

Sparrow PV Facility

Final Basic Assessment Report

Stilfontein PV Cluster, Stilfontein, North West Province, South Africa
South Africa Mainstream Renewable Power Developments (Pty) Ltd

SRK Reference Number: 581877/Project 7

DFFE Reference Number: 14/12/16/3/3/1/2742



Sparrow PV Facility Final Basic Assessment Report

Stilfontein PV Cluster, Stilfontein, North West Province, South Africa

Prepared for:

South Africa Mainstream Renewable Power
Developments (Pty) Ltd
4th floor Mariendahl House, Newlands on Main
Claremont, Cape Town, 7708
South Africa



+27 21 657 8061

www.mainstreamrp.com

Prepared by:

SRK Consulting (South Africa) (Pty) Ltd.
183 Main Road, Administrative Building, Albion
Springs
Rondebosch
Cape Town, WC, South Africa, 7700



PostNet Suite 206, Private Bag X18
Rondebosch
Cape Town, WC, South Africa, 7701

+27 21 659 3060

www.srk.com



Reg. No. 1995.012890.07

Lead Author: Sue Reuther, Partner REUT

Reviewer: Chris Dalglish, Partner DALC

Contributors Kate Steyn, Principal, Lauren Elston, Senior Consultant STEY, ELSL

File Name:

00_Sparrow PV_Final BAR_20230710

Suggested Citation:

SRK Consulting (South Africa) (Pty) Ltd. Sparrow PV Facility Final BAR. Prepared for South Africa Mainstream Renewable Power Developments (Pty) Ltd, Claremont, Cape Town. Project number: 581877.

Copyright © 2023

SRK Consulting (South Africa) (Pty) Ltd. ■ 581877 ■ July 2023



EXECUTIVE SUMMARY: BASIC ASSESSMENT REPORT

STILFONTEIN PV CLUSTER: SPARROW PV FACILITY

STILFONTEIN, NORTH WEST

July 2023

SRK Project Number: 581877/Project 7

Note: All changes to the Executive Summary following public comment are italicised and underlined for ease of reference.

1 INTRODUCTION

South Africa Mainstream Renewable Power Developments (Pty) Ltd (**Mainstream**) proposes to develop the Stilfontein Photovoltaic (PV) Cluster, ~6 km north-east of Stilfontein in North West Province (see *Figure 2 and Figure 3*). The Stilfontein Cluster (the 'project area') comprises:

- 9 x 150MW (max) PV facilities and associated infrastructure (11-33 kV transmission lines, a Battery Energy Storage Systems (BESS) per site and an Independent Power Producer (IPP)-side on-site substation per site);
- 9 x Eskom-side on-site substations and 132 kV transmission lines to evacuate power to the Main Transmission Station (MTS); and
- 1 x MTS and 400 kV lines to existing Hermes Pluto transmission lines.

SRK Consulting (South Africa) (Pty) Ltd (**SRK**) was appointed by Mainstream to undertake the environmental processes required in terms of the National Environmental Management Act 107 of 1998 (NEMA) and the Environmental Impact Assessment (EIA) Regulations, 2014, in support of applications for Environmental Authorisation (EA) for the various components of the project. (Separate EAs are sought for the nineteen individual projects in the Stilfontein Cluster, as listed above.) In addition, the project will require a heritage comment in terms of the National Heritage Resources Act 25 of 1998 (NHRA) issued by the South African Heritage Resources Agency (SAHRA).

This Basic Assessment Report (BAR) relates specifically to the Sparrow PV facility and associated infrastructure project (*see Figure 4*).

2 GOVERNANCE FRAMEWORK

The EIA Regulations, 2014, govern the process, methodologies and requirements for EIAs in support of EA applications.

The EIA Regulations lay out two authorisation processes and depending on the type of activity that is proposed, either a Basic Assessment (BA) process or a Scoping and Environmental Impact Reporting (S&EIR) process is required

to obtain EA. The EIA Regulations are accompanied by Listing Notices (LN) 1-3 that list activities that require EA. LN 1 and LN 3 list activities that require a BA process, while LN 2 lists activities that require S&EIR.

The proposed project triggers activities in both LN1 and LN2 so normally, a S&EIR process would be required. However, the Department of Forestry, Fisheries and Environment (DFFE) has identified eleven Renewable Energy Development Zones (REDZ) across the country and to expedite the authorisation of large renewable energy projects in response to the energy crisis in South Africa, Government Notice (GN) 142 of 2021¹ stipulates that a BA process must be followed when a project falls within a REDZ. The Stilfontein Cluster lies entirely within the Klerksdorp REDZ and thus BA processes are being followed for each EA application as per the approach set out in the EIA Regulations, 2014 and GN 142, 2021 (see Figure 1).

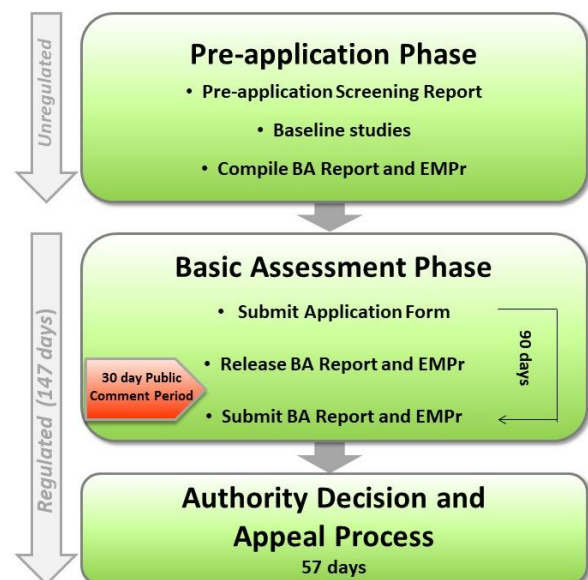

Figure 1: BA Process for projects within a REDZ.

The project is intended to form part of a submission under the Renewable Energy Independent Power Producers Procurement Programme (REIPPPP). As such, DFFE is the competent authority for this application.

¹¹ Identification of Procedures to be Followed when Applying for or Deciding on an Environmental Authorisation Application

for Large Scale Wind and Solar Photovoltaic Facilities, when occurring in Renewable Energy Development Zones

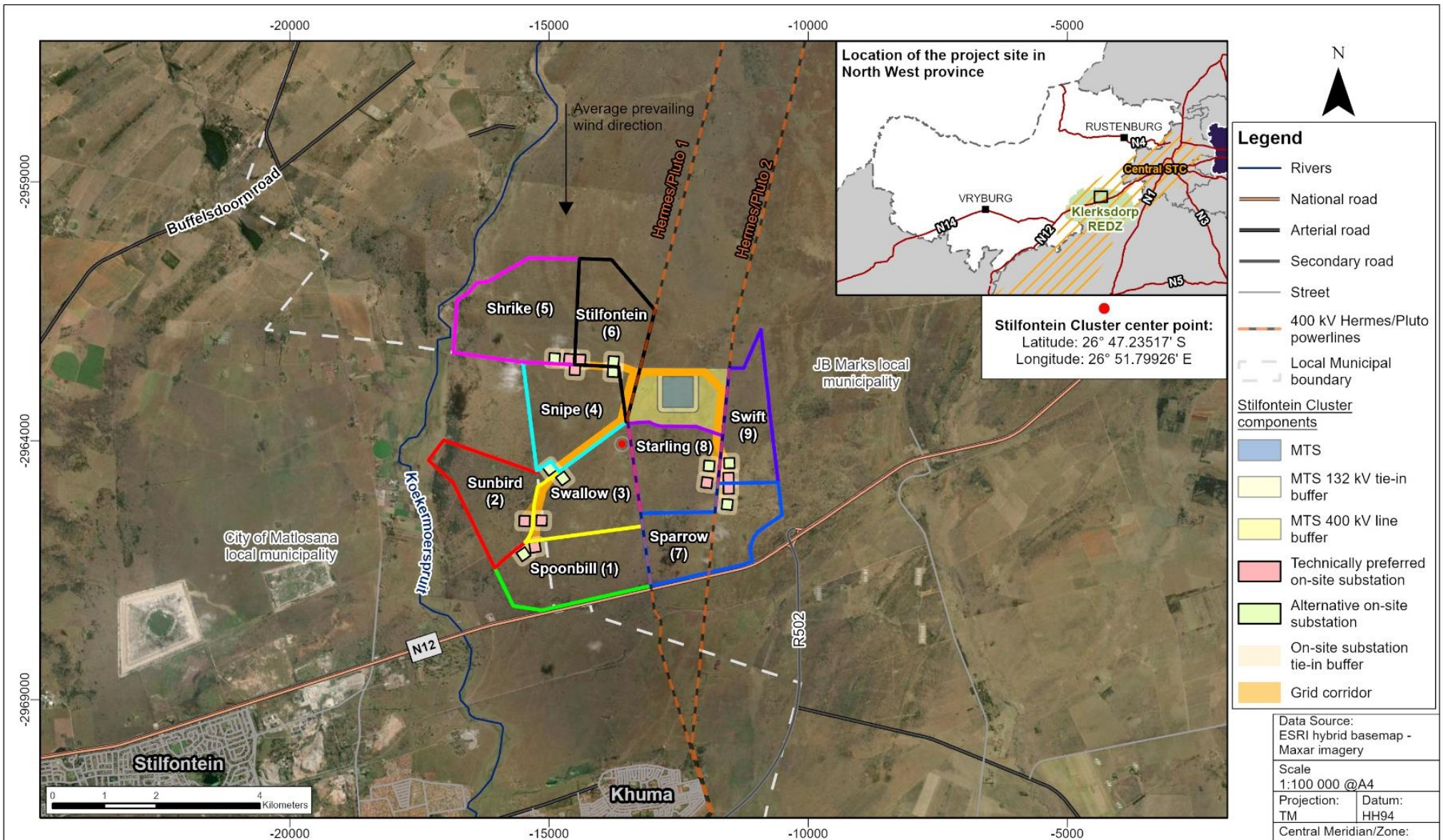

Figure 2: PV cluster locality map

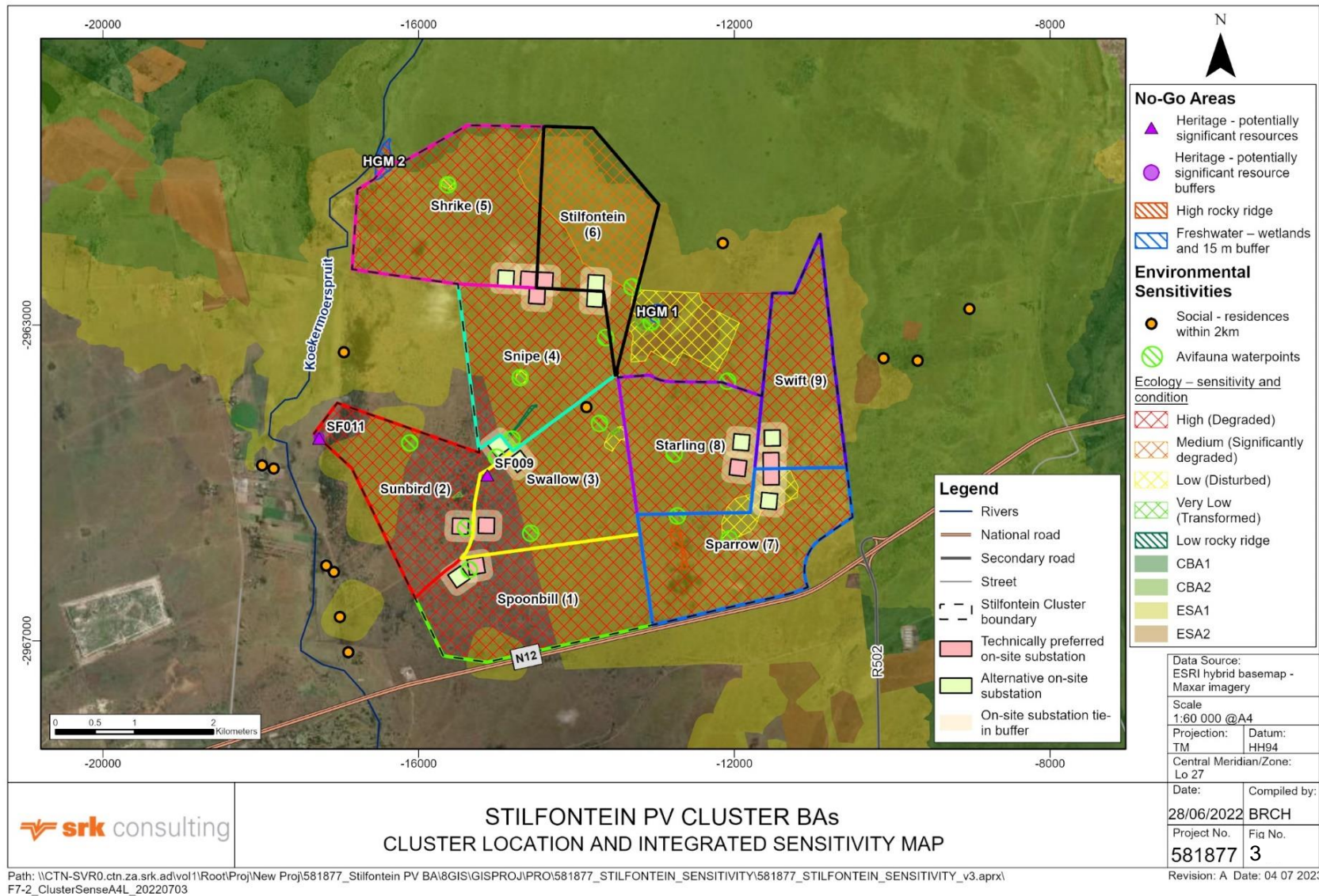

Figure 3: PV cluster locality and integrated sensitivity map

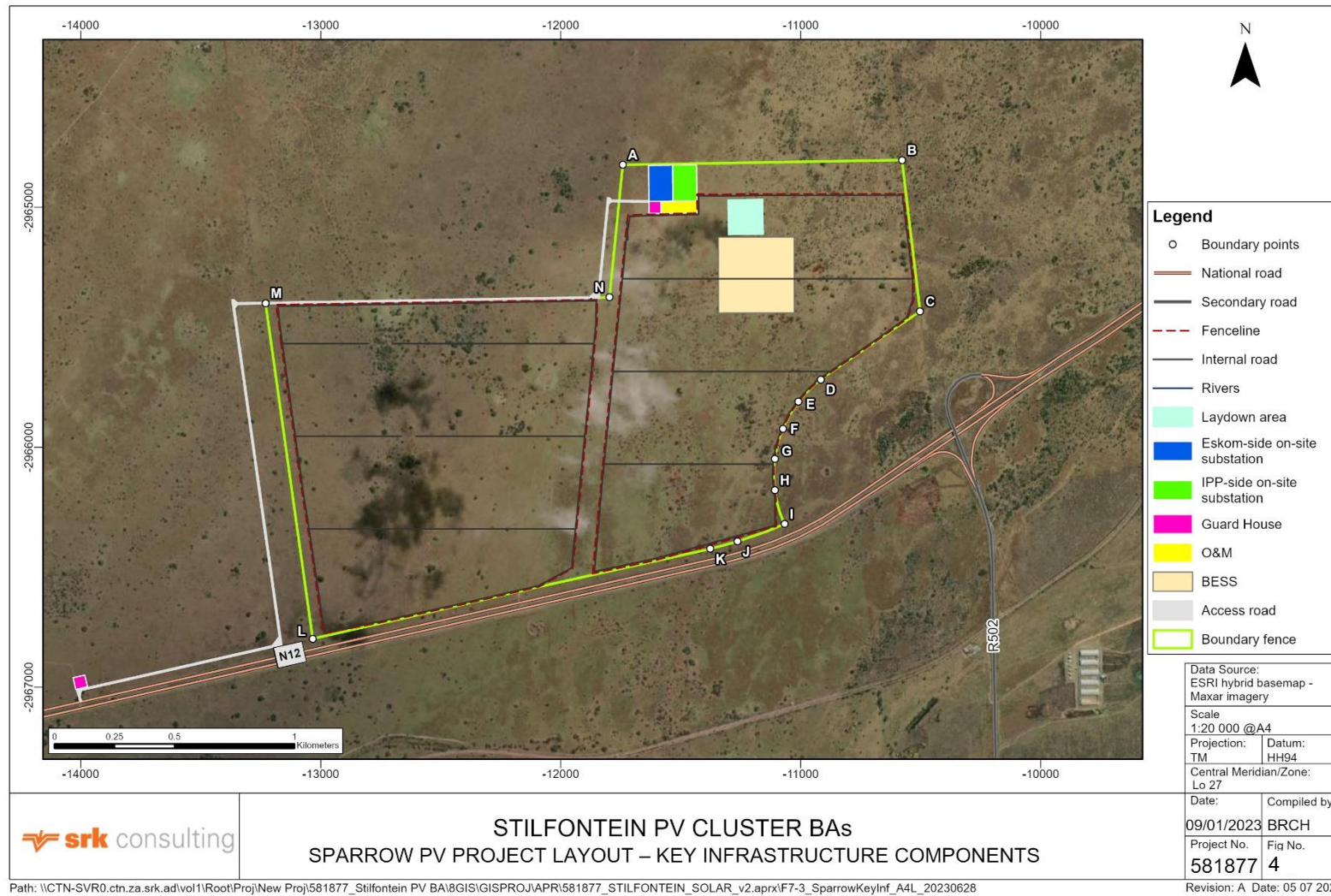

Figure 4: Sparrow PV project layout – key infrastructure components²

² The proposed location of the BESS is shown in Figure 4 and it is noted that if the BESS is not installed, this area will be occupied by additional PV panels

3 ENVIRONMENTAL PROCESS

The objectives of the BA process are to:

- Identify relevant authorities and key stakeholders to engage in the stakeholder engagement process;
- Facilitate the dissemination of information to the relevant authorities and stakeholders and provide them with an opportunity to raise issues or concerns related to the project;
- Identify potential issues and environmental impacts;
- Assess the significance of the potential environmental impacts identified;
- Describe and investigate alternatives that have been and / or could be considered; and
- Provide feasible mitigation measures to address any significant impacts identified.

The above objectives are achieved through the technical evaluation of the proposed activity, the stakeholder engagement process and the submission of the relevant information and documentation to DFFE.

4 DESCRIPTION OF THE ENVIRONMENT

The project area falls within the Dry Highveld Grassland Bioregion, which is not particularly species rich compared to other South African biomes and contains few endemic or floral and faunal Species of Conservation Concern (SCC).

The vegetation in the project area mainly consists of grassland-woodland vegetation with occasional rocky ridges. The habitat in most of the project area is degraded due to overgrazing and other agricultural practices. While the area is not entirely transformed, ongoing disturbance prevents recovery of these areas to a more natural state. Camel Thorn (*Vachellia erioloba*) is the only SCC recorded in the project area and these trees are widely distributed across the site (see Figure 3). Camel thorn trees are protected under the National Forests Act 84 of 1998 and their removal requires a permit. The Critically Endangered White-backed Vulture (*Gyps africanus*) is the only faunal SCC recorded in the Stilfontein Cluster area, recorded roosting on the 400kV Hermes / Pluto 2 powerline (see Figure 6).



Figure 5: Typical vegetation in the project area.

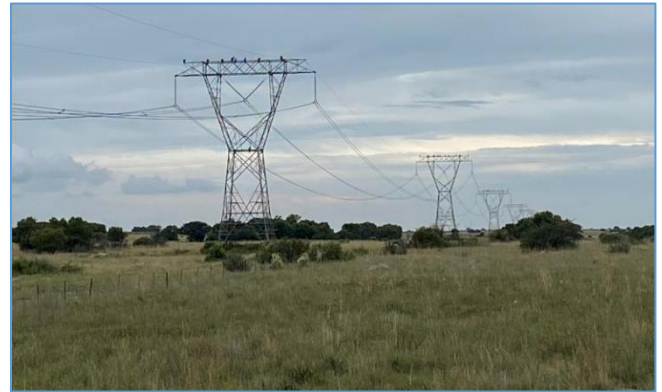

Figure 6: White-backed vultures roosting on the 400kV Hermes- Pluto transmission lines.

A large proportion of the project area is classified as an Ecological Support Area (ESA category 1), with a narrow strip along the northern boundary of the Cluster overlapping a Critical Biodiversity Area (CBA level 2).

There is very little surface water in the project area. Concrete reservoirs provide important resources for birds in the project area. The Kromdraaispruit and Koekemoerspruit lie west of the project area and their floodplains are classified as Critically Endangered habitat in terms of the 2018 National Biodiversity Assessment, although they are categorised as ‘moderately modified’. A depression wetland located near the centre of the project area has low ecosystem functioning but does provide some important ecosystem services.

The site lies in the Dr Kenneth Kaunda District Municipality (DM), the smallest but marginally most affluent DM in the province. The N12 corridor forms an important regional development axis along its southern boundary. The economy is dominated by agriculture, services, mining and manufacturing. Employment opportunities in the DM are limited, primarily in the mining industry, and poverty levels are showing a strong upward trend.

Heritage resources on the site are limited to low-density scatters of Stone Age artefacts, a few structures of limited historical value and a burial site. Visually, the project area is characterised as a modified rural landscape, with rolling expanses of grazing land with mining activities and busy roads and railways visible in the landscape.

5 PROJECT DESCRIPTION

The Sparrow PV facility will occupy ~330 ha across several farm portions and comprises these key components:

- PV arrays with a maximum capacity of up to 150 MW;
- Internal cabling connecting panels, inverters and transformers;
- Lithium-Ion BESS;
- 11-33kV underground cable / overhead powerline between the PV facility and on-site substation;
- Internal gravel roads;

- Fencing and lighting;
- Material and construction laydown areas;
- Stormwater infrastructure;
- Water supply and water storage infrastructure;
- Offices, including ablutions with septic tank / conservancy tanks sewage treatment infrastructure;
- Operational control centre and maintenance area; and
- Security guard house.

Access to the facility will be from the N12.

Note that the associated Eskom-side on-site substation and 132 kV transmission lines to the MTS are subject to a separate EA application.

6 ALTERNATIVES

Appendix 3 Section 3 (h)(i) of the EIA Regulations, 2014, requires that all BA processes must identify and describe feasible and reasonable alternatives. Alternatives considered during screening phases of the project include:

- Location alternatives
- Layout alternatives
- Activity alternatives
- Technology alternatives (including cell, panel, mounting and BESS technologies)
- The No-Go alternative.

Solar panel technology alternatives that were assessed in detail in the BAR are:

- *Monofacial panels:* only have PV cells on top of the solar panel that collect direct sunlight.
- *Bifacial panels:* have solar cells on top and underneath the solar panel to gather both direct sunlight and reflected light. They require a reflective substrate under and more space between panels, but can be as much as ~35% more efficient than monofacial panels.

7 STAKEHOLDER ENGAGEMENT

Stakeholder engagement is a key component of the BA process and was undertaken in accordance with the requirements of the EIA Regulations, 2014. The stakeholder engagement activities undertaken as part of this BA process are summarised in Table 1.

Table 1: Stakeholder engagement during the BA process

Activity	Date
Advertise commencement of the EIA process	26 May -30 June 2022
Submit Application Form to DFFE	05 April 2023
Readvertise the EIA process	05 - 13 April 2023
Release Draft BAR to the Public	13 April 2023
Comment period	14 April - 16 May 2023
Submit Final BAR to DFFE	<u>July 2023</u>

Note that the project originally commenced in February 2022 and calls for registration of Interested and Affected Parties (IAPs) were first made in May 2022. The EIA process was put on hold while Mainstream refined their project description.

The project was readvertised in April 2023 and stakeholders were invited to register.

Relevant Organs of State (local, provincial and national authorities) as well as conservation bodies and local forums have been automatically registered as stakeholders.

Key comments and concerns raised by stakeholders predominantly relate to:

- **Impacts to water resources:** Prevent groundwater and surface water pollution;
- **Terrestrial biodiversity impact:** Compile a Fire Management Plan;
- **Terrestrial biodiversity impact:** The DFFE Directorate Biodiversity Conservation Directorate does not support the development since the identified degraded habitats, mostly within ESA1 areas were assigned High Site Ecological Importance (SEI) by the specialist. The degraded habitat was assigned to have a high functional integrity and low receptor resilience and the habitat is unlikely to be able to recover fully after a relatively long period;
- **Avifauna impact:** BirdLife noted that the associated powerlines (to be submitted as separate EA applications) will pose a bigger risk to the White-backed vulture than the PV facility itself and therefore Eskom's bird-friendly requirements must be implemented for the grid infrastructure projects;
- **Socio-economic benefits:** The project is anticipated to empower and develop SMMEs and create jobs;
- **Heritage impact:** Avoid no go areas specified in the heritage impact assessment, where applicable, employ an ECO to monitor construction and implement a chance finds procedure should heritage resources be found;
- **Eskom's requirements:** Eskom's requirements for works at or near Eskom infrastructure and servitudes, as well as a setbacks guideline for renewable energy developments, must adhered to;
- **Openserve approval:** The proposed powerlines are approved, and conditions of approval provided in terms of Section 22 of the Electronic Communications Act 36 of 2005;
- **Geotechnical considerations:** The area experiences mine-induced seismic activity;
- **Effective stakeholder engagement:** Consult with affected communities, landowners, people who have land claims and engage with the local municipality in terms of service capacity for general waste disposal and potable water supply;

- **Decommissioning planning:** Plan for the ultimate disposal of hazardous waste/ material e.g., batteries and solar panels;
- **Safety and security impacts:** Ensure effective security arrangements since illegal mining activities take place in the area;
- **Dust impact:** Ensure effective dust mitigation since the community is sensitive to dust impacts;
- **Land use applications:** Apply for rezoning and servitude registrations;
- **Technical and design detail:** More specific layout information as described in the Draft BAR be shown on a map and technical details, including various co-ordinates, to be provided in a summary table;
- **Mapping:** Provide layout and sensitivity mapping showing key infrastructure components as described in the Draft BAR, including buffer areas and no-go areas; and
- **Cumulative impact assessment:** Similar projects within a 30km radius must be assessed.

- Land capability specialist
- Freshwater ecologist
- Terrestrial ecologist
- Avifaunal ecologist
- Socio-economist
- Heritage and palaeontology practitioner
- Visual specialist

8 ASSESSMENT OF POTENTIAL IMPACTS

For all potentially significant impacts, the significance of the anticipated impact was rated using SRK’s standard Impact Assessment Methodology. These impacts are presented in Table 2, which summarises:

- The impacts assessed in the BAR, including alternatives assessed where relevant; and
- Their significance before (without) and following (with) the implementation of essential mitigation measures.

Impact Significance Ratings Legend:

Rating	+ve	-ve
Insignificant	I	I
VL	VL	VL
L	L	L
M	M	M
H	H	H
Very H	VH	VH

Mitigation measures for the management and monitoring of identified impacts are set out in the BAR and detailed in an Environmental Management Programme Report (EMPr), which accompanies the BAR.

The following specialists were engaged to identify and assess potential impacts within their particular field of study and to identify practicable mitigation and optimisation measures to avoid or minimise potential negative impacts and/or enhance any benefits:

Table 2: Summary of impacts

Impact	Significance rating	
	Without	With
CONSTRUCTION PHASE IMPACTS		
Reduction and loss of land capability	VL	VL
Degradation and loss of habitat and protected species	Panel Technology One	
	L	VL
	Panel Technology Two	
	H	M
Spread of alien and invasive species	Panel Technology One	
	VL	VL
	Panel Technology Two	
	L	VL
Displacement and loss of fauna	Panel Technology One	
	VL	VL
	Panel Technology Two	
	M	VL
Bird displacement due to disturbance	L	VL
Bird displacement due to habitat transformation	H	M
Capital investment contributing to the national, regional and local economy	M	M
Generation of employment, income and skills	L	M
Social disruption and change in social dynamics	VL	I
Reduced quality of life and increased risks due to construction near residences	VL	I
Loss of heritage resources	VL	VL
Altered Sense of Place and Visual Intrusion	L	VL
(Traffic) trip generation	L	VL
OPERATIONAL PHASE IMPACTS		
Reduction and loss of land capability	VL	VL
Degradation and fragmentation of habitat	Panel Technology One	
	VL	VL
	Panel Technology Two	
	L	M
Spread of alien and invasive species	Panel Technology One	
	VL	VL
	Panel Technology Two	
	L	VL
Displacement and loss of fauna	Panel Technology One	
	VL	VL
	Panel Technology Two	
	L	VL
Bird mortality due to collision with solar panels	VL	VL
Bird mortality due to entrapment in perimeter fences	L	VL
Bird mortality due to electrocution	H	L

Impact	Significance rating	
	Without	With
Bird mortality due to collision with transmission lines	H	L
Bird displacement due to disturbance	L	VL
Operational investment contributing to the national, regional and local economy	M	M
Generation of employment, income and skills	L	L
Increased community prosperity through contributions and income from the project	If procured via the REIPPPP	
	M	H
	If a private end-user agreement is pursued	
	L	L
Altered sense of place and visual intrusion caused by the PV array	H	M
Altered sense of place and visual intrusion caused by the 11-33kV powerlines and pylons	L	L
Altered sense of place and visual intrusion caused by the BESS and IPP side substation	M	M
Visual discomfort and impaired visibility (glint and glare)	H	L
Altered visual quality from nightglow	M	M
DECOMMISSIONING PHASE IMPACTS		
Degradation and fragmentation of habitat	Panel Technology One	
	VL	VL
	Panel Technology Two	
	L	M
Spread of alien and invasive species	Panel Technology One	
	VL	I
	Panel Technology Two	
	L	I
Bird displacement due to disturbance	L	VL
Reduced employment and funding	VL	VL
(Traffic) trip generation	VL	VL

Cumulative impacts of this project were also assessed using the same methodology, taking consideration of the other proposed projects that form part of the Stilfontein Cluster as well as other approved solar projects in the area (see **Table 3**).

Table 3: Summary of cumulative impacts

Cumulative Impact	Significance rating	
	Without	With
Cumulative reduction and loss of land capability	L	L
Cumulative loss of habitat	M	M
Cumulative bird displacement	L	L
Cumulative stimulation of economic and employment growth	VH	VH
Cumulative increase in community prosperity	If procured via the REIPPPP	
	VH	VH
	If a private end-user agreement is pursued	
	L	M

Cumulative Impact	Significance rating	
	Without	With
Cumulative heritage impacts	VL	VL
Cumulative altered sense of place and visual intrusion	M	M
Cumulative visual discomfort and impaired visibility (glint and glare)	M	M
Cumulative (traffic) trip generation	M	M

9 FINDINGS AND RECOMMENDATIONS

The Final BAR has identified and assessed the potential biophysical and socio-economic impacts associated with the proposed Sparrow PV Facility and associated infrastructure near Stilfontein in the North West *Province*.

In terms of Section 31 (n) of NEMA, the EAP is required to provide an opinion as to whether the activity should or should not be authorised. SRK believes that sufficient information is available for DFFE to take a decision.

The PV Facility and associated infrastructure will result in unavoidable adverse biophysical impacts. Assuming that Mainstream is committed to ensuring that the EMPr is strictly implemented, none of these adverse impacts are considered unacceptably significant. The project will result in significant potential socio-economic benefits and responds to a national need for additional, cleaner power generation. On this basis, the No-Go alternative is not preferred.

In conclusion, and noting that the project is located within a REDZ, SRK is of the opinion that on purely ‘environmental’ grounds (i.e. the project’s potential social, economic and biophysical implications) the application as it is currently articulated should be approved, provided the essential mitigation measures are implemented. The impacts of both panel technologies are deemed acceptable with mitigation. Ultimately, however, DFFE will need to consider whether the project benefits outweigh the potential impacts.

WAY FORWARD

The Final BAR, including the comments received, is now being submitted to DFFE for their consideration. Once a decision is taken by the authorities, this decision will be communicated to all registered stakeholders.

Note:

In response to stakeholder comments, the Draft Basic Assessment Report (BAR) and Environmental Management Programme (EMPr) were updated at the end of the comment period to produce this Final BAR and EMPr for submission to the Department of Forestry, Fisheries and the Environment (DFFE).

All changes in the Final BAR vis-a-vis the previously released BAR are italicised and underlined for ease of reference.

*An **Issues and Responses Summary**, reflecting stakeholder comments received during the stakeholder engagement process and responses by SRK, is included in Appendix C.7.*

Disclaimer

SRK Consulting (South Africa) (Pty) Ltd. has prepared this document for SRK Reference Number: 581877/Project 7, our client. Any use or decisions by which a third party makes use of this document are the responsibility of such third parties. In no circumstance does SRK accept any consequential liability arising from commercial decisions or actions resulting from the use of this report by a third party.

The opinions expressed in this document have been based on the information available to SRK at the time of preparation. SRK has exercised all due care in reviewing information supplied by others for use on this project. While SRK has compared key supplied data with expected values, the accuracy of the results and conclusions from the review are entirely reliant on the accuracy and completeness of the supplied data. SRK does not accept responsibility for any errors or omissions in the supplied information, except to the extent that SRK was hired to verify the data.

Contents

Acronyms and Abbreviations	xii
Glossary	xv
1 Introduction	1
1.1 Background	1
1.2 Purpose of the Report	1
1.3 Structure of this Report.....	1
1.4 Content of the Report	1
1.5 Assumptions and Limitations.....	4
2 Governance Framework and Environmental Process.....	5
2.1 Legal Requirements	5
2.1.1 National Environmental Management Act 107 of 1998	5
2.1.2 National Environmental Management: Biodiversity Act 10 of 2004	9
2.1.3 National Water Act 36 of 1998	10
2.1.4 National Heritage Resources Act 25 of 1999.....	11
2.2 Planning Policy Framework	12
2.2.1 Integrated Resource Plan for Electricity 2010 – 2030	12
2.2.2 Strategic Integrated Projects.....	13
2.2.3 Renewable Energy Strategy for North West Province (2012)	14
2.2.4 North West Provincial Development Plan (2015)	14
2.2.5 North West Biodiversity Sector Plan (2015).....	14
2.2.6 Dr Kenneth Kaunda District Municipality Integrated Development Plan.....	16
2.2.7 JB Marks Local Municipality Integrated Development Plan.....	16
2.3 Environmental Process.....	17
2.3.1 Submission of Applications	18
2.3.2 BA Process and Phasing	19
3 Project Description	21
3.1 PV Facilities: An Introduction.....	21
3.2 Stilfontein PV Cluster Overview	23
3.2.1 PV Facilities	23
3.2.2 Grid Connection Infrastructure.....	24
3.3 Description of the Project Area.....	24
3.4 Proponent’s Project Motivation.....	25
3.4.1 Motivation for Renewable Energy Generation in South Africa.....	25
3.4.2 Motivation for the Stilfontein Cluster projects.....	29
3.5 Project Alternatives.....	32
3.5.1 Location Alternatives.....	32
3.5.2 Layout Alternatives.....	33
3.5.3 Activity Alternatives	33
3.5.4 Technology Alternatives.....	33
3.5.5 The No-Go Alternative	36
3.6 Sparrow PV Facility Infrastructure and Construction Activities	36
3.6.1 Project Location	41
3.6.2 Project Layout and Mounting Technology.....	41
3.6.3 PV Panels	43
3.6.4 BESS.....	44
3.6.5 Internal Powerlines.....	46
3.6.6 IPP-Side On-Site Substation.....	46
3.6.7 Access Roads	47
3.6.8 Laydown Area and Ancillary Facilities	47
3.6.9 Ground Preparation and Installation	48
3.6.10 Stormwater Management.....	48

3.6.11	Water Use and Supply	49
3.6.12	Waste and Wastewater Management	49
3.6.13	Workforce	50
3.6.14	Capital Expenditure	50
3.6.15	Community and Social Investment	51
3.6.16	Construction Timelines	51
3.7	Sparrow PV Facility Operation and Maintenance Activities	52
3.7.1	Energy Generation and Transmission	52
3.7.2	Maintenance	52
3.7.3	Stormwater Management	52
3.7.4	Water Use and Supply	52
3.7.5	Waste Management	53
3.7.6	Workforce	53
3.7.7	Operational Expenditure	54
3.7.8	Community and Corporate Social Investment	54
3.7.9	Project Lifetime	54
3.8	Decommissioning	54
4	Description of the Affected Environment	55
4.1	Biophysical Environment	55
4.1.1	Geology and Topography	55
4.1.2	Climate	58
4.1.3	Soils and Land Capability	58
4.1.4	Wetlands	59
4.1.5	Terrestrial Ecology	62
4.2	Socio-Economic Environment	71
4.2.1	Regional Context	71
4.2.2	Demographics	71
4.2.3	Social Characteristics	71
4.2.4	Local Economy	72
4.2.5	Education	73
4.3	Historical and Cultural Environment	74
4.3.1	Palaeontology, Archaeology and Historical Record	74
4.3.2	Cultural Landscape	76
4.4	Visual and Aesthetic Environment	78
4.4.1	Visual Character	78
4.4.2	Visual Quality	78
4.4.3	Sense of Place	78
4.4.4	Visual Receptors	78
4.4.5	Viewing Distance and Visibility	79
4.5	Regional Renewable Energy Sector	80
5	Stakeholder Engagement	83
5.1	Objectives and Approach to Stakeholder Engagement	83
5.2	Stakeholder Engagement during the Basic Assessment Process	83
5.2.1	Identification of Key Stakeholders and IAPs	84
5.2.2	Newspaper Advertisements, Site Notices and Letter Drops	84
5.2.3	Comments Received During the Pre-Application Phase	85
5.2.4	Notification of BAR for Public Comment	86
5.2.5	Issues and Concerns Raised by Registered Stakeholders during the Commenting Period on the Draft BAR	86
5.2.6	Next Steps	88
6	Environmental Impact Assessment	89
6.1	Introduction	89
6.1.1	Environmental Impacts Identified	89
6.1.2	Specialist Studies Undertaken	89
6.1.3	Alternatives Assessed in the EIA	90

6.1.4	Impact Rating Methodology	90
6.2	Potential Soil and Land Capability Impacts	92
6.2.1	Introduction	92
6.2.2	Assessment of Impacts: Construction Phase	93
6.2.3	Assessment of Impacts: Operational Phase	93
6.2.4	Specialist Opinion	94
6.2.5	The No-Go Alternative	94
6.3	Potential Freshwater Impacts	94
6.3.1	Introduction	94
6.3.2	Assessment of Impacts: Construction Phase	94
6.3.3	Assessment of Impacts: Operational Phase	95
6.3.4	Specialist Opinion	95
6.3.5	The No-Go Alternative	95
6.4	Potential Terrestrial Ecology Impacts	95
6.4.1	Introduction	95
6.4.2	Assessment of Impacts: Construction Phase	96
6.4.3	Assessment of Impacts: Operational Phase	99
6.4.4	Assessment of Impacts: Decommissioning Phase	102
6.4.5	Specialist Opinion	104
6.4.6	No-Go Alternative.....	104
6.5	Potential Avifauna Impacts	104
6.5.1	Introduction	104
6.5.2	Assessment of Impacts: Construction Phase	105
6.5.3	Assessment of Impacts: Operational Phase	106
6.5.4	Assessment of Impacts: Decommissioning Phase	109
6.5.5	Specialist Opinion	109
6.5.6	The No-Go Alternative	110
6.6	Potential Socio-Economic Impacts	110
6.6.1	Introduction	110
6.6.2	Assessment of Impacts: Construction Phase	110
6.6.3	Assessment of Impacts: Operational Phase	114
6.6.4	Assessment of Impacts: Decommissioning Phase	117
6.6.5	Specialist Opinion	118
6.6.6	The No-Go Alternative	118
6.7	Potential Heritage and Palaeontology Impacts	118
6.7.1	Introduction	118
6.7.2	Assessment of Impacts: Construction Phase	119
6.7.3	Assessment of Impacts: Operational Phase	120
6.7.4	Specialist Opinion	120
6.7.5	The No-Go Alternative	120
6.8	Potential Visual Impacts	120
6.8.1	Introduction	120
6.8.2	Assessment of Impacts: Construction Phase	121
6.8.3	Assessment of Impacts: Operational Phase	121
6.8.4	Specialist Opinion	124
6.8.5	The No-Go Alternative	124
6.9	Potential Traffic Impacts	124
6.9.1	Introduction	124
6.9.2	Assessment of Impacts: Construction Phase	125
6.9.3	Assessment of Impacts: Operational Phase	128
6.9.4	Assessment of Impacts: Decommissioning Phase	128
6.9.5	Opinion	129
6.9.6	The No-Go Alternative	129
6.10	Potential Cumulative Impacts	129
6.10.1	Introduction	129
6.10.2	Methodology.....	130
6.10.3	Cumulative Impact Assessment.....	131

- 7 Conclusions and Recommendations 141
- 7.1 Environmental Impact Statement 141
 - 7.1.1 Evaluation and Summary of Positive and Negative Impacts 141
 - 7.1.2 Integrated Project and Sensitivity Map 156
 - 7.1.3 Principal Findings 156
- 7.2 Analysis of Need and Desirability of the Project 160
 - 7.2.1 Alignment with Policy and Planning Documentation 160
 - 7.2.2 Socio-Economic Need and Desirability 161
 - 7.2.3 Ecological Need and Desirability 162
 - 7.2.4 Summary of Need and Desirability 163
- 7.3 Recommendations 163
- 7.4 Conclusion and Authorisation Opinion 164
- 7.5 Way Forward 167

- 8 References 169

Tables

Table 1-1:	Content of BAR as per Appendix 1 of the EIA Regulations, 2014	2
Table 2-1:	NEMA listed activities (2014) applicable to the proposed project	7
Table 2-2:	Applications for authorisation	18
Table 3-1:	Alternatives considered	32
Table 3-2:	Advantages and disadvantages of mounting technologies	34
Table 3-3:	Advantages and disadvantages of battery technologies	35
Table 3-4:	Overview of Sparrow PV facility key components	37
Table 3-5:	Property details of Sparrow PV facility	41
Table 4-1:	Specialist baseline studies undertaken for the BA	55
Table 4-2:	Herpetofauna species recorded in the Stilfontein Cluster project area	66
Table 4-3:	Mammal species of conservation concern expected to occur in the Stilfontein Cluster	67
Table 4-4:	Avifauna priority species likely to occur in the Stilfontein Cluster project area	68
Table 4-5:	Population distribution (number and percentage) across the JB Marks LM, DKKDM and Province	71
Table 4-6:	Record of heritage observations in the cumulative Stilfontein Cluster area	76
Table 4-7:	<i>Renewable energy projects under consideration in the project area</i>	81
Table 5-1:	BA Process stakeholder engagement activities	83
Table 5-2:	Site notices and posters placed near Stilfontein Cluster	84
Table 5-3:	Letter drops near Stilfontein Cluster	85
Table 5-4:	<i>Stakeholders who submitted written comments during the draft BAR commenting period</i>	86
Table 6-1:	Specialist studies proposed in the DFFE Screening Tool	89
Table 6-2:	Criteria used to determine the consequence of the impact	91
Table 6-3:	Method used to determine the consequence score	91
Table 6-4:	Probability classification	91
Table 6-5:	Impact significance ratings	92
Table 6-6:	Impact status and confidence classification	92
Table 6-7:	Significance of reduction and loss of land capability	93
Table 6-8:	Significance of reduction and loss of land capability	94
Table 6-9:	Significance of potential degradation and loss of habitat and protected species – Panel Technology One	96
Table 6-10:	Significance of potential degradation and loss of habitat and protected species – Panel Technology Two	97
Table 6-11:	Significance of spread of alien and invasive species – Panel Technology One	97
Table 6-12:	Significance of spread of alien and invasive species – Panel Technology Two	98
Table 6-13:	Significance of displacement and loss of fauna – Panel Technology One	99
Table 6-14:	Significance of displacement and loss of fauna – Panel Technology Two	99
Table 6-15:	Significance of degradation and fragmentation of habitat – Panel Technology One	100
Table 6-16:	Significance of degradation and fragmentation of habitat – Panel Technology Two	100
Table 6-17:	Significance of spread of alien and invasive species – Panel Technology One	101
Table 6-18:	Significance of spread of alien and invasive species – Panel Technology Two	101
Table 6-19:	Significance of displacement and loss of fauna – Panel Technology One	101
Table 6-20:	Significance of displacement and loss of fauna – Panel Technology Two	102
Table 6-21:	Significance of degradation and fragmentation of habitat – Panel Technology One	103
Table 6-22:	Significance of degradation and fragmentation of habitat – Panel Technology Two	103
Table 6-23:	Significance of spread of alien and invasive species – Panel Technology One	103
Table 6-24:	Significance of spread of alien and invasive species – Panel Technology Two	104
Table 6-25:	Significance of potential bird displacement due to disturbance	105
Table 6-26:	Significance of potential bird displacement due to habitat transformation	106
Table 6-27:	Significance of potential bird mortality due to collision with solar panels	107
Table 6-28:	Significance of potential bird mortality due to entrapment in perimeter fences	107
Table 6-29:	Significance of potential bird mortality due to electrocution	108
Table 6-30:	Significance of potential bird mortality due to collisions with transmission lines	108
Table 6-31:	Significance of potential bird displacement due to disturbance	109
Table 6-32:	Significance of capital investment contributing to the national, regional and local economy	111

Table 6-33: Significance of generation of employment, income and skills.....	112
Table 6-34: Significance of social disruption and change in social dynamics.....	113
Table 6-35: Significance of reduced quality of life and increased risks due to construction near residences	114
Table 6-36: Significance of operational investment contributing to the national, regional and local economy	115
Table 6-37: Significance of generation of employment, income and skills.....	115
Table 6-38: Significance of increased community prosperity through contributions and income from the project if procured via the REIPPPP	117
Table 6-39: Significance of increased community prosperity through contributions and income from the project if a private end-user agreement is pursued.....	117
Table 6-40: Significance of reduced employment and funding	118
Table 6-41: Significance of potential loss of heritage / palaeontology resources	119
Table 6-42: Significance of potential loss of fossils.....	120
Table 6-43: Altered sense of place and visual intrusion caused by construction activities	121
Table 6-44: Altered sense of place and visual intrusion caused by PV array	122
Table 6-45: Altered sense of place and visual intrusion caused by the 11-33 kV powerlines and pylons.....	122
Table 6-46: Altered sense of place and visual intrusion caused by the BESS and IPP-side substation	123
Table 6-47: Visual discomfort and impaired visibility resulting from glint and glare	123
Table 6-6-48:.....Altered visual quality caused by light pollution at night.....	124
Table 6-49: Significance of potential trip generation during construction.....	128
Table 6-50: Significance of potential trip generation during decommissioning	129
Table 6-51: Significance of potential cumulative reduction and loss of land capability.....	132
Table 6-52: Cumulative loss of habitat due to Stilfontein Cluster.....	133
Table 6-53: Significance of potential cumulative habitat loss, fragmentation and degradation	133
Table 6-54: Significance of potential cumulative bird displacement due to habitat transformation	134
Table 6-55: Significance of potential cumulative stimulation of economic and employment growth	135
Table 6-56: Significance of potential cumulative increase in community prosperity if REIPPPP requirements apply.....	136
Table 6-57: Significance of potential cumulative increase in community prosperity if REIPPPP requirements do not apply.....	137
Table 6-58: Significance of potential cumulative loss of heritage resources and fossils	137
Table 6-59: Significance of potential cumulative altered sense of place and visual intrusion caused by facilities.....	138
Table 6-60: Significance of potential cumulative visual discomfort and impaired visibility caused by glint and glare	139
Table 6-61: Significance of potential cumulative trip generation	139
Table 7-1: Summary of potential impacts of the Sparrow PV Facility	143
Table 7-2: Analysis of project consistency with relevant plans and policies	161

Figures

Figure 1-1: Location of the Stilfontein Cluster	3
Figure 1-2: Location of the Sparrow Project	4
Figure 2-1: Emerging long-term plan in 2019 IRP	13
Figure 2-2: Priority areas identified in the NWBSP for the project region	16
Figure 2-3: BA Process for projects located within a REDZ	19
Figure 3-1: PV cells (left) and panel (right).....	22
Figure 3-2: Schematic of PV plant operation.....	22
Figure 3-3: Components included in individual BA processes for the Stilfontein Cluster.....	23
Figure 3-4: View of the project area	25
Figure 3-5: History of loadshedding in South Africa	26
Figure 3-6: Electricity production in South Africa (TWh)	26
Figure 3-7: Renewable energy production in South Africa (TWh).....	27
Figure 3-8: Annual CO2 emissions from fuel combustion in South Africa (million tons / year)	28
Figure 3-9: Gross power generation by source in South Africa.....	29
Figure 3-10: Power sector emissions intensity and economy energy intensity in South Africa	29
Figure 3-11: Solar resource map for South Africa	31
Figure 3-12: North West substation and transformer capacity	31

Figure 3-13: Illustration of single and dual (two) axis tracking system	34
Figure 3-14: Redox Flow battery schematic	35
Figure 3-15: <i>Sparrow PV project site</i>	42
Figure 3-16: Illustration of bifacial versus monofacial solar panels	44
Figure 3-17: Solid state battery module (left) and system (right)	45
Figure 3-18: Schematic of a substation	46
Figure 3-19: Schematic of a wastewater treatment unit	53
Figure 4-1: Geology of the project area (yellow rectangle)	56
Figure 4-2: Project area topography	57
Figure 4-3: Slopes in the Stilfontein Cluster project area	57
Figure 4-4: Climatic characteristics of the project region	58
Figure 4-5: Average monthly precipitation (left) and temperature (right) in Stilfontein, 1910-2022	58
Figure 4-6: Soil types in the Stilfontein Cluster project area	59
Figure 4-7: Ecosystem threat status of river and wetland ecosystems in the 500 m regulated area of the Stilfontein Cluster	60
Figure 4-8: Hydrogeomorphic units within the 500 m regulated area in the Stilfontein Cluster area	61
Figure 4-9: Depression wetland HGM 1, showing wetland centre (A) and wetland outskirts with hydrophytes (B)	61
Figure 4-10: Floodplain wetland HGM 2, showing downstream (left) and upstream (right) of the portion located within the 500 m of the Stilfontein Cluster	62
Figure 4-11: Habitat type of the project area: open woodland (top), degraded grassland (middle) and rocky outcrop (bottom)	63
Figure 4-12: Selected flora species recorded in the Stilfontein Cluster project area	65
Figure 4-13: Camelthorn trees in the Stilfontein Cluster project area	65
Figure 4-14: Selected reptiles recorded in the Stilfontein Cluster project area	66
Figure 4-15: Selected mammal species observed in the Stilfontein Cluster project area	67
Figure 4-16: White-backed vultures roosting on the 400kV Hermes – Pluto 2 transmission line	69
Figure 4-17: Location of White-backed Vulture roosts on the Hermes/Pluto 2 overhead line	70
Figure 4-18: Location of water reservoirs in the Stilfontein Cluster project area	70
Figure 4-19: Employment status (left) and sectors (right) in the JB Marks LM in 2011	72
Figure 4-20: Economic structure of the JB Marks Municipality in 2017.....	73
Figure 4-21: JB Marks LM, district and provincial education for 2016.....	74
Figure 4-22: Location of heritage observations in the cumulative Stilfontein Cluster area	75
Figure 4-23: Photos of heritage observations in the cumulative Stilfontein Cluster area	77
Figure 4-24: Combined viewshed with viewpoints in the Stilfontein Cluster	79
Figure 4-25: Diab’s wind atlas (left) and Hagemann’s wind atlas (right)	80
Figure 4-26: Distribution of renewable energy production in South African (2020).....	80
Figure 4-27: Renewable energy projects under consideration in the project area	82
Figure 6-1: <i>Existing gravel road site access</i>	126
Figure 6-2: Recommended minimum access separations	127
Figure 6-3: Sight distances at Access 1 to the east (top) and west (bottom)	127
Figure 7-1: Integrated sensitivity map: Sparrow	158
Figure 7-2: <i>Integrated sensitivity map: Stilfontein Cluster area</i>	159
Figure 7-3: Sparrow PV project layout - key infrastructure components	166

Appendices

Appendix A	EAP Declaration
Appendix B	Curriculum Vitae of the EAP(s)
Appendix C	Stakeholder Engagement
Appendix C.1	Stakeholder Database
Appendix C.2	Site Notice and Proof of Placement
Appendix C.3	Newspaper Advert and Proof of Placement
Appendix C.4	Proof of Letter Drop
Appendix C.5	Notification Letter and Proof of Stakeholder Notification
Appendix C.6	Comments Received
Appendix C.7	Issues and Responses Summary

Appendix D	Specialist Studies
Appendix D.1	Freshwater Specialist Study
Appendix D.2	Terrestrial Ecology Specialist Study
Appendix D.3	Avifauna Specialist Study
Appendix D.4	Soil and Land Capability Specialist Study
Appendix D.5	Socio-Economic Specialist Study
Appendix D.6	Heritage Specialist Study
Appendix D.7	Visual Specialist Study
Appendix E	EMPrs
Appendix E.1	EMPr for the Sparrow PV Facility and associated infrastructure
Appendix E.2	Generic EMPr for the Development and Expansion of Substation Infrastructure for Transmission and Distribution of Electricity
Appendix F	Site Sensitivity Verification Report

Acronyms and Abbreviations

AC	Alternating current
AoI	Area of Influence
BA	Basic Assessment
BAR	Basic Assessment Report
BESS	Battery Energy Storage System
BSP	Biodiversity Spatial Plan
CapEx	Capital expenditure
CBA	Critical Biodiversity Area
CIA	Cumulative Impact Assessment
CO ₂	Carbon Dioxide
CSI	Corporate Social Investment
DC	Direct current
DEA&DP	(Western Cape) Department of Environmental Affairs and Development Planning
DFFE	(National) Department of Forestry, Fisheries and the Environment
DHSWS	(National) Department of Human Settlements, Water and Sanitation
DKKDM	Dr Kenneth Kaunda District Municipality
DMRE	Department of Mineral Resources and Energy
DNI	Direct natural (solar) irradiation
DWS	Department of Water and Sanitation
EA	Environmental Authorisation
EAP	Environmental Assessment Practitioner
ECO	Environmental Control Officer
ED	Enterprise Development
EHV	Extra High Voltage
EIA	Environmental Impact Assessment
EIS	Environmental Impact Statement
EMPr	Environmental Management Programme
EN	Endangered
EPC	Engineering Procurement Contractor
ESA	Ecological Support Area
FEPA	Freshwater Ecosystem Priority Area
GA	General Authorisation
GDPR	Regional Gross Domestic Product
GHG	Greenhouse Gas
GN	Government Notice
GW	Gigawatt
ha	Hectares
HDI	Human Development Index
HGM	Hydrogeomorphic (Classification)

HIA	Heritage Impact Assessment
HIV	Human Immunodeficiency Virus
IAPs	Interested and Affected Parties
IDP	Integrated Development Plan
IEM	Integrated Environmental Management
IFC	International Finance Corporation
IPP	Independent Power Producer
IRP	Integrated Resource Plan
IUCN	International Union for Conservation of Nature
km	Kilometres
kV	Kilovolt
LC	Least Concern
LED	Local Economic Development
LM	Local Municipality
LN	Listing Notice
LSA	Later Stone Age
MERO	Municipal Economic Review and Outlook
MSA	Middle Stone Age
MTS	Main Transmission Station
MW	Megawatt
NBA	National Biodiversity Assessment
NEMA	National Environmental Management Act 107 of 1998 as amended
NEM:BA	National Environmental Management: Biodiversity Act 10 of 2004
NEM:PAA	National Environmental Management: Protected Areas Act 57 of 2003
NEM:WA	National Environmental Management: Waste Act 59 of 2008
NERSA	National Energy Regulator of South Africa
NFEPA	National Freshwater Ecosystem Priority Area
NGO	Non-Governmental Organisation
NHRA	National Heritage Resources Act 25 of 1999
NT	Near threatened
NWA	National Water Act 36 of 1998
NWBSP	North West Biodiversity Sector Plan
OpEx	Operational expenditure
PES	Present Ecological State
<u>POPIA</u>	<u>Protection of Personal Information Act 4 of 2013</u>
PPA	Power Purchasing Agreement
PSDF	Provincial Special Development Framework
PV	Photovoltaic
RE	Remainder
REDZ	Renewable Energy Development Zone
REIPPPP	Renewable Energy Independent Power Producers Procurement Programme

RES	Renewable Energy Strategy
S&EIR	Scoping and Environmental Impact Reporting
SABAP	Southern African Bird Atlas Project
SAHRA	South African National Heritage Resources Agency
SAHRIS	South African Heritage Resources Information System
SANBI	South African National Biodiversity Institute
SCC	Species of Conservation Concern
SDF	Spatial Development Framework
SED	Socio-economic Development
SG Code	Surveyor General Code
SIA	Socio-economic Impact Assessment
SIP	Strategic Integrated Projects
SoW	Scope of Work
SRK	SRK Consulting (South Africa) (Pty) Ltd
StatsSA	Statistics South Africa
STC	Strategic Transmission Corridor
ToR	Terms of Reference
VAC	Visual Absorption Capacity
VEC	Valued Environmental and Social Component
VEGMAP	Vegetation Map of South Africa, Lesotho and Swaziland
VIA	Visual Impact Assessment
VP	Viewpoint
VU	Vulnerable
WMA	Water Management Area
WUA	Water Use Authorisation
WUL	Water Use Licence

Glossary

This list contains definitions of symbols, units, abbreviations, and terminology that may be unfamiliar to the reader.

Avifauna	The collective birds of a given region.
Baseline	Information gathered at the beginning of a study which describes the environment prior to development of a project and against which predicted changes (impacts) are measured.
Community	Those people who may be impacted upon by the construction and operation of the project. This includes neighbouring landowners, local communities and other occasional users of the area
Construction Phase	The stage of project development comprising site preparation as well as all construction activities associated with the development.
Consultation	A process for the exchange of views, concerns and proposals about a project through meaningful discussions and the open sharing of information.
Critical Biodiversity Area	Areas of the landscape that must be conserved in a natural or near-natural state in order for the continued existence and functioning of species and ecosystems and the delivery of ecosystem services.
Cumulative Impacts	Direct and indirect impacts that act together with current or future potential impacts of other activities or proposed activities in the area/region that affect the same resources and/or receptors.
Ecological Support Area	Areas which play an important role in supporting the ecological functioning of critical biodiversity areas and/or in delivering ecosystem services that support socio-economic development.
Ecology	The study of the interrelationships of organisms with and within their physical surroundings
Ecosystem	The interconnected assemblage of all living organisms that occupy a given area and the physical environment with which they interact.
Endemic / Endemism	Species unique (native or restricted) to a defined geographic location, i.e. ecological state of a species being unique to a defined geographic location.
Environment	The external circumstances, conditions and objects that affect the existence of an individual, organism or group. These circumstances include biophysical, social, economic, historical and cultural aspects.
Environmental Authorisation	Permission granted by the competent authority for the applicant to undertake listed activities in terms of the NEMA EIA Regulations, 2014.
Environmental Impact Assessment	A process of evaluating the environmental and socio-economic consequences of a proposed course of action or project.
Environmental Impact Assessment Report	The report produced to relay the information gathered and assessments undertaken during the Environmental Impact Assessment.
Environmental Management Programme	A description of the means (the environmental specification) to achieve environmental objectives and targets during all stages of a specific proposed activity.
Ephemeral	A water body that does not flow or contain water year-round, in response to seasonal rainfall and run-off.
Fauna	The collective animals of a particular region, habitat or geological period.
Flora	The collective plants of a particular region, habitat or geological period.
Geohydrology	The study of the character, source and mode of occurrence of groundwater
Heritage Resources	Refers to something tangible or intangible, e.g. a building, an area, a ritual, etc. that forms part of a community's cultural legacy or tradition and is passed down from preceding generations and has cultural significance.

Housekeeping	Maintaining the working environmental in a tidy manner.
Hydrology	(The study of) surface water flow.
Impact	A change to the existing environment, either adverse or beneficial, that is directly or indirectly due to the development of the project and its associated activities.
Independent EAP	An independent person with the appropriate qualifications and experience appointed by the Applicant to manage the Environmental Impact Assessment process on behalf of the Applicant.
Integrated Environmental Management	The practice of incorporating environmental management into all stages of a project's life cycle, namely planning, design, implementation, management and review.
Mitigation measures	Design or management measures that are intended to minimise or enhance an impact, depending on the desired effect. These measures are ideally incorporated into a design at an early stage.
Operational Phase	The stage of the works following the Construction Phase, during which the development will function or be used as anticipated in the Environmental Authorisation.
Red Data List	Species of plants and animals that because of their rarity and/or level of endemism are included on a Red Data List (usually compiled by the IUCN) which provides an indication of their threat of extinction and recommendations for their protection.
Resilient System	An ecosystem or habitat that resists damage and recovers quickly.
Scoping	A procedure to consult with stakeholders to determine issues and concerns and for determining the extent of and approach to an EIA and EMPr (one of the phases in an EIA and EMPr). This process results in the development of a scope of work for the EIA, EMPr and specialist studies.
Specialist study	A study into a particular aspect of the environment, undertaken by an expert in that discipline.
Stakeholders	All parties affected by and/or able to influence a project, often those in a position of authority and/or representing others.
Sustainable development	Sustainable development is generally defined as development that meets the needs of the present generation without compromising the ability of future generations to meet their own needs. NEMA defines sustainable development as the integration of social, economic and environmental factors into planning, implementation and decision-making so as to ensure that development serves present and future generations.

1 Introduction

1.1 Background

South Africa Mainstream Renewable Power Developments (Pty) Ltd (Mainstream) proposes to construct up to nine Photovoltaic (PV) facilities and associated infrastructure for the Stilfontein PV Cluster (see Section 3.2). The Stilfontein Cluster is located ~20 km south-west of Potchefstroom and ~6 km north-east of Stilfontein, in the in the City of Matlosana and JB Marks Local Municipalities and Dr Kenneth Kaunda District Municipality (DKKDM) in North West Province. The Stilfontein Cluster lies within the Klerksdorp Renewable Energy Development Zone (REDZ) (see Figure 1-1).

The proposed project is intended to form part of a submission under the Renewable Energy Independent Power Producers Procurement Programme (REIPPPP). If bidding is unsuccessful and a private offtake opportunity arises, this may be pursued.

A Basic Assessment (BA) process in terms of the National Environmental Management Act 107 of 1998, as amended (NEMA) and the EIA Regulations, 2014, as amended, is required to support an application for EA for the project(s). SRK Consulting (South Africa) (Pty) Ltd (SRK) was appointed by Mainstream to undertake the BA processes for each project in the Stilfontein PV Cluster.

Separate EAs are to be applied for the individual projects in the Stilfontein Cluster as well as the associated grid connections:

- 9 x PV facilities, including 11-33 kV transmission lines, each including Battery Energy Storage Systems (BESS), and 9 x Independent Power Producer (IPP)-side on-site substations;
- 9 x Eskom-side on-site substations and 132 kV transmission lines to the Main Transmission Station (MTS); and
- 1 x MTS and 400 kV lines to existing Hermes Pluto transmission lines.

This BA Report (BAR) relates to the Sparrow PV facility, BESS and IPP-side of the Sparrow substation (see Figure 1-2).

1.2 Purpose of the Report

In terms of relevant legislation, the project may not commence prior to obtaining a suite of authorisations (see Section 2). This report has been compiled in support of these applications. The BAR documents the steps undertaken during the pre-application phase to assess the significance of impacts and determine measures to mitigate the negative impacts and enhance the benefits (or positive impacts) of the proposed project. The report presents the findings of the BA and a description of the public participation that forms part of the process.

The BAR is accompanied by an Environmental Management Programme (EMPr), which documents the management and monitoring measures that need to be implemented during the design, construction and operational phases of the project to ensure that impacts are appropriately mitigated and benefits enhanced.

More specifically, the objectives of this BAR are to:

- Inform the stakeholders about the proposed project and the BA process followed;
- Obtain contributions from stakeholders (including the applicant, consultants, relevant authorities and the public) and ensure that all issues, concerns and queries raised are fully documented and addressed;
- Assess in detail the potential environmental and socio-economic impacts of the project;
- Identify environmental and social mitigation measures to address the impacts assessed; and

- Produce a BAR that will assist the Department of Forestry, Fisheries and the Environment (DFFE) to decide whether (and under what conditions) to authorise the proposed development.

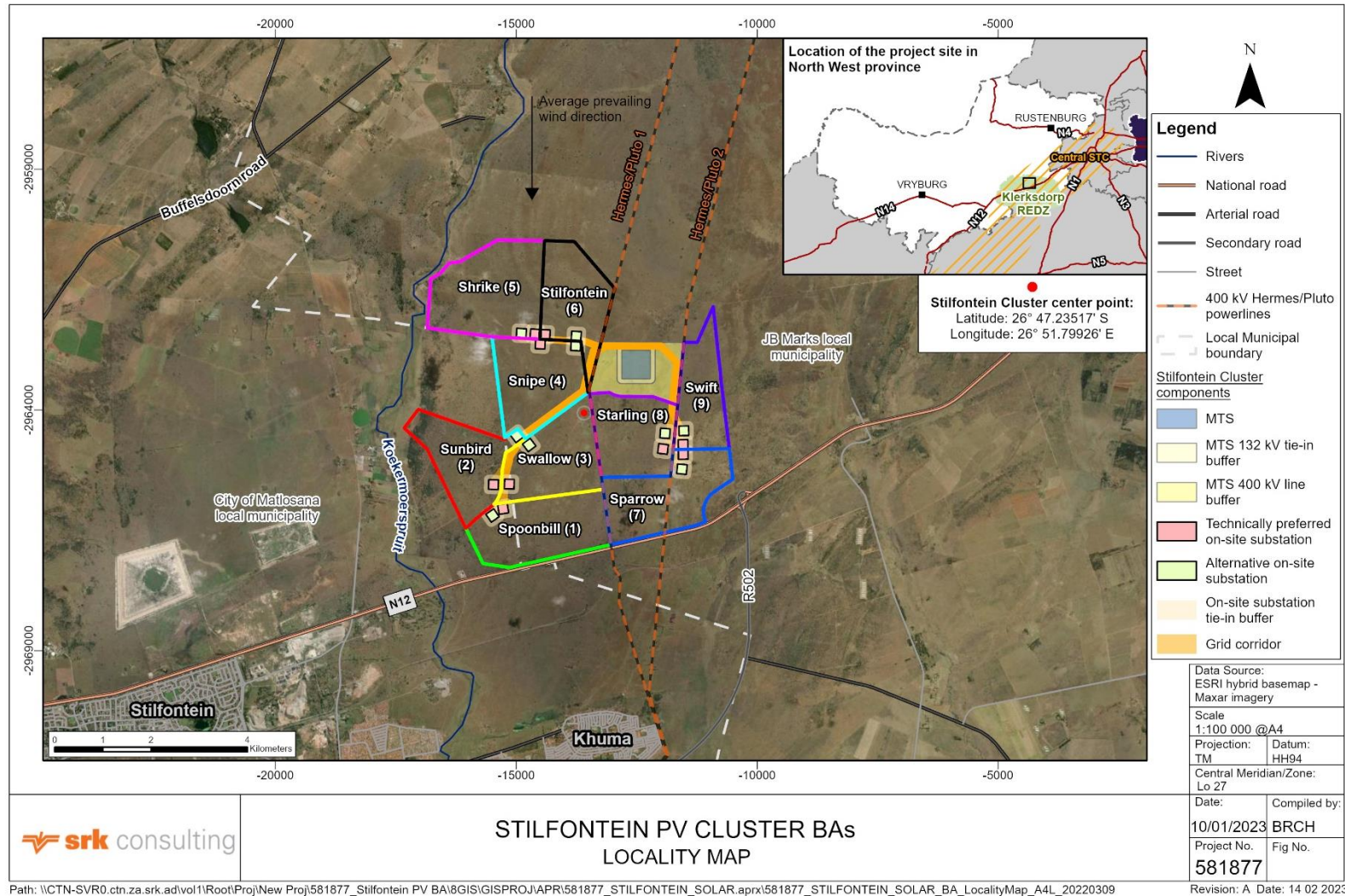

Figure 1-1: Location of the Stilfontein Cluster

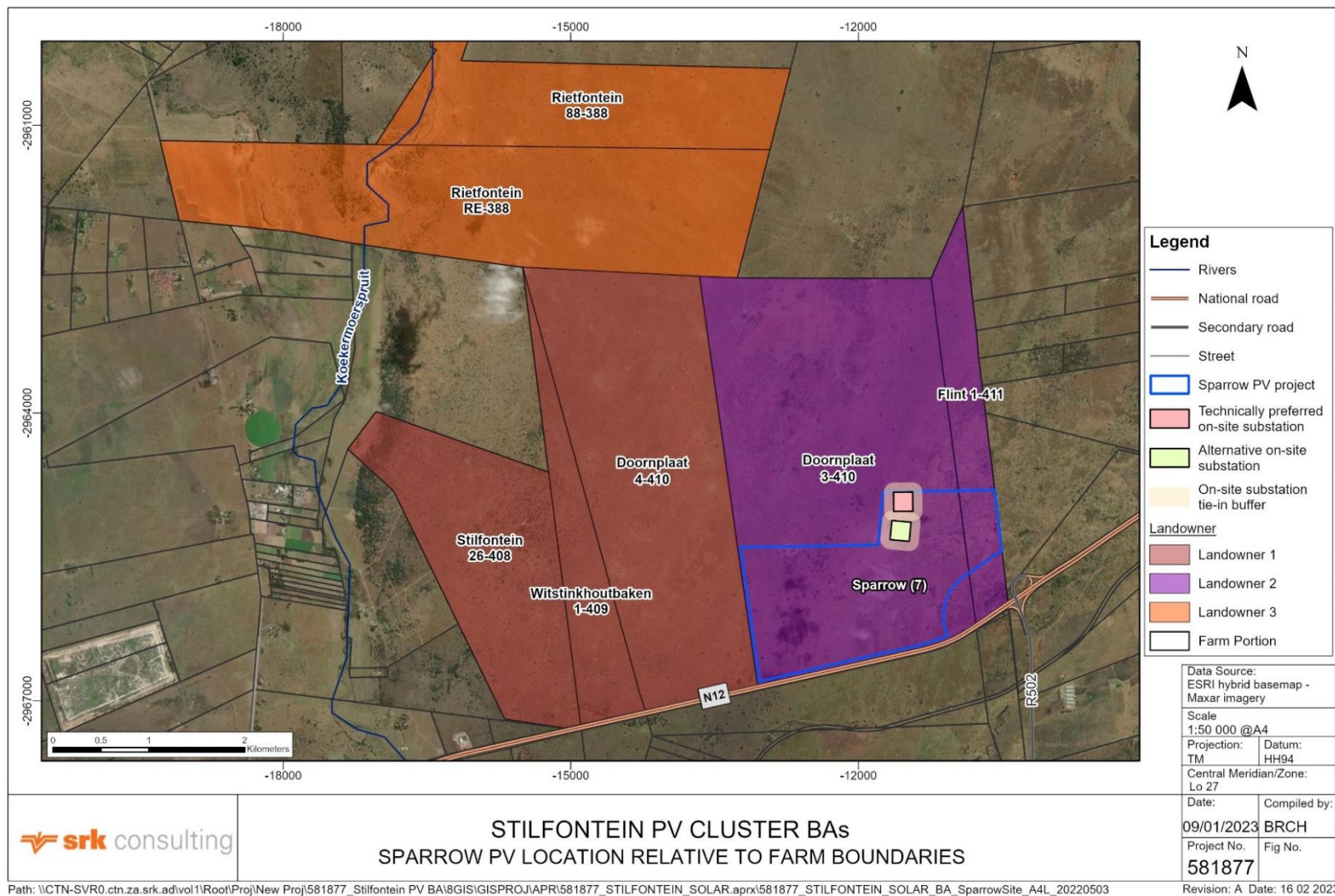

Figure 1-2: Location of the Sparrow Project ¹

¹ In their review of the Draft BAR, DFFE requested that more specific layout information than described in the Draft BAR be shown on a map. This site layout detail is presented in Figure 7-3.

1.3 Structure of this Report

This report discusses relevant environmental legislation and its application to this project, outlines the BA process, presents a detailed project description and environmental baseline, details the stakeholder engagement process followed and assesses the potential impacts of the project before concluding the report with a set of pertinent findings and key recommendations.

The report consists of the following sections:

Section 1: Introduction

Provides an introduction and background to the proposed project and outlines the purpose of this document and the assumptions and limitation applicable to the study.

Section 2: Governance Framework and Environmental Process

Provides a brief summary and interpretation of the relevant legislation as well as pertinent strategic planning documents and outlines the approach to the environmental process.

Section 3: Project Description

Describes the location and current status of the site and provides a brief summary of the surrounding land uses as well as background to, motivation, and description of, the proposed project.

Section 4: Description of the Affected Environment

Describes the biophysical and socio-economic characteristics of the affected environment against which potential project impacts are assessed.

Section 5: Stakeholder Engagement

Details the stakeholder engagement approach and summarises stakeholder comments that informed the impact assessment.

Section 6: Environmental Impact Assessment

Describes the specialist studies undertaken and assesses the potential impacts of the project utilising SRK's proven impact assessment methodology.

Section 7: Conclusions and Recommendations

Provides an Environmental Impact Statement (EIS), describes the need and desirability of the project, and summarises the recommendations of the BAR.

The BAR has been prepared in accordance with Section 19 of the EIA Regulations, 2014 (as amended).

1.4 Content of the Report

Section 3 of Appendix 1 of the EIA Regulations, 2014 prescribe the required content in a BAR. These requirements and the sections of this BAR in which they are addressed, are summarised in Table 1-1.

Table 1-1: Content of BAR as per Appendix 1 of the EIA Regulations, 2014

Appendix 1 S 3(1) Ref:	Item	BAR Section:
(b) (i)	The 21-digit Surveyor General code of the properties	3.6.1
(b) (ii)	The physical address and farm name (where available)	3.6.1
(b) (iii)	The coordinates of the boundary of the property / properties (where (3) (b) (i) and (3) (b) (ii) are not available)	N/A
(c)	A plan indicating the location of the proposed activity / activities and associated infrastructure, or:	<i>Figure 1-1</i> <i>Figure 1-2</i> <i>Figure 7-3</i>
(c) (ii)	On land where the property has not been defined, the coordinates within which the activity is to be undertaken	Figure 1-2 and <i>Table 3-4</i>
(d)	A description of the scope of the proposed activity, including:	
(d) (i)	All listed and specified activities trigger and being applied for	2.1.1.1
(d) (ii)	A description of the associated structures and infrastructure related to the development	3
(e)	A description of the policy and legislative context within which the development is proposed including:	
(e) (i)	An identification of all legislation, policies, plans, guidelines, spatial tools, municipal development planning frameworks, and instruments that are applicable to this activity and have been considered in the preparation of the report; and	2
(e) (ii)	How the proposed activity complies with and responds to the legislation and policy context, plans, guidelines, tools frameworks, and instruments;	2, 7.2
(f)	A motivation for the need and desirability for the proposed development, including the need and desirability of the activity in the context of the preferred location	3.4, 7.2
(g)	A motivation for the preferred site, activity and technology alternative	7.4
(h)	A full description of the process followed to reach the proposed development footprint within the approved site, including:	
(h) (i)	Details of all the alternatives considered;	3.5, 6.1
(h) (ii)	Details of the public participation process undertaken in terms of regulation 41 of the Regulations, including copies of the supporting documents and inputs;	5
(h) (iii)	A summary of the issues raised by interested and affected parties, and an indication of the manner in which the issues were incorporated, or the reasons for not including them	5.2.3
(h) (iv)	The environmental attributes associated with the alternatives focusing on the geographical, physical, biological, social, economic, heritage and cultural aspects;	4
(h) (v)	The impacts and risks identified, including the nature, significance, consequence, extent, duration and probability of the impacts, including the degree to which these impacts can be reversed, may cause irreplaceable loss of resources, and can be avoided, managed or mitigated	0
(h) (vi)	The methodology used in determining and ranking the nature, significance, consequences, extent, duration and probability of potential environmental impacts and risks associated with the alternatives	6.1.3
(h) (vii)	Positive and negative impacts that the proposed activity and alternatives will have on the environment and on the community that may be affected focusing on the geographical, physical, biological, social, economic, heritage and cultural aspects	0, Table 7-1
(h) (viii)	The possible mitigation measures that could be applied and level of residual risk	0, Table 7-1
(h) (ix)	The outcome of the site selection matrix	3.5
(h) (x)	If no alternatives, including alternative locations for the activity were investigated, the motivation for not considering such; and	3.5

Appendix 1 Item S 3(1) Ref:		BAR Section:
(h) (xi)	A concluding statement indicating the preferred alternatives, including preferred location of the activity	7.4
(i)	A full description of the process undertaken to identify, assess and rank the impacts the activity and associated structures and infrastructure will impose on the preferred location through the life of the activity, including:	0
(i) (i)	A description of all environmental issues and risks that were identified during the environmental impact assessment process	0
(i) (ii)	An assessment of the significance of each issue and risk and an indication of the extent to which the issue and risk could be avoided or addressed by the adoption of mitigation measures;	0
(j)	An assessment of each identified potentially significant impact and risk, including:	
(j) (i)	Cumulative impacts	0
(j) (ii)	The nature, significance and consequences of the impact and risk	0
(j) (iii)	The extent and duration of the impact and risk	0
(j) (iv)	The probability of the impact and risk occurring	0
(j) (v)	The degree to which the impact and risk can be reversed	0
(j) (vi)	The degree to which the impact and risk may cause irreplaceable loss of resources	0
(j) (vii)	The degree to which the impact and risk can be avoided, managed or mitigated;	0
(k)	Where applicable, a summary of the findings and impact management measures identified in any specialist report complying with Appendix 6 to these Regulations and an indication as to how these findings and recommendations have been included in the final report;	6.2 to 6.8, Table 7-1
(l)	An EIS which contains:	
(l) (i)	A summary of the key findings of the environmental impact assessment	7.1
(l) (ii)	A map at an appropriate scale which superimposes the proposed activity and its associated structures and the infrastructure on the environmental sensitivities of the preferred site indicating any areas that should be avoided, including buffers	Figure 7-1 and <u>Figure 7-2</u>
(l) (iii)	A summary of the positive and negative impacts and risks of the proposed activity and identified alternatives	7.1
(m)	Based on the assessment, and where applicable, impact management measures from specialist reports, the recording of the proposed impact management outcomes for the development for inclusion in the EMPr;	0, 7.3
(n)	Any aspects which were conditional to the findings of the assessment either by the EAP or specialist which are to be included as conditions of authorisation	7.4
(o)	A description of any assumptions, uncertainties and gaps in knowledge which relate to the assessment and mitigation measures proposed;	1.5
(p)	A reasoned opinion as to whether the proposed activity should or should not be authorised, and if the opinion is that it should be authorised, any conditions that should be made in respect of that authorisation;	7.4
(q)	Where the proposed activity does not include operational aspects, the period for which the environmental authorisation is required and the date on which the activity will be concluded and the post construction monitoring requirements finalised	N/A
(r)	An undertaking under oath or affirmation by the EAP in relation to	Appendix A
(r) (i)	The correctness of the information provided in the reports	
(r) (ii)	The inclusion of comments and inputs from stakeholders and I&APs	
(r) (iii)	The inclusion of inputs and recommendations from the specialist reports where relevant; and	

Appendix 1 Item S 3(1) Ref:		BAR Section:
(r) (iv)	Any information provided by the EAP to interested and affected parties and any responses by the EAP to comments or inputs made by interested and affected parties; and	
(s)	Where applicable, details of any financial provision for the rehabilitation, closure, and ongoing post decommissioning management of negative environmental impacts;	N/A
(t)	Where applicable, any specific information required by the competent authority; and	N/A
(u)	Any other matter required in terms of section 24(4)(a) and (b) of the Act.	N/A

1.5 Assumptions and Limitations

As is standard practice, the report is based on a number of assumptions and is subject to certain limitations. These are as follows:

- Information provided by Mainstream and specialists is assumed to be accurate and correct;
- The assessment of the significance of impacts of the proposed development on the affected environment has been based on the assumption that the activities will be confined to those described in Section 3. If there are any substantial changes to the project description, impacts may need to be reassessed;
- The project considers different cell technology alternatives (see Section 3.5.4.1). As polycrystalline cells have lower efficiency, a larger number of panels is required to generate the same energy output as fewer monocrystalline panels. It is assumed that the choice of cell technology does not materially affect the project layout presented in Figure 3-15;
- For the impact assessment it is conservatively assumed that the full footprint of the Sparrow PV facility is developed;
- Where detailed design information is not available, the precautionary principle, i.e. a conservative approach which overstates negative impacts and understates benefits, has been adopted;
- It is assumed that the stakeholder engagement process undertaken during the BA process has identified all relevant concerns of stakeholders; and
- Mainstream and its contractors will in good faith implement the mitigation measures identified in this report. To this end it is assumed that Mainstream and its contractors will commit sufficient resources and employ suitably qualified personnel.

Limitations and assumptions applicable to specific specialist studies are listed in the respective specialist reports. Notwithstanding the above, SRK is confident that these assumptions and limitations do not compromise the overall findings of the report.

2 Governance Framework and Environmental Process

2.1 Legal Requirements

There are a number of regulatory requirements at local, provincial and national level with which the proposed development will have to conform. Key legal requirements include the following:

- National Environmental Management Act 107 of 1998 (NEMA);
 - EIA Regulations, 2014, promulgated in terms of NEMA;
 - National Web Based Environmental Screening Tool;
 - Procedures for the Assessment and Minimum Criteria for Reporting;
 - Procedures relating to renewable energy projects in a REDZ;
 - Procedures relating to renewable energy projects in a STC;
 - Exclusion of certain infrastructure from the requirement to obtain EA;
 - Procedures relating to Integrated Resource Plan Projects;
- National Environmental Management: Biodiversity Act 10 of 2004 (NEM:BA);
- National Water Act 36 of 1998 (NWA); and
- National Heritage Resources Act 25 of 1999 (NHRA).

A brief summary of SRK's understanding of the relevant Acts and Regulations that are applicable to this study is provided below. Note that other legislative requirements may also pertain to the proposed project. As such, the summary provided below is not intended to be definitive or exhaustive and serves only to highlight key environmental legislation and obligations.

2.1.1 National Environmental Management Act 107 of 1998

NEMA establishes a set of principles which all authorities must consider when exercising their powers. These include the following:

- Development must be sustainable;
- Pollution must be avoided or minimised and remedied;
- Waste must be avoided or minimised, reused or recycled;
- Negative impacts must be minimised; and
- Responsibility for the environmental consequences of a policy, project, product or service applies throughout its life cycle.

Section 28(1) states that “*every person who causes, has caused or may cause significant pollution or degradation of the environment must take reasonable measures to prevent such pollution or degradation from occurring, continuing or recurring*”. If such degradation/pollution cannot be prevented, then appropriate measures must be taken to minimise or rectify such pollution. These measures may include:

- Assessing the impact on the environment;
- Informing and educating employees about the environmental risks of their work and ways of minimising these risks;

- Ceasing, modifying or controlling actions which cause pollution/degradation;
- Containing pollutants or preventing movement of pollutants;
- Eliminating the source of pollution; and
- Remedying the effects of the pollution.

Legal requirements for this project:

Mainstream has a responsibility to ensure that the proposed activities and the BA process conform to the principles of NEMA. In terms of Section 28 of NEMA, the proponent is obliged to take actions to prevent pollution or degradation of the environment, and to ensure that the environmental impacts associated with the project are considered and mitigated where possible.

2.1.1.1 EIA Regulations, 2014 (as amended)

Sections 24 and 44 of NEMA make provision for the promulgation of regulations that identify activities which may not commence without an EA issued by the competent authority. In this context, the EIA Regulations, 2014², promulgated in terms of NEMA, govern the process, methodologies and requirements for the undertaking of EIAs in support of EA applications. Listing Notices 1-3 in terms of NEMA list the activities that require EA (“NEMA listed activities”).

The EIA Regulations, 2014 lay out two alternative authorisation processes. Depending on the type of activity that is proposed, either a Basic Assessment (BA) process or a Scoping and Environmental Impact Reporting (S&EIR) process is required to obtain EA. Listing Notice (LN) 1³ lists activities that require a BA process, while LN 2⁴ lists activities that require S&EIR. LN 3⁵ lists activities in certain sensitive geographic areas that require a BA process.

The regulations for both processes – BA and S&EIR – stipulate that:

- Public participation must be undertaken as part of the assessment process;
- The assessment must be conducted by an independent Environmental Assessment Practitioner (EAP);
- The relevant authorities must respond to applications and submissions within stipulated time frames;
- Decisions taken by the authorities can be appealed by the proponent or any other Interested and Affected Party (IAP); and
- A draft EMPr must be compiled and released for public comment.

Government Notice (GN) R982 of 2014 sets out the procedures to be followed and content of reports compiled during the BA and S&EIR processes.

The NEMA National Appeal Regulations⁶ make provision for appeal against any decision issued by the relevant authorities. In terms of the Regulations, an appeal must be lodged with the relevant authority in writing within 20 days of the date on which notification of the decision (EA) was sent to the applicant or IAP (as applicable). The applicant, the decision-maker, an IAP and organs of state must submit their responding statement, if any, to the appeal authority and the appellant within 20 days from the date of receipt of the appeal submission.

² GN R982 of 2014, as amended

³ GN R983 of 2014, as amended

⁴ GN R984 of 2014, as amended

⁵ GN R985 of 2014, as amended

⁶ GN R993 of 2014, as amended

The proposed project includes activities that are listed in terms of the EIA Regulations, 2014 (see Table 2-1).

Table 2-1: NEMA listed activities (2014) applicable to the proposed project

No.	Listed Activity	Applicability
Listing Notice 1		
11	The development of facilities or infrastructure for the transmission and distribution of electricity - (i) outside urban areas or industrial complexes with a capacity of more than 33 but less than 275 kilovolts	<ul style="list-style-type: none"> • 11-33/132kV IPP-side on-site substation with a footprint of <u>15 012m²</u>
24	The development of a road - (i) with a reserve wider than 13.5 meters or where no reserve exists where the road is wider than 8 meters	<ul style="list-style-type: none"> • Where existing access roads are not available, new gravel access roads up to 12 m wide will be constructed
28	Residential, mixed, retail, commercial, industrial or institutional developments where such land was used for agriculture, game farming, equestrian purposes or afforestation on or after 01 April 1998 and where such development: (ii) will occur outside an urban area, where the total land to be developed is bigger than 1ha	<ul style="list-style-type: none"> • PV facility (deemed to be an industrial facility) on land currently used for grazing
56	The widening of a road by more than 6 metres, or the lengthening of a road by more than 1 kilometre (i) where the existing reserve is wider than 13.5 metres; or (ii) where no reserve exists, where the existing road is wider than 8 metres.	<ul style="list-style-type: none"> • Where existing access roads are not sufficient, they may be widened to up to 12 m wide and/or lengthened
Listing Notice 2		
1	The development of facilities or infrastructure for the generation of electricity from a renewable resource where the electricity output is 20 megawatts or more	<ul style="list-style-type: none"> • Sparrow PV facility has a design electricity output of up to 150 MW
15	The clearance of an area of 20 ha or more of indigenous vegetation	<ul style="list-style-type: none"> • Sparrow PV facility has a footprint of <u>313.9 ha</u> (clearance is more extensive for bifacial than monofacial panel technology, see Section 3.6.3) • 11-33/132kV IPP-side on-site substation with a footprint of <u>15 012m²</u> • BESS with a footprint of <u>9.99 ha</u>

Legal requirements for this project in relation to the EIA process:

Mainstream is obliged to apply for EA for the activities listed in Table 2-1. As the project triggers activities in LN 2, a S&EIR process would ordinarily be required. However, a BA process is being undertaken as indicated by Sections 2.1.1.4.

2.1.1.2 National Web Based Environmental Screening Tool

In terms of Regulation 16(1)(b)(v) of the NEMA EIA Regulations, 2014, an application for EA must include “the report generated by the national web based environmental screening tool”. On 20 March 2020, notice was given that that the submission of such a report is compulsory for all applications submitted after 4 October 2019 (GN R960 of 2020).

The national screening tool is based on broad scale national environmental sensitivity data and identifies specialist studies that may be required for the EIA. It is the responsibility of the EAP to confirm whether these specialist studies will be conducted or provide a motivation as to why the specialist studies will not be conducted as part of the EIA process.

The Screening Tool Report has informed the identification of specialist studies required for the BA and, where applicable, motivation as to why certain specialist studies have not been scoped was submitted to DFFE during the pre-application meeting.

Legal requirements for this project

The Screening Tool identified a number of site sensitivities in relation to the proposed project and proposed a number of specialist studies, which were evaluated by the EAP (see Table 6-1). The Screening Tool Report and a verification report confirming the specialist studies proposed to inform the BA process were submitted to DFFE on 21 February 2022 with the Pre-Application Meeting Request form. The Screening Tool Report was updated subsequent to the adjustment of the project boundaries and the updated Screening Tool Report is attached the EA application form. The Site Sensitivity Verification Report is presented as Appendix F.

2.1.1.3 Procedures for the Assessment and Minimum Criteria for Reporting

In terms of the *Procedures for the Assessment and Minimum Criteria for Reporting on Identified Environmental Themes when Applying for EA* (GN R320 of 2020):

- The EAP and / or specialist(s) must verify (update) the findings of the Screening Tool based on desktop sources and a site inspection and compile a Verification Report;
- Where the Screening Tool indicates that a site is sensitive for an “Identified Environmental Theme”, a specialist assessment (for more sensitive sites) or Compliance Statement (for less sensitive sites) must be undertaken, depending on the verified sensitivity of the site;
- Specialists must ensure compliance with the *Protocols for the assessment and minimum report content requirements of environmental impacts* published in GN320 of 2020 and GN 1150 of 2020 for the various identified environmental themes; and
- Should the Screening Tool (or EAP) identify site sensitivities for disciplines which are not “Identified Environmental Themes” and specialist assessment is required, specialist reporting must comply with the requirements of Appendix 6 of the EIA Regulations, 2014.

Legal requirements for this project

Specialists report content must comply with the relevant Protocols for the assessment and minimum report content requirements of environmental impacts or Appendix 6 of the EIA Regulations, 2014. Evidence of compliance is provided in each specialist report (see Appendix C).

2.1.1.4 Procedures Relating to Renewable Energy Projects in a REDZ

GN 142 of 2021 (*Identification of Procedures to be Followed when Applying for or Deciding on an Environmental Authorisation Application for Large Scale Wind and Solar Photovoltaic Facilities, when occurring in Renewable Energy Development Zones*) stipulates the following for renewable energy projects triggering LN2 Activity 1, including associated activities necessary for the realisation of such a facility (e.g. access roads):

- They must follow a BA process if the entire facility lies within a REDZ; and

- The timeframe for decision-making on such applications is 57 days⁷.

GN 145 of 2021 (*Identification of Procedures to be Followed when Applying for or Deciding on an Environmental Authorisation Application for the Development of Electricity Transmission and Distribution Infrastructure when Occurring in Renewable Energy Development Zones*) stipulates the following for transmission line projects triggering LN1 Activity 11 where the greater part of the facility is located within a REDZ:

- The applicant must negotiate a route with all landowners and submit the route as part of the EA application;
- The Generic Environmental Management Programme (EMPr) for the Development and Expansion of Substation Infrastructure for Transmission and Distribution of Electricity and the Generic Environmental Management Programme (EMPr) for the Development and Expansion of Overhead Electricity Transmission and Distribution Infrastructure, published in GN 435 of 2019, apply; and
- The timeframe for decision-making on such applications is 57 days.

Legal requirements for this project in relation to the EIA process:

The project triggers LN 2 Activity 1, but since the project lies entirely within the Klerksdorp REDZ, instead of following an S&EIR process the project must thus be assessed via a BA process.

The project triggers LN 1 Activity 11, and the applicant must thus negotiate a powerline route with all landowners and submit the route as part of the EA application. These negotiated agreements, in the form of signed lease agreements with each landowner, will be submitted directly to DFFE.

The DFFE decision-making timeframe on the BA process for this project is 57 days.

2.1.2 National Environmental Management: Biodiversity Act 10 of 2004

The purpose of the NEM:BA is to provide for the management and conservation of South Africa's biodiversity and the protection of species and ecosystems that warrant national protection. The NEM:BA makes provision for the publication of bioregional plans and the listing of ecosystems and species that are threatened or in need of protection. Threatened or Protected Species Regulations (2007), Guidelines for the determination of bioregions and the preparation and publication of bioregional plans (2009) and a National List of Ecosystems that are Threatened and in Need of Protection (2011) have been promulgated in terms of NEM:BA.

A published bioregional plan is a spatial plan indicating terrestrial and aquatic features in the landscape that are critical for conserving biodiversity and maintaining ecosystem functioning. These areas are referred to as Critical Biodiversity Areas (CBAs) in terms of NEM:BA. Bioregional plans provide guidelines for avoiding the loss or degradation of natural habitat in CBAs with the aim of informing, EIAs and land-use planning (including Environmental Management Frameworks [EMFs], Spatial Development Frameworks [SDFs], and Integrated Development Plans [IDPs]).

Permits to carry out a restricted activity involving listed threatened or protected species or alien species may only be issued after an assessment of risks and potential impacts on biodiversity has been undertaken.

Legal requirements for this project:

The North West Biodiversity Sector Plan (2015) sets out Critical Biodiversity Areas (CBAs) and Ecological Support Areas (ESA) for the region, preliminarily identified by the South African Botanical Institute (SANBI).

⁷ Reduced from 107 days

The overlap with the project area is discussed in Section 2.2.5. The impacts of the project on the biodiversity are assessed. Measures to manage and control alien invasive species, as required by NEM: BA, are included as required mitigation.

2.1.3 National Water Act 36 of 1998

Water use in South Africa is controlled by the NWA. The executive authority is the Department of Human Settlements, Water and Sanitation (DHSWS). The NWA recognises that water is a scarce and unevenly distributed national resource in South Africa. Its provisions are aimed at achieving sustainable and equitable use of water to the benefit of all users and to ensure protection of the aquatic ecosystems associated with South Africa's water resources. The provisions of the Act are aimed at discouraging pollution and wastage of water resources.

In terms of the Act, a land user, occupier or owner of land where an activity that causes or has the potential to cause pollution of a water resource has a duty to take measures to prevent pollution from occurring. If these measures are not taken, the responsible authority may do whatever is necessary to prevent the pollution or remedy its effects, and to recover all reasonable costs from the responsible party.

Section 21 of the NWA specifies a number of water uses, including:

- (a) taking water from a water resource;
- (b) storing water;
- (c) impeding or diverting the flow of water in a watercourse;
- (d) engaging in a stream flow reduction activity contemplated in section 36 [of the NWA];
- (e) engaging in a controlled activity identified as such in section 37(1) [of the NWA] or declared under section 38(1) [of the NWA];
- (f) discharging waste or water containing waste into a water resource through a pipe, canal, sewer, sea outfall or other conduit;
- (g) disposing of waste in a manner which may detrimentally impact on a water resource;
- (h) disposing in any manner of water which contains waste from, or which has been heated in, any industrial or power generation process;
- (i) altering the bed, banks, course or characteristics of a watercourse;
- (j) removing, discharging or disposing of water found underground if it is necessary for the efficient continuation of an activity for the safety of people; and
- (k) using water for recreational purposes.

These water uses require authorisation in terms of Section 22 (1) of the Act, unless they are listed in Schedule 1 of the NWA, are an existing lawful use, fall under a General Authorisation issued in terms of section 39 or if the responsible authority waives the need for a licence.

Legal requirements for this project:

Water will be sourced from authorised service providers and/or existing boreholes and/or abstracted from surface water sources, which will be determined during detailed design.

The placement of project structures and infrastructure, including stormwater infrastructure, within 500 m of a wetland boundary may be considered a water use in terms of S21 (c) and (i). The storage of waste or

release of wastewater may be considered a water use in terms of S21 (g). A Water Use Authorisation, if required, will be pursued if and when the project is awarded preferential bidder status and final design is underway⁸.

2.1.4 National Heritage Resources Act 25 of 1999

The protection and management of South Africa's heritage resources are controlled by the NHRA. The enforcing authority for the Act is the South African National Heritage Resources Agency (SAHRA). In terms of the Act, historically important features such as graves, trees, archaeological artefacts / sites and fossil beds are protected. Similarly, culturally significant symbols, spaces and landscapes are also afforded protection.

Section 38 of the NHRA requires that any person who intends to undertake certain categories of development must notify SAHRA at the very earliest stage of initiating such a development and must furnish details of the location, nature and extent of the proposed development. SAHRA has designed the South African Heritage Resources Information System (SAHRIS) database to assist the developer in providing the necessary information to enable SAHRA to decide whether a Heritage Impact Assessment (HIA) will be required.

Section 38 also makes provision for the assessment of heritage impacts as part of an EIA process and indicates that, if such an assessment is deemed adequate, a separate HIA is not required. There is however the requirement in terms of Section 38 (8) for the consenting authority (in this case the DFFE) to ensure that the evaluation of impacts on the heritage resources fulfils the requirements of the relevant heritage resources authority (SAHRA), and that the comments and recommendations of the heritage resources authority are taken into account prior to the granting of the consent.

Section 38(1) of the NHRA specifies activities that trigger the need for the proponent to notify SAHRA of the proposed development, in order for SAHRA to determine the need for further Heritage Assessment. The proposed project triggers a number of these activities, including:

- a) Construction of a road, wall, power line, canal or other similar form of linear development or barrier over 300 m in length; and
- c) Any development or activity that will change the character of a site (i) exceeding 5 000 m² in extent, (ii) involving three or more existing erven or subdivisions thereof.

⁸ As noted in the REIPPPP Bid Window 5 Overview, the Department of Human Settlements, Water and Sanitation will only consider applications for water use licenses in respect of Projects, once Bidders are appointed as Preferred Bidders by the DMRE. For this reason, a Preferred Bidder which, due to no fault, negligence or contributory negligence of its own, does not have a Water Use License at Commercial Close or whose Water Use License is, at that date, the subject of any appeal, review proceedings or other legal challenge, will, in the Department's sole discretion, be afforded an extension of time as is reasonable in the circumstances (DMRE, 2021).

Legal requirements for this project:

Mainstream is required to notify SAHRA, via the SAHRIS database, of the proposed project and to undertake the assessments deemed necessary by SAHRA. Heritage, archaeological and paleontological impacts were assessed as part of the BA process, and the Heritage Impact Assessment (HIA) and BA documentation was uploaded to SAHRIS.

2.2 Planning Policy Framework

This section discusses a number of key planning documents and policies relevant to the project. The policies and plans briefly discussed below include regional and local development and spatial plans:

- IRP for Electricity 2010 – 2030;
- Strategic Integrated Projects (SIP);
- Renewable Energy Strategy for North West Province (2012);
- North West Provincial Development Plan (PDP) (2013);
- North West Biodiversity Sector Plan (NWBSP) (2015);
- DKKDM Integrated Development Plan (IDP) (2017);
- JB Marks Local Municipality (LM) IDP (2017).

Section 7.2 examines the extent to which the proposed project is consistent with relevant plans and policies.

2.2.1 Integrated Resource Plan for Electricity 2010 – 2030

The IRP was promulgated in March 2011 and updated in 2019. It determines South Africa's long term electricity demand and the type, cost, timing and generating capacity required to meet this demand. The IRP set targets for additional generation capacity of ~40 000 MW to meet future electricity demand and secure reserves, and provides input into economic, environmental and social policy development and funding.

The IRP further identifies the preferred generation technologies required to meet the expected demand up to 2030, incorporating objectives such as reduced greenhouse gas (GHG) emissions, reduced water consumption, affordable electricity, diversified electricity generation sources and localised and regional development. The envisaged energy mix includes coal, nuclear, natural gas, renewable energy and hydropower sources. Energy (battery) storage is deemed important in the South African context where the power system does not have the requisite storage capacity or flexibility required for the large increase in renewable energy.

By 2019, ~18 000 MW of new generation capacity had been committed (commissioned, procured or officially announced by the Minister of Energy), including ~6 500 MW procured under the REIPPPP, 9 600 MW by the Medupi and Kusile coal power plants and 1 005 MW from gas turbines (DoE, 2019).

The 2019 IRP envisages the installation of a further 6 000 MW of solar and 14 400 MW of wind energy between 2022 and 2030, taking solar and wind energy to 10.5% and 22.5% of total installed capacity and 6.3% and 17.8% of generated electricity in South Africa, respectively. This is to be achieved through annual installation of 1 000 MW PV in most years until 2030 and 1 600 MW wind energy each year until 2030⁹.

⁹ In July 2022, the South African President announced that amount of new renewable energy generation capacity that would be procured through REIPPPP Bid Window 6 would be doubled to 5 200 MW (Hall, 2022).

The IRP also envisages the installation of 2 088 MW additional energy storage capacity (see Figure 2-1) (DoE, 2019).

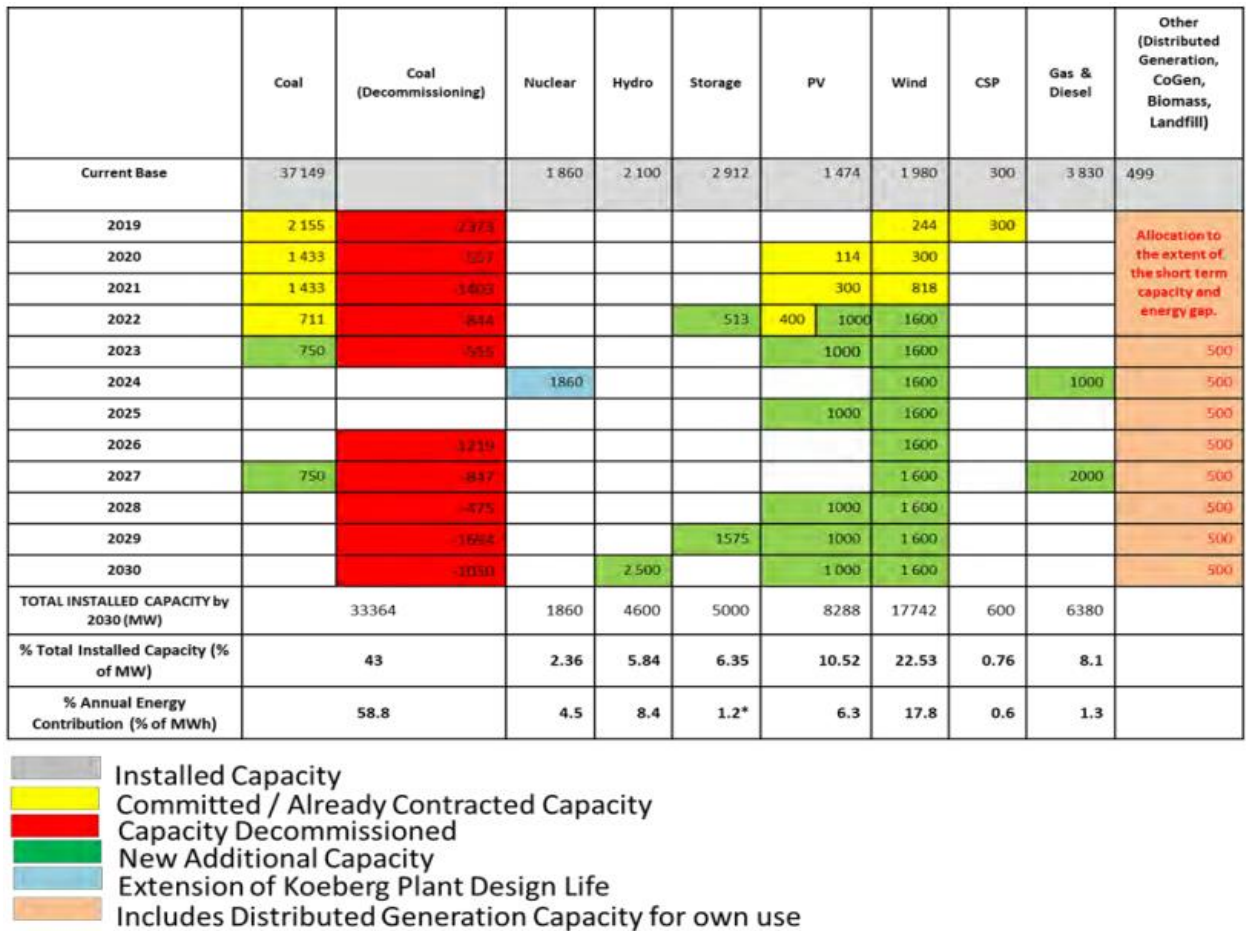

Figure 2-1: Emerging long-term plan in 2019 IRP

Sources: (DoE, 2019)

2.2.2 Strategic Integrated Projects

Eighteen Strategic Integrated Projects (SIP) have been developed and approved in terms of the National Infrastructure Plan (2012) to support economic development and address service delivery in South Africa. Each SIP comprises a large number of specific infrastructure components and programmes.

The National Infrastructure Plan (2012) identifies three energy SIPs (South African Government, n.d.):

- SIP 8: Green energy in support of the South African economy
 - Support sustainable green energy initiatives on a national scale through a diverse range of clean energy options as envisaged in the Integrated Resource Plan (IRP2010); and
 - Support bio-fuel production facilities.
- SIP 9: Electricity generation to support socio-economic development
 - Accelerate the construction of new electricity generation capacity in accordance with the IRP2010 to meet the needs of the economy and address historical imbalances.
 - Monitor implementation of major projects such as new power stations: Medupi, Kusile and Ingula.
- SIP 10: Electricity transmission and distribution for all

- Expand the transmission and distribution network to address historical imbalances, provide access to electricity for all and support economic development.
- Align the 10-year transmission plan, the services backlog, the national broadband roll-out and the freight rail line development to leverage off regulatory approvals, supply chain and project development capacity.

2.2.3 Renewable Energy Strategy for North West Province (2012)

The Renewable Energy Strategy (RES) for North West Province was developed in recognition of the need to participate in South Africa's renewable energy sector. The RES provides guidelines for the development and production of renewable energy across North West Province, including domestic and industrial renewable energy generation, and analyses the feasibility of various renewable energy resources in the Province. Solar (PV and solar water heaters) facilities were identified as some of the most viable alternatives for renewable energy projects in North West Province.

The aims of the RES are to improve the North West Province environment, reduce its contribution to GHG emissions and alleviate energy poverty, whilst promoting economic development and job creation and developing a green economy. The RES therefore provides a foundation for North West Province's contribution to renewable energy in South Africa.

With a large percentage of the North West Province population living in rural areas, access to municipality-supplied electricity is relatively limited.

2.2.4 North West Provincial Development Plan (2015)

The Provincial Development Plan (PDP) (2013) identifies eight development priorities to promote economic transformation in North West Province, including the promotion of environmental sustainability and economic infrastructure (including renewable energy infrastructure).

The PDP identifies various actions related to renewable energy generation to be implemented in the Province, including the development of energy infrastructure and service provision, expanding renewable energy with particular focus on solar power (solar power heaters and PV technologies), sustaining ecosystems, using natural resources more effectively, improving energy efficiency and developing more renewable sources.

The PDP 2030 vision envisages that renewable sources will comprise a large share of the provincial energy sector, and that economic growth and development are promoted through adequate investment in energy infrastructure, whilst ensuring social equity and environmental sustainability are maintained. The PDP identifies high initial capital expenditure and limited grid access as challenges to the implementation of renewable energy projects.

2.2.5 North West Biodiversity Sector Plan (2015)

The North West Biodiversity Sector Plan (NW BSP) (READ, 2015) was compiled to inform land use planning, environmental, water and land use assessments and natural resource management. The aim of the NW BSP is to identify the minimum area required to maintain and conserve major ecological infrastructure and biodiversity in North West Province by mapping biodiversity priority areas (i.e. CBAs and ESAs). The NW BSP comprehensively revised the CBAs and ESAs previously mapped and described in the 2009 North West Biodiversity Conservation Assessment.

Identified key pressures on biodiversity in North West Province are associated with agriculture (cropping and grazing), mining and urban expansion. Other pressures include the dependence of rural communities

on natural harvestable products, poor water catchment and river management, climate change, alien invasives and harvesting, poaching and trading in indigenous species (READ, 2015).

CBAs are defined as terrestrial and aquatic areas of the landscape that need to be maintained in a natural or near-natural state to ensure the continued existence and functioning of species and ecosystems and the delivery of ecosystem services. Maintaining an area in a natural state can include a variety of biodiversity compatible land uses and resource uses.

ESAs are defined as terrestrial and aquatic areas that are not essential for meeting biodiversity representation targets (thresholds), but which nevertheless play an important role in supporting the ecological functioning of CBAs and/or in delivering ecosystem services that support socio-economic development, such as water provision, flood mitigation or carbon sequestration. The degree or extent of restriction on land use and resource use in these areas may be lower than that recommended for CBAs.

In relation to spatial planning, the difference between CBAs and ESAs relates to where in the landscape the biodiversity impact of any land use activity action is most significant (READ, 2015):

- In CBAs where a change in land use results in a change from the desired ecological state, the impact on biodiversity as a result of this change is most significant locally at the point of impact through the direct loss of a biodiversity feature (e.g. loss of a populations or habitat). Land management objectives are to maintain the area in a natural or near-natural state that maximises the retention of biodiversity pattern and ecological process; and
- In ESAs a change from the desired ecological state is most significant elsewhere in the landscape through the indirect loss of biodiversity due to a breakdown, interruption or loss of an ecological process pathway. Land management objectives are to maintain the area in at least a semi-natural state as ecologically functional landscapes that retain basic natural attributes (ESA 1) or to maintain as much ecological functionality as possible (generally these areas have been substantially modified) (ESA 2).

CBAs and ESAs identified in the project region are shown in [Figure 2-2](#), [Figure 7-1](#) and [Figure 7-2](#).

The DKKDM IDP places particular focus on community empowerment through the reduction of poverty, unemployment and inequality (DKKDM, 2017). It describes district key performance areas as basic service delivery and infrastructure development, municipal institutional development transformation, district economic development, financial viability and management, good governance and public participation, and spatial rationale. The vision for the DKKDM is described as exploring prosperity through sustainable service delivery for all.

While the IDP does not make reference to renewable energy, the 2021/22 IDP Review identifies “Optimum use of existing resources including agriculture, forestry, renewable energy” potential as a Spatial Development Value of the Province (DKKDM, 2021).

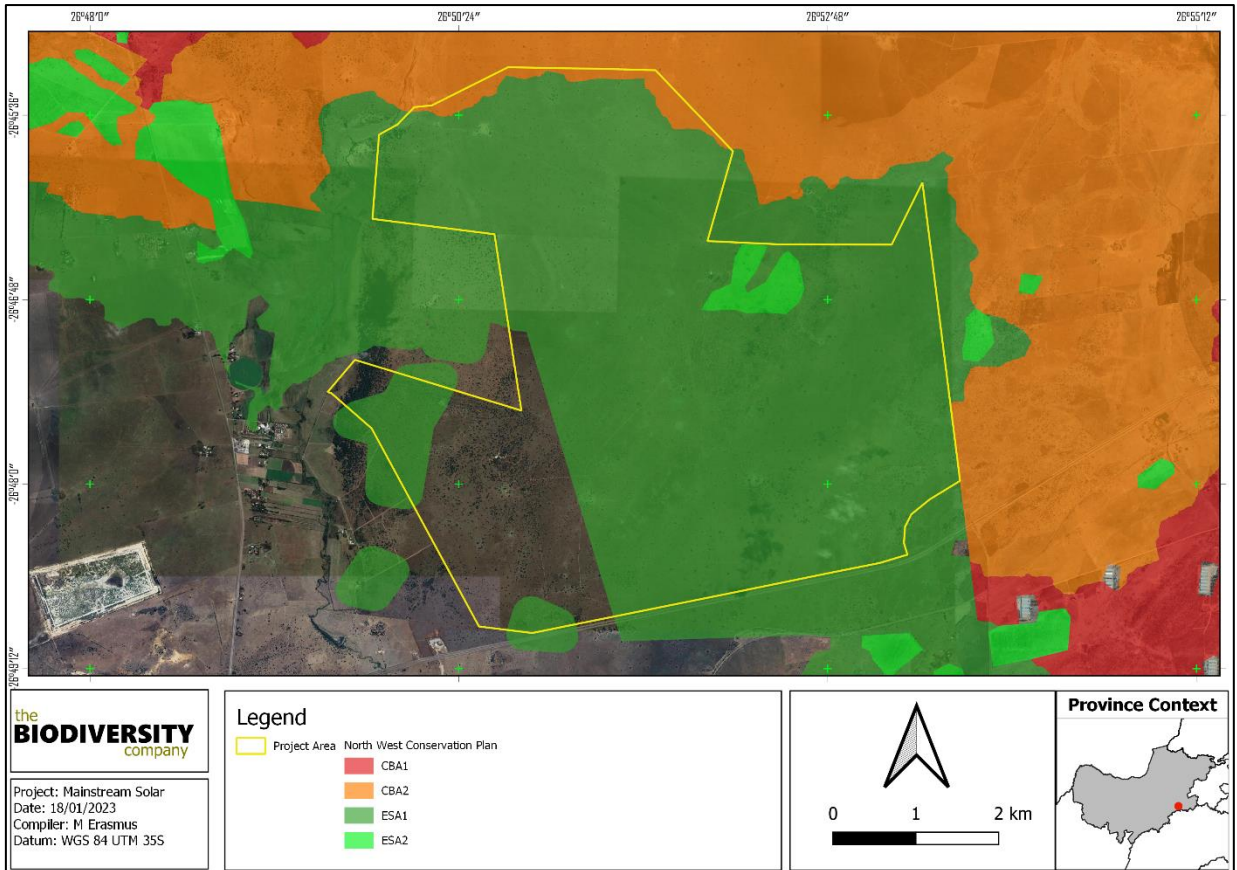

Figure 2-2: Priority areas identified in the NWBSP for the project region

Sources: (The Biodiversity Company, 2022c)

2.2.6 Dr Kenneth Kaunda District Municipality Integrated Development Plan

The DKKDM IDP places particular focus on community empowerment through the reduction of poverty, unemployment and inequality (DKKDM, 2017). It describes district key performance areas as basic service delivery and infrastructure development, municipal institutional development transformation, district economic development, financial viability and management, good governance and public participation, and spatial rationale. The vision for the DKKDM is described as exploring prosperity through sustainable service delivery for all.

While the IDP does not make reference to renewable energy, the 2021/22 IDP Review identifies “Optimum use of existing resources including agriculture, forestry, renewable energy” potential as a Spatial Development Value of the Province (DKKDM, 2021).

2.2.7 JB Marks Local Municipality Integrated Development Plan

The JB Marks LM IDP (2017 – 2022) (North West 405 Municipality, 2017) objectives include the expedition of service delivery, with development priorities being access to electricity, land and housing, agriculture, rural and economic development and quality sustainable service delivery.

Neither the 2017 – 2022 IDP nor its 2020 – 2021 amendment (JB Marks LM, 2020) reference renewable energy, which was not a considered factor in the area other than in the form of solar water geysers implemented in parts of the municipality. However, the most recent 2022-23 Draft IDP cites the North West Province goal of expanding renewable energy, with special reference to solar power, and the national goal of using renewable energy to promote employment and economic growth. While these are not translated

into municipal goals or strategies for renewable energy, their reference indicates increasing local awareness of the sector (JB Marks LM, 2022).

2.3 Environmental Process

The general approach to this study is guided by the principles contained in Section 2 of NEMA and those of Integrated Environmental Management (IEM).

NEMA lists a number of principles that apply to the actions of organs of state and that also serve as reference for the interpretation of environmental legislation and administration of environmental processes. The principles most relevant to environmental assessment processes and projects for which authorisation is required are summarised below.

Principles relevant to the BA process:

- Adopt a risk-averse and cautious approach;
- Anticipate and prevent or minimise negative impacts;
- Pursue integrated environmental management;
- Involve stakeholders in the process; and
- Consider the social, economic and environmental impacts of activities.

Principles relevant to the project:

- Place people and their needs at the forefront of concern and serve their needs equitably;
- Ensure development is sustainable, minimises disturbance of ecosystems and landscapes, pollution and waste, achieves responsible use of non-renewable resources and sustainable exploitation of renewable resources;
- Assume responsibility for project impacts throughout its life cycle; and
- Polluter bears remediation costs.

This BA process complies with these principles through its adherence to the EIA Regulations, 2014 and associated guidelines, which set out clear requirements for, *inter alia*, impact assessment and stakeholder involvement (see below), and through the assessment of impacts and identification of mitigation measures. An initial analysis of the project's compliance with the aims of sustainable development is provided in the impact assessment.

In accordance with the IEM Information Series (DEAT, 2004), an open, transparent approach, which encourages accountable decision-making, has been adopted.

The underpinning principles of IEM require:

- Informed decision making;
- Accountability for information on which decisions are made;
- A broad interpretation of the term "environment";
- An open participatory approach in the planning of proposals;
- Consultation with interested and affected parties;

- Due consideration of alternatives;
- An attempt to mitigate negative impacts and enhance positive impacts of proposals;
- An attempt to ensure that the social costs of development proposals are outweighed by the social benefits;
- Democratic regard for individual rights and obligations;
- Compliance with these principles during all stages of the planning, implementation and decommissioning of proposals; and
- The opportunity for public and specialist input in the decision-making process.

Although various environmental authorisations, permits or licences are required before the proposed project may proceed, the regulatory authorities are committed to the principle of cooperative governance and, in order to give effect to this principle, a single BA process is required to inform all applications. To this end, a single BAR (this report) has been compiled. The BAR will be submitted to the DFFE in support of the application for environmental authorisation of NEMA listed activities.

Supplementary applications will be made as required for the remaining authorisations.

The study will also be guided by the requirements of the EIA Regulations, 2014 (see Section 2.1.1.1), which are more specific in their focus and define the detailed approach to the BA process, as well as relevant guidelines published by the (former) DEA and the Western Cape Department of Environmental Affairs and Development Planning (DEA&DP), including:

- DEA’s Integrated Environmental Management Guideline: Guideline on Need and Desirability (DEA, 2017a), which contains “information on best practice and how to meet the peremptory requirements prescribed by the legislation and sets out both the strategic and statutory context for the consideration of the need and desirability of a development involving any one of the NEMA listed activities” (DEA, 2017);
- DEA&DP’s EIA Guideline and Information Document Series (DEA&DP, 2013), which includes guidelines on Generic Terms of Reference (ToR) for EAPs and Project Schedules, Public Participation, Alternatives, Need and Desirability and Exemption Applications and Appeals; and
- DEA’s Public Participation Guideline (DEA, 2017), which provides information and guidance for applicants, stakeholders and EAP’s on the public participation requirements as prescribed in the EIA Regulations of 2014.

2.3.1 Submission of Applications

Various environmental authorisations are required before the proposed project may proceed. Application forms must generally be submitted at the outset of or during the BA process. The required environmental applications and their status are listed in Table 2-2.

Table 2-2: Applications for authorisation

Application	Authority	Status
EA	DFFE	The application was submitted to the DFFE on 05 April 2023 in compliance with Section 16 of the EIA Regulations, 2014. <i>An updated application will be submitted together with the Final BAR, reflecting the changes in the activities applied for as discussed in Table 2-1.</i>

Application	Authority	Status
Heritage	SAHRA	<i>Interim comment has been provided by SAHRA (see Appendix C6) and SAHRA will provide final comment on the final BAR to be uploaded onto SAHRIS subsequent to submission of the final BAR to DFFE.</i>

2.3.2 BA Process and Phasing

The BA process consists of two phases, namely the Pre-Application (which has been completed) and Basic Assessment Phases (the current phase) (see Figure 2-3 below).

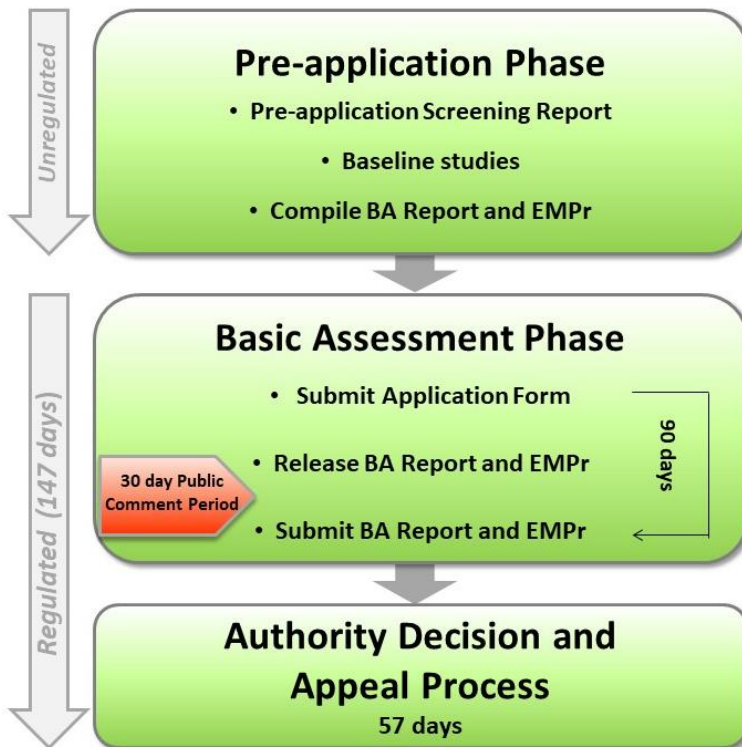

Figure 2-3: BA Process for projects located within a REDZ

The objectives of the Pre-Application Phase are to:

- Identify stakeholders, including neighbouring landowners/ residents and authorities;
- Undertake specialist studies;
- Compile the draft BA Report which should:
 - Describe the affected environment;
 - Document and contextualise the biophysical baseline conditions of the study area and the socio-economic conditions of affected communities;
 - Assess in detail the potential environmental and socio-economic impacts of the project;
 - Identify environmental and social mitigation measures to avoid and/or address the impacts assessed; and

- Develop and/or amend environmental and social management plans based on the mitigation measures developed in the BA Report and EMPr.

The objectives of the BA Phase are to:

- Inform stakeholders of the proposed activity, feasible alternatives and the BA process;
- Provide stakeholders with the opportunity to participate effectively in the process and identify any issues and concerns associated with the proposed activity, review specialist study ToR;
- Build capacity amongst stakeholders during the BA process so that they may actively and meaningfully participate;
- Inform and obtain contributions from stakeholders, including relevant authorities, the public and local communities and address their relevant issues and concerns;
- Submit a final BA Report to the relevant authorities (in this case, DFFE).

Further detail about activities undertaken or planned during the BA process is presented in Section 5.

3 Project Description

Mainstream proposes to construct and operate the Sparrow PV facility with maximum nameplate capacity of up to 150 MW, as well as grid connections, BESS and associated infrastructure. The Sparrow facility is located in the JB Marks Local Municipality within the larger DKKDM in North West Province, South Africa. The project site is located approximately 13 km east of the town of Stilfontein along the N12 and forms part of the proposed, larger Stilfontein PV Cluster.

The proposed project is intended to form part of a submission under the Renewable Energy Independent Power Producers Procurement Programme (REIPPPP). If bidding is unsuccessful and a private offtake opportunity arises, this may be pursued. Electricity will either be despatched directly into the national grid or stored on site in a BESS and evacuated to the grid on demand.

An overview of the proposed Sparrow PV facility key components and dimensions is provided in Table 3-4.

Grid connection infrastructure is the subject of separate applications (for EA) and BA processes and is briefly described in Section 3.2.2.

3.1 PV Facilities: An Introduction

A photovoltaic (PV) power plant or facility, also known as a solar farm or solar power plant, is a large-scale, grid-connected PV power system. It supplies power to utilities (e.g. Eskom), or large private offtakers (e.g. industrial or municipal customers).

Most **PV panels** are made from semiconductor materials, usually some form of silicon. When photons from sunlight hit the semiconductor material, free electrons are generated which flow through the material to produce a direct electrical current (DC). This is known as the photoelectric effect¹⁰.

PV panels produce the photoelectric effect directly, without intermediary processes or devices (for example, they do not use a liquid heat-carrying agent, like water, which is used in solar thermal plants). PV panels do not concentrate energy, they simply convert photons into electricity which is then transmitted somewhere else (McFadden, 2021).

PV cells are grouped into PV modules¹¹ (see Figure 3-1), which are then assembled into PV panels. The collection of multiple PV panels is connected in series to generate electricity at the requisite voltage and current required and thus form PV arrays. Panels or arrays are mounted onto fixed tilt, single axis or dual axis solar tracker support structures.

Generated DC power may be stored in electro-chemical **batteries** for later use. It needs to be converted to alternating current (AC) by an **inverter** before it can be fed into the electrical grid. A three phase step up **transformer** (see Figure 3-2) increases (or steps up) the voltage to 33kV prior to evacuation to the substation (for further voltage increase), electrical grid and onward transmission.

¹⁰ The classic structure of photovoltaic cells is based on two layers, one negatively (N) and the other positively (P) charged. The two layers of silicon dioxide and aluminium create a circuit, while the anti-reflective surface is responsible for facilitating the absorption of sunlight (Enelgreenpower.com, n.d.).

¹¹ Photovoltaic modules are made up of many individual, interconnected photovoltaic cells. To ensure the modules are tilted correctly and facing the sun, they are housed in support structures. Every module has two output terminals that collect the generated current and transfer it to the management systems at a solar power station.

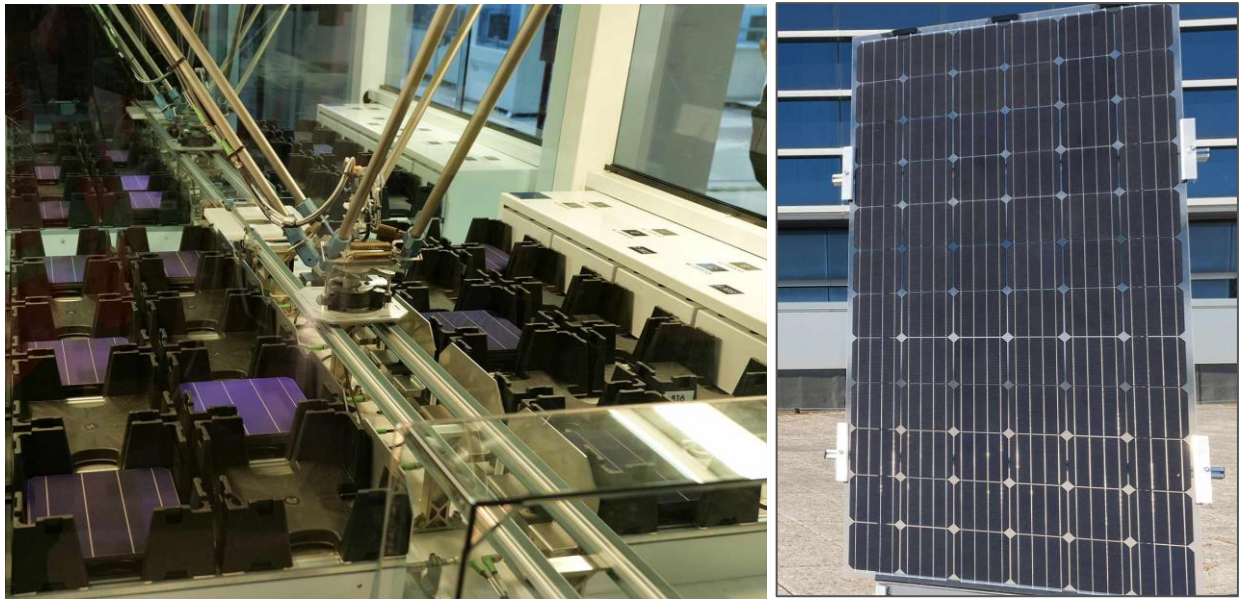

Figure 3-1: PV cells (left) and panel (right)

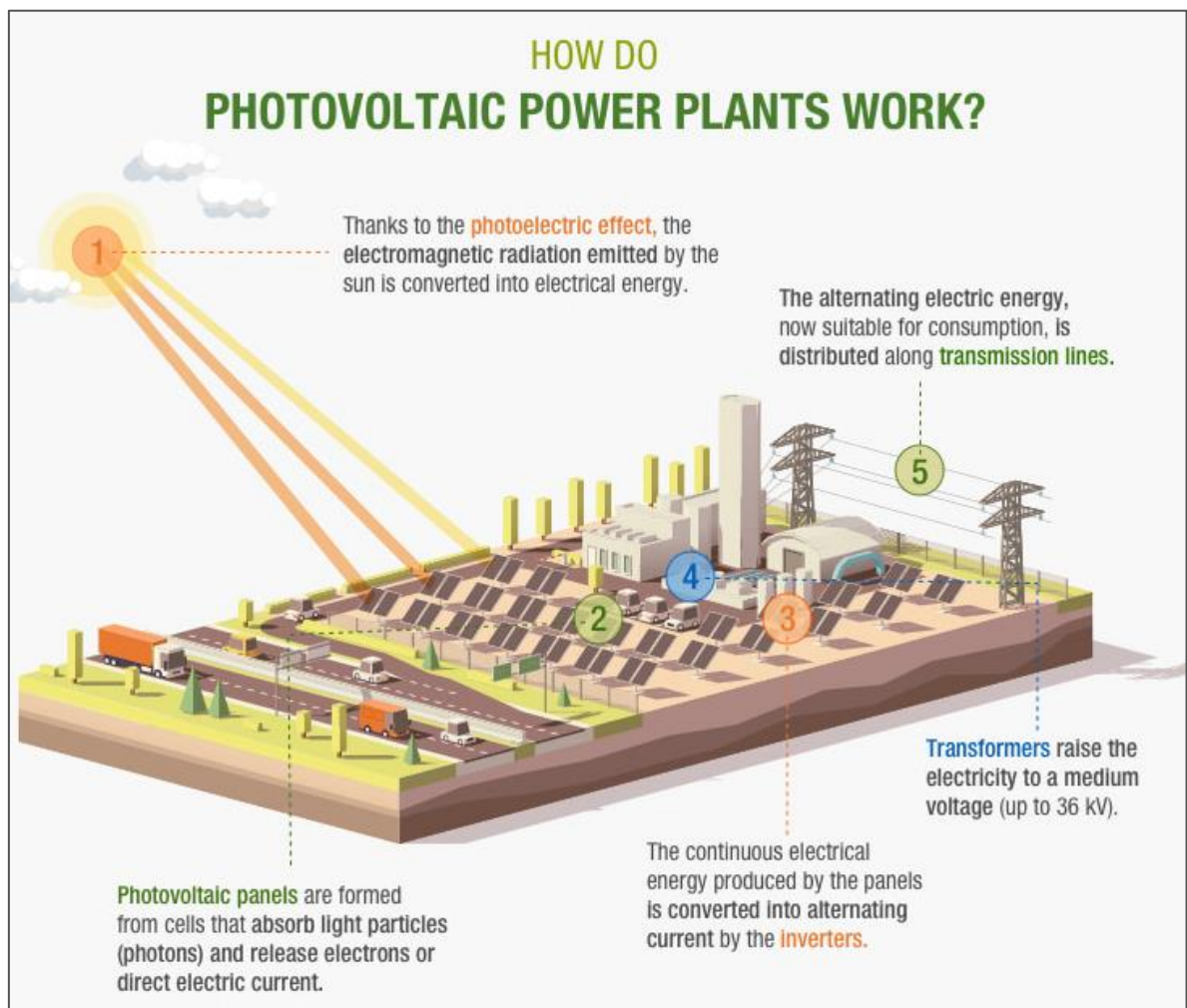

Figure 3-2: Schematic of PV plant operation

Sources: (Iberdrola, 2022)

The performance of a PV plant depends on the climatic conditions, equipment used and system configuration. The primary energy input is the electromagnetic radiation emitted by the sun. A key determinant of the output is the conversion efficiency of the solar modules, which depends on the type of solar cell used. Current modules have a significantly reduced degradation rate and retain ~88% of their output performance after 25 years. The accumulation of dust or organic material on the solar panels that blocks incident sunlight can be a significant loss factor (Wikipedia, 2021c), (PVEDUCATION.COM, n.d.).

3.2 Stilfontein PV Cluster Overview

The project forms part of the proposed, larger Stilfontein PV Cluster, which comprises nine PV facilities of up to 150 MW each, as well as grid connections, BESS and ancillary infrastructure. **Separate EA applications will be submitted for the individual PV facilities and grid connections through separate BA processes** (see Figure 3-3). The Stilfontein Cluster is briefly described here.

The Stilfontein Cluster is entirely located within the Klerksdorp REDZ and the Central Strategic Transmission Corridor (STC) (see Figure 1-1). The Cluster has a total footprint of ~2 114 ha. At this stage it not known which IPPs or facilities (projects) will be selected as preferred bidders through the REIPPPP bidding process and/or potentially receive interest from private off-takers, and thus which components of the Stilfontein Cluster will be developed.

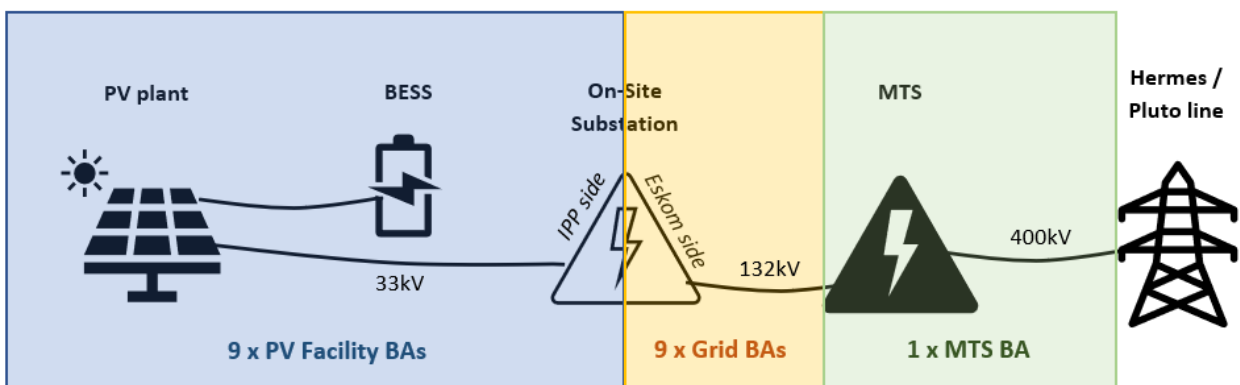

Figure 3-3: Components included in individual BA processes for the Stilfontein Cluster

3.2.1 PV Facilities

The Stilfontein Cluster comprises nine proposed PV facilities, each with a notional development area (footprint) of ~220 to 405 ha: Spoonbill (Project 1), Sunbird (Project 2), Swallow (Project 3), Snipe (Project 4), Shrike (Project 5), Stilfontein (Project 6), Sparrow (Project 7), Starling (Project 8) and Swift (Project 9) (see Figure 1-1).

Each PV facility comprises the following key components:

- PV arrays with a total maximum export capacity of up to 150 MW;
- Internal cabling connecting panels, inverters and transformers;
- Lithium-Ion BESS;
- 11-33kV underground cable / overhead powerline between the PV facility and on-site substation;
- Internal gravel roads;
- Fencing and lighting;
- Material and construction laydown areas;

- Stormwater infrastructure;
- Water supply and water storage infrastructure;
- Offices, including ablutions with septic tank / conservancy tanks sewage treatment infrastructure;
- Operational control centre and maintenance area; and
- Security guard house.

A comprehensive description of the proposed Sparrow facility, which is the subject of this BA process, is provided in Sections 3.6 and 3.7.

An overview of the proposed Sparrow PV facility key components and dimensions is provided in Table 3-4.

3.2.2 Grid Connection Infrastructure

The Stilfontein Cluster, if fully developed, will include ten substations and associated powerlines (see Figure 1-1):

- Nine 11-33/132kV on-site substations each serving one PV facility;
- 132kV above ground powerline, varying in length between ~1.8 and 3.8 km, from 11-33/132kV on-site substations to the Main Transmission Substation (MTS);
- One 132/400kV MTS;
- 400kV above ground powerline (Loop In / Loop Out), approximately 1 km long, connecting to the existing 400 kV Eskom Pluto / Hermes 1 and 2 powerlines; and
- Material laydown areas (temporary for construction phase and permanent for operation phase).

Grid connection infrastructure is the subject of separate applications (for EA) and BA processes.

3.3 Description of the Project Area

The project is located in the JB Marks Local Municipality, approximately 13 km east of the town of Stilfontein and 25 km west of Potchefstroom, directly north of the N12.

The project area falls within the western portion of the highveld, the elevated inland plateau that comprises roughly 30% of South Africa's land area. The highveld terrain is generally devoid of mountains and consists primarily of rolling plains. The rainy season occurs in summer, with substantial afternoon thunderstorms being typical occurrences in November, December and January. Frost occurs in winter. The highveld is home to some of the South Africa's most important commercial farming areas, as well as its largest concentration of metropolitan centres (Wikipedia, 2022).

Stilfontein was established in 1949 as a residential centre for three new large gold mines, the Hartebeesfontein, Buffelsfontein and Stilfontein mines (Wikipedia, 2021). Potchefstroom is one of the largest urban centres in North West Province and accommodates five tertiary institutions, including the Potchefstroom Campus of the North-West University. Industry (including steel, food and chemical processing), services and agriculture are important economic sectors (Wikipedia, 2021a).

The N12 National Road dual carriageway connects Kimberley and Klerksdorp west of the project site to Potchefstroom and Johannesburg east of the project site. The project can be directly accessed from the N12.

The project area has a rural setting. It is dominated by grassland and low bushes. Numerous farmsteads and extensive agricultural lands are located within and adjacent to the Stilfontein Cluster project area. The

site and surrounding area are primarily used for game farming, and open veld is dissected with game fence. Isolated gravel roads, farmsteads and waterholes are located throughout in the project area.

The existing 400 kV Hermes – Pluto 1 and 2 powerlines traverse the site in a north-southerly direction (see Figure 1-1 and Figure 3-4).



Figure 3-4: View of the project area

Sources: SRK, February 2022

3.4 Proponent’s Project Motivation

3.4.1 Motivation for Renewable Energy Generation in South Africa

3.4.1.1 Increasing Power Generation to Reduce Loadshedding Impacts on Economic Production and Quality of Life

South Africa has been forced to implement periodic loadshedding due to insufficient power production in nine of the 16 years between 2007 and 2022 (see Figure 3-5). Loadshedding accelerated in 2022, which was another record year for loadshedding as the supply gap widens further; more loadshedding was experienced from July to September 2022 than in in any year before, and September 2022 on its own had loadshedding than in the whole of 2020(BusinessTech, 2022) (CSIR, 2022). Loadshedding is a result of broadly declining electricity production (see Figure 3-6), which increased renewable energy production could only partly compensate for (see Figure 3-7). However, Figure 3-6 and Figure 3-7 illustrate that renewable energy, which can be commissioned in a relatively short period, has an important role to play to address South Africa’s energy shortage.

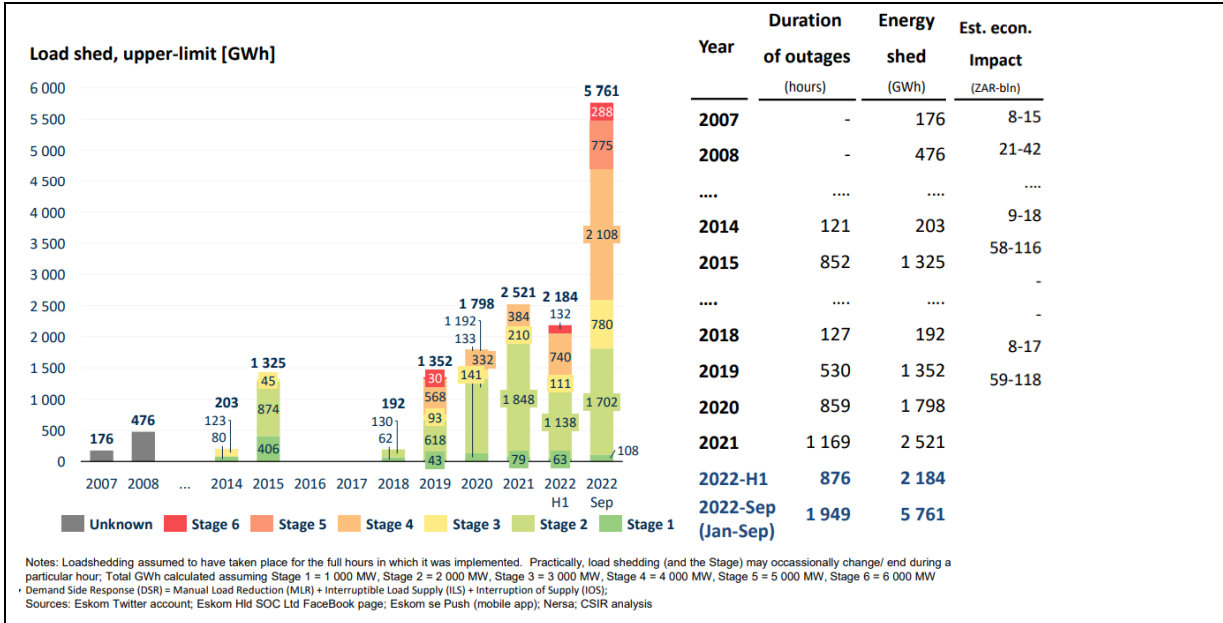

Figure 3-5: History of loadshedding in South Africa

Source: (CSIR, 2022), (CSIR, 2020)

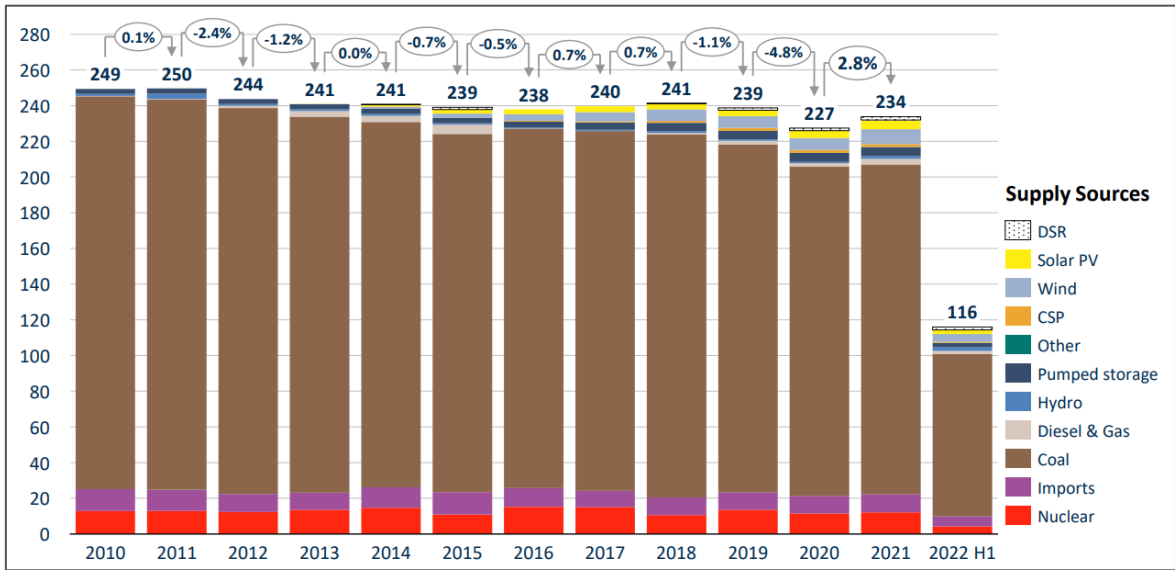

Figure 3-6: Electricity production in South Africa (TWh)

Source: (CSIR, 2022)

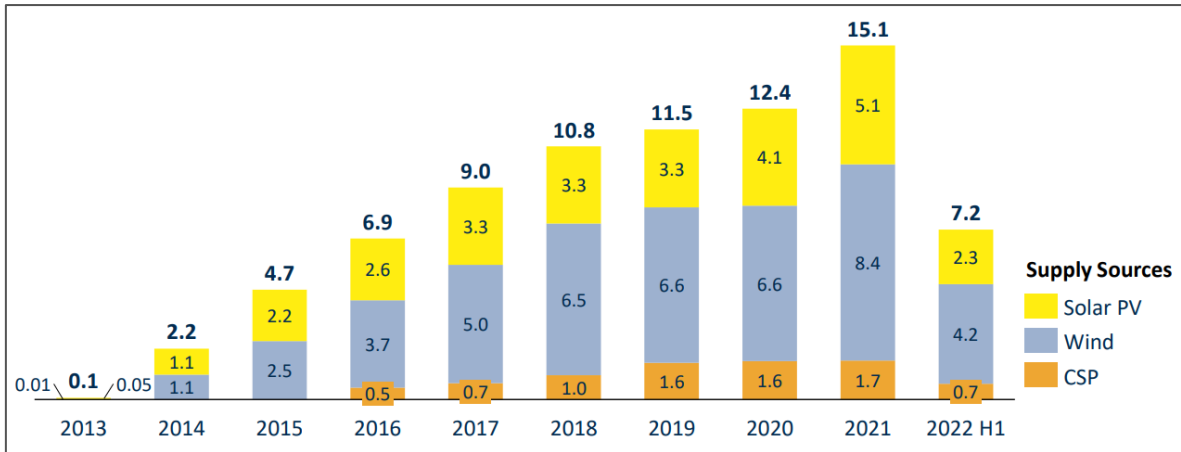

Figure 3-7: Renewable energy production in South Africa (TWh)

Source: (CSIR, 2022)

Loadshedding has significant consequences for economic production, business operation and quality of life. Mathe (2023) considers conservatively that each stage of full-day load-shedding to cost the South African economy about R1 billion, with most severe impacts on small companies and service delivery mainly affecting poor communities, schools, universities, hospitals, clinics, postal offices and police stations. SAWEA (2019) estimates that loadshedding costs the South African economy R90/kWh, and that the operation of diesel-powered Open Cycle Gas Turbines to generate additional emergency power costs ~R3/kWh. CSIR (2020) similarly estimates an economic impact of R45 – R90/kWh, so that loadshedding of 1 352 GWh in 2019 had an impact on the economy of ~R 60 to 120 billion (see Figure 3-5), while loadshedding in 2022 would have cost the economy R480 billion (Mathe, 2023).

The REIPPPP was established at the end of 2010 as one of the South African Government’s urgent interventions to enhance electrical power generation capacity in the country. Administered by the DMRE, the programme seeks to secure electricity from renewable and non-renewable energy sources, via private sector investment, whilst contributing to broader national development objectives (DMRE, 2021). In July 2022 it was announced that the originally anticipated generation capacity to be procured in Bid Window 6 would be doubled to ramp up electricity generation in South Africa (Hall, 2022).

An August 2021 amendment to the Electricity Regulation Act 4 of 2006 exempts embedded electricity generation projects between 1 MW and 100 MW from the previous requirement of applying for a generation licence, requiring them only to register with the National Energy Regulator of South Africa (NERSA). In February 2022 private electricity trading company Enpower Trading was issued a licence that allows it to transport energy from IPPs to private end-users in any location across the municipal and national electricity grid by ‘wheeling’ the energy across the national and municipal grid networks. These developments are expected to further drive availability of and demand for independently produced renewable energy in South Africa and increase in the number of South African IPPs (business essentials, 2022) independently of the REIPPPP.

3.4.1.2 Increasing Renewable Power Generation to Reduce Carbon Emissions from Energy Production

Once operational, PV plants produce electricity that is largely free of CO₂ emissions¹². PV plants are thus considered important in the transition to a low-carbon economy to address climate change, especially where they replace (current or future) electricity that generates high CO₂-e emissions, such as in South Africa where electricity is primarily produced by coal fired power plants.

In 2019, electricity generated by Eskom produced ~212 Mt CO₂-e (EcoMetrix Africa, 2020), ~44% of South Africa’s total emissions from fuel combustion (Our World in Data, n.d.) (see also Figure 3-8). Renewables generated 6.5% of power in South Africa in 2019, including 1.6% from solar facilities. That represents a 158% increase from 2014 to 2019, but is still low, and the level of power generated from coal has hardly decreased at 88% of the power mix (see Figure 3-9) (Climate Transparency, 2020).

The emissions intensity of the South African power sector and the energy intensity of its economy are both nearly double the G2013 average (see Figure 3-10), while at the same time South Africa’s share of renewable energy in power generation (6.5%) is low compared to the G20 average (27%) (Climate Transparency, 2020). In combination this provides for a concerning picture regarding South African GHG emissions, which are high relative to comparative countries. Renewable energy projects were thus identified in South Africa’s IRP as an important component of South Africa’s energy mix going forward (see Section 2.2.1).

By generating renewable energy, the project contributes not only to improving South Africa’s energy security but also to lowering the carbon intensity of South African energy production, by supplementing coal power generation supply from Eskom with solar energy.

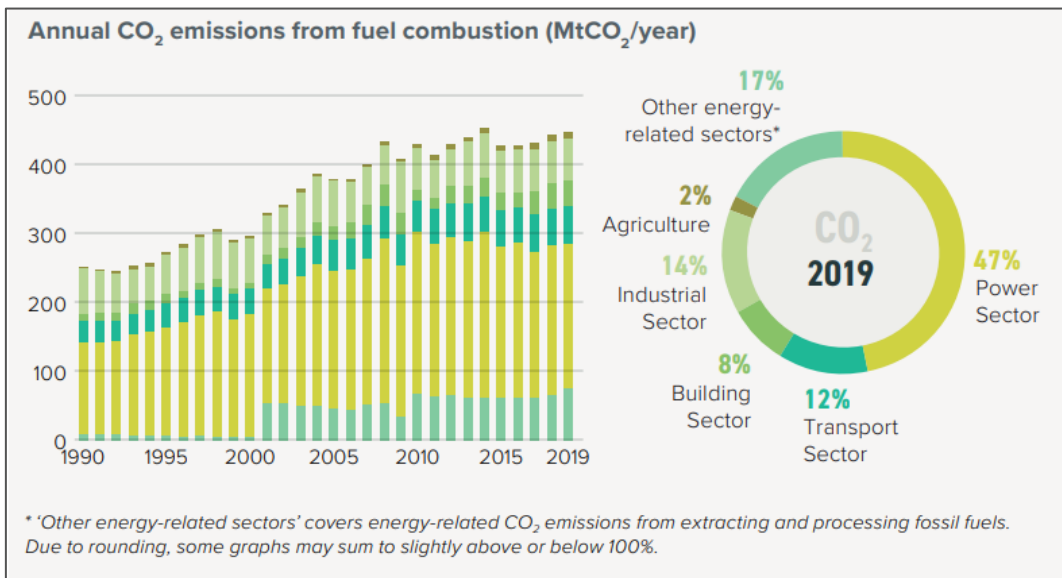

Figure 3-8: Annual CO₂ emissions from fuel combustion in South Africa (million tons / year)

Sources: (Climate Transparency, 2020)

¹² It is noted that the manufacturing, transportation and installation of renewable energy plant components result in CO₂ equivalent (CO₂-e) Greenhouse Gas (GHG) emissions. Volumes depend on the source and recycling content of materials (particularly concrete and steel for WEFs and glass, steel and concrete for PV plants), type of energy used for manufacturing and distance over which materials are transported (IRENA, 2019).

¹³ The G20 comprises Argentina, Australia, Brazil, Canada, China, France, Germany, Japan, India, Indonesia, Italy, Mexico, Russia, South Africa, Saudi Arabia, South Korea, Turkey, the United Kingdom, the United States, and the European Union. Its members account for more than 80% of world GDP, 75% of global trade and 60% of the population of the planet (G20, n.d.).

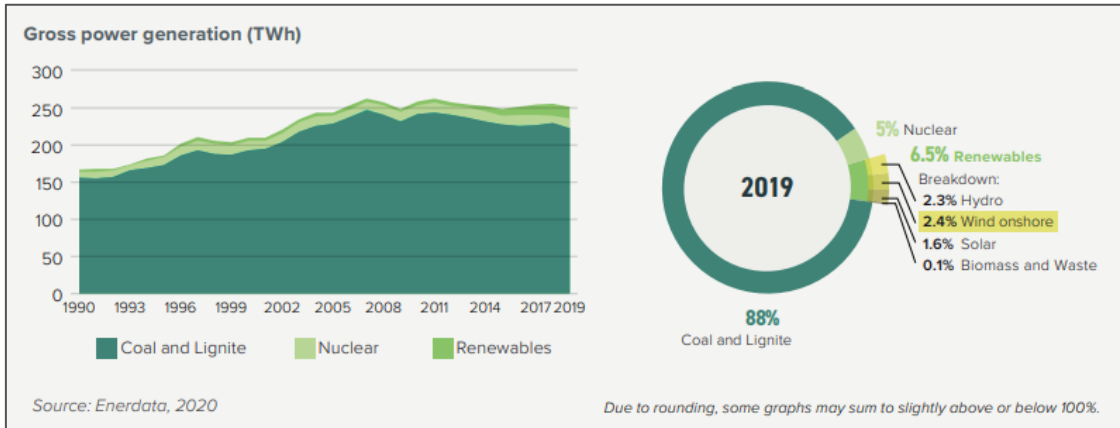

Figure 3-9: Gross power generation by source in South Africa

Sources: (Climate Transparency, 2020)

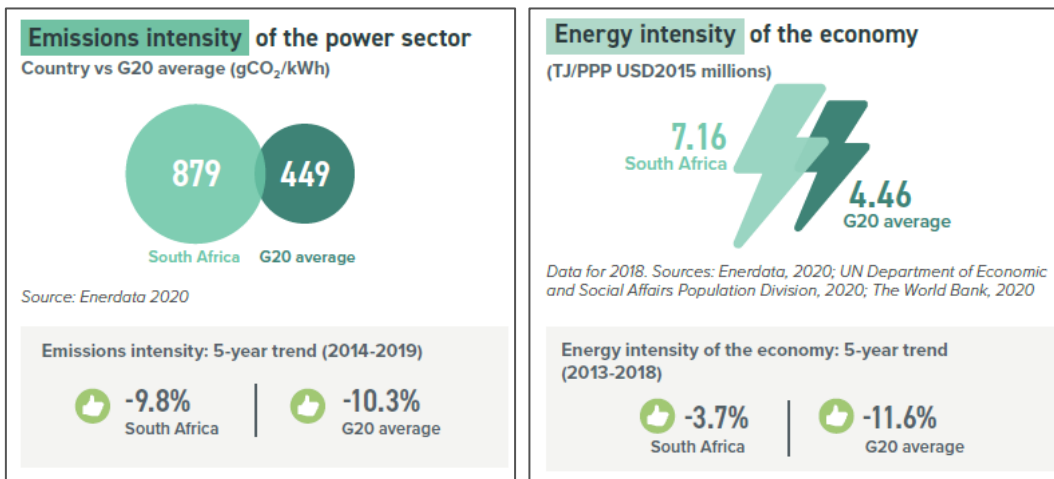

Figure 3-10: Power sector emissions intensity and economy energy intensity in South Africa

Sources: (Climate Transparency, 2020)

3.4.2 Motivation for the Stilfontein Cluster projects

Mainstream intends generating renewable electricity at the proposed Sparrow facility. As noted in 3.4.1.1, reducing the risk of loadshedding through the provision of additional energy represents a benefit to the South African economy. The up to 150 MW PV project is forecast to generate 330 GWh of electricity per year¹⁴. Based on the values estimated by SAWEA (2019), the economic value of reduced load shedding

¹⁴ Anticipated power output was not provided, and depends on various factors, such as the panel technology and solar irradiation. Productions rates vary across PV plants:

- In 2017, total PV installed capacity in South Africa was 2 186 MW, producing 3 095 GWh, or ~1 416 MWh per installed MW (Wikipedia, 2022).
- The 96MW Jasper Solar Power Project, operational in the Northern Cape since 2014, produces 180 GWh per year, or ~1 875 MWh per installed MW (Unwin, 2019).
- The more recent 75MW Kalkbult solar power plant, operational in the Northern Cape since 2019, produces 150 GWh of energy a year, or ~2 000 MWh per installed MW (Unwin, 2019).
- Amazon’s 10 MW solar project in the Northern Cape, using single-axis tracking bifacial solar modules, is expected to supply 28 GWh of renewable energy per year, or 2 800 MWh per installed MW (BusinessTech, 2021a)

associated with the total power produced by the project could amount to R30 billion, or a R990 million saving in diesel used to generate emergency power¹⁵, per annum.

Eskom has cited an immediate power gap of 4 000 to 6 000 MW (Business Day, 2022), of which the project installed capacity represents 2.5% to 3.7% - though it is noted that energy demand and supply are highly complex, and that PV plants are not on-demand facilities that always produce a predictable, dispatchable power output¹⁶ (installation of a BESS would increase the reliability of energy supply from the project).

Eskom expects to retire 10 000 MW of installed thermal power generation capacity by 2030 and needs to add 40 000 to 50 000 MW of new capacity by 2037 to replace retired units and provide for South Africa's growing energy demand (Business Day, 2022) (and see Section 2.2.1). Installing alternative power sources as part of the energy mix will be critical.

The production of renewable power by the project will reduce the carbon intensity of South Africa's energy production.

Mainstream considers the proposed site to be suitable for the development of a PV plant and evacuation to the grid for the following reasons:

- *Resource availability:* The project falls within the Klerksdorp REDZ, which was identified for the deployment of large-scale PV facilities. The annual direct natural (solar) irradiation (DNI) in the project area, at ~2 120 to 2 550 kWh/m²/annum (see Figure 3-11), is above the threshold deemed sufficient for efficient PV power generation.
- *Site extent and sensitivity:* The identified project area is sufficiently large to accommodate a up to 150 MW PV facility while avoiding known environmentally sensitive areas.
- *Topography:* The project area is largely flat and suitable for the installation of PV arrays.
- *Landowner support:* The project area is owned by very few landowners who have concluded an agreement with Mainstream and support the development. Positioning of the proposed PV facility has been undertaken in consultation with the affected landowner.
- *Site access:* The project site can be readily accessed from the N12, which minimises construction of access roads and facilitates the transportation of heavy machinery and project components during construction.
- *Grid access:* The project site is located close to two 400 kV Eskom powerlines (Hermes/Pluto 1 and 2), facilitating easy evacuation of power generated to the Eskom grid. While insufficient grid capacity is an increasing concern, the Carletonville supply area has available transformer and substation transfer capacity at all substations except Mookodi and Pluto (see Figure 3-12) (Eskom, 2021). The local grid can thus accommodate and transmit power generated at the Stilfontein Cluster.

It is evident that efficiency is increasing in solar plants. However, considering the less intense solar irradiation in North West Province, where the Stilfontein Cluster is located, generation capacity of ~2 200 MWh per installed MW is assumed for this project.

¹⁵ 330 000 000 kWh x R90/kWh loadshedding impact = R30 billion; 330 000 000 kWh x R3/kWh diesel cost for power generation = R990 million.

¹⁶ In mid-2022 the average capacity factor for solar PV in South Africa was 24.2, compared to 30.9 for wind and 30.6 for CSP. Wind and solar PV energy excludes curtailment (the reduction of output of a renewable resource below what it could have otherwise produced) and thus capacity factor is lower than actual wind and solar PV available (CSIR, 2022).

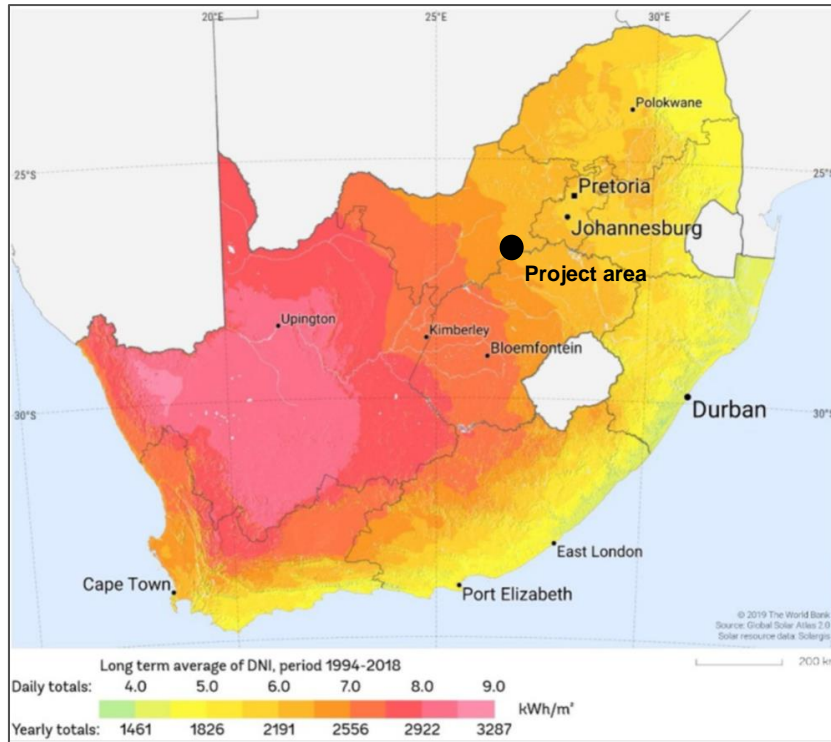

Figure 3-11: Solar resource map for South Africa

Sources: (Akinbami, Oke, & Bodunrin, 2021)

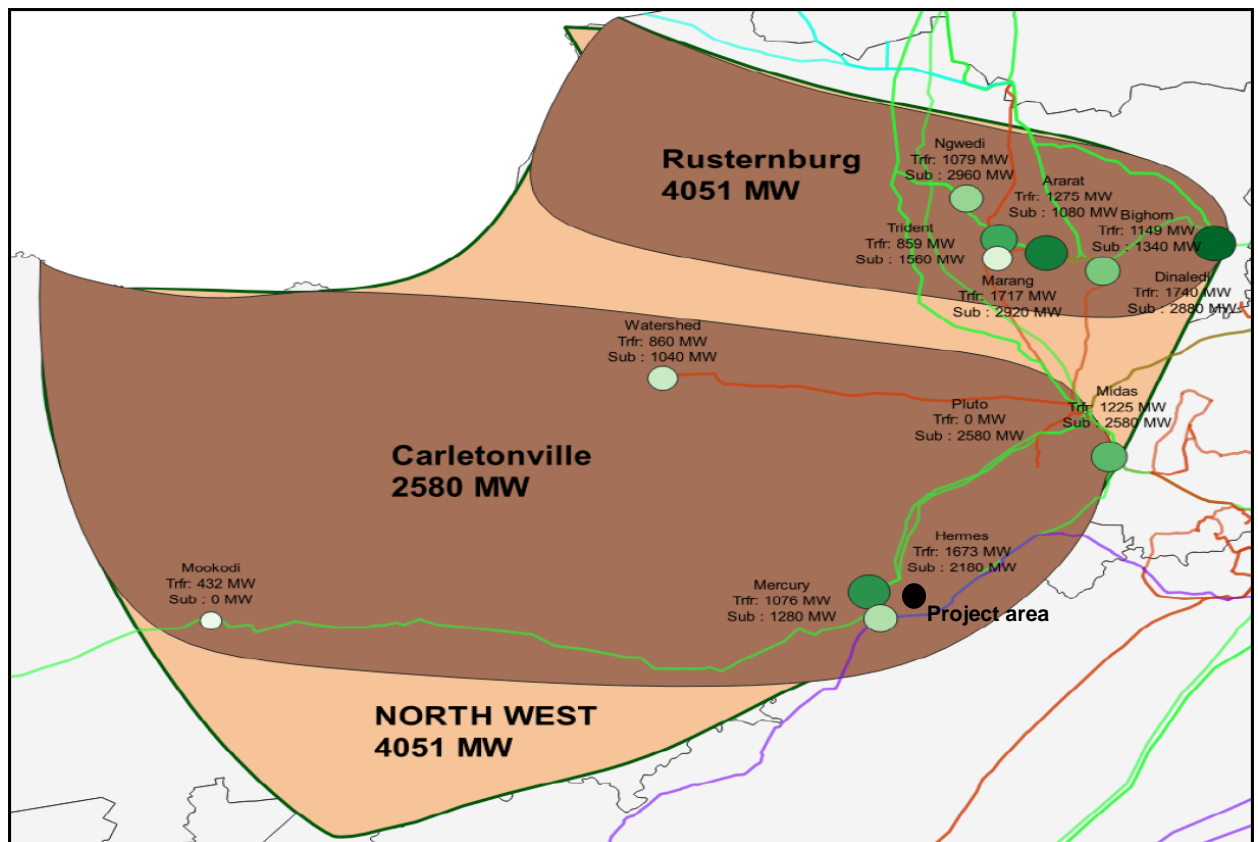

Figure 3-12: North West substation and transformer capacity

Sources: (Eskom, 2021)

3.5 Project Alternatives

Appendix 1 Section 3 (h)(i) of the EIA Regulations, 2014 requires that all BA processes must identify and describe alternatives to the proposed activity that are feasible and reasonable. Different types or categories of alternatives can be identified, e.g. location alternatives, type of activity, design or layout alternatives, technology alternatives and operational alternatives. The “No-Go” or “no development” alternative must also be considered.

Not all categories of alternatives are applicable to this project, as discussed below and summarised in Table 3-1.

Table 3-1: Alternatives considered

Alternative type	Alternatives considered	BAR Section	Assessed in BAR
Location	PV project location	3.5.1.1, <i>Chapter 0 and 7</i>	Yes
	PV project alternative location		No
	Substation technically preferred location	3.6.6, <i>Chapter 0 and 7</i>	Yes
	Substation alternative location		Yes
Layout	Nine substations (one each per PV facility)	3.5.2, <i>Chapter 0 and 7</i>	Yes
	Three substations (serving three PV facilities each)		No
Activity	Activity as described in BA	3, <i>Chapter 0 and 7</i>	Yes
	No-go alternative	3.5.5, <i>Chapter 0 and 7</i>	Yes
Technology <i>Cell technology</i>	Monocrystalline Modules	3.5.4.1, 3.6.3, <i>Chapter 0 and 7</i>	Yes
	Polycrystalline Modules		Yes
	Thin Film Modules		Yes
Panel technology	Monofacial panels	3.5.4.2, 3.6.3, <i>Chapter 0 and 7</i>	Yes
	Bifacial panels		Yes
Mounting technology	Fixed axis	3.5.4.3, <i>Chapter 0 and 7</i>	No
	Single axis tracking		Yes
	Dual axis tracking		No
BESS technology	Solid State Batteries	3.5.4.4, 3.6.4, <i>Chapter 0 and 7</i>	Yes
	Redox Flow Batteries	3.5.4.4	No

3.5.1 Location Alternatives

3.5.1.1 PV Project

Mainstream undertook an internal constraint mapping exercise to identify the most suitable project area for the Sparrow PV facility (and the Stilfontein Cluster), i.e. the location with least environmental and social impact. The following criteria were considered:

- Avoidance of environmentally sensitive areas, e.g. Critical Biodiversity Areas (CBAs), national parks and watercourses;
- Avoidance of socially sensitive areas, e.g. inhabited areas, and cultivated land;
- Location within a REDZ and STC;

- Support of and approval by affected landowners;
- Suitable terrain for the establishment of PV arrays, requiring a minimum of earthworks;
- Sufficient available area to site the cluster of projects;
- Good accessibility from existing roads;
- Proximity of tie-in points to the Eskom grid; and
- Availability of grid (transmission) capacity in the region.

The identified project area satisfies all the above criteria, which makes the identified site ideally suited. The identified project area has been fully allocated to the nine proposed PV facilities and associated infrastructure that comprise the Stilfontein Cluster (see Figure 1-1). As such, no alternative locations or sites are assessed for the Sparrow PV facility.

3.5.2 Layout Alternatives

Mainstream investigated two substation configuration alternatives for the Stilfontein Cluster:

- Construction of nine individual on-site substations, one per PV facility; and
- Construction of three collector substations, each serving up to three PV facilities.

The construction of one on-site substation per PV facility is preferred as it allows for more project-specific siting and sizing of the substation.

As such, only the grid connection layout alternative comprising nine on-site substations is assessed, but alternative substation locations are assessed (see Section 3.6.6).

3.5.3 Activity Alternatives

The proposal is to generate renewable power. The project lies within the Klerksdorp REDZ which was specifically identified for the deployment of large-scale PV facilities. As such, there are no reasonable activity alternatives.

3.5.4 Technology Alternatives

3.5.4.1 Cell Technology

Three cell technology alternatives are considered and described in Section 3.6.3:

- Monocrystalline Modules;
- Polycrystalline Modules; and
- Thin Film Modules.

3.5.4.2 Panel Technology

Two panel technology alternatives are considered and described in Section 3.6.3:

- Monofacial panels; and
- Bifacial panels.

3.5.4.3 Panel Mounting Technology

Mainstream considered various mounting technologies during the pre-feasibility stage:

- *Fixed axis:* A fixed-tilt system positions the panels at a “fixed” tilt and orientation. This reduces the accuracy of solar panel placement and energy output;
- *Single axis tracking:* This system has a single degree of flexibility that serves as an axis of rotation and is usually aligned north-south (see Figure 3-13). It allows the panels to track the daily movement of sun from east to west, but does not correct for seasonal elevation of the sun. This system is cheaper, more reliable and has a longer lifespan than a dual axis system. It can increase energy production by ~25% to 35% compared to fixed axis systems (SolarReviews, 2022), (energysage, n.d.), but energy production is lower than for dual axis systems; and
- *Dual axis tracking:* This system allows for movement along two axes (see Figure 3-13), which offers a wider range of motion and thus increase the accuracy in directional positioning of solar panels. It allows the panels to follow the sun daily from east to west and additionally corrects for seasonal north-south sun movement (elevation of the sun in the sky). The dual axis system thereby allows for ~40% higher energy output than for fixed axis systems (SolarReviews, 2022) (energysage, n.d.). However, the system is mechanically complex and more susceptible to break down, has a lower lifespan and is unreliable during cloudy or overcast weather.

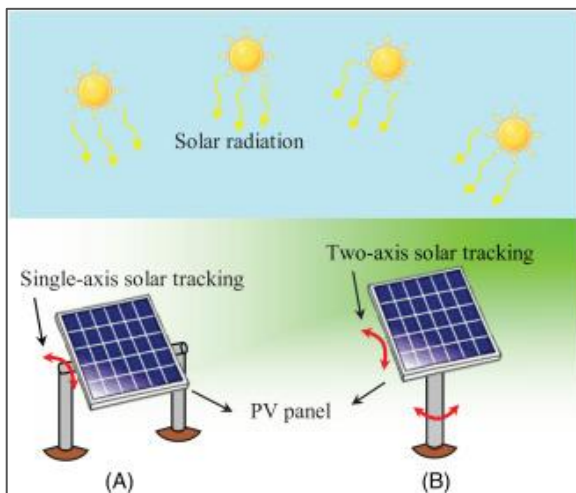

Figure 3-13: Illustration of single and dual (two) axis tracking system

Sources: <https://www.sciencedirect.com/topics/engineering/solar-tracking-system>

Advantages and disadvantages of each mounting technology are summarised in Table 3-2. Based on an analysis of advantages and disadvantages, Mainstream selected single axis tracking which is the only mounting technology alternative considered in the BAR (see Section 3.6.3).

Table 3-2: Advantages and disadvantages of mounting technologies

Technology	Advantages	Disadvantages
Fixed axis	<ul style="list-style-type: none"> ■ High reliability ■ Low maintenance ■ Cheaper installation 	<ul style="list-style-type: none"> ■ Lower energy output
Single axis tracking	<ul style="list-style-type: none"> ■ Higher energy output than fixed axis ■ High reliability 	<ul style="list-style-type: none"> ■ Lower energy output than dual axis

Technology	Advantages	Disadvantages
	<ul style="list-style-type: none"> Low maintenance Cheaper installation than dual axis Longer life span than dual axis 	
Dual axis tracking	<ul style="list-style-type: none"> Higher energy output than single axis 	<ul style="list-style-type: none"> More susceptible to breakdown Lower lifespan than single axis More expensive than single axis Unreliable during cloudy weather

3.5.4.4 BESS Technology

Mainstream considered two battery technology alternatives during the pre-feasibility stage:

- Solid State Batteries** typically consist of a graphite anode, metal-oxide cathode, and an electrolyte gel packaged in a flat pouch or rolled up in a cylindrical shape. Solid-state battery electrolytes typically consist of Lead Acid (Pb), Nickel Cadmium (NiCad), Lithium-Ion (Li-ion), Sodium Sulfur (NaS) or Sodium Nickel Chloride / Zebra (NaNiCl). Sealed thermal management systems within the batteries contain coolants and refrigerants (ethylene glycol and tetrafluoroethane).
- Redox Flow Batteries** contain a battery cell with flowable electrolyte pumped between storage tanks (see Figure 3-14). Electrolyte is pumped through the cell for charging or discharging and is stored in separate tanks for longer duration storage. The electrolyte storage tanks and cells are installed in a specially prepared shipping container (see Figure 3-14). The containers typically have secondary and tertiary containment for the electrolyte fluid (Platte River Power Authority, 2017).

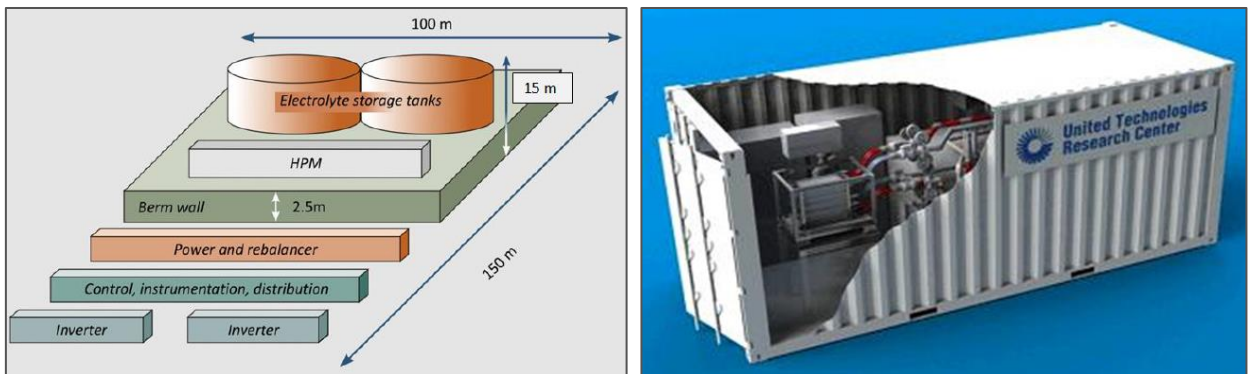

Figure 3-14: Redox Flow battery schematic

Advantages and disadvantages of either technology are summarised in Table 3-3. Based on an analysis of advantages and disadvantages, Mainstream selected the solid state battery technology as the preferred technology, which is the only battery technology alternative considered in the BAR (see Section 3.6.4.2).

Table 3-3: Advantages and disadvantages of battery technologies

Technology	Advantages	Disadvantages
Solid state	<ul style="list-style-type: none"> High efficiency Relatively high energy density 	<ul style="list-style-type: none"> Fire risk due to thermal runaway High cost due to limited abundance in lithium

Technology	Advantages	Disadvantages
	<ul style="list-style-type: none"> ■ Fast response to unpredictable variations in demand and generation ■ Low maintenance ■ Relatively long lifecycle (~10-15 years) ■ Ability to offset grid fluctuations ■ Ease and flexibility of production and sizing ■ Low occurrence of short circuits ■ High stability (as no liquids and volatile substances are used) ■ No risk of spills (as batteries contain no liquids) ■ Currently the most widely used BESS technology ■ Li-ion battery systems arrive fully encased (rather than being installed on site) 	<ul style="list-style-type: none"> ■ Risk of annual degradation ■ Battery protection is required ■ Power and energy capacity directly coupled (expensive to scale)
Redox flow	<ul style="list-style-type: none"> ■ Fast response to unpredictable variations in demand and generation ■ Long life cycle (~20 years) ■ Almost unlimited energy capacity ■ No capacity degradation over time ■ Electrolyte is inherently safe and non-flammable ■ Independently tuneable power rating and energy capacity 	<ul style="list-style-type: none"> ■ Scarce and expensive components ■ Lower efficiency ■ Lower energy density than solid state batteries ■ Storage of electrolyte chemicals in tanks (storage of hazardous goods) requires additional approvals ■ Storage of electrolyte chemicals in tanks increases the risk of spills ■ Larger footprint (unless containers are stacked) ■ Currently not market competitive ■ Battery systems are installed on site (increasing the risk of accidents)

3.5.5 The No-Go Alternative

In addition, the No-Go alternative has been considered in the BAR in accordance with the requirements of the EIA Regulations, 2014 (as amended). The No-Go alternative implies that the project does not go ahead, i.e. that no renewable energy will be generated on the site, and that current activities (notably grazing) will continue, and/or that other activities not requiring authorisation may be pursued.

3.6 Sparrow PV Facility Infrastructure and Construction Activities

The Sparrow PV facility includes the key components listed in Table 3-4, described in the sections below and shown in Figure 3-3, Figure 3-15 *and* Figure 7-3.

In their review of the Draft BAR, DFFE requested that more specific layout information than shown in Figure 3-15 be presented. This detailed site layout is presented in Figure 7-3 of the final BAR. It was fully assessed in the draft BAR and is not regarded as new information. The site layout detail is for the technically preferred on-site substation shown in Figure 3-15 in addition to the other requested components of the facility and associated infrastructure (as described and assessed in the previous version of the BAR and this final BAR) from DFFE.

Table 3-4: Overview of Sparrow PV facility key components ¹⁷

<u>Component</u>	<u>Description / Dimensions</u>	<u>Start/End or Corner point Coordinates</u>	<u>Length/Area</u>
<u>Height of PV panels</u>	<ul style="list-style-type: none"> <u>The PV panels will be up to 5 m high.</u> 	<u>N/A</u>	<u>N/A</u>
<u>Type of PV panels</u>	<ul style="list-style-type: none"> <u>PV arrays with a total maximum export capacity of up to 150 MW.</u> <u>Solar panel arrays with monofacial or bifacial modules.</u> <u>Single axis mounting system.</u> 	<u>N/A</u>	<u>N/A</u>
<u>Area of PV array</u>	<ul style="list-style-type: none"> <u>For the assessment it is conservatively assumed that the footprint of the area within the project boundary fenceline¹⁸ of Sparrow PV facility, minus the footprint of the BESS, on site substation, O&M building and guardhouse is developed with PV array (see Figure 7-3)</u> 	<u>Provided in Figure 3-15.</u>	<ul style="list-style-type: none"> <u>3 139 551m² (313.9Ha)</u>
<u>BESS</u>	<ul style="list-style-type: none"> <u>The lithium iron BESS up to 9.99ha in size (see Figure 7-3).</u> 	<u>26° 47' 48.61470206" S / 26° 53' 09.30688598" E</u> <u>26° 47' 48.60397406" S / 26° 53' 20.75235304" E</u> <u>26° 47' 58.87517453" S / 26° 53' 20.76445050" E</u> <u>26° 47' 58.88590516" S / 26° 53' 09.31870071" E</u>	<ul style="list-style-type: none"> <u>99 936m²</u>
<u>11-33kV transmission lines</u>	<ul style="list-style-type: none"> <u>11-33 kV cabling from the Sparrow PV plant to the Sparrow on-site substation and/or BESS will be underground as far as possible.</u> 	<u>Not available</u>	<u>Not available</u>
<u>Inverters</u>	<ul style="list-style-type: none"> <u>Aspects related to required inverters and transformers, such as number and capacity, will be finalised during detailed design prior to construction, but do not materially affect project layout or project impacts.</u> 	<u>Not available</u>	<u>Not available</u>
<u>Area occupied by on site substation</u>	<ul style="list-style-type: none"> <u>The on-site substation comprises of an IPP-side and Eskom-side (see Figure 7-3). The IPP-side of the on-site substation</u> 	<u>IPP-side on-site substation:</u> <u>26° 47' 38.81859548" S / 26° 53' 06.03668218" E</u> <u>26° 47' 43.69387899" S / 26° 53' 06.09591508" E</u>	<u>IPP-side substation</u> <ul style="list-style-type: none"> <u>15 012m²</u>

¹⁷ Table 3-4 has been amended to comply with the format set out in DFFE's comments on the DBAR.

¹⁸ An internal fence and a project boundary fence will be erected. The internal fence is to separate the access road from the N12 (providing access to all projects) from the projects PV array area and internal access roads. The project boundary fence will separate the individual projects from one another (see Figure 7-3).

<u>Component</u>	<u>Description / Dimensions</u>	<u>Start/End or Corner point Coordinates</u>	<u>Length/Area</u>
	<u>comprises an inverter (step up facility) to convert power from DC to AC and step up the voltage from 11-33 kV to 132 kV.</u>	<u>26° 47' 43.72930413" S / 26° 53' 02.47419045" E</u> <u>26° 47' 38.85401709" S / 26° 53' 02.41500055" E</u> <u>Eskom-side substation:</u> <u>26° 47' 38.85401709" S / 26° 53' 02.41500055" E</u> <u>26° 47' 43.72930413" S / 26° 53' 02.47419045" E</u> <u>26° 47' 43.76470028" S / 26° 52' 58.85246168" E</u> <u>26° 47' 38.88941622" S / 26° 52' 58.79331840" E</u>	<u>Eskom-side substation:</u> • <u>15 012m²</u>
<u>Capacity on-site substation</u>	• <u>The IPP-side of the Sparrow on-site substation will receive incoming power from the Sparrow PV facility at 11-33 kV and step up outgoing (Eskom-side) electricity to the MTS at 132 kV.</u>	<u>N/A</u>	<u>N/A</u>
<u>Area occupied by construction laydown area¹⁹</u>	• <u>Construction camp(s) and / or laydown area(s) will be established as required (see Figure 7-3) during the Construction Phase.</u>	<u>Construction Laydown Area:</u> <u>26° 47' 43.48741470" S / 26° 53' 10.66618350" E</u> <u>26° 47' 43.40851846" S / 26° 53' 16.09837884" E</u> <u>26° 47' 48.28345256" S / 26° 53' 16.18632698" E</u> <u>26° 47' 48.36234952" S / 26° 53' 10.75406716" E</u>	• <u>22 518m²:</u>
<u>Area occupied by buildings</u>	• <u>Building infrastructure includes (see Figure 7-3):</u> <ul style="list-style-type: none"> ○ <u>Guardhouse 1 located at the entrance to substation and Operation and Maintenance (O & M) area;</u> ○ <u>Guardhouse 2 located at the entrance to the main access road (to all projects); and</u> ○ <u>O & M Area.</u> 	<u>Guard house 1</u> <u>26° 47' 43.74700704" S / 26° 53' 00.66332432" E</u> <u>26° 47' 45.37210148" S / 26° 53' 00.68304738" E</u> <u>26° 47' 45.38979476" S / 26° 52' 58.87217757" E</u> <u>26° 47' 43.76470028" S / 26° 52' 58.85246168" E</u> <u>Guard house 2</u> <u>26° 48' 48.18100096" S / 26° 51' 31.89646728" E</u> <u>26° 48' 47.82611906" S / 26° 51' 33.66401539" E</u> <u>26° 48' 49.41207961" S / 26° 51' 34.05953954" E</u> <u>26° 48' 49.76696933" S / 26° 51' 32.29198492" E</u> <u>O & M Area</u> <u>26° 47' 43.69387899" S / 26° 53' 06.09591508" E</u> <u>26° 47' 45.31897653" S / 26° 53' 06.11565602" E</u> <u>26° 47' 45.37210148" S / 26° 53' 00.68304738" E</u> <u>26° 47' 43.74700704" S / 26° 53' 00.66332432" E</u>	<u>Guard house 1:</u> • <u>2 502m²</u> <u>Guard house 2:</u> • <u>2 502m²</u> <u>O & M Area:</u> • <u>7 506m²</u>
<u>Length of internal roads</u>	• <u>The N12 provides convenient and suitable main access to the site.</u> • <u>Internal roads are required along the facility boundary and within the facility to allow access to installations.</u>	<u>N12 main access to the site:</u> <u>26° 48' 51.45337095" S / 26° 51' 33.08084173" E</u> <u>26° 48' 50.70280708" S / 26° 51' 32.82758357" E</u> <u>26° 48' 49.91254554" S / 26° 51' 32.56093037" E</u>	<u>N12 main access to the site:</u> • <u>4456.62m</u>

¹⁹ A permanent laydown area (Operation Phase) is not required and therefore excluded.

<u>Component</u>	<u>Description / Dimensions</u>	<u>Start/End or Corner point Coordinates</u>	<u>Length/Area</u>
	<ul style="list-style-type: none"> <u>Existing service 'farm' roads will be used as far as possible.</u> 	<u>26° 48' 43.98096381" S / 26° 52' 01.91992737" E</u> <u>26° 48' 43.70692058" S / 26° 52' 03.27610934" E</u> <u>26° 48' 06.14040036" S / 26° 51' 57.44468207" E</u> <u>26° 47' 57.54611997" S / 26° 51' 56.11074712" E</u> <u>26° 47' 57.53637631" S / 26° 51' 56.80647413" E</u> <u>26° 47' 56.79080133" S / 26° 52' 49.84662564" E</u> <u>26° 47' 56.77165084" S / 26° 52' 51.20373318" E</u> <u>26° 47' 55.64527454" S / 26° 52' 51.33051545" E</u> <u>26° 47' 43.68943613" S / 26° 52' 52.67618674" E</u> <u>26° 47' 43.69640149" S / 26° 52' 53.25726148" E</u> <u>26° 47' 43.76604291" S / 26° 52' 59.06977323" E</u>	
<u>Width of internal roads</u>	<ul style="list-style-type: none"> <u>Internal access roads between solar arrays will not be wider than 6 m, including drainage ditches.</u> <u>The main access road not exceeding 12 m in width will be constructed from the N12 to the project site.</u> 	N/A	N/A
<u>Height and type of fencing</u>	<ul style="list-style-type: none"> <u>An internal fence as well as a site boundary fence will be installed (see Figure 7-3).</u> <u>Standard fencing (with security features as needed and where required), up to 3m high.</u> 	<u>Internal fence (west) line start, end and corner points:</u> <u>26° 48' 02.99158814" S / 26° 52' 03.33444038" E</u> <u>26° 47' 57.69718268" S / 26° 52' 02.54771629" E</u> <u>26° 47' 57.05379976" S / 26° 52' 51.09005904" E</u> <u>26° 48' 33.47982747" S / 26° 52' 47.29124544" E</u> <u>26° 48' 35.93580458" S / 26° 52' 42.21523892" E</u> <u>26° 48' 42.23511283" S / 26° 52' 09.62336958" E</u> <u>26° 48' 02.99158814" S / 26° 52' 03.33444038" E</u> <u>Internal fence (east) line start, end and corner points:</u> <u>26° 48' 34.15610888" S / 26° 52' 50.28914747" E</u> <u>26° 47' 45.59418879" S / 26° 52' 55.66362726" E</u> <u>26° 47' 45.32546869" S / 26° 53' 06.12025838" E</u> <u>26° 47' 42.79553922" S / 26° 53' 06.10742865" E</u> <u>26° 47' 42.78028686" S / 26° 53' 37.23850915" E</u> <u>26° 47' 54.33217198" S / 26° 53' 38.79460020" E</u> <u>26° 47' 57.15204309" S / 26° 53' 38.79198186" E</u> <u>26° 47' 59.64923770" S / 26° 53' 37.85631397" E</u> <u>26° 48' 07.89038039" S / 26° 53' 24.74225930" E</u> <u>26° 48' 11.75166222" S / 26° 53' 20.70508565" E</u> <u>26° 48' 14.56008653" S / 26° 53' 19.02870866" E</u> <u>26° 48' 18.65715526" S / 26° 53' 17.80101248" E</u> <u>26° 48' 27.77560223" S / 26° 53' 18.01420671" E</u> <u>26° 48' 32.37198318" S / 26° 52' 59.78322919" E</u> <u>26° 48' 34.15610888" S / 26° 52' 50.28914747" E</u>	<u>Internal fence (west) length:</u> <ul style="list-style-type: none"> <u>4 932m</u> <u>Internal fence (east) length:</u> <ul style="list-style-type: none"> <u>5 162m</u>

<u>Component</u>	<u>Description / Dimensions</u>	<u>Start/End or Corner point Coordinates</u>	<u>Length/Area</u>
		<u>Site boundary fence start, end and corner points: See Figure 3-15.</u>	<u>Site boundary fence</u> <ul style="list-style-type: none">• <u>8 397.1m</u>

Associated grid connections, briefly described in Section 3.2.2, are dealt with in separate BA processes.

3.6.1 Project Location

Property details for the Sparrow PV facility are provided in Table 3-5 and Figure 1-2.

Table 3-5: Property details of Sparrow PV facility

Property name, number and portion	SG Code	Coordinates	Property size	Development footprint
Doornplaat 3/410	TOIP00000000041000003	26°52'25.98"E, 26°47'48.70"S	951 ha	330 ha
Flint 1/411	TOIP00000000041100001	26°53'27.69"E, 26°47'29.68"S	149 ha	
<u>Doornplaat RE4/410</u>	<u>TOIP00000000041000004</u>	<u>26°51'32.02"E</u> <u>26°48'4.86"S</u>	<u>679 ha</u>	

No previous applications for renewable energy projects on these properties are registered on DFFE's Database of Approved Renewable Energy Applications.

3.6.2 Project Layout and Mounting Technology

The preliminary layout and design of the Sparrow PV facility are described below. A final layout will be determined during detailed design by an Engineering Procurement Contractor (EPC) once the project has been awarded REIPPPP preferred bidder status or potentially reach agreement with private end-users.

PV arrays will be installed in north-south aligned rows over most of the project footprint (see Figure 3-15). Spacing between PV arrays is up to 12 m where internal roads are required.

PV modules will be mounted on a single axis tracking system (see 3.5.4.3) in accordance with the following specifications:

- Tracking Axis: horizontal;
- Tracking Axis Tilt (tilt of torque tube): assumed tilt is 0°;
- Maximum rotation (tracking) angle of PV modules relative to the mid (horizontal) position on the torque tube: Negative (Counter clockwise - CCW) 60° to positive (clockwise - CW) 60°;
- Resting / stow angle of PV module: assumed 0° (horizontal); and
- Height of PV panels above ground: up to 5 m.

Cables between panels will preferably be placed underground where possible and suspended between panels where necessary. The capacity of internal cabling between inverters and the on-site substation will not exceed 33kV.

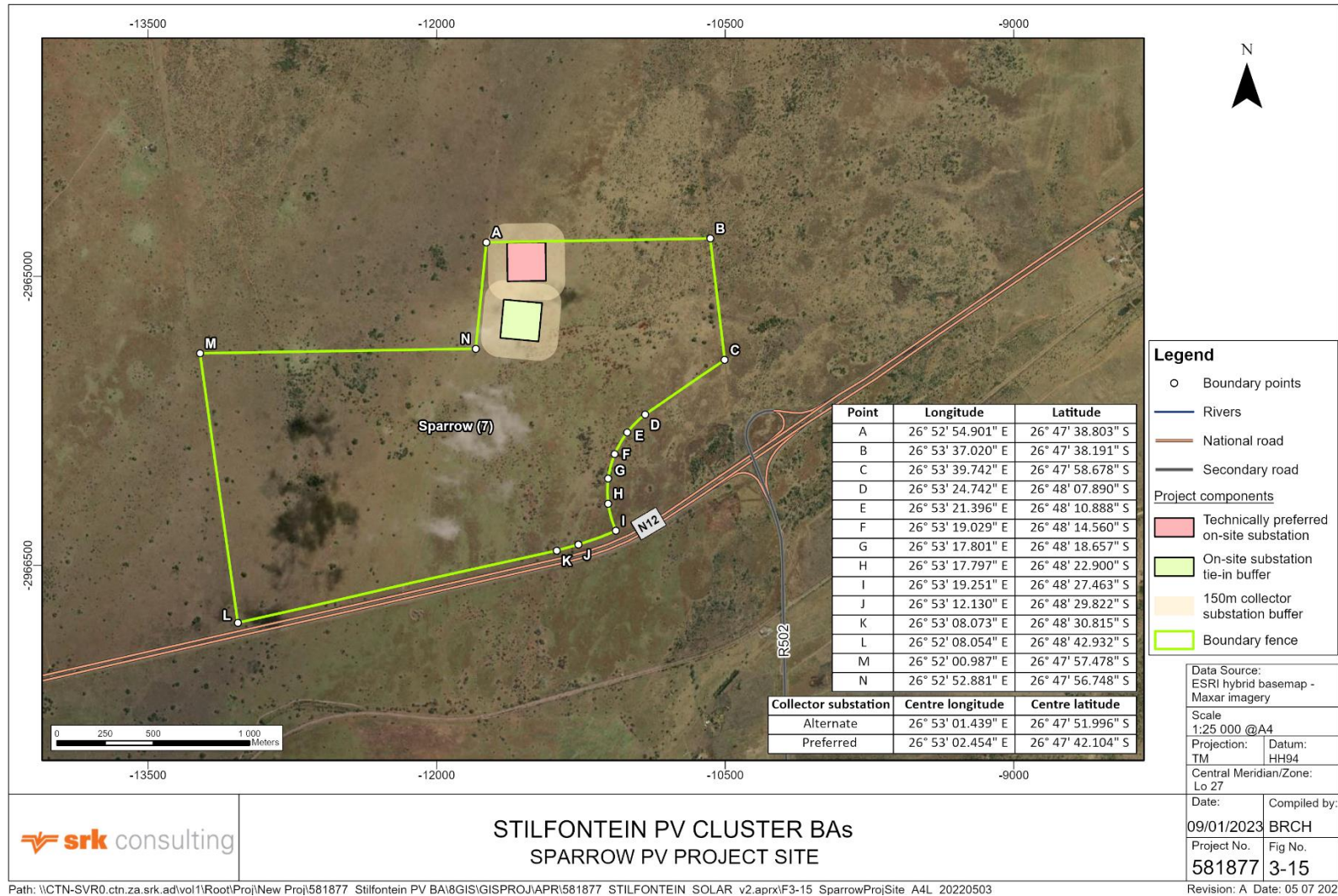

Figure 3-15: Sparrow PV project site²⁰

²⁰ In their review of the Draft BAR, DFFE requested that more specific layout information than described in the Draft BAR be shown on a map. This site layout detail is presented in Figure 7-3.

3.6.3 PV Panels

The Sparrow PV facility will comprise more than 200 000 PV panels mounted in parallel rows, occupying most of the site. Aspects related to required inverters and transformers, such as number and capacity, will be finalised during detailed design prior to construction, but do not materially affect project layout or project impacts.

3.6.3.1 Solar Cell Technology

Three cell technology alternatives *formed part of the impact assessment. The final technology selection however will be considered in the detailed design prior to construction since alternatives assessed do not affect any identified and assessed impacts. Cell technology alternatives are* described below:

- *Monocrystalline modules* are made from pure silicon crystal ingots melted down and drawn out into a solid silicon crystal from which the solar cells are cut. The cells are rigid and mounted on a rigid frame. The modules are covered in glass to protect the cells from damage. Monocrystalline modules are highly efficient (~20% efficiency rating (McFadden, 2021)) but expensive;
- *Polycrystalline modules* are made from silicon that contains impurities. It is melted down and cut into wafers which make up the blocks in a module. The cells are rigid and mounted on a rigid frame. The modules are covered in glass to protect the cells from damage. Polycrystalline modules are cheaper to produce but less efficient than monocrystalline modules (~15% efficiency rating (McFadden, 2021)); and
- *Thin-film modules* are cells manufactured from a chemical ink compound that has similar properties to silicon cells. The ink compound is printed onto a sheet metal to form the base of the module. This sheet is heated to turn it into a semiconductor. A layer of glass is added to cover the cell surface, which allows thin-film modules to match the lifespan of silicon modules. Thin-film modules are cheaper than silicon-based modules, but slightly less efficient.

While more polycrystalline modules are required to generate the same energy output than monocrystalline modules, the choice of cell technology does not materially affect the project layout. For the assessment it is conservatively assumed that the full footprint of the Sparrow PV facility is developed.

3.6.3.2 Solar Panel Technology

Two further panel technology alternatives will also be considered during detailed design, as described below:

- *Monofacial panels* have PV cells on one side (on top) of the solar panel that collect direct sunlight. They do not require reflective surfaces or special mounting equipment.
- *Bifacial panels* have solar cells on both sides of the solar panel (on top and underneath the panel). The cells on top of the panel gather direct sunlight, while the cells on the bottom collect reflected light. For bifacial panels to work best, they need a reflective substrate, greater spacing and special frame and mounting structures. Since both sides of the panel can produce electricity, the efficiency of bifacial panels is somewhat higher (between ~5% and ~35% more efficient than monofacial panels, depending on diffuse light energy, reflectivity of the substrate, tilt and row spacing) (Go Solar, 2021) (Pickerel, 2018).

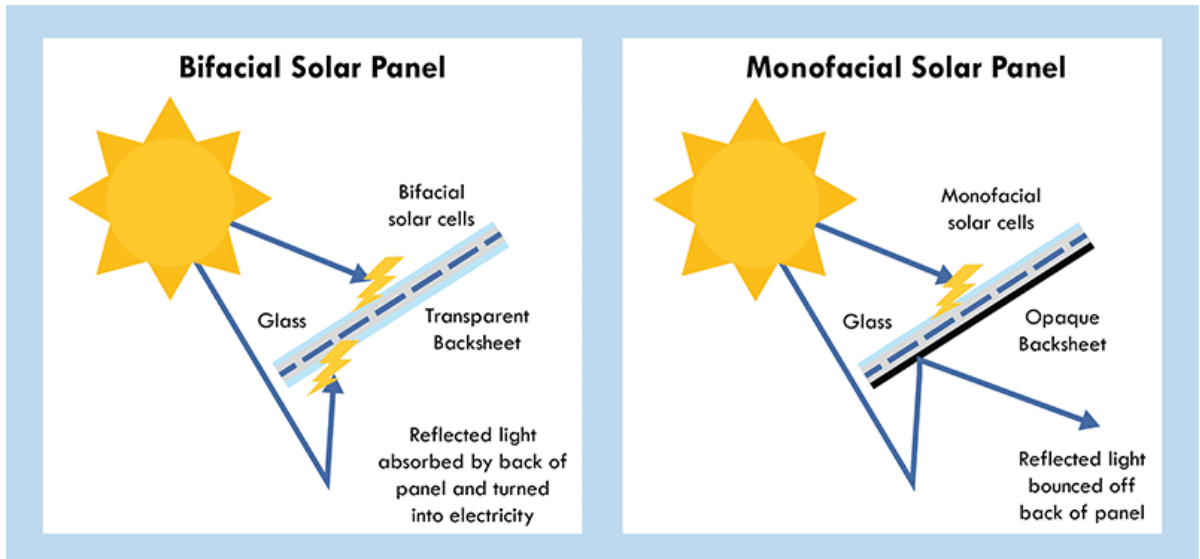

Figure 3-16: Illustration of bifacial versus monofacial solar panels

Sources: (Wolf, 2021)

The choice of panel technology affects project layout as follows:

- A PV facility using monofacial panels requires a bigger footprint to produce the same energy than a facility using bifacial panels; and
- A PV facility using bifacial panels must be placed on a reflective white gravel substrate to improve reflection of sunlight onto the backside of the panel.

For the assessment it is conservatively assumed that the full footprint of the Sparrow PV facility is developed. Both alternatives are assessed in terms of substrate requirements (see Section 3.6.9) *and the potential impacts of both alternatives are considered in all assessments although particularly relevant to the Terrestrial Ecology Impact Assessment (Section 6.4).*

3.6.4 BESS

3.6.4.1 Background

A (simple) battery is a device that can store electrical energy in the form of chemical energy and convert that energy into electricity.

There are three main components of a battery: two terminals made of different chemicals (typically metals), the anode and the cathode; and the electrolyte, which separates these terminals. The electrolyte is a chemical medium that allows the flow of electrical charge between the cathode and anode. When a device (or, the electrical grid) is connected to a battery, chemical reactions occur on the electrodes that create a flow of electrical energy to the device (or the electrical grid).

During a discharge of electricity, the chemical on the anode releases electrons to the negative terminal and ions in the electrolyte through an oxidation reaction. At the positive terminal, the cathode accepts electrons, completing the circuit for the flow of electrons. The function of the electrolyte is to put the different chemicals of the anode and cathode into contact with one another in a way that the chemical potential can equilibrate from one terminal to the other, converting stored chemical energy into useful electrical energy (Bates, 2012).

3.6.4.2 Proposed BESS

A BESS may be constructed for the Sparrow PV facility to store electricity produced during daytime (when the sun is shining) for dispatch during evening peak time when the PV facility does not produce energy. A BESS thus makes energy supply from the Sparrow PV facility more efficient and reliable. The economic feasibility of a BESS will be determined during detailed design.

If installed, the BESS will comprise an assemblage of numerous container-sized battery modules. It will be located adjacent to the substation and/or office building. The proposed location of the BESS is shown in Figure 7-3 and it is noted that if the BESS is not installed, this area will be occupied by additional PV panels.

Solid state Lithium-ion batteries will be used. Solid state battery cells are integrated into battery modules, which are installed in standard racks similar to those used for telecommunication equipment (see Figure 3-17). Typically, the racks are then installed in a specially prepared shipping container to function as an integrated battery system.

Containers will be placed on raised concrete plinths and may be stacked on top of each other to a maximum height of approximately 15 m. Each container has a footprint of ~60 m² and is ~4 m high. Additional equipment, e.g. inverters and temperature control equipment, may be positioned between the battery containers. Sufficient spacing between each container must be ensured to adhere to safety requirements (see Figure 3-17).



Figure 3-17: Solid state battery module (left) and system (right)

Sources: Engadget.com

The chemical composition of the batteries (in the BESS) can be hazardous (typically comprised of a blend of one or more of the hazardous substances listed in SANS 10234), and the batteries will therefore be housed in intermodal containers (or similar) in a bunded area.

The Li-ion battery systems will arrive fully encased (and are thus not assembled on site) and have a number of design features that mitigate key risks of solid state batteries:

- Design features that mitigate the risk of fire or structural damage of batteries due to external temperature variations include the following:
 - Insulated containers;
 - Centrally monitored Heating, Ventilation and Air-Conditioning system;
 - Multiple sensors to measure temperature of battery cells and air;
 - Automated shut down mechanism if temperature gets too high;
 - Dousing and sealing mechanism for fire suppression and containment; and
 - Battery management system to prevent overuse and maintain good battery condition; and

- Design features that mitigate the risk of fire due to volatility of the battery system and battery chemicals include the following:
 - Fire detection and suppressant system;
 - Gas level monitoring;
 - Heat sensors;
 - Battery condition monitoring;
 - Dousing mechanism for emergency cooling and fire suppression;
 - Density limits in containers; and
 - Spacing requirements between containers.

3.6.5 Internal Powerlines

An 11-33 kV powerline(s) will be installed underground and/or overhead on support structures (pylons / monopoles) between the Sparrow PV facility and the Sparrow on-site substation.

Final powerline design, including the number of support structures and their type, height and precise location (micro-siting), will be completed during detailed design based on environmental, geotechnical and civil engineering considerations.

3.6.6 IPP-Side On-Site Substation

3.6.6.1 Background

A substation is a part of an electrical generation, transmission and distribution system. Substations transform voltage from low to high, or the reverse, or perform any of several other important functions. Between the generating station and consumer, electric power may flow through several substations to deliver electricity at the required voltage. A substation typically include transformers to change voltage levels from low distribution voltages to high transmission voltages and, and/or is constructed at the interconnection of two different transmission voltages.

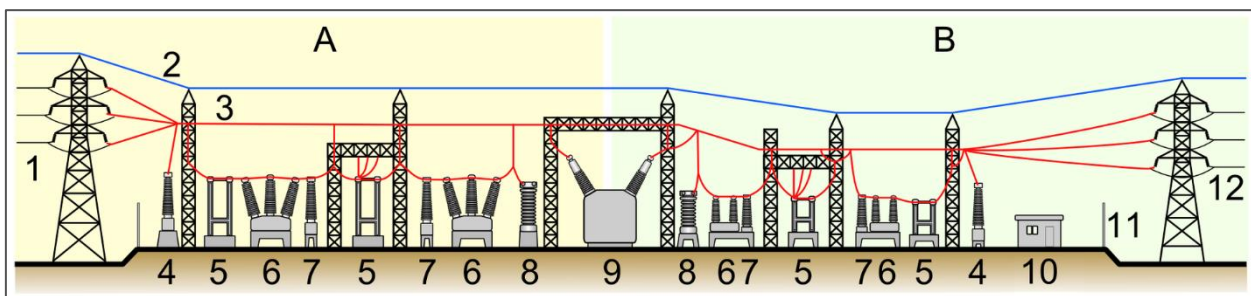

Figure 3-18: Schematic of a substation

Sources: By Shigeru23 - Own work, CC BY-SA 3.0, <https://commons.wikimedia.org/w/index.php?curid=14896493>

Notes: Elements of a substation include 1. Primary power lines, 2. Ground wire, 3. Overhead lines, 4. Transformer for measurement of electric voltage, 5. Disconnect switch, 6. Circuit breaker, 7. Current transformer, 8. Lightning arrester, 9. Main transformer, 10. Control building, 11. Security fence, 12. Secondary power lines

In projects with spatially dispersed generation sources, such as a windfarm or PV facility, an interim on-site substation may be required. The substation steps up voltage to a transmission voltage for the grid (or, in this case, the MTS) (Wikipedia, 2021b).

3.6.6.2 Proposed On-Site Substation

The IPP-side of the Sparrow on-site substation will receive incoming power from the Sparrow PV facility at 11-33 kV and step up outgoing (Eskom-side) electricity to the MTS at 132 kV. The IPP-side of the on-site substation will be owned and operated by the IPP and is therefore included in the Sparrow PV facility application.

The IPP-side of the Sparrow on-site substation comprises an inverter (step up facility) to convert power from DC to AC and step up the voltage from 11-33 kV to 132 kV.

The area of the IPP-side on-site substation is included in Table 3-4.

Two alternative locations are assessed. The technically preferred alternative is shown in red in Figure 1-2, Figure 3-15 and Figure 7-1.

3.6.7 Access Roads

Project components and construction equipment, such as excavators, trucks, graders, compaction equipment etc., will be transported to site by truck. Some heavy equipment will likely be defined as abnormal loads in terms of the Road Traffic Act 29 of 1989.

The Sparrow PV facility will make use of existing access roads wherever possible. The N12 provides convenient and suitable access to the site.

The proposed location of the main access road from the N12 to the project site is shown in the site layout plan in Figure 7-3 and the length and width of the proposed main access to the project site and internal access roads within the project site is described in Table 3-4 and below.

Internal roads are required along the facility boundary and within the facility to allow access to installations. Existing service 'farm' roads will be used as far as possible. Where new access roads are required, access roads not exceeding 12 m in width will be constructed to the project site. Internal access roads between solar arrays will not be wider than 6 m, including drainage ditches.

Vegetation will be cleared, the road will be graded and a suitable road surface material (e.g. gravel) will be used. The thickness and type of the road surface material will be dictated by *in situ* testing to assess if the material is suitable for compaction, or whether additional structural layers are required. Road surface material will be sourced from commercial sources. Typically, internal roads are built with a minimum of 400 mm depth of sub-grade preparation and an aggregate base layer of up to 150 mm thick (KMA, 2016).

3.6.8 Laydown Area and Ancillary Facilities

Construction camp(s) and laydown area(s) will be established as required in the project area (see Figure 7-3 and Table 3-4). The laydown will be used for the storage of project components, building materials and equipment. If necessary, a temporary concrete batching plant will be installed to produce concrete for foundations and/or platforms. Other options include mobile batching plants that allow *in situ* batching of concrete. Aggregate, cement and sand will be imported to the site from commercial sources.

A permanent laydown area (Operation Phase) is not required.

Support structures and infrastructure that will be installed during construction to support the operation of the Sparrow PV facility include offices, operational control centre, operation and maintenance area / warehouse / workshop and ablution facilities, most of which will be located near the Sparrow substation.

Fuel (petrol and diesel) will be trucked to site by the Contractor and temporarily stored on site during the construction phase, in tanks and bowsers in bunded areas. The fuel tanks and bowsers will be removed from the site upon completion of the construction phase.

A standard fence (with security features as needed and where required), up to 3m high, will be erected around the perimeter of the Sparrow PV facility. A guard house will be constructed to control site access. Telecommunication facilities will be installed to ensure connectivity on site.

3.6.9 Ground Preparation and Installation

In preparation for construction, vegetation will be cleared for:

- PV array foundations;
- BESS platform;
- Transmission line support structure (pylons / monopoles) foundations and/or underground cabling;
- IPP-side substation foundations;
- Access roads;
- Laydown area; and
- Building and support infrastructure footprints.

Stripped topsoil will be stockpiled, used as fill material to level certain features, removed from site and/or spread across the site.

Vegetation in and near the transmission line servitude and substation will be trimmed, and shrubs and trees will be removed to ensure sufficient overhead clearance between vegetation and the transmission line. The preparation of the substrate beneath solar arrays depends on the panel technology alternatives that is implemented (both are assessed in detail in the Terrestrial Ecology Impact Assessment):

- Panel Technology One (monofacial panels): Retain (grass) ground cover - shrubs and trees will be removed; and
- Panel Technology 2 (bifacial panels): Remove vegetation and place white gravel underneath panels.

Other notable site preparation activities include the following:

- Support poles will be installed on which to mount PV arrays. Depending on the geotechnical conditions, screw pile, helical pile, micro-pile or drilled post/pile methods may be used. Structures (tables) on which PV modules are mounted will be attached (bracketed) to the support poles.
- Trenches will be dug for underground cabling. Foundations for the inverters and transformers will be prepared.
- Support structure (pylon) foundations for overhead transmission lines will be excavated and constructed. Structures will be assembled and erected on site, followed by the stringing of cables.
- For the substation, trenching and ground grid conduit installation will be followed by casting of concrete foundations. Thereafter, substation equipment will be assembled and installed. Gravel will be placed around the substation area, and a fence erected.
- For the BESS, a foundation will be constructed, on which assembled battery units will be placed and connected to the project infrastructure.

3.6.10 Stormwater Management

Stormwater measures will be implemented on site to divert stormwater away from potentially contaminated areas such as fuel storage, waste storage and BESS containers, and divert accidental leaks / spillages away from the natural environment.

Measures will be implemented to ensure that stormwater originating from upgradient (stormwater that could flow across the site from external areas) is diverted around potentially contaminating areas. Also, clearly

visible signage indicating emergency numbers if stormwater (or any other environmental) issues are identified, will be erected.

3.6.11 Water Use and Supply

Water will be required during construction for:

- Domestic use (ablutions, drinking): ~225 m³ / month or ~2 700 m³ / annum;
- Civil works (compaction of fill material, cement batching etc): ~400 m³ in total during construction; and
- Dust suppression on roads: ~15 l / m², as and when needed depending on conditions.

Water will be sourced from authorised service providers and/or existing boreholes and/or abstracted from surface water sources, which will be determined during detailed design. Temporary water pipelines will be installed during construction to supply the construction camp and ancillary facilities²¹.

Measures to reduce water use and prevent water pollution will be implemented and specified in the EMPr.

3.6.12 Waste and Wastewater Management

The waste hierarchy and waste management procedures will be implemented during operation to prevent, minimise or recycle waste (where possible).

Solid waste produced during the construction phase will be:

- Packaging material for the PV panels, notably:
 - Cardboard – a 150 MW PV project is estimated to generate 375 t of cardboard waste, which may be compressed in a compactor to facilitate storage and transport off site;
 - Rubber caps placed on PV panels to provide protection during transport;
 - Wooden pallets on which PV panels are shipped;
 - Plastic wrap;
- Typical construction rubble (rock, sand, soil and concrete);
- General waste; and
- Contaminated waste such as dirty / used oil and grease and contaminated materials and soil.

Waste management during construction will be the responsibility of the contractor.

All construction waste will be removed from work areas and disposed of at licensed (municipal) waste disposal facilities. Where possible, options to reuse or recycle waste materials will be favoured over disposal. Hazardous waste will be disposed of at a licensed hazardous waste disposal facility and waste disposal manifests will be available to the competent authority upon request.

The volume of waste that will be generated cannot be estimated at this stage but is not expected to be significant nor compromise local waste management handling and disposal. At this stage it is proposed to temporarily store less than 100 m³ general and less than 80 m³ hazardous waste on site at any one moment²².

²¹ A Water Use Authorisation, if required, will be pursued once the project has been awarded preferential bidder status and final design is underway.

²² Deviations from this may require the need to obtain approval in terms of the National Environmental Waste Act 59 of 2008 (NEM:WA).

Wastewater produced during the construction phase comprises contaminated runoff, wash water and domestic wastewater. Wastewater will be captured in either septic or conservancy tanks and disposed of at a suitable facility.

3.6.13 Workforce

Construction of a 150 MW PV facility generates ~ 220 jobs over the construction period. Of these, ~100 jobs are skilled and ~120 jobs are unskilled.

Construction will primarily be undertaken by contractors. Local contractors will be appointed where possible.

No labourers will be accommodated onsite.

The DMRE typically sets out specific economic development targets or focus areas in its REIPPPP Bid Window Request for Proposal, which are either compulsory and/or influence the functionality score of a project bid. These differ over time, and requirements that may be applicable to the [Subject] PV facility are not yet known. Relevant focus areas and targets stipulated in Bid Window 5 (April – August 2021) included the following (DMRE, 2021):

- Job creation - emphasises jobs for South African citizens, black people (including black women and black youth) and citizens from local communities;
- Management Control - focuses on the involvement of black people (in particular black women) in Board Directorship, executive management and senior management roles of the Project Company;
- Skill Development - focuses on the contributions made by the Project Company to improve the skills of employees, learners at higher education institutions and disabled persons;
- Enterprise and Supplier Development - focuses on the development of emerging enterprises, including emerging enterprises located in local communities, and on procuring from black enterprises and enterprises owned by black women.

As of mid-2021 IPPs can also sell independently-generated electricity to private end-users; such agreements are not subject to the REIPPPP requirements. This application is however primarily aimed at REIPPPP requirements however, although the potential for private offtake may be considered.

3.6.14 Capital Expenditure

Anticipated capital expenditure (CapEx) for the Sparrow PV facility is R1.1 billion. Installation of a BESS would further increase CapEx, depending on the capacity of the storage system and timing of installation²³.

Approximately 45% of PV CapEx and 15% of BESS CapEx will be expended in South Africa. The proportion of CapEx that will be spent in local areas will be determined at detailed design stage.

The DMRE typically sets out specific economic development targets or focus areas in its REIPPPP Bid Window Request for Proposal, which are either compulsory and/or influence the functionality score of a project bid. These differ over time, and requirements that may be applicable to the [Subject] PV facility are not yet known. Relevant focus areas and targets stipulated in Bid Window 5 (April – August 2021) included the following (DMRE, 2021):

- Local content - requires compliance with local content designations under South African procurement law, and that a certain percentage of the total value of the Project be spent on South African goods and services. Bid Window 5 required at least 40% of local content during construction, in addition to the use

²³ Battery cost for 4-hour lithium-ion system was USD350 / kWh in 2020. By 2030 costs are expected to reduce by 58%, 42% and 28% in the low, mid and high scenarios, respectively (Cole, Frazier, & Augustine, 2021).

of designated components as determined by the Department of Trade, Industry and Competition. For the first time, local content commitments were also required during operation (Mantashe, 2021); and

- Enterprise and Supplier Development - which focuses on the development of emerging enterprises, including emerging enterprises located in local communities; and on procuring from black enterprises and enterprises owned by black women.

As of mid-2021 IPPs can also sell independently-generated electricity to private end-users; such agreements are not subject to the REIPPPP requirements. This application is however primarily aimed at REIPPPP requirements however, although the potential for private offtake may be considered.

3.6.15 Community and Social Investment

The DMRE typically sets out specific economic development targets or focus areas in its REIPPPP Bid Window Request for Proposal, which are either compulsory and/or influence the functionality score of a project bid. These differ over time, and requirements that may be applicable to the [Subject] PV facility are not yet known. Relevant focus areas and targets stipulated in Bid Window 5 (April – August 2021) included the following (DMRE, 2021):

- Ownership - requires minimum 49% ownership by South African entities and 2.5% ownership by local communities in the Project Company, and 30% ownership by black people including, for the first time, 5% ownership by black women in the Project Company and in the contractors responsible for construction and operations (Mantashe, 2021);
- Enterprise and Supplier Development - focuses on the development of emerging enterprises, including emerging enterprises located in local communities, and on procuring from black enterprises and enterprises owned by black women;
- Socio-economic development - which aims to address socio-economic needs including those of local communities²⁴.

As of mid-2021 IPPs can also sell independently-generated electricity to private end-users; such agreements are not subject to the REIPPPP requirements. This application is however primarily aimed at REIPPPP requirements however, although the potential for private offtake may be considered.

3.6.16 Construction Timelines

The project requires EA from DFFE, preferred bidder status awarded by the DMRE and/or another Power Purchasing Agreement (PPA) entered into and a generation licence issued by the NERSA.

Preferred Bidders typically have a limited period (7 months in REIPPPP Bid Window 6) to negotiate and finalise all other contractual arrangements and project documents and reach Commercial Close. Projects must be capable of achieving the Commercial Operation Date within 24 months of Commercial Close. This includes the project's construction and commissioning timetable, as well as the time for grid connection as estimated by the Grid Provider (DMRE, 2021).

The anticipated duration of the construction phase for the Sparrow PV facility is 18 – 24 Months.

The majority of the construction activities are expected to occur during normal working hours (07h00 - 18h00). Construction activities will largely be limited to Mondays to Saturdays. Construction activities will only be allowed on Sundays where unavoidable, and if the contractor is able to provide the engineer with adequate motivation.

²⁴ The 25 Preferred Bidders of Bid Window 5 committed a total of R 2.7 billion towards Socio-Economic Development and Enterprise and skills development initiatives over the 20-year lifetime of the projects.

3.7 Sparrow PV Facility Operation and Maintenance Activities

Following the completion of the construction phase, the Sparrow PV facility, IPP-side of the Sparrow substation and BESS will be commissioned into operation.

3.7.1 Energy Generation and Transmission

The Sparrow PV facility will generate power from sunlight (see Section 3.1). The electricity generated will feed directly into the national grid (via the Sparrow substation and MTS); some may be stored on site in the BESS and despatched to the grid on demand.

3.7.2 Maintenance

The accumulation of dust on the panels affects the productivity of the proposed PV facility (see Section 3.1), and panels thus require regular cleaning. Up to four panel cleaning cycles per annum are currently envisaged; however, the cleaning regime will be revised based on site conditions. Panels will be washed with clean water, i.e. no chemicals will be used.

Livestock will be generally kept away from PV areas, but grazing under panels can be considered where appropriate, in part to reduce the impact associated with the loss of grazing land.

Maintenance of the IPP-side Sparrow substation, powerlines and BESS requires periodic, planned inspection and, if necessary, repair and replacement of equipment and structures. Maintenance typically includes visual and physical inspections and monitoring of data collected by on-site meters and sensors.

Internal roads and other infrastructure will be maintained as and when required. Vegetation will be trimmed and cleared to maintain access and meet legal overhead clearance requirements.

Periodic and emergency repairs may be required. Replacement components will be delivered to site by truck and installed with appropriate equipment (e.g. mobile cranes).

3.7.3 Stormwater Management

Stormwater measures will be implemented on site to divert stormwater away from potentially contaminated areas such as BESS containers, and divert accidental leaks / spillages away from the natural environment.

Measures will be implemented to ensure that stormwater originating from upgradient (stormwater that could flow across the site from external areas) is diverted around potentially contaminating areas. Also, clearly visible signage indicating emergency numbers if stormwater (or any other environmental) issues are identified, will be erected.

3.7.4 Water Use and Supply

Water will be required on site during operation for:

- PV panel cleaning: up to ~18 000 m³ / annum; and
- Domestic use (ablutions, drinking): ~20 m³ / month or 240 m³ / annum.

No additional water is required for the BESS and substation during operations.

Water will be sourced from authorised service providers and/or existing boreholes and/or abstracted from surface water sources.

3.7.5 Waste Management

The waste hierarchy and waste management procedures will be implemented during operation to prevent, minimise or recycle waste (where possible).

Solid waste produced during the operation phase will include small volumes of domestic waste, packaging from replacement equipment, discarded components and vegetation cuttings. The volume of waste that will be generated cannot be estimated at this stage, but is not expected to be significant or place strain on local waste management and disposal facilities.

No waste will be generated during normal operations of the BESS. However, battery cells may need to be replaced. The supplier will be responsible for removing the battery cells from site during the guarantee period and ensuring that battery cells are properly disposed of in accordance with legal requirements.

Waste management during operation will be the responsibility of the PV facility operator. All waste generated during maintenance and operation activities will be disposed of at appropriate licensed waste disposal facilities.

Wastewater produced during the operation phase comprises contaminated runoff, panel wash water and domestic wastewater. Wastewater will be stored in septic tanks and/or conservancy tanks and disposed of at a suitable facility. Wastewater may also be treated in a mobile wastewater treatment unit (e.g. Clarus Fusion) designed to ensure effluent quality meets or exceeds DWS standards (see Figure 3-19). Treated water can then be used for irrigation.

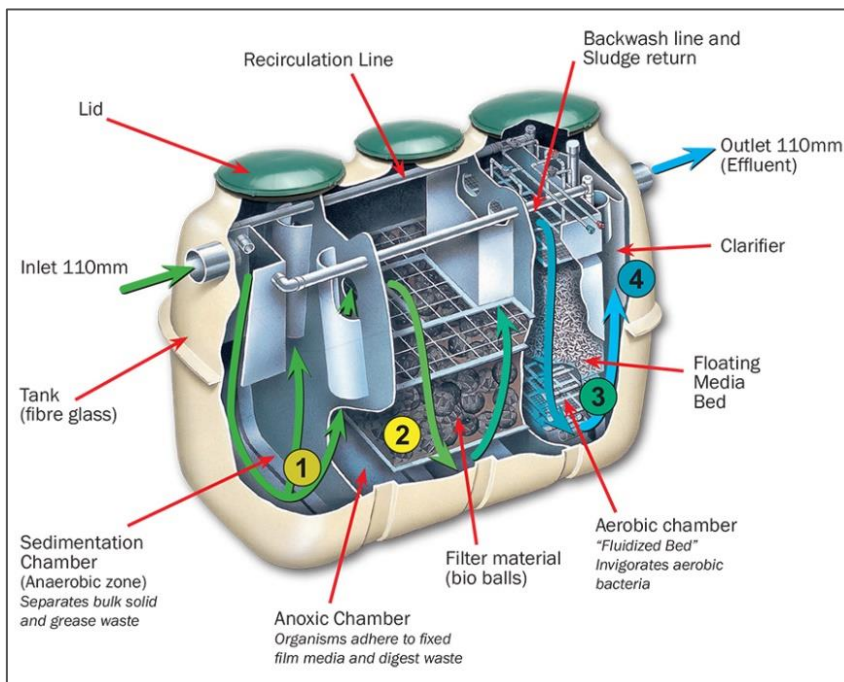

Figure 3-19: Schematic of a wastewater treatment unit

Sources: (Maskam Water, n.d.)

3.7.6 Workforce

The operation of a 150 MW PV facility will create ~20 permanent jobs over the 20-year life span of the facility. Of these, approximately half the jobs are skilled and half are unskilled.

Most employees are anticipated to reside in the Local and District Municipalities. No labourers will be accommodated onsite.

The DMRE economic development targets described in Section 3.6.13 would also apply during the operation phase.

3.7.7 Operational Expenditure

Anticipated operation expenditure (OpEx) for the Sparrow PV facility is R600 million over the 20-year lifetime of the facility, or R32 million per year (at 2022 prices). Operation of a BESS would further increase OpEx.

The proportion of local procurement and expenditure has not yet determined, but DMRE economic development targets described in Section 3.6.14 would also apply during the operation phase.

3.7.8 Community and Corporate Social Investment

Approximately 1% of revenue will be spent in local communities and /or through targeted Corporate Social Investment (CSI) during operations. The DMRE economic development targets described in Section 3.6.15 would also apply during the operation phase.

3.7.9 Project Lifetime

The anticipated lifetime of the Sparrow PV facility is 20 years minimum, with the potential option to upgrade technology to extend the lifetime of the project.

3.8 Decommissioning

Should the operational lifespan of the project not be extended, the project will be decommissioned.

Decommissioning involves:

- Salvaging and/or removing PV panels;
- Demolishing, salvaging and/or removing ancillary infrastructure;
- Excavating, salvaging and/or removing cables;
- Removing concrete foundations, to a depth deemed appropriate by a qualified specialist;
- Ripping compacted sections of the site; and
- Rehabilitating, i.e. profiling and revegetating the site.

Decommissioning activities will comply with the legislation applicable at the time. It is expected that the project area will revert to its current land-use (grazing) once the PV facility has been decommissioned.

In agreement with the landowner, some project components may be left in place if useful to the landowner. Any other components will be removed from the site and either re-sold, recycled or disposed of at a suitable licensed disposal facility.

REIPPPP bidders must make financial provision for decommissioning of their facility, rehabilitation and closure of the project site and the post-closure monitoring of environmental impacts in respect of the facility upon the termination of the PPA, whatever the cause of the termination. Decommissioning funds may be built up over time during operation (DMRE, 2021).

4 Description of the Affected Environment

This chapter presents an overview of the biophysical and socio-economic environment in which the proposed project is located to:

- Understand the general sensitivity of and pressures on the affected environment;
- Inform the identification of potential issues and impacts associated with the proposed project; and
- Start conceptualising practical mitigation measures.

The components of the baseline provided in Sections 4.1 to 4.5 have been generated based on those provided by specialists appointed to undertake baseline and impact assessments for the proposed project. The specialist baseline and impact studies undertaken for the BA process are listed in Table 4-1.

Table 4-1: Specialist baseline studies undertaken for the BA

Specialist Study	Specialists	Organisation
Freshwater	Andrew Husted Martinus Erasmus	The Biodiversity Company
Terrestrial Biodiversity	Andrew Husted Martinus Erasmus	The Biodiversity Company
Avifauna	Chris van Rooyen <i>Albert Froneman</i>	Chris van Rooyen Consulting
Soil and Land Capability	Andrew Husted Martinus Erasmus	The Biodiversity Company
Socio-Economic	Sue Reuther	SRK
Archaeology, Palaeontology and Heritage	Jaco van der Walt Prof. Marion Bamford	Beyond Heritage
Visual	Kelly Armstrong	SRK

Specialist studies are attached as Appendix D.1 to Appendix D.7 and provide additional detail.

4.1 Biophysical Environment

4.1.1 Geology and Topography

Geologically the project area lies in the southwestern part of the Transvaal Basin where rocks of the Transvaal Supergroup, more specifically dolomites and limestones of the Malmani Subgroup (Vmd), are exposed. The Malmani Subgroup is subdivided into five formations, with the top of the Chuniespoort Group forming the Penge Formation and the Duitschland Formation. The Chuniespoort Group was formed by the first of three major cycles of basin infill and tectonic activity. The second cycle deposited the lower Pretoria Group, and the sediments in the project area derive from the interim lowstand that preceded the third cycle. These sediments were deposited in shallow lacustrine, alluvial fan and braided stream environments. Outcrops of quartzite 'koppies' are evident across the site, along with areas of exposed dolomite (see Figure 4-1) (Beyond Heritage, 2022). Dolomite gradually dissolves in water, which gives rise to cave systems and voids in the rock, creating potential for sinkholes and subsidence. The Council for Geoscience confirmed that no sinkholes have formed within the project area (GaGE Consulting, 2022).

According to the Seismic Hazard Map of South Africa (SANS 10160-4, 2010), the site has a peak ground acceleration of $\sim 0.2 g^{25}$ and lies within seismic hazard Zone II, Class 2 (regions of mine-induced and natural seismic activity) (GaGE Consulting, 2022).

Although the site is located near the Klerksdorp goldfields (also known as the Klerksdorp-Orkney-Stilfontein-Hartebeesfontein [KOSH] area) and Stilfontein mining area, the site does not fall within the Stilfontein Mine lease and no deep and documented mine shafts underlie the site (GaGE Consulting, 2022). In a preliminary geotechnical study for the project, (GaGE Consulting, 2022) concluded that undermining will not pose any fatal flaws to the proposed development at this stage.

Topographically the project area lies in the western portion of South Africa's highveld, which primarily consists of rolling plains. The Stilfontein Cluster site topography is fairly uniform and elevation ranges slightly from $\sim 1\ 380$ m above mean sea level (amsl) in the north to ~ 1340 m in the south near the N12. Gently undulating topography to the northeast and northwest of the sites rises to $\sim 1\ 500$ m amsl (see Figure 4-2) (SRK Consulting, 2022a) (The Biodiversity Company, 2022a).

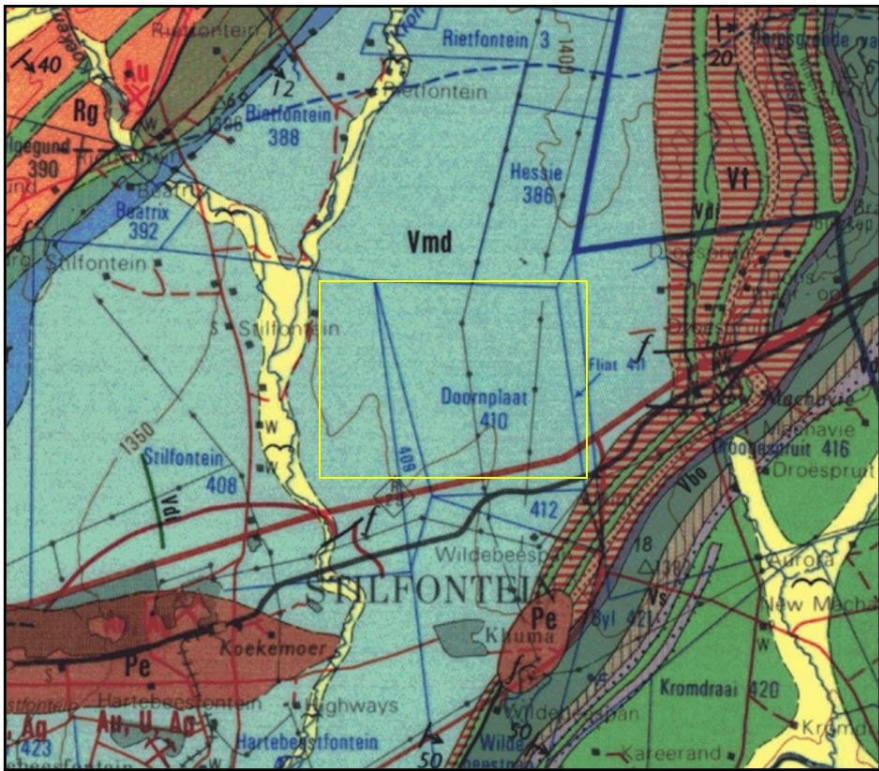

Figure 4-1: Geology of the project area (yellow rectangle)

Sources: (Beyond Heritage, 2022)

Notes: **Vmd** denotes Dolomite, chert and remnants of chert breccia of the Rooihooft Formation

Slope gradients vary, as the ground is undulating, but average slope is ~ 1 to 2 degrees, with localised slopes of up to 4 degrees (and less than 1:10, equivalent to 5.7 degrees) (see Figure 4-3). Isolated outcrops of chert and dolomite are located in the area (GaGE Consulting, 2022).

The general site drainage is anticipated to occur towards the Koekemoerspruit River to the west of the site which flows in a southerly direction into the Vaal River. The site drainage will occur as overland surface flow and shallow subsurface flow and convergence into lower lying areas across the site.

²⁵ The peak ground acceleration may be described as the maximum acceleration of the ground shaking during an earthquake, which has a 10% probability of being exceeded in a 50-year period.

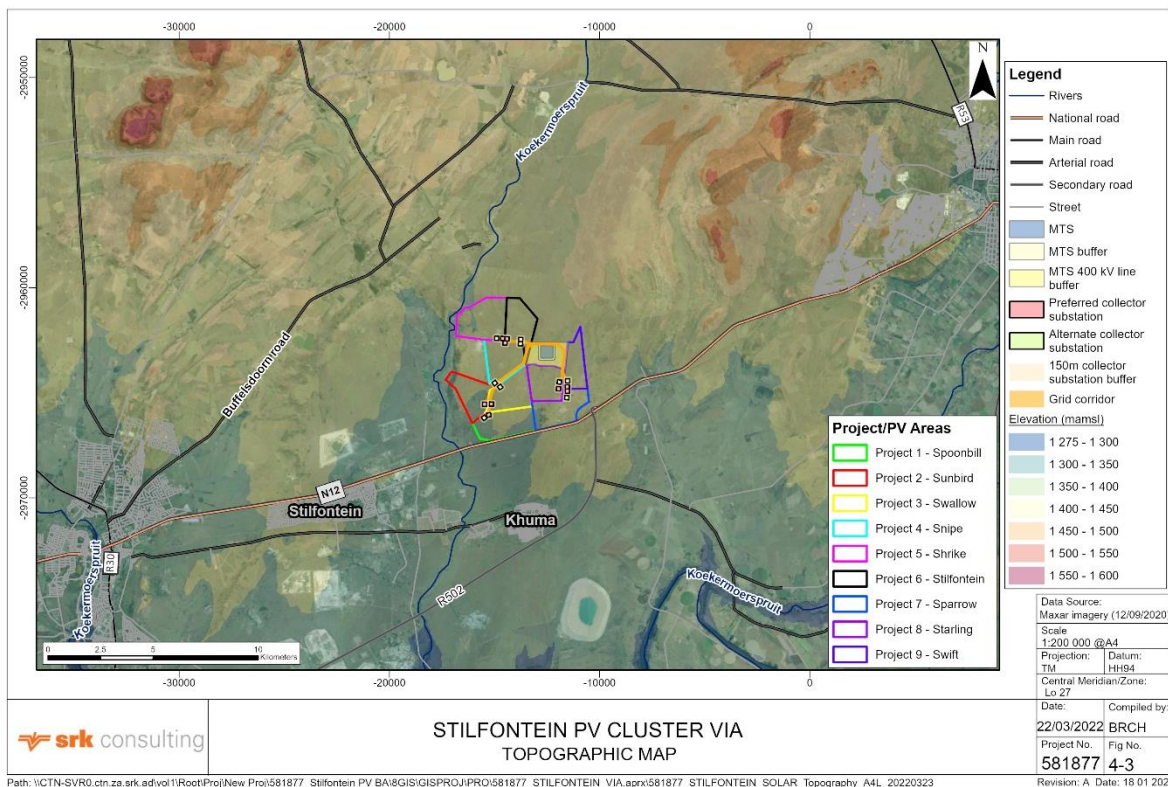

Figure 4-2: Project area topography

Source: (SRK Consulting, 2022a)

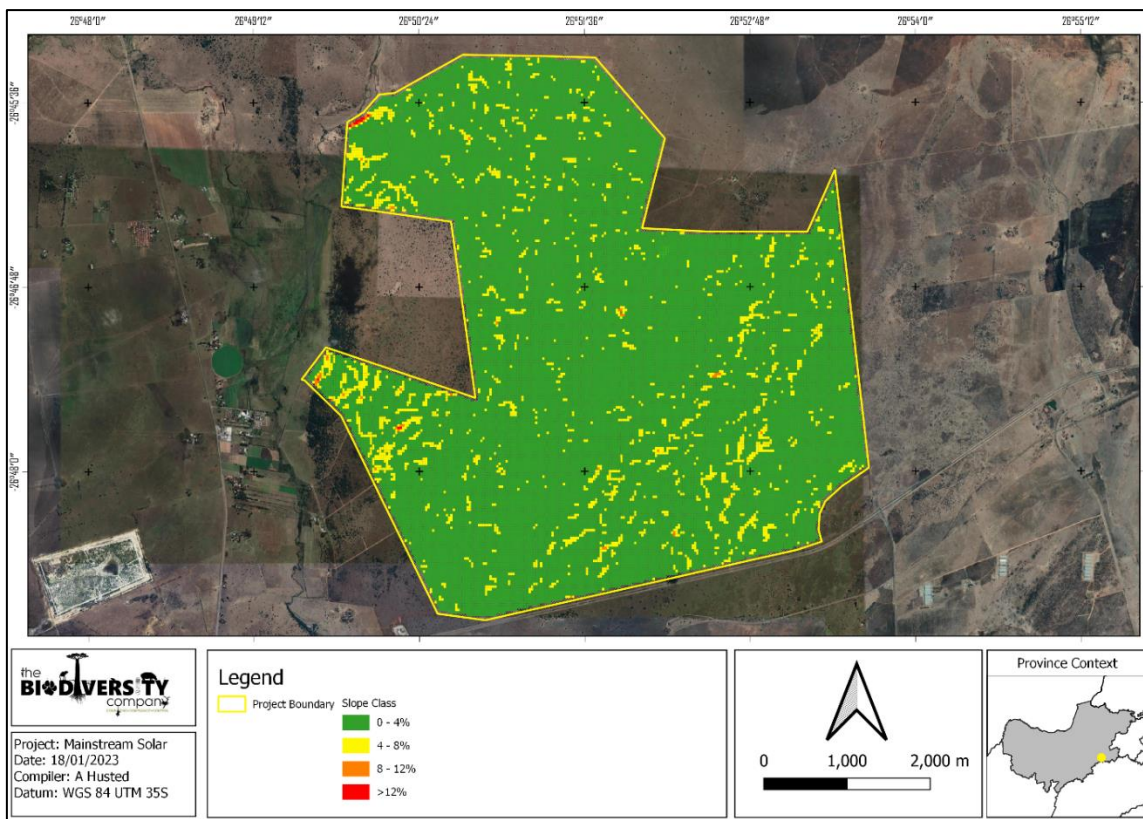

Figure 4-3: Slopes in the Stilfontein Cluster project area

Source: (The Biodiversity Company, 2022a)

Note: A slope of 4% = 2.29 degrees, 8% = 5.57 degrees, 12% = 6.84 degrees.

4.1.2 Climate

The study area falls within the Cwa (temperate, dry winter, hot summer) and BSk (cold arid steppe) climate subtypes of the Warm Temperate Climate and Tropical and Subtropical Steppe Climate, respectively, as classified by the Köppen Climate Classification system. The site experiences moderate to hot summers and cold and dry winters with some frost at night.

Temperatures range between an average annual minimum of 10°C and an average annual maximum of 23°C. The coldest months are June and July, while January is the hottest with minimum temperature of 16°C and maximum temperature of 32°C (Figure 4-4 and Figure 4-5).

Mean annual rainfall in the region is 593 mm, which correlates well with the 592 mm mean annual precipitation measured in Stilfontein since 1910 (Figure 4-5). Rain occurs predominantly in the form of thunderstorms and mostly between November and March. Humidity is moderate at approximately 56% (www.weatherbase.com).

Wind is predominantly northerly, with wind speeds exceeding 5 m/s ~51% of the time in summer and 36% of the time in winter (WeatherSpark, 2022).

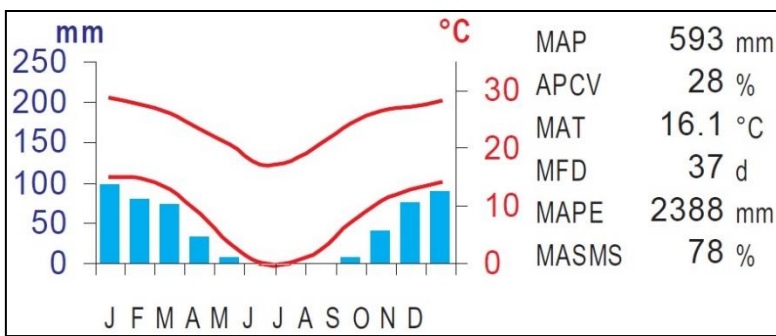

Figure 4-4: Climatic characteristics of the project region

Sources: (Mucina & Rutherford, 2006)

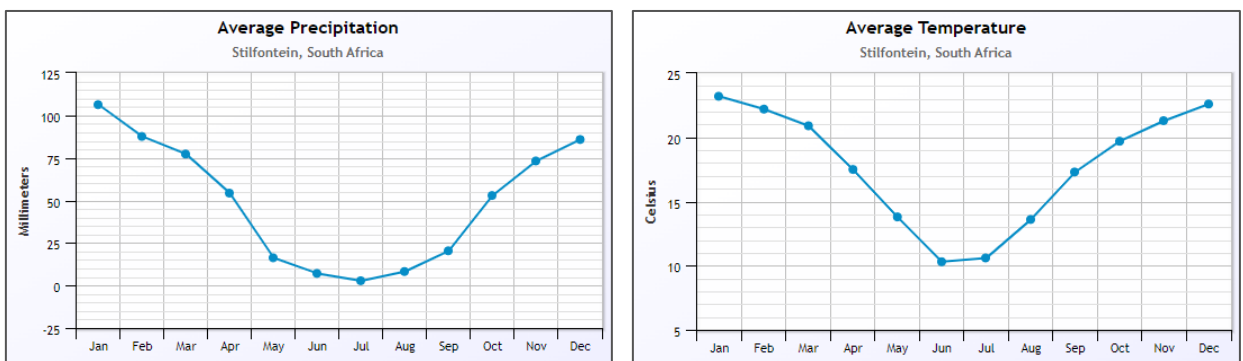

Figure 4-5: Average monthly precipitation (left) and temperature (right) in Stilfontein, 1910-2022

Sources: www.weatherbase.com

4.1.3 Soils and Land Capability

Agricultural potential, or land capability, is determined by soil, terrain and climate characteristics and reflects the most intensive long-term use of land under rain-fed conditions (The Biodiversity Company, 2022a).

Soil profile analysis revealed four diagnostic horizons or layers, including orthic topsoil, lithocutanic horizon, red apedal horizon and gley horizon. The project area is predominantly characterised by the dark geolithic Glenrosa soil form (Figure 4-6). The project area is relatively flat, with slopes primarily below 5% (see Section 4.1.1). The area has a climatic capability class of C8, which indicates very severe limitations, i.e. very severe restrictions in the choice of crops due to heat and moisture stress. Suitable crops are at high risk of yield loss.

As a result of the above factors, the project area is of land capability Class VI (limitations preclude cultivation, suitable for perennial vegetation), with an HGM 1 depression wetland categorised as land capability Class V (water course and land with wetness limitations). Either class is suitable for grazing and has low (agricultural) sensitivity.

Due to poor climatic and land capability, the agricultural potential of the entire area is classified as L7²⁶, which means it has low agricultural potential, severe limitations due to soil, slope, temperatures or rainfall and is non-arable (The Biodiversity Company, 2022a).

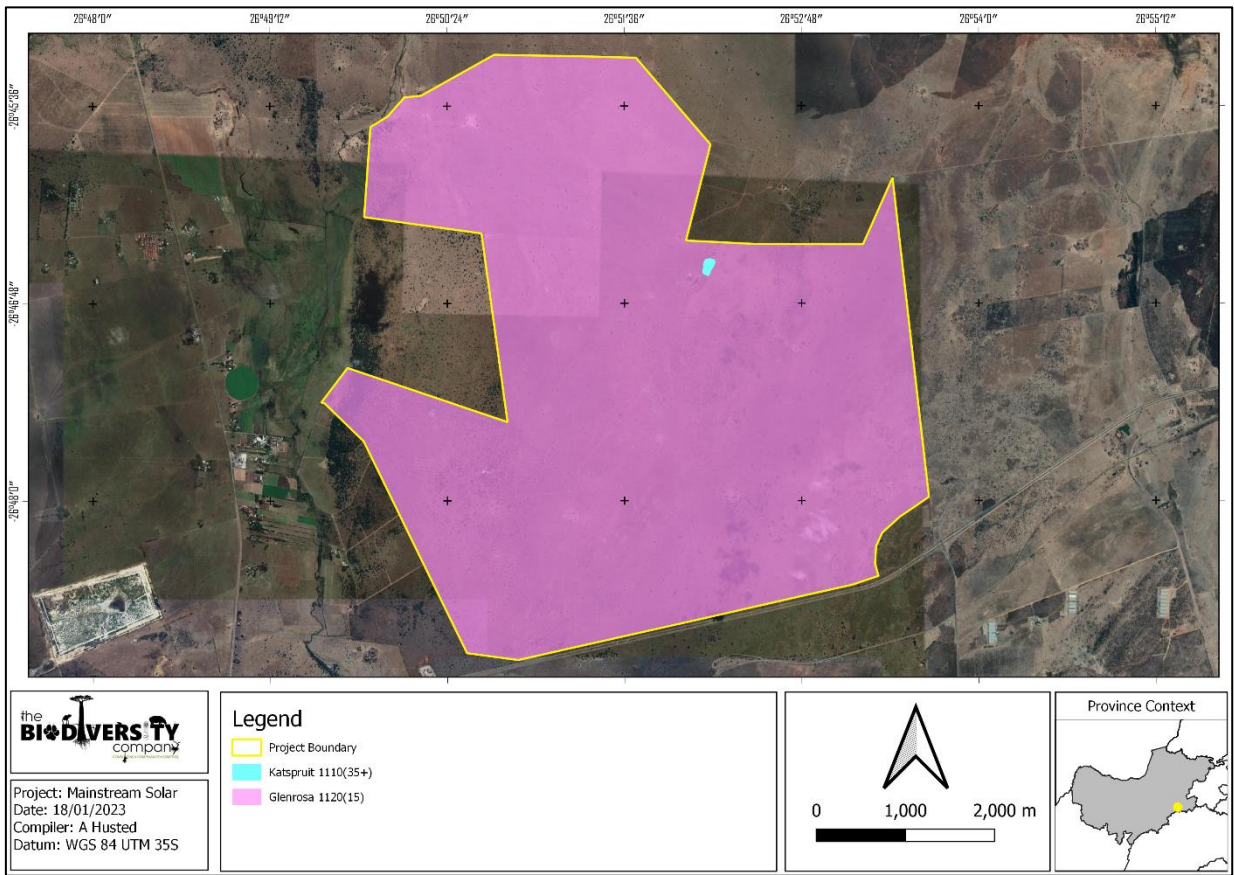

Figure 4-6: Soil types in the Stilfontein Cluster project area²⁷

Source: (The Biodiversity Company, 2022a)

4.1.4 Wetlands

The Stilfontein Cluster site lies between the Kromdraaispruit and Koekemoerspruit rivers to the west and the Drospruit River to the east. Floodplain wetlands in these rivers are categorised as Critically Endangered in the 2018 National Biodiversity Assessment (NBA). The project area is within 500 m of the

²⁶ The HGM 1 depression wetland is categorised as Vlei.

²⁷ The Vaalbos soil form was not delineated due to the small extent of the soil form.

Critically Endangered Kromdraaispruit and Koekemoerspruit Rivers, with no overlap with these Rivers. The project area slightly overlaps with Critically Endangered floodplain wetlands (Figure 4-7) (The Biodiversity Company, 2022b). The Stilfontein Cluster does not overlie any Freshwater Ecosystem Priority Areas (FEPAs).

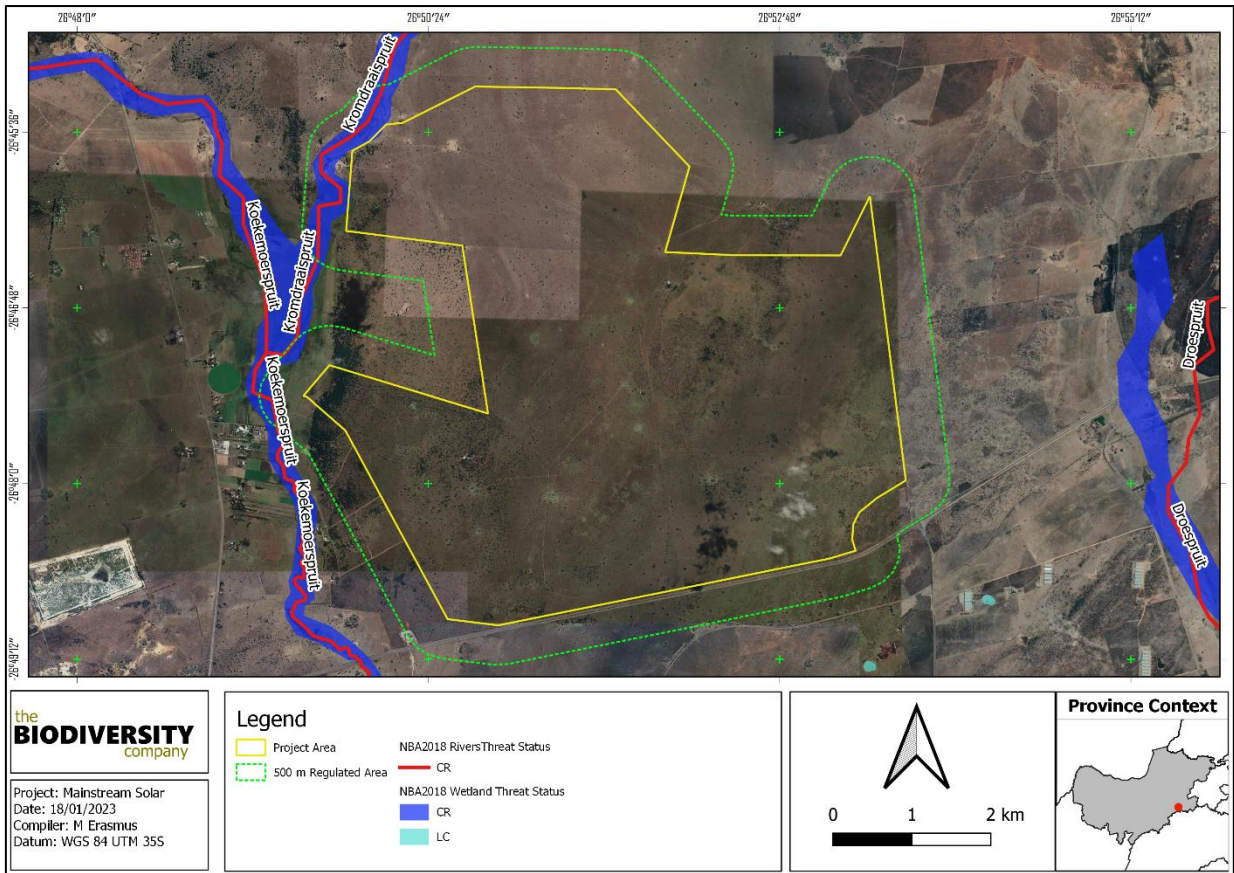

Figure 4-7: Ecosystem threat status of river and wetland ecosystems in the 500 m regulated area of the Stilfontein Cluster

Source: (The Biodiversity Company, 2022c)

Two wetland units are located within the Stilfontein Cluster including the 500 regulated area: a depression wetland (HGM 1) close to the centre of the Stilfontein Cluster (see Figure 4-8 and Figure 4-9) and a floodplain wetland (HGM 2) outside the north-western Cluster boundary (see Figure 4-8 and Figure 4-10). Both wetlands support hydrophytic and facultative wetland species such as *Cyperus* spp. (including *C. dives*) and *Schoenoplectus* spp. Some alien vegetation is also present.

The depression wetland (HGM 1) is fed by runoff from the surrounding topography and to some extent by lateral sub-surface flows. The dominant soil form of the depression wetland is the Mispah soil form. The ecosystem function and service provision was assessed as low. The wetland provides a number of ecosystem services, including carbon storage, biodiversity maintenance and (potentially) tourism and recreation. The Present Ecological State (PES) is Category C (moderately modified), with an overall score of 2.5.

The floodplain wetland (HGM 2) is fed by overflows from the stream channel banks along with lateral seepage with orthic mineral topsoil overlaid on gleyic horizons of the Katspruit form. The wetland provides a number of ecosystem services, including biodiversity maintenance, stream flow regulation and water for human use. The ecosystem function and service provision of the floodplain was assessed to be moderate to moderately high due to its ability to regulate stream flow and trap sediment. The PES is Category C (moderately modified), with an overall score of 3.8 and hydrology PES only at Category D.

Grazing and trampling by livestock in the floodplain and historic agricultural activities within the catchment have lowered the PES. Both wetlands have a low Ecological Importance and Sensitivity rating.

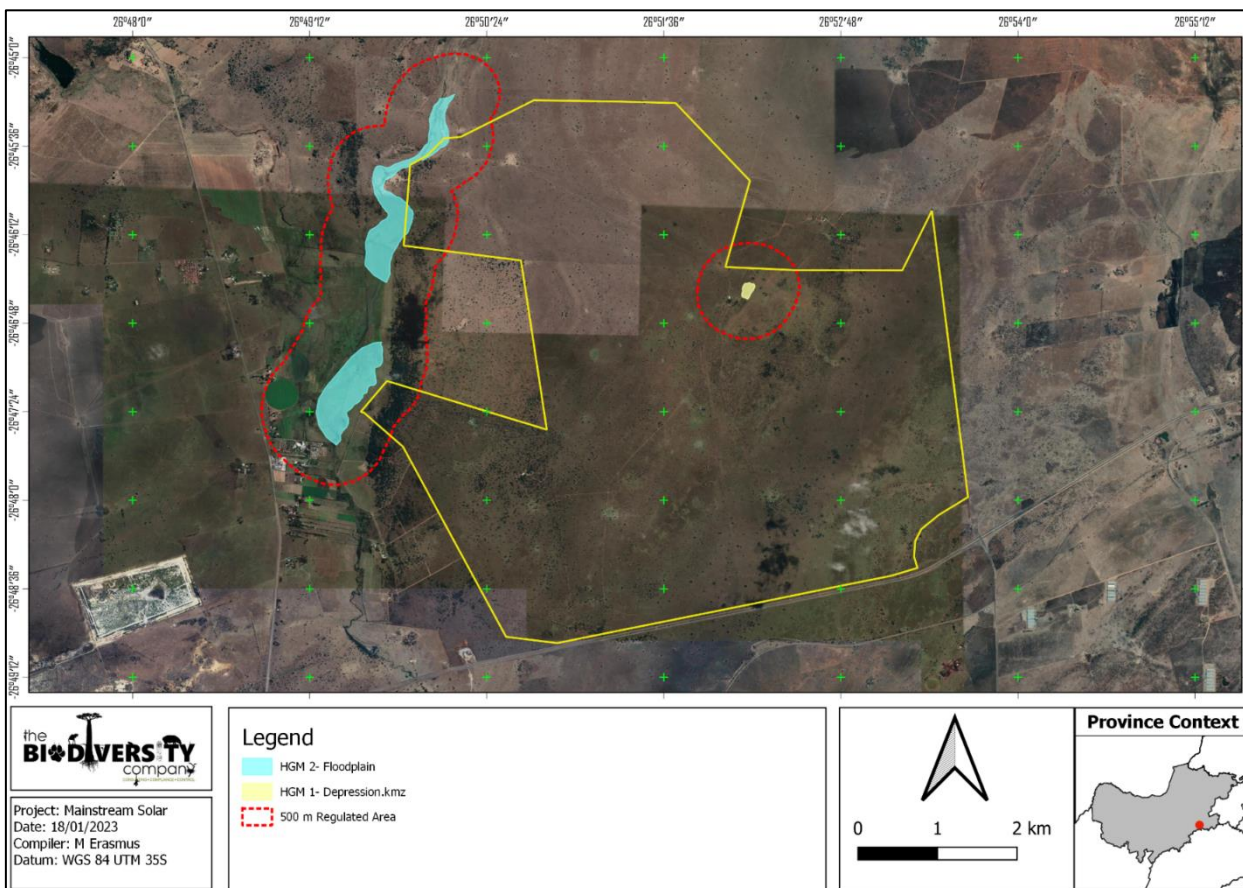

Figure 4-8: Hydrogeomorphic units within the 500 m regulated area in the Stilfontein Cluster area

Source: (The Biodiversity Company, 2022b)



Figure 4-9: Depression wetland HGM 1, showing wetland centre (A) and wetland outskirts with hydrophytes (B)

Source: (The Biodiversity Company, 2022b)



Figure 4-10: Floodplain wetland HGM 2, showing downstream (left) and upstream (right) of the portion located within the 500 m of the Stilfontein Cluster

Source: (The Biodiversity Company, 2022b)

4.1.5 Terrestrial Ecology

The North West Province supports grassland and savanna vegetation. The project area falls within the Dry Highveld Grassland Bioregion, which is reminiscent of African savannah landscapes as it comprises grasses and low shrubby vegetation with small clusters of trees and bushes. Approximately 30% of the biome has been transformed by cultivation, forestry, urbanisation and mining (Mucina & Rutherford, 2006). The biome flora is not particularly species rich compared to other South African biomes and contains few endemic species. There are few floral and faunal Species of Conservation Concern (SCC) in the region and is considered Least Concern (The Biodiversity Company, 2022c) (Mucina & Rutherford, 2006).

Natural disturbances that drive vegetation dynamics in the region aside from agricultural grazing include grazing by wild herbivores, fire, rainfall and runoff (which causes erosion). Fire events in the grassland biome are frequent, but recovery is generally fast. High intensity rainfall events coupled with low vegetation cover can result in sheet erosion (Mucina & Rutherford, 2006) (READ, 2015).

4.1.5.1 Vegetation

Open woodland with a prominent grassy component is the dominant habitat type in the Stilfontein Cluster project area (Figure 4-11). The woodland consists of mainly fine-leaved, semi-deciduous *Vachellia*-dominated shrubs and medium-sized trees with shrub / tree density ranging from relatively dense in places to open tracts of grassland with scattered shrubs (Chris van Rooyen Consulting, 2022). The dominant vegetation consists of grassland-woodland vegetation with dolomite extrusions and prominent rocky ridges (The Biodiversity Company, 2022c).

The habitat in most of the project area is degraded (see Figure 4-11) due to historic overgrazing and other agricultural practices. While the area is not entirely transformed, ongoing disturbance prevents recovery of these areas to a more natural state.

The rocky ridge located in the southern portion of the Stilfontein Cluster area functions as a micro-habitat for small faunal species such as the Cape Rock Hyrax (*Procavia capensis*) and is regarded as sensitive.

The Stilfontein Cluster project area overlaps widely with areas classified as ESA1, with less extensive overlap with ESA2 and CBA2 areas (see Figure 2-2 and Figure 7-1).



Figure 4-11: Habitat type of the project area: open woodland (top), degraded grassland (middle) and rocky outcrop (bottom)

Source: (Chris van Rooyen Consulting, 2022) (The Biodiversity Company, 2022c)

Vegetation structure of the Stilfontein Cluster project area is predominantly Vaal Reefs Dolomite Sinkhole Woodland, with Carletonville Dolomite Grassland in the north-east. Vaal Reefs Dolomite Sinkhole Woodland (Gh 12) vegetation occurs at altitudes ranging from 1 280 to 1 380 m amsl, in slightly undulating plains dissected by rocky chert ridges. Vegetation consists of small trees, low and tall shrubs and graminoids. Dominant species includes *Vachellia* (formerly *Acacia*) spp., *Asparagus* spp., *Commelina africana*, *Aristida congesta*, *Digitaria eriantha* and *Eragrostis* spp. Dolomite Sinkhole Woodland is **vulnerable** and ~25% of its original extent has been transformed by mining, cultivation, urban sprawl and infrastructure (Mucina & Rutherford, 2006).

Carletonville Dolomite Grassland (Gh 15) vegetation is mainly found in the North West, and to some extent in Gauteng and Free State Province. Carletonville Dolomite Grassland occurs in undulating plains dissected by rocky chert ridges. Vegetation consists mainly of graminoids and also includes herbs, geophytic herbs, low shrubs and geoxyllic suffrutices. Dominant species include *A. congesta*, *Brachiaria serrata*, *Cynodon dactylon*, and *Eragrostis* spp. The succulent shrub *Delosperma davyi* is found only in this vegetation type. Carletonville Dolomite Grassland is classified as **vulnerable** and ~25% of its original extent has been transformed by cultivation, urban sprawl, mining and the construction of the Boskop and Klerkskraal Dams (Mucina & Rutherford, 2006).

A total of 111 floral species were recorded in the Stilfontein Cluster project area, of which three are endemic (*Crabbea angustifolia*, *Ehretia rigida* and *Gladiolus permeabilis*). Five invasive alien plants, listed as NEMBA Category 1b, were recorded, with 7 listed as naturalized exotics. The remaining 96 plants are indigenous species, classified as Least Concern. Some of the recorded species are shown in Figure 4-12, while a complete list of recorded species is provided in Appendix D.2.

Camel Thorn trees (*Vachellia erioloba*, see Figure 4-13) are the only SCC and recorded throughout the project area. Camel thorn trees are protected under the National Forests Act 84 of 1998. The density of Camel Thorn trees varies across the Stilfontein Cluster area. The total number of Camel Thorn trees in the Stilfontein Cluster area exceeds 500²⁸.

²⁸ Not all trees would need to be removed for the project. Impacted trees will be identified during the detailed design phase. An Application for a Licence Regarding Protected Trees needs to be lodged in terms of Section 15(1) of the National Forest Act 84 of 1998 for the cutting, disturbing, damaging or destruction of any protected tree.



Figure 4-12: Selected flora species recorded in the Stilfontein Cluster project area

Source: (The Biodiversity Company, 2022c)

Notes: A) *Senecio inornatus*, B) *Boophone disticha*, C) *Crabbea angustifolia*, D) *Harpagophytum procumbens*, E) *Delosperma herbeum* and F) *Gladiolus permeabilis*



Figure 4-13: Camelthorn trees in the Stilfontein Cluster project area

Source: (The Biodiversity Company, 2022c)

4.1.5.2 Fauna

4.1.5.2.1 Herpetofauna

Twenty (20) amphibian and forty-three (43) reptile species are expected to occur in the Stilfontein Cluster. The only amphibian SCC that is expected to occur in the project area is the Near-Threatened Giant Bullfrog (*Pyxicephalus adspersus*). One reptilian SCC (the Vulnerable Cape sand snake – *Psammophis leightoni*) has a low likelihood of occurrence in the project area.

Five reptilian and three amphibian species were recorded in the Stilfontein Cluster (Table 4-2). None of these species are regarded as threatened.

Table 4-2: Herpetofauna species recorded in the Stilfontein Cluster project area

Species	Common Name	Conservation Status	
		Regional (SANBI, 2016)	IUCN (2021)
Reptiles			
<i>Acanthocercus atricollis</i>	Southern Tree Agama	LC	LC
<i>Lygodactylus capensis</i>	Cape dwarf gecko	LC	LC
<i>Trachylepis punctatissima</i>	Speckled Rock Skink	LC	LC
<i>Pachydactylus capensis</i>	Cape Gecko	LC	Unlisted
<i>Pelomedusa galeata</i>	South African Marsh Terrapin	Not evaluated	Unlisted
Amphibians			
<i>Amietia fuscigula</i>	Common River Frog	LC	LC
<i>Cacosternum boettgeri</i>	Common Caco	LC	LC
<i>Kassina senegalensis</i>	Bubbling Kassina	LC	LC

Source: (The Biodiversity Company, 2022c)



Figure 4-14: Selected reptiles recorded in the Stilfontein Cluster project area

Source: (The Biodiversity Company, 2022c)

Notes: A) Cape Gecko (*Pachydactylus capensis*), B) South African Marsh Terrapin (*Pelomedusa galeata*)

4.1.5.2.2 Mammals

Large herds of indigenous migratory ungulates and predators once roamed the Highveld. While these have now been mostly replaced by ‘captive’ species on game farms, a number of medium to large mammal species are still known to occur in the project area. These include Greater Kudu, Springbok, Duiker, Black-backed Jackal, Steenbok, Aardwolf and Vervet Monkey. ‘Captive’ species only observed on game farms in the cluster project area include Impala, Red Hartebeest, Blue Wildebeest, Common Waterbuck, Common Eland and the near-threatened Plains Zebra (Figure 4-15).

Several smaller mammal species were observed, including *Cynictis penicillata* (Yellow Mongoose), Shrub Hare (*Lepus saxatilis*) and Southern African Ground Squirrel (*Xerus inauris*). The rocky outcrops are microhabitats frequented by many of the observed rodent species recorded (Figure 4-15).

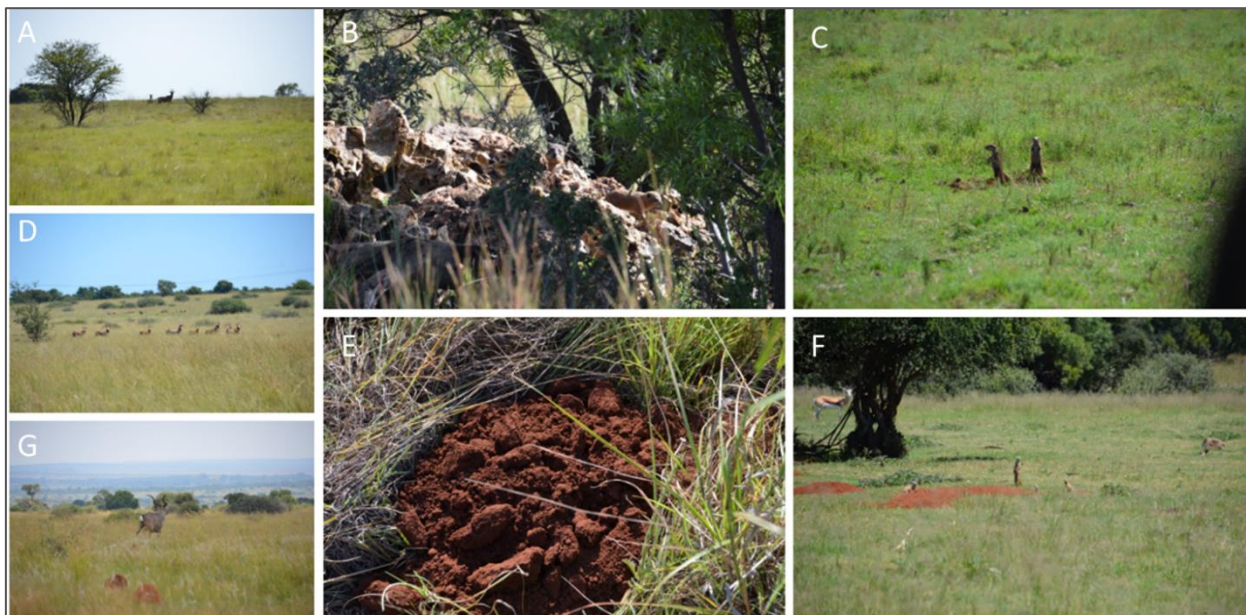

Figure 4-15: Selected mammal species observed in the Stilfontein Cluster project area

Source: (The Biodiversity Company, 2022c)

Notes: A) Red Hartebeest (*Alcelaphus buselaphus caama*), B) Cape Rock Hyrax (*Procavia capensis*), C) South African Ground Squirrel (*Xerus inauris*), D) Blesbok (*Damaliscus pygargus*), E) Southern African Mole-rat (*Cryptomys hottentotus*) and F) Meerkat (*Suricata suricatta*) & Springbok (*Antidorcas marsupialis*) and G) Greater Kudu (*Tragelaphus strepsiceros*).

Thirteen mammal SCC are expected to occur in the project area (Table 4-3), of which five have a moderate to high likelihood of occurrence based on the suitability of habitat and availability of food sources. These include Southern African Hedgehog (*Atelerix frontalis*), African White-tailed Rat (*Mystromys albicaudatus*), Serval (*Leptailurus serval*), Southern African Vlei Rat (Grassland type) (*Otomys auratus*) and the Brown Hyena (*Parahyaena brunnea*). None of these species were directly or indirectly observed in the project area.

Table 4-3 Mammal species of conservation concern expected to occur in the Stilfontein Cluster

Species	Common Name	Conservation Status	
		Regional (SANBI, 2016)	IUCN (2021)
<i>Aonyx capensis</i>	African Clawless Otter	NT	NT
<i>Atelerix frontalis</i>	Southern African Hedgehog	NT	LC
<i>Crocidura maquassiensis</i>	Makwassie musk shrew	VU	LC
<i>Crocidura mariquensis</i>	Swamp Musk Shrew	NT	LC
<i>Eidolon helvum</i>	African Straw-coloured Fruit Bat	LC	NT
<i>Felis nigripes</i>	Black-footed Cat	VU	VU
<i>Hydrichtis maculicollis</i>	Spotted-necked Otter	VU	NT
<i>Leptailurus serval</i>	Serval	NT	LC
<i>Mystromys albicaudatus</i>	African White-tailed Rat	VU	EN
<i>Otomys auratus</i>	Southern African Vlei Rat (Grassland type)	NT	NT

Species	Common Name	Conservation Status	
		Regional (SANBI, 2016)	IUCN (2021)
<i>Panthera pardus</i>	Leopard	VU	VU
<i>Parahyaena brunnea</i>	Brown Hyaena	NT	NT
<i>Poecilogale albinucha</i>	African Striped Weasel	NT	LC

Source: (The Biodiversity Company, 2022c)

4.1.5.2.3 Avifauna

The project area does not lie within or near an Important Bird Area or a Protected Area. The closest Important Bird Area is the Sandveld and Bloemhof Dam Nature Reserves (IBA SA039) ~102 km south-west of the site. The Faan Meintjies Private Nature Reserve lies ~10 km west of the project site, and the project is not expected to impact on either (Chris van Rooyen Consulting, 2022).

The habitat type (open woodland), presence of surface water and of overhead powerlines determines the type of birds expected in the area. Artificial impoundments (including cement water troughs and reservoirs) are important water sources for birds. Several species also utilise the impoundments as habitat and hunting grounds and for bathing and drinking. More than 210 species are expected to occur within the broader area, 23 of these are considered powerline priority species²⁹ (see Table 4-4).

Table 4-4: Avifauna priority species likely to occur in the Stilfontein Cluster project area

Species	Common Name
<i>Falco amurensis</i>	Amur Falcon
<i>Ardea melanocephala</i>	Black-headed Heron
<i>Elanus caeruleus</i>	Black-winged Kite
<i>Vanellus armatus</i>	Blacksmith Lapwing
<i>Zosterops virens</i>	Cape White-eye
<i>Cisticola textrix</i>	Cloud Cisticola
<i>Buteo buteo</i>	Common Buzzard
<i>Alopochen aegyptiaca</i>	Egyptian Goose
<i>Melaenornis silens</i>	Fiscal Flycatcher
<i>Micronisus gabar</i>	Gabar Goshawk
<i>Falco rupicoloides</i>	Greater Kestrel
<i>Bostrychia hagedash</i>	Hadada Ibis
<i>Numida meleagris</i>	Helmeted Guineafowl
<i>Turdus smithi</i>	Karoo Thrush
<i>Falco biarmicus</i>	Lanner Falcon
<i>Falco naumanni</i>	Lesser Kestrel
<i>Afrotis afraoides</i>	Northern Black Korhaan
<i>Corvus albus</i>	Pied Crow
<i>Lamprotornis bicolor</i>	Pied Starling

²⁹ Powerline priority species are defined as species which could potentially be impacted by powerline collisions or electrocutions, based on their morphology. Larger birds, particularly raptors and vultures, are more vulnerable to electrocution as they are more likely to bridge the clearances between electrical components than smaller birds. Large terrestrial species and certain waterbirds with high wing loading are less manoeuvrable than smaller species and are therefore more likely to collide with overhead lines.

Species	Common Name
<i>Petrochelidon spilodera</i>	South African Cliff Swallow
<i>Bubo africanus</i>	Spotted Eagle-Owl
<i>Bubulcus ibis</i>	Western Cattle Egret
<i>Gyps africanus</i>	White-backed Vulture

Source: (Chris van Rooyen Consulting, 2022)

Even though the project area contains marginal habitat for several SCC, the Critically Endangered White-backed Vulture (*Gyps africanus*) is the only SCC recorded in the Stilfontein Cluster area, recorded roosting on the 400kV Hermes / Pluto 2 powerline (Figure 4-16 and Figure 4-17). It is expected that other powerline priority avifaunal species (more specifically raptors) may also use the powerlines for roosting and breeding.

Water reservoirs located throughout the Stilfontein Cluster area (see Figure 4-18) are important for priority avifauna and many non-priority species. Retaining at least four water reservoirs across the Stilfontein Cluster area (see Figure 1-1), with one retained in the north west, one retained in the south east, and two to be retained near the MTS, is deemed important to provide birds with adequate access to the water. The relocation of existing water points can be considered (with a minimum of four water points in the Cluster area). These four water points are considered by the specialist to provide adequate water resources for the avifauna in the cumulative assessment area. The specialist noted that a cement water trough is preferred to a water reservoir in terms of design of avian water points.

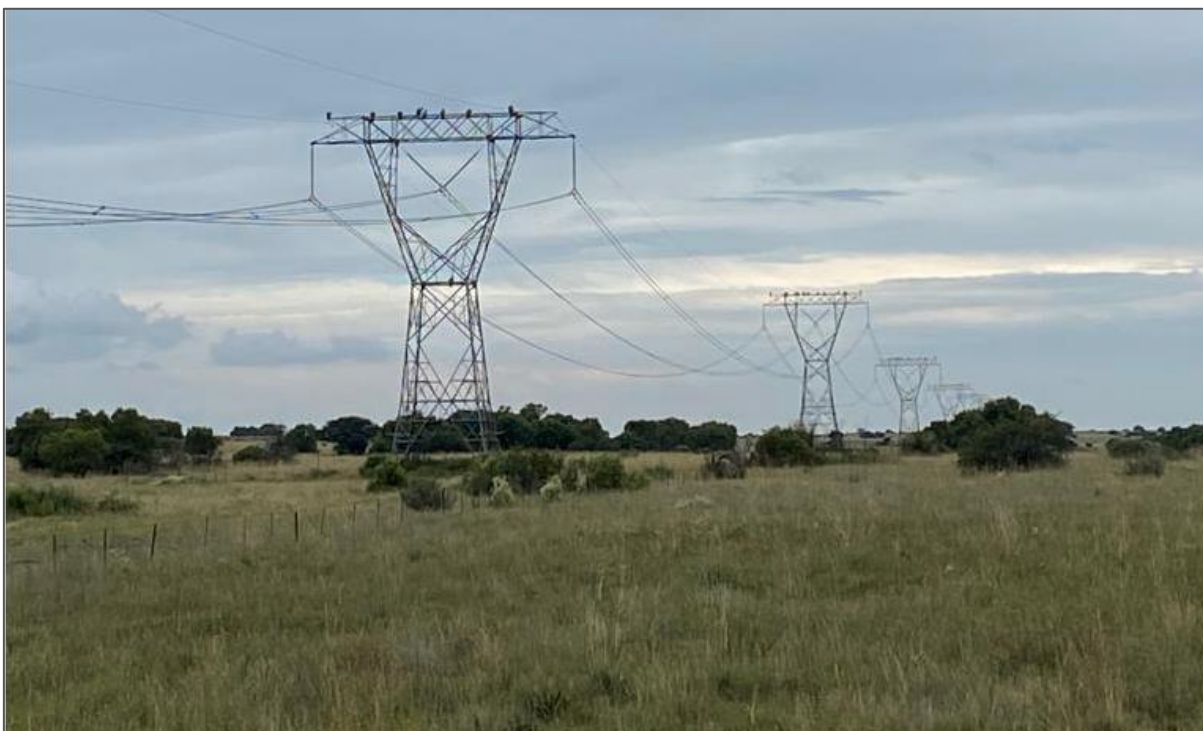

Figure 4-16: White-backed vultures roosting on the 400kV Hermes – Pluto 2 transmission line

Source: (Chris van Rooyen Consulting, 2022)

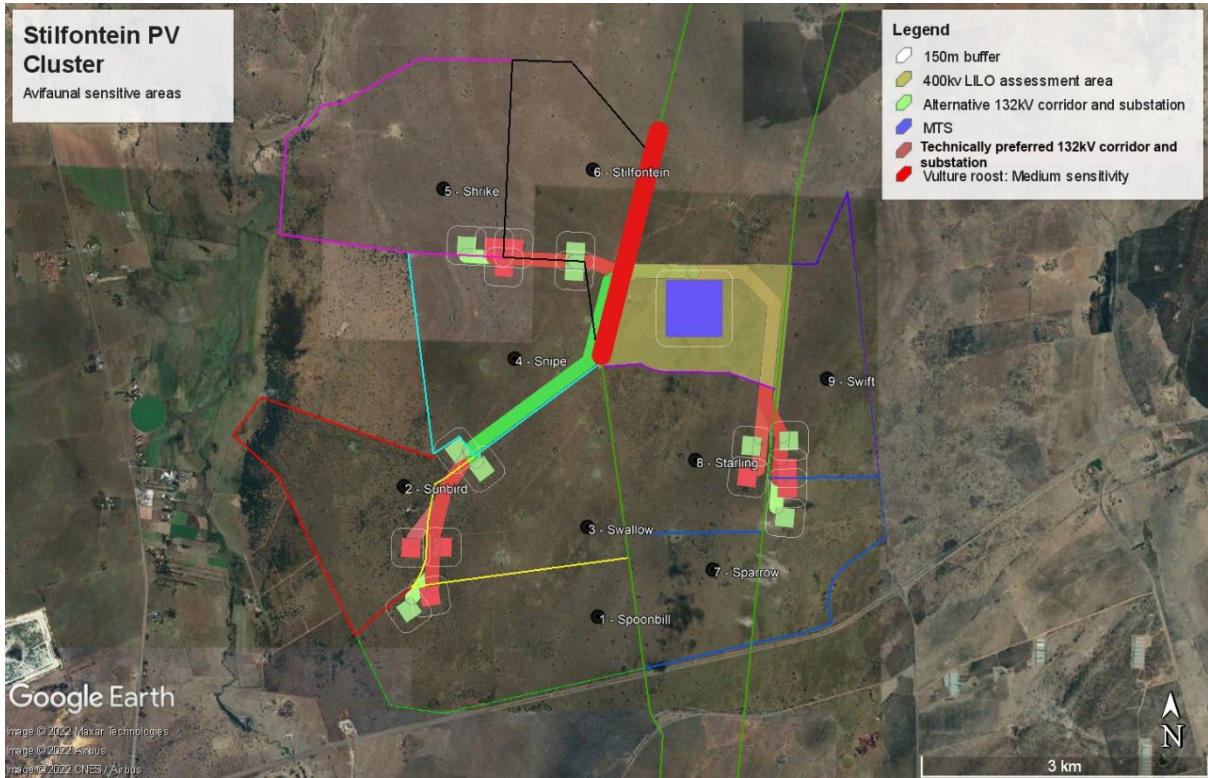

Figure 4-17: Location of White-backed Vulture roosts on the Hermes/Pluto 2 overhead line³⁰

Source: (Chris van Rooyen Consulting, 2022)

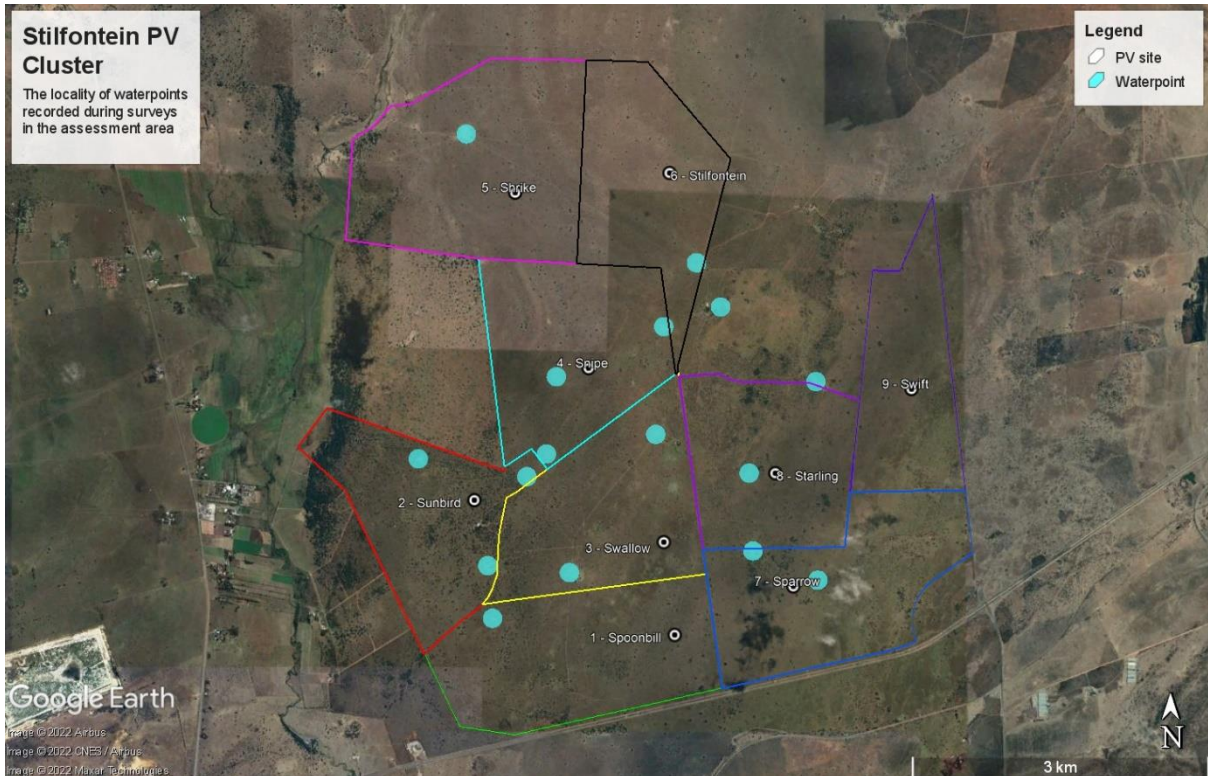

Figure 4-18: Location of water reservoirs in the Stilfontein Cluster project area

Sources: (Chris van Rooyen Consulting, 2022)

³⁰ The locality of the roost on the powerlines is likely to shift periodically in response to the availability of food (Chris van Rooyen Consulting, 2022).

4.2 Socio-Economic Environment

4.2.1 Regional Context

The project lies in the DKKDM, which comprises the JB Marks, City of Matlosana and Maquassi Hills LM. The DKKDM is situated in the south-eastern part of the North West Province and borders the Free State and Gauteng Provinces. The DKKDM is the smallest district in the North West Province, covering 14% of the provincial area, with a population of 742 822 in 2016, or 20% of the provincial population (Wazimap, 2022a) (DKKDM, 2017a). The area has a number of decommissioned gold mines (Batho Earth & SED, 2020). The district is strategically located along the national transport corridor between Johannesburg and Cape Town, with the N12 corridor forming the main regional development axis and a potential focal point for future development (Municipalities of South Africa, 2022a).

The Stilfontein Cluster project area is located in the JB Marks LM, with only the south-western portion falling within the City of Matlosana LM. JB Marks LM includes the towns of Potchefstroom and Ventersdorp and a number of large rural wards.

4.2.2 Demographics

The JB Marks LM population increased by 17% between 2011 and 2016 to 243 528, faster than the DKKDM population growth rate of 12%. Approximately 33% of the DKKDM population resides in the JB Marks LM (Wazimap, 2022c), of which the majority live in Potchefstroom and Ventersdorp (Batho Earth & SED, 2020). More than 95% of residents are younger than 65 years old: 35% of residents (~85 200 residents) are younger than 18 years and 60% (~146 500 residents) are aged between 18 – 64 years. The population in the JB Marks LM is comprised of 77% Black Africans, 17% Whites and 5% Coloureds (see Table 4-5).

The DKKDM population is comprised of 82% Black Africans, 4% Coloureds, 14% Whites and less than 1% Indians (see Table 4-5).

Most households have three household members.

Table 4-5: Population distribution (number and percentage) across the JB Marks LM, DKKDM and Province

Population Group	JB Marks LM		DKKDM		North West Prov	
Black African	187 656	77%	606 652	82%	3 432 379	92%
Coloured	12 987	5%	27 185	4%	61 010	2%
Indian/ Asian	1 620	1%	5 066	1%	16 686	1%
White	41 264	17%	103 919	14%	238 360	6%

Source: (Wazimap, 2022c)

4.2.3 Social Characteristics

Employment opportunities in the DKKDM are limited. In rural areas, employment is primarily in the mining sector, which provides opportunities for primarily semi-skilled and unskilled workers and does not pay high wages. Towns have a slightly more diverse employment profile. Generally, the District is characterised by high levels of poverty and low levels of education.

The Human Development Index (HDI)³¹ scores in the DKKDM are similar to national HDI scores, at 0.56 and 0.58 respectively in 2010, and are slightly higher than the provincial average, indicating that the DKKDM is relatively better off than other district municipalities in the North West. Poverty and inequality are entrenched throughout the province (NWP, 2013) and rising, affecting nearly one third of provincial residents. DKKDM poverty levels are slightly lower than the provincial average: the DKKDM Poverty Gap Index³² increased from 27.8% to 30.2% between 2013 and 2019, whereas it increased from 27.9% to 31.4% across the North West (NWDC, 2021b) (NWDC, 2016), with the number of people living in poverty increasing by 12.3% in the DKKDM between 2013 and 2019 (NWDC, 2021a) (NWDC, 2016) – which does not yet take the economic effects of the COVID-19 pandemic into account.

The average annual household income in the JB Marks LM was R30 000 in 2011 (Wazimap, 2022g), with 39% households earning less than R20 000 per annum. Household income distribution is comparable across the JB Marks LM, DKKDM and North West Province.

Some 13% of JB Marks LM residents were unemployed in 2011, a further 4% were discouraged work seekers and 40% of people were not economically active (Wazimap, 2022e). Of the 43% of the working-age population that were employed, 74% worked in the formal sector (Wazimap, 2022e), while 24% had more precarious employment in the informal sector and private households (see Figure 4-19).

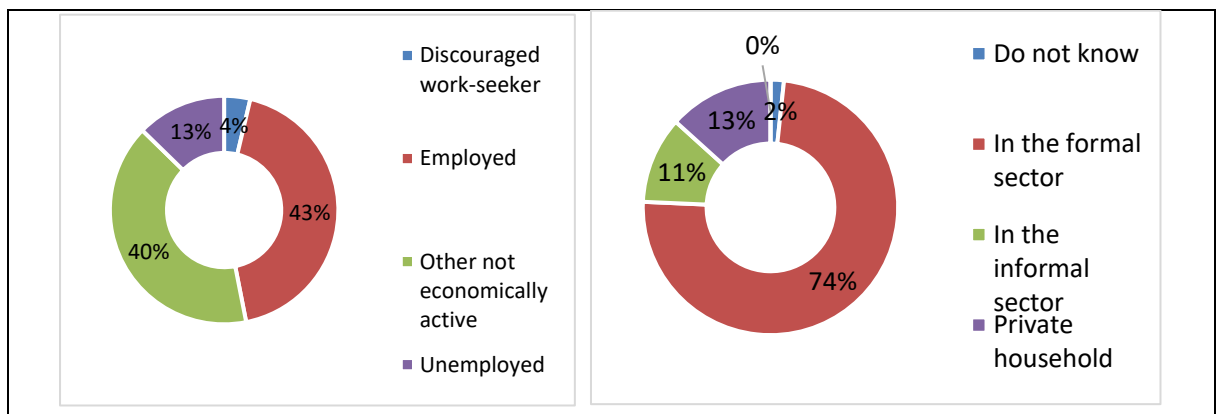

Figure 4-19: Employment status (left) and sectors (right) in the JB Marks LM in 2011

Source: (Wazimap, 2022e)

Housing is a basic human need and influences health, welfare and economic productivity. It is also an indicator of the standard of living. Only 71% of households in the JB Marks LM reside in formal dwellings (houses and apartments), while the remainder live in informal dwellings (16% in shacks and 8% in backyard flats). Access to services varies across the JB Marks LM but is generally poorer in the rural areas.

4.2.4 Local Economy

The economy of the JB Marks LM is dominated by agriculture in the northern parts and services and manufacturing in the southern parts (Batho Earth & SED, 2020). The services sector is the largest

³¹ The HDI quantifies the extent of human development of a community and is a “measure of people’s ability to live long and healthy lives, to communicate, to participate in the life of the community and to have sufficient resources to make a decent living” (NWP, 2013, p. 34).

³² The Poverty Gap Index estimates the depth of poverty by considering how far, on the average, the poor are from that poverty line. The Poverty Gap Index is a percentage between 0% and 100%. Individuals whose income is above the poverty line have a gap of zero while individuals whose income is below the poverty line would have a gap ranging from 1% to 100% (with a theoretical value of 100% implying that the individual earns zero income). An overall value of zero implies that no one in the population is below the poverty line, while an overall value of 100% implies that everyone in the population earns zero income. A higher poverty gap index thus means that poverty is more severe.

contributor to the JB Marks LM, primarily due to the presence of the North West University in Potchefstroom as well as other governmental and private services (Figure 4-20).

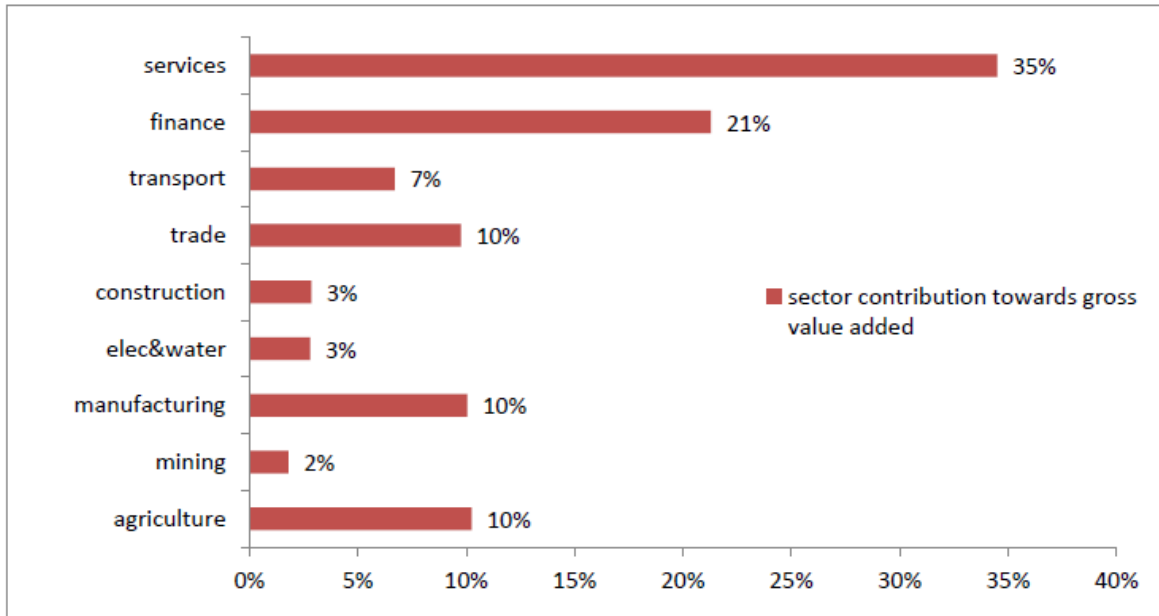

Figure 4-20: Economic structure of the JB Marks Municipality in 2017

Source: (Batho Earth & SED, 2020)

In 2020, the COVID-19 pandemic and associated domestic lockdowns placed the already contracting national economy under severe economic strain, and the national economy contracted by an unprecedented 51% in the second quarter of 2020 (Western Cape Provincial Treasury, 2020b). Ultimately national GDP contracted 6.4% in 2020, with the North West Province experiencing a larger contraction at 8%. Economic growth remained subdued nationally in 2021 with the persistence of the COVID-19 pandemic and outbreak of widespread rioting and looting of industries in parts of the country in July 2021.

4.2.5 Education

Schooling levels in the JB Marks LM have improved slightly since 2011. A higher percentage of learners in the LM completed matric compared to the District and Province (Figure 4-21). While the overall percentage of the JB Marks population who completed matric and tertiary studies has increased between 2011 and 2016, the proportion of the population that has no schooling decreased (from 9.2% in 2011 to 8.9% in 2016), although very slowly. Although concerning, lower levels of formal education can be anticipated in largely rural communities.

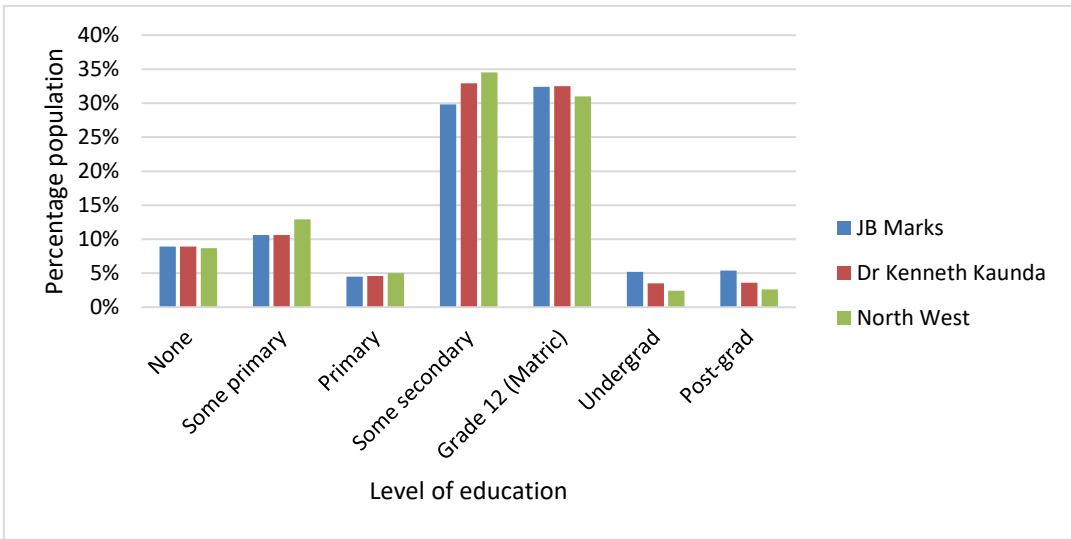

Figure 4-21: JB Marks LM, district and provincial education for 2016³³

Source: (Wazimap, 2022c)

The DKKDM is serviced by four hospitals and 35 permanent Community Health Care facilities and Clinics (DKKDM, 2020a). The number of people living with Human Immunodeficiency Virus (HIV) in the North West increased significantly by 79% between 1996 and 2010 (NWP, 2013). Approximately 13% of the DKKDM population tested positive for HIV in 2019. A decrease in the number of deaths caused by tuberculosis was observed between 2011 and 2015 (from 14% to 9% of deaths in the district) (DKKDM, 2015) (DKKDM, 2020b). The DKKDM had seven quarantine sites for COVID-19 positive patients in 2020. By February 2022, 52 008 COVID-19 cases had been confirmed in the DKKDM (27% of provincial confirmed cases), and 1 951 COVID-19 deaths had been recorded (41% of provincial COVID-19 deaths) (North West Department of Health, 2022).

4.3 Historical and Cultural Environment

4.3.1 Palaeontology, Archaeology and Historical Record

The proposed project lies in the southwestern part of the Transvaal Basin where the dolomites of the Malmani Group are exposed (Section 4.1.1 and Figure 4-1). The Late Archaean to early Proterozoic Transvaal Supergroup is preserved in three structural basins on the Kaapvaal Craton (Eriksson, Altermann, & Hartzler, 2006) of which two are in South Africa – the Transvaal and Griqualand West Basins. The predominantly carbonaceous sediments are evidence of the increase in the atmosphere of oxygen produced by algal colony photosynthesis, the so-called Great Oxygen Event (ca 2.4 – 2.3 billion years ago) and precursor to an environment where diverse life forms could evolve. The Neoproterozoic Transvaal Supergroup in South Africa contains the well-preserved stromatolitic Campbellrand-Malmani carbonate platform (Griqualand West Basin – Transvaal Basin respectively), which was deposited in shallow seawater shortly before the Great Oxidation Event.

The Transvaal Supergroup comprises one of world’s earliest carbonate platform successions (Beukes, 1987) (Eriksson, Altermann, & Hartzler, 2006) (Zeh, Wilson, & Gerdes, 2020). Well preserved stromatolites that are evidence of the photosynthetic activity of blue green bacteria and green algae (Cyanobacteria) are found in some areas. These microbes formed colonies in warm, shallow seas and deposited layer upon layer of minerals, often in domes or columns. The minerals are predominantly calcium carbonate, calcium sulphate, magnesium carbonate and magnesium sulphate. Only very rarely are the bacteria and algae

³³ Data reflects education levels of individuals 20 years and older.

preserved, but the stromatolites are traces of their activity, hence called trace fossils. As these fossils are protected by legislation, the palaeosensitivity of the Malmani Subgroup is regarded as very high. No stromatolites were however recorded on the project area.

The archaeological record for the greater study area consists of the Stone Age and Iron Age. Various Stone Age artifacts are expected to be found, including Acheulean stone tools from the Early Stone Age, stone tools and tools with handles from the Middle Stone Age (MSA) and a more diverse variety of artifacts such as microlithic stone tools, ostrich eggshell beads and rock art from the Later Stone Age (LSA). Sites containing artifacts from the LSA in the open are poorly preserved and therefore less valuable than those found in caves or rock shelters. Since there are no caves in the study area, no Stone Age sites of significance are expected. Low density scatters of MSA artefacts that are of low significance have been recorded to the north and west of the study area (van der Walt J. , 2022a) (van der Walt J. , Heritage Impact Assessment of the Roan 2 PV Development, North West Province, 2022b) (van der Walt J. , 2022c) (van der Walt J. , 2022d). Due to the readily available quartzite found on the site, scatters of the MSA are expected for the study area.

The well-known rock art site of Bosworth that also included LSA artifacts (Mason, 1962) is located to the northwest but will not be affected by the proposed project. Other LSA sites in the larger geographical area are located north and west of Klerksdorp (e.g., (Bergh, 1999) (Wells, 1933) (Maggs, 1976) (White, 1977)). No artifacts from the LSA were found in the project area.

Few sites dating back to the Iron Age have been recorded in the greater study area, but no artifacts of this period have been found on the project area. An old cemetery is located outside Klerksdorp and southwest of the project area, relating to the Second Boer War (1898-1902). No human remains or artifacts dating to this period were found on site.

Remains of low-density scatters of Stone Age artefacts noted during the field survey, a burial site and historical structures are shown in Figure 4-22 and Figure 4-23 and listed in Table 4-6.

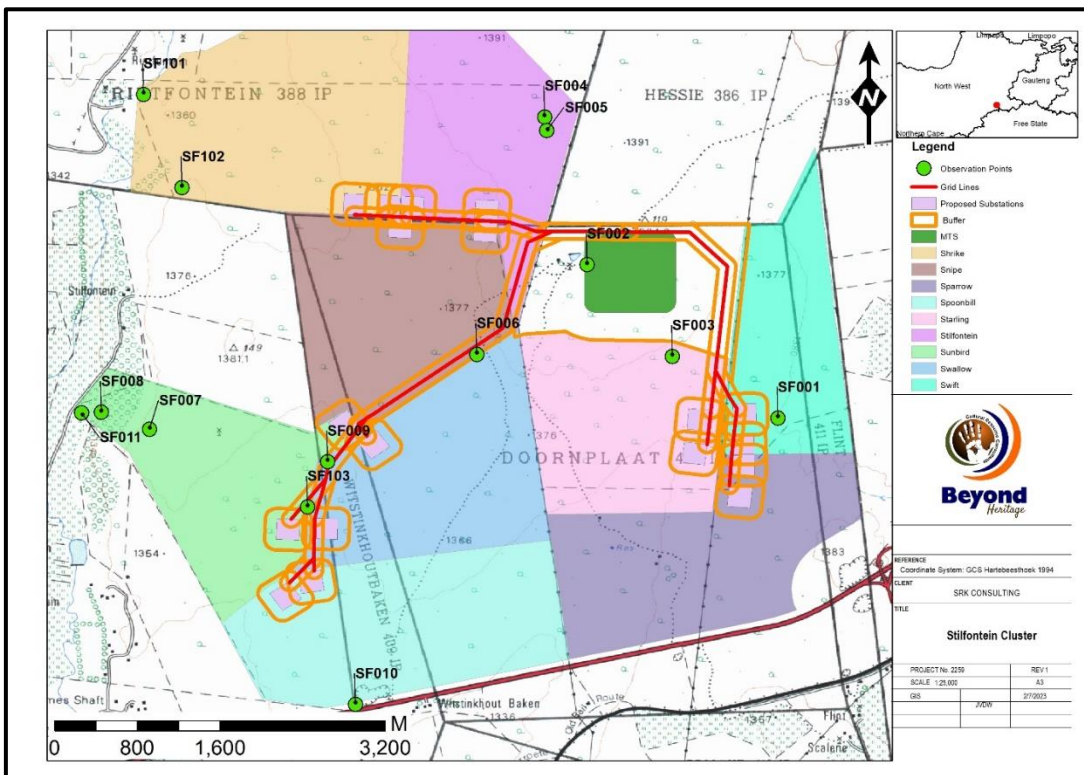

Figure 4-22: Location of heritage observations in the cumulative Stilfontein Cluster area

Source: (Beyond Heritage, 2022)

Table 4-6: Record of heritage observations in the cumulative Stilfontein Cluster area

ID	Description	Coordinates		Significance
		X	Y	
SF001	Low density MSA scatter	26,88707	-2978065	GP C, Low Significance
SF002	Low density MSA scatter	26,87045	-2976504	GP C, Low Significance
SF003	Low density MSA scatter	26,87787	-2977424	GP C, Low Significance
SF004	Isolated lithic Artefact	26,86674	-2975056	GP C, Low Significance
SF005	Isolated lithic artefact	26,86691	-2975189	GP C, Low Significance
SF006	Isolated Lithic artefact	26,86083	-2977327	GP C, Low Significance
SF007	Low density scatter	26,83232	-2977922	GP C, Low Significance
SF008	Historical Farmstead	26,82813	-2977737	GP C, Low Significance
SF009	Stone wall	26,84784	-2978306	GP C, Low Significance
SF010	A small stone-built structure	26,85027	-2980666	GP C, Low Significance
SF011	Burial site	26,82642	-2977736	GP A, High Significance
SF101	Ruin foundation	26,83182	-26,7627	GP C, Low Significance
SF102	Ruin	26,83516	-26,7708	GP C, Low Significance
SF103	Stone and cement platform	26,8461	-26,7987	GP C, Low Significance

Source: (Beyond Heritage, 2022)

4.3.2 Cultural Landscape

The study area is in a rural setting and characterised by cultivation and agricultural activities with a historical layering consisting of Stone Age sites with modern infrastructure elements that are limited to agricultural infrastructure, remnants of mining activity, powerlines and gravel roads.



Ventral view of chert lithics at SF001



Isolated artefact at SF004



Isolated artefact at SF004

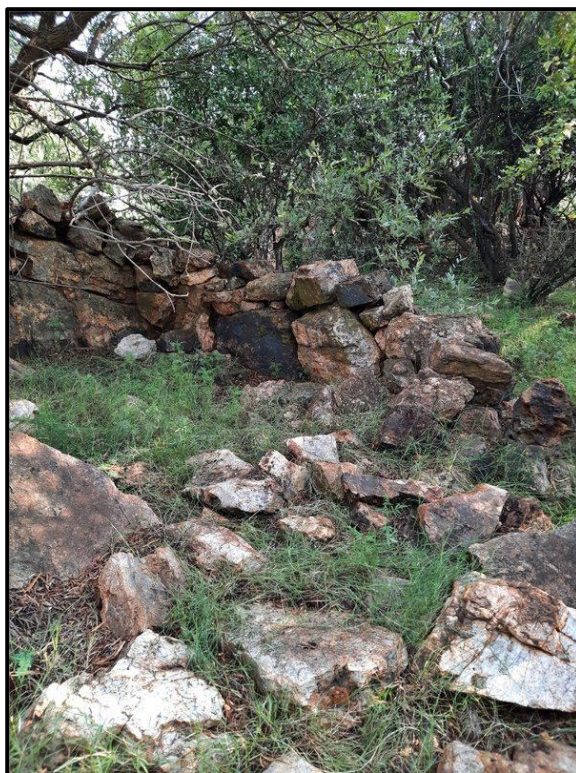

Stone packed enclosure at SF009

Figure 4-23: Photos of heritage observations in the cumulative Stilfontein Cluster area

Sources: (Beyond Heritage, 2022)

4.4 Visual and Aesthetic Environment

4.4.1 Visual Character

The visual character of the project area is determined by the topography, vegetation and land use of the area, which is predominantly a rural environment characterised by the undulating, vegetated landscape, albeit with large pockets of settlements and mining activity. Harsh, man-made structures and landforms introduced by mining dominate the landscape to the south-west of the Stilfontein Cluster. The rolling expanse of vegetated landscape to the north and east of the Stilfontein Cluster further evokes the natural, rural environment. The project area can therefore be defined as a modified rural landscape as it is mostly rural but settlements, mining activities and busy roads and railways are visible in the landscape.

The expansive and somewhat unspectacular landscape is further characterised by tailings dams and overburden stockpiles to the southwest, ranging from ~15 m to ~30 m in height, evidence past and present mining activity in the surrounding area.

4.4.2 Visual Quality

The visual quality of the area is largely experienced through rolling views of the undulating landscape, especially from and across the project area. The visual quality of the project area is defined by the fabric of developed settlements and infrastructure surrounded by agricultural and mining activity. Some elements surrounding the proposed project area detract from the visual quality in the area, notably the exposed, unvegetated tailings dams and overburden stockpiles. Streams and rivers add to the visual quality of the project area.

4.4.3 Sense of Place

The region has scenic value in terms of its undulating natural landscape and views over large portions of agricultural land and – within the project site – fairly pristine if undramatic grasslands and treescapes, reminiscent of African savannah landscapes (preserved in the nearby [proposed] Highveld National Park). The natural landscape and rustic character contrast with evidence of anthropogenic influence in the region, viz. mining, dense urban fabric and industry. To the north of the project area, visual-spatial quality is informed by the rural character of the area (farmsteads, smallholdings, rolling hills), while to the south it is informed by industrial and peri-urban textures (residential areas, mines and industrial areas).

The sense of place of the surrounding area is strongly influenced by the surrounding land use, which can generally be described as a rural mining area.

The relationship of receptors in the study area (Section 4.4.4) to place may be predominantly biographical and dependent. A family, for example, who has lived or worked in Klerksdorp or Stilfontein for a few generations will have a biographical and dependent attachment to the area.

4.4.4 Visual Receptors

The Stilfontein Cluster is located across seven farms that neighbour farms to the north, east and west and abut the N12 national highway to the south (Figure 1-2). Beyond the N12 to the south and southeast are the settlements of Khuma and Stilfontein and various industrial and mining areas.

Visual receptors have been identified based on surrounding land uses. The visual receptors are briefly described below and linked to viewpoints (VP) indicated in Figure 4-24):

- *Residents* (VP2 – VP3, VP6 – VP8, VP11 – VP13): The residential areas of Stilfontein and Khuma are located to the southwest of the PV Facilities. Isolated farmsteads are interspersed throughout the area surrounding the PV Facilities in all directions, but especially to the east and west.

- **Recreational (VP8 - VP10):** The Frontier Shooting Range (VP 8), Camp Louico (VP9) and Khora Lion Park (VP10) are located to the west of the sites.
- **Motorists (VP1 - VP5, VP7 – VP8, VP15 – VP18):** Three roads are located in close proximity, to the east, south and west of the sites. To the east is an unnamed street (hereafter referred to as Road East). The N12 national dual-carriage way is situated to the south of the site. Vermaasdrift Road extends north - south, to the west of the project site.

Landowners and occupiers (tenants) of the seven farms are considered as receptors; however, they have reached a negotiated agreement with Mainstream and will receive financial remuneration in compensation for development on their properties. As such, they are not deemed to be sensitive receptors.

4.4.5 Viewing Distance and Visibility

The visibility of the project can be summarised as follows:

- The project will be highly visible in the foreground and middle ground to motorists on the N12 (VP5, VP16 and VP17);
- The project will largely be screened by topography and vegetation, and, therefore, will be marginally visible to receptors located some distance away (VP1) and to the south (VP4, VP6 and VP15), west (VP9) and north (VP10 – VP13); and
- The project will not be visible from the east (VP2 and VP3), far south (VP14) and west (VP7 and VP8) due to topography.

Overall, the visibility of the project is moderate due to its high visibility to transient motorists on the N12, and marginal visibility to highly sensitive receptors (e.g. residents).

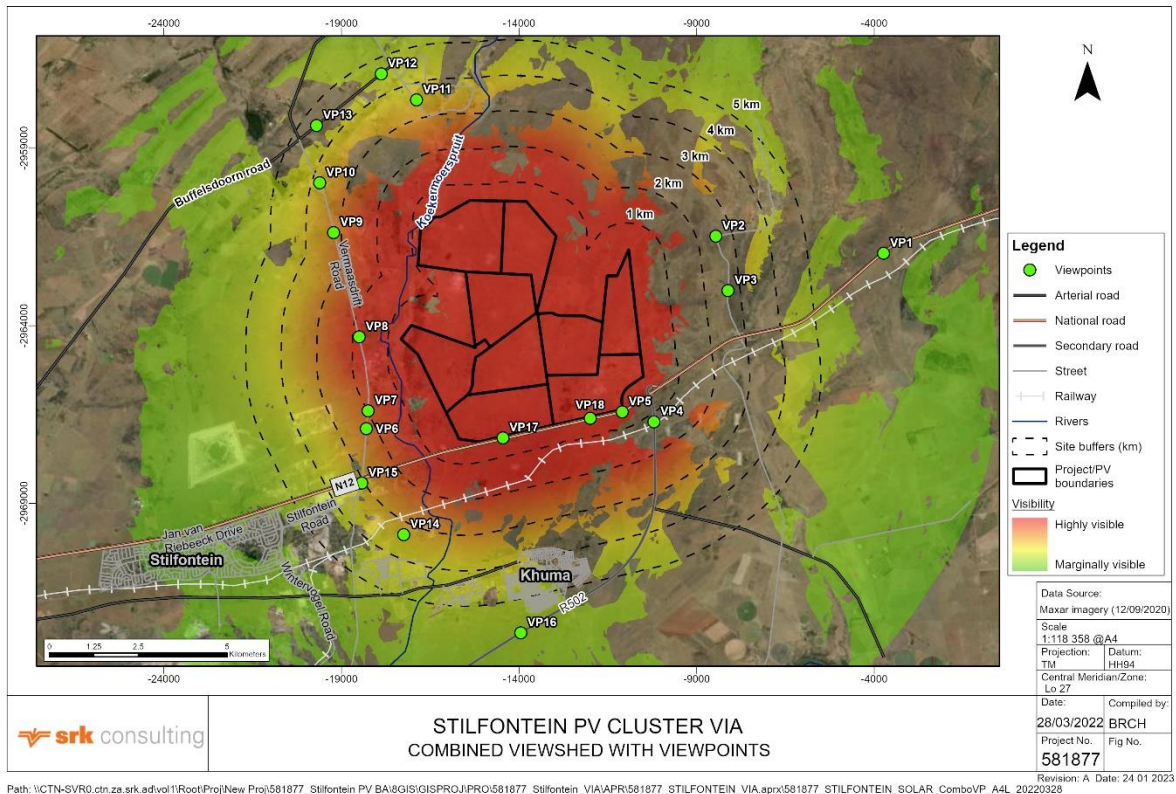

Figure 4-24: Combined viewshed with viewpoints in the Stilfontein Cluster

Source: (SRK Consulting, 2022a)

4.5 Regional Renewable Energy Sector

The North West Province has a lower potential for renewable energy projects than other areas of South Africa, due to lower solar (see Figure 3-11) and wind energy (see Figure 4-25) resources. As such, it has not received as much interest from renewable energy companies as some other provinces (see Figure 4-26). However, the solar energy resource is of high quality and the area may become increasingly attractive as it has spare grid capacity to evacuate renewable energy, while none is currently available in some other areas, e.g. Northern Cape.

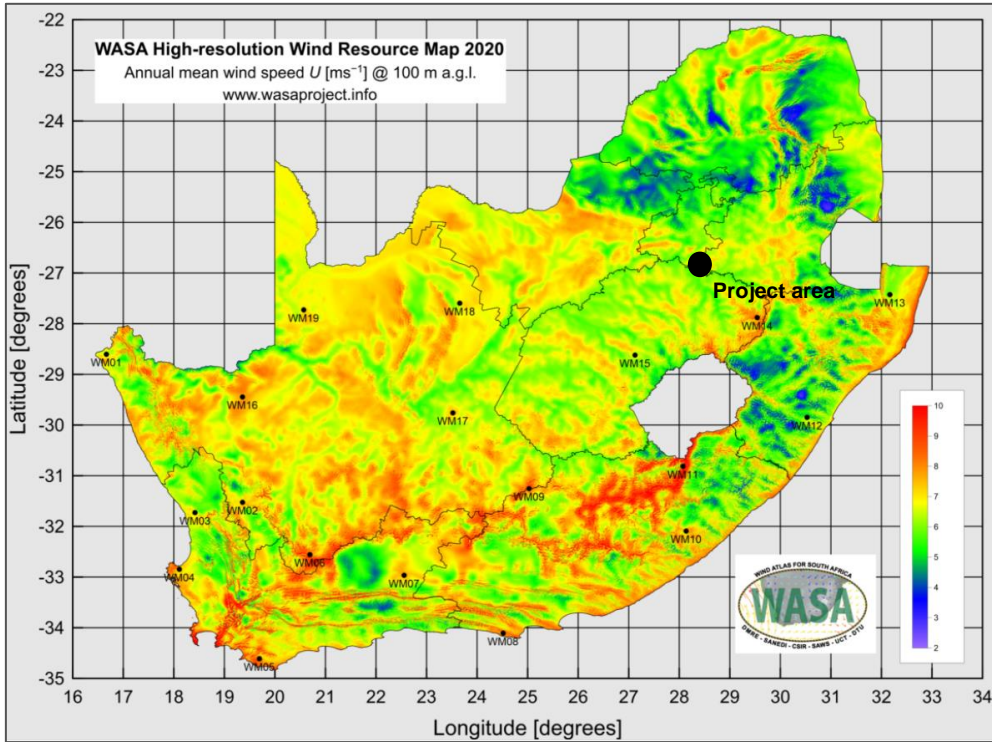

Figure 4-25: Diab’s wind atlas (left) and Hagemann’s wind atlas (right)

Source: (WASA, 2020)

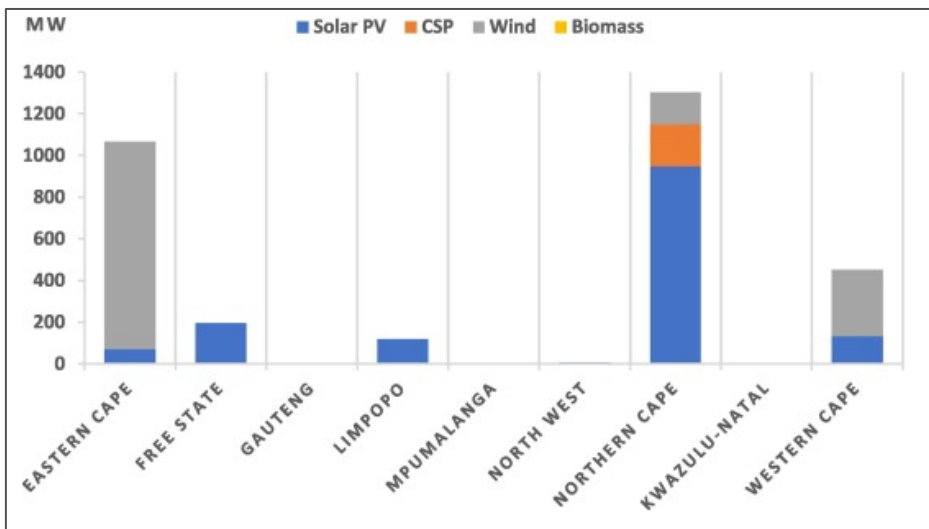

Figure 4-26: Distribution of renewable energy production in South African (2020)

Source: (Akinbami, Oke, & Bodunrin, 2021)

Four renewable energy projects were awarded in the North West during the 2018 REIPPPP Bid Window 4: Waterloo (75 MW) near Vryburg, Zeerust (75 MW) near Zeerust, Bokomaso (68 MW) near Rustenburg and

De Wildt (50 MW) near Brits, all of which were operational as of early 2021 (DMRE, n.d.). These projects contribute(d) to local employment (mostly during construction) and development of communities within a 50 km radius through investment in SED projects and Enterprise Development (ED) (Waterloo Solar, n.d.), (De Wildt Solar, n.d.). None of these are located in the DKKDM.

Although several solar farms in the Klerksdorp REDZ received EA in the past (see Table 4-7, Figure 4-26 and Figure 4-27) none have established, and the project area has not yet benefitted from renewable energy projects. The Klerksdorp REDZ was declared in 2020 during the second REDZ designation round, in a specific attempt to generate a renewables industry near coal and gold mining towns to begin the process of just transition, i.e. where the poor and working class are not left behind in an energy transition process (Creamer T. , 2020).

Table 4-7: Renewable energy projects under consideration in the project area

<u>Project</u>	<u>DFFE Reference</u>	<u>Capacity</u>	<u>EA Status</u>
<u>Noko Solar Power Plant</u>	<u>14/12/16/3/3/1/2474</u>	<u>20 MW</u>	<u>Approved</u>
<u>Nyarhi Solar Power Plant</u>	<u>14/12/16/3/3/1/2533</u>	<u>100 MW</u>	<u>Approved</u>
<u>YMS Tlokwe Photovoltaic Power Plant</u>	<u>12/12/20/2/122</u>	<u>5 MW</u>	<u>Approved</u>
<u>Kabi Witkop Solar 1 PV facility</u>	<u>12/12/20/2507/1</u>	<u>75 MW</u>	<u>In process</u>
<u>Kabi Vaalkop Photovoltaic Facility</u>	<u>12/12/20/2513/1</u>	<u>75 MW</u>	<u>Approved</u>
<u>Kabi Vaalkop Photovoltaic Facility</u>	<u>12/12/20/2513/2</u>	<u>75 MW</u>	<u>Approved</u>
<u>Kabi Vaalkop Photovoltaic Facility</u>	<u>12/12/20/2513/3</u>	<u>75 MW</u>	<u>Approved</u>
<u>YMS Mineral Resources PV Plant</u>	<u>12/12/20/2629</u>	<u>20 MW</u>	<u>Approved</u>
<u>Paleso Solar PV</u>	<u>14/12/16/3/3/1/2365</u>	<u>150 MW</u>	<u>Approved</u>
<u>Siyanda Solar PV</u>	<u>14/12/16/3/3/2/1/2369</u>	<u>150 MW</u>	<u>Approved</u>
<u>Buffels Solar PV 1</u>	<u>14/12/16/3/3/2/777</u>	<u>75 MW</u>	<u>Approved</u>
<u>Buffels Solar PV2</u>	<u>14/12/16/3/3/2/778</u>	<u>100 MW</u>	<u>Approved</u>
<u>Orkney PV SEF</u>	<u>14/12/16/3/3/2/954</u>	<u>100 MW</u>	<u>Approved</u>
<u>Vaal River Solar 3 PV facility</u>	<u>12/12/20/2513/3/AM6</u>	<u>250 MW</u>	<u>Approved</u>
<u>Buffels solar energy facility</u>	<u>14/12/16/3/3/2/777/AM2</u>	<u>75 MW</u>	<u>Approved</u>
<u>Orkney PV solar energy facility</u>	<u>14/12/16/3/3/2/954/AM1</u>	<u>100 MW</u>	<u>Approved</u>
<u>Witkop Solar PV II facility</u>	<u>12/12/20/2507/2</u>	<u>61 MW</u>	<u>In process</u>
<u>Roan 1 solar PV facility</u>	<u>14/12/16/3/3/1/2539</u>	<u>120 MW</u>	<u>To Review</u>
<u>Roan 2 solar PV facility</u>	<u>14/12/16/3/3/1/2540</u>	<u>120 MW</u>	<u>Approved</u>
<u>Doornhoek 1 PV facility</u>	<u>14/12/16/3/3/1/2548</u>	<u>115 MW</u>	<u>Approved</u>
<u>Doornhoek 2 PV facility</u>	<u>14/12/16/3/3/1/2549</u>	<u>50 MW</u>	<u>Approved</u>

Source: (DFFE, 2023) DFFE Q1 2023 REEA database

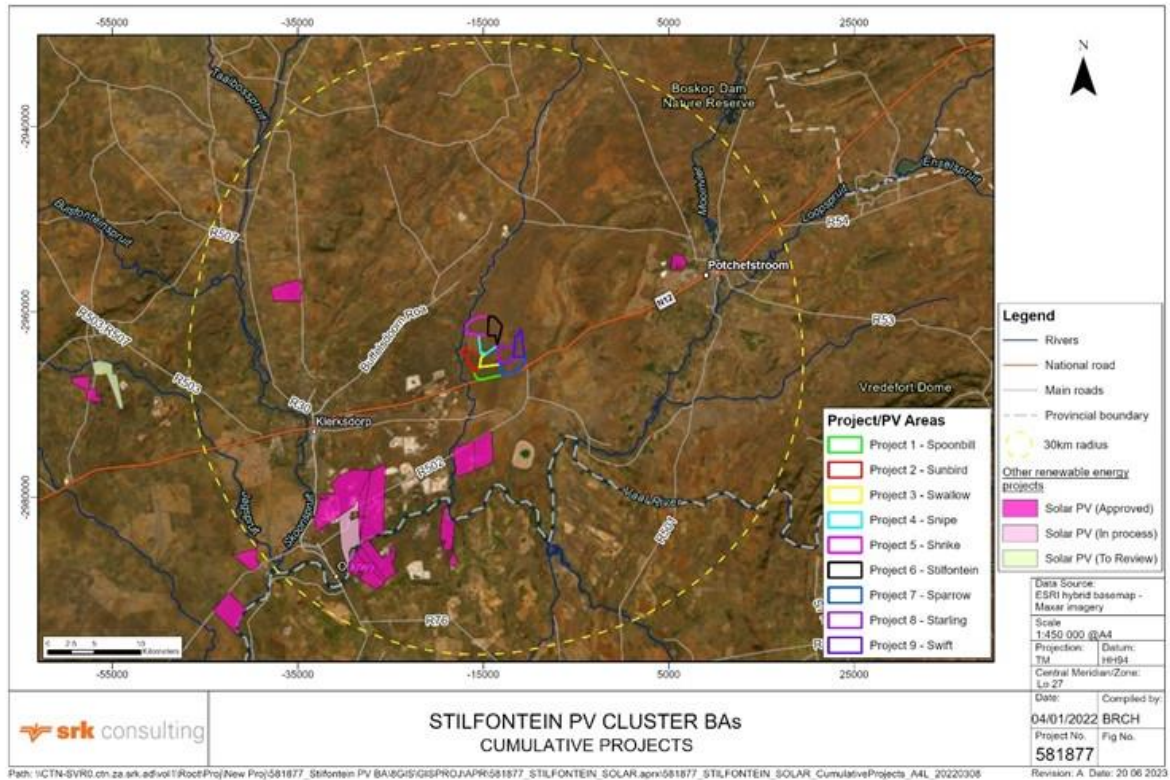

Figure 4-27: Renewable energy projects under consideration in the project area

Sources: (DFFE, 2023)

5 Stakeholder Engagement

Stakeholder engagement forms a key component of the BA process. The objectives of stakeholder engagement are outlined in this section, followed by a summary of the approach followed in compliance with Chapter 6 of the EIA Regulations, 2014 and any issues raised by the public with regard to the proposed project during the Pre-Application Phase.

*As of 1 July 2021, sections of the Protection of Personal Information Act 4 of 2013 (POPIA), which aims to promote protection of personal information, came into effect. The EIA Regulations, 2014 require, inter alia, transparent disclosure of registered stakeholders and their comments. In terms of the EIA Regulations, 2014, stakeholders who submit comments, attend a meeting or request registration in writing are deemed registered stakeholders who must be added to the project’s Registered Stakeholder Database with their contact details. Therefore, **registered stakeholders are deemed to give their consent for relevant information (including name and contact details) to be processed and disclosed, in fulfilment of the requirements of the EIA Regulations, 2014 and the National Appeal Regulations, 2014.***

5.1 Objectives and Approach to Stakeholder Engagement

The overall aim of public consultation is to ensure that all stakeholders have adequate opportunity to provide input into the process and raise their comments and concerns. More specifically, the objectives of public consultation are to:

- Identify IAPs and inform them about the proposed development and BA process;
- Provide the public with the opportunity to participate effectively in the process and identify relevant issues and concerns;
- Coordinate cooperation between organs of state in the consideration of the assessment; and
- Provide the public with the opportunity to review documentation and assist in identifying mitigation and management options to address potential environmental issues.

5.2 Stakeholder Engagement during the Basic Assessment Process

Public participation is undertaken to raise public and authority awareness of the proposed project. Table 5-1 outlines stakeholder engagement activities that form part of the BA process.

Table 5-1: BA Process stakeholder engagement activities

Task	Objectives	Dates
Pre-application meeting with DFFE	To discuss the proposed approach of the BA processes, specialist studies and stakeholder engagement with the Competent Authority	21 February 2022
Place posters on-site	To notify stakeholders of the BA process, provide an initial description of the proposed project, and invite stakeholder registrations and initial comments.	19 May 2022
Advertise commencement of the BA processes for the projects		26 May 2022
1 st Public comment period	Stakeholder registration and initial comments.	26 May - 30 June 2022
At this stage, the project description was adjusted by Mainstream and the BA processes were temporarily put on hold. The stakeholder engagement process has been reinitiated as follows:		
Place updated posters on-site	To invite stakeholder registrations and to notify IAPs of the availability of the BAR for comment.	06 April 2023
Re-advertise commencement of the BA processes for the projects		13 April 2023

Task	Objectives	Dates
Notify stakeholders of the release of the BAR for public comment, and distribute Executive Summary		By 14 April 2023
Public comment period	To provide stakeholders with the opportunity to review and comment on the results of the impact assessment, and to obtain written comments from stakeholders on the BAR.	14 April to 16 May 2023
Compile Issues and Responses Summary and finalise BAR	To record and respond to all issues and concerns raised by stakeholders and to collate these comments in the Final BAR to inform DFFE's decision on whether to authorise the project.	<u>July 2023</u>

The key activities are described further below.

5.2.1 Identification of Key Stakeholders and IAPs

SRK made a concerted effort to identify various local, provincial and national authorities, local ratepayers' forums and surrounding landowners and occupants for inclusion in the project database. SRK also obtained the assistance of several local stakeholders who disseminated project notification in local resident communication groups.

Relevant authorities are automatically registered as IAPs. As specified in the EIA Regulations, 2014, all persons who submit written comments or request registration in writing were placed on the project register. The stakeholder database was updated throughout the BA process and currently includes 221 IAPs. To comply with POPIA, the full registered stakeholder database is not provided in, or attached to, reports made available in the public domain. However, the registered stakeholder database (including name and contact information) will need to be provided to the appellant(s) if the EA is appealed, and it may also need to be provided to other consultants if, for example, they are required to notify adjacent landowners of matters arising during project implementation or of the findings of an external audit report.

The registered stakeholder database is attached as Appendix C.1.

5.2.2 Newspaper Advertisements, Site Notices and Letter Drops

Several A2 site notices (in English) were placed at the Stilfontein Cluster project boundary and nearby areas accessible to the public. These notices included brief details of the proposed project and BA process and the contact details of the consultant (see Table 5-2). Proof of site notice placement is included in Appendix C.2.

A4 copies of the site notice were also placed on the community noticeboard at the Stilfontein Library and various other public access points (see Table 5-2). Proof of notice placement around Stilfontein is included in Appendix C.2.

Table 5-2: Site notices and posters placed near Stilfontein Cluster

Location of site notice placements	Coordinates
Stilfontein Library	26°50'42.43"S, 26°46'26.54"E
Along Vermaasdrift Road on Rietfontein RE/388 property boundary	26°45'54.37"S, 26°48'27.40"E
Corner of Vermaasdrift Road and Buffelsdoorn Road	26°44'20.96"S, 26°47'49.47"E
Corner of N12 and Vermaasdrift Road (MMC Motors)	26°49'29.94"S, 26°48'54.14"E
Along N12 on Witstinkhoutbaken 1/409 property boundary	26°48'55.88"S, 26°51'9.04"E

Location of site notice placements	Coordinates
Along N12 on Doornplaat RE/3/410 property boundary	26°48'37.64"S, 26°52'39.38"E

The site notice was also sent to two local stakeholders via email and WhatsApp for distribution in local resident communication groups. *Proof of this is provided in Appendix C.2.*

Newspaper advertisements announcing the commencement of the BA processes and inviting IAPs to register on the project database were placed in the local paper *Klerksdorp Record* (in Afrikaans and English) on 26 May 2022 to afford stakeholders additional time to register prior to the release of the BAR for comment. *Proof of advertisement placement is included in Appendix C.3.*

Forty-two *notification letters* were dropped with neighbours and communities within 2-5 km of the Stilfontein Cluster on 19 May 2022 at the locations shown in Table 5-3. Evidence is provided in *Appendix C.4*

Table 5-3: Letter drops near Stilfontein Cluster

Location	Number of letters dropped	Coordinates
West of Stilfontein Cluster	10	not recorded
West of Stilfontein Cluster	10	26°47'36.25"S, 26°49'13.23"E
West of Stilfontein Cluster, Frontier Shooting Range	1	26°47'35.84"S, 26°49' 6.03"E
Farm north of Stilfontein Cluster	2	26°44'20.66"S, 26°50'8.82"E
Doornplaat RE/4/410	1	26°48'50.61"S, 26°51'32.82"E
Doornplaat RE/3/410	1	26°48'37.43"S, 26°52'39.04"E
East of Stilfontein Cluster	1	26°49'54.92"S, 26°51'44.10"E
East of Stilfontein Cluster	1	26°46'57.10"S, 26°54'10.36"E
East of Stilfontein Cluster	1	26°45'51.38"S, 26°54'42.56"E
Stilfontein Library	14	26°50'42.43"S, 26°46'26.54"E

5.2.3 Comments Received During the Pre-Application Phase

Stakeholder comments were received prior to the release of the BAR through the following channels:

- Interviews with key stakeholders as part of the SIA (see Section 5 of the SIA in Appendix D.5); and
- Initial comments from stakeholders upon registering as IAPs for the project (see Issues and Responses Summary in Appendix B).

Broadly summarised:

- Landowners reported that the project is expected to have a positive impact on farmers as it provides an alternative income to offset declining farming income and productivity;
- The municipality / organisations representing local residents reported that the closure of mining operations has led to demand for new work opportunities, though renewable energy projects are unlikely to compensate fully for the loss of previous mining sector jobs;
- Stakeholders located near the project area reported that the development of a solar farm(s) in the project area is not expected to affect neighbouring businesses and that they are generally supportive of the project; and

- IAPs registering for the project welcomed future business opportunities for Small and Medium Enterprises in the area.

5.2.4 Notification of BAR for Public Comment

Subsequent to *the* initial stakeholder engagement process, the BA process was put on hold while the project description was refined by Mainstream. *The following was undertaken* to notify stakeholders of the recommencement of the process and the opportunity to comment on the Draft BAR:

- Site notices *were* placed on the site boundary and nearby areas accessible to the public including the community noticeboard at the Stilfontein Library and various other public access points (*see Appendix C.2*);
- An advertisement in the Klerksdorp Record (*in English and Afrikaans*) on 14 April 2023 (*Appendix C.3*),
- *A total of 60 notification letters were* dropped *at* neighbouring *properties/farms* and communities within close proximity of the Stilfontein Cluster (*see Appendix C.4*); *and*
- The *notification letter was* sent to two local stakeholders via email and WhatsApp for distribution in local resident communication groups (*see Appendix C.5*).

Registered stakeholders were notified of the release of the Draft BAR for public review. Notifications, including copies of the Executive Summary, were sent by email, sms, fax or post to all registered IAPs. *Proof of notification has been included in Appendix C.5.*

The report *was made* accessible as an electronic copy on SRK’s website www.srk.com (via the “Knowledge Centre” and then “Public Documents” links). Hard copies of *the* report *were placed* at the Stilfontein Library *for public review* and to authorities upon request.

Stakeholders *were* afforded a 30-day comment period, *ending on 16 May 2023*.

5.2.5 Issues and Concerns Raised by Registered Stakeholders during the Commenting Period on the Draft BAR

Comments received were incorporated into the Issues and Responses Summary which is appended to this report as Appendix C.7. Stakeholders who submitted written comments during the Draft BAR commenting period are listed in Table 5-4. All written comments received during the Draft BAR commenting period are included in Appendix C.6.

Table 5-4: Stakeholders who submitted written comments during the draft BAR commenting period

#	Stakeholder	Affiliation	Submission Format	Comment Received
<i>During the Pre-application Phase Requesting Registration</i>				
i.	<i>Friedemann Essrich</i>	<i>JB Marks Consumer & Ratepayers Association</i>	<i>Telephonic</i>	<i>3 May 2022</i>
ii.	<i>Teboho Lehola</i>	<i>TVL Enterprise Pty Ltd</i>	<i>Email</i>	<i>26 May 2022</i>
<i>During the Post-application Phase Requesting Comment Following Release of the Draft BA Report</i>				
iii.	<i>John Geeringh</i>	<i>Eskom Holdings SOC Ltd (Eskom)</i>	<i>Email</i>	<i>13 April 2023</i>
iv.	<i>Mamokete Mafumo</i>	<i>Eskom Transmission Land and Rights</i>	<i>Email</i>	<i>13 April 2023; 3 May 2023</i>
v.	<i>Malebo Motlounq</i>	<i>Rays Hope NPO</i>	<i>Email</i>	<i>16 April 2023; 16 May 2023</i>

vi.	<u>Kesaobaka Archibald Monnahela</u>	<u>Gizabo Holdings Pty Ltd</u>	<u>Email</u>	<u>17 April 2023</u>
vii.	<u>Carlo Geel</u>	<u>Harmony Gold Mining Company Limited</u>	<u>Online form</u>	<u>17 April 2023</u>
viii.	<u>Princess Ngobeni</u>	<u>Openserve – a Division of Telkom SA SOC Ltd</u>	<u>Email</u>	<u>18 April 2023</u>
ix.	<u>Gopolang Moeketsane</u>	<u>Openserve – a Division of Telkom SA SOC Ltd</u>	<u>Email</u>	<u>25 April 2023</u>
x.	<u>Friedemann Essrich</u>	<u>JB Marks Consumer & Ratepayers Association</u>	<u>Email</u>	<u>15 May 2023</u>
xi.	<u>Hendrick Mongale</u>	<u>Nearby landowner and business owner</u>	<u>Email</u>	<u>7 May 2023</u>
xii.	<u>Lunga Dlova</u>	<u>Department of Forestry, Fisheries and the Environment (DFFE): Integrated Environmental Authorisations</u>	<u>Email</u>	<u>8 May 2023; 10 May 2023</u>
xiii.	<u>Wayne Hector</u>	<u>DFFE: Integrated Environmental Authorisations</u>	<u>Email</u>	<u>9 May 2023; 15 May 2023</u>
xiv.	<u>Matlhodi Mogorosi</u>	<u>DFFE: Integrated Environmental Authorisations</u>	<u>Email</u>	<u>12 May 2023</u>
xv.	<u>Coenrad Agenbach</u>	<u>DFFE: Integrated Environmental Authorisations</u>	<u>Email</u>	<u>15 May 2023</u>
xvi.	<u>Nyiko Nkosi</u>	<u>DFFE: Integrated Environmental Authorisations</u>	<u>Email</u>	<u>12 May 2023</u>
xvii.	<u>Mohammed Dambha</u>	<u>City of Matlosana Local Municipality</u>	<u>Email</u>	<u>16 May 2023</u>
xviii.	<u>Ntombi Rikhotso</u>	<u>JB Marks Local Municipality, Environmental Management Unit</u>	<u>Email</u>	<u>16 May 2023</u>
xix.	<u>MMatlala Rabothata</u>	<u>DFFE: Biodiversity and Conservation</u>	<u>Email</u>	<u>25 May 2023</u>
xx.	<u>Sityhilelo Ngcatsha</u>	<u>South African Heritage Resource Agency (SAHRA)</u>	<u>Email</u>	<u>29 May 2023</u>
xxi.	<u>Sam Ralston</u>	<u>Birdlife SA</u>	<u>Email</u>	<u>7 June 2023</u>

Key comments and concerns raised by stakeholders can be summarised as follows:

- **Impacts to water resources:** Prevent groundwater and surface water pollution;
- **Terrestrial biodiversity impact:** Compile a Fire Management Plan;
- **Terrestrial biodiversity impact:** The DFFE Directorate Biodiversity Conservation Directorate does not support the development since the identified degraded habitats, mostly within ESA1 areas were assigned High Site Ecological Importance (SEI) by the specialist. The degraded habitat was assigned to have a high functional integrity and low receptor resilience and the habitat is unlikely to be able to recover fully after a relatively long period;
- **Avifauna impact:** BirdLife noted that the associated powerlines (to be submitted as separate EA applications) will pose a bigger risk to the White-backed vulture than the PV facility itself and therefore Eskom's bird-friendly requirements must be implemented for the grid infrastructure projects;
- **Socio-economic benefits:** The project is anticipated to empower and develop SMMEs and create jobs;
- **Heritage impact:** Avoid no go areas specified in the heritage impact assessment, where applicable, employ an ECO to monitor construction and implement a chance finds procedure should heritage resources be found;
- **Eskom's requirements:** Eskom's requirements for works at or near Eskom infrastructure and servitudes, as well as a setbacks guideline for renewable energy developments, must adhered to;
- **Openserve approval:** The proposed powerlines are approved, and conditions of approval provided in terms of Section 22 of the Electronic Communications Act 36 of 2005;
- **Geotechnical considerations:** The area experiences mine-induced seismic activity;

- **Effective stakeholder engagement:** *Consult with affected communities, landowners, people who have land claims and engage with the local municipality in terms of service capacity for general waste disposal and potable water supply;*
- **Decommissioning planning:** *Plan for the ultimate disposal of hazardous waste/ material e.g., batteries and solar panels;*
- **Safety and security impacts:** *Ensure effective security arrangements since illegal mining activities take place in the area;*
- **Dust impact:** *Ensure effective dust mitigation since the community is sensitive to dust impacts;*
- **Land use applications:** *Apply for rezoning and servitude registrations;*
- **Technical and design detail:** *More specific layout information as described in the Draft BAR be shown on a map and technical details, including various co-ordinates, to be provided in a summary table;*
- **Mapping:** *Provide layout and sensitivity mapping showing key infrastructure components as described in the Draft BAR, including buffer areas and no-go areas; and*
- **Cumulative impact assessment:** *Similar projects within a 30km radius must be assessed.*

5.2.6 Next Steps

Following the close of the comment period on the Draft BAR, issues raised by authorities and the public have been included and responded to in an Issues and Responses Summary, which is appended as Appendix C.7. This BAR has been updated, where necessary, taking stakeholder input into account. The Final BAR will be submitted to the DFFE for decision making. Registered IAPs will be informed of the submission of the Final BAR and provided with the Issues and Responses Summary.

6 Environmental Impact Assessment

6.1 Introduction

6.1.1 Environmental Impacts Identified

Based on the professional experience of the EIA team, legal requirements (Section 2), the nature of the proposed activity (Section 3), the nature of the receiving environment (Section 4) and issues raised in the stakeholder comments during the pre-application phase (Section 5), the following key environmental issues – potential negative impacts and potential benefits – were identified:

- **Freshwater ecology** – potential loss of wetlands associated with bulk earthworks during construction;
- **Terrestrial ecology** – potential loss of faunal and floral habitat and species associated with construction and operation of the project;
- **Avifauna** – Mortality and disturbance of birds due to construction and operation of the project;
- **Land capability** – loss or sterilisation of arable soils associated with construction and operation of the project;
- **Socio-economic** – potential socio-economic benefits and impacts to the wider community in the form of job creation, investment, community ownership and nuisance factors during construction; and
- **Heritage and palaeontology** – potential destruction of significant heritage resources associated with bulk earthworks during construction;
- **Visual** – potential loss of visual quality and sense of place associated with project components; and
- **Traffic** – trip generation during the construction phase.

6.1.2 Specialist Studies Undertaken

The Screening Tool (see Section 2.1.1.2) indicated specialist assessments to be considered by the EAP for inclusion in the BA. SRK has evaluated the proposed studies and commissioned most specialist studies listed in the Screening Tool, as shown in Table 6-1.

The specialist studies (see Table 4-1 and Table 6-1) were undertaken to investigate the key potential direct, indirect and cumulative impacts (negative and positive) listed in Section 6.1.1. Sections 6.2 to 6.8 provide a summary of the findings and impact management measures identified in the specialist reports.

Table 6-1: Specialist studies proposed in the DFFE Screening Tool

Specialist study proposed in Screening Tool	Specialist report appendix / SRK comment
Aquatic biodiversity IA	Appendix D.1: Freshwater study
Animal species IA	Appendix D.2: Terrestrial ecology study
Plant species IA	
Terrestrial biodiversity IA	
Avian IA	Appendix D.3: Avifauna study
Agricultural IA	Appendix D.4: Soil and land capability study
Socio-economic IA	Appendix D.5: Socio-economic study

Specialist study proposed in Screening Tool	Specialist report appendix / SRK comment
Archaeological and cultural heritage IA Palaeontology IA	Appendix D.6: Heritage and palaeontology study
Landscape / Visual IA	Appendix D.7: Visual study
Geotechnical IA	<u><i>A preliminary Geotechnical Desktop Study has been undertaken for Stilfontein Solar Photovoltaic Cluster) to determine geotechnical feasibility. Mainstream will undertake a more detailed geotechnical assessment, as may be required, during detailed design phase.</i></u>
Civil Aviation IA	The sensitivity of the project area was deemed low <u><i>in DFFE's Screening Tool Report</i></u> with regards to civil aviation. No major civil aviation aerodromes are located near the project area. <u><i>SACAA were notified of the project and provided with the opportunity to comment on the DBAR. No comment was received by SACAA.</i></u>
Defence Assessment	The sensitivity of the project area was deemed low <u><i>in DFFE's Screening Tool Report</i></u> with regards to defence. <u><i>SANDAF were notified of the project and provided with the opportunity to comment on the DBAR. No comment was received by SANDAF.</i></u>
RFI Assessment	The sensitivity of the project area was deemed low <u><i>in DFFE's Screening Tool Report</i></u> with regards to RFI. <u><i>Several telecommunication service providers in the region were notified of the project and provided with the opportunity to comment on the DBAR. Comment was received by Openseve, a Division of Telkom SA SOC Ltd. Openseve provided approval in terms of section 22 of the Electronic Communications Act 36 of 2005.</i></u>

6.1.3 Alternatives Assessed in the EIA

During the prefeasibility phase of most projects various development alternatives are investigated. Furthermore, the EIA Regulations, 2014 require that all BA processes must identify and describe “alternatives to the proposed activity that are feasible and reasonable”. Depending on the specific project circumstances various alternatives may be considered.

Various alternatives were considered during the initial screening and feasibility phases of this project, some of which were eliminated for technical reasons (refer to Section 3.5). The alternatives assessed in Sections 6.2 to 6.8 are listed in Table 3-1.

6.1.4 Impact Rating Methodology

The assessment of impacts was based on specialists’ expertise, SRK’s professional judgement, field observations and desk-top analysis.

The significance of potential impacts that may result from the proposed project was determined in order to assist decision-makers (typically by a designated competent authority or state agency, but in some instances, the applicant).

The **significance** of an impact is defined as a combination of the **consequence** of the impact occurring and the **probability** that the impact will occur.

The criteria used to determine impact consequence are presented in the table below.

Table 6-2: Criteria used to determine the consequence of the impact

Rating	Definition of Rating	Score
A. Extent– the area over which the impact will be experienced		
Local	Confined to project area (e.g. the development site and immediate surrounds)	1
Regional	The region (e.g. municipality or Quaternary catchment)	2
(Inter) national	Nationally or beyond	3
B. Intensity– the magnitude of the impact in relation to the sensitivity of the receiving environment, taking into account the degree to which the impact may cause irreplaceable loss of resources		
Low	Site-specific and wider natural and/or social functions and processes are negligibly altered	1
Medium	Site-specific and wider natural and/or social functions and processes continue albeit in a modified way	2
High	Site-specific and wider natural and/or social functions or processes are severely altered and/or irreplaceable resources ³⁴ are lost	3
C. Duration– the timeframe over which the impact will be experienced and its reversibility		
Short-term	Up to 2 years and reversible	1
Medium-term	2 to 15 years and reversible	2
Long-term	More than 15 years and irreversible	3

The combined score of these three criteria corresponds to a **Consequence Rating**, as follows:

Table 6-3: Method used to determine the consequence score

Combined Score (A+B+C)	3 – 4	5	6	7	8 – 9
Consequence Rating	Very low	Low	Medium	High	Very high

Once the consequence was derived, the probability of the impact occurring was considered, using the probability classifications presented in the table below.

Table 6-4: Probability classification

Probability– the likelihood of the impact occurring	
Improbable	< 40% chance of occurring
Possible	40% - 70% chance of occurring
Probable	> 70% - 90% chance of occurring
Definite	> 90% chance of occurring

The overall **significance** of impacts was determined by considering consequence and probability using the rating system prescribed in the table below.

³⁴ Defined as important cultural or biological resource which occur nowhere else, and for which there are no substitutes.

Table 6-5: Impact significance ratings

		Probability			
		Improbable	Possible	Probable	Definite
Consequence	Very Low	INSIGNIFICANT	INSIGNIFICANT	VERY LOW	VERY LOW
	Low	VERY LOW	VERY LOW	LOW	LOW
	Medium	LOW	LOW	MEDIUM	MEDIUM
	High	MEDIUM	MEDIUM	HIGH	HIGH
	Very High	HIGH	HIGH	VERY HIGH	VERY HIGH

Finally the impacts were also considered in terms of their status (positive or negative impact) and the confidence in the ascribed impact significance rating. The prescribed system for considering impacts status and confidence (in assessment) is laid out in the table below.

Table 6-6: Impact status and confidence classification

<i>Status of impact</i>	
Indication whether the impact is adverse (negative) or beneficial (positive).	+ ve (positive – a ‘benefit’) – ve (negative – a ‘cost’)
<i>Confidence of assessment</i>	
The degree of confidence in predictions based on available information, SRK’s judgment and/or specialist knowledge.	Low Medium High

The impact significance rating should be considered by authorities in their decision-making process based on the implications of ratings ascribed below:

INSIGNIFICANT: the potential impact is negligible and **will not** have an influence on the decision regarding the proposed activity/development.

VERY LOW: the potential impact is very small and **should not** have any meaningful influence on the decision regarding the proposed activity/development.

LOW: the potential impact **may not** have any meaningful influence on the decision regarding the proposed activity/development.

MEDIUM: the potential impact **should** influence the decision regarding the proposed activity/development.

HIGH: the potential impact **will** affect the decision regarding the proposed activity/development.

VERY HIGH: The proposed activity should only be approved under special circumstances.

6.2 Potential Soil and Land Capability Impacts

6.2.1 Introduction

The assessment is based on the Soil Specialist Study, which contains more detail (see Appendix D.4). The ToR for the study were to:

- Describe the soil characteristics in the project area;
- Classify the soil and land capability / potential and current land use;

- Identify and assess potential impacts of the project on soil and land capability;
- Recommend relevant mitigation measures; and
- Compile a Report compliant with Appendix 6 of the EIA Regulations (2014), relevant guidelines and/or the Environmental Assessment Protocols (GN R320 of 2020), as applicable.

All alternatives considered (see Table 3-1) do not affect the significance of soil and land capability impacts in the Construction and Operation Phases.

6.2.2 Assessment of Impacts: Construction Phase

Construction phase impacts on soil and land capability are assessed below.

6.2.2.1 Reduction and Loss of Land Capability

Construction activities such as vegetation clearing, excavations and vehicle movements will result in soil compaction and erosion, which decreases land capability. These decrease land capability, though soil resources are of low sensitivity and land capability is low.

The impact is assessed to be of **very low** significance with and without the implementation of mitigation.

Table 6-7: Significance of reduction and loss of land capability

	<i>Extent</i>	<i>Intensity</i>	<i>Duration</i>	<i>Consequence</i>	<i>Probability</i>	<i>Significance</i>	<i>Status</i>	<i>Confidence</i>
Without mitigation	Local	Medium	Short-term	Very Low	Probable	VERY LOW	– ve	High
	1	2	1	4				
Essential mitigation measures:								
<ul style="list-style-type: none"> • Compile and implement a Stormwater Management Plan. • Drive only on approved access roads to avoid unnecessary compaction. • Clear vegetation only once construction is imminent, to reduce cleared areas and minimise erosion risk. • Store and maintain topsoil as per best practice in order to utilise it for rehabilitation of eroded areas. • Implement the Alien Vegetation Management Plan. • Park equipment and vehicles on impermeable surfaces or utilise drip trays to prevent hydrocarbon spills and monitor daily for fluid leaks. • Remediate hydrocarbon spills immediately. • Report hydrocarbon spills to the appropriate authorities if significant contamination of the environment occurs. 								
With mitigation	Local	Medium	Short-term	Very Low	Probable	VERY LOW	– ve	High
	1	2	1	4				

6.2.3 Assessment of Impacts: Operational Phase

Operational phase impacts on soil and land capability are assessed below.

6.2.3.1 Reduction and Loss of Land Capability

Operational activities by operational and maintenance staff as well as vehicle movements and ongoing vegetation trimming and / or removal, may continue to result in further soil compaction and erosion. These decrease land capability, though soil resources are of low sensitivity and land capability is low.

The impact is assessed to be of **very low** significance with and without the implementation of mitigation.

Table 6-8: Significance of reduction and loss of land capability

	<i>Extent</i>	<i>Intensity</i>	<i>Duration</i>	<i>Consequence</i>	<i>Probability</i>	<i>Significance</i>	<i>Status</i>	<i>Confidence</i>
Without mitigation	Local	Low	Long-term	Low	Possible	VERY LOW	– ve	High
	1	1	3	5				
Essential mitigation measures:								
<ul style="list-style-type: none"> • Compile and implement a Stormwater Management Plan. • Drive only on approved access roads to avoid unnecessary compaction. • Park equipment and vehicles on impermeable surfaces or utilise drip trays to prevent hydrocarbon spills and monitor daily for fluid leaks. • Remediate hydrocarbon spills immediately. • Report hydrocarbon spills to the appropriate authorities if significant contamination of the environment occurs. • Implement the Alien Vegetation Management Plan. • Implement the Habitat Restoration Plan guided by the botanical specialist. 								
With mitigation	Local	Low	Long-term	Low	Possible	VERY LOW	– ve	High
	1	1	3	5				

6.2.4 Specialist Opinion

The specialist states that the proposed project will not result in the loss of high production arable land or the fragmentation of high productivity agricultural land uses. The specialist therefore recommends that the proposed project proceeds. Both substation alternatives are equally acceptable from a soil and agricultural perspective.

6.2.5 The No-Go Alternative

The No-Go alternative implies that the project is not implemented. In that case, the land use and land capability will not be affected, and grazing may continue on the entire site. As the specialist recommends that the project is approved, the No-Go alternative is not preferred.

6.3 Potential Freshwater Impacts

6.3.1 Introduction

The assessment is based on the Freshwater Specialist Study, which contains more detail (see Appendix D.1). The ToR for the study were to:

- Delineate, classify and assess freshwater features within 500 m of the project area;
- Identify and assessment project impacts on freshwater features;
- Recommend mitigation measures; and
- Compile an impact assessment report compliant with Appendix 6 of the EIA Regulations (2014), relevant guidelines and/or the Environmental Assessment Protocols (GN R320 of 2020), as applicable.

All alternatives considered (see Table 3-1) do not affect the significance of freshwater impacts in the Construction and Operation Phases.

6.3.2 Assessment of Impacts: Construction Phase

Construction phase impacts on the freshwater environment are assessed below.

6.3.2.1 Degradation and Loss of Wetlands

No impacts to wetlands are expected to occur due to the project during the construction phase. Both substation alternatives are equally acceptable from a wetland and freshwater perspective. No fatal flaws are expected for the project.

6.3.3 Assessment of Impacts: Operational Phase

The project will not result in any impacts on the freshwater environment during the operational phase.

6.3.4 Specialist Opinion

The specialist has assessed that the residual impact posed by the project on the wetlands is deemed very low, and confirmed that the project is thus deemed acceptable. It is expected that a General Authorisation in terms of NWA Section 21(c) and (i) water uses will be required prior to project construction.

Both substation alternatives are equally acceptable from a wetland and freshwater perspective.

6.3.5 The No-Go Alternative

The No-Go alternative implies that the project is not implemented, and the assessed impacts on wetlands will not be incurred. As the specialist assessed that project impacts are acceptable, the No-Go alternative is not preferred.

6.4 Potential Terrestrial Ecology Impacts

6.4.1 Introduction

The assessment is based on the Terrestrial Ecology Specialist Study, which contains more detail (see Appendix D.2). The ToR for the study were to:

- Undertake a desktop assessment of available terrestrial (fauna and flora) ecology datasets;
- Undertake a field survey for fauna (mammals, reptiles and amphibians) and flora, preferably during the rainy season between October and April;
- For fauna, compile expected and identified species list, identify Red Data or listed species and assess and delineate habitat and proximity to any protected or ecologically important areas;
- Determine and evaluate the status of the faunal environment in terms of ecological indicators, important biodiversity attributes (such as rare and endangered species, protected species, sensitive species and endemic species);
- Determine Red and Orange Data plant species, vegetation units and habitat types and discuss protected, endemic, exotic, alien invasive and culturally significant species. Consult local authorities;
- Discuss fauna in relation to floristic survey findings and consider the probability of occurrence for species not observed during field surveys, with a focus on protected and endemic species;
- Identify and delineate habitats and any unique or protected habitat features and sensitive habitats;
- Assess the significance of biodiversity impacts;
- Identify mitigation measures for the reduction of the significance of negative impacts (and enhancement of benefits) and re-rate the impact significance assuming the effective implementation of mitigation measures; and

- Compile a Report compliant with Appendix 6 of the EIA Regulations (2014), relevant guidelines and/or the Environmental Assessment Protocols (GN R320 of 2020), as applicable.

6.4.2 Assessment of Impacts: Construction Phase

Construction phase impacts on terrestrial ecology are assessed below. The assessment considers both solar panel technology alternatives (see Section 3.6.3.2), which in respect to terrestrial ecology impacts differ as follows:

- Panel Technology One (monofacial panels): vegetative (grass) ground cover will be retained, while shrubs and trees will be removed; and
- Panel Technology One (bifacial panels): vegetative (grass) ground cover will be removed and white gravel will be placed underneath panels.

Other alternatives considered do not affect the significance of terrestrial ecology impacts.

Substation alternative locations considered (see Table 3-1) do not affect the significance of terrestrial ecology impacts in the Construction and Operation Phases.

6.4.2.1 Degradation and Loss of Habitat and Protected Species³⁵

During construction, for Panel Technology One, vegetation will be trimmed and larger bushes and trees removed in the area where solar arrays will be established. For Panel Technology Two, vegetation will be cleared in most of the project footprint. Vegetation will also be cleared and some soil stripped in areas where infrastructure and associated facilities are established, e.g. access roads, BESS, IPP-side on-site substation, administrative buildings and laydown area.

The removal of vegetation reduces the extent of and fragments habitat and ecosystems. Soil stripping also removes the seedbank in the affected area, and the exposed areas are more susceptible to wind and water erosion.

As vegetation clearance is more extensive for Panel Technology Two, the impact of degradation and loss of habitat and ecosystems is higher.

Both substation alternatives are equally acceptable from a terrestrial ecology perspective.

The impact for Panel Technology One is assessed to be of **low** significance and with the implementation of mitigation is reduced to **very low**.

Table 6-9: Significance of potential degradation and loss of habitat and protected species – Panel Technology One

	<i>Extent</i>	<i>Intensity</i>	<i>Duration</i>	<i>Consequence</i>	<i>Probability</i>	<i>Significance</i>	<i>Status</i>	<i>Confidence</i>
Without mitigation	Local	Medium	Medium-term	Low	Definite	LOW	– ve	High
	1	2	2	5				
Essential mitigation measures:								
<ul style="list-style-type: none"> • Demarcate the construction footprint with visible barriers (i.e. safety tape / fencing and signage). • <u>Demarcate the high rocky ridges as No-Go area for Construction.</u> • Restrict vegetation clearing to the minimum required and do not clear vegetation outside of the development footprint. • Clear vegetation by hand cutting to avoid heavy machinery, as far as practically possible. 								

³⁵ This impact incorporates the impact of degradation of terrestrial ecology due to dust generation, which had been assessed separately by the specialist.

	<i>Extent</i>	<i>Intensity</i>	<i>Duration</i>	<i>Consequence</i>	<i>Probability</i>	<i>Significance</i>	<i>Status</i>	<i>Confidence</i>
<ul style="list-style-type: none"> • Limit construction of new roads as much as possible. • Avoid land clearing and disturbance of rocky habitats. • Minimise the number (and size) of laydown, storage and staff facilities. • Remove all remaining construction materials once the construction phase ends. • Store topsoil stockpiles on flat ground and use bunds and/or other stabilisation methods (e.g., netting) to avoid erosion. • Obtain relocation or destruction permits before any protected trees (<i>Vachellia erioloba</i>) are relocated or destroyed. • Compile and implement a Hydrocarbon Spill Management Plan; • Compile and implement a Fire Management Plan. • Appoint a rehabilitation specialist to develop and implement a Habitat Rehabilitation Plan from the onset of the project. • Rehabilitate areas as soon as they are no longer impacted by construction. • Utilise indigenous vegetation only for habitat rehabilitation. • Return topsoil as soon as possible. • Apply surplus topsoil / rehabilitation material to other areas in need of stabilisation and vegetation cover. • Implement strict dust control for all roads and bare (unvegetated) areas. • Reduce dust generated by vehicles and earth moving machinery, through wetting the soil surface (with non-potable water) and erecting speed limit signage to enforce speed limits. • Prohibit the use of non-environmentally friendly dust suppressants to avoid pollution of water sources. 								
With mitigation	Local	Low	Short-term	Very low	Definite	VERY LOW	– ve	High
	1	1	1	3				

The impact for Panel Technology Two is assessed to be of **high** significance and with the implementation of mitigation is reduced to **medium**.

Table 6-10: Significance of potential degradation and loss of habitat and protected species – Panel Technology Two

	<i>Extent</i>	<i>Intensity</i>	<i>Duration</i>	<i>Consequence</i>	<i>Probability</i>	<i>Significance</i>	<i>Status</i>	<i>Confidence</i>
Without mitigation	Local	High	Long-term	High	Definite	HIGH	– ve	High
	1	3	3	7				
Essential mitigation measures: As per Table 6-9.								
With mitigation	Local	Medium	Long-term	Medium	Definite	MEDIUM	– ve	High
	1	2	3	6				

6.4.2.2 Spread of Alien and Invasive Species

The disturbance of vegetation and soils and the movement of construction staff and vehicles onto and across the site increases the potential for alien and invasive vegetation to establish. This can exacerbate the degradation and loss of habitats and ecosystems on the site.

The impact for Panel Technology One is assessed to be of **very low** significance with and without the implementation of mitigation.

Table 6-11: Significance of spread of alien and invasive species – Panel Technology One

	<i>Extent</i>	<i>Intensity</i>	<i>Duration</i>	<i>Consequence</i>	<i>Probability</i>	<i>Significance</i>	<i>Status</i>	<i>Confidence</i>
Without mitigation	Local	Low	Medium-term	Very low	Probable	VERY LOW	– ve	Medium
	1	1	2	4				
Essential mitigation measures:								

	<i>Extent</i>	<i>Intensity</i>	<i>Duration</i>	<i>Consequence</i>	<i>Probability</i>	<i>Significance</i>	<i>Status</i>	<i>Confidence</i>
	<ul style="list-style-type: none"> • Compile and implement an Alien Vegetation Management Plan, including but not limited to identification of areas for action (if any), prescription of the necessary removal methods and frequencies, monitoring plan and requirements for updates. • Compile and implement a Waste Management Plan to: <ul style="list-style-type: none"> ○ Prioritize waste management such that all waste is collected, stored and disposed of adequately. ○ Collect and dispose of all waste generated on site, at least on a weekly basis, to prevent rodents and pests. ○ Ensure waste storage bins have lids and are secured to prevent falling over. ○ Compile and implement a pest control plan that does not include the use of poison as a control measure. 							
With mitigation	Local	Low	Short-term	Very low	Probable	VERY LOW	– ve	High
	1	1	1	3				

As vegetation clearance is more extensive for Panel Technology Two, the potential for establishment of alien and invasive vegetation along the periphery of cleared areas is higher.

The impact for Panel Technology Two is assessed to be of **low** significance and with the implementation of mitigation is reduced to **very low**.

Table 6-12: Significance of spread of alien and invasive species – Panel Technology Two

	<i>Extent</i>	<i>Intensity</i>	<i>Duration</i>	<i>Consequence</i>	<i>Probability</i>	<i>Significance</i>	<i>Status</i>	<i>Confidence</i>
Without mitigation	Local	Medium	Medium-term	Low	Probable	LOW	– ve	Medium
	1	2	2	5				
Essential mitigation measures:								
<ul style="list-style-type: none"> • As per Table 6-11 								
With mitigation	Local	Low	Short-term	Very low	Probable	VERY LOW	– ve	High
	1	1	1	3				

6.4.2.3 Displacement and Loss of Fauna

The removal of vegetation will result in the loss of habitat, forcing fauna to move into adjacent areas. Fauna will also move from the site due to increased disturbance from construction activities, such as noise, dust, vibration and human activity. This could result in overpopulation of adjacent habitats and increased competition for natural resources, which may cause further disruption to faunal populations by interfering with their movement and/or breeding.

Direct mortalities or potential injury could result from collisions with construction vehicles in the area. Increased traffic due to construction vehicles will increase the likelihood of collisions with fauna. Increased human presence on the site could also increase poaching.

The introduction of new diseases and feral species such as cats and dogs to the area is unlikely due to the proximity of the project area to adjacent settlements and nearby homesteads.

As vegetation clearance is more extensive for Panel Technology Two, the extent of displacement and potential mortality of fauna is greater.

The impact for Panel Technology One is assessed to be of **very low** significance with and without the implementation of mitigation.

Table 6-13: Significance of displacement and loss of fauna – Panel Technology One

	<i>Extent</i>	<i>Intensity</i>	<i>Duration</i>	<i>Consequence</i>	<i>Probability</i>	<i>Significance</i>	<i>Status</i>	<i>Confidence</i>
Without mitigation	Local	Medium	Short-term	Very low	Probable	VERY LOW	– ve	Medium
	1	2	1	4				
Essential mitigation measures:								
<ul style="list-style-type: none"> • Demarcate the construction footprint with visible barriers (i.e. safety tape / fencing and signage). • Restrict vegetation clearing to the minimum required and do not clear vegetation outside of the development footprint. • Areas should be cleared and disturbed only as and when needed. • Minimise the time between clearing of an area and subsequent development to avoid fauna from re-entering the site to be disturbed. • Flush sites (one or two persons walking the area) prior to vegetation clearing activities to encourage fauna to move off site (not more than one day in advance of clearing). • Restrict construction activities to as few discrete areas as possible, allowing fauna to move off site as activities progress. • Excavate holes / excavations on a needs only basis. • Cover open holes / excavations overnight to prevent fauna mortalities. • Provide environmental awareness training to all personnel and contractors regarding: <ul style="list-style-type: none"> ○ Sensitive environmental receptors within the project area; ○ Management requirements in the Environmental Authorisation and the EMPr; ○ How to deal with any fauna species encountered during the construction process; • Obtain permits for the relocation of animals during construction as and if required. 								
With mitigation	Local	Low	Short-term	Very low	Probable	VERY LOW	– ve	Medium
	1	1	1	3				

The impact for Panel Technology Two is assessed to be of **medium** significance and with the implementation of mitigation is reduced to **very low**.

Table 6-14: Significance of displacement and loss of fauna – Panel Technology Two

	<i>Extent</i>	<i>Intensity</i>	<i>Duration</i>	<i>Consequence</i>	<i>Probability</i>	<i>Significance</i>	<i>Status</i>	<i>Confidence</i>
Without mitigation	Regional	Medium	Medium-term	Medium	Probable	MEDIUM	– ve	Medium
	2	2	2	6				
Essential mitigation measures:								
<ul style="list-style-type: none"> • As per Table 6-13 								
With mitigation	Local	Low	Medium-term	Very low	Probable	VERY LOW	– ve	High
	1	1	2	4				

6.4.3 Assessment of Impacts: Operational Phase

Operation phase impacts on terrestrial ecology are assessed below. The assessment considers both solar panel technology alternatives (see Section 3.6.3.2), which in respect to terrestrial ecology impacts differ as follows:

- Panel Technology One (monofacial panels): vegetative (grass) ground cover will be retained, while shrubs and trees will be removed; and
- Panel Technology One (bifacial panels): vegetative (grass) ground cover will be removed and white gravel will be placed underneath panels.

Other alternatives considered (including location of substations) do not affect the significance of terrestrial ecology impacts.

6.4.3.1 Degradation and Fragmentation of Habitat

Vegetation will continue to be trimmed (Panel Technology One) or removed (Panel Technology Two) underneath the solar arrays during the lifetime of the project. This will continue to affect habitat quality and connectivity, and more so for Panel Technology Two.

Natural areas adjacent to solar arrays, servitudes and associated infrastructure and facilities areas may experience degradation through dust deposition (which reduces the effectiveness of photosynthesis and pollination). Any unrehabilitated areas may also present sources of dust.

As vegetation clearance is more extensive for Panel Technology Two, the extent of habitat fragmentation is greater. Gravel placed underneath the solar arrays for Panel Technology Two should mitigate dust generation.

The impact for Panel Technology One is assessed to be of **very low** significance with and without the implementation of mitigation.

Table 6-15: Significance of degradation and fragmentation of habitat – Panel Technology One

	Extent	Intensity	Duration	Consequence	Probability	Significance	Status	Confidence
Without mitigation	Local	Low	Medium-term	Very low	Probable	VERY LOW	– ve	Medium
	1	1	2	4				
Essential mitigation measures:								
<ul style="list-style-type: none"> Prohibit staff from bringing or removing any plant species (whether indigenous or exotic) to or from the project site to prevent the spread of exotic or invasive species or the illegal collection of plants. Implement the Alien Vegetation Management Plan. 								
With mitigation	Local	Low	Medium-term	Very low	Probable	VERY LOW	– ve	Medium
	1	1	2	4				

The impact for Panel Technology Two is assessed to be of **low** significance and with the implementation of mitigation is reduced to **very low**.

Table 6-16: Significance of degradation and fragmentation of habitat – Panel Technology Two

	Extent	Intensity	Duration	Consequence	Probability	Significance	Status	Confidence
Without mitigation	Local	Medium	Medium-term	Low	Probable	LOW	– ve	Medium
	1	2	2	5				
Essential mitigation measures:								
<ul style="list-style-type: none"> As per Table 6-16 								
With mitigation	Local	Low	Short-term	Very low	Probable	VERY LOW	– ve	High
	1	1	1	3				

6.4.3.2 Spread of Alien and Invasive Species

The movement of operations and maintenance staff and vehicles across the site may introduce or spread alien and invasive vegetation, though movement and disturbance will be much reduced compared to the construction phase. Alien vegetation will deteriorate habitat quality.

As vegetation clearance is more extensive for Panel Technology Two, the potential for establishment of alien and invasive vegetation in or along the periphery of cleared areas is higher.

The impact for Panel Technology One is assessed to be of **very low** significance with and without the implementation of mitigation.

Table 6-17: Significance of spread of alien and invasive species – Panel Technology One

	Extent	Intensity	Duration	Consequence	Probability	Significance	Status	Confidence
Without mitigation	Local	Low	Medium-term	Very low	Probable	VERY LOW	– ve	Medium
	1	1	2	4				
Essential mitigation measures:								
<ul style="list-style-type: none"> Implement the Alien Vegetation Management Plan. Implement the Waste Management Plan. 								
With mitigation	Local	Low	Short-term	Very low	Probable	VERY LOW	– ve	High
	1	1	1	3				

The impact for Panel Technology Two is assessed to be of **low** significance and with the implementation of mitigation is reduced to **very low**.

Table 6-18: Significance of spread of alien and invasive species – Panel Technology Two

	Extent	Intensity	Duration	Consequence	Probability	Significance	Status	Confidence
Without mitigation	Local	Medium	Medium-term	Low	Probable	LOW	– ve	Medium
	1	2	2	5				
Essential mitigation measures:								
<ul style="list-style-type: none"> As per Table 6-17 								
With mitigation	Local	Low	Short-term	Very low	Probable	VERY LOW	– ve	High
	1	1	1	3				

6.4.3.3 Displacement and Loss of Fauna

Though disturbance on the site, such as noise, dust, vibration and human activity, will be much reduced compared to construction activities, it will lead to some ongoing disruption and displacement of fauna. Similarly, staff and vehicle movements are much reduced compared to the construction phase, but collisions of fauna with vehicles as well as poaching can result in fauna mortalities or injury.

As vegetation clearance is more extensive for Panel Technology Two, the extent of displacement of fauna is greater.

The impact for Panel Technology One is assessed to be of **very low** significance with and without the implementation of mitigation.

Table 6-19: Significance of displacement and loss of fauna – Panel Technology One

	Extent	Intensity	Duration	Consequence	Probability	Significance	Status	Confidence
Without mitigation	Local	Low	Medium-term	Very low	Probable	VERY LOW	– ve	Medium
	1	1	2	4				
Essential mitigation measures:								
<ul style="list-style-type: none"> Design outside lighting to limit impacts on fauna. <ul style="list-style-type: none"> Fit lighting fixtures with baffles, hoods or louvres and directed light downward. Direct outside lighting away from sensitive areas such as the wetland. Avoid fluorescent and mercury vapor lighting. 								

	Extent	Intensity	Duration	Consequence	Probability	Significance	Status	Confidence
<ul style="list-style-type: none"> ○ Utilise sodium vapor (yellow) lights wherever possible. ○ Utilise motion detection lighting wherever possible to minimise the unnecessary illumination of areas. ● Minimise traffic during the night. ● Minimise noise from dusk to dawn to reduce disturbance of amphibian species and nocturnal mammals. ● Obtain permits for the relocation of animals as and if required. 								
With mitigation	Local	Low	Short-term	Very low	Probable	VERY LOW	– ve	Medium
	1	1	1	3				

The impact for Panel Technology Two is assessed to be of **low** significance and with the implementation of mitigation is reduced to **very low**.

Table 6-20: Significance of displacement and loss of fauna – Panel Technology Two

	Extent	Intensity	Duration	Consequence	Probability	Significance	Status	Confidence
Without mitigation	Local	Medium	Medium-term	Low	Probable	LOW	– ve	Medium
	1	2	2	5				
Essential mitigation measures:								
<ul style="list-style-type: none"> ● As per Table 6-19 								
With mitigation	Local	Low	Short-term	Very low	Probable	VERY LOW	– ve	High
	1	1	1	3				

6.4.4 Assessment of Impacts: Decommissioning Phase

Decommissioning phase impacts on terrestrial ecology are assessed below. The assessment considers both solar panel technology alternatives (see Section 3.6.3.2), which in respect to terrestrial ecology impacts differ as follows:

- Panel Technology One (monofacial panels): vegetative (grass) ground cover will be retained, while shrubs and trees will be removed; and
- Panel Technology One (bifacial panels): vegetative (grass) ground cover will be removed and white gravel will be placed underneath panels.

Other alternatives considered (including substation locations) do not affect the significance of terrestrial ecology impacts.

6.4.4.1 Degradation and Fragmentation of Habitat

Operational phase impacts will persist until all infrastructure has been removed and the affected areas have been rehabilitated. As vegetation clearance is more extensive for Panel Technology Two, rehabilitation effort must be significantly more intense to achieve an acceptable residual impact.

Though the impact assessment provided below rates the impact of unavoidable site disturbance during the decommissioning phase, effective rehabilitation will re-create suitable habitat for fauna, allowing fauna to re-establish over time. As such, the ultimate outcome of rehabilitation, to be undertaken during and after decommissioning, will be a benefit.

The impact for Panel Technology One is assessed to be of **very low** significance with and without the implementation of mitigation.

Table 6-21: Significance of degradation and fragmentation of habitat – Panel Technology One

	<i>Extent</i>	<i>Intensity</i>	<i>Duration</i>	<i>Consequence</i>	<i>Probability</i>	<i>Significance</i>	<i>Status</i>	<i>Confidence</i>
Without mitigation	Local	Low	Medium-term	Very low	Probable	VERY LOW	– ve	Medium
	1	1	2	4				
Essential mitigation measures:								
<ul style="list-style-type: none"> • Confine closure and rehabilitation activities to the disturbed footprint areas only. • Declare all areas outside of the disturbed footprint as ‘no-go’ areas. • Avoid access to previously undisturbed or already rehabilitated areas. • Reduce dust generated by vehicles and earth moving machinery through wetting the soil surface (with non-potable water) and erecting speed limit signage. • Implement the Habitat Rehabilitation Plan. • Utilise indigenous vegetation for habitat rehabilitation. • Implement the Alien Vegetation Management Plan. 								
With mitigation	Local	Low	Short-term	Very low	Probable	VERY LOW	– ve	Medium
	1	1	1	3				

The impact for Panel Technology Two is assessed to be of **low** significance and with the implementation of mitigation is reduced to **very low**.

Table 6-22: Significance of degradation and fragmentation of habitat – Panel Technology Two

	<i>Extent</i>	<i>Intensity</i>	<i>Duration</i>	<i>Consequence</i>	<i>Probability</i>	<i>Significance</i>	<i>Status</i>	<i>Confidence</i>
Without mitigation	Local	Medium	Medium-term	Low	Probable	LOW	– ve	Medium
	1	2	2	5				
Essential mitigation measures:								
<ul style="list-style-type: none"> • As per Table 6-21 								
With mitigation	Local	Low	Short-term	Very low	Probable	VERY LOW	– ve	High
	1	1	1	3				

6.4.4.2 Spread of Alien and Invasive Species

The movement of decommissioning staff and vehicles across the site may introduce or spread alien and invasive vegetation. Denuded areas following the removal of infrastructure are at particular risk of being invaded by alien and invasive vegetation. Effective rehabilitation with indigenous vegetation is required to mitigate the risk long-term.

As vegetation clearance is more extensive for Panel Technology Two, the risk of alien vegetation establishment is higher and rehabilitation effort must be significantly more intense to achieve an acceptable residual impact.

The impact for Panel Technology One is assessed to be of **very low** significance and with the implementation of mitigation is reduced to **insignificant**.

Table 6-23: Significance of spread of alien and invasive species – Panel Technology One

	<i>Extent</i>	<i>Intensity</i>	<i>Duration</i>	<i>Consequence</i>	<i>Probability</i>	<i>Significance</i>	<i>Status</i>	<i>Confidence</i>
Without mitigation	Local	Low	Medium-term	Very low	Probable	VERY LOW	– ve	Medium
	1	1	2	4				
Essential mitigation measures:								

	<i>Extent</i>	<i>Intensity</i>	<i>Duration</i>	<i>Consequence</i>	<i>Probability</i>	<i>Significance</i>	<i>Status</i>	<i>Confidence</i>
<ul style="list-style-type: none"> Implement the Alien Vegetation Management Plan. Update the Alien Vegetation Management Plan to include estimated monitoring frequency post-closure and indicate when the plan no longer needs to be implemented, to be compliant with legislated requirements at the time. 								
With mitigation	Local	Low	Short-term	Very low	Possible	INSIGNIFICANT	– ve	Medium
	1	1	1	3				

The impact for Panel Technology Two is assessed to be of **low** significance and with the implementation of mitigation is reduced to **insignificant**.

Table 6-24: Significance of spread of alien and invasive species – Panel Technology Two

	<i>Extent</i>	<i>Intensity</i>	<i>Duration</i>	<i>Consequence</i>	<i>Probability</i>	<i>Significance</i>	<i>Status</i>	<i>Confidence</i>
Without mitigation	Local	Medium	Medium-term	Low	Probable	LOW	– ve	Medium
	1	2	2	5				
Essential mitigation measures:								
<ul style="list-style-type: none"> As per Table 6-23. 								
With mitigation	Local	Low	Short-term	Very low	Possible	INSIGNIFICANT	– ve	High
	1	1	1	3				

6.4.5 Specialist Opinion

The specialist has assessed that the project impacts can be effectively mitigated to an acceptable residual impact. Panel Technology One is preferred as it has lower residual impacts on terrestrial ecology. Panel Technology Two may also be considered but requires more intensive mitigation and management, notably related to dust suppression, alien vegetation control and rehabilitation.

Development within areas of high sensitivity is not regarded as a fatal flaw for the project and can be effectively mitigated. Substation Option 2 (southern option) is preferred, but substation Option 1 (northern option – Technically preferred alternative) is also acceptable. All mitigation measures must be implemented.

6.4.6 No-Go Alternative

The No-Go alternative implies that the project is not implemented, and the assessed impacts on terrestrial ecology will not be incurred. As the specialist concludes that the project impact is acceptable, the No-Go alternative is not preferred.

6.5 Potential Avifauna Impacts

6.5.1 Introduction

The assessment is based on the Avifauna Specialist Study, which contains more detail (see Appendix D.3). The ToR for the study were to:

- Describe the affected environment from an avifaunal perspective;
- Discuss gaps in baseline data and other limitations;
- Undertake field surveys;

- Compare the site sensitivity recorded in the field with the sensitivity classification in the DFFE National Screening Tool and adjust if necessary;
- Identify and assess the potential impacts of the proposed development on avifauna;
- Recommend appropriate mitigation measures; and
- Compile an impact assessment report; and
- Compile a Report compliant with Appendix 6 of the EIA Regulations (2014), relevant guidelines and/or the Environmental Assessment Protocols (GN R320 of 2020), as applicable.

All alternatives considered (see Table 3-1) do not affect the significance of avifauna impacts in the Construction and Operation Phases.

6.5.2 Assessment of Impacts: Construction Phase

Construction phase impacts on avifauna are assessed below.

6.5.2.1 Bird Displacement due to Disturbance

Construction is likely to impact on birds breeding, foraging and roosting at or near the development area through disturbance and transformation of habitat, which could result in temporary or permanent displacement of birds, including priority species such as Cape White-eye, Cloud Cisticola, Fiscal Flycatcher, Gabar Goshawk, Greater Kestrel, Karoo Thrush, Lanner Falcon, Pied Starling, Spotted Eagle-Owl and White-backed Vulture.

It is likely that avifauna will be temporarily displaced in the footprint area of the proposed project, either completely or more likely partially (reduced densities) during the construction phase, due to the disturbance associated with the construction activities. This is likely to affect breeding residents most.

The impact is assessed to be of **low** significance and with the implementation of mitigation is reduced to **very low**.

Table 6-25: Significance of potential bird displacement due to disturbance

	<i>Extent</i>	<i>Intensity</i>	<i>Duration</i>	<i>Consequence</i>	<i>Probability</i>	<i>Significance</i>	<i>Status</i>	<i>Confidence</i>
Without mitigation	Local	High	Short-term	Low	Definite	LOW	– ve	High
	1	3	1	5				
Essential mitigation measures:								
<ul style="list-style-type: none"> ● Restrict construction activities to the immediate development footprint. ● Minimise construction of new roads. ● Demarcate access roads clearly. ● Prohibit off-road driving. ● Undertake regular ECO audits / inspections to report on compliance with the EMPr (including compliance with noise control mechanisms). ● Include avifauna impacts of off-road driving in construction staff environmental awareness training. ● Implement best practice measures to control noise and dust. ● <u>Retain or relocate existing waterpoints to ensure at least four waterpoints are retained within the Stilfontein Project Cluster, one of which must be in the north west and one in the south east of the Cluster.</u> 								
With mitigation	Local	Medium	Short-term	Very low	Definite	VERY LOW	– ve	High
	1	2	1	4				

6.5.2.2 Bird Displacement due to Habitat Transformation

Visser *et al* (2019) found that bird density and bird diversity was higher in the boundary and untransformed landscape than in a solar development area, though the difference was not statistically significant. This indicates that the PV facility matrix is permeable to most species. However, the distribution of birds in the landscape changed, from a shrubland to open country and grassland bird community, in response to changes in the distribution and abundance of habitat resources such as food, water and nesting sites. Shrubland specialists appeared to be negatively affected by the presence of the PV facility, while open country/grassland and generalist species were favoured by solar development.

It is highly likely that habitat loss and transformation during the construction phase will lead to reduced avifaunal densities as per the pattern noted by Visser *et al* (2019), impacting shrubland species more. Priority species potentially affected are Cape White-eye, Cloud Cisticola, Fiscal Flycatcher, Gabar Goshawk, Greater Kestrel, Karoo Thrush, Lanner Falcon, Pied Starling, Spotted Eagle-Owl and White-backed Vulture. In addition, raptors and terrestrial species could also be impacted.

The impact is assessed to be of **high** significance and with the implementation of mitigation is reduced to **medium**.

Table 6-26: Significance of potential bird displacement due to habitat transformation

	<i>Extent</i>	<i>Intensity</i>	<i>Duration</i>	<i>Consequence</i>	<i>Probability</i>	<i>Significance</i>	<i>Status</i>	<i>Confidence</i>
Without mitigation	Local	High	Long-term	High	Probable	HIGH	– ve	Medium
	1	3	3	7				
Essential mitigation measures:								
<ul style="list-style-type: none"> • Restrict activities to the development footprint. • Implement best practice measures to control noise and dust. • Demarcate access roads clearly. • Prohibit off-road driving. • Minimise construction of new roads. • <u>Retain or relocate existing waterpoints to ensure at least four waterpoints are retained within the Stilfontein Project Cluster, one of which must be in the north west and one in the south east of the Cluster.</u> • Implement and strictly enforce the mitigation measures proposed by the botanical specialist. • Appoint a rehabilitation specialist to develop and implement a Habitat Rehabilitation Plan. • Conduct site inspections to monitor the progress of rehabilitation, as and when required based on specialist recommendations according to the Habitat Rehabilitation Plan. • Implement adaptive management to ensure vegetation rehabilitation goals are met. 								
With mitigation	Local	Medium	Long-term	Medium	Probable	MEDIUM	– ve	Medium
	1	2	3	6				

6.5.3 Assessment of Impacts: Operational Phase

Operational phase impacts on avifauna are assessed below.

6.5.3.1 Bird Mortality due to Collision with Solar Panels

Sheet glass used in commercial and residential buildings has been well established as a hazard for birds. Although very few cases have been reported it is possible that the reflective surfaces of solar panels could constitute a similar risk to avifauna. An extremely rare but potentially related problem is the so-called “lake effect” i.e. it seems possible that reflections from solar facilities' infrastructure, particularly large sheets of dark blue photovoltaic panels, may attract birds in flight across the open desert, who mistake the broad reflective surfaces for water. However, due to limited data it would be premature to make any general

conclusions about the influence of the lake effect or other factors that contribute to fatality of water-dependent birds.

Visser *et al* (2019), who studied bird mortality on a South African solar farm in the Northern Cape, concluded *inter alia* the few bird fatalities that were recorded might suggest that there is no significant collision-related mortality at the study site, though the short study period and lack of comparable results from other sources made it difficult to provide a meaningful assessment of avian mortality at PV facilities.

Based on the lack of evidence to the contrary, it is not foreseen that collisions with the solar panels at the PV facility will be a significant impact. The priority species which would most likely be affected by this impact are mostly small, ground-dwelling birds which forage between the solar panels, and a variety of waterbirds which may be at risk due to the “lake effect”. Priority species with a medium to high likelihood of occurrence in the assessment area are Blacksmith Lapwing, Cape White-eye, Cloud Cisticola, Fiscal Flycatcher, Karoo Thrush, Pied Starling and South African Cliff Swallow.

The impact is assessed to be of **very low** significance. No further mitigation is possible.

Table 6-27: Significance of potential bird mortality due to collision with solar panels

	<i>Extent</i>	<i>Intensity</i>	<i>Duration</i>	<i>Consequence</i>	<i>Probability</i>	<i>Significance</i>	<i>Status</i>	<i>Confidence</i>
Without mitigation	Local	Low	Long-term	Low	Possible	VERY LOW	– ve	Medium
	1	1	3	5				
Essential mitigation measures:								
• None								
With mitigation	Local	Low	Long-term	Low	Improbable	VERY LOW	– ve	Medium
	1	1	3	5				

6.5.3.2 Bird Mortality due to Entrapment in Perimeter Fences

Visser *et al.* (2019) recorded a bird being trapped between the inner and outer perimeter fence of the PV facility, and it was observed that large-bodied birds were unable to escape from between the two fences. It is, however, not foreseen that entrapment in perimeter fences will be a significant impact for priority avifauna at the PV facility, notably Black-headed Heron and Spotted Eagle-Owl.

The impact is assessed to be of **low** significance and with the implementation of mitigation is reduced to **very low**.

Table 6-28: Significance of potential bird mortality due to entrapment in perimeter fences

	<i>Extent</i>	<i>Intensity</i>	<i>Duration</i>	<i>Consequence</i>	<i>Probability</i>	<i>Significance</i>	<i>Status</i>	<i>Confidence</i>
Without mitigation	Local	Medium	Long-term	Medium	Possible	LOW	– ve	High
	1	2	3	6				
Essential mitigation measures:								
• Use a single perimeter fence.								
• For single wire fences, increase the spacing between at least the top two wires to a minimum of 30 cm and ensure they are correctly tensioned to reduce the snaring risk for owls.								
With mitigation	Local	Low	Long-term	Low	Improbable	VERY LOW	– ve	High
	1	1	3	5				

6.5.3.3 Bird Mortality due to Electrocutation

Electrocutation occurs when a bird is perched or attempts to perch on an electrical structure and causes an electrical short circuit by physically bridging the air gap (clearance) between live components and/or live and earthed components. The electrocution risk is largely determined by the design of the electrical hardware.

The 33 kV transmission lines could pose an electrocution risk to certain species, mostly raptors and vultures, but also some waterbirds, due to the small clearances, unless a bird-friendly structure is used.

Electrocutions within the substation are possible, however, the likelihood of this impact on the more sensitive Red List priority species is remote, as these species are unlikely to regularly utilise the infrastructure within the substation yard for perching or roosting.

The priority species with a medium to high likelihood of occurrence in the assessment area that could be affected by electrocution are the Amur Falcon, Black-headed Heron, Black-winged Kite, Common Buzzard, Egyptian Goose, Gabar Goshawk, Greater Kestrel, Lanner Falcon, Lesser Kestrel, Spotted Eagle-Owl and White-backed Vulture.

The impact is assessed to be of **high** significance and with the implementation of mitigation is reduced to **low**.

Table 6-29: Significance of potential bird mortality due to electrocution

	<i>Extent</i>	<i>Intensity</i>	<i>Duration</i>	<i>Consequence</i>	<i>Probability</i>	<i>Significance</i>	<i>Status</i>	<i>Confidence</i>
Without mitigation	Regional	High	Long-term	Very high	Possible	HIGH	– ve	High
	2	3	3	8				
Essential mitigation measures:								
<ul style="list-style-type: none"> • Bury 33 kV cables where possible. • Use Eskom approved bird friendly pole design approved by an avifaunal specialist (preferably the inverted T design with a cross-arm and suspended insulators to provide safe perching space for large birds, especially vultures.) • Investigate electrocution incidents and implement appropriate mitigation by insulating any hardware that causes repeat electrocutions. 								
With mitigation	Regional	Low	Long-term	Medium	Improbable	LOW	– ve	High
	2	1	3	6				

6.5.3.4 Bird Mortality due to Collisions with Transmission Lines

Collisions are the biggest threat posed by powerlines to birds in southern Africa (van Rooyen, 2004). Heavy-bodied birds with limited manoeuvrability, such as bustards, storks, cranes and various species of waterbirds and, to a lesser extent, vultures are most heavily impacted.

Using flight diverters is associated with a very significant decrease in bird mortality (55–94%). The priority species with a medium to high likelihood of occurrence in the assessment area which could be affected by transmission line collisions are Black-headed Heron, Egyptian Goose, Spotted Eagle-Owl, Western Cattle Egret and White-backed Vulture.

The impact is assessed to be of **high** significance and with the implementation of mitigation is reduced to **low**.

Table 6-30: Significance of potential bird mortality due to collisions with transmission lines

	<i>Extent</i>	<i>Intensity</i>	<i>Duration</i>	<i>Consequence</i>	<i>Probability</i>	<i>Significance</i>	<i>Status</i>	<i>Confidence</i>
Without mitigation	Regional	High	Long-term	Very high	Possible	HIGH	– ve	High
	2	3	3	8				
Essential mitigation measures:								
<ul style="list-style-type: none"> Mark all the sections of 11-33kV overhead lines with Eskom approved Bird Flight Diverters according to the applicable Eskom standard. 								
With mitigation	Regional	Low	Long-term	Medium	Improbable	LOW	– ve	High
	2	1	3	6				

6.5.4 Assessment of Impacts: Decommissioning Phase

Decommissioning phase impacts on avifauna are assessed below.

6.5.4.1 Bird Displacement due to Disturbance

Decommissioning activities on the site are likely to impact on birds breeding, foraging and roosting at or near the development area through disturbance, which could result in temporary or permanent displacement of birds, including priority species Cape White-eye, Cloud Cisticola, Fiscal Flycatcher, Gabar Goshawk, Greater Kestrel, Karoo Thrush, Lanner Falcon, Pied Starling, Spotted Eagle-Owl and White-backed Vulture.

It is likely that avifauna will be temporarily displaced in the footprint area of the proposed project, either completely or more likely partially (reduced densities) during the decommissioning phase, due to the disturbance associated with the decommissioning activities. This is likely to affect breeding residents most.

The impact is assessed to be of **low** significance and with the implementation of mitigation is reduced to **very low**.

Table 6-31: Significance of potential bird displacement due to disturbance

	<i>Extent</i>	<i>Intensity</i>	<i>Duration</i>	<i>Consequence</i>	<i>Probability</i>	<i>Significance</i>	<i>Status</i>	<i>Confidence</i>
Without mitigation	Local	High	Short-term	Low	Definite	LOW	– ve	High
	1	3	1	5				
Essential mitigation measures:								
<ul style="list-style-type: none"> Limit the area of activity to the immediate footprint of the infrastructure as possible. Demarcate access roads clearly. Prohibit off-road driving. Restrict access to areas outside of the site boundary. Implement best practice measures to control noise and dust. Undertake regular ECO audits / inspections to report on compliance with the EMPr. 								
With mitigation	Local	Medium	Short-term	Very low	Definite	VERY LOW	– ve	High
	1	2	1	4				

6.5.5 Specialist Opinion

The specialist has assessed that no fatal flaws were discovered at the project site during the investigations. The specialist therefore recommends that from an avifauna perspective the activity can be authorised, on condition that the proposed mitigation measures are implemented. Both 11-33/132 kV substation location alternatives and tie-in of powerlines anywhere along the substation are deemed acceptable.

6.5.6 The No-Go Alternative

The No-Go alternative implies that the project is not implemented, and the assessed impacts on avifauna will not be incurred. As the specialist recommends that the project is authorised, the No-Go alternative is not preferred.

6.6 Potential Socio-Economic Impacts

6.6.1 Introduction

The assessment is based on the Socio-Economic Specialist Study, which contains more detail (see Appendix D.5). The ToR for the study were to:

- Compile a socio-economic baseline of the study area, based on existing secondary public data and any primary data collected by the social specialist;
- Identify the potential social and economic impacts (including benefits) associated with the project, including, inter alia, impacts associated with loss of farmland (grazing), contribution to economic growth and job creation, quality of life, local community income and influx of workers / job seekers;
- Assess the direct, indirect and cumulative impacts of the proposed project, including alternatives, on the socio-economic environment using a prescribed impact assessment methodology;
- Recommend practicable mitigation measures to minimise / reduce impacts and enhance benefits and monitoring requirements, where possible;
- Identify and map potentially sensitive areas, buffer areas and preferred locations, if applicable;
- Compile an SIA Report compliant with Appendix 6 of the EIA Regulations (2014), relevant guidelines and Part A of the Environmental Assessment Protocols (GN R320 of 2020), where applicable; and
- Update the SIA Report based on and provide responses to comments from stakeholders and/or the Competent Authority.

All alternatives considered (see Table 3-1) do not affect the significance of socio-economic impacts in the Construction and Operation Phases.

6.6.2 Assessment of Impacts: Construction Phase

Construction phase impacts on the socio-economic environment are assessed below.

6.6.2.1 Capital Investment Contributing to the National, Regional and Local Economy

The estimated CapEx of the project is R1.1 billion. Mainstream estimates that 45% of CapEx, e.g. ~R500 million, will be expended in South Africa. This is in line with current REIPPPP local content requirements, which required at least 40% local content during construction in 2021, in addition to the use of designated components³⁶.

Specialised suppliers are likely located outside the project region, as renewable energy has played a limited role in the North West Province. However, the nearby towns of Potchefstroom, Klerkedorp and Stilfontein have a history of providing services to the mining industry and will be able to provide many of the required services, such as civil works. Other local businesses that typically benefit, at least temporarily, from the construction of a renewable energy project include the hospitality sector (restaurants, entertainment businesses and accommodation), services and transport and retail (hardware) businesses, particularly if

³⁶ REIPPPP requirements would not apply to agreements with private end-users, but it is assumed that local content would be maximized in either case.

services meet the quality requirements of multinational clients (WWF, 2015). It is expected that a considerable proportion of required project services (total value of ~R500 million) can be sourced locally and regionally.

Renewable energy is deemed one of the economic sectors with the most promise to add value to the GDP, while having the potential to change the composition and character of towns (CKDM, 2017). This could equally apply to the Klerksdorp REDZ and is especially important in the light of several economic contractions in the past decade, ascribed to mine closures, difficult farming conditions and the impacts of COVID-19.

It is expected that the project construction will temporarily (for ~2 years) but significantly increase business activity in the region and have a direct positive regional impact that is enhanced by the presence of a functional local services sector.

The benefit is assessed to be of **medium** (positive) significance with and without the implementation of optimisation³⁷.

Table 6-32: Significance of capital investment contributing to the national, regional and local economy

	<i>Extent</i>	<i>Intensity</i>	<i>Duration</i>	<i>Consequence</i>	<i>Probability</i>	<i>Significance</i>	<i>Status</i>	<i>Confidence</i>
Without mitigation	Regional	High	Short-term	Medium	Definite	MEDIUM	+ ve	Medium
	2	3	1	6				
Essential mitigation measures:								
<ul style="list-style-type: none"> Source as many goods and services as possible from the local and regional economy (e.g. use local contractors and accommodation and equipment suppliers as far as possible and purchase perishable goods locally). Provide suitable training to service providers, where possible and practicable. Develop and implement a fair and transparent procurement policy. Provide training to appointed staff and appointed service providers on how to position themselves for other employment opportunities once construction ends. Consult with existing IPP projects that successfully procure from local SMMEs to share learnings, where possible. 								
With mitigation	Regional	High	Short-term	Medium	Definite	MEDIUM	+ ve	Medium
	2	3	1	6				

The benefit of the investment, once made, is irreversible, though the flow of investment is temporary.

6.6.2.2 Generation of Employment, Income and Skills

The project is expected to create various types of employment during the manufacturing and construction phase:

- Direct employment includes staff and contractors directly associated with the project;
- Indirect employment includes other sub-contractors and suppliers; and
- Induced employment includes employment generated by increased spending at businesses and on services by households earning an income from the project (the multiplier effect).

Mainstream anticipates that the project will generate approximately 220 **direct construction** jobs during the 18 – 24-month construction phase. Based on typical REIPPPP requirements, which include targets for national and local job creation, it is assumed that virtually all semi-skilled and unskilled positions (assumed

³⁷ Goods and services have to be sourced from where they are available in sufficient quantity and quality, and it is assumed that the project will aim to procure locally and nationally as much as possible from the outset. As such, it is expected that there is limited scope for optimisation measures during the construction phase.

~85% of jobs, or ~180 jobs) will be filled by local labour³⁸. Skilled personnel may be sourced from further afield. The project area has a high proportion of precarious employment and much lower income levels than surrounding areas. Employment opportunities in the mining sector, which previously provided local semi-skilled and unskilled jobs, have reduced as mines have closed. Based on coarse assumptions made for this specialist study, the local wage bill will amount to more than R16.5 million during the construction phase. The (temporary) generation of ~180 direct local semi-skilled and unskilled positions during the construction phase in this poverty-stricken area is thus important.

The project is estimated to generate up to 2 500 **indirect and induced** (temporary) jobs. It is noted that many or most of those jobs will be jobs retained as contractors finish one project and start another, rather than additional jobs created. The estimated 180 locally and directly employed workers are estimated to support ~360 dependants.

The benefit is assessed to be of **low** (positive) significance and with the implementation of mitigation increases to **medium**.

Table 6-33: Significance of generation of employment, income and skills

	<i>Extent</i>	<i>Intensity</i>	<i>Duration</i>	<i>Consequence</i>	<i>Probability</i>	<i>Significance</i>	<i>Status</i>	<i>Confidence</i>
Without mitigation	Regional	Low	Medium	Low	Probable	LOW	+ve	Medium
	2	1	2	5				
Essential mitigation measures:								
<ul style="list-style-type: none"> • Maximise use of local skills and resources through preferential employment of locals where practicable. • Develop, communicate and implement a fair and transparent labour and recruitment policy. • Ensure diversity and gender equality in recruitment, as far as possible. • Provide training to staff and service providers before and/or during the construction phase. • Provide training to appointed staff and appointed service providers on how to position themselves for other employment opportunities once construction ends. 								
With mitigation	Regional	Medium	Medium	Medium	Definite	MEDIUM	+ve	Medium
	2	2	2	6				

The benefit of employment is irreversible, though the employment itself is temporary.

6.6.2.3 Social Disruption and Change in Social Dynamics

The establishment of the solar project may attract different groups of people to the area:

- Non-local workers / professionals hired for the construction phase of the project where expertise is not available in the local area; and
- People moving opportunistically into the area in the hope of finding employment or exploiting other commercial opportunities.

The temporary influx of people during construction, leading to short-term growth in population size, may lead to changes in social dynamics (WWF, 2015). This indirect impact of the project is common to most medium to large scale projects in South Africa and much of the world. It cannot be addressed by the developers alone and will require management of resources by the municipality as well.

The impact intensity and likelihood are considered comparatively low for this project as:

³⁸ REIPPPP requirements would not apply to agreements with private end-users, but it is assumed that local employment would be maximized in either case.

- It is expected that none or very few workers need to be hired from outside of the region, as sufficient workers should be available from the three towns located within 35 km of the project area. As such, most workers could operate from their home base;
- The presence of several towns and a considerable population within 35 km of the project area will dilute the effect of migrants moving into the area; and
- The region, though located within the Klerksdorp REDZ, has not yet seen any renewable energy development. As such, it is not (yet) a focus area for in-migration.

The rollout of renewable energy may also cause socio-political disruption/protest. The project does not appear to overlay ecologically sensitive areas (as identified by SANBI GIS), is located on private land and not linked to potential job losses at existing local (e.g. power generation) facilities or agricultural ventures. Stakeholders contacted during the SIA did not voice concerns regarding the project (see Section 5.2.3). Disruptions due to social or environmental concerns are thus considered unlikely.

The impact is assessed to be of **very low** significance and with the implementation of mitigation reduces to **insignificant**.

Table 6-34: Significance of social disruption and change in social dynamics

	<i>Extent</i>	<i>Intensity</i>	<i>Duration</i>	<i>Consequence</i>	<i>Probability</i>	<i>Significance</i>	<i>Status</i>	<i>Confidence</i>
Without mitigation	Local	Low	Medium	VERY LOW	Probable	VERY LOW	-ve	Medium
	1	1	2	4				
Essential mitigation measures:								
<ul style="list-style-type: none"> Clearly publicise and implement a local recruitment policy. Work together with impartial local representatives to identify local people during the recruitment process. Consult with the municipality regarding the capacity of existing services and infrastructure (e.g. provision of water, electricity, waste removal, sanitation and housing) to cope if significant numbers of additional workers are brought into the area during the construction period. Consider supporting projects that improve local services and infrastructure and/or deal with social problems or conflicts through the social upliftment programme, if the need arises. 								
With mitigation	Local	Low	Medium	VERY LOW	Possible	INSIGNIFICANT	-ve	Medium
	1	1	2	4				

6.6.2.4 Reduced Quality of Life and Increased Risks due to Construction near Residences

Several residences are located within 0.75 km and 2 km of the Stilfontein Cluster boundary. Construction can reduce quality of life of residents through noise and dust from construction activities and/or increase the risk of crime due to increased activity in the area, possibly attracting opportunists and littering by construction crews.

Construction noise will be confined primarily to daylight hours and weekdays and is attenuated by the distance between the project site and (offsite) residences (>750 m). Air emissions from construction activities are not expected to cause nuisance or health impacts as dust levels are not likely to exceed normal dust levels associated with construction activities and both will be limited in extent and duration. Emissions from vehicles and other equipment are likely to be low and disperse quickly in the open space.

Certain project characteristics will mitigate security risks, including that no workers will be accommodated on site and that the site will be secured and access controlled. The project is not expected to trigger a significant influx of people into the area. Other construction-related nuisances and risks, such as littering and disruption of any service infrastructure, can be managed through standard contractor procedures.

The impact is assessed to be of **low** significance and with the implementation of mitigation is reduced to **very low**.

Table 6-35: Significance of reduced quality of life and increased risks due to construction near residences

	<i>Extent</i>	<i>Intensity</i>	<i>Duration</i>	<i>Consequence</i>	<i>Probability</i>	<i>Significance</i>	<i>Status</i>	<i>Confidence</i>
Without mitigation	Local	High	Short-term	Low	Possible	VERY LOW	– ve	High
	1	3	1	5				
Key essential mitigation measures:								
<ul style="list-style-type: none"> • Liaise with nearby residents (up to ~2 km from the project boundary) before and during construction to inform them of construction status and discuss safety management measures to reduce security risks. • Maintain a visible security presence on site. • Implement a grievance mechanism at the start of the construction phase. • Communicate and implement a compensation procedure in the event of damages directly linked to the construction. • Control site access. • Provide transportation to site for workers. • Declare areas outside of the construction site as no-go areas for construction staff. • Erect and regularly inspect a boundary fence. • Regularly inspect the project area and surrounding area for signs of illegal activity. • Regularly clean any litter from the project area and surrounding area. 								
With mitigation	Local	Medium	Short-term	Very Low	Improbable	INSIGNIFICANT	– ve	High
	1	2	1	4				

The impact can be reversed, as no or very few security risks are associated with the operation phase, when on-site activities significantly scale back.

6.6.3 Assessment of Impacts: Operational Phase

Operational phase impacts on the socio-economic environment are assessed below.

6.6.3.1 Operational Investment Contributing to the National, Regional and Local Economy

The estimated OpEx is R600 million, or R32 million per year over 20 years (2022 prices), and mostly relates to servicing solar panels and project infrastructure, administrating the project and land rental. This represents a significant and reliable long-term contribution to the local and regional economy.

Whether the benefits will accrue at a local, regional or national level depends to a large extent on the level of development of renewable energy support services in the area (IRENA, 2014). As Potchefstroom, Klerkdorp and Stilfontein are located nearby, it is expected that many of the services required during operation will be available at a local and regional level. Local economic activity has reduced considerably in the wake of mine closures, and the need for alternative economic opportunities is significant.

The benefit is assessed to be of **medium** (positive) significance with and without the implementation of optimisation³⁹.

³⁹ Goods and services have to be sourced from where they are available in sufficient quantity and quality, and it is assumed that the project will aim to procure within South Africa as much as possible from the outset. As such, it is expected that there is limited scope for optimisation measures during the operation phase.

Table 6-36: Significance of operational investment contributing to the national, regional and local economy

	<i>Extent</i>	<i>Intensity</i>	<i>Duration</i>	<i>Consequence</i>	<i>Probability</i>	<i>Significance</i>	<i>Status</i>	<i>Confidence</i>
Without mitigation	Regional	Low	Long-term	Medium	Probable	MEDIUM	+ve	Medium
	2	1	3	6				
Essential mitigation measures:								
<ul style="list-style-type: none"> • Source as many goods and services as possible from the local and regional economy (e.g. use local contractors and equipment suppliers as far as possible). • Provide suitable training to service providers, where possible and practicable. • Develop and implement a fair and transparent procurement policy. 								
With mitigation	Regional	Low	Long-term	Medium	Probable	MEDIUM	+ve	Medium
	2	1	3	6				

6.6.3.2 Generation of Employment, Income and Skills

Mainstream anticipates that the project generates approximately 20 **direct jobs** during the 20-year project life. Based on typical REIPPPP requirements⁴⁰, operational practicalities and the fact that the region is expected to hold a pool of suitable labour, it is assumed that all positions will be filled by local/regional labour. Though the total number of positions is limited, the generation of sustainable long-term employment in the region is important.

The project also provides a sustainable alternative income for some farmers (whose activities have seen productivity declines), from lease payments for land on which the project is established. This will supplement or substitute current farming activities, some of which may not be able to continue.

The benefit is assessed to be of **low** (positive) significance with and without the implementation of optimisation.

Table 6-37: Significance of generation of employment, income and skills

	<i>Extent</i>	<i>Intensity</i>	<i>Duration</i>	<i>Consequence</i>	<i>Probability</i>	<i>Significance</i>	<i>Status</i>	<i>Confidence</i>
Without mitigation	Local	Low	Long-term	Low	Definite	LOW	+ve	Medium
	1	1	3	5				
Essential mitigation measures:								
<ul style="list-style-type: none"> • Maximise use of local skills and resources through preferential employment of locals where practicable. • Develop and implement a fair and transparent labour and recruitment policy. • Ensure diversity and gender equality in recruitment, as far as possible. • Provide suitable training. • Provide ancillary training to workers on maximising the use of income and training to further future economic prospects, potentially through projects initiated as part of the social upliftment programme. 								
With mitigation	Local	Low	Long-term	Low	Definite	LOW	+ve	Medium
	1	1	3	5				

⁴⁰ REIPPPP requirements would not apply to agreements with private end-users, but it is assumed that local employment would be maximized in either case.

6.6.3.3 Increased Community Prosperity through Contributions and Income from the Project

The REIPPPP requires successful bidders to comply with requirements aimed at sharing benefits of the project with communities of Historically Disadvantaged Individuals (HDIs) within a 50 km radius and contribute towards the growth and transformation of the South African economy. Requirements typically include (WWF, 2015):

- Annual Socio-economic Development (SED) contributions, as a percentage of project revenue;
- Annual Enterprise Development (ED) contributions, as a percentage of project revenue; and
- Community ownership (shareholding) in the project, which pays dividends.

A typical project is likely to contribute between 1.5% and 2.5% of project revenue to community upliftment SED and ED projects; these investments tend to start shortly after project initiation. Between 5% and 15% of the project equity is assigned to communities and typically acquired through a loan by a Community Trust set up for this purpose; during the initial project years dividends from these investments are typically used to pay off loans used to purchase the equity. This may not always be the case however and contributions through SED and ED projects could take preference. This is typically decided prior to bid taking into account bidding requirements etc..

As of mid-2021 IPPs can also sell limited quantities of independently-generated electricity to private end-users; such agreements are not subject to the REIPPPP socio-economic requirements.

If managed and implemented effectively, sustained funding of social upliftment projects over many years is expected to have many potential benefits for the local communities, such as enhanced educational opportunities, improved skills, improved access to healthcare and development of an economic base and economic independence of the community. (Intellidex, 2021).

However, the prospect and eventual flow of significant payments also creates risks related to unrealistic expectations in the community, disagreement about appropriate fund allocation, rivalry for fund allocation, misallocation or ineffective allocation of funds and corruption. These challenges can lead to social disruptions and conflict, disillusionment and apathy and empowerment of some sections of the community at the expense of others. Ensuring that a Community Trust is consistently funded (if applicable) and that projects are carefully selected and well administered would increase the likelihood of successful outcomes and long-term benefits accruing to the community.

The benefit is assessed to be of **medium** (positive) significance and with the implementation of mitigation increases to **high** if the project is procured via the REIPPPP (and past REIPPPP requirements apply).

Table 6-38: Significance of increased community prosperity through contributions and income from the project if procured via the REIPPPP

	<i>Extent</i>	<i>Intensity</i>	<i>Duration</i>	<i>Consequence</i>	<i>Probability</i>	<i>Significance</i>	<i>Status</i>	<i>Confidence</i>
Without mitigation	Regional	Medium	Long-term	High	Possible	MEDIUM	+ve	Medium
	2	2	3	7				
Essential mitigation measures:								
<ul style="list-style-type: none"> Regularly engage with community stakeholders to develop meaningful strategies for community development. Define a vision for economic development in consultation with communities. Develop a Governance Plan with clear governance rules for a Community Trust, including administration and trustee and beneficiary selection (if applicable). Ensure that funding requirements for each project are considered into the future so that projects are viable and sustainable. Set clear goals for each project and phase out funding once these goals are achieved. Ensure regular external auditing of the Community Trust as well as supported projects (if applicable). Consider auditing projects for several years after funding has ceased to ensure their benefits are sustained. 								
With mitigation	Regional	Medium	Long-term	High	Probable	HIGH	+ve	Medium
	2	2	3	7				

The benefit is assessed to be of **low** (positive) significance and with the implementation of mitigation remains **low** if a private end-user agreement is pursued (or past REIPPPP requirements do not apply).

Table 6-39: Significance of increased community prosperity through contributions and income from the project if a private end-user agreement is pursued

	<i>Extent</i>	<i>Intensity</i>	<i>Duration</i>	<i>Consequence</i>	<i>Probability</i>	<i>Significance</i>	<i>Status</i>	<i>Confidence</i>
Without mitigation	Local	Low	Long-term	Low	Probable	LOW	+ve	Medium
	1	1	3	5				
Essential mitigation measures:								
<ul style="list-style-type: none"> Regularly engage with community stakeholders to develop meaningful strategies for community development. Define a vision for economic development in consultation with communities. Ensure that funding requirements for each project are considered into the future so that projects are viable and sustainable. Set clear goals for each project and phase out funding once these goals are achieved. 								
With mitigation	Local	Low	Long-term	Low	Probable	LOW	+ve	Medium
	1	1	3	5				

6.6.4 Assessment of Impacts: Decommissioning Phase

The decommissioning of the substations and transmission lines is not expected to have socio-economic impacts (other than those separately assessed for the PV facilities).

Decommissioning Phase phase impacts on the socio-economic environment are assessed below.

6.6.4.1 Reduced Employment and Community Income

The decommissioning phase is primarily associated with the demolition, salvage and removal of the solar facilities and the rehabilitation of the site. This generates some opportunities for demolition, recycling and disposal services (IRENA, 2014). No detail on such opportunities is currently available.

Decommissioning is also associated with a reduction and, ultimately, cessation of employment at the project, and discontinued support of upliftment initiatives and dividend payouts to shareholders. Employment during the operational phase is relatively low and the end of life of the project is predictable,

so that the impact of termination of employment is limited. Similarly, contributions to initiatives are predictable over the lifetime of the project and the cessation of such contributions is known from the outset.

The impact is assessed to be of **very low** significance and with the implementation of mitigation remains **very low**.

Table 6-40: Significance of reduced employment and funding

	<i>Extent</i>	<i>Intensity</i>	<i>Duration</i>	<i>Consequence</i>	<i>Probability</i>	<i>Significance</i>	<i>Status</i>	<i>Confidence</i>
Without mitigation	Regional	Low	Short-term	Very Low	Definite	VERY LOW	-ve	Medium
	2	1	1	4				
Essential mitigation measures:								
<ul style="list-style-type: none"> Clearly communicate project duration to staff and communities. Prolong the operational life of the project as much as possible. Assist with recommendations and referrals where possible. Assist with the sustainable administration of funds throughout the project lifetime. 								
With mitigation	Regional	Low	Short-term	Very Low	Definite	VERY LOW	-ve	Medium
	2	1	1	4				

6.6.5 Specialist Opinion

The specialist has assessed that the project has acceptable socio-economic impacts and desirable benefits, though careful management of benefits (particularly governance of Community Trusts if community takes partial ownership of the project) is critical. The specialist recommends that from a socio-economic perspective the project is authorised and preferred to the No-Go alternative. Both 11-33/132 kV substation location alternatives and tie-in of powerlines anywhere along the substation are deemed acceptable.

6.6.6 The No-Go Alternative

The project has significant socio-economic benefits at the local and regional scale which outweigh the potential negative socio-economic impacts. The No-Go alternative is thus considered less desirable than proceeding with the project.

6.7 Potential Heritage and Palaeontology Impacts

6.7.1 Introduction

The assessment is based on the Heritage and Palaeontology Specialist Study, which contains more detail (see Appendix D.6). The ToR for the study were to:

- Undertake a desktop screening study to gather data and compile a background history of the area, including archaeological sites, historical sites and known graves;
- Undertake field work to understand the heritage character of the study area. Record, photograph and describe any heritage sites of significance and document GPS locations;
- Undertake a Phase 1 study in line with the high and very high palaeontological sensitivity rating in SAHRA’s palaeontological sensitivity map;
- Identify any significant project impacts, rate impact significance and recommend mitigation measures should sensitive sites be identified during the field visit;

- Compile a Report compliant with Appendix 6 of the EIA Regulations (2014), relevant guidelines and/or the Environmental Assessment Protocols (GN R320 of 2020), as applicable; and
- Submit required documentation to SAHRA as the commenting authority.

All alternatives considered (see Table 3-1) do not affect the significance of heritage and palaeontology impacts in the Construction and Operation Phases.

6.7.2 Assessment of Impacts: Construction Phase

Construction phase impacts on the heritage environment are assessed below.

6.7.2.1 Loss of Heritage and Palaeontology Resources

The disturbance and removal of topsoil and vegetation and establishment of infrastructure and facilities during construction can damage and destroy heritage features should any occur in the area. Isolated Stone Age scatters recorded across the project area are out of context and scattered too sparsely to be of significance. A few built environment features recorded in the cluster area were found to have no aesthetic, historical or architectural potential and the sites are of low significance and require no pre construction mitigation if they are disturbed by the final project footprint. As no heritage sites of significance occur within the project area, no significant impacts to heritage resources are expected.

The impact is assessed to be of **very low** significance with and without the implementation of mitigation.

Table 6-41: Significance of potential loss of heritage / palaeontology resources

	<i>Extent</i>	<i>Intensity</i>	<i>Duration</i>	<i>Consequence</i>	<i>Probability</i>	<i>Significance</i>	<i>Status</i>	<i>Confidence</i>
Without mitigation	Local	Low	Long-term	Low	Possible	VERY LOW	– ve	High
	1	1	3	5				
Essential mitigation measures:								
<ul style="list-style-type: none"> • Employ an ECO to monitor the construction activities. • Implement a chance find procedure for palaeontology and heritage finds. 								
With mitigation	Local	Low	Long-term	Low	Improbable	VERY LOW	– ve	High
	1	1	3	5				

6.7.2.2 Loss of Fossils

The disturbance and removal of topsoil and vegetation and trenching and other earthworks for the establishment of infrastructure and facilities during construction can damage and destroy fossils should any occur sufficiently near the surface in the area.

However, no fossils were found above ground during the site visit. Fossils that may be present below ground are trace fossils such as stromatolites. They are common in the Malmani Subgroup and are traces of microbial activity, not fossils of the microbes (bacteria and algae), which reduces their scientific value. Recovery and safe storage of any such trace fossils in a research institute or museum for future research would represent a positive impact.

The impact is assessed to be **insignificant** with and without the implementation of mitigation.

Table 6-42: Significance of potential loss of fossils

	<i>Extent</i>	<i>Intensity</i>	<i>Duration</i>	<i>Consequence</i>	<i>Probability</i>	<i>Significance</i>	<i>Status</i>	<i>Confidence</i>
Without mitigation	Local	Medium	Short-term	Very low	Improbable	INSIGNIFICANT	- ve	High
	1	2	1	4				
Essential mitigation measures:								
<ul style="list-style-type: none"> Put aside and photograph any fossils found during excavations and send pictures to a palaeontologist to assess their scientific importance. If deemed important, the palaeontologist must obtain a SAHRA permit and remove stromatolites to a recognised repository. 								
With mitigation	Local	Medium	Short-term	Very Low	Possible	INSIGNIFICANT	+ ve	High
	1	2	1	4				

6.7.3 Assessment of Impacts: Operational Phase

Operational activities are not expected to impact on heritage resources.

6.7.4 Specialist Opinion

The specialist has assessed that the project area is considered to be of low heritage potential and no fossils are visible on the land surface. Due to the nature of the environment, there is no discernible difference in the substation alternatives. The impact on heritage resources can be mitigated to an acceptable level and the specialist recommends that from a heritage perspective the project should be authorised.

6.7.5 The No-Go Alternative

The No-Go alternative implies that the project is not implemented. In that case, heritage resources will not be affected. As the site was deemed to be of low heritage potential and the specialist recommends that the project is approved, the No-Go alternative is not preferred.

6.8 Potential Visual Impacts

6.8.1 Introduction

The assessment is based on the Visual Specialist Study, which contains more detail (see Appendix D.5). The ToR for the study were to:

- Describe the baseline visual characteristics of the study area, including landform, visual character and sense of place, and place this in a regional context;
- Identify potential impacts of the project on the visual environment through analysis and synthesis of visual exposure, visual absorption capacity, sensitivity of viewers (visual receptors), viewing distance and visibility and landscape integrity;
- Model glare generated by the proposed PV arrays;
- Assess potential visual and sense of place impacts of the project using SRK’s impact assessment methodology;
- Identify and assess the direct, indirect and cumulative impacts (pre- and post-mitigation) of the proposed project (and alternatives, if applicable) on visual resources in relation to other proposed and existing developments in the surrounding area;

- Recommend practicable mitigation measures to avoid and/or minimise impacts and/or optimise benefits; and
- Compile a Report compliant with Appendix 6 of the EIA Regulations (2014), relevant guidelines and/or the Environmental Assessment Protocols (GN R320 of 2020), as applicable.

All alternatives considered (see Table 3-1) do not affect the significance of visual impacts in the Construction and Operation Phases.

6.8.2 Assessment of Impacts: Construction Phase

Construction phase impacts on the visual environment are assessed below.

6.8.2.1 Altered Sense of Place and Visual Intrusion caused by Construction Activities

Visual impacts will be generated by construction activities such as stripping of vegetation, bulk earthworks (which can generate dust) and from construction infrastructure, plant, and materials on site. Dust generated during construction will be visually unappealing and may detract from the visual quality (sense of place) of the area. These impacts are typically limited to the immediate area surrounding the construction site, during the construction period.

The impact is assessed to be of **low** significance and with the implementation of mitigation is reduced to **very low**.

Table 6-43: Altered sense of place and visual intrusion caused by construction activities

	<i>Extent</i>	<i>Intensity</i>	<i>Duration</i>	<i>Consequence</i>	<i>Probability</i>	<i>Significance</i>	<i>Status</i>	<i>Confidence</i>
Without mitigation	Local	High	Short-term	Low	Definite	LOW	-ve	High
	1	3	1	5				
Essential Mitigation Measures:								
<ul style="list-style-type: none"> • Limit vegetation clearance and the footprint of construction to what is absolutely essential. • Consolidate the footprint of the construction camp to a functional minimum. • Avoid excavation, handling and transport of materials which may generate dust under very windy conditions. • Cover stockpiled aggregates and sand to minimise dust generation. • Implement dust suppression on access roads during dry conditions. • Keep construction site tidy. 								
With mitigation	Local	Medium	Short-term	Very Low	Probable	VERY LOW	-ve	High
	1	2	1	4				

6.8.3 Assessment of Impacts: Operational Phase

Operational phase impacts on the visual environment are assessed below.

6.8.3.1 Altered Sense of Place and Visual Intrusion caused by the PV Array

The PV facility will occupy over 330 ha and will introduce infrastructure that may be perceived as conflicting with the current natural landscapes of grassland and treescapes. While there is evidence of anthropogenic influence within the surrounding area, it is largely confined. The PV facility will be of a different size, scale, texture and layout to those structures which already exists within the landscape, and as such is anticipated to impact the sense of place.

The PV array will be highly visible in the foreground to middleground to motorists on the N12 and visible in the background, screened by vegetation, to residents in the eastern suburbs of Stilfontein and Khuma. The PV array will also be visible in the middleground from the intersection of Vermaasdrift Road and the N12. The PV array is likely to be partially screened by vegetation between the site and the receptors.

The impact is assessed to be of **high** significance and with the implementation of mitigation is reduced to **medium**.

Table 6-44: Altered sense of place and visual intrusion caused by PV array

	<i>Extent</i>	<i>Intensity</i>	<i>Duration</i>	<i>Consequence</i>	<i>Probability</i>	<i>Significance</i>	<i>Status</i>	<i>Confidence</i>
Without mitigation	Local	High	Long-term	High	Definite	HIGH	-ve	High
	1	3	3	7				
Essential Mitigation Measures:								
<ul style="list-style-type: none"> Plant tall vegetation (~5 m in height) along the boundary of the site upon completion of construction, to screen the site but not cast shadow across the PV array. Fence the perimeter of the site with a green or black fencing. 								
With mitigation	Local	High	Long-term	High	Possible	MEDIUM	-ve	High
	1	3	3	7				

6.8.3.2 Altered Sense of Place and visual intrusion caused by the 11-33 kV Powerlines and Pylons

Two existing 400 kV Hermes/Pluto powerlines traverse the site and have marginally inured receptors to powerlines within the landscape. Nevertheless, it is expected that the development of the 11-33 kV powerline will detract from the scenic value of the project site and surrounding areas, albeit to a limited degree. The PV array will be marginally visible in the middleground to background, and is partially screened by vegetation. The PV Facility will be connected to the BESS and on-site substation by a 33 kV underground cabling and overhead powerlines. The proposed powerline will be set back at least 1 km from the N12 and therefore it is anticipated that all receptors will have limited visibility of this powerline.

The impact is assessed to be of **low** significance with and without the implementation of mitigation.

Table 6-45: Altered sense of place and visual intrusion caused by the 11-33 kV powerlines and pylons

	<i>Extent</i>	<i>Intensity</i>	<i>Duration</i>	<i>Consequence</i>	<i>Probability</i>	<i>Significance</i>	<i>Status</i>	<i>Confidence</i>
Without mitigation	Local	Low	Long-term	Low	Definite	LOW	-ve	High
	1	1	3	5				
Essential Mitigation Measures:								
<ul style="list-style-type: none"> Do not install or affix lights on pylons. 								
With mitigation	Local	Low	Long-term	Low	Probable	LOW	-ve	High
	1	1	3	5				

6.8.3.3 Altered Sense of Place and visual intrusion caused by the BESS and On-Site Substation

The BESS and IPP-side on-site substation will be of a different form to the few farmsteads dotted across the greater project site. The ~10 ha BESS may be stacked to a maximum height of ~15 m. There are few

structures within the landscape that have prominent vertical profiles, as such, the BESS may alter the scenic value of the landscape. The on-site substations will have a footprint of 2 ha and will be several meters high. The BESS and on-site substation will diminish the scenic value of the project site, albeit to a lesser degree than the PV arrays.

The BESS and IPP-side on-site substation will be constructed near the PV Facility, connected by a 11-33 kV underground cable and / or overhead transmission line. Due to the low Visual Absorption Capacity (VAC) of the site, the proposed BESS and IPP-side on-site substation are expected to be visually intrusive, albeit only partially visible to receptors.

The impact is assessed to be of **medium** significance with and without the implementation of mitigation.

Table 6-46: Altered sense of place and visual intrusion caused by the BESS and IPP-side substation

	<i>Extent</i>	<i>Intensity</i>	<i>Duration</i>	<i>Consequence</i>	<i>Probability</i>	<i>Significance</i>	<i>Status</i>	<i>Confidence</i>
Without mitigation	Local	Medium	Long-term	Medium	Definite	MEDIUM	-ve	High
	1	2	3	6				
Essential Mitigation Measures:								
<ul style="list-style-type: none"> Consolidate the BESS and on-site substation footprint, if possible. Ensure that the on-site substation roof and BESS container colour blends into the landscape. Limit the stacking of containers to a height of 10 m. 								
With mitigation	Local	Medium	Long-term	Medium	Probable	MEDIUM	-ve	High
	1	2	3	6				

6.8.3.4 Visual Discomfort and Impaired Visibility Resulting from Glint and Glare

Due to the proximity of the PV Facility to residential areas and roads, the potential glare impact was modelled. The analysis indicated that only very limited and short-term glare (and potentially glint) will be experienced. These short durations of glare are not considered to be of a level that would cause visual discomfort or impaired visibility to stationary receptors but may be experienced as a nuisance by the sensitive receptors (motorists) if not mitigated.

The impact is assessed to be of **high** significance and with the implementation of mitigation is reduced to **low**.

Table 6-47: Visual discomfort and impaired visibility resulting from glint and glare

	<i>Extent</i>	<i>Intensity</i>	<i>Duration</i>	<i>Consequence</i>	<i>Probability</i>	<i>Significance</i>	<i>Status</i>	<i>Confidence</i>
Without mitigation	Local	High	Long-term	High	Definite	HIGH	-ve	Medium
	1	3	3	7				
Essential Mitigation Measures:								
<ul style="list-style-type: none"> Plant tall vegetation (~5 m in height) along the boundary of PV array to screen the PV panels from receptors, to screen the site but not cast shadow across the PV array. Fence the perimeter of the site with a green or black fencing. 								
With mitigation	Local	Low	Long-term	Low	Possible	LOW	-ve	Medium
	1	1	3	5				

6.8.3.5 Altered Visual Quality caused by Light Pollution at Night

It is anticipated that lighting will be installed along the perimeter of the PV Facility and / or around the BESS and on-site substation to improve security.

The installation of lighting is anticipated to generate nightglow that currently does not emanate from the natural, undeveloped site. As such, the introduction of lighting on the site alters the sense of place and visual quality to surrounding receptors. Nightglow may become more intense to farmstead receptors currently located some distance from the nightglow emanating from the towns of Stilfontein, Khuma and Klerksdorp. This can significantly alter the visual quality of the surrounding area.

The impact is assessed to be of **medium** significance with and without the implementation of mitigation.

Table 6-6-48: Altered visual quality caused by light pollution at night

	<i>Extent</i>	<i>Intensity</i>	<i>Duration</i>	<i>Consequence</i>	<i>Probability</i>	<i>Significance</i>	<i>Status</i>	<i>Confidence</i>
Without mitigation	Local	Medium	Long-term	Medium	Definite	MEDIUM	-ve	High
	1	2	3	6				
Essential Mitigation Measures:								
<ul style="list-style-type: none"> • Reduce the height of lighting masts to a workable minimum. • Direct lighting inwards and downwards to limit light pollution. 								
With mitigation	Local	Medium	Long-term	Medium	Probable	MEDIUM	-ve	High
	1	2	3	6				

6.8.4 Specialist Opinion

The specialist has assessed that construction and operation phase visual impacts are deemed to be acceptable on the assumption that the mitigation measures are implemented and noting the location of the project in a designated REDZ. Both 11-33/132 kV substation location alternatives and tie-in of powerlines anywhere along the substation are deemed acceptable. On this basis, the specialist recommends that from a visual perspective the project is authorised.

6.8.5 The No-Go Alternative

The No Go alternative entails that the project is not developed. Forgoing the development means that the sense of place will not be altered, no visual intrusion, glint or glare or light pollution will be experienced, i.e. the visual impacts of this project would not be realised. However, it would also mean that no renewable energy will be generated by this project. As the project was deemed acceptable, the No-Go alternative is not preferred.

6.9 Potential Traffic Impacts

6.9.1 Introduction

Traffic impacts are discussed and assessed in the sections below.

All alternatives considered (see Table 3-1) do not affect the significance of traffic impacts in the Construction and Operation Phases.

6.9.2 Assessment of Impacts: Construction Phase

Construction phase impacts on traffic are assessed below. Since the N12 (which affords access to the site) is a national road designed to accommodate all legal vehicle types, it is assumed that the structural integrity of the road pavement will not be affected by vehicles accessing the project site.

Main access to the Sparrow project site will be from the N12 as per Figure 7-3. The dimensions of the main access road and internal access roads are included in Table 3-4.

6.9.2.1 Trip Generation Causing Congestion during the Construction Phase

Construction phase traffic will comprise:

- Vehicles (typically trucks) delivering materials and components to the site. Deliveries will occur throughout the construction phase and may occur at higher frequency during certain construction periods. While trip generation cannot be precisely estimated at this stage, for a similar plant KMA (2016) estimated that construction phase traffic will peak at approximately 10 large delivery vehicles and 40 to 50 concrete trucks (delivering premix) per day while the PV array footings and facility slabs are being cast, reducing to about 20 to 30 large delivery vehicles per day while the electrical reticulation is being installed;
- Vehicles transporting construction staff to site. As no staff will be accommodated on site, the estimated ~220 construction staff will travel to and from site. Transport arrangements will be made by the contractor(s). Assuming that workers are transported in vehicles with an average capacity of 5 passengers, some 40 vehicle (return) movements per day are anticipated; and
- Abnormal load vehicles delivering oversize components or construction vehicles to undertake specialised works on site. Construction vehicles typically remain on site until no longer needed.

At peak construction, a total of ~100 daily traffic movements are estimated. If concrete is batched on site, the estimated vehicle movements reduce to ~60 per day.

PV components typically do not require abnormal load vehicles, as all materials fit on standard interlink vehicles or in standard containers (KMA, 2016). Substation transformers and certain other components are likely to be abnormal loads, requiring special arrangements.

The project site is directly accessible from the N12, a dual carriageway national road with a wide median, wide gravel shoulders, suitable geometry and good sight distances. National roads are designed to accommodate large vehicles and traffic volumes. Rush hour commuter congestion is experienced at the interchange of the N12 and R502, just east of the project area, which leads to the residential area of Khuma south of the project area. Capacity on other sections and at other times is good (i-traffic, 2022).

Two existing gravel roads provide at grade access off the northern carriageway of the N12 to the project site; these intersections are approximately 2 km apart, each at 90° angle to the N12 on flat (level gradient) sections of the road. Access 2 is approximately 2 km west of the N12 / R502 interchange (see Figure 6-1), far exceeding the recommended minimum access separation (spacing) of 350 m on roads with design speed of up to 120 km/h (see Figure 6-2). No other accesses are located in the area. Sight distances are also very good (see Figure 6-3).

The existing gravel road Access 1 (see Figure 6-1) will be formalised as per the layout design in Figure 7-3.

No public roads other than the N12 would be utilised by construction vehicles in the project vicinity.

Noting that other existing intersections on the N12 are likely to accommodate far more traffic than will be generated by the project, it is anticipated that with appropriate upgrade(s)⁴¹ of the intersection(s) it is likely that the Level of Service (i.e. congestion and associated waiting times) during the Construction Phase will be acceptable.

The additional volume of traffic generated during the construction phase is significant but temporary. The N12 provides direct access to the site and is designed for heavy vehicles, though accesses require formalisation. Construction traffic does not impact on other local roads, accesses or communities, as none are located close to the project site.

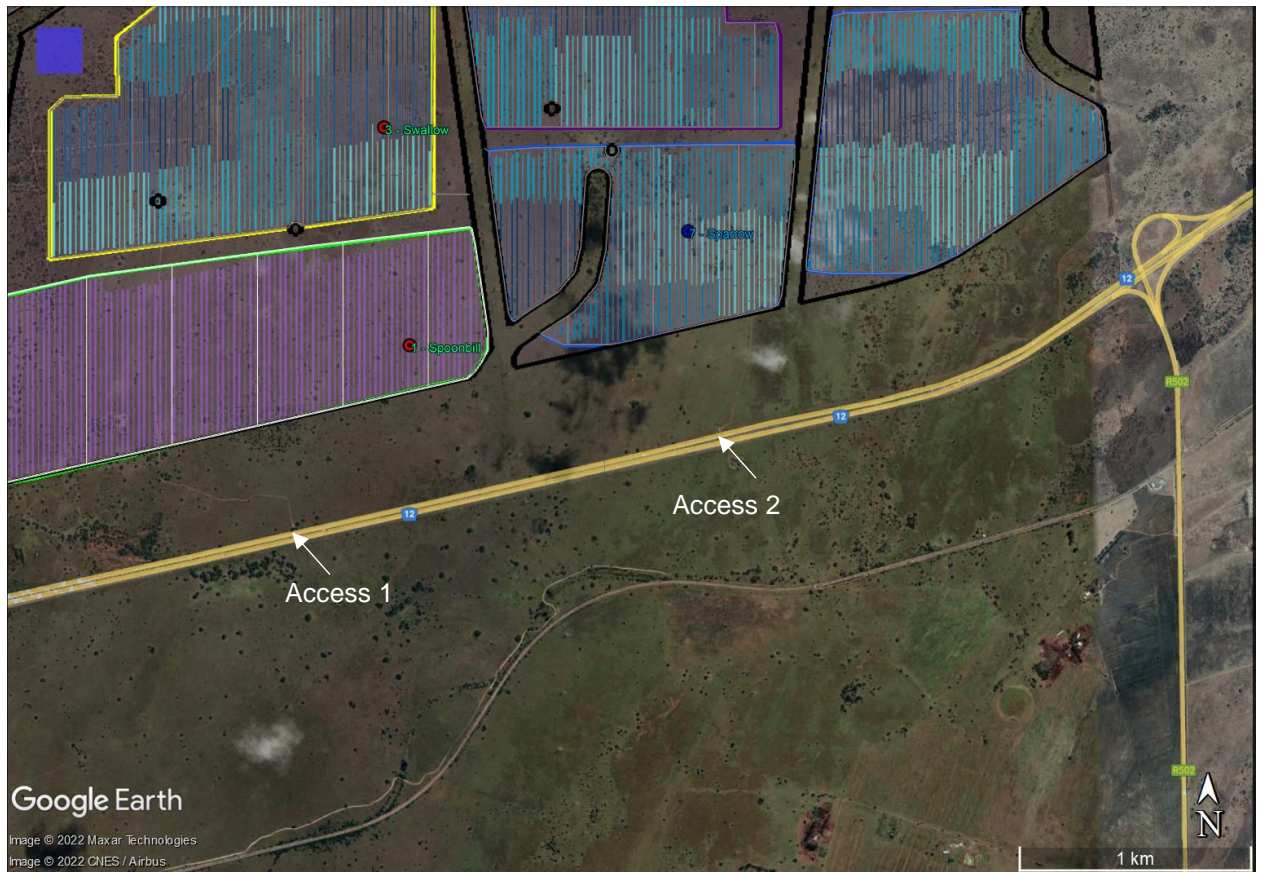

Figure 6-1: Existing gravel road site access

⁴¹ Access 1 (see Figure 6-1) from the N12 will be formalised to accommodate the anticipated number of heavy vehicles in a safe manner. As the N12 is a dual carriageway, access will be a left in left out configuration, off the northern carriageway. Sufficient space must be allowed at the access point to ensure that vehicles do not queue while exiting the N12.

Design speed (km/h)	Upstream access class	
	Unsignalised marginal	All other access types
40	20	80
50	35	110
60	50	130
70	70	175
80	100	200
100	170	300
120	250	350

Figure 6-2: Recommended minimum access separations

Sources: (KMA, 2016)

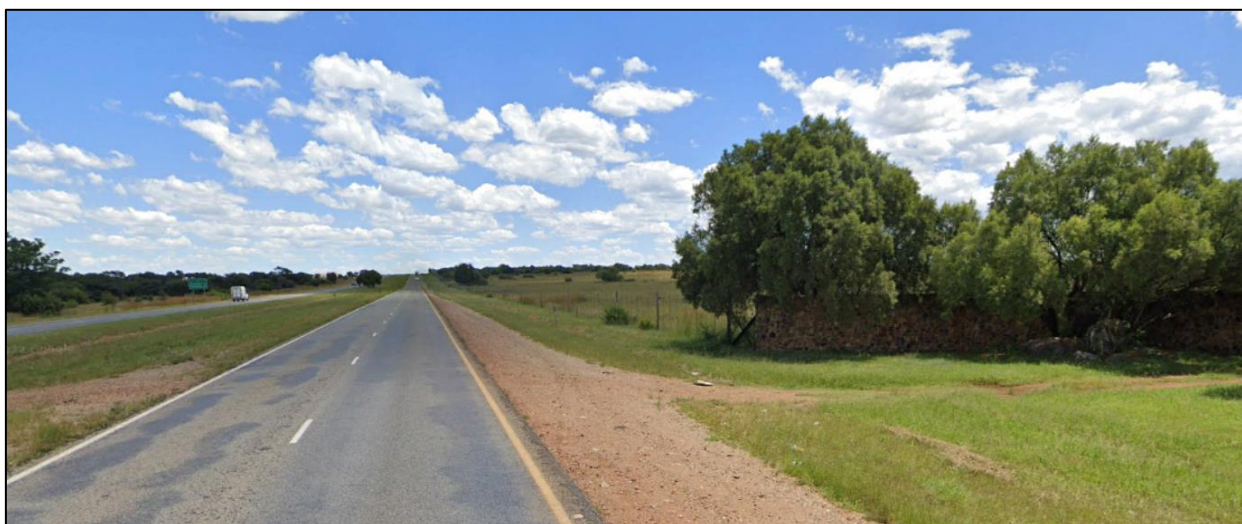

Figure 6-3: Sight distances at Access 1 to the east (top) and west (bottom)

The impact is assessed to be of **low** significance and with the implementation of mitigation reduces to **very low**.

Table 6-49: Significance of potential trip generation during construction

	<i>Extent</i>	<i>Intensity</i>	<i>Duration</i>	<i>Consequence</i>	<i>Probability</i>	<i>Significance</i>	<i>Status</i>	<i>Confidence</i>
Without mitigation	Local	High	Short-term	Low	Probable	LOW	– ve	High
	1	3	1	5				
Essential mitigation measures:								
<ul style="list-style-type: none"> • Design and construct an appropriate and formalised access to the site from the N12, if and when the project is awarded preferential bidder status. • Liaise with the appropriate road authorities to coordinate access improvements and erect road signage on the N12 near the site access warning of possible construction vehicles. • Inform local road authorities and road users before unusual traffic is generated, e.g. high volumes or abnormal loads. • Obtain abnormal load permits if required. • Compile a road maintenance plan. • Stagger deliveries to the site as far as possible. • Schedule deliveries outside of commuter peak hours, especially for large vehicles / abnormal loads. • Consider scheduling shift changes to occur outside peak hours. 								
With mitigation	Local	Low	Short-term	Very Low	Probable	VERY LOW	– ve	High
	1	1	1	3				

6.9.3 Assessment of Impacts: Operational Phase

Operational phase impacts on traffic are assessed below.

6.9.3.1 Trip Generation Causing Congestion during the Operational Phase

Operational phase traffic will comprise:

- Vehicles transporting ~20 operations staff to site daily. If staff travel in private vehicles, up to 20 light vehicles would access the site daily; and
- Infrequent access by cleaning, maintenance and delivery vehicles.

In the order of 15 - 25 traffic movements per day will be generated by the PV plant during the operation phase, which is deemed negligible. Operational phase traffic will use accesses upgraded and formalised during the construction phase.

The impact is assessed to be **insignificant**.

Regular N12 access maintenance will be required during the operational phase.

6.9.4 Assessment of Impacts: Decommissioning Phase

Decommissioning phase impacts on traffic are assessed below.

6.9.4.1 Traffic Generation Causing Congestion during the Decommissioning Phase

Decommissioning phase traffic will be similar to the construction traffic, with the exception of concrete premix trucks. As such, at peak decommissioning, ~40 daily traffic movements are anticipated, of which ~50% will be heavy vehicles.

Decommissioning phase traffic will use accesses upgraded and formalised during the construction phase and maintained during the operational phase.

The additional volume of traffic generated during the decommissioning phase is significant but temporary. The N12 provides direct access to the site and is designed for heavy vehicles.

The impact is assessed to be of **very low** significance with and without the implementation of mitigation.

Table 6-50: Significance of potential trip generation during decommissioning

	<i>Extent</i>	<i>Intensity</i>	<i>Duration</i>	<i>Consequence</i>	<i>Probability</i>	<i>Significance</i>	<i>Status</i>	<i>Confidence</i>
Without mitigation	Local	Medium	Short-term	Very low	Probable	VERY LOW	– ve	High
	1	2	1	4				
Essential mitigation measures:								
<ul style="list-style-type: none"> • Inform local road authorities and road users before unusual traffic is generated, e.g. high volumes or abnormal loads. • Obtain abnormal load permits if required. • Liaise with the appropriate road authorities to erect road signage on the N12 near the site access warning of possible construction vehicles. • Maintain access to the N12. • Stagger deliveries to the site as far as possible. • Schedule deliveries outside of commuter peak hours, especially for large vehicles / abnormal loads. 								
With mitigation	Local	Low	Short-term	Very Low	Probable	VERY LOW	– ve	High
	1	1	1	3				

6.9.5 Opinion

The project will have an acceptable traffic impact. Provided that access improvements are undertaken to the appropriate standards, especially to accommodate heavy vehicle activities during the construction stage, the project can be approved from a traffic point of view.

6.9.6 The No-Go Alternative

The No Go alternative entails that the project is not developed. As such, additional traffic will not be generated, and access do not need to be improved. However, the project was deemed acceptable and the No-Go alternative is not preferred.

6.10 Potential Cumulative Impacts

6.10.1 Introduction

Anthropogenic activities can result in numerous and complex effects on the natural and social environment. While many of these are direct and immediate, the environmental effects of individual activities (or projects) can combine (additive impact) and interact (synergistic impact) with other activities in time and space to cause incremental or aggregate effects. Effects from ongoing but unrelated activities may accumulate or interact to cause additional effects (Canadian Environmental Protection Agency, no date), known as “cumulative” effects or impacts (hereafter cumulative impacts).

Cumulative impacts are defined by the International Finance Corporation (IFC, 2013) as “those that result from the successive, incremental, and / or combined effects of an action, project, or activity when added to other existing (i.e. ongoing), planned, and / or reasonably anticipated future” actions, projects or activities.

Key to the theoretical understanding of cumulative impacts is that the effects of previous and existing actions, projects or activities are already present and assimilated into the biophysical and socio-economic

baseline. For the purposes of this report, cumulative impacts are defined as 'direct and indirect project impacts that act together with external stressors and existing or future potential effects of other activities or proposed activities in the area/region that affect the same resources and/or receptors, also referred to as Valued Environmental and Social Components (VECs)'.

For the most part, cumulative effects or aspects thereof are too uncertain to be quantifiable, due to mainly lack of data availability and accuracy. This is particularly true of cumulative effects arising from potential or future projects, the design or details of which may not be finalised or available and the direct and indirect impacts of which have not yet been assessed.

6.10.2 Methodology

The IFC Good Practice Handbook for Cumulative Impact Assessment (2013), describes five / six key steps and considerations in the assessment of cumulative impacts:

- Definition of the Area of Influence (Aol);
- Identification of VECs, and their baseline condition;
- Identification of activities or stressors that contribute or are anticipated to contribute to cumulative effects in the foreseeable future (i.e. for all phases of the project);
- Implementation of a suitable methodology to assess cumulative impacts and evaluate their significance; and
- Identification of measures to manage and monitor cumulative impacts.

The **Aol** can be defined as the area likely to be affected, and the period or duration of occurrence of effects. In practice the Aol is a function of a large number of factors which have changing and varying degrees of influence on the areas surrounding the project throughout the course of the project cycle. The geographical extent of some of these factors can be partially quantified (e.g. air emissions can be defined by a delineated plume under specified meteorological conditions), whilst the extent of others is very difficult to measure (e.g. direct and indirect socio-economic effects).

In CIA it is good practice to focus on **VECs**, which are environmental and social attributes that are considered to be important in assessing risks and can be defined as essential elements of the physical, biological or socio-economic environment that may be affected by a proposed project. Types of VECs include physical features, habitats, wildlife populations (e.g. biodiversity), ecosystem services, natural processes (e.g. water and nutrient cycles, microclimate), social conditions (e.g. health, economics) or cultural aspects (e.g. traditional spiritual ceremonies). VECs should reflect public concern about social, cultural, economic, or aesthetic values, and also the scientific concerns of the professional community (Beanlands & Duinker, 1983).

In addition to the project, other past, present and future activities might have caused or may cause impacts and may interact with impacts caused by the project under review:

- **Cumulative impacts of past and existing activities:** It is reasonably straightforward to identify significant past and present projects and activities that may interact with the project to produce cumulative impacts, and in many respects, these are taken into account in the descriptions of the biophysical and socio-economic baseline; and
- **Potential cumulative impacts of planned and foreseen activities:** Relevant future projects that will be included in the assessment are defined as those that are 'reasonably foreseeable', i.e. those that have a high probability of implementation in the foreseeable future; speculation is not sufficient reason for inclusion.

Natural and social stressors can also contribute to cumulative impacts. Stressors can be defined as natural or anthropogenic aspects which cause a change in i.e. impact to the structure or function of the

environment. Natural and anthropogenic stressors often have similar components, e.g. both drought and wood harvesting result in a loss of habitat. Due to rapid increases in human population, anthropogenic stressors on the environment have increased greatly (Cairns, 2013).

Given the limited detail available regarding future developments, the analysis is of a more generic nature and focuses on key issues and sensitivities for the project and how these might be influenced by cumulative impacts with other activities. Mitigation measures for cumulative impacts are not proposed as these cannot be imposed on other developers and projects. However, the mitigations measures proposed for the project in Sections 6.2 to 6.9 will also contribute towards the mitigation of cumulative impacts.

6.10.3 Cumulative Impact Assessment

Cumulative impacts have been assessed using the same impact rating methodology used to assess impacts associated with the project (see Section 6.1.4).

Typically, many mitigation measures to address cumulative impacts cannot be implemented by the project proponent as they relate to activities outside project boundaries over which the proponent has no jurisdiction, influence or right to impose mitigation. As such, mitigation measures to be implemented *on the project* to manage cumulative impacts are identified and considered in the *with mitigation* impact rating. Where possible, additional mitigation measures are identified that would be applicable to other activities or facilities in the area and could reduce the significance of the cumulative impact if the relevant authorities are able to enforce implementation.

6.10.3.1 Identification of the Aol, VECs, Stressors and Projects Considered

Cumulative impacts for this project have been identified based on the extent and nature of the Aol of the projects, status of VECs and understanding of external natural and social stressors. These insights have been informed by engagements with project stakeholders, review of existing documentation, field observations and data collection.

The Aol has been taken as the area within a 30 km radius of the project, covering ~2 830 km², which is sufficiently large to capture cumulative impacts on ecosystem and sufficiently small to experience cumulative impacts. The VECs (considered) are those for which project impacts were identified, i.e. soil resources, freshwater and terrestrial ecology, fauna and social receptors (communities).

By and large, the cumulative impacts of past and existing projects are incorporated in the baseline (Section 4) and the focus hereafter is on planned and foreseen projects and activities. The future developments that are considered are:

- Those for which EAs have already been granted;
- Those that are currently subject to environmental authorisation applications and for which there is currently information available; and
- Those forming part of Provincial or National initiatives.

The project is part of the proposed, larger Stilfontein Cluster which comprises up to nine up to 150 MW PV facilities and ancillary infrastructure located on neighbouring properties (see Section 3.2). The total area directly affected by the proposed Stilfontein PV Cluster projects is ~30 km². The project is also located within the Klerksdorp REDZ, which may attract additional renewable energy projects while grid capacity remains available. Several solar farms within a 30 km radius of the project area received EAs in the past (see Section 4.5), though none have established. The total area taken up by these authorised renewable energy projects is ~63 km². The combined area affected by authorised renewable energy projects within the 30 km radius of the Stilfontein PV Cluster is thus ~93 km², with the Stilfontein Cluster projects accounting for ~32.5%.

The projects that are considered in the cumulative impact analysis are thus the remaining facilities in the Stilfontein Cluster and the approved solar projects listed in Table 4-7 and shown in Figure 4-27.

Natural or social stressors identified in the area of influence include:

- Veld fires, grazing and cultivation, affecting the function and composition of habitats and faunal communities;
- Powerlines and other infrastructure, posing a potential risk to avifauna; and
- Closure of local mines and dependent businesses, increasing unemployment.

6.10.3.2 Cumulative Soil and Land Capability Impacts

6.10.3.2.1 Reduction and Loss of Land Capability

The cumulative impact of the proposed and approved renewable energy projects on land capability in the region is expected to be low as the regional soil sensitivity and land capability are also expected to be low, as identified for the project area.

The cumulative impact is assessed to be of **low** significance with and without the implementation of mitigation.

Table 6-51: Significance of potential cumulative reduction and loss of land capability

	<i>Extent</i>	<i>Intensity</i>	<i>Duration</i>	<i>Consequence</i>	<i>Probability</i>	<i>Significance</i>	<i>Status</i>	<i>Confidence</i>
Without mitigation	Regional	Low	Long-term	Medium	Possible	LOW	– ve	High
	2	1	3	6				
Recommended mitigation measures:								
<ul style="list-style-type: none"> • Coordinate the stormwater management plan with nearby developments / projects. • Coordinate vegetation clearing with adjacent projects to avoid concurrent clearing over large areas wherever possible. • Coordinate the Alien Vegetation Management Plan with nearby developments / projects.. 								
With mitigation	Local	Low	Long-term	Low	Probable	LOW	– ve	High
	1	1	3	5				

6.10.3.3 Cumulative Freshwater Impacts

The project does not materially affect freshwater features at or near the project site, and does not affect, i.e. has no impact on any freshwater systems further afield. The logical inference is that the project is not expected to contribute to cumulative impacts on freshwater resources.

The cumulative freshwater impact is deemed **insignificant**.

6.10.3.4 Cumulative Terrestrial Ecology Impacts

6.10.3.4.1 Cumulative Habitat Loss, Fragmentation and Degradation

The Stilfontein Cluster is located in the Vaal Reefs Dolomite Sinkhole Woodland and Carletonville Dolomite Grassland vegetation types. The total Stilfontein Cluster footprint is 2 470 ha, which equates to the loss of ~3.9% of each habitat type in the region (Table 6-52).

Table 6-52 Cumulative loss of habitat due to Stilfontein Cluster

Vegetation Type	Pre-development (ha)	Post-development (ha)	Area lost (ha)	% lost
Carletonville Dolomite Grassland	28 878	27 760	1 118	3.9%
Vaal Reefs Dolomite Sinkhole Woodland	34 740	33 397	1 343	3.9%
Total	63 618	61 157	2 461	3.9%

Adding the potential habitat loss of other approved, proximate PV facilities will increase the cumulative loss and degradation of natural areas in the region. Long-term cumulative impacts from a number of solar farms, powerlines and substations, together with existing land take for mining, urban areas and agriculture (captured in the baseline), can eventually lead to the degradation and loss of habitat and vegetation types and loss of endemic and/or threatened species. The threshold where permanent loss at the species level occurs cannot be determined with the available information. However, the currently envisaged cumulative impact is deemed acceptable.

The cumulative impact is assessed to be of **medium** significance with and without the implementation of mitigation.

Table 6-53: Significance of potential cumulative habitat loss, fragmentation and degradation

	<i>Extent</i>	<i>Intensity</i>	<i>Duration</i>	<i>Consequence</i>	<i>Probability</i>	<i>Significance</i>	<i>Status</i>	<i>Confidence</i>
Without mitigation	Local	Medium	Long-term	Medium	Probable	MEDIUM	- ve	High
	1	2	3	6				
Recommended mitigation measures:								
<ul style="list-style-type: none"> Maintain an ecological corridor around the projects wherever possible to retain connectivity with and between areas of natural vegetation. Retain as many protected trees as possible in the project area. Coordinate flushing of fauna from site prior to construction with other nearby developments / projects to ensure fauna removes to undisturbed areas. Share access roads with nearby developments / projects wherever possible to minimise the construction of new roads. Consider sharing other infrastructure (waste management areas, laydown areas etc) with other nearby developments / projects where feasible to reduce their cumulative footprint. Coordinate the Fire Management Plan with nearby developments / projects. Coordinate the Alien Vegetation Management Plan with nearby developments / projects. Coordinate rehabilitation with nearby developments / projects. 								
With mitigation	Local	Medium	Long-term	Medium	Probable	MEDIUM	- ve	High
	1	2	3	6				

The significance of this cumulative impact could be reduced further if the relevant authorities impose the following mitigation measures on other renewable energy projects in the Aol:

- Implement ecological corridors between and around different projects wherever possible to retain connectivity with and between areas of natural vegetation.

6.10.3.5 Cumulative Avifauna Impacts

6.10.3.5.1 Bird Displacement due to Habitat Transformation

The combined (~93 km²) footprint of the renewable energy projects approved or proposed in the region equates to ~3.2% of the total area within the 30 km radius, should all projects proceed. Natural habitat in

this zone has been severely impacted by agriculture, urbanisation and industrial developments, with the result that very little pristine grassland habitat remains. This has already had a severe impact on avifauna, especially ground-living grassland species. Conversely, it could also be argued that certain development has benefited certain species, e.g. White-backed Vultures are most likely attracted to the area due to the presence of food (cattle carcasses) and suitable roosting structures (transmission lines and pylons).

The cumulative impact of the proposed Stilfontein PV Cluster projects and the other authorised PV projects on priority avifauna within the 30 km radius is considered to be of low intensity, given the relatively small area that will be affected and the current transformed state of the natural habitat within this area, which has already depleted the numbers and diversity of priority avifauna.

The cumulative impact is assessed to be of **low** significance with and without the implementation of mitigation.

Table 6-54: Significance of potential cumulative bird displacement due to habitat transformation

	<i>Extent</i>	<i>Intensity</i>	<i>Duration</i>	<i>Consequence</i>	<i>Probability</i>	<i>Significance</i>	<i>Status</i>	<i>Confidence</i>
Without mitigation	Local	Low	Long-term	Low	Probable	LOW	– ve	Medium
	1	1	3	5				
Recommended mitigation measures:								
<ul style="list-style-type: none"> • Maintain an ecological corridor around the projects wherever possible to retain connectivity with and between areas of natural vegetation. • Retain as many trees as possible in the project area. • Coordinate flushing of fauna from site prior to construction with other nearby developments / projects to ensure fauna removes to undisturbed areas. • Coordinate management and Habitat Rehabilitation Plan with nearby developments / projects. 								
With mitigation	Local	Low	Long-term	Low	Probable	MEDIUM	– ve	High
	1	1	3	5				

6.10.3.5.2 Bird Mortality due to Electrocution on Medium Voltage Power Lines

The total length of existing power lines (i.e. 11 kV and 22 kV lines) within the 30 km radius is unknown, but can safely be assumed to be hundreds of kilometres. Many of these lines could pose an electrocution risk to large raptors, particularly vultures, given the fact that many were constructed before bird-friendly designs became the norm. However, if the proposed 11-33 kV medium voltage lines of future energy projects are designed to be bird-friendly, their cumulative impact will be negligible.

The cumulative impact is assessed to be **insignificant**.

The significance of this cumulative impact could be reduced further if the relevant authorities implement the following mitigation measures on other powerlines in the Aol:

- Use bird friendly pole designs to provide safe perching space for birds; and
- Install Eskom-approved Bird Flight Diverters on overhead lines.

6.10.3.6 Cumulative Socio-Economic Impacts

6.10.3.6.1 Stimulation of Economic and Employment Growth

The nine Stilfontein Cluster PV plants together will have an installed capacity of up to 1 350 MW and are projected to generate ~3 000 GWh/annum⁴². This would represent 22% - 33% of the shortfall in installed capacity⁴³. This is a significant contribution towards reducing the shortfall in South African electricity generation and the massive economic costs of loadshedding. The cumulative impact of renewable energy IPPs on the local, regional and national economy is thus highly significant and positive. Total CapEx for the nine Stilfontein Cluster PV projects would be R9.9 billion, and total OpEx over the 20-year project life would amount to ~5.4 billion (not discounted)⁴⁴.

Investment figures and installed capacity for other projects proposed in the area are not yet available. However, considering the high CapEx for a single PV project and other IPP’s likely interest to establish in the area, it is expected that multiple billions of Rand will be spent in the national, regional and local economies. For comparison, during the first four bidding rounds, REIPPPP attracted R209.4 billion in committed private sector investment (South African Government News Agency, 2019), 24% of which is Foreign Direct Investment (Nomjana, 2020).

A spike of investment and employment will be experienced during the construction phases of individual projects. If the construction phases for several projects in the same region coincide, the cumulative investment could have a distorting effect in the local and regional economy through significantly increased (short-term) demand for certain goods and services and labour. In the worst case this could lead to inflationary pressures on wages, goods and services and make them less affordable for other businesses or individuals. This could crowd out such businesses or reduce the living standard of people who do not benefit from the renewable energy boom and cannot afford goods at higher prices. However, the presence of several towns and past and present mining activity ensures a relatively large business network and workforce in the area, and the likelihood of this impact occurring is expected to be low.

Cumulative operational phase spending by the different projects will be lower and longer-term and thus carries less distortion risk. Operational phase spending of even a few projects will deliver for a sustained long-term increase in employment and local economic activity, and also provide some indirect and induced stimulation to other sectors.

The cumulative benefit is assessed to be of **very high** significance with and without the implementation of mitigation.

Table 6-55: Significance of potential cumulative stimulation of economic and employment growth

	<i>Extent</i>	<i>Intensity</i>	<i>Duration</i>	<i>Consequence</i>	<i>Probability</i>	<i>Significance</i>	<i>Status</i>	<i>Confidence</i>
Without mitigation	Regional	High	Long-term	Very High	Probable	VERY HIGH	+ ve	High
	2	3	3	8				
Recommended mitigation measures:								
<ul style="list-style-type: none"> • Coordinate local recruitment and procurement with other nearby developments / projects where possible to streamline the application process and/or transition of workers between projects. • Consider pooling resources to provide training to appointed staff and appointed service providers on how to position themselves for other employment opportunities once construction ends. • Consider undertake a joint skills survey in the area to inform a coordinated recruitment and procurement approach. 								

⁴² Output is calculated as 1 350 MW x 2 200 MW= 2 970 GWh

⁴³ South Africa’s immediate power gap has been reported as 4 000 MW to 6 000 MW (Business Day, 2022)

⁴⁴ CapEx: R1.1 billion per project x 9 projects, OpEx: R600 million per project x 9 projects

	<i>Extent</i>	<i>Intensity</i>	<i>Duration</i>	<i>Consequence</i>	<i>Probability</i>	<i>Significance</i>	<i>Status</i>	<i>Confidence</i>
With mitigation	Regional	High	Long-term	Very High	Probable	VERY HIGH	+ ve	High
	2	3	3	8				

The significance of this cumulative impact could be reduced further if the relevant authorities implement the following mitigation measures in the AoI:

- Offer training in relevant skills to potential future workers and contractors prior to the initiation of projects.

6.10.3.6.2 Increased Community Prosperity through Contributions and Income from IPPs

Projects selected through the REIPPPP must comply with requirements aimed at sharing project benefits with HDI communities within a 50 km radius and contribute towards the growth and transformation of the South African economy.

Amounts committed to communities proposed by other projects is not yet available, but community investment is highly significant, especially in impoverished rural communities. For comparison, WWF (2015) estimates that the 64 projects approved during the first three REIPPPP bidding rounds have committed to R441 million in SED, R130 million in ED and R600 million in dividends via community shareholding, amounting to community investment of R1.17 billion over the 20-year project lifetimes. The South African government assumes much higher values based on the first four bidding rounds, including R27.1 billion net community dividend income from their shareholding over the 20-year life of these projects (Nomjana, 2020).

The funds disbursed by REIPPPP to communities are very substantial, which may create governance challenges. Communication between IPPs operating in the same region and IPPs and communities, as well as the implementation of good governance procedures, will be critical to ensuring that the funds deliver equitable benefits, and to avoid corruption and community discord over use of funds.

As of mid-2021 IPPs can also sell independently generated electricity to private end-users; such agreements are not subject to the REIPPPP socio-economic requirements.

The cumulative benefit is assessed to be of **very high** significance with and without the implementation of mitigation if the project is procured via the REIPPPP (and past REIPPPP requirements apply).

Table 6-56: Significance of potential cumulative increase in community prosperity if REIPPPP requirements apply

	<i>Extent</i>	<i>Intensity</i>	<i>Duration</i>	<i>Consequence</i>	<i>Probability</i>	<i>Significance</i>	<i>Status</i>	<i>Confidence</i>
Without mitigation	Regional	High	Long-term	Very High	Probable	VERY HIGH	+ ve	High
	2	3	3	8				
Recommended mitigation measures:								
<ul style="list-style-type: none"> Coordinate selection and implementation of SED and ED initiatives with adjacent development / project proponents as far as possible maximise the effectiveness of initiatives. Consider pooling resources of several projects to fund dedicated full-time resources to jointly manage community work and relationships with stakeholders on behalf of several adjacent IPPs. Consider pooling resources of several projects to build skills of trustees and/or other community representatives as well as systems of governance. 								
With mitigation	Regional	High	Long-term	Very High	Probable	VERY HIGH	+ ve	High
	2	3	3	8				

The cumulative benefit is assessed to be of **low** significance and with the implementation of mitigation increases to **medium** if a private end-user agreement is pursued (or past REIPPPP requirements do not apply).

Table 6-57: Significance of potential cumulative increase in community prosperity if REIPPPP requirements do not apply

	<i>Extent</i>	<i>Intensity</i>	<i>Duration</i>	<i>Consequence</i>	<i>Probability</i>	<i>Significance</i>	<i>Status</i>	<i>Confidence</i>
Without mitigation	Local	Low	Long-term	Low	Probable	LOW	+ ve	High
	1	1	3	5				
<p>Recommended mitigation measures to be implemented on the project to manage cumulative impacts:</p> <ul style="list-style-type: none"> Coordinate selection and implementation of SED and ED initiatives with adjacent development / project proponents as far as possible maximise the effectiveness of initiatives. Consider pooling resources of several projects to fund dedicated full-time resources to jointly manage community work and relationships with stakeholders on behalf of several adjacent IPPs. Consider pooling resources of several projects to build skills of community representatives as well as systems of governance. 								
With mitigation	Local	Medium	Long-term	Medium	Probable	MEDIUM	+ ve	High
	1	2	3	6				

The significance of this cumulative benefit could be increased further if the relevant authorities implement the following optimisation measures in the Aol:

- Encourage multilateral collaboration between different trusts and different IPPs, especially where there are multiple IPPs (and hence trusts) operating in the same geographic areas to improve integration and scaling of efforts and reduce duplication;
- Provide structured support to IPPs and any trusts they establish, including strategies and formats for community engagement, managing expectations, trustee elections and appointments and trust management; and
- Investigate options to improve local energy security in communities where the widespread expectation is that IPPs will solve longstanding energy woes, possibly through municipal IPP procurement, if possible.

6.10.3.7 Cumulative Heritage Impacts

6.10.3.7.1 Loss of Heritage Resources and Fossils

Cumulatively the approved and proposed projects may have a negative impact on Stone Age sites in the area if such sites are destroyed. However, the impact can be successfully mitigated with the implementation of a standard chance finds procedure.

The cumulative impact is assessed to be of **very low** significance with and without the implementation of mitigation.

Table 6-58: Significance of potential cumulative loss of heritage resources and fossils

	<i>Extent</i>	<i>Intensity</i>	<i>Duration</i>	<i>Consequence</i>	<i>Probability</i>	<i>Significance</i>	<i>Status</i>	<i>Confidence</i>
Without mitigation	Local	Low	Long-term	Low	Improbable	VERY LOW	- ve	High
	1	1	3	5				

	<i>Extent</i>	<i>Intensity</i>	<i>Duration</i>	<i>Consequence</i>	<i>Probability</i>	<i>Significance</i>	<i>Status</i>	<i>Confidence</i>
Recommended mitigation measures:								
<ul style="list-style-type: none"> Coordinate management plans and chance find procedures with nearby developments / projects where appropriate. 								
With mitigation	Local	Low	Long-term	Low	Improbable	VERY LOW	– ve	High
	1	1	3	5				

6.10.3.8 Cumulative Visual Impacts

6.10.3.8.1 Altered Sense of Place and Visual Intrusion caused by Facilities

The Stilfontein Cluster will introduce unique infrastructure into the visual landscape, comprising over 2 000 ha of PV panels, four substations and various powerlines. This infrastructure will be different in form, scale, size and texture to the surrounding infrastructure and will contrast with the largely rural and natural landscape of the surrounding area. As such, the project will alter the sense of place and diminish the scenic value of the project site and surrounding area. The man-made structures that are visible to receptors will present as a visual intrusion in the foreground to motorists or middleground or background to residential and recreational receptors. As the cluster will require some lighting, it is expected to add to existing nightglow from surrounding residential areas.

The other approved PV projects are largely located to the south-west of the project area, adjacent to existing mines. As such, these projects are likely to be more congruent with land use, form and size than the Stilfontein Cluster which is at some distance from mines in the area. Despite the comparatively small scale of those projects, they will also create visual impacts such as altered sense of place, visual intrusion and light pollution.

The cumulative impact is assessed to be of **medium** significance with and without the implementation of mitigation.

Table 6-59: Significance of potential cumulative altered sense of place and visual intrusion caused by facilities

	<i>Extent</i>	<i>Intensity</i>	<i>Duration</i>	<i>Consequence</i>	<i>Probability</i>	<i>Significance</i>	<i>Status</i>	<i>Confidence</i>
Without mitigation	Local	Medium	Long-term	Medium	Probable	MEDIUM	– ve	High
	1	2	3	6				
Recommended mitigation measures to be implemented on the project to manage cumulative impacts:								
<ul style="list-style-type: none"> Coordinate vegetation clearing with adjacent projects to avoid concurrent clearing over large areas wherever possible. Coordinate any screening of construction activities with nearby developments / projects where appropriate to improve the overall visual screening effect. Coordinate the planting of screening vegetation with nearby developments / projects where appropriate to improve the overall visual screening effect. 								
With mitigation	Local	Medium	Long-term	Medium	Probable	MEDIUM	– ve	High
	1	2	3	6				

6.10.3.8.2 Visual Discomfort and Impaired Visibility caused by Glint and Glare

The introduction of a vast array of reflective surfaces will generate glare which is expected to impact surrounding receptors, mainly to the east and west, and motorists along the N12, Unnamed Road East and Vermaasdrift Road during certain times of the day in select periods of the year. Cumulatively, exposure to

glare from the Stilfontein Cluster does not exceed 30 minutes per day at any one receptor, and as such is not considered to be high or a fatal flaw; however, is likely to be a nuisance to some receptors.

The additional approved projects and the Stilfontein PV Cluster are expected to alter the sense of place, adding to anthropogenic transformation in the rural / peri-urban landscape environment. Cumulative light pollution is also expected to increase as this impact has a larger zone of influence than direct visual intrusion, for example.

It is relevant to note that, while the cumulative visual impact is considered significant, these projects fall within the Klerksdorp REDZ, a designated area where such projects are encouraged, *inter alia*, by streamlining of EA processes.

The cumulative impact is assessed to be of **medium** significance with and without the implementation of mitigation.

Table 6-60: Significance of potential cumulative visual discomfort and impaired visibility caused by glint and glare

	<i>Extent</i>	<i>Intensity</i>	<i>Duration</i>	<i>Consequence</i>	<i>Probability</i>	<i>Significance</i>	<i>Status</i>	<i>Confidence</i>
Without mitigation	Local	Medium	Long-term	Medium	Probable	MEDIUM	– ve	High
	1	2	3	6				
Recommended mitigation measures:								
<ul style="list-style-type: none"> Coordinate the planting of screening vegetation with nearby developments / projects where appropriate to improve the overall visual screening effect. 								
With mitigation	Local	Medium	Long-term	Medium	Probable	MEDIUM	– ve	High
	1	2	3	6				

6.10.3.9 Cumulative Traffic Impacts

6.10.3.9.1 Additional Trip Generation

The construction of solar projects generates additional traffic, including heavy and abnormal load vehicles.

If the construction phases for several projects in the same region coincide, the cumulative traffic generation could be significant. This is especially true if several Stilfontein Cluster projects are constructed concurrently and accessed via the same access point off the N12. While the traffic impacts of one project are very low, the impact increases significantly if the number of vehicles using the same access point increases (up to) ninefold. In that case an analysis should be undertaken to confirm the capacity and design of project site access point(s) during the construction phases.

The operational phase traffic impact is considered negligible even if all facilities operate concurrently.

The cumulative impact is assessed to be of **medium** significance with and without the implementation of mitigation.

Table 6-61: Significance of potential cumulative trip generation

	<i>Extent</i>	<i>Intensity</i>	<i>Duration</i>	<i>Consequence</i>	<i>Probability</i>	<i>Significance</i>	<i>Status</i>	<i>Confidence</i>
Without mitigation	Local	High	Medium-term	Medium	Probable	MEDIUM	– ve	High
	1	3	2	6				
Recommended mitigation measures:								

	<i>Extent</i>	<i>Intensity</i>	<i>Duration</i>	<i>Consequence</i>	<i>Probability</i>	<i>Significance</i>	<i>Status</i>	<i>Confidence</i>
<ul style="list-style-type: none"> • Coordinate the construction of access to the project site with nearby developments / projects where appropriate to ensure the access capacity is sufficient for cumulative project traffic volume. • Coordinate the implementation of a road maintenance plan with nearby developments / projects. • Coordinate traffic to the larger project site with nearby developments / projects, including delivery times (especially for heavy vehicles and abnormal loads) and shift changes, to ensure efficient access to the site especially during traffic peak hours. 								
With mitigation	Local	Medium	Long-term	Medium	Probable	MEDIUM	- ve	High
	1	2	3	6				

7 Conclusions and Recommendations

This chapter evaluates the impact of the Sparrow PV Facility. The principal findings are presented in this chapter, followed by an analysis of the need and desirability of the project and a discussion of the key factors DFFE would consider in order to take a decision which is aligned with the principles of sustainable development and South Africa's commitments to reducing carbon emissions effected in part through a just transition to renewable energy. Key recommendations are also presented.

The project has the potential to cause impacts, both negative and positive. The BA has examined the available project information and drawn on both available (secondary) and specifically collected (primary) baseline data to identify and evaluate environmental (biophysical and socio-economic) impacts of the proposed project. The BAR aims to inform stakeholders and decision-makers of the key considerations by providing an objective and comprehensive analysis of the potential impacts and benefits of the project and has created a platform for the formulation of mitigation measures to manage these impacts, presented in the EMPr (see Appendix E⁴⁵).

This chapter presents the general conclusions drawn from the BA process, which should be considered in evaluating the project. It should be viewed as a supplement to the detailed assessment of individual impacts presented in Chapter 6 and the specialist studies in Appendix C.

7.1 Environmental Impact Statement

The EIA Regulations, 2014 prescribe the required content of a BAR, including, inter alia, an EIS, which is presented below.

7.1.1 Evaluation and Summary of Positive and Negative Impacts

The evaluation is undertaken in the context of:

- The project information provided by the proponent;
- The assumptions made for this BAR;
- The assumption that the recommended (essential) mitigation measures will be effectively implemented; and
- The assessments provided by specialists.

This evaluation aims to provide answers to a series of key questions posed as objectives at the outset of this report, which are repeated here:

- Assess in detail the environmental and socio-economic impacts that may result from the project;
- Identify environmental and social mitigation measures to address the impacts assessed; and
- Produce BAR that will assist DFFE to decide whether (and under what conditions) to authorise the proposed development.

⁴⁵ As noted in Section 2.1.1.4, transmission line projects triggering LN1 Activity 11 where the greater part of the facility is located within a REDZ must use the:

- Generic EMPr for the Development and Expansion of Substation Infrastructure for Transmission and Distribution of Electricity; and / or
- Generic EMPr for the Development and Expansion of Overhead Electricity Transmission and Distribution Infrastructure,

published in GN 435 of 2019. As such, these EMPrs are provided in Appendix E as appropriate, together with any project-specific measures.

The evaluation and the basis for the subsequent discussion are represented concisely in Table 7-1, which summarises the potentially significant impacts and their significance ratings before and after application of mitigation and/or optimisation measures.

Relevant observations with regard to the overall impact ratings, assuming mitigation measures are effectively implemented, are:

- The predicted *land capability* impacts are rated as *very low*, as soil resources are not sensitive and existing land capability is low. It is expected that grazing can continue in much of the area after decommissioning of the project.
- The predicted *terrestrial ecology* impacts are rated as *very low* for monofacial panel technology (which requires limited vegetation clearing), and *medium* for bifacial panel technology (which requires placement of reflective gravel across the PV site). Impacts are mainly associated with the degradation, loss and fragmentation of habitat due to installation of infrastructure and facilities and, to a lesser degree, displacement of fauna due to disturbance. The project site overlays an ESA, but is degraded by grazing and other historic anthropogenic activities.
- The predicted impacts on *avifauna* are rated as *medium* during construction and *low* during operations. Construction phase impacts are mainly associated with habitat loss and disturbance, while collisions with and electrocution by powerlines present the greatest risks during operations. However, these can be effectively mitigated through standard design measures, and the likelihood of impacting the more sensitive Red List priority species is remote.
- The predicted *socio-economic benefits* are rated as *medium* during construction and *high* during operations, if community ownership is implemented, otherwise *medium*. Benefits are associated with economic stimulation through investment and generation of (limited) employment in an area negatively affected by mine closures, and CSI initiatives. Community income through partial ownership in the project – if past REIPPPP requirements are implemented – would be the most significant potential benefit but requires careful management to prevent social disruption and conflict.
- The predicted *heritage* impacts are rated as *very low*. Impacts are mainly associated with the damage to and loss of heritage resources and fossils, while effective documentation and/or recovery of resources would present a benefit. No significant resources were identified.
- The predicted *visual* impacts are rated as *very low* during construction. However, during the operational phase, some impacts resulting from altered sense of place, visual intrusion and light pollution at night are considered to be of *medium* significance.
- The predicted *traffic* impacts are rated as *very low* during construction and decommissioning. Impacts are mainly associated with the generation of additional (heavy and abnormal load) vehicle trips potentially causing congestion at the site access from the N12.
- The impact of *alternative* monofacial and bifacial panel technologies differs primarily in the extent and intensity of vegetation clearing, and hence the significance of terrestrial ecology impacts. Vegetation clearing is less extensive for monofacial panels, which are thus preferred from an ecological impact perspective, though both alternatives are deemed acceptable.
- Two substation location with associated powerline corridor *alternatives* were examined. All specialist studies agreed that there was no discernible difference in the impacts resulting from either alternative, with the exception of the Terrestrial Ecology study, which marginally favoured the alternative location

Table 7-1: Summary of potential impacts of the Sparrow PV Facility

Potential negative impacts are shaded in reds, benefits are shaded in greens.
 Only **key** mitigation / optimisation measures are presented.

Impact	Significance rating		Preferred <u>Panel Technology Alternative</u> ⁴⁶	Key mitigation / optimisation measures
	Before mitigation/optimisation	After mitigation/optimisation		
CONSTRUCTION PHASE IMPACTS				
Soil and Land Capability Impacts				
Reduction and loss of land capability	Very low	Very low	n/a	<ul style="list-style-type: none"> • Compile and implement a Stormwater Management Plan. • Drive only on approved access roads to avoid unnecessary compaction. • Clear vegetation only once construction is imminent, to reduce cleared areas and minimise erosion risk. • Store and maintain topsoil as per best practice in order to utilise it for rehabilitation of eroded areas. • Implement the Alien Vegetation Management Plan. • Park equipment and vehicles on impermeable surfaces or utilise drip trays to prevent hydrocarbon spills and monitor daily for fluid leaks. • Remediate hydrocarbon spills immediately. • Report hydrocarbon spills to the appropriate authorities if significant contamination of the environment occurs.
Terrestrial Ecology Impacts				
Degradation and loss of habitat and protected species	Panel Technology One	Panel Technology One (monofacial panels)		<ul style="list-style-type: none"> • Demarcate the construction footprint with visible barriers (i.e. safety tape / fencing and signage). • <u>Demarcate the high rocky ridges as No-Go area for Construction.</u> • Restrict vegetation clearing to the minimum required and do not clear vegetation outside of the development footprint. • Clear vegetation by hand cutting to avoid heavy machinery, as far as practically possible. • Limit construction of new roads as much as possible.

⁴⁶ There is no difference in any impacts from any of the other alternatives assessed (see Table 3-1)

Impact	Significance rating		Preferred <u>Panel Technology</u> Alternative ⁴⁶	Key mitigation / optimisation measures
	Before mitigation/ optimisation	After mitigation/ optimisation		
				<ul style="list-style-type: none"> • Avoid land clearing and disturbance of rocky habitats. • Minimise the number (and size) of laydown, storage and staff facilities. • Remove all remaining construction materials once the construction phase ends. • Store topsoil stockpiles on flat ground and use bunds and/or other stabilisation methods (e.g., netting) to avoid erosion. • Obtain relocation or destruction permits before any protected trees (<i>Vachellia erioloba</i>) are relocated or destroyed. • Compile and implement a Hydrocarbon Spill Management Plan; • Compile and implement a Fire Management Plan. • Appoint a rehabilitation specialist to develop and implement a Habitat Rehabilitation Plan from the onset of the project. • Rehabilitate areas as soon as they are no longer impacted by construction. • Utilise indigenous vegetation only for habitat rehabilitation. • Return topsoil as soon as possible. • Apply surplus topsoil / rehabilitation material to other areas in need of stabilisation and vegetation cover. • Implement strict dust control for all roads and bare (unvegetated) areas. • Reduce dust generated by vehicles and earth moving machinery, through wetting the soil surface (with non-potable water) and erecting speed limit signage to enforce speed limits. • Prohibit the use of non-environmentally friendly dust suppressants to avoid pollution of water sources.
			Panel Technology Two	
	High	Medium		<ul style="list-style-type: none"> • As for Panel Technology One
Spread of alien and invasive species	Panel Technology One		Panel Technology One (monofacial panels)	

Impact	Significance rating		Preferred <u>Panel Technology</u> Alternative ⁴⁶	Key mitigation / optimisation measures
	Before mitigation/optimisation	After mitigation/optimisation		
	Very low	Very low		<ul style="list-style-type: none"> • Compile and implement an Alien Vegetation Management Plan, including but not limited to identification of areas for action (if any), prescription of the necessary removal methods and frequencies, monitoring plan and requirements for updates. • Compile and implement a Waste Management Plan to: <ul style="list-style-type: none"> ○ Prioritize waste management such that all waste is collected, stored and disposed of adequately. ○ Collect and dispose of all waste generated on site, at least on a weekly basis, to prevent rodents and pests. ○ Ensure waste storage bins have lids and are secured to prevent falling over. • Compile and implement a pest control plan that does not include the use of poison as a control measure.
	Panel Technology Two			
	Low	Very low		<ul style="list-style-type: none"> • As for Panel Technology One
Displacement and loss of fauna	Panel Technology One	Panel Technology One (monofacial panels)		
	Very low	Very low		<ul style="list-style-type: none"> • Demarcate the construction footprint with visible barriers (i.e. safety tape / fencing and signage). • Restrict vegetation clearing to the minimum required and do not clear vegetation outside of the development footprint. • Areas should be cleared and disturbed only as and when needed. • Minimise the time between clearing of an area and subsequent development to avoid fauna from re-entering the site to be disturbed. • Flush sites (one or two persons walking the area) prior to vegetation clearing activities to encourage fauna to move off site (not more than one day in advance of clearing). • Restrict construction activities to as few discrete areas as possible, allowing fauna to move off site as activities progress. • Excavate holes / excavations on a needs only basis. • Cover open holes / excavations overnight to prevent fauna mortalities. • Provide environmental awareness training to all personnel and contractors regarding: <ul style="list-style-type: none"> ○ Sensitive environmental receptors within the project area; ○ Management requirements in the Environmental Authorisation and the EMPr;

Impact	Significance rating		Preferred <u>Panel Technology</u> Alternative ⁴⁶	Key mitigation / optimisation measures
	Before mitigation/ optimisation	After mitigation/ optimisation		
				<ul style="list-style-type: none"> ○ How to deal with any fauna species encountered during the construction process; ● Obtain permits for the relocation of animals during construction as and if required.
			Panel Technology Two	
	Medium	Very low		<ul style="list-style-type: none"> ● As for Panel Technology One
Avifauna Impacts				
Bird displacement due to disturbance	Low	Very low	n/a	<ul style="list-style-type: none"> ● Restrict construction activities to the immediate development footprint. ● Minimise construction of new roads. ● Demarcate access roads clearly. ● Prohibit off-road driving. ● Undertake regular ECO audits / inspections to report on compliance with the EMPr (including compliance with noise control mechanisms). ● Include avifauna impacts of off-road driving in construction staff environmental awareness training. ● Implement best practice measures to control noise and dust. ● <u>Retain or relocate existing waterpoints to ensure at least four waterpoints are retained within the Stilfontein Project Cluster, one of which must be in the north west and one in the south east of the Cluster.</u>
Bird displacement due to habitat transformation	High	Medium	n/a	<ul style="list-style-type: none"> ● Restrict activities to the development footprint. ● Implement best practice measures to control noise and dust. ● Demarcate access roads clearly. ● Prohibit off-road driving. ● Minimise construction of new roads. ● <u>Retain or relocate existing waterpoints to ensure at least four waterpoints are retained within the Stilfontein Project Cluster, one of which must be in the north west and one in the south east of the Cluster.</u> ● Implement and strictly enforce the mitigation measures proposed by the botanical specialist. ● Appoint a rehabilitation specialist to develop and implement a Habitat Rehabilitation Plan. ● Conduct site inspections to monitor the progress of rehabilitation, as and when required based on specialist recommendations according to the Habitat Rehabilitation Plan.

Impact	Significance rating		Preferred <u>Panel Technology Alternative</u> ⁴⁶	Key mitigation / optimisation measures
	Before mitigation/ optimisation	After mitigation/ optimisation		
				<ul style="list-style-type: none"> Implement adaptive management to ensure vegetation rehabilitation goals are met
Socio-Economic Impacts				
Capital investment contributing to the national, regional and local economy	Medium	Medium	n/a	<ul style="list-style-type: none"> Source as many goods and services as possible from the local and regional economy (e.g. use local contractors and accommodation and equipment suppliers as far as possible and purchase perishable goods locally). Provide suitable training to service providers, where possible and practicable. Develop and implement a fair and transparent procurement policy. Provide training to appointed staff and appointed service providers on how to position themselves for other employment opportunities once construction ends. Consult with existing IPP projects that successfully procure from local SMMEs to share learnings, where possible.
Generation of employment, income and skills	Low	Medium	n/a	<ul style="list-style-type: none"> Maximise use of local skills and resources through preferential employment of locals where practicable. Develop, communicate and implement a fair and transparent labour and recruitment policy. Ensure diversity and gender equality in recruitment, as far as possible. Provide training to staff and service providers before and/or during the construction phase. Provide training to appointed staff and appointed service providers on how to position themselves for other employment opportunities once construction ends.
Social disruption and change in social dynamics	Very Low	Insignificant	n/a	<ul style="list-style-type: none"> Clearly publicise and implement a local recruitment policy. Work together with impartial local representatives to identify local people during the recruitment process. Consult with the municipality regarding the capacity of existing services and infrastructure (e.g. provision of water, electricity, waste removal, sanitation and housing) to cope if significant numbers of additional workers are brought into the area during the construction period. Consider supporting projects that improve local services and infrastructure and/or deal with social problems or conflicts through the social upliftment programme, if the need arises.
Reduced quality of life and increased risks due to construction near residences	Very Low	Insignificant	n/a	<ul style="list-style-type: none"> Liaise with nearby residents (up to ~2 km from the project boundary) before and during construction to inform them of construction status and discuss safety management measures to reduce security risks. Maintain a visible security presence on site. Implement a grievance mechanism at the start of the construction phase.

Impact	Significance rating		Preferred <u>Panel Technology</u> Alternative ⁴⁶	Key mitigation / optimisation measures
	Before mitigation/ optimisation	After mitigation/ optimisation		
				<ul style="list-style-type: none"> • Communicate and implement a compensation procedure in the event of damages directly linked to the construction. • Control site access. • Provide transportation to site for workers. • Declare areas outside of the construction site as no-go areas for construction staff. • Erect and regularly inspect a boundary fence. • Regularly inspect the project area and surrounding area for signs of illegal activity. • Regularly clean any litter from the project area and surrounding area.
Heritage and Palaeontology Impacts				
Loss of heritage resources	Very low	Very low	n/a	<ul style="list-style-type: none"> • Employ an ECO to monitor the construction activities. • Implement a chance find procedure for palaeontology and heritage finds.
Visual Impacts				
Altered Sense of Place and Visual Intrusion	Low	Very low	n/a	<ul style="list-style-type: none"> • Limit vegetation clearance and the footprint of construction to what is absolutely essential. • Consolidate the footprint of the construction camp to a functional minimum. • Avoid excavation, handling and transport of materials which may generate dust under very windy conditions. • Cover stockpiled aggregates and sand to minimise dust generation. • Implement dust suppression on access roads during dry conditions. • Keep construction site tidy.
Traffic Impacts				
Trip generation	Low	Very low	n/a	<ul style="list-style-type: none"> • Design and construct an appropriate and formalised access to the site from the N12, if and when the project is awarded preferential bidder status. • Liaise with the appropriate road authorities to coordinate access improvements and erect road signage on the N12 near the site access warning of possible construction vehicles. • Inform local road authorities and road users before unusual traffic is generated, e.g. high volumes or abnormal loads.

Impact	Significance rating		Preferred <u>Panel Technology</u> Alternative ⁴⁶	Key mitigation / optimisation measures
	Before mitigation/ optimisation	After mitigation/ optimisation		
				<ul style="list-style-type: none"> • Obtain abnormal load permits if required. • Compile a road maintenance plan. • Stagger deliveries to the site as far as possible. • Schedule deliveries outside of commuter peak hours, especially for large vehicles / abnormal loads. • Consider scheduling shift changes to occur outside peak hours.

OPERATION PHASE IMPACTS				
Reduction and loss of land capability	Very low	Very low	n/a	<ul style="list-style-type: none"> • Compile and implement a Stormwater Management Plan. • Drive only on approved access roads to avoid unnecessary compaction. • Park equipment and vehicles on impermeable surfaces or utilise drip trays to prevent hydrocarbon spills and monitor daily for fluid leaks. • Remediate hydrocarbon spills immediately. • Report hydrocarbon spills to the appropriate authorities if significant contamination of the environment occurs. • Implement the Alien Vegetation Management Plan. • Implement the Habitat Restoration Plan guided by the botanical specialist.
Terrestrial Ecology Impacts				
Degradation and fragmentation of habitat	Panel Technology One		Panel Technology One (monofacial panels)	<ul style="list-style-type: none"> • Prohibit staff from bringing or removing any plant species (whether indigenous or exotic) to or from the project site to prevent the spread of exotic or invasive species or the illegal collection of plants. • Implement the Alien Vegetation Management Plan.
	Very low	Very low		
	Panel Technology Two			<ul style="list-style-type: none"> • As per Panel Technology One
Spread of alien and invasive species	Panel Technology One		Panel Technology One (monofacial panels)	<ul style="list-style-type: none"> • Implement the Alien Vegetation Management Plan. • Implement the Waste Management Plan.
	Very low	Very low		
	Panel Technology Two			<ul style="list-style-type: none"> • As per Panel Technology One
Displacement and loss of fauna	Panel Technology One		Panel Technology One (monofacial panels)	

OPERATION PHASE IMPACTS				
	Very low	Very low		<ul style="list-style-type: none"> Design outside lighting to limit impacts on fauna. <ul style="list-style-type: none"> Fit lighting fixtures with baffles, hoods or louvres and directed light downward. Direct outside lighting away from sensitive areas such as the wetland. Avoid fluorescent and mercury vapor lighting. Utilise sodium vapor (yellow) lights wherever possible. Utilise motion detection lighting wherever possible to minimise the unnecessary illumination of areas. Minimise traffic during the night. Minimise noise from dusk to dawn to reduce disturbance of amphibian species and nocturnal mammals. Obtain permits for the relocation of animals as and if required.
	Panel Technology Two			
	Low	Very low		<ul style="list-style-type: none"> As per Panel Technology One
Avifauna Impacts				
Bird mortality due to collision with solar panels	Very low	Very low	n/a	<ul style="list-style-type: none"> None
Bird mortality due to entrapment in perimeter fences	Low	Very low	n/a	<ul style="list-style-type: none"> Use a single perimeter fence. For single wire fences, increase the spacing between at least the top two wires to a minimum of 30 cm and ensure they are correctly tensioned to reduce the snaring risk for owls.
Bird mortality due to electrocution	High	Low	n/a	<ul style="list-style-type: none"> Bury 33 kV cables where possible. Use Eskom approved bird friendly pole design approved by an avifaunal specialist (preferably the inverted T design with a cross-arm and suspended insulators to provide safe perching space for large birds, especially vultures.) Investigate electrocution incidents and implement appropriate mitigation by insulating any hardware that causes repeat electrocutions.
Bird mortality due to collision with transmission lines	High	Low	n/a	<ul style="list-style-type: none"> Mark all the sections of 11-33kV overhead lines with Eskom approved Bird Flight Diverters according to the applicable Eskom standard.
Bird displacement due to disturbance	Low	Very low		<ul style="list-style-type: none"> Limit the area of activity to the immediate footprint of the infrastructure as possible. Demarcate access roads clearly. Prohibit off-road driving. Restrict access to areas outside of the site boundary.

OPERATION PHASE IMPACTS				
			<ul style="list-style-type: none"> Implement best practice measures to control noise and dust. Undertake regular ECO audits / inspections to report on compliance with the EMPr. 	
Socio-Economic Impacts				
Operational investment contributing to the national, regional and local economy	Medium	Medium	n/a	<ul style="list-style-type: none"> Source as many goods and services as possible from the local and regional economy (e.g. use local contractors and accommodation and equipment suppliers as far as possible and purchase perishable goods locally). Provide suitable training to service providers, where possible and practicable. Develop and implement a fair and transparent procurement policy.
Generation of employment, income and skills	Low	Low	n/a	<ul style="list-style-type: none"> Maximise use of local skills and resources through preferential employment of locals where practicable. Develop and implement a fair and transparent labour and recruitment policy. Ensure diversity and gender equality in recruitment, as far as possible. Provide suitable training. Provide ancillary training to workers on maximising the use of income and training to further future economic prospects, potentially through projects initiated as part of the social upliftment programme.
Increased community prosperity through contributions and income from the project	If procured via the REIPPPP		n/a	
	Medium	High		<ul style="list-style-type: none"> Regularly engage with community stakeholders to develop meaningful strategies for community development. Define a vision for economic development in consultation with communities. Develop a Governance Plan with clear governance rules for a Community Trust, including administration and trustee and beneficiary selection (if applicable). Ensure that funding requirements for each project are considered into the future so that projects are viable and sustainable. Set clear goals for each project and phase out funding once these goals are achieved. Ensure regular external auditing of the Community Trust as well as supported projects (if applicable). Consider auditing projects for several years after funding has ceased to ensure their benefits are sustained.

OPERATION PHASE IMPACTS

If a private end-user agreement is pursued

Low Low

- Regularly engage with community stakeholders to develop meaningful strategies for community development.
- Define a vision for economic development in consultation with communities.
- Ensure that funding requirements for each project are considered into the future so that projects are viable and sustainable.
- Set clear goals for each project and phase out funding once these goals are achieved.

Visual Impacts

Altered sense of place and visual intrusion caused by the PV array

High Medium

- Plant tall vegetation (~5 m in height) along the boundary of the site upon completion of construction, to screen the site but not cast shadow across the PV array.
- Fence the perimeter of the site with a green or black fencing.

Altered sense of place and visual intrusion caused by the 11-33kV powerlines and pylons

Low Low

- Do not install or affix lights on pylons.

Altered sense of place and visual intrusion caused by the BESS and IPP side substation

Medium Medium

- Consolidate the BESS and on-site substation footprint, if possible.
- Ensure that the on-site substation roof and BESS container colour blends into the landscape.
- Limit the stacking of containers to a height of 10 m.

Visual discomfort and impaired visibility (glint and glare)

High Low

- Plant tall vegetation (~5 m in height) along the boundary of PV array to screen the PV panels from receptors, to screen the site but not cast shadow across the PV array.
- Fence the perimeter of the site with a green or black fencing.

Altered visual quality from nightglow

Medium Medium

- Reduce the height of lighting masts to a workable minimum.
- Direct lighting inwards and downwards to limit light pollution.

OPERATION PHASE IMPACTS

DECOMMISSIONING PHASE IMPACTS

Terrestrial Ecology Impacts

Degradation and fragmentation of habitat	Panel Technology One	Panel Technology One (monofacial panels)	
	Very low	Very low	<ul style="list-style-type: none"> • Confine closure and rehabilitation activities to the disturbed footprint areas only. • Declare all areas outside of the disturbed footprint as 'no-go' areas. • Avoid access to previously undisturbed or already rehabilitated areas. • Reduce dust generated by vehicles and earth moving machinery through wetting the soil surface (with non-potable water) and erecting speed limit signage. • Implement the Habitat Rehabilitation Plan. • Utilise indigenous vegetation for habitat rehabilitation. • Implement the Alien Vegetation Management Plan.
	Panel Technology Two		
	Low	Very low	<ul style="list-style-type: none"> • As per Panel Technology One
Spread of alien and invasive species	Panel Technology One	Panel Technology One (monofacial panels)	
	Very low	Insignificant	<ul style="list-style-type: none"> • Implement the Alien Vegetation Management Plan. • Update the Alien Vegetation Management Plan to include estimated monitoring frequency post-closure and indicate when the plan no longer needs to be implemented, to be compliant with legislated requirements at the time.
	Panel Technology Two		
	Low	Insignificant	<ul style="list-style-type: none"> • As per Panel Technology One
Degradation and fragmentation of habitat	Panel Technology One	Panel Technology One (monofacial panels)	
	Very low	Very low	<ul style="list-style-type: none"> • Limit closure and rehabilitation activities to the disturbed footprint areas only. • Declare all areas outside of the disturbed footprint as 'no-go' areas. • Avoid access to previously undisturbed or already rehabilitated areas. • Utilise indigenous vegetation for habitat rehabilitation.

OPERATION PHASE IMPACTS				
				<ul style="list-style-type: none"> • Reduce dust generated by vehicles and earth moving machinery through wetting the soil surface (with non-potable water) and erecting speed limit signage to enforce speed limits. • Implement the Habitat Rehabilitation Plan. • Implement the Alien Vegetation Management Plan.
Avifauna Impacts				
Bird displacement due to disturbance	Low	Very low	n/a	<ul style="list-style-type: none"> • Limit the area of activity to the immediate footprint of the infrastructure as possible. • Demarcate access roads clearly. • Prohibit off-road driving. • Restrict access to areas outside of the site boundary. • Implement best practice measures to control noise and dust. • Undertake regular ECO audits / inspections to report on compliance with the EMPr.
Socio-Economic Impacts				
Reduced employment and funding	Very low	Very low	n/a	<ul style="list-style-type: none"> • Clearly communicate project duration to staff and communities. • Prolong the operational life of the project as much as possible. • Assist with recommendations and referrals where possible. • Assist with the sustainable administration of funds throughout the project lifetime.
Traffic Impacts				
Trip generation	Very low	Very low	n/a	<ul style="list-style-type: none"> • Inform local road authorities and road users before unusual traffic is generated, e.g. high volumes or abnormal loads. • Obtain abnormal load permits if required. • Liaise with the appropriate road authorities to erect road signage on the N12 near the site access warning of possible construction vehicles. • Maintain access to the N12. • Stagger deliveries to the site as far as possible. • Schedule deliveries outside of commuter peak hours, especially for large vehicles / abnormal loads.

- *Cumulative impacts* in the region may derive from past and ongoing agricultural and mining activities (captured in the baseline) and the proposed development of the entire Stilfontein Cluster as well as additional renewable energy projects in the Klerksdorp REDZ – five projects have been approved or are under investigation. Potential cumulative impacts of *very low* or *low* significance are associated with displacement of avifauna due to habitat transformation, reduction of soil capability and loss of heritage resources. Potential cumulative impacts of *medium* significance are associated with terrestrial ecology (degradation, fragmentation and loss of habitat) and visual impacts (alteration of sense of place, visual intrusion and generation of limited glint and glare) and traffic (trip generation and congestion). Cumulative socio-economic benefits are of *very high* significance if income from project ownership is equitably disbursed and appropriately managed. The contribution of the project to cumulative impacts is relatively limited at a regional scale.

7.1.2 Integrated Project and Sensitivity Map

The EIA Regulations, 2014 prescribe that an integrated map at an appropriate scale is presented in the EIS. The map should, so far as it is applicable, superimpose the proposed activity and associated structures and infrastructure on the environmental sensitivities of the preferred site indicating any areas that should be avoided, including buffers. The integrated sensitivity map for the Sparrow PV project is provided in Figure 7-1 and for the overall Stilfontein Cluster area in Figure 7-2.

7.1.3 Principal Findings

The project will entail so-called triple bottom line costs and/or benefits. The triple bottom line reflects the three pillars of sustainability and concerns itself with environmental (taken to mean biophysical) sustainability, social equity and economic efficiency and is typically employed by companies seeking to report on their performance. The concept serves as a useful construct to frame the evaluation of the effects of the project.

The challenge for DFFE is to take a decision which is sustainable in the long term and which will probably entail trade-offs between environmental, social and economic costs and benefits. The trade-offs are documented in the report, which assesses environmental impacts and benefits and compares these to the No-Go alternative. SRK believes it will be instructive to reduce the decision factors to the key points which the authorities should consider. These points constitute the principal findings of the BA:

1. Mainstream intends to construct a new up to 150 MW PV facility and associated infrastructure on a ~200 ha site to generate, store and evacuate renewable energy to the national grid. The project includes the PV arrays, a BESS, the 2ha IPP-side of the 11-33/132 kV Sparrow on-site substation and 11-33 kV transmission lines connecting the PV plant to the BESS and on-site substation, as well as associated infrastructure such as access roads.
2. The purpose of the project is to improve the capacity and reliability of electrical supply to South Africa.
3. The project forms part of the proposed ~2 114 ha Stilfontein Cluster that comprises up to nine up to 150 MW PV facilities and up to nine BESS, nine on-site substations and one MTS as well as associated infrastructure such as access roads. The proposed project is intended to form part of a submission under the REIPPPP. If bidding is unsuccessful and a private offtake opportunity arises, this may be pursued.
4. South Africa experiences regular loadshedding due to insufficient power generation, mostly from thermal power plants with high GHG emissions. The project will significantly increase power generation capacity (reducing loadshedding, boosting economic productivity and improving quality of life) and is aligned with South Africa's commitments to reducing carbon emissions and climate change impacts, effected in part through a just transition to renewable energy.
5. The project is located on private land in a rural area used primarily for grazing.

6. Economic activity in the region has reduced with the closure of many local mines.
7. Potential environmental aspects considered include freshwater, terrestrial ecology and avifauna, land capability, socio-economic, heritage, visual and traffic impacts.
8. Key ecological impacts are associated with a loss in vegetation and avifauna mortality. These impacts are mitigated to acceptable levels through the strict implementation of the EMPr.
9. The impacts associated with both panel technology alternatives are considered to be acceptable.
10. The socio-economic benefits of economic growth, employment, CSI and partial community ownership in the PV project (if implemented) are important considerations.
11. The No-Go alternative implies that the project will not be implemented, significant benefits will not accrue and increased electrical supply will not be secured (from this project), while (acceptable) adverse impacts will also not materialise. As potential project impacts were deemed acceptable and outweighed by potential benefits, the No-Go alternative is not preferred.
12. A number of mitigation and monitoring measures have been identified to avoid, minimise and manage potential environmental impacts associated with the project. These are further laid out in the EMPr⁴⁷.

⁴⁷ The Generic EMPrs for substations and overhead transmission infrastructure were used as appropriate.

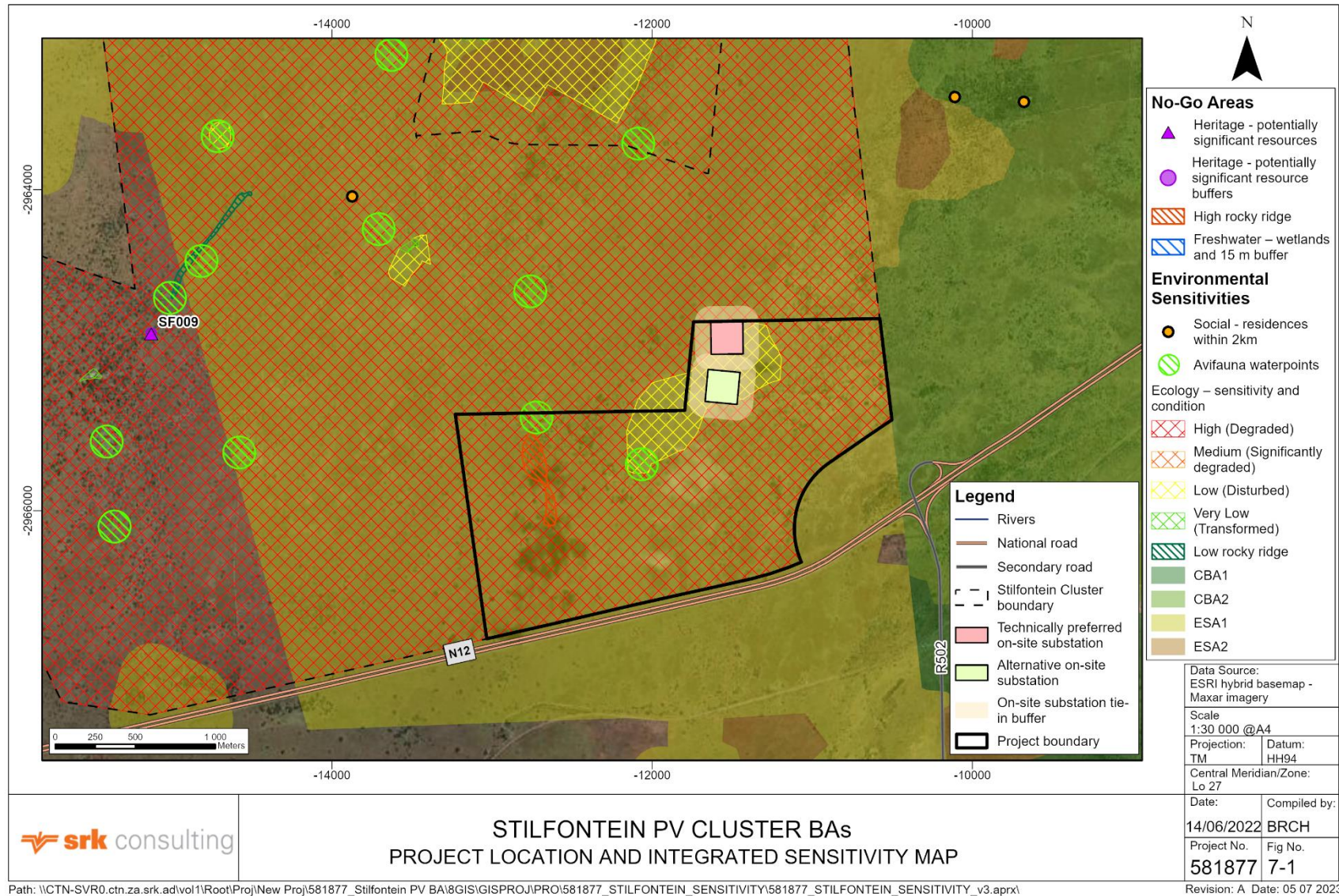

Figure 7-1: Integrated sensitivity map: Sparrow

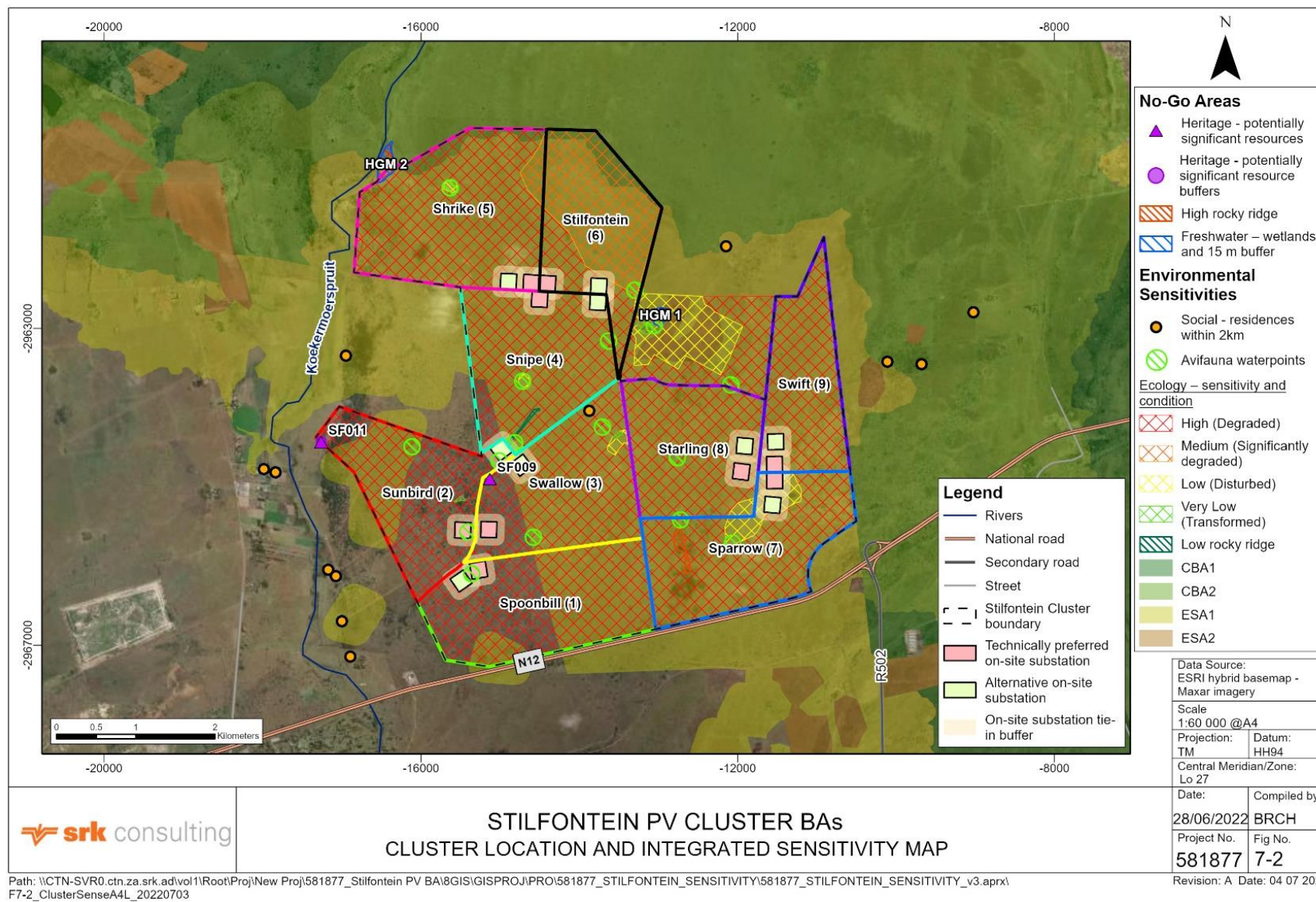

Figure 7-2: Integrated sensitivity map: Stilfontein Cluster area

7.2 Analysis of Need and Desirability of the Project

Best practice as well as the EIA Regulations, 2014 (Appendix 3 Section 3 [f]) requires that the need and desirability of a project (including viable alternatives) are considered and evaluated against the tenets of sustainability. This requires an analysis of the effect of the project on *social, economic and ecological* systems; and places emphasis on consideration of a project's *justification* not only in terms of financial viability (which is often implicit in a [private] proponent's intention to implement the project), but also in terms of the specific needs and interests of the community and the opportunity cost of development (DEA&DP, 2013).

The principles in NEMA (see Section 2.1.1) serve as a guide for the interpretation of the issue of "need", but do not conceive "need" as synonymous with the "general purpose and requirements" of the project. The latter might relate to the applicant's project motivation, while the "need" relates to the interests and needs of the broader public. In this regard, an important NEMA principle is that environmental management must ensure that the environment is "held in public trust for the people, the beneficial use of environmental resources must serve the public interest and the environment must be protected as the people's common heritage" (DEA, 2014).

There are various proxies for assessing the need and desirability of a project, notably national and regional planning documents which enunciate the strategic needs and desires of broader society and communities: project alignment with these documents must therefore be considered and reported on in the EIA process. With the use of these documents or - where these planning documents are not available - using best judgment, the EAPs (and specialists) must consider the project's strategic context, or justification, in terms of the needs and interests of the broader community (DEA&DP, 2013).

The consideration of need and desirability in EIA decision-making therefore requires the consideration of the strategic context of the project along with broader societal needs and the public interest (DEA, 2017). However, it is important to note that projects which deviate from strategic plans are not necessarily undesirable. The DEA notes that more important are the social, economic and ecological impacts of the deviation, and "the burden of proof falls on the applicant (and the EAP) to show why the impacts...might be justifiable" (DEA, 2010).

7.2.1 Alignment with Policy and Planning Documentation

The project generally aligns well with key planning documents (see Table 7-2), as it is aligned with and directly responds to South African strategy on growing renewable energy (as expressed in the IRP and SIPs) and is located in a REDZ declared for the express purpose of solar energy generation. Provincial policy also supports expansion of renewable energy.

The proposed project is intended to form part of a submission under the REIPPPP, a programme aimed at bringing additional megawatts onto the country's electricity system in line with the IRP through private sector investment in renewable energy development. The project is desirable as it contributes to the overarching goals of the IRP which is to add megawatts to the grid to reduce loadshedding. There is a significant need and urgency for installation of additional renewable energy in South Africa, making the project highly desirable.

The project lies in an ESA, one of the less sensitive biodiversity planning categories, but which nevertheless should be retained in at least a semi-natural state. In principle, the NWBSP 'actively discourages' renewable energy (PV farms and solar arrays) and does 'not usually permit' transmission lines in ESAs; however, based on a site investigation the ecological specialist has indicated that impacts can be mitigated so that the project is acceptable.

Table 7-2: Analysis of project consistency with relevant plans and policies

Policy	Compliance	Comments
National		
IRP for Electricity 2010 – 2030 (BAR Section 2.2.1)	Compliant	The project contributes toward the original IRP goal of procuring ~1 000 MW per annum from new PV facilities and increasing battery energy storage to improve the percentage of energy generated from these facilities relative to the percentage of installed capacity. The announcement in July 2022 that originally anticipated generation capacity to be procured in Bid Window 6 would be doubled indicates the need and urgency for installation of additional renewable energy in South Africa.
SIP (BAR Section 2.2.2)	Compliant	The project is compliant with SIP 8, as it relates to the industrial-scale generation of sustainable green energy and SIP 9, as it provides new energy generation capacity. M Essop of DFFE confirmed on 23 June 2022 that the project is only classified as a SIP after it has been awarded as a preferred bidder if it is part of a DMRE REIPPPP Bid.
REDZ (BAR Section 4.5)	Compliant	The project lies within the Klerksdorp REDZ identified for solar renewable energy facilities.
Provincial		
RES for North West Province (2012) (BAR Section 2.2.2)	Compliant	The project is compliant with the RES objective of growing renewable energy generation in the North West Province and the identification of PV as one of the most viable sources.
North West PDP (2013) (BAR Section 2.2.4)	Compliant	The project aligns with the PDP objective of growing the share renewable energy generation in the North West Province via PV facilities. Limited grid access / capacity is not a challenge at present, as the North West Province is one of the few locations that have excess grid capacity at present (see Section 3.4.2).
NWBSP (BAR Section 2.2.5)	Very limited compliance	The project overlies ESAs, which are less sensitive and more suitable to development than CBAs. However, PV farms and solar arrays are 'actively discouraged' in ESAs, while wind farms and power lines are 'not usually permitted' but 'subject to site-specific conditions and controls when unavoidable' in ESAs.
Municipal		
DKKDM IDP (2017) (BAR Section 2.2.5)	Limited guidance	The latest draft IDP makes very limited reference to renewable energy, but the project is consistent insofar as renewable energy is identified as a Spatial Development Value of the Province.
JB Marks LM IDP (2017) (BAR Section 2.2.7)	Limited guidance	The latest draft IDP makes very limited reference to renewable energy, but the project is consistent insofar as growing renewable energy is identified as a provincial and national goal.

7.2.2 Socio-Economic Need and Desirability

At a local level, the economic baseline has identified a significant need for economic growth and employment generation in the project region, arising from the closure of mines and a struggling economy in the wake of the COVID-19 pandemic and evidenced in high poverty and unemployment rates (see Section 4.2). The project could generate significant long-term investment in the local and regional economy, some employment, local development through CSI and – if implemented in line with past REIPPPP requirements – considerable community income through partial ownership in the project (if managed well). From this perspective, the project is highly desirable.

At a national level, there is a clear need to produce more power (to reduce loadshedding impacts on economic production and quality of life) and cleaner power (to reduce GHG emissions as part of a transition

to a low-carbon economy to address climate change). The project would contribute to both objectives by producing up to 150 MW of renewable energy. From this perspective, the project is also highly desirable.

The cumulative socio-economic benefit of the Stilfontein Cluster PV plants will result in a needed significant contribution towards reducing the shortfall in South African electricity generation and the massive economic costs of loadshedding. A significant and desirable cumulative benefit in terms of stimulation of economic and employment growth is expected.

7.2.3 Ecological Need and Desirability

It is essential that the implementation of social and economic policies take cognisance of strategic *ecological* concerns such as climate change, food security, as well as the sustainability in supply of natural resources and the status of ecosystem services. Sustainable development is the process followed to achieve the goal of sustainability (DEA, 2014).

Sustainable development implies that a project should not compromise natural systems. In this regard, the Best Practicable Environmental Option (BPEO) is that which provides the most benefit and causes the least damage to the environment as a whole, at a cost acceptable to society, in the long term as well as in the short term.

NEMA and the EIA Regulations, 2014 call for a hierarchical approach to the selection of development options, as well as impact management, which includes the investigation of alternatives to avoid, reduce (mitigate and manage) and/or remediate (rehabilitate and restore) negative (ecological) impacts (DEA, 2014).

Not surprisingly, the project has negative ecological impacts, most notably on avifauna (residual medium impact of bird displacement during construction, though operation phase impacts can be mitigated to low significance) and terrestrial ecology (residual medium impact of habitat degradation and loss for bifacial panel technology during construction, though operational phase impacts can be mitigated to very low significance). Furthermore, as noted in Section 7.2.1, the project is located in an ESA, where PV farms and, to a lesser extent, transmission lines are discouraged at a planning level. Based on site investigations, both specialists consider the project impacts acceptable.

In this context the avifauna specialist notes that human-induced climate change is recognized as a fundamental driver of biological processes and patterns. Historic climate change is known to have caused shifts in the geographic ranges of many plants and animals, and future climate change is expected to result in even greater redistributions of species (National Audubon Society, 2015).

South Africa is among the top 10 developing countries required to significantly reduce their carbon emissions (Seymore, Inglesi-Lotz, & Blignaut, 2014), and the introduction of low-carbon technologies into South Africa's power generation portfolio will greatly assist with achieving this important objective (Walwyn & Brent, 2015). Given that South Africa receives among the highest levels of solar radiation on earth (Fluri, 2009) (Munzhedi, Munzhedi, & Sebitosi, 2009), solar power generation should feature prominently in future efforts to convert to a more sustainable energy mix, also from an ecological impact perspective. However, while the expansion of solar power generation is undoubtedly a positive development in the longer term, in that it will help reduce the effect of climate change and thus habitat transformation, it must also be acknowledged that renewable energy facilities in themselves have some potential for negative ecological impacts.

The project is thus in principle ecologically desirable, and was deemed acceptable on the project site.

The cumulative impact assessment (Section 6.10.3) found that the contribution of the project to cumulative avifauna, soil capability and heritage impacts is relatively limited. However, due to the size and nature of PV projects unavoidable adverse cumulative terrestrial ecology (degradation, fragmentation and loss of habitat) and visual impacts (alteration of sense of place, visual intrusion and generation of limited glint and glare) in the region may derive from adding further habitat loss of other approved, proximate PV facilities

which will increase the cumulative loss and degradation of natural areas in the region. However, the currently envisaged cumulative impact, assessed to be of medium significance, is deemed acceptable with implementation of the relevant mitigation measures as provided in this impact assessment report.

7.2.4 Summary of Need and Desirability

In summary:

- The project complies with and responds directly to a number of social and economic principles and policies laid out in the planning framework by providing additional and renewable low-emission electricity to the national grid, generated in a REDZ and STC.
- The project responds well to an identified social and economic need to stimulate and provide jobs in the local economy, and to provide alternative income to communities challenged by mine closures and general economic downturn.
- The project does not fully comply with ecological planning objectives and policies contained in the NWBSP, as it is located within an ESA. Ecological impacts, while not desirable, are deemed acceptable.
- While ecological desirability is one aspect of site identification, other aspects must be satisfied to ensure that the project is (technically) sustainable. This is the case for this project:
 - Support of and approval by affected landowners;
 - Suitable terrain for the establishment of PV arrays, requiring a minimum of earthworks;
 - Sufficient available area to site the cluster of projects;
 - Good accessibility from existing roads;
 - Proximity of tie-in points to the Eskom grid; and
 - Availability of grid (transmission) capacity in the region.
- Social, economic and ecological factors are considered and assessed during the BA process, to ensure that the development is sustainable. Mitigation measures are recommended in the BAR to prevent, minimise (and optimise) impacts and to secure stakeholders' environmental rights. An EMPr has been drafted and must be implemented to ensure that potential environmental pollution and degradation can be minimised, if not prevented.
- The Project will generate impacts, both negative and positive and these should be considered in evaluating the desirability of the Project. Impacts can be managed.

7.3 Recommendations

The specific recommended mitigation and optimisation measures are presented in Section 6 and the EMPr Appendix E. Implementation thereof should be a condition of the EA, if granted.

Key project-specific recommendations are listed below:

1. Implement the EMPr (including site specific mitigation) to guide construction, operation and maintenance and decommissioning activities and to provide a framework for the ongoing assessment of environmental performance;
2. Appoint an ECO to oversee the implementation of the EMPr and supervise construction activities;
3. Implement and avoid a 15 m buffer around wetlands;
4. Retain or relocate existing waterpoints to ensure at least four waterpoints are retained within the Stilfontein Project Cluster, one of which must be in the north west and one in the south east of the Cluster;

5. Demarcate the high rocky ridges as No-Go area for Construction;
6. Restrict vegetation clearance to the immediate development footprint;
7. Limit construction of new roads as much as possible and prohibit off-road driving;
8. Demarcate potentially sensitive heritage sites and implement a chance finds procedure;
9. Design and construct an appropriate and formalised access to the site from the N12;
10. Use a single perimeter fence and space the top two wires at minimum 30 cm;
11. Use bird friendly pole designs;
12. Investigate electrocution incidents and insulate hardware if required;
13. Install and maintain Bird Flight Diverters along the length of the transmission lines according to applicable Eskom standards.
14. If the community takes partial ownership, develop a Governance Plan with clear governance rules for the Community Trust (owning shares in the project, if implemented), including trustee and beneficiary selection (if applicable);
15. If applicable, ensure regular external auditing of the Community Trust as well as supported projects (if applicable); and
16. Compile and implement management plans to guide construction, operation and decommissioning:
 - a. Rehabilitation Plan;
 - b. Alien Vegetation Management Plan;
 - c. Waste Management Plan;
 - d. Stormwater Management Plan; and
 - e. Fire Management Plan.

7.4 Conclusion and Authorisation Opinion

This BAR has identified and assessed the potential biophysical and socio-economic impacts associated with the proposed Sparrow PV facility, BESS and IPP-side of the Sparrow on-site substation.

In terms of Section 31 (n) of NEMA, the EAP is required to provide an opinion as to whether the activity should or should not be authorised. In this section, a qualified opinion is ventured, and in this regard SRK believes that sufficient information is available for DFFE to take a decision.

The project will result in unavoidable adverse biophysical impacts, while adverse socio-economic impacts are very low. Working on the assumption that Mainstream is committed to ensuring that the EMP is strictly implemented, none of these adverse impacts are considered unacceptably significant. The project has significant potential socio-economic benefits however and responds to a national need for more and cleaner power generation. On this basis, the No-Go alternative is not preferred.

In conclusion, and noting that the project could become an important SIP located within a designated zone (REDZ), SRK is of the opinion that on purely 'environmental' grounds (i.e. the project's potential social, economic and biophysical implications) the application as it is currently articulated should **be approved**, provided the essential mitigation measures are implemented. The impacts of both panel technologies were deemed acceptable with mitigation. The impacts of both panel technologies were deemed acceptable with mitigation. It is recommended that Panel Technology One is approved as it has lower residual impacts on terrestrial ecology. The impacts of both substation alternatives were deemed to be the same and accepted so it is recommended that the technically preferred location be approved. The impacts of all three cell

technology alternatives are the same and any off the three cell technology alternatives assessed can be implemented (to be decided during detailed design).

Ultimately, however, the DFFE will consider whether the project benefits outweigh the potential impacts.

It is recommended the PV project layout map, (Figure 7-3 below), is approved.

If approved, it is SRK's opinion that the EA should require construction to be completed within five years once construction begins and that the EA should remain valid for 10 years.

SRK recommends a Statutory Environmental Audit be undertaken upon completion of the Construction Phase.

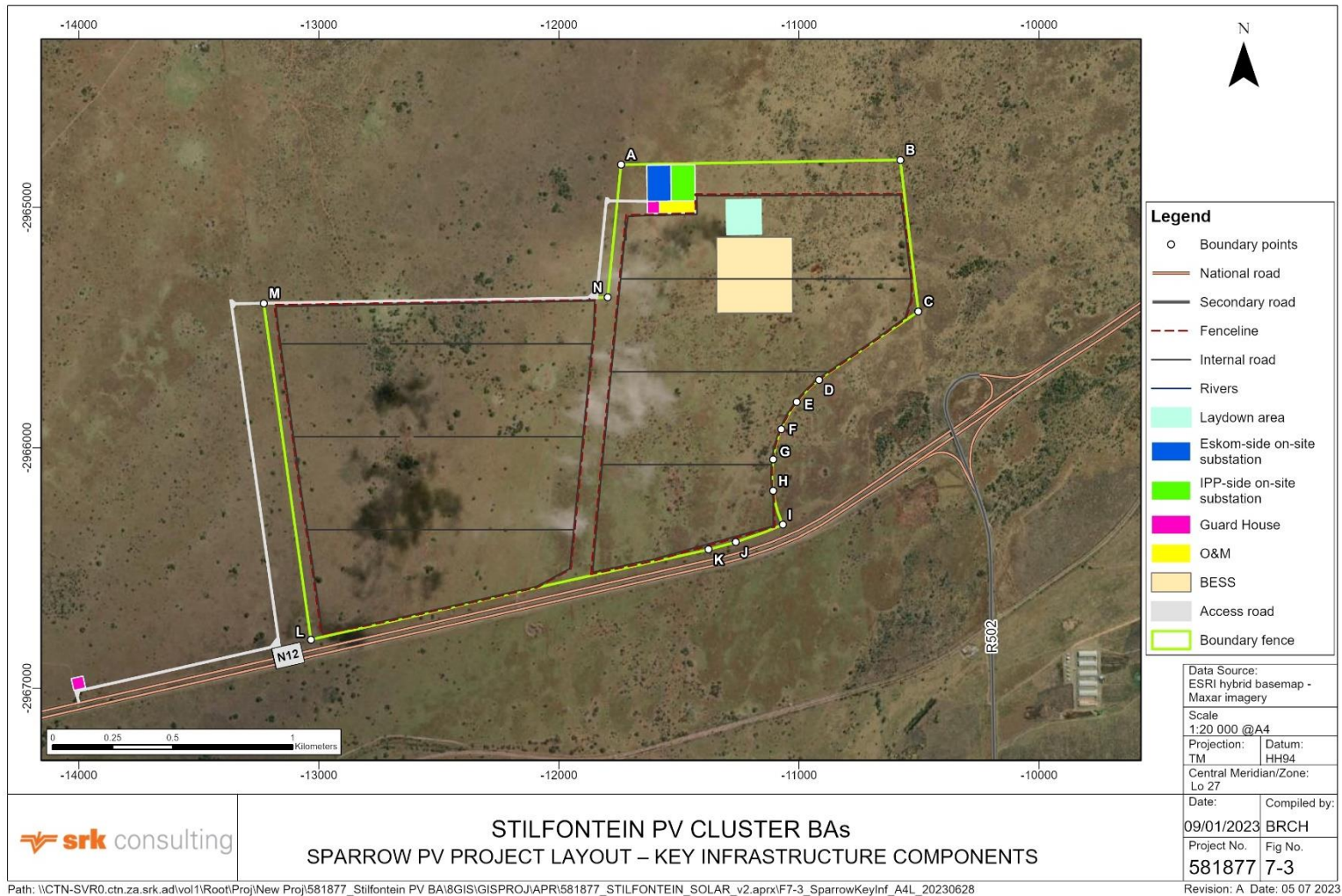

Figure 7-3: Sparrow PV project layout - key infrastructure components⁴⁸

⁴⁸ *The proposed location of the BESS is shown in Figure 7-3 and it is noted that if the BESS is not installed, this area will be occupied by additional PV panels*

7.5 Way Forward

The public participation process conducted to date has given stakeholders the opportunity to assist with the identification of issues and potential impacts, and to submit their comments. All submissions and comments received to date have been addressed and included in the Issues and Response Summary and provided to DFFE (Appendix C.6 and Appendix C.7).

This Final BAR will be submitted to DFFE for approval. Registered IAPs will be informed of the submission of the Final BAR and provided with the Issues and Responses Summary.

Once a decision is taken by DFFE, this decision will be communicated to registered IAPs.

Signatures

All data used as source material plus the text, tables, figures, and attachments of this document have been reviewed and prepared in accordance with generally accepted professional engineering and environmental practices.

This report, the Sparrow PV Facility Final Basic Assessment Report, was prepared and reviewed by the SRK personnel presented below.

Prepared by



Kate Steyn
Principal Environmental Consultant

Prepared by



Lauren Elston
Senior Environmental Consultant

Reviewed by



Chris Dalgliesh, Partner
Principal Environmental Consultant

8 References

- Akinbami, O., Oke, S., & Bodunrin, M. (2021, December). The state of renewable energy development in South Africa: An overview. *Alexandria Engineering Journal*, 60(6), 5077-5093. Retrieved from <https://www.sciencedirect.com/science/article/pii/S1110016821002295>
- Bates, M. (2012, May 1). MIT. Retrieved March 2022, from How does a battery work?: <https://engineering.mit.edu/engage/ask-an-engineer/how-does-a-battery-work/>
- Batho Earth & SED. (2020). *Proposed Kareerand Tailings Storage Facility (TSF) Expansion Project, near Stilfontein, North West Province*. Retrieved March 2022, from https://gcs-sa.biz/wp-content/uploads/2021/03/App-D14_-Socio-economic-Impact-Assessment.pdf
- Beanlands, G., & Duinker, P. (1983). *An ecological framework for environmental impact assessment in Canada*. Dalhousie University, Halifax, NS, and Federal Environmental Assessment Review Office, Hull, QC. Institute for Resource and Environmental Studies.
- Bergh, J. (1999). *Geskiedenis Atlas van Suid-Afrika. Die Vier Noordelike Provinsies*. Pretoria: J.L van Schaik.
- Beukes, N. J. (1987). Facies relations, depositional environments, and diagenesis in a major early Proterozoic stromatolitic carbonate platform to basinal sequence, Campbell Rand Subgroup, Transvaal Supergroup, southern Africa. *Sedimentary Geology*, 54, 1-46.
- Beyond Heritage. (2022). *Heritage Impact Assessment for the proposed Stilfontein Solar Energy Facility and Associated Infrastructure, North West Province*.
- Business Day. (2022, May 12). Only new generation capacity will end blackouts - Eskom.
- business essentials*. (2022, April 26). Retrieved from Landmark Licencing of Private Electricity Trader Set to Transform SA Energy: <https://www.businessessentials.co.za/2022/04/26/landmark-licencing-of-private-electricity-trader-set-to-transform-sa-energy/>
- Business Insider SA*. (2021a, March 13). Retrieved from 860 hours of load shedding: These graphs show the sorry state of SA electricity: <https://www.businessinsider.co.za/new-csir-report-load-shedding-and-eskom-2021-3>
- BusinessTech*. (2021, March 12). Retrieved from South Africa spends 10% of the year load shedding – and it could get worse: <https://businesstech.co.za/news/energy/475406/south-africa-spends-10-of-the-year-load-shedding-and-it-could-get-worse/>
- BusinessTech*. (2022, January 13). Retrieved from Expect another record year of load shedding in South Africa: economists: <https://businesstech.co.za/news/energy/550572/expect-another-record-year-of-load-shedding-in-south-africa-economists/>
- Caetano, T., & Thurlow, J. (n.d.). *The Socioeconomic Implications of Renewable Energy and Low Carbon Trajectories in South Africa*. Retrieved June 2021, from https://www.codesria.org/IMG/pdf/1-inequality_climate_change_caetano_thurlow.pdf
- Cairns, J. (2013). Environmental Stress. In S. Levin (Ed.), *Encyclopaedia of Biodiversity, second edition, Volume 7* (pp. 39-44). Waltham, MA: Academic Press.
- Canadian Environmental Protection Agency. (no date). *Reference Guide: Addressing Cumulative Environmental Effects*. Retrieved August 2007, from www.ceaa-acee.gc.ca/013/0001/0008/guide1_e.htm#
- Chris van Rooyen Consulting. (2022). *Avifauna Specialist Study - PV Facility and Associated Infrastructure near Stilfontein, North-West Province*.
- City of Matlosana. (2017). *Integrated Development Plan of the City of Matlosana 2017-2022*. Retrieved February 2022, from https://www.cogta.gov.za/cgta_2016/wp-content/uploads/2020/12/Matlosana-IDP-REVIEW-DOCUMENT-2020-2021-DRAFT.pdf

- City of Matlosana. (2022). *TABLING OF THE 2022-2027 DRAFT INTEGRATED DEVELOPMENT PLAN*. Retrieved from <http://www.matlosana.gov.za/Documents/IDP/IDP-DOCUMENT-2022-2023-DRAFT.pdf>
- CKDM. (2017). Central Karoo District Municipality Integrated Development Plan 2017-2022.
- Climate Transparency. (2020). *Climate Transparency Report 2020*. Retrieved from <https://www.climate-transparency.org/wp-content/uploads/2020/11/South-Africa-CT-2020-Web.pdf>
- Cole, W., Frazier, W., & Augustine, C. (2021). *Cost Projections for Utility-Scale Battery Storage: 2021 Update*. National Renewable Energy Laboratory. Retrieved from <https://www.nrel.gov/docs/fy21osti/79236.pdf>
- Creamer, T. (2020, 07 23). *Engineering News*. Retrieved from Renewables zones in Emalahleni and Klerksdorp part of just-transition vision – Creecy: <https://www.engineeringnews.co.za/article/renewables-zones-in-emalahleni-and-klerksdorp-part-of-just-transition-vision-creecy-2020-07-23>
- Creamer, T. (2020, December 11). *South Africa's renewables plan presents 'remarkable' industrialisation opportunity*. Retrieved from Engineering News: https://www.engineeringnews.co.za/article/south-africas-renewables-plan-presents-remarkable-industrialisation-opportunity-2020-12-11/rep_id:4136
- CSIR. (2020). *Setting up for the 2020s. Addressing South Africa's electricity crisis and getting ready for the next decade*. CSIR Energy Centre. Retrieved June 2021, from https://cisp.cachefly.net/assets/articles/attachments/81125_rs_setting_up_for_2020.pdf
- CSIR. (2022). *Statistics of utility-scale power generation in South Africa*. Retrieved from https://www.csir.co.za/sites/default/files/Documents/Statistics%20of%20utility-scale%20power%20generation%20in%20South%20Africa_2022H1.pdf
- De Wildt Solar. (n.d.). Retrieved from <https://dewildtsolar.co.za/>
- DEA. (2017). *Public Participation guideline in terms of NEMA EIA Regulations, Department of Environmental Affairs, Pretoria, South Africa*.
- DEA. (2017a). *Guideline on Need and Desirability, Department of Environmental Affairs, Pretoria, South Africa*.
- DEA&DP. (2013). *EIA Guideline and Information Document Series*. Western Cape Department of Environmental Affairs and Development Planning (DEA&DP).
- DEL. (2022, February 08). *Minister Thulas Nxesi announces 2022 National Minimum Wage increases*. Retrieved from Department of Employment and Labour: <https://www.gov.za/speeches/minister-thulas-nxesi-announces-2022-national-minimum-wage-increases-8-feb-2022-0000>
- DFFE. (2022). *Department of Forestry, Fisheries and the Environment: egis*. Retrieved from https://egis.environment.gov.za/gis_data_downloads
- DFFE. (2023). Q1 2023 REEA database.
- DKKDM. (2015). *Annual Report 2015/16*. Retrieved February 2022, from https://www.kaundadistrict.gov.za/documents/2015_16/DRKKDM%20FINAL%20%20201516%20ANNUAL%20REPORT.pdf
- DKKDM. (2017). *Dr Kenneth Kaunda District Municipality Integrated Development Plan (2017-2022)*. Retrieved from http://www.kaundadistrict.gov.za/documents/2017_2022%20idp%20review%20final.pdf
- DKKDM. (2017a). *Final Integrated Development Plan 2017/18 - 2021/22*. Retrieved February 2022, from http://www.kaundadistrict.gov.za/documents/2017_2022%20idp%20review%20final.pdf
- DKKDM. (2020a). *Profile and Analysis District Development Model*. Retrieved from <https://www.cogta.gov.za/ddm/wp-content/uploads/2020/11/DR-Kenneth-Kaunda-DM-October2020.pdf>
- DKKDM. (2020b). *Dr Kenneth Kaunda Annual Report 2020-21*. Retrieved February 2022, from <http://www.kaundadistrict.gov.za/documents/2020-21%20DrKKDM%20Annual%20Report.pdf>

- DKKDM. (2021). *Integrated Development Plan 2017-2022. 2021/22 Interim Review.* Retrieved June 2022, from <https://www.kaundadistrict.gov.za/documents/idp/2021-22%20Draft%20IDP%20REVIEW.pdf>
- DMRE. (2021). *REIPP Bid Window 5 Overview.* Retrieved March 2022, from <https://www.ipp-renewables.co.za/PressCentre/GetPressRelease?fileid=a1289fb1-0cbe-eb11-9547-2c59e59ac9cd&fileName=REIPPPP%20BW5%20Summary%20260521.pdf>
- DMRE. (2021). *REIPPP Bid Window 5 Overview.* Retrieved March 2022, from <https://www.ipp-renewables.co.za/PressCentre/GetPressRelease?fileid=a1289fb1-0cbe-eb11-9547-2c59e59ac9cd&fileName=REIPPPP%20BW5%20Summary%20260521.pdf>
- DMRE. (n.d.). *IPP Projects.* Retrieved from <https://www.ipp-projects.co.za/ProjectDatabase>
- DoE. (2019). *Integrated Resource Plan (IRP2019).* Retrieved from <http://www.energy.gov.za/IRP/2019/IRP-2019.pdf>
- EcoMetrix Africa. (2020). *Final Report: Eskom Carbon Footprint Study 2019.* Retrieved June 2021, from <https://www.eskom.co.za/OurCompany/SustainableDevelopment/Documents/Final%20Carbon%20Footprint%20Report.pdf>
- Enelgreenpower.com.* (n.d.). Retrieved from Solar Plants: <https://www.enelgreenpower.com/learning-hub/renewable-energies/solar-energy/solar-plants>
- energysage.* (n.d.). Retrieved from Solar trackers: everything you need to know: <https://news.energysage.com/solar-trackers-everything-need-know/>
- Eriksson, P., Altermann, W., & Hartzler, F. (2006). The Transvaal Supergroup and its pre-cursors. In M. Johnson, C. Anhaeusser, & R. Thomas, *The Geology of South Africa* (pp. 237-260). Pretoria: Geological Society of South Africa, Johannesburg / Council for Geoscience, Pretoria.
- Eskom. (2021). *TRANSMISSION GENERATION CONNECTION CAPACITY ASSESSMENT OF THE 2023 TRANSMISSION NETWORK (GCCA – 2023) Phase 1.* Reference No. : GP_21/126. Retrieved February 2022, from [https://www.ipp-renewables.co.za/PressCentre/GetPressRelease?fileid=D96C0DFE-F5DF-EB11-954D-2C59E59AC9CD&fileName=Generation%20Connection%20Capacity%20Assessment%20\(GCCA%20-%20%202023\)%20-%20Phase%201_signed.pdf](https://www.ipp-renewables.co.za/PressCentre/GetPressRelease?fileid=D96C0DFE-F5DF-EB11-954D-2C59E59AC9CD&fileName=Generation%20Connection%20Capacity%20Assessment%20(GCCA%20-%20%202023)%20-%20Phase%201_signed.pdf)
- Finn, A. (2015). *A National Minimum Wage in the Context of the South African Labour Market. National Minimum Wage Research Initiative, Working Paper Series No. 1, University of the Witwatersrand.* Retrieved from <https://www.dropbox.com/s/r9pit4odz4kzpej/NMW-RI%20Descriptive%20Statistics%20Final.pdf?dl=0>
- Fluri, T. P. (2009). The potential of concentrating solar power in South Africa. *Energy Policy*, 37, pp. 5075-5080.
- GaGE Consulting. (2022). *Report on the Geotechnical Desktop Study for Stilfontein Solar Photovoltaic Cluster.*
- Go Solar.* (2021, November 10). Retrieved from Monofacial versus Bifacial Monocrystalline Panels: <https://gosolargroup.com/panels/monofacial-vs-bifacial-monocrystalline-modules/>
- Hall, M. (2022, July 27). *South Africa to allocate 5.2 GW of renewables in sixth REIPPPP round.* Retrieved from pv magazine: <https://www.pv-magazine.com/2022/07/27/south-africa-to-allocate-5-2-gw-of-renewables-in-sixth-reipppp-round/>
- Iberdrola.* (2022). Retrieved from How do photovoltaic plants work?: <https://www.iberdrola.com/sustainability/what-is-photovoltaic-energy>
- IEEEXplore.* (n.d.). Retrieved from Maintenance of EVH substations: <https://ieeexplore.ieee.org/document/7955819>
- Intellidex. (2021). *Communities in Transition: the Role of Community Ownership in South Africa's REIPPPP Programme.* Retrieved from <https://www.intellidex.co.za/reports/communities-in-transition-report/#:~:text=Intellidex%20has%20conducted%20a%20research,research%20was%20funded%20by%20FirstRand.>

- IRENA. (2014). *The Socio-economic Benefits of Solar and Wind Energy*. Retrieved June 2021, from <https://www.irena.org/publications/2014/May/The-Socio-economic-Benefits-of-Solar-and-Wind-Energy>
- IRENA. (2019). *Measuring the socio-economic footprint of the Energy Transition: The Role of Supply Chains*. Retrieved June 2021, from https://www.irena.org/-/media/Files/IRENA/Agency/Publication/2019/Jan/IRENA_-_Measuring_socio-economic_footprint_2019_summary.pdf?la=en&hash=98F94BCC01598931E91BF49A47969B97ABD374B5
- IRENA. (2020). Retrieved from Avoided Emissions Calculator: <https://www.irena.org/climatechange/Avoided-Emissions-Calculator>
- i-traffic. (2022, 06). Retrieved from <https://www.i-traffic.co.za/region/Gauteng>
- JB Marks LM. (2020). *JB MARKS LOCAL MUNICIPALITY 2017-2022 FINAL INTEGRATED PLAN AMENDED 2020-2021*. Retrieved from <https://www.jbmarks.co.za/download/integrated-development-plan-2020-2021/?wpdmdl=14027&refresh=629a10c9527db1654264009>
- JB Marks LM. (2022). *DRAFT INTEGRATED DEVELOPMENT PLAN (IDP) 2022-2023*. Retrieved from <https://www.jbmarks.co.za/download/draft-idp-2022-2023/?wpdmdl=14031&refresh=629a10c6b36aa1654264006>
- KMA. (2016). *Klondike Solar PV Power Plan - Traffic Impact Assessment*. Retrieved from <https://sahris.sahra.org.za/sites/default/files/additionaldocs/Appendix%20E10%20Traffic%20Assessment%20and%20Transport%20Plan.pdf>
- Maggs, T. (1976). *Iron Age Communities of the Southern Highveld*. Pietermaritzburg: Natal Museum.
- Mantashe, G. (2021, October 28). ANNOUNCEMENT BY THE MINISTER OF MINERAL RESOURCES AND ENERGY, THE HONOURABLE GWEDE MANTASHE, 28 October 2021, RENEWABLE ENERGY IPP PROCUREMENT PROGRAMME (REIPPPP) BID WINDOW 5, ANNOUNCEMENT OF PREFERRED BIDDERS. Retrieved March 2022, from <https://www.ipp-renewables.co.za/PressCentre/GetPressRelease?fileid=1b9b12ad-a038-ec11-9556-2c59e59ac9cd&fileName=REIPPPP-Announcement-by-Minister-28102021%20%281%29.pdf>
- Maskam Water. (n.d.). Retrieved from Clarus Fusion Treatment System: <http://www.maskamwater.com/products/clarus-fusion-series-treatment-systems/>
- Mason, R. (1962). *The Prehistory of the Transvaal*. Witwatersrand University Press, Johannesburg. Johannesburg: Witwatersrand University Press.
- Mathe, Z. T. (2023, January 6). Practical steps to stop load-shedding and secure electricity security. *Mail and Guardian*. Retrieved from <https://mg.co.za/opinion/2023-01-06-practical-steps-to-stop-load-shedding-and-secure-electricity-security/>
- McFadden, C. (2021, February 05). *Interesting Engineering*. Retrieved from How Does a Solar Power Plant Work?: <https://interestingengineering.com/how-does-a-solar-power-plant-work>
- Meridian Economics. (2020). *Accelerating renewable energy industrialisation in South Africa: What's stopping us? Final Report*. Retrieved June 2021, from <https://meridianeconomics.co.za/wp-content/uploads/2020/07/Accelerating-renewable-energy-industrialisation-in-South-Africa-July2020.pdf>
- Mucina, L., & Rutherford, M. C. (Eds.). (2006). *The vegetation of South Africa, Lesotho and Swaziland*. Pretoria, South Africa: Strelizia 19. South African Biodiversity Institute.
- Municipalities of South Africa. (2022a, March). *Municipalities of South Africa*. Retrieved from City of Matlosana Local Municipality (NW403): <https://municipalities.co.za/demographic/1193/city-of-matlosana-local-municipality>
- Municipalities of South Africa*. (2022b, March). Retrieved from Municipalities: www.localgovernment.co.za

- Munzhedi, Munzhedi, R., & Sebitosi, A. (2009). Re-drawing the solar map of South Africa for photovoltaic applications. *Renewable Energy*, 34, pp. 165-169.
- National Audubon Society. (2015). *Audubon's Birds and Climate Change Report: A Primer for Practitioners*. National Audubon Society, New York. Contributors: Gary Langham, Justin Schuetz, Candan Soykan, Chad Wilsey, Tom Auer, Geoff LeBaron, Connie Sanchez, Trish Distler. Version 1.3.
- National Treasury. (2016). *Budget Review 2016*. Retrieved from <http://www.treasury.gov.za/documents/national%20budget/2016/review/FullReview.pdf>
- Nomjana, L. (2020, February 18). *FutureGrowth*. Retrieved from REIPPP comes of age: <https://futuregrowth.co.za/insights/reipp-comes-of-age/>
- North West 405 Municipality. (2017). *NW 405 MUNICIPALITY INTEGRATED DEVELOPMENT PLAN 2017-2020*. Retrieved from <https://www.jbmarks.co.za/download/integrated-development-plan-2017-2020/?wpdmdl=14024&refresh=629a10ef15bc91654264047>
- North West Department of Health. (2022). *Covid-19 Statistics in the North West*. Retrieved February 2022, from <https://twitter.com/NorthWestDOH/status/1498214590953541634/photo/1>
- NWDC. (2016). *Economic Data Report 1st Quarter 2015/16*. Retrieved February 2022, from https://nwdc.co.za/wp-content/uploads/2015/07/NWDC_Economic_Data_Report_Qtr_1_201516.pdf
- NWDC. (2021a). *Economic Data Report Quarter 3 of 2021/2022*. Retrieved February 2022, from https://nwdc.co.za/wp-content/uploads/2022/01/NWDC_Economic_Data_Report_Qtr_3_2021-2022.pdf
- NWDC. (2021b). *Economic Data Report Quarter 2 of 2021/22*. Retrieved February 2022, from https://nwdc.co.za/wp-content/uploads/2021/10/NWDC_Economic_Data_Report_Qtr_2_2021.2022.pdf
- NWP. (2013). *Provincial Development Plan*. Retrieved February 2022, from <http://www.nwpg.gov.za/Documents/Provincial%20Development%20Plan.pdf>
- Our World in Data*. (n.d.). Retrieved from South Africa: CO2 Country Profile: <https://ourworldindata.org/co2/country/south-africa>
- PERO. (2018). *Provincial Economic Review and Outlook*. City of Cape Town : Western Cape Government Provincial Treasury.
- Pickerel, K. (2018, April 2). *Solar Power World*. Retrieved from What are bifacial solar modules?: <https://www.solarpowerworldonline.com/2018/04/what-are-bifacial-solar-modules/#:~:text=Bifacial%20modules%20produce%20solar%20power,backside%20of%20the%20solar%20cells.>
- Platte River Power Authority. (2017). *Battery Energy Storage Technology Assessment*. Retrieved March 2022, from <https://www.prpa.org/wp-content/uploads/2017/10/HDR-Battery-Energy-Storage-Assessment.pdf>
- PVeducation.com*. (n.d.). Retrieved March 2022, from Working Safety with Photovoltaic Systems: <https://pveducation.com/working-safely/>
- READ. (2015). *North West Biodiversity Sector Plan*. Mahikeng: North West Provincial Government. Retrieved June 2022
- SA Cities Network. (2014). *Matlosana - City on the Move?* Retrieved February 2022, from <https://www.sacities.net/wp-content/uploads/2019/12/City-of-Matlosana-final-author-tc.pdf>
- SAWEA. (2019). *The Cost Benefits of Renewable Energy*. Retrieved June 2021, from https://sawea.org.za/wp-content/uploads/2019/02/RE-Costs_SAWEA2019.pdf
- Seymore, R., Inglesi-Lotz, R., & Blignaut, J. (2014). A greenhouse gas emissions inventory for South Africa: a comparative analysis. *Renewable & Sustainable Energy Reviews*, 34, pp. 371-379.

- SolarReviews*. (2022, 03 15). Retrieved from What is a solar tracker and is it worth the investment?: <https://www.solarreviews.com/blog/are-solar-axis-trackers-worth-the-additional-investment>
- South African Government. (n.d.). *National Infrastructure Plan*. Retrieved from <https://www.gov.za/issues/national-infrastructure-plan#E-SIPs>
- South African Government News Agency*. (2019, February 24). Retrieved from Renewable energy programme attracts R209.4 billion to SA economy: <https://www.sanews.gov.za/south-africa/renewable-energy-programme-attracts-r2094-billion-sa-economy>
- SRK. (2022). *Social Impact Assessment for the Ingwe Renewable Energy Project*. SRK Report 582222/1.
- SRK Consulting. (2022a). *Visual Impact Assessment for the Project within the Stilfontein PV Cluster, Stilfontein, North West Province*.
- Stilfontein Climate Weather Averages*. (2022, June 7). Retrieved 2022, from World Weather Online: <https://www.worldweatheronline.com/stilfontein-weather-averages/north-west/za.aspx>
- Techso. (2017). *Traffic Impact Assessment for the Proposed Constuction of the Orkney Solar Farm and associated infrastructure on the Remaining Extent of Portion 7 and Portion 21 of the farm Wolvehuis 114, North West Province*. Retrieved June 2022, from <https://sahris.sahra.org.za/sites/default/files/additionaldocs/Appendix%20G%20-%20Traffic%20Impact%20Assessment%20Report.pdf>
- The Biodiversity Company. (2022a). *Pedology Baseline & Impact Assessment for the Proposed Mainstream Stilfontein Solar Project*.
- The Biodiversity Company. (2022b). *Wetland Baseline & Impact Assessment for the Proposed Mainstream Stilfontein Solar Projects*.
- The Biodiversity Company. (2022c). *The Terrestrial Biodiversity Baseline and Impact Assessment for the Mainstream Stilfontein Solar Project*.
- TIPS. (2020). *A case for renewable energy in South Africa's post-lockdown economic recovery stimulus package*. Trade & Industrial Policy Strategies.
- Tregenna, F. (2010). *Sectoral Labour-Intensity in South Africa*. Retrieved from http://new.nedlac.org.za/wp-content/uploads/2014/10/labour_intensity_report_2010.pdf
- van der Walt, J. (2019, September 30). *Wind farms: a massive opportunity for SA's farmers*. Retrieved from farmer's weekly: <https://www.farmersweekly.co.za/farm-basics/how-to-business/wind-farms-a-massive-opportunity-for-sas-farmers/>
- van der Walt, J. (2022a). *Heritage Impact Assessment of the Roan 1 PV Development, North West Province*.
- van der Walt, J. (2022b). *Heritage Impact Assessment of the Roan 2 PV Development, North West Province*.
- van der Walt, J. (2022c). *Heritage Impact Assessment for the proposed Doornhoek 1 PV Facility and Associated Infrastructure, Klerksdorp, North West Province*.
- van der Walt, J. (2022d). *Heritage Impact Assessment for the proposed Doornhoek 2 PV Facility and Associated Infrastructure, Klerksdorp, North West Province*.
- Vanclay, F. (2003). *International Principles for Social Impact Assessment. Impact Assessment Project Appraisal for IAIA*. Retrieved from <http://www.iaia.org/publicdocuments/sections/sia/IAIA-SIA-International-Principles.pdf>.
- Visser, E., Perold, V., Ralston-Paton, S., Cardenal, A., & Ryan, P. (2019). Assessing the impacts of a utility-scale photovoltaic solar energy facility on birds in the Northern Cape, South Africa. *Renewable Energy*, pp. 1285 – 1294. Retrieved from <https://doi.org/10.1016/j.renene.2018.08.106>

- Walwyn, D., & Brent, A. (2015). Renewable energy gathers steam in South Africa. *Renewable and Sustainable Energy*, 41, pp. 390-401.
- WASA. (2020). WASA High-resolution Wind Resource Map 2020. Retrieved from http://www.wasaproject.info/docs/WASA_3_Resource_Map_March_2021.png
- Waterloo Solar. (n.d.). Retrieved from <https://waterloosolar.co.za/community/#more-12>
- Wazimap. (2022a, March). *Dr Kenneth Kaunda based on Community Survey 2016*. Retrieved from Wazimap: <https://wazimap.co.za/profiles/district-DC40-dr-kenneth-kaunda/>
- Wazimap. (2022b, March). *City of Matlosana based on Community Survey 2016*. Retrieved from Wazimap: <https://wazimap.co.za/profiles/municipality-NW403-city-of-matlosana/?release=2016#elections>
- Wazimap. (2022c, March). *Ventersdorp/ Tlokwe based on Community Survey 2016*. Retrieved from Wazimap: <https://wazimap.co.za/profiles/municipality-NW405-ventersdorptlokwe/#demographics>
- Wazimap. (2022e, March). *Ventersdorp/ Tlokwe, North West based on Survey 2011*. Retrieved from Wazimap: <https://wazimap.co.za/profiles/municipality-NW405-ventersdorptlokwe/?release=2011#education>
- Wazimap. (2022f, March). *City of Matlosana Ward 18 (64003018)*. Retrieved from Wazimap: <https://wazimap.co.za/profiles/ward-64003018-city-of-matlosana-ward-18-64003018/>
- Wazimap. (2022g, March). *City of Matlosana, North West based on 2011 data*. Retrieved from Wazimap: <https://wazimap.co.za/profiles/municipality-NW403-city-of-matlosana/?release=2011>
- WCG. (2020). *Provincial Economic Review and Outlook 2020*. Retrieved November 2020, from <https://www.westerncape.gov.za/provincial-treasury/files/atoms/files/2020%20PERO%20Publication.pdf>
- WeatherSpark. (2022). *Climate and Average Weather Year Round in Stilfontein*. Retrieved June 2022, from WeatherSpark: <https://weatherspark.com/y/92859/Average-Weather-in-Stilfontein-South-Africa-Year-Round#Figures-WindDirection>
- Wells, L. (1933). A report on the stone structures of the Platberg near Klerksdorp. *South African Journal of Science*, 30, 582-584.
- Western Cape Provincial Treasury. (2020b). *Municipal Economic Review and Outlook 2020*. Retrieved May 2021, from https://www.westerncape.gov.za/provincial-treasury/files/atoms/files/Mero%202020%20final_compressed.pdf
- White, D. (1977). The Excavation of an Iron Age Site at Palmietfontein near Klerksdorp. *The South African Archaeological Bulletin*, 32(125), 89-92.
- Wikipedia. (2021, November 17). Retrieved March 2022, from Stilfontein: <https://en.wikipedia.org/wiki/Stilfontein>
- Wikipedia. (2021a, November 27). Retrieved March 2022, from Potchefstroom: <https://en.wikipedia.org/wiki/Potchefstroom>
- Wikipedia. (2021b, October 31). Retrieved March 2022, from Electrical Substation: https://en.wikipedia.org/wiki/Electrical_substation
- Wikipedia. (2021c, December 29). Retrieved March 2022, from Photovoltaic power station: https://en.wikipedia.org/wiki/Photovoltaic_power_station
- Wikipedia. (2022, February 01). Retrieved March 2022, from Highveld: <https://en.wikipedia.org/wiki/Highveld>
- Wolf, S. (2021, October 13). *Paradise Energy Solutions*. Retrieved from What are Bifacial Solar Panels: <https://www.paradisesolarenergy.com/blog/what-are-bifacial-solar-panels>
- WWF. (2015). *A review of the local community development requirements in South Africa's renewable energy procurement programme*. Retrieved May 2021, from

https://wwfafrica.awsassets.panda.org/downloads/local_community_development_report_20150618.pdf?14322/A-review-of-the-local-community-development-requirements-in-South-Africas-renewable-energy-procurement-programme

Zeh, A., Wilson, A., & Gerdes, A. (2020). *Zircon U-Pb-Hf isotope systematics of Transvaal Supergroup – Constraints for the geodynamic evolution of the Kaapvaal Craton and its hinterland between 2.65 and 2.06 Ga. Precambrian Research 345, 105760.* Retrieved from <https://doi.org/10.1016/j.precamres.2020.105760>

Appendix A EAP Declaration

Appendix B Curriculum Vitae of the EAP(s)

Appendix C Stakeholder Engagement

Appendix C.1 Stakeholder Database

Appendix C.2 Site Notice and Proof of Placement

Appendix C.3 Newspaper Advert and Proof of Placement

Appendix C.4 Proof of Letter Drop

Appendix C.5 Notification Letter and Proof of Stakeholder Notification

Appendix C.6 Comments Received

Appendix C.7 Issues and Responses Summary

Appendix D Specialist Studies

Appendix D.1 Freshwater Specialist Study

Appendix D.2 Terrestrial Ecology Specialist Study

Appendix D.3 Avifauna Specialist Study

Appendix D.4 Soil and Land Capability Specialist Study

Appendix D.5 Socio-Economic Specialist Study

Appendix D.6 Heritage Specialist Study

Appendix D.7 Visual Specialist Study

Appendix E EMPrs

**Appendix E.1 EMPr for the Sparrow PV Facility and
associated infrastructure**

**Appendix E.2 Generic EMPr for the Development
and Expansion of Substation
Infrastructure for Transmission and
Distribution of Electricity**

Appendix F Site Sensitivity Verification Report