



Hartebeesthoek East Wind Energy Facility

Amendment Report for Traffic Impact Assessment

29 July 2019

JT0048

DOCUMENT CONTROL

Project Name:	Hartebeesthoek East Wind Energy Facility Traffic Impact Assessment Report
Project Number:	JT0048
Report for:	ARCUS Consultancy Services South Africa (Pty) Ltd

REVISIONS

Revision #	Date	Change Overview	Prepared by	Reviewed by
0	04/06/2019	Rev 0	C. Xhobiso	M. Westwood
1	05/06/2019	Rev 1	C. Xhobiso	G. van Jaarsveld
2	12/06/2019	Rev 2	C. Xhobiso	Client
3	05/07/2019	Rev 3	C. Xhobiso	V. de Abreu
4	29/07/2019	Rev 4	C. Xhobiso	Client

SMEC COMPANY DETAILS

Prepared by:	SMEC South Africa (Pty) Ltd
	Address: 275 Kent Ave, Ferndale, Randburg
	Telephone: +27 11 369 0600
	Contact Person: Gerna van Jaarsveld
	Email Address: Gerna.vanJaarsveld@smec.com
	www.smec.com

The information within this document is and shall remain the property of **SMEC South Africa (Pty) Ltd**.

TABLE OF CONTENTS

	PAGE(S)
1. INTRODUCTION	1
1.1 Background	1
1.2 Objectives	1
2. HARTEBEESTHOEK EAST WEF PROPOSED AMENDMENTS.....	2
2.1 Project Data	2
2.2 Proposed Amendments of Key Components	2
3. SUMMARY OF TRAFFIC IMPACT ASSESSMENT PREVIOUSLY UNDERTAKEN	5
3.1 Transportation Route and Site Access and Abnormal loads	5
3.2 SANRAL Consultation.....	7
3.3 Previously Determined Traffic Impacts	8
4. TRAFFIC IMPACT ASSESSMENT OF THE PROPOSED AMENDMENTS	9
4.1 Site Access Options.....	9
4.1.2 Impact on Road Users and Community.....	12
4.2 Trip Generation.....	15
4.2.1 Pre-construction.....	15
4.2.2 Construction.....	15
4.2.3 Operational	20
4.2.1 Decommissioning	22
4.2.2 Closure.....	24
4.3 Trip distribution and assignment.....	24
4.4 Road capacity and safety assessment	24
4.4.2 SANRAL Traffic Data	25
4.4.3 12 hour all turning movements traffic counts	26
4.4.4 Regression analysis.....	26
4.4.5 Capacity Analysis Scenarios.....	29
4.5 Potential impacts of the development on intersections	34
4.6 Traffic Impact Rating.....	34
4.7 Advantages and Disadvantages of the Proposed Changes.....	35
5. CONCLUSION AND RECOMMENDATIONS	36

TABLE INDEX

	PAGE(S)
Table 2-1: Main Project Changes	3

Table 4-1: Site Access Assessment Summary.....	11
Table 4-2: WEF Components to be transported	16
Table 4-3: Trip Generation: Construction Phase.....	19
Table 4-4: Trip Generation: Operation Phase	21
Table 4-5: Trips Generation: Decommissioning Phase	23
Table 4-6: SANRAL Permanent stations data received	25
Table 4-7: Regression/Correlation model scaling equations	28
Table 4-8: Typical Traffic Growth Rates	29
Table 4-9: Analysed Scenarios.....	29
Table 4-10: Intersection Based Level of Service Criteria.....	30
Table 4-11: Background 2019 Traffic	31
Table 4-12: Background 2022 Traffic	31
Table 4-13: Background 2022+ Development Traffic	32
Table 4-14: Background 2044 Traffic	32
Table 4-15: Background 2044+ Development Traffic	33
Table 4-16: Traffic Impact Rating: Construction and Decommissioning Phase	34

FIGURE INDEX

	PAGE(S)
Figure 2-1: Proposed Amendment Layout.....	3
Figure 3-1: Transportation Routes Surveyed by AECOM for Umsobomvu WEF.....	6
Figure 4-1: Site Access Options to Hartebeesthoek East WEF.....	9
Figure 4-3: Site Access Option for a priority control T-junction intersection (Access F)	12
Figure 4-4: Site Access Option for a priority control T-junction intersection (Access G).....	12
Figure 4-5: Stop-Go Operation (SARTSM-Volume 2)	14
Figure 4-6: Project Phases.....	15
Figure 4-7: Construction Workforce Distribution	18
Figure 4-8: Permanent Staff Distribution.....	20
Figure 4-9: Intersections Surveyed	25

ABBREVIATIONS

IDZ	Industrial Development Zone
TIA	Traffic Impact Assessment
WEF	Wind Energy Facility
WT	Wind Turbine
WTG	Wind Turbine Generator

APPENDICES

APPENDIX A	TRAFFIC COUNTS
APPENDIX B	SITE VISIT
APPENDIX C	REGRESSION ANALYSIS EXAMPLE
APPENDIX D	STICK DIAGRAMS

1. INTRODUCTION

1.1 Background

SMEC South Africa (Pty) Ltd was appointed by ARCUS Consultancy Services (Pty) Ltd to provide an amendment report for a Traffic Impact Assessment (TIA) submitted in 2018, for the proposed Hartebeesthoek East Wind Energy Facility (WEF), a development of Hartebeesthoek Wind Farm (Pty) Ltd.

The proposed Hartebeesthoek East WEF properties are located in the Northern Cape and Eastern Cape. The WEF is located near the town of Noupport close to the intersection of the N9 and N10 National Roads. The proposed development site falls within the Umsobomvu Local Municipality, in the Pixley ka Seme District Municipality in the Northern Cape, as well as in the Inxuba Yethemba Local Municipality and Chris Hani District Municipality in the Eastern Cape.

This amendment report has been produced to assess the proposed amendments and their potential to have a significant change in impact on the traffic and surrounding transportation network.

The amendment is a result of the split of the 10 511 hectares into two separate WEF projects demarcated as:

- San Kraal Wind Energy Facility (Split 1); and
- Hartebeesthoek East Wind Energy Facility (Split 2)

1.2 Objectives

The main objective of this report is to assess the traffic impacts of the proposed amendments to the Hartebeesthoek East WEF project. NEMA EIA Regulations 2014 as amended, Regulation 32(1) (a) states that amendment reports must:

- (i) Evaluate the potential traffic impacts of the proposed changes to the development on the existing road network with surrounding traffic volumes.
- (ii) Identify the advantages and disadvantages associated with the proposed change from a transportation point of view.
- (iii) Propose and recommend avoidance, management and mitigation of traffic impacts associated with such proposed change; and
- (iv) Include any changes to the EMPr.

The contents of this report are based on the contents of the traffic impact assessment undertaken in 2018 for the originally authorised San Kraal WEF and compares those impacts to the potential impacts that may be expected from the proposed amendments. The focus of this report is the assessment of the Hartebeesthoek East WEF split 2.

2. HARTEBEESTHOEK EAST WEF PROPOSED AMENDMENTS

2.1 Project Data

The following is a list of information provided by the client about the Hartebeesthoek East Wind Facility construction:

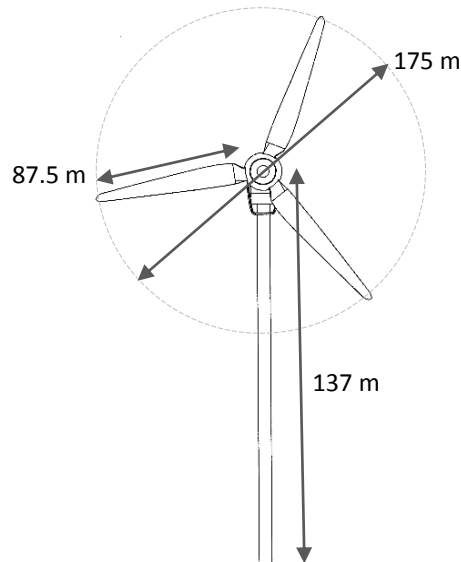

- Up to 20 wind turbines with a turbine output up to 6.2 MW and a total project output up to 124 MW;
- A rotor diameter of up to 175 m, a hub height of up to 137 m and a blade length of up to 87.5 m;
- Foundations and hardstands associated with the wind turbines;
- Internal access roads of between 8 m (during operation) and 14 m (during construction) wide to each turbine;
- 33kV underground electrical cables will be laid to transmit electricity generated by the wind turbines to the onsite switching station;
- Overhead medium voltage cables between turbine rows where necessary;
- A 7500 m² operations and services workshop area/office building for control, maintenance and storage;
- Temporary infrastructure including a site camp; and
- A laydown area approximately 7500 m² in extent, per turbine.

2.2 Proposed Amendments of Key Components

The Hartebeesthoek East WEF layout and the proposed amendments to the site layout are shown in Figure 2-1.

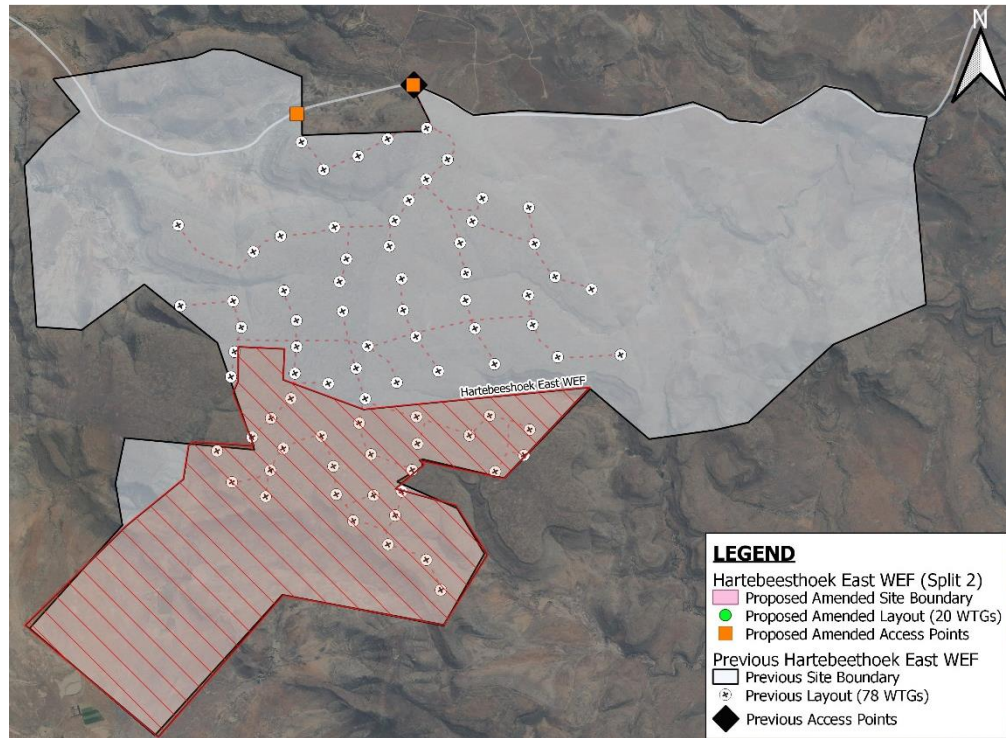

Figure 2-1: Proposed Amendment Layout

Table 2-1 presents a summary of changes proposed on key components of the WEF split compared with the previously submitted TIA. The other details of the development project will stay the same or are deemed to have no significant traffic impact and therefore, will not be considered in the assessment.

Table 2-1: Main Project Changes

Description	Previous WEF Data	Proposed Amended Data
Site Size (ha)	10,511	2,792
Project Output (MW)	390	124
No. of wind turbines	78	20
Hub Height (m)	150	137
No. of Proposed Site Access Points	1	2

The proposed changes that have the most impact on traffic generated are the number of wind turbines. This will decrease and increase trips generated to the site, respectively.

The extent of impact caused by this amendment will be quantified in the capacity and safety analysis.

3. SUMMARY OF TRAFFIC IMPACT ASSESSMENT PREVIOUSLY UNDERTAKEN

3.1 Transportation Route and Site Access and Abnormal loads

The proposed WEF is well connected to the road network and is in the vicinity of a railway line and stations, i.e. Midlandia locomotive complex, which connects to the De Aar, Northern Cape through to Port Elizabeth.

The surrounding road network comprises of the following roads:

- N10- National Class 1 principle arterial;
- N9- National Class 1 principle arterial;
- R389-Major Class 2 major arterial;
- Murray Street/Road to Oorlogspoort Class 4 District Collector; and
- Other collector and local roads in the town of Noupoort.

A transportation route was identified from the Coega Port in Port Elizabeth to the project site that is presented in Figure 3-1. The main route on the N10, as identified by the route determination report (written June 2016, by AECOM SA (Pty) Ltd for the proposed Umsobomvu WEF) was determined to be suitable for transportation of WEF components. National roads on the potential transportation routes are generally of a high standard, and many of the structures have been assessed for load-bearing capacity and height clearance in the past.

SMEC recommended that from Middleburg the vehicles will make use of the N9 heading north towards Noupoort where most of the site access options are located. It was also recommended that a formal route assessment be carried out for the portion not surveyed by the AECOM report and establish where existing public roads may need to be upgraded along the proposed equipment transport route to allow for the transportation and delivery of wind turbine components and other associated infrastructure components.

All WT components are considered to be abnormal loads, either through length, weight or height, usually comprising of 3 tower sections, 1 hub, 1 nacelle and 3 blades and will necessitate the application to the Department of Transport and Public Works for a permit authorising the conveyance of said load.

A complete transportation management plan must be undertaken prior to construction, should the project be awarded preferred bidder status.

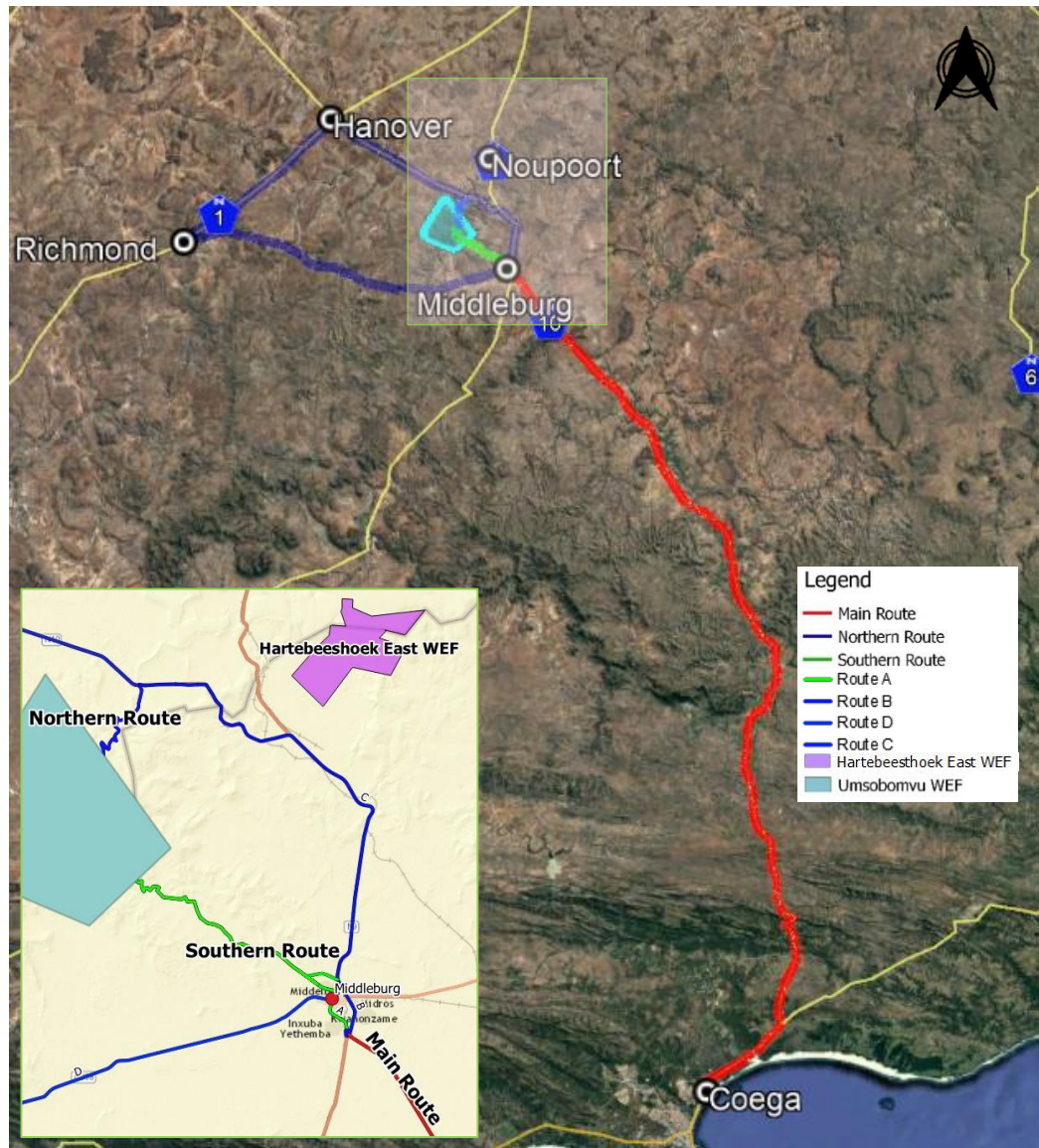

Figure 3-1: Transportation Routes Surveyed by AECOM for Umsobomvu WEF

3.2 SANRAL Consultation

Consultation took place with SANRAL on 9 January 2018. It was established that:

- SANRAL's Western Region (head office in Cape Town, Western Cape) is responsible for the section of the N9 where the access points are proposed (accesses are located in the Northern Cape). The project manager of this section of the N9 is Mr Deriek Wilson - 021 957 4600.
- The client needs to submit the TIA, a plan indicating existing intersections and layouts as well as planned intersections and proposed layouts produced by the applicant to SANRAL for approval should the project be awarded.
- This TIA needs to be submitted to SANRAL's statutory control section – Ms Colene Runkel (runkelc@nra.co.za).
- SANRAL may then request additional information as required.
- SANRAL's Southern Region (head office in Port Elizabeth, Eastern Cape) will be responsible for the remainder of the N9 route to/from the site and Port Elizabeth and will have to be consulted for any route determination requirements, which are not included in this scope of works. The project manager for the N9 between Graaff-Reinet and Carlton Heights is Mr Danford Adams - 041 398 3200.

3.3 Previously Determined Traffic Impacts

A capacity analysis to assess the level of service for the surrounding road network was undertaken using SIDRA intersection software. The Highway Capacity Manual (HCM) defines the acceptable level of service for rural Class 1 roads to be LOS B. The analysed scenarios included: a base year 2018; Pre-construction (2019), Construction (2021), Operation (2041) and Decommissioning (2043) Scenarios.

The assessment of the proposed project concluded that the development of the WEF would result in low traffic impact related to the transportation of components, equipment, materials and staff as the capacity analysis determined that the analysed intersections will operate at an acceptable LOS during both AM and PM peak hours during all stages of the project life cycles. The net effects of these impacts were deemed to be low after recommendations made for mitigation measures.

It was determined from the safety assessment of the site access points that traffic disruptions may impact the mobility of the road. It was therefore recommended that the preferred access points be widened to allow for dedicated right-turn lanes and left-turn deceleration lanes, which incorporate turning circles of the abnormal vehicles, and 500 m acceleration.

Given the findings of that report, it was recommended that the proposed construction be considered favourably from a traffic engineering point of view as the intended construction will have no negative impact on the surrounding road network after proposed mitigation has been considered and implemented.

4. TRAFFIC IMPACT ASSESSMENT OF THE PROPOSED AMENDMENTS

4.1 Site Access Options

Two site access point options and 3 intersections have been identified to provide access to the Hartebeesthoek East WEF, as shown in Figure 4-1. The Hartebeesthoek East WEF is located west of the N9 national road and is accessible from Murray Street (Road to Oorlogspoort) which runs north of the site as seen in Figure 4-1.

Providing access from the national roads will potentially impact the mobility of the road and cause speed differentials between high-speed through traffic travelling along the national roads and vehicles turning into the access roads. This has negative safety implications.

The Hartebeesthoek East WEF must be accessible to passenger cars, buses, trucks and abnormal multi-vehicle combinations which will be delivering WT components. Access to the site needs to be safe and practical to minimise the risk of pedestrian and vehicle accidents through:

- The provision of adequate traffic control; and
- Clear visibility by ensuring sufficient stopping sight distances and sufficient markings and warnings signs.

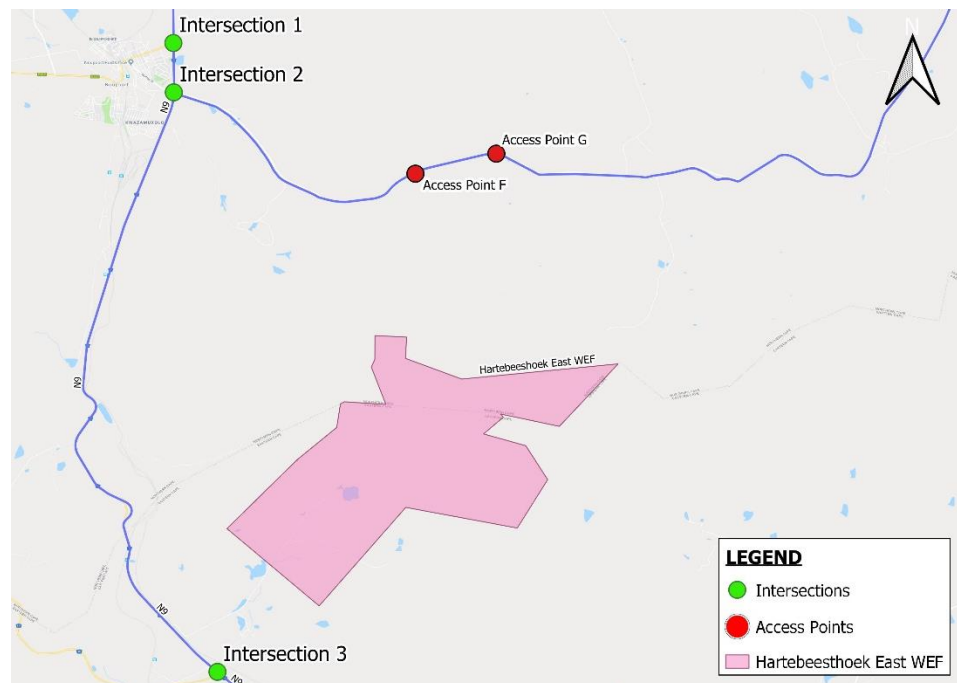

Figure 4-1: Site Access Options to Hartebeesthoek East WEF

Through site visits and desktop studies, each access point was evaluated for its suitability to serve the WEF, taking into consideration site distance lines, intersection/access spacing requirements, speed limits and road surface conditions.

A summary of the assessment of the site access points is presented in Table 4-1. Pictures and comments from the site visit are provided in Appendix B.

The minimum spacing requirements for intersections with a Rural Class 4 road, as defined by the TRH26: South African Road Classification and Access Management Manual, is 0.6 km from the centrelines of the connecting intersections. Access G does not meet minimum spacing requirements as it is located close to the existing Noupoort WEF access. It is therefore recommended that access point G be moved west, 0.6 km away from any intersection/access point, in order to comply with spacing requirements.

Based on the assessment, both Access F and G have the potential to be acceptable access points. Access F will provide access to the portion north of Murray Street, and Access G will provide access to the portion south of Murray Street.

Table 4-1: Site Access Assessment Summary

Access Point	Road	Site Distance	Intersection/Access Spacing Requirement	Existing Access/intersection?	Comments
F	Accessible from Murray Street (Road to Oorlogspoort)	No sight distance issues – sight extends for at least 500m.	1.67 km from the closest existing intersection/access. Meets minimum 0.6 km Requirement.	No	<ul style="list-style-type: none"> • Surfaced road in good condition.
G	Accessible from Murray Street (Road to Oorlogspoort)	Access is on a slight curve on the right, which might create visibility issues.	286 m from the closest existing intersection/access. Minimum requirement is 0.6 km.	No	<ul style="list-style-type: none"> • Surfaced road in good condition. • Access point G is close to the existing Noupoort Wind Farm access.

It is recommended that the access points/intersections into the site:

- Be priority controlled, with the higher category road as a priority; and
- Be widened to allow for incorporating the turning circles of the expected abnormal vehicles.

An example of the recommended intersection layout for access F and G is illustrated in Figure 4-2 and Figure 4-3, respectively.

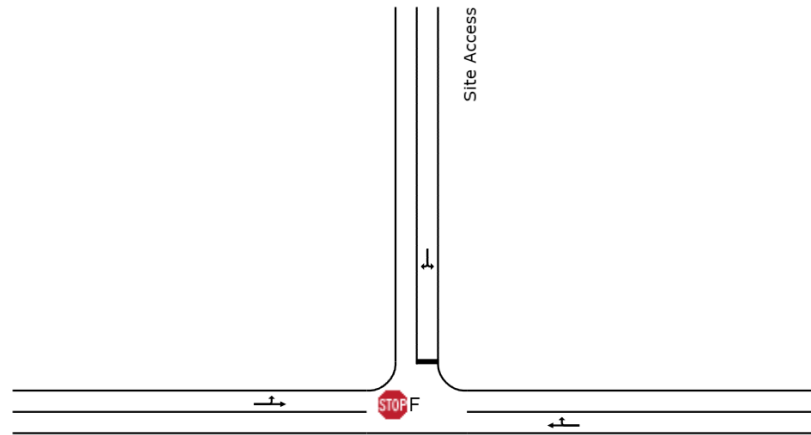

Figure 4-2: Site Access Option for a priority control T-junction intersection (Access F)

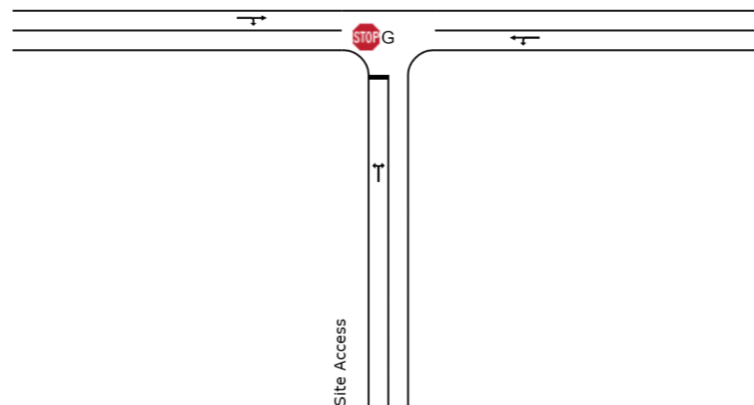
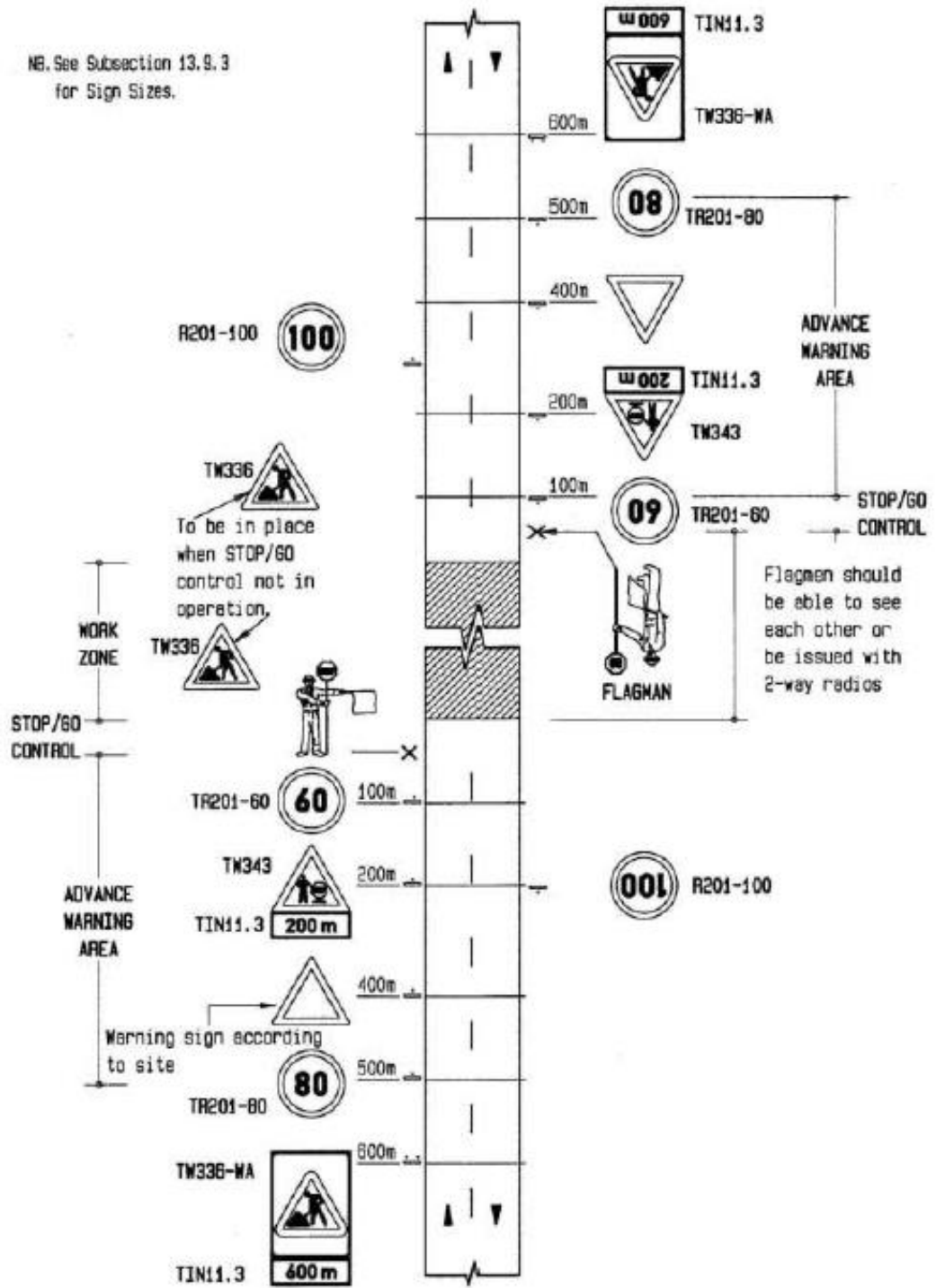

Figure 4-3: Site Access Option for a priority control T-junction intersection (Access G)

4.1.2 Impact on Road Users and Community

The presence of the heavy vehicles required during the construction and decommissioning phase may also cause noise and dust, which will impact general traffic and the local community of Noupoort located close to the WEF site. These impacts may be minimised by:

- Scheduling abnormal and heavy vehicle transport by proper distribution of arrivals and departure to avoid high numbers of vehicles arriving at once;
- Applying dust suppression techniques such as watering unpaved roads;
- Providing clear warning road markings and signage to alert road users of construction and abnormal vehicles in the area especially at access points;
- Provision of public transport vehicle lay byes, preferably on the road reserve of the minor roadway, away from principal arterials, such as the N9 and N10, as well as safe pedestrian crossings on the minor access road. This is to cater for larger numbers of persons who will be offloaded or picked up from the project site. This is required to ensure adequate separation of traffic and pedestrians; and
- Traffic accommodation during temporary roadwork's/closures, to limit impact, as per the South African Road Traffic Signs Manual, i.e. stop-go system. An example of a stop-go operation is presented in Figure 4-4.



13.44 STOP/RY-GO Operation

Figure 4-4: Stop-Go Operation (SARTSM-Volume 2)

4.2 Trip Generation

As stated previously, the trips generated at the Hartebeesthoek East WEF will vary during the different phases of the project implementation. Project phases are defined as follows:

Pre-construction	Construction	Operational	Decommissioning	Closure
<ul style="list-style-type: none"> •Site survey and preparation 	<ul style="list-style-type: none"> •All construction and installation related activities until contractor leaves the site such as component, equipment and materials truck deliveries. 	<ul style="list-style-type: none"> •All activities after construction and installation of WEF, such as operation, maintenance and other services related activities. 	<ul style="list-style-type: none"> •Withdrawal and site rehabilitation 	<ul style="list-style-type: none"> •Closure of site

Figure 4-5: Project Phases

To evaluate the impacts and traffic needs of the development on the existing road network, envisioned vehicle trips are detailed in the following sections.

4.2.1 Pre-construction

The pre-construction phase of the wind facility is expected to generate negligible traffic to site as trips generated during pre-construction phase include planning activities, site survey and site preparation.

4.2.2 Construction

Trips generated during the construction phase will primarily comprise of transporting equipment, turbine components, personnel, construction and other facility materials comprising a mix of normal, heavy and abnormal load vehicles. It is expected that the construction phase will have the highest traffic impact of all the phases.

The following assumptions were made in order to calculate trips generated during the construction phase.

- It is estimated that the construction period will last approximately less than 2 years with a 5-day working week, resulting in 400 working days over 20 months.
- The WEF will most likely be constructed from components that will need to be shipped to South Africa via the Port Elizabeth port and be transported to site via

road transport using heavy and abnormal load vehicles. It is also assumed that the turbine component delivery period will be over the course of 5 months.

- Different abnormal vehicle options, similar to the ones listed below, as found in the TRH11 (2009), may be selected depending on the service provider used to transport WT components. The remainder of the facility components and construction equipment will use standard transport vehicles and therefore, will not require abnormal vehicles.
- The following WT components and associated details as provided by the client are presented in Table 4-2.

Table 4-2: WEF Components to be transported

Component	Details	Comments and Assumptions
Tower	Length: 137 m	3 Tower sections/WT Abnormal vehicle required to transport component
Rotor	Blade Length: 87.5 m Diameter: 175m	3 Blades/WT Connected to 1 Hub/WT Abnormal vehicle required to transport component
Nacelle	Weight: 67-85 tons	1 Nacelle/WT Abnormal vehicle required to transport component
Foundation	Area: 20 m × 25 m Depth: 5 m	Reinforced Concrete Heavy vehicle to transport materials
Hard Stand Areas	Area: 7500 m ²	Levelled and compacted Heavy vehicle to transport materials
Electrical Cabling	33kV Electrical network Underground and Overhead	Concrete, steel or wood monopoles; Guy line supported steel structures; Freestanding metal lattice towers; or Multi-pole structures such as H-towers or K-towers. Heavy vehicle to transport materials

- Average “component per turbine” rate of 8 will be used (sum of abnormal components), therefore over the course of the turbine component delivery period, if 1 load is equivalent to 1 trip then approximately 160 abnormal vehicle trips to construct 20 WT, will be made to the project site.
- Some of the aggregate required for the construction of the on-site tracks may be sourced from cut and fill operations within site with additional material being obtained from borrow pits or imported from quarries as required.
- Based on figures obtained from similar construction projects, the estimated number of expected trips per turbine are:
 - Road layer works: 90 trips/WT
 - Reinforced Concrete Works: 133 trips/WT
 - Substation/Switching gear components: 3.35 trips/WT
 - Construction vehicles & water tanker: 23 trips/WT

Another contributor to trips generated to the site will be daily commuters/workers expected during construction. The following assumptions, derived from project data as provided by the client, were made:

- Due to the site being close to the town of Noupoort, the construction labour force will be mostly local.
- From the authorised TIA, it was given that approximately 300 workers will be on site. Assuming that 1 WT takes just under 2 months to construct and teams work concurrently, it is envisioned that the same number of staff would be on-site for a shorter period of time.
- The envisioned construction workforce composition is presented in Figure 4-6.
- Based on the workforce composition, it was therefore assumed that 20% of the workers would make use of private or personal vehicles (cars and light-duty trucks) travelling from their temporary or permanent place of residence to the site.
- Furthermore, it was assumed that the remainder of the 80% staff would be transported to site with 14-seater buses, whose quantities will fluctuate depending on the number of labourers, costs, routes and shuttle hours.

- For assessment purposes, only the peak morning and afternoon trip generation were assessed.

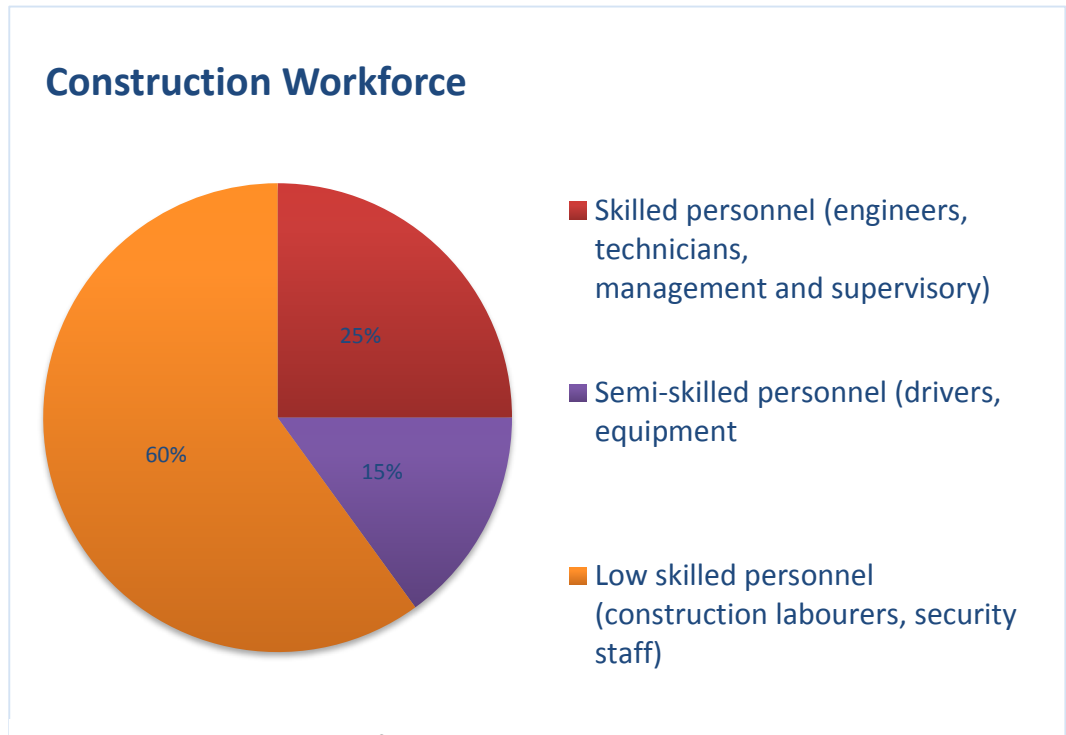

Figure 4-6: Construction Workforce Distribution

Based on the above assumptions, the expected AM and PM peak trips comprise of 18 buses and 60 vehicles. With a majority of them travelling from Noupoort to site in the AM and vice versa in the PM.

A summary of all construction trips generated in Table 4-3.

Table 4-3: Trip Generation: Construction Phase

Activity	Period (days)	Components	Trips/Turbine	Total 1-way Trips for WEF Project	Daily Trips	Peak Hours Trips	PCU Trips
Transportation of WT Components	103	Blade (abnormal)	3	60	1	1	2
		Tower (abnormal)	3	60	1	1	2
		Hub(abnormal)	1	20	0	0	1
		Nacelle(abnormal)	1	20	0	0	1
		Reinforced Concrete works	133	2650	13	7	23
		Road Layer works	90	1800	9	4	16
Substation	103	2 Transformers	-	2	0	0	0
		Switching Gear and other Substation Equipment	3	67	1	1	2
Site Work Activities	400	Construction Vehicles & Water Tanker	23	460	1	1	2
		Crane Transport	-	4	0	0	0
		Labour Transport (Passenger Vehicles)	-	60	120	60	60
		Labour Transport (Bus)	-	18	36	18	18
Total				5221	184	92	127

4.2.3 Operational

The operational phase is expected to have comparatively minimal traffic impact as the only transport required will be associated with monitoring, operation and maintenance. During the operational phase of the wind farm, the following assumptions, derived from project data as provided by the client, were made:

- The wind farm will be in operation over a 20-year lifespan.
- Activities on the wind farm include maintenance on an ongoing basis.
- An estimated 13 permanent staff will be working on the site consisting of operational and maintenance technicians, rehabilitation of vegetation and bird and bat post-construction monitoring because the number of WT has decreased. Figure 4-7 presents the envisioned permanent staff composition.
- Staff will likely make use of passenger vehicles and light-duty trucks (i.e. Bakkie/4x4) to commute to the site daily.
- There will be a possibility for excavations, planned and emergency maintenance, replacement or service of WT components, requiring the use of the above mentioned heavy and abnormal vehicles travelling from PE. It is assumed that, in such a case, the staff's origin will be from Noupoort.
- It is assumed that during a maintenance/service or repair event, at least 3 trucks will be expected on site: 1 abnormal vehicle and 2 Heavy vehicles (equipment trucks).

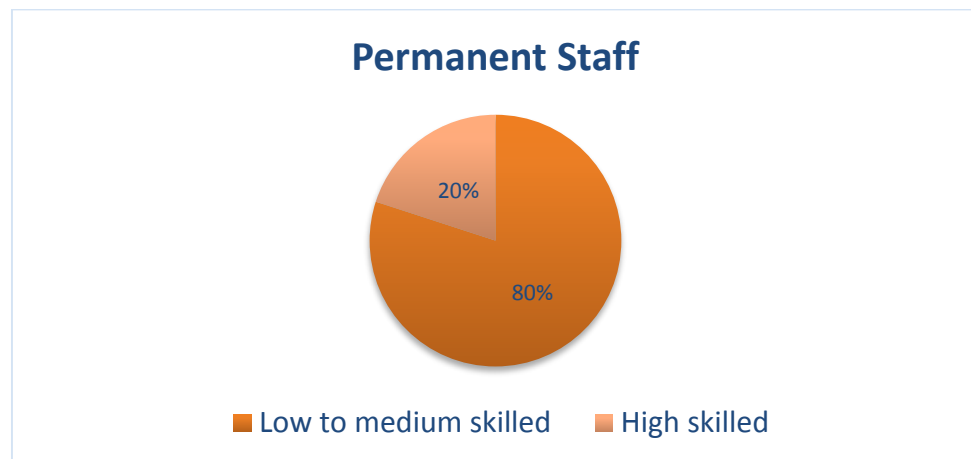

Figure 4-7: Permanent Staff Distribution

A summary of all operational trips generated is presented in Table 4-4.

Table 4-4: Trip Generation: Operation Phase

Activity	Period (days)	Components	Trips/Turbine	Total 1-way Trips for WEF Project	Daily Trips	Peak Hours Trips	PCU Trips
1 Repair Event	20	Abnormal Trucks	1	1	2	1	4
		Trucks	2	2	4	2	7
Daily Operation Activities	20	Labour Transport (Passenger Vehicles)	-	13	26	13	13
Total				16	32	16	24

4.2.1 Decommissioning

There are three possibilities as specified by the client for the decommissioning phase of the project as listed below.

1. After the 20-year lifespan of the WEF, the need for continued generation of electricity through wind energy is still required, and the WEF is renovated with new towers on the existing foundation in order to serve another 20 years. 50 people will be needed, and components will be transported from Port Elizabeth.
2. The WEF is converted into another alternative renewable energy facility. The specifications around this are unknown.
3. There is no longer an economical / technical basis for an energy plant, and the WEF is decommissioned, and the land is rehabilitated.

For trip generation purposes, the third possibility was considered to be a conservative, worst-case assumption. The relevant assumption made in the construction phase was used here as it will take about 2 years to decommission and rehabilitate the site. About 300 people will be needed with similar transport in the construction phase. All parts will be either reused or recycled and would most likely be transported back to Port Elizabeth. The decommissioning phase is expected to generate the second-highest traffic impact after construction as a result of the need to remove the infrastructure and rehabilitate the site.

A summary of all decommissioning trips generated is presented in Table 4-5.

Table 4-5: Trips Generation: Decommissioning Phase

Activity	Period (days)	Components	Trips/Turbine	Total 1-way Trips for WEF Project	Daily Trips	Peak Hours Trips	PCU Trips
Recycling of WT Components	103	Blade (abnormal)	8	160	3	2	5
Rubble removal and flattening	400	Construction Vehicles & Water Tanker	50	250	25	12	44
Labour Transport		Labour Transport (Passenger Vehicles)	-	60	120	60	60
		Labour Transport (Bus)	-	18	36	18	18
Total				488	184	92	127

4.2.2 Closure

The closure phase of the wind facility is expected to generate negligible traffic to the site.

4.3 Trip distribution and assignment

A majority of WT components are assumed to be transported to Hartebeesthoek East WEF on the N10 using site Access G and F.

The trips generated were distributed onto the surrounding road network with:

- 100% of delivery trips travelling from the Coega PE Port along the N10 & N9
- 100% of daily commuter trips from Noupoort town via R389

Diagrams showing trip distribution and assignment are provided in Appendix D.

4.4 Road capacity and safety assessment

Intersection capacity analyses were undertaken to determine the anticipated operational performance of the site access points and the surrounding road network. The intersection capacity analysis was conducted using SIDRA Intersection 8.0 Intersection software. The intersections analysed are listed below and presented in Figure 4-8.

- M1: N9 & Shaw St
- M2: N9 & Murray St
- M3: N9 & N10
- M4: R389 & road to N10

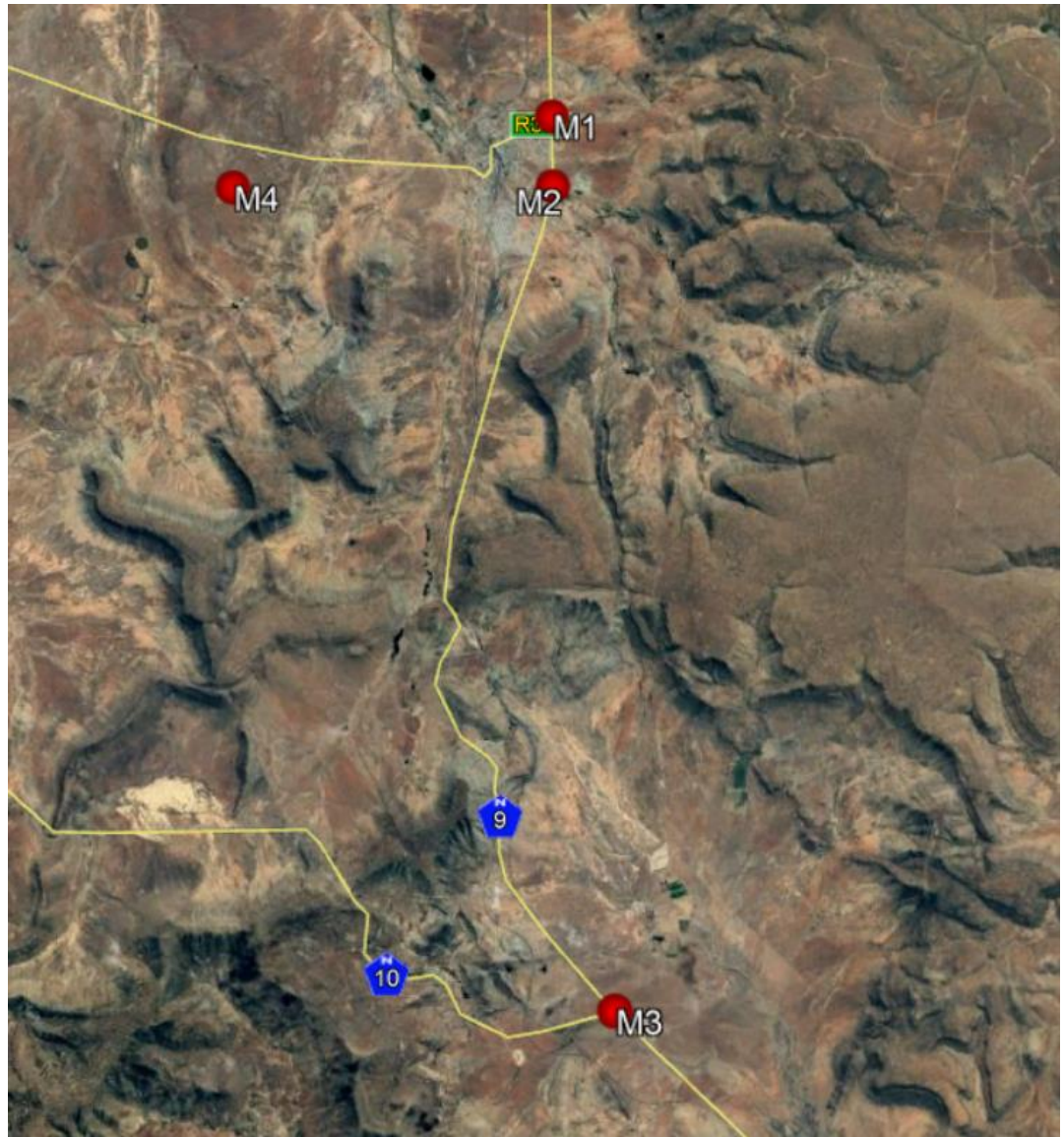

Figure 4-8: Intersections Surveyed

4.4.2 SANRAL Traffic Data

The following is the summary of data sourced from SANRAL.

Table 4-6: SANRAL Permanent stations data received

Station no.	Location	From	To	Comments
1477	Hanover East	2016-01-01	2017-12-07	Per direction Classified Typical Vol/hr for 2016-2017

2733	Between Noupoot and Middelburg	2013-08-26	2013-08-29	Per direction Not Classified Typical Vol/hr for 2013
2741	Middleburg	2014-01-21	2014-01-24	Per direction Not Classified Typical Vol/hr for 2014

4.4.3 12 hour all turning movements traffic counts

Surveys were undertaken at four-count stations surrounding the site consisting of 12-hour manual traffic counts. The counts were done on Wednesday, 10 January 2019 from 06:00 to 18:00 at the following locations:

- Station M1: N9 and Shaw St
- Station M2: N9 and Murray St
- Station M3: N9 and N10
- Station M4: R389 and road to N10

The vehicles were classified as light, taxi, bus and heavy vehicles per direction in 15-minute intervals. Data collected is attached in Appendix A. It should be noted that the majority of light vehicles were holiday traffic at the time of the year when the counts were conducted. A correction was applied to traffic volumes, as discussed in Section 4.4.4, using the regression analysis equations to normalise data.

4.4.4 Regression analysis

To estimate representative traffic volumes, on a normal Wednesday, the following methodology was applied:

- Correlation plot/regression analysis was used to determine the degree of relationship between two data sets, namely:
 - Data set 1: 2nd Wednesday of January (Abnormal)
 - Data set 2: 2nd Wednesday of October (Normal)

This was done to normalise January data using normal conditions for a normal day defined as a Wednesday in October.

- Scaling equations (Table 4-7) were derived from applying a regression model using SANRAL permanent station data and 24-hour traffic counts.

An example of how the regression analysis was derived and applied to traffic volumes of an intersection is attached in Appendix C.

Table 4-7: Regression/Correlation model scaling equations

Source	Type	Count Station	Data Type	Data Available	Scaling Equations
Trafftrans	New Count	1	12 Hour	10 January 2018	$y = 0.739x + 5.068$
Trafftrans	New Count	2	12 Hour	10 January 2018	$y = 0.739x + 5.068$
Trafftrans	New Count	3	12 Hour	10 January 2018	$y = 0.739x + 5.068$
Trafftrans	New Count	4	12 Hour	10 January 2018	$y = 0.739x + 5.068$

4.4.5 Capacity Analysis Scenarios

It is required to grow background traffic flow to an acceptable horizon year to ensure that the future road network would be able to operate adequately. In the absence of historical data, the COTO, TMH17 Volume 1 Manual provides typical growth rates to be used for growth areas based on the existing/anticipated rate of growth. Typical traffic growth rates are illustrated in Table 4-8.

Table 4-8: Typical Traffic Growth Rates

DEVELOPMENT AREA	GROWTH RATE
Low Growth Areas	0% - 3%
Average Growth Areas	3% - 4%
Above Average Growth Areas	4% - 6%
Fast Growing Areas	6% - 8%
Exceptionally High Growth Areas	> 8%

The Noupport area was considered to be a low growth area. Taking into account the additional WEF being developed in the area, a 3% per annum growth rate was assumed to represent the expected traffic growth.

To identify any shortcomings in the road-based capacity in the short-term, a base year assessment was undertaken. Furthermore, the background traffic was grown to an acceptable horizon year to ensure that the proposed road network would be able to operate adequately once the development is constructed. The scenarios analysed to quantify the impact of the amendments are as follows:

Table 4-9: Analysed Scenarios

Phase	Scenario	Year	
Base	1	2019	Existing Traffic
Construction	2	2022	Background Traffic
	3		Background+ Development Traffic
Decommissioning	4	2044	Background Traffic
	5		Background+ Development Traffic

The operational performance of an intersection is defined by the level of service (LOS) for each approach to the intersection. These definitions, as defined in the Highway Capacity Manual (HCM), relate average delays at intersections for individual turning movements, for each approach and the overall intersection to a Level of Service ranging from A to F,

as shown in Table 4-10. During the peak hours, the road infrastructure capacity provided should ensure that the intersection approach level of service should ideally not exceed LOS D. Because Noupoot is located in a rural part of the country, the TMH 16 defines acceptable LOS for Rural class 1-2 roads is LOS B on a days and LOS C on abnormal days.

It should be noted that Intersection Level of Service (LOS) and Major Road Approach LOS values are not applicable for two-way sign control since the average delay is not a useful LOS measure due to zero delays associated with major road movements. However, results will give an indication of delay and LOS for the minor road approaching the major road.

Table 4-10: Intersection Based Level of Service Criteria

Level of Service	Control Delay per Vehicle in Seconds (d)	
	Signals and Roundabouts	Stop Signs and Yield Signs
A	$d \leq 10$	$d \leq 10$
B	$10 < d \leq 20$	$10 < d \leq 15$
C	$20 < d \leq 35$	$15 < d \leq 25$
D	$35 < d \leq 55$	$25 < d \leq 35$
E	$55 < d \leq 80$	$35 < d \leq 50$
F	$80 < d$	$50 < d$

(a) Scenario 1: AM and PM Background 2019 Traffic;

Capacity analysis for 2019 traffic volumes is summarised in Table 4-11.

Table 4-11: Background 2019 Traffic

INTERSECTION APPROACH		Hartebeesthoek East Energy Facility							
		Weekday AM				Weekday PM			
		Delay (sec)	V/C (%)	LOS	95% queue (m)	Delay (sec)	V/C (%)	LOS	95% queue (m)
1. N9 & Shaw St	South	0.9	4.0	A	0.0	0.7	7.1	A	0.0
	East	8.6	1.8	A	0.1	9.2	2.0	A	0.1
	North	1.6	2.4	A	0.0	1.5	3.4	A	0.0
	West	10.0	3.3	A	0.1	10.6	3.4	B	0.1
OVERALL (LOS)		A				A			
2.N9 & Murray St	South	1.3	4.5	A	0.0	0.9	7.5	A	0.0
	East	8.7	2.3	A	0.1	10.4	2.9	B	0.1
	North	1.4	2.7	A	0.0	1.0	3.5	A	0.0
	West	1.4	2.4	A	0.1	9.5	3.2	A	0.1
OVERALL (LOS)		A				A			
3. N9 & N10	South	0.9	4.7	A	0.0	0.6	6.9	A	0.0
	East	N/A	N/A	N/A	N/A	N/A	N/A	N/A	N/A
	North	1.0	2.4	A	0.0	0.7	4.1	A	0.0
	West	10.2	3.4	B	0.1	11.2	3.5	B	0.1
OVERALL (LOS)		A				A			
4. R389 & road to N10	South	2.5	0.7	A	0.0	3.0	0.6	A	0.0
	East	N/A	N/A	N/A	N/A	N/A	N/A	N/A	N/A
	North	5.5	0.7	A	0.0	5.5	1.0	A	0.0
	West	2.8	0.6	A	0.0	2.8	0.8	A	0.0
OVERALL (LOS)		A				A			

(b) Scenario 2: AM and PM Background 2022 Traffic;

Capacity analysis for 2022 traffic volumes is summarised in Table 4-12.

Table 4-12: Background 2022 Traffic

INTERSECTION APPROACH		Hartebeesthoek East Energy Facility							
		Weekday AM				Weekday PM			
		Delay (sec)	V/C (%)	LOS	95% queue (m)	Delay (sec)	V/C (%)	LOS	95% queue (m)
1. N9 & Shaw St	South	0.9	4.4	A	0.0	0.7	7.3	A	0.0
	East	8.7	2.2	A	0.1	9.4	2.4	A	0.1
	North	1.7	2.6	A	0.0	1.5	4.2	A	0.0
	West	10.2	3.7	A	0.1	10.9	3.8	B	0.1
OVERALL (LOS)		A				A			
2.N9 & Murray St	South	1.3	4.9	A	0.0	1.0	8.0	A	0.0
	East	8.8	2.7	A	0.1	9.4	2.8	A	0.1
	North	1.5	2.9	A	0.0	1.1	4.1	A	0.0
	West	8.9	2.5	A	0.1	9.7	3.7	A	0.1
OVERALL (LOS)		A				A			
3. N9 & N10	South	0.9	5.1	A	0.0	0.6	7.2	A	0.0
	East	N/A	N/A	N/A	N/A	N/A	N/A	N/A	N/A
	North	0.9	2.6	A	0.0	0.6	4.8	A	0.0

INTERSECTION APPROACH		Hartebeesthoek East Energy Facility							
		Weekday AM				Weekday PM			
		Delay (sec)	V/C (%)	LOS	95% queue (m)	Delay (sec)	V/C (%)	LOS	95% queue (m)
	West	10.3	3.9	B	0.1	11.0	3.8	B	0.1
OVERALL (LOS)		A				A			
4. R389 & road to N10	South	2.8	0.8	A	0.0	3.0	0.7	A	0.0
	East	N/A	N/A	N/A	N/A	N/A	N/A	N/A	N/A
	North	5.5	0.9	A	0.0	5.5	1.1	A	0.0
	West	2.8	0.7	A	0.0	2.8	0.8	A	0.0
OVERALL (LOS)		A				A			

(c) Scenario 3: AM and PM Background 2022+ Development Traffic;

Capacity analysis for 2022 traffic volumes is summarised in Table 4-13.

Table 4-13: Background 2022+ Development Traffic

INTERSECTION APPROACH		Hartebeesthoek East Energy Facility							
		Weekday AM				Weekday PM			
		Delay (sec)	V/C (%)	LOS	95% queue (m)	Delay (sec)	V/C (%)	LOS	95% queue (m)
1. N9 & Shaw St	South	0.9	4.4	A	0.0	0.7	7.4	A	0.0
	East	8.8	2.2	A	0.1	9.4	2.4	A	0.1
	North	1.5	2.9	A	0.0	1.5	4.2	A	0.0
	West	10.3	3.7	B	0.1	11.0	3.8	B	0.1
OVERALL (LOS)		A				A			
2. N9 & Murray St	South	3.2	5.0	A	0.2	2.2	8.1	A	0.2
	East	9.3	3.4	A	0.1	8.7	11.5	A	0.4
	North	1.7	3.1	A	0.0	1.1	4.1	A	0.0
	West	9.8	11.8	A	0.5	10.7	4.3	B	0.2
OVERALL (LOS)		A				A			
3. N9 & N10	South	0.6	8.4	A	0.0	0.5	9.4	A	0.0
	East	N/A	N/A	N/A	N/A	N/A	N/A	N/A	N/A
	North	0.9	2.9	A	0.0	0.3	10.8	A	0.0
	West	11.0	4.3	B	0.2	12.8	4.8	B	0.2
OVERALL (LOS)		A				A			
4. R389 & road to N10	South	2.8	0.8	A	0.0	3.0	0.7	A	0.0
	East	N/A	N/A	N/A	N/A	N/A	N/A	N/A	N/A
	North	5.5	0.9	A	0.0	5.5	1.1	A	0.0
	West	2.8	0.7	A	0.0	2.8	0.8	A	0.0
OVERALL (LOS)		A				A			

(d) Scenario 4: AM and PM Background 2044 Traffic;

Capacity analysis for 2044 traffic volumes is summarised in Table 4-14.

Table 4-14: Background 2044 Traffic

INTERSECTION APPROACH		Hartebeesthoek East Energy Facility							
		Weekday AM				Weekday PM			
		Delay (sec)	V/C (%)	LOS	95% queue (m)	Delay (sec)	V/C (%)	LOS	95% queue (m)
1. N9 & Shaw St	South	0.9	8.4	A	0	0.7	14.0	A	0.0
	East	9.8	4.7	A	0.2	11.5	6.0	B	0.2
	North	1.7	5.1	A	0	1.6	8.0	A	0.1
	West	12.0	8.6	B	0.3	14.0	10.9	B	0.4
OVERALL (LOS)		A				A			
2.N9 & Murray St	South	1.3	9.4	A	0.1	1.1	15.4	A	0.1
	East	10.0	6.0	A	0.2	11.5	7.3	B	0.3
	North	1.5	5.6	A	0.0	1.1	7.8	A	0.0
	West	10.2	6.0	B	0.2	12.4	10.1	B	0.4
OVERALL (LOS)		A				A			
3. N9 & N10	South	0.9	9.8	A	0.0	0.6	13.8	A	0.0
	East	N/A	N/A	N/A	N/A	N/A	N/A	N/A	N/A
	North	1.0	5.0	A	0.0	0.7	9.3	A	0.1
	West	12.1	9.2	B	0.3	14.3	10.5	B	0.4
OVERALL (LOS)		A				A			
4. R389 & road to N10	South	2.7	1.5	A	0.1	3.0	1.4	A	0.1
	East	N/A	N/A	N/A	N/A	N/A	N/A	N/A	N/A
	North	5.6	1.6	A	0.1	5.6	2.1	A	0.1
	West	2.8	1.2	A	0.0	2.8	1.5	A	0.0
OVERALL (LOS)		A				A			

(e) Scenario 5: AM and PM Background 2044+ Development Traffic;

Capacity analysis for 2044 traffic volumes is summarised in Table 4-15

Table 4-15: Background 2044+ Development Traffic

INTERSECTION APPROACH		Hartebeesthoek East Energy Facility							
		Weekday AM				Weekday PM			
		Delay (sec)	V/C (%)	LOS	95% queue (m)	Delay (sec)	V/C (%)	LOS	95% queue (m)
1. N9 & Shaw St	South	0.9	8.4	A	0.0	0.7	14.1	A	0.0
	East	9.8	4.7	A	0.2	11.5	6.0	B	0.2
	North	1.6	5.3	A	0.0	1.6	8.0	A	0.1
	West	12.1	8.7	B	0.3	14.3	10.6	B	0.4
OVERALL (LOS)		A				A			
2.N9 & Murray St	South	2.6	9.4	A	0.3	1.8	15.4	A	0.2
	East	10.8	7.1	B	0.3	10.0	17.1	B	0.7
	North	1.6	5.8	A	0.0	1.1	7.8	A	0.0
	West	11.5	17.8	B	0.7	14.1	11.9	B	0.4
OVERALL (LOS)		A				A			
3. N9 & N10	South	0.7	13.0	A	0.0	0.5	16.0	A	0.0
	East	N/A	N/A	N/A	N/A	N/A	N/A	N/A	N/A
	North	1.0	5.3	A	0.1	0.5	15.3	A	0.1
	West	13.2	10.3	B	0.4	17.3	13.6	C	0.5

INTERSECTION APPROACH		Hartebeesthoek East Energy Facility							
		Weekday AM				Weekday PM			
		Delay (sec)	V/C (%)	LOS	95% queue (m)	Delay (sec)	V/C (%)	LOS	95% queue (m)
OVERALL (LOS)		A				A			
4. R389 & road to N10	South	2.7	1.5	A	0.1	3.0	1.4	A	0.1
	East	N/A	N/A	N/A	N/A	N/A	N/A	N/A	N/A
	North	5.6	1.6	A	0.1	5.6	2.1	A	0.1
	West	2.8	1.2	A	0.0	2.8	1.5	A	0.0
OVERALL (LOS)		A				A			

4.5 Potential impacts of the development on intersections

From the capacity analysis in Section 4.4.5, it can be seen that all assessed legs of the assessed intersections operate at a LOS A or B. The following is a summary of results for all the analysed scenarios:

Intersection 1 – N9 & Shaw St: All approaches operate at acceptable LOS during both the AM and PM peak hours;

Intersection 2 – N9 & Murray St: All approaches operate at acceptable LOS during both the AM and PM peak hours;

Intersection 3 – N9 & N10: All approaches operate at acceptable LOS during both the AM and PM peak hours; and

Intersection 4 – R389 & road to N10: All approaches operate at acceptable LOS during both the AM and PM peak hours.

Therefore, it can be concluded that the road capacity will maintain and perform at acceptable levels of service.

4.6 Traffic Impact Rating

This assessment of traffic impact during the lifecycle of the project also has to inform the EIA phase, where an environmental significance scale is used to evaluate the importance of a particular impact. Table 4-16 indicates the originally identified impacts associated with the traffic. The significance during the operational phase is considered very low with mitigation.

Table 4-16: Traffic Impact Rating: Construction and Decommissioning Phase

Impact Phase: Construction/Decommissioning							
Potential impact description: Increase traffic on the route and access points to the site, potential to be greater than what the existing road capacity of the local road network can handle in order to operate at an acceptable level of service.							
	Severity	Extent	Duration	Status	Probability	Significance	Confidence
Without Mitigation	Medium (M)	Regional to local (L)	Short Term (L)	Negative (L)	Probable (H)	Low (L)	Sure (H)
With Mitigation	Low (L)	Regional to local (L)	Short Term (L)	Neutral (L)	Probable (H)	Very Low (L)	Sure (H)
Can the impact be reversed?			Through proper coordination of arrivals and departure to avoid high numbers of vehicles arriving at once. Provision of traffic management controls at access points to site.				
Will impact cause irreplaceable loss or resources?			Road safety concerns may lead to higher risks of fatal accidents.				
Can impact be avoided, managed or mitigated?			Implementation of a traffic management plan and road upgrades where necessary (intersection/access points) and may manage/mitigate safety concerns and minimise traffic disruptions.				
Mitigation measures to reduce residual risk or enhance opportunities:							
<ul style="list-style-type: none"> - Arrival and departure of abnormal and heavy vehicle traffic should be coordinated and distributed throughout the day. - Community must be informed before the start of site activities. - Additional traffic management control measures at site accesses must be implemented, which may include warning and construction vehicles signage and/or flagmen to assist during detours or temporary road closures. - Use of access points G and F are recommended subject to approval from SANRAL. Access points must be priority stop-controlled, with the national roads as a priority. - Provision must be made for 500 m acceleration lanes, to allow trucks turning onto a road to accelerate before entering the traffic stream, and the road widened to allow for a dedicated right turn and left turn (auxiliary lanes) lanes off the main road and must incorporate the turning circles of the expected vehicles. 							
Residual impact	- Yes, but acceptable						

4.7 Advantages and Disadvantages of the Proposed Changes

The changes in the number of wind turbines determined to have no significant changes in road capacity and safety recommendations when compared to the previously undertaken TIA. Advantages of the proposed changes include the decrease in abnormal heavy traffic generated by the transportation of wind turbine components. This will lessen the number of disturbances of vehicle traffic that is usually associated with the transportation of wind turbine components.

5. CONCLUSION AND RECOMMENDATIONS

Based on the information detailed in this report, the following conclusions are drawn:

- The base year and forecast year road capacity has indicated that the proposed development and proposed amendments will have no significant change in impact on the existing road network capacity and the project will maintain acceptable levels of service.
- The safety assessment has indicated that the proposed development will have some impact at proposed access points. Providing access to national roads will impact the mobility of the road. Therefore adequate traffic control and clear road markings and warnings signs must be provided.
- Given the findings of this report, it is recommended that the proposed construction be considered favourably from a traffic engineering point of view as the intended construction will have no significant negative impact on the surrounding road network.

The following recommendations are made:

- A comprehensive route assessment of the entire route is recommended should the project be awarded to a preferred bidder as part of the REIPPP process.
- Scheduling abnormal and heavy vehicle transport by proper distribution of arrivals and departure to avoid high numbers of vehicles arriving at once
- Access point G and F are recommended as the preferred access positions, based on safety considerations.
- It is recommended that access point G be moved west, 0.6 km away from any intersection/access point, in order to comply with spacing requirements.
- It is recommended that access points control be priority controlled, with the higher category road as a priority.
- Roads should be widened to allow for incorporating the turning circles of the expected abnormal vehicles at access points.
- Provision must be made for clear warning road markings and signage on both sides of both approaches of access points.
- Traffic accommodation measures during temporary roadwork's/closures must be implemented as per the South African Road Traffic Signs Manual.
- In addition, allowance must be made for public transport vehicle lay byes preferably on the road verge away from the roadway, as well as safe pedestrian crossings on the minor access road.
- Clearances permits will be required for the transport of the WT components.

- It is recommended that applications for Abnormal Permits be lodged to the Department of Transport and Public Works, Eskom and Telkom.

APPENDIX A	TRAFFIC COUNTS
APPENDIX B	SITE VISIT
APPENDIX C	REGRESSION ANALYSIS EXAMPLE
APPENDIX D	STICK DIAGRAMS

Appendix A

SUMMARY OF TRAFFIC COUNTS

STATION: M1
 LOCATION: N/S E/W

N9
 Shaw

LAT: 31° 10' 27.5" S DATE: 10/01/2018
 LONG: 24° 57' 47.7" E Wednesday

MOVEMENT		AM PEAK HOUR						PM PEAK HOUR					
		LIGHT	TAXI	BUS	HEAVY	TOTAL	PHF	LIGHT	TAXI	BUS	HEAVY	TOTAL	PHF
FROM	NO	VOL	VOL	VOL	VOL	VOL		VOL	VOL	VOL	VOL	VOL	
N O R T H	1 R	2				2	0.71	7			1	8	0.77
	2 T	14			17	31		37			19	56	
	3 L												
E A S T	4 R						n.a.						n.a.
	5 T												
	6 L												
S O U T H	7 R						0.86						0.57
	8 T	65			10	75		99			31	131	
	9 L	2				2		5				5	
W E S T	10 R	6				6	0.67	3				3	0.50
	11 T				1	1							
	12 L	2				2		5				5	
TOTAL		91			28	119	0.85	156			51	208	0.68
VEH SPLIT		76%			24%	100%		75%			25%	100%	
		PERCENTAGE OF: 12H				5.9%		PERCENTAGE OF: 12H				10.3%	

MOVEMENT		MIDDAY PEAK HOUR						12 HOUR COUNT				
		LIGHT	TAXI	BUS	HEAVY	TOTAL	PHF	LIGHT	TAXI	BUS	HEAVY	TOTAL
FROM	NO	VOL	VOL	VOL	VOL	VOL		VOL	VOL	VOL	VOL	VOL
N O R T H	1 R	5				5	0.62	49			2	51
	2 T	49			16	65		349	7	1	198	555
	3 L											
E A S T	4 R						n.a.					
	5 T				1	1					3	3
	6 L											
S O U T H	7 R						0.74					
	8 T	156			10	168		1061	5	1	170	1237
	9 L	6			1	7		55			2	57
W E S T	10 R	4				4	0.44	44	1			45
	11 T				1	1					3	3
	12 L	11				11		61		1		62
TOTAL		231			29	262	0.87	1619	13	3	378	2013
VEH SPLIT		88%			11%	100%		80%	1%	0%	19%	100%
		PERCENTAGE OF: 12H				13.0%						

STARTING TIME OF PEAK HOUR

AM MID PM
 08:00 11:30 15:00

NOTE: SEE ATTACHED SKETCH FOR LAYOUT OF STATION

PREPARED BY TRAFFTRANS (PTY) LTD

SUMMARY OF TRAFFIC COUNTS

STATION: M2
 LOCATION: N/S N9
 E/W Murray

LAT: 31° 11' 11.7" S DATE: 10/01/2018
 LONG: 24° 57' 48.0" E Wednesday

MOVEMENT FROM NO		AM PEAK HOUR						PM PEAK HOUR						
		LIGHT VOL	TAXI VOL	BUS VOL	HEAVY VOL	TOTAL VOL	PHF	LIGHT VOL	TAXI VOL	BUS VOL	HEAVY VOL	TOTAL VOL	PHF	
NORTH	1 R							1				1	0.79	
	2 T	20			17	37	0.79	39			19	58		0.77
	3 L	1				1								
EAST	4 R						0.50						0.58	
	5 T	4				4		0.50	3					3
	6 L	1				1						2		2
SOUTH	7 R	1			1	2	0.89	3				3	0.57	
	8 T	67			10	77		0.89	103			31		135
	9 L	5			2	7			12					12
WEST	10 R	2				2	0.63	8				8	0.63	
	11 T	2				2		0.63	1					1
	12 L								1					1
TOTAL		103			30	133	0.90	171			52	224	0.67	
VEH SPLIT		77%			23%	100%		76%			23%	100%		
		PERCENTAGE OF: 12H				6.2%		PERCENTAGE OF: 12H				10.4%		

MOVEMENT FROM NO		MIDDAY PEAK HOUR						12 HOUR COUNT					
		LIGHT VOL	TAXI VOL	BUS VOL	HEAVY VOL	TOTAL VOL	PHF	LIGHT VOL	TAXI VOL	BUS VOL	HEAVY VOL	TOTAL VOL	
NORTH	1 R	1				1	0.63	7			1	8	
	2 T	50			22	72		0.63	383	8	1	196	588
	3 L								10			1	11
EAST	4 R						0.63	7				7	
	5 T	5				5		0.63	36			1	37
	6 L								14			2	16
SOUTH	7 R	3				3	0.73	20			1	21	
	8 T	156			12	170		0.73	1096	5	1	172	1274
	9 L	12				12			77			4	81
WEST	10 R	8			1	9	0.54	60			4	64	
	11 T	3				3		0.54	26			1	27
	12 L	1				1			20				20
TOTAL		239			35	276	0.68	1756	13	2	383	2154	
VEH SPLIT		87%			13%	100%		82%	1%	0%	18%	100%	
		PERCENTAGE OF: 12H				12.8%							

STARTING TIME OF PEAK HOUR
 AM 08:00 MID 11:15 PM 15:00

NOTE: SEE ATTACHED SKETCH FOR LAYOUT OF STATION PREPARED BY TRAFFTRANS (PTY) LTD

SUMMARY OF TRAFFIC COUNTS

STATION: M3

LOCATION: N/S N9
E/W N10

LAT: 31° 19' 48.0" S DATE: 10/01/2018

LONG: 24° 58' 26.6" E Wednesday

MOVEMENT FROM NO		AM PEAK HOUR						PM PEAK HOUR					
		LIGHT VOL	TAXI VOL	BUS VOL	HEAVY VOL	TOTAL VOL	PHF	LIGHT VOL	TAXI VOL	BUS VOL	HEAVY VOL	TOTAL VOL	PHF
NORTH	1 R	2				2	0.77	3				3	0.85
	2 T	21			17	38		52	1		23	76	
	3 L												
EAST	4 R						n.a.						n.a.
	5 T												
	6 L												
SOUTH	7 R						0.86						0.74
	8 T	83			14	97		109			31	140	
	9 L	7			5	12		6			3	9	
WEST	10 R	11			6	17	0.59	8			6	14	0.58
	11 T												
	12 L	1				1		1				1	
TOTAL		125			42	167	0.89	179	1		63	243	0.82
VEH SPLIT		75%			25%	100%		74%	0%		26%	100%	
		PERCENTAGE OF: 12H				6.9%		PERCENTAGE OF: 12H				10.0%	

MOVEMENT FROM NO		MIDDAY PEAK HOUR						12 HOUR COUNT				
		LIGHT VOL	TAXI VOL	BUS VOL	HEAVY VOL	TOTAL VOL	PHF	LIGHT VOL	TAXI VOL	BUS VOL	HEAVY VOL	TOTAL VOL
NORTH	1 R				1	1	0.68	13	2		2	17
	2 T	49			23	72		429	7	1	197	634
	3 L											
EAST	4 R						n.a.					
	5 T											
	6 L											
SOUTH	7 R						0.74					
	8 T	171			11	184		1170	3	1	172	1346
	9 L	22			6	29		111	1		99	211
WEST	10 R	3			9	12	0.75	74	11		119	204
	11 T											
	12 L							7			1	8
TOTAL		245			50	298	0.79	1804	24	2	590	2420
VEH SPLIT		82%			17%	100%		75%	1%	0%	24%	100%
		PERCENTAGE OF: 12H				12.3%						

AM MID PM
08:00 11:15 15:00

STARTING TIME OF PEAK HOUR
NOTE: SEE ATTACHED SKETCH FOR LAYOUT OF STATION

PREPARED BY TRAFFTRANS (PTY) LTD

SUMMARY OF TRAFFIC COUNTS

STATION: M4
 LOCATION: N/S
 E/W

R389
 R389

LAT: 31° 11' 12.2" S DATE: 10/01/2018
 LONG: 24° 53' 49.3" E Wednesday

MOVEMENT FROM NO		AM PEAK HOUR						PM PEAK HOUR						
		LIGHT VOL	TAXI VOL	BUS VOL	HEAVY VOL	TOTAL VOL	PHF	LIGHT VOL	TAXI VOL	BUS VOL	HEAVY VOL	TOTAL VOL	PHF	
NORTH	1 R							3					3	0.38
	2 T						n.a.							
	3 L													
EAST	4 R	1				1		1					1	0.25
	5 T	2				2	0.38							
	6 L													
SOUTH	7 R													n.a.
	8 T						n.a.							
	9 L													
WEST	10 R													0.50
	11 T						n.a.	2				2		
	12 L							2				2		
TOTAL		3				3	0.38	8				8	0.67	
VEH SPLIT		100%				100%		100%				100%		
		PERCENTAGE OF: 12H					7.0%	PERCENTAGE OF: 12H					18.6%	

MOVEMENT FROM NO		MIDDAY PEAK HOUR						12 HOUR COUNT					
		LIGHT VOL	TAXI VOL	BUS VOL	HEAVY VOL	TOTAL VOL	PHF	LIGHT VOL	TAXI VOL	BUS VOL	HEAVY VOL	TOTAL VOL	
NORTH	1 R	1				1		6				6	n.a.
	2 T												
	3 L							3				3	
EAST	4 R							3				3	0.38
	5 T	2			1	3	0.38	10			1	11	
	6 L												
SOUTH	7 R												n.a.
	8 T												
	9 L												
WEST	10 R												0.75
	11 T	2				2	0.75	11				11	
	12 L	4				4		9				9	
TOTAL		9			1	10	0.63	42			1	43	
VEH SPLIT		90%			10%	100%		98%			2%	100%	
		PERCENTAGE OF: 12H					23.3%						

AM MID PM
 07:30 09:00 16:15

NOTE: SEE ATTACHED SKETCH FOR LAYOUT OF STATION

PREPARED BY TRAFFTRANS (PTY) LTD

Appendix B



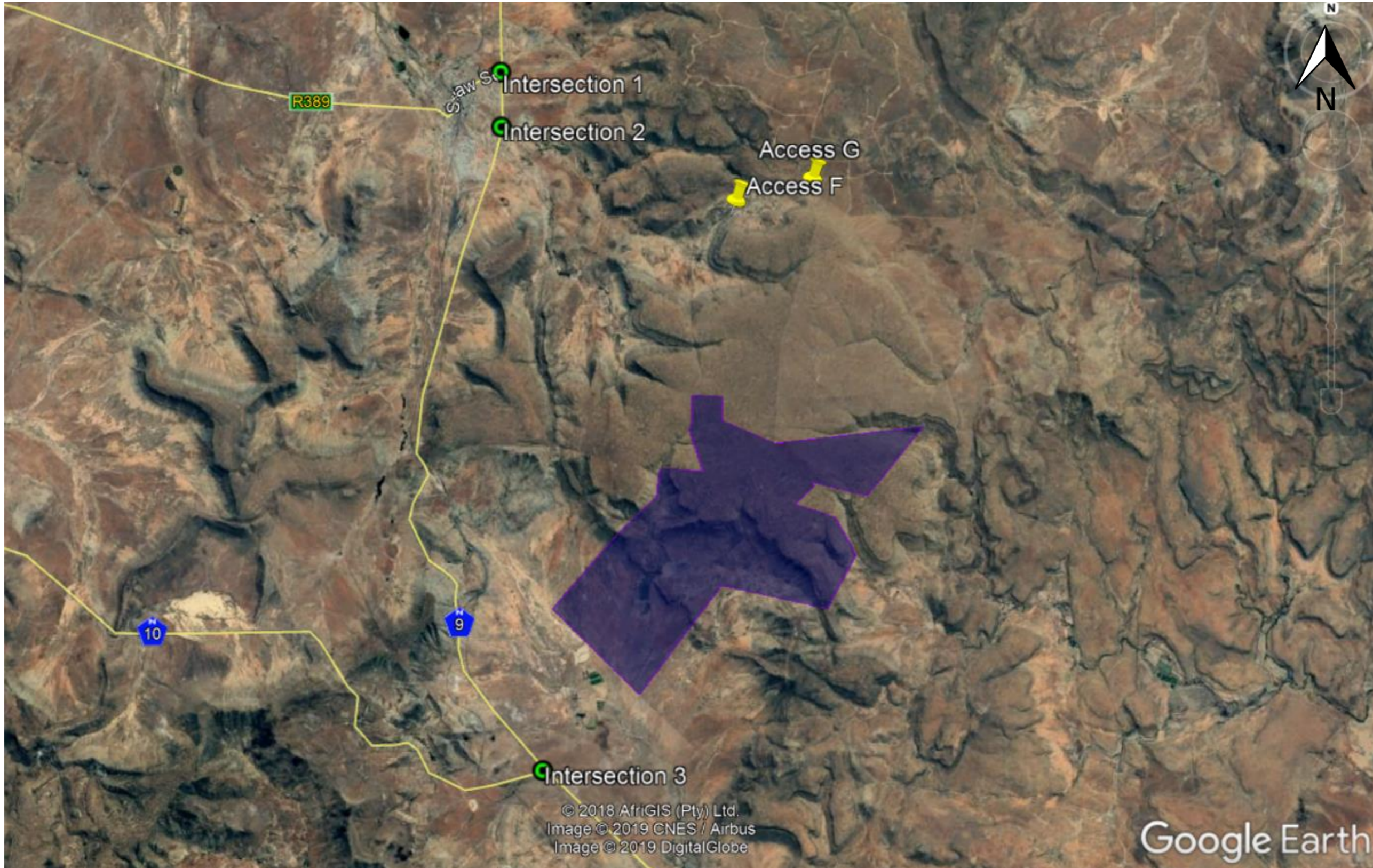

LOCALITY MAP

Access Points from N9 and other roads



Intersection 1

on N9

		
<p>Left Approach</p>	<p>Access Intersection</p>	<p>Right Approach</p>
<p>No Sight distance issues – sight extends for at least 500m</p>		<p>No Sight distance issues – sight extends for at least 500m</p>
		

Intersection 2

From N9 onto "Oorlogspoor"

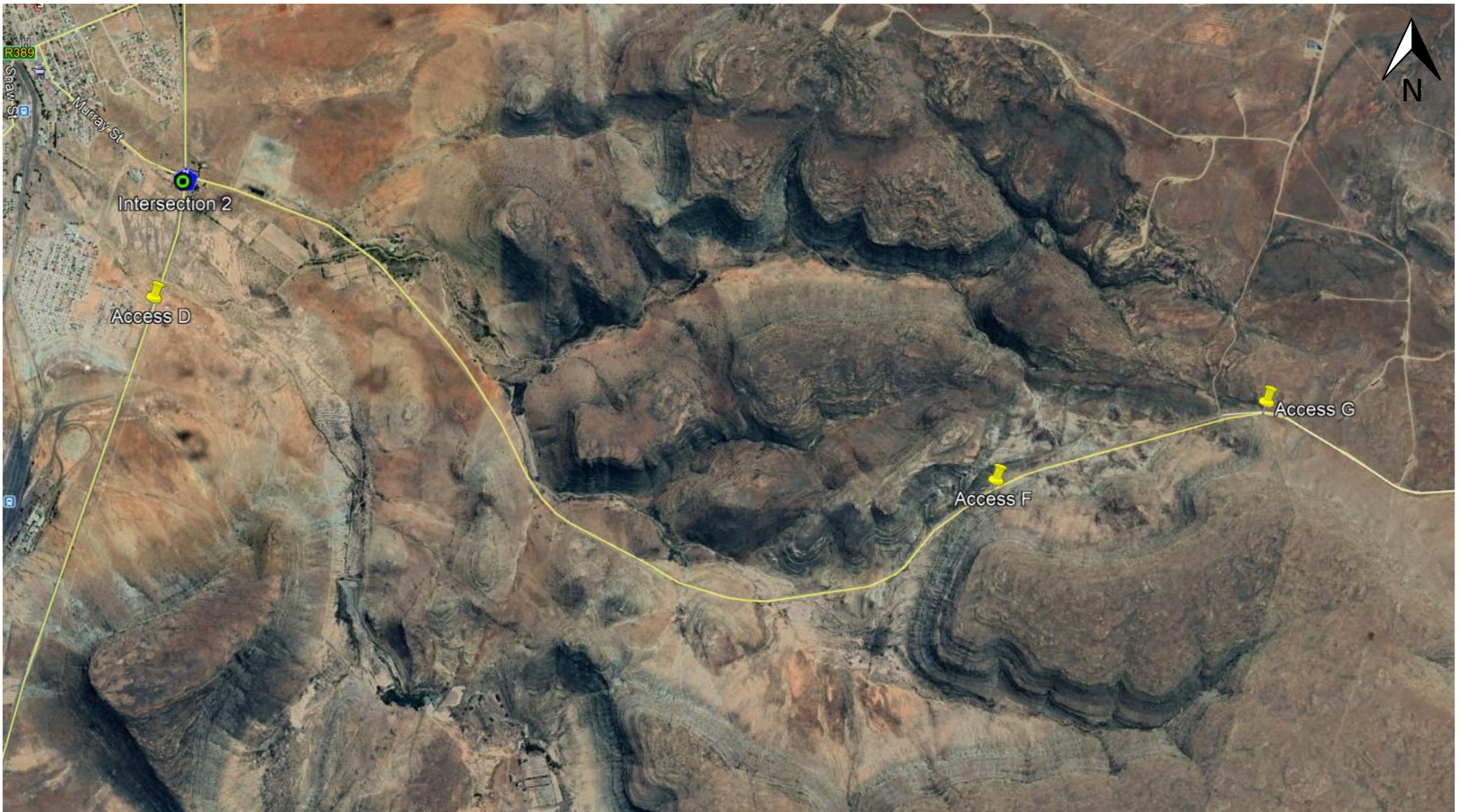





Intersection 2 on N9

		
Left Approach	Access Intersection	Right Approach
No Sight distance issues – sight extends for at least 500m		No Sight distance issues – sight extends for at least 500m

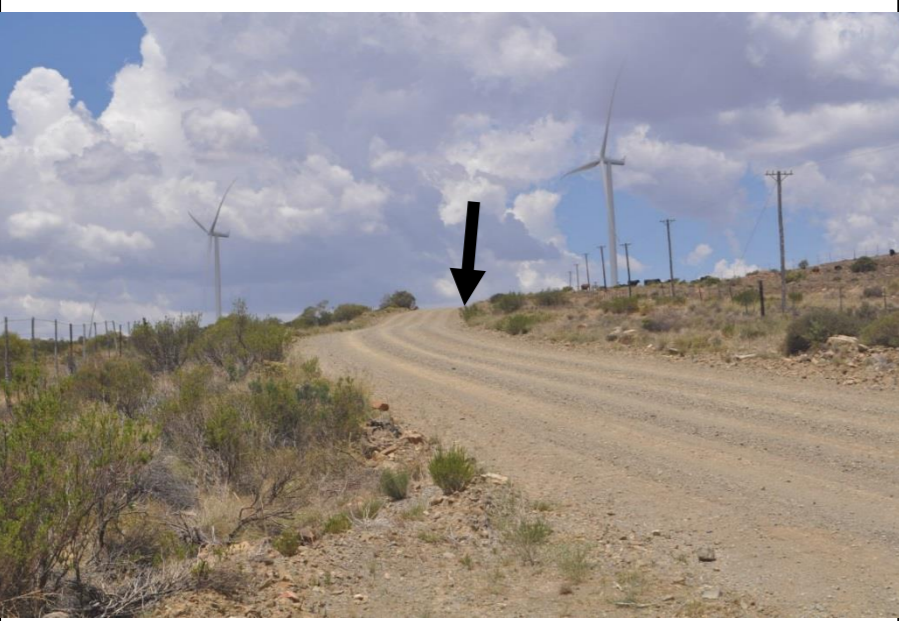

ACCESS G

		
<p align="center">Left Approach</p>	<p align="center">Access Intersection</p>	<p align="center">Right Approach</p>
<p align="center">At 247m sight disappears over crest curve</p>		<p align="center">Slight tree / bush obstruction at 315m</p>
		

ACCESS F

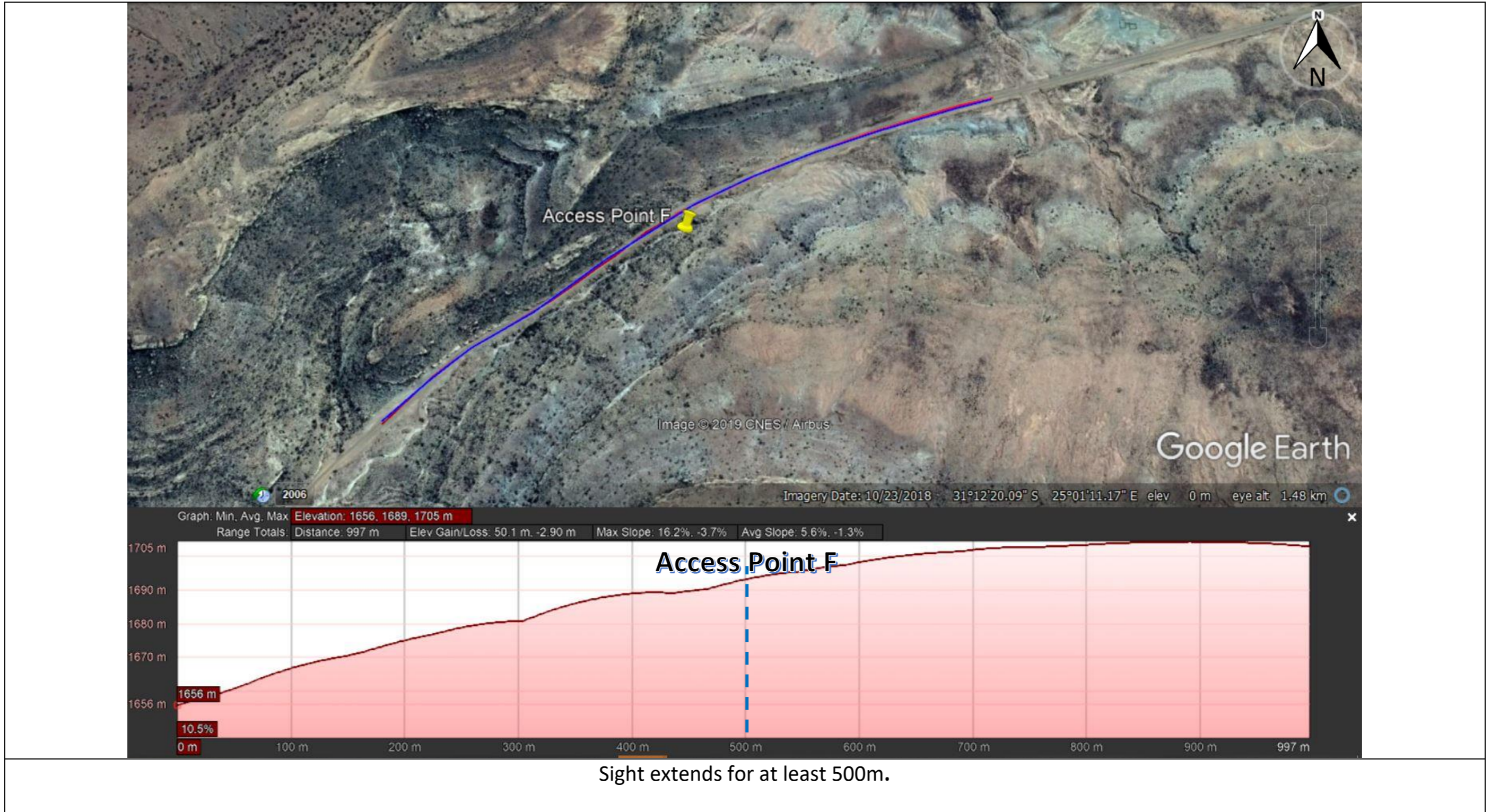

Appendix C

Appendix C: Regression Analysis Example

In statistics, linear regression is a linear approach for modelling the relationship between a scalar dependent variable y and one or more explanatory variables (or independent variables) denoted X . Our goal was to predict, forecast, and error reduction between the historical traffic volumes of permanent station 1477 from which is located approximately 40km from the WEF site. Using Regression Analysis, the correlation equations between two data sets (two months) was determined and thereafter applied to the new traffic counts. For example, the normalising of intersection 1 traffic volumes was as follows.

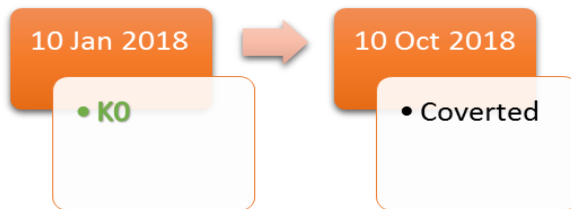

KO Factor
applied

Time	11 January 2017	11 October 2017	Peak Hour SUM	Peak Hour AVG	$y = 0.739x + 5.068$
01:00:00	3	4	7	4	7
02:00:00	7	2	9	5	10
03:00:00	6	5	11	6	10
04:00:00	4	4	8	4	8
05:00:00	3	8	11	6	7
06:00:00	13	10	23	12	15
07:00:00	23	14	37	19	22
08:00:00	29	17	46	23	26
09:00:00	28	19	47	24	26
10:00:00	31	23	54	27	28
11:00:00	24	23	47	24	23
12:00:00	32	23	55	28	29
13:00:00	31	28	59	30	28
14:00:00	21	32	53	27	21
15:00:00	16	32	48	24	17
16:00:00	37	41	78	39	32
17:00:00	21	31	52	26	21
18:00:00	25	30	55	28	24
19:00:00	28	18	46	23	26
20:00:00	11	29	40	20	13
21:00:00	26	25	51	26	24
22:00:00	8	12	20	10	11
23:00:00	10	14	24	12	12
24:00:00	6	5	11	6	10

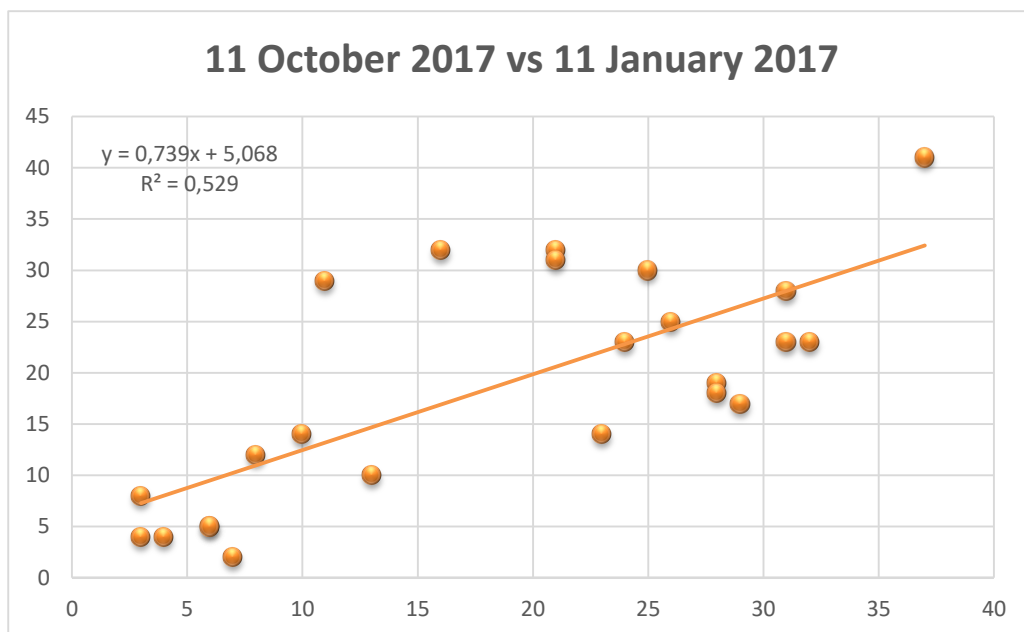

Resulting the following 2018 traffic volumes.

Intersection 1		AM Peak Hour		08:00-09:00	
Movement (approach)			Jan-18	Oct-18	
From	No.		traffic	Y = 0.739x + 5.068	
North	1	R	2	7	
	2	T	31	28	
	3	L	0	5	
East	4	R	0	5	
	5	T	0	5	
	6	L	0	5	
South	7	R	0	5	
	8	T	75	60	
	9	L	2	7	
West	10	R	6	10	
	11	T	1	6	
	12	L	2	7	
			119	149	

To be consistent, all traffic volumes were normalised with is method. For example, the normalising of intersection 2733 traffic volumes was as follows.

Appendix D

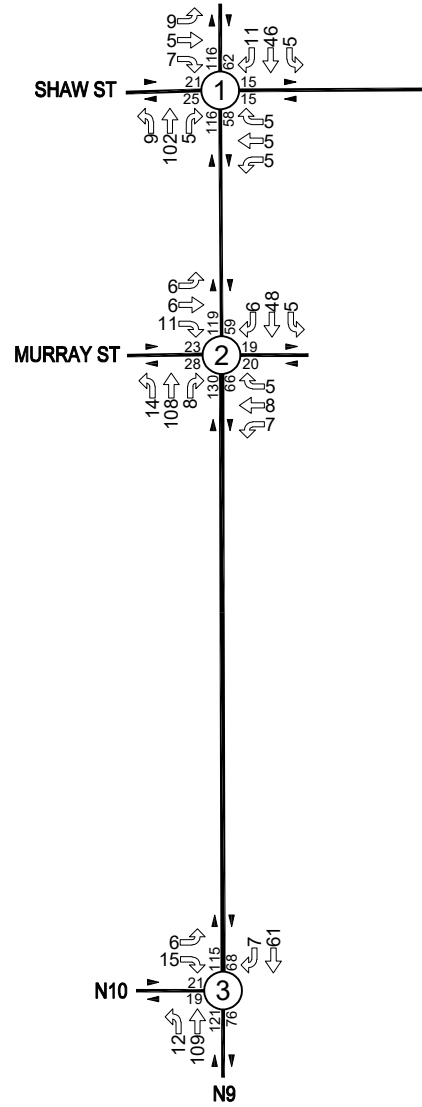
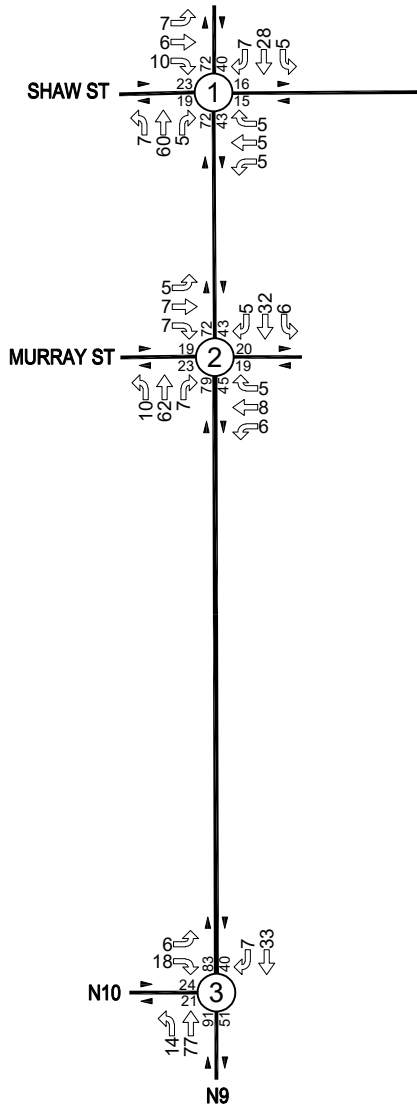

WEEKDAY AM PEAK HOUR (08H00 - 09H00)

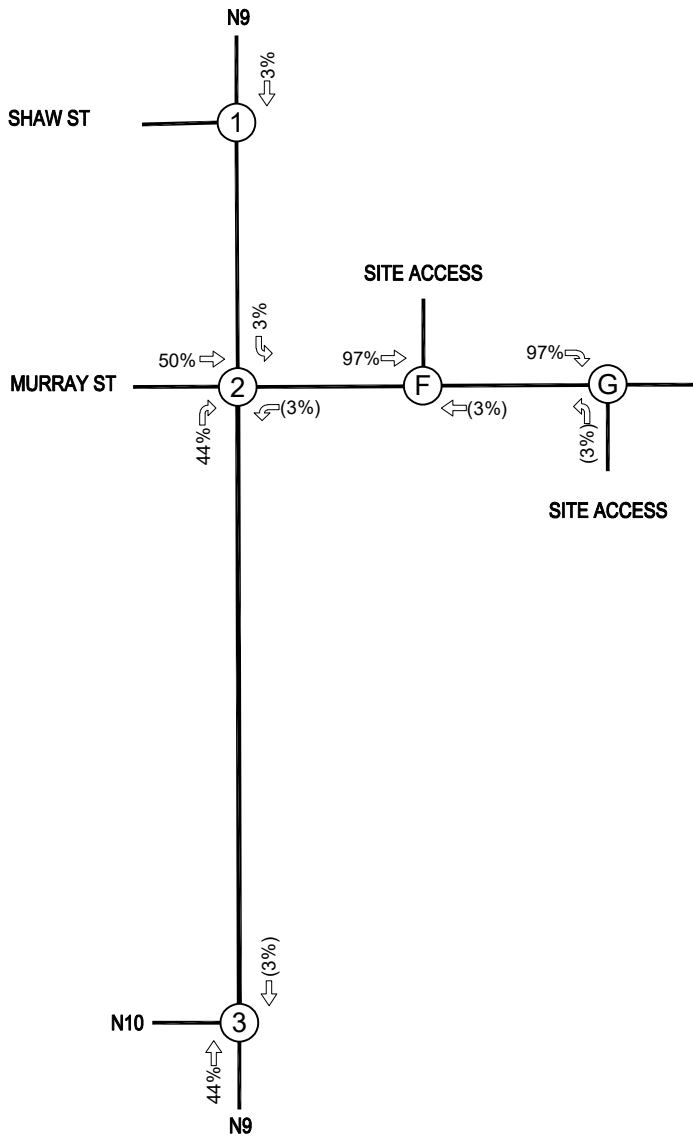

WEEKDAY PM PEAK HOUR (15H00 - 16H00)

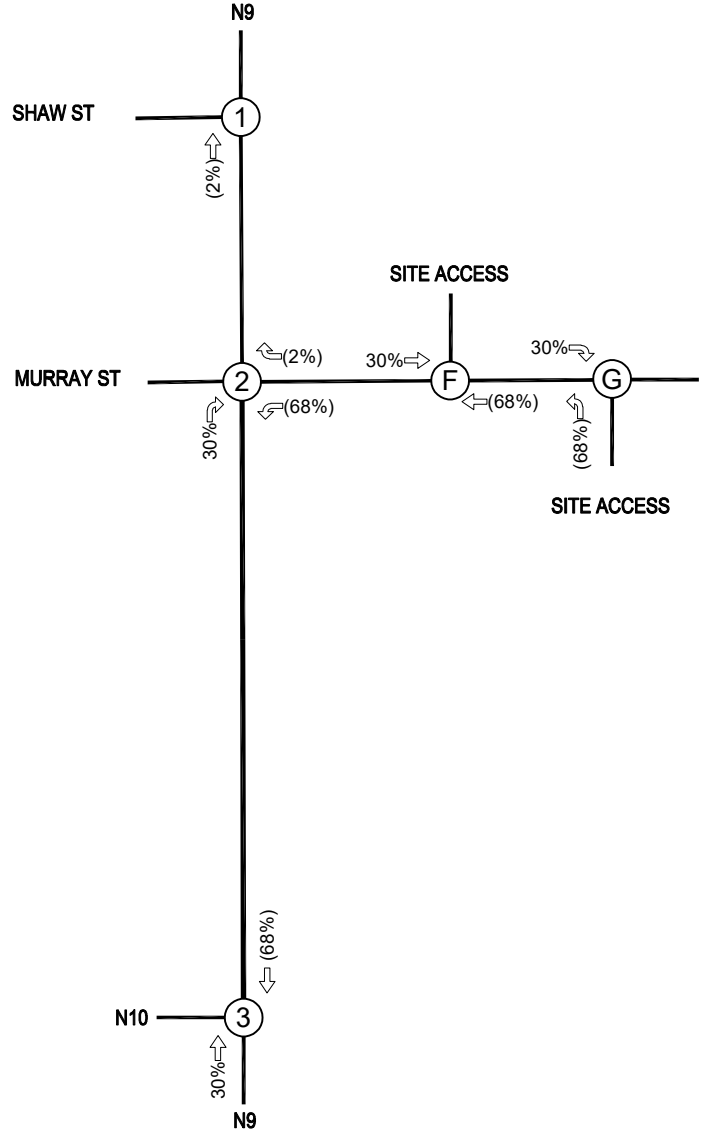

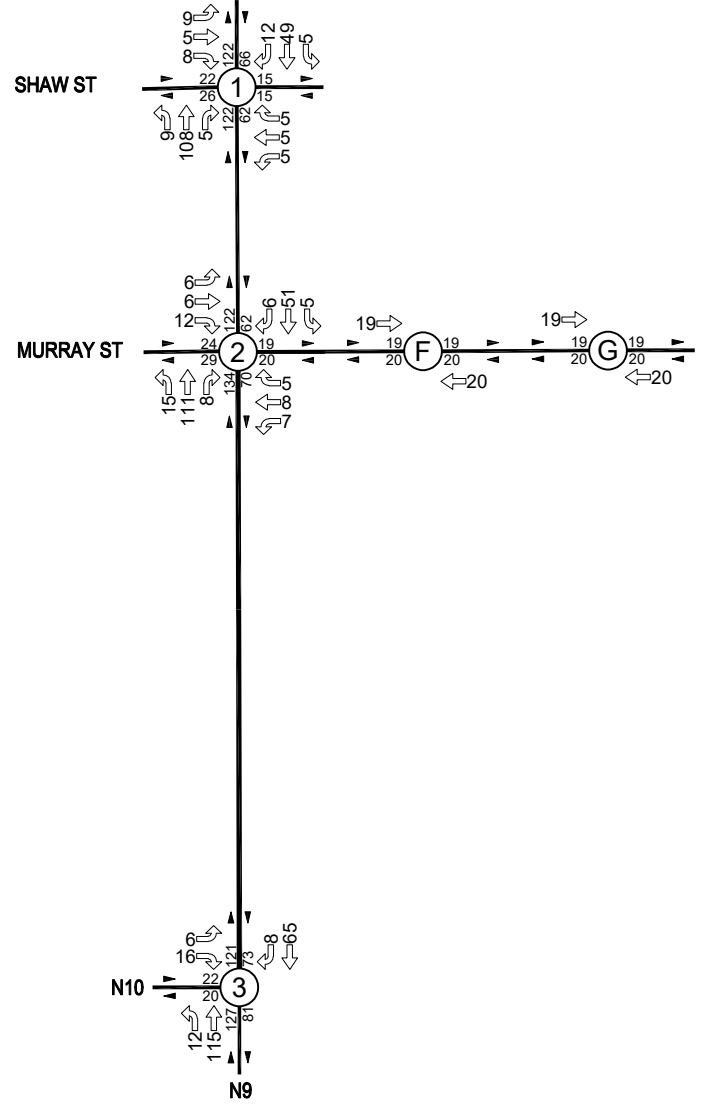
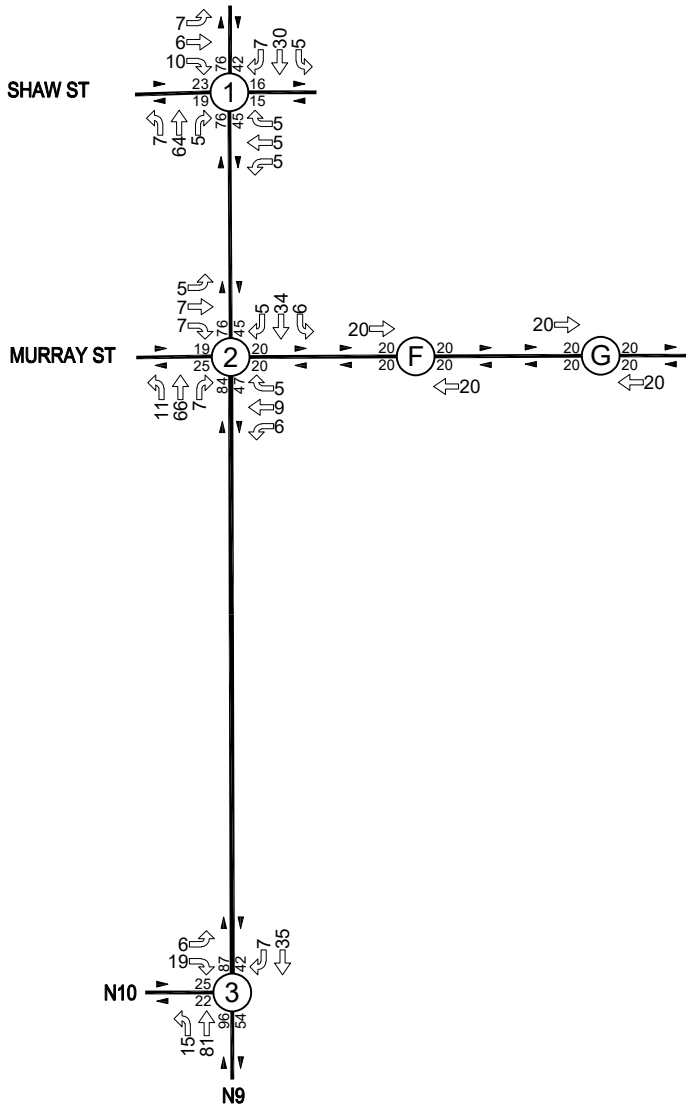

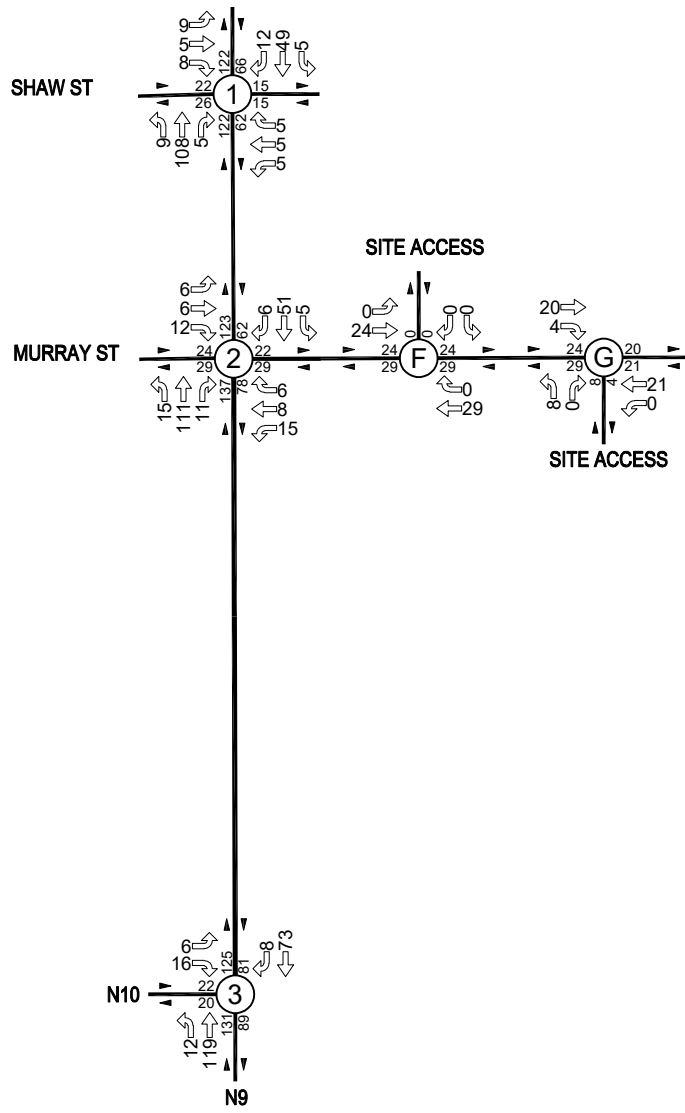
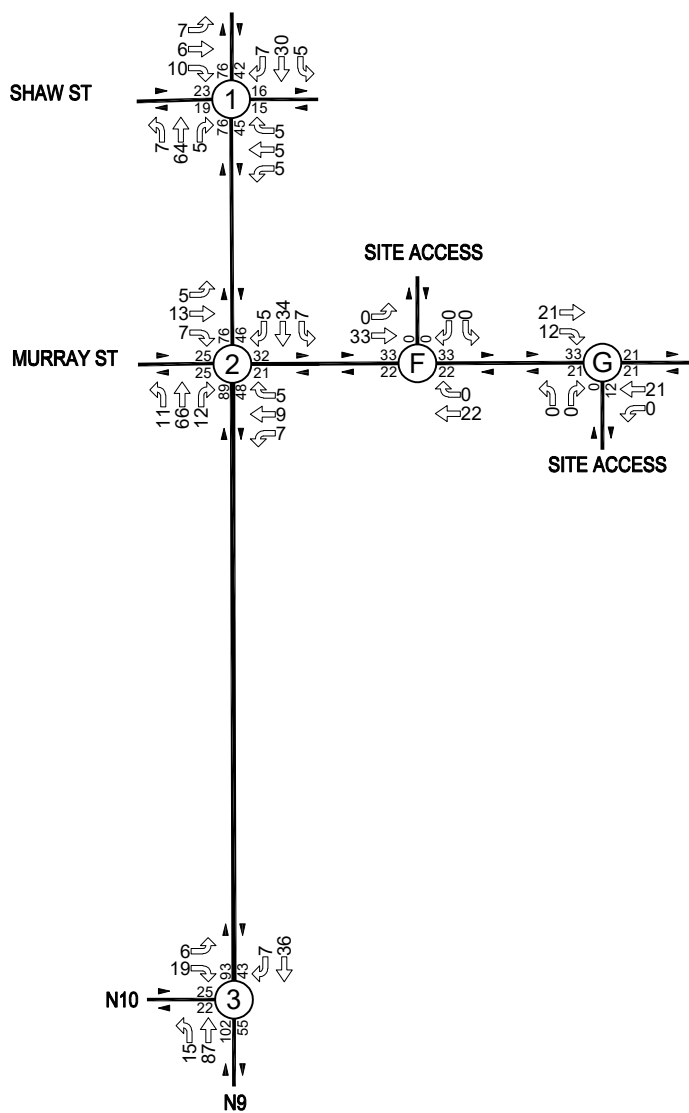

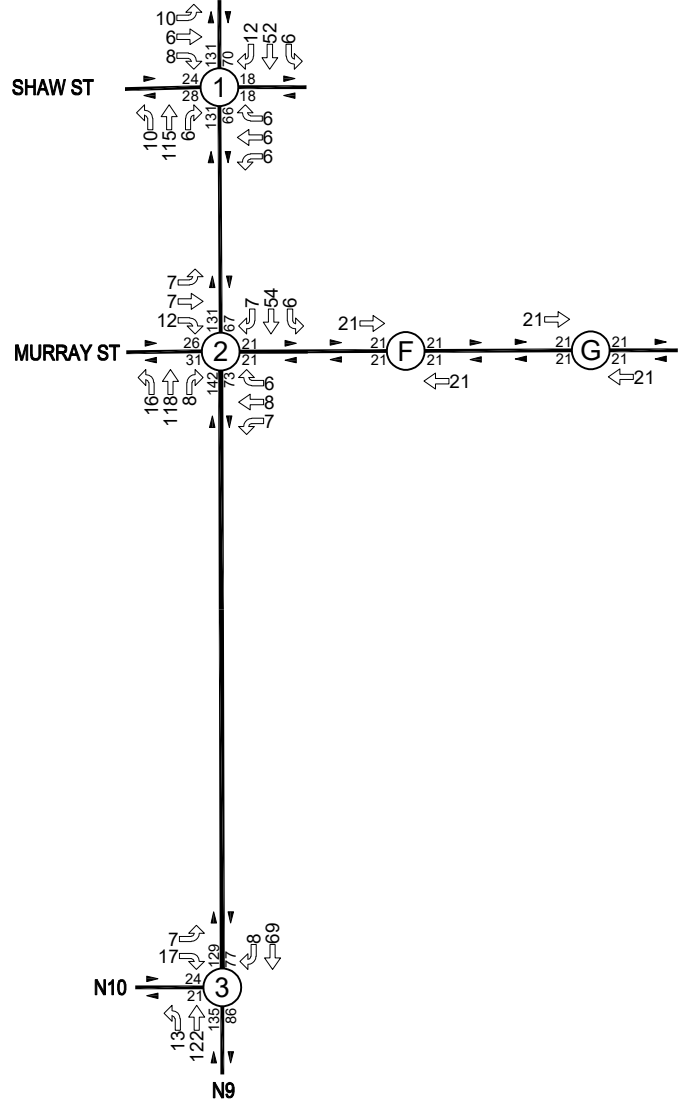
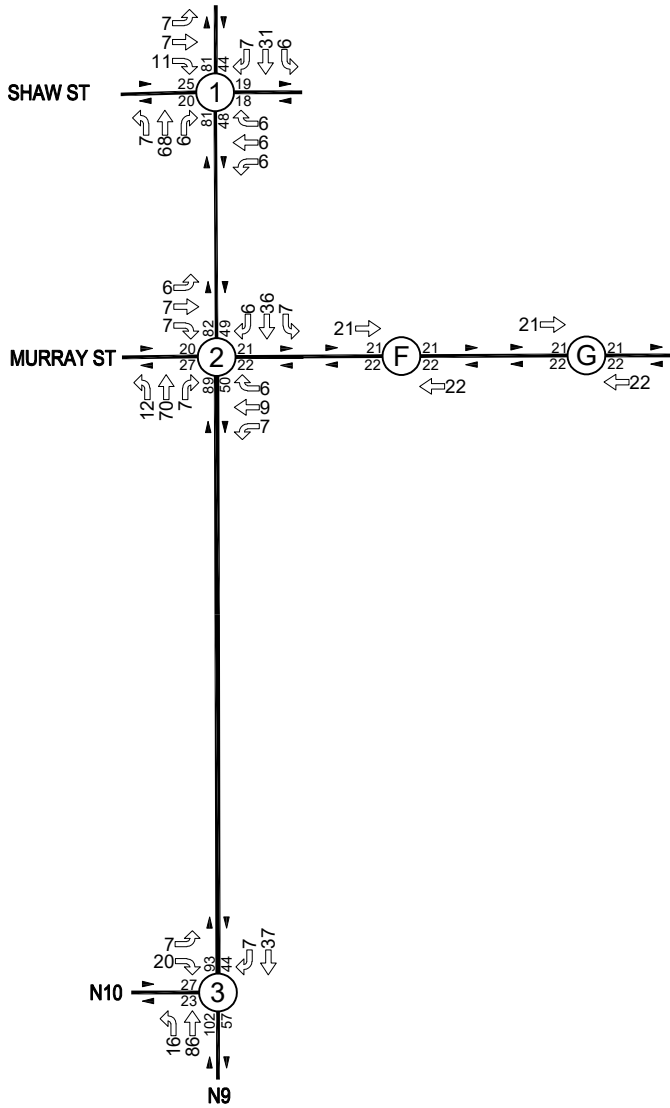

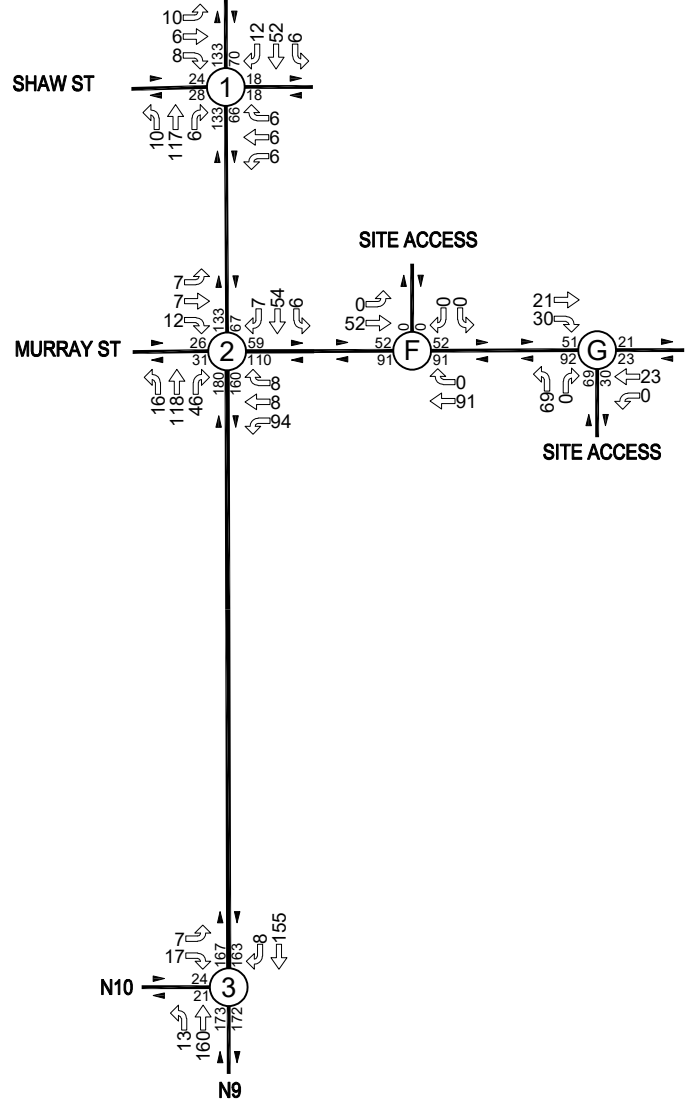
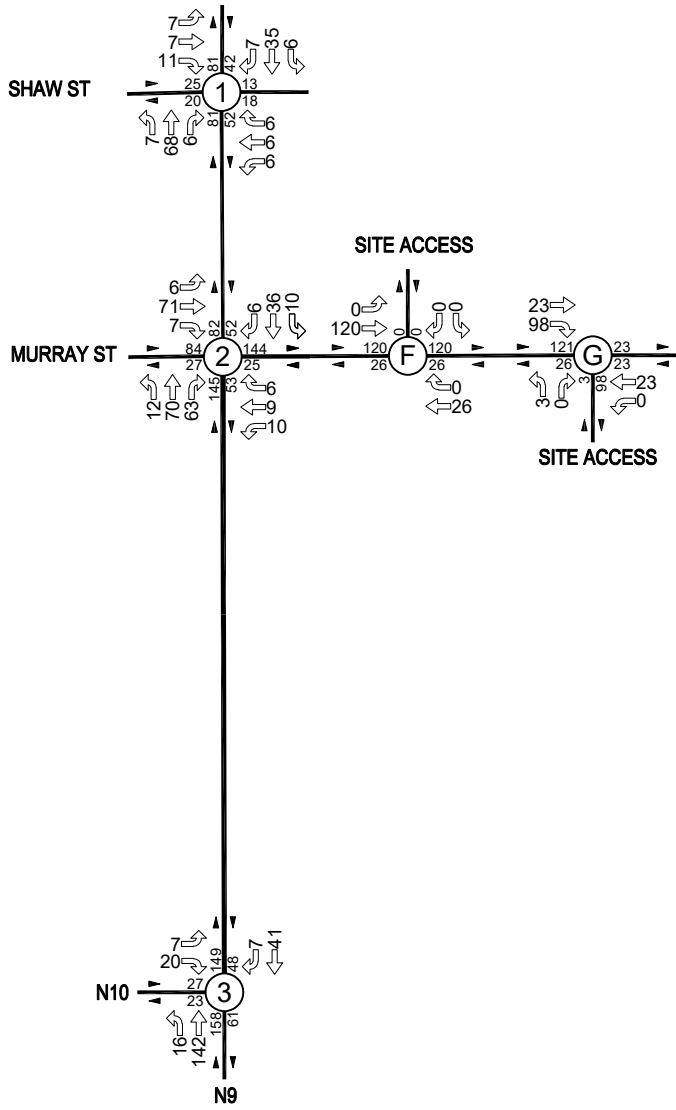

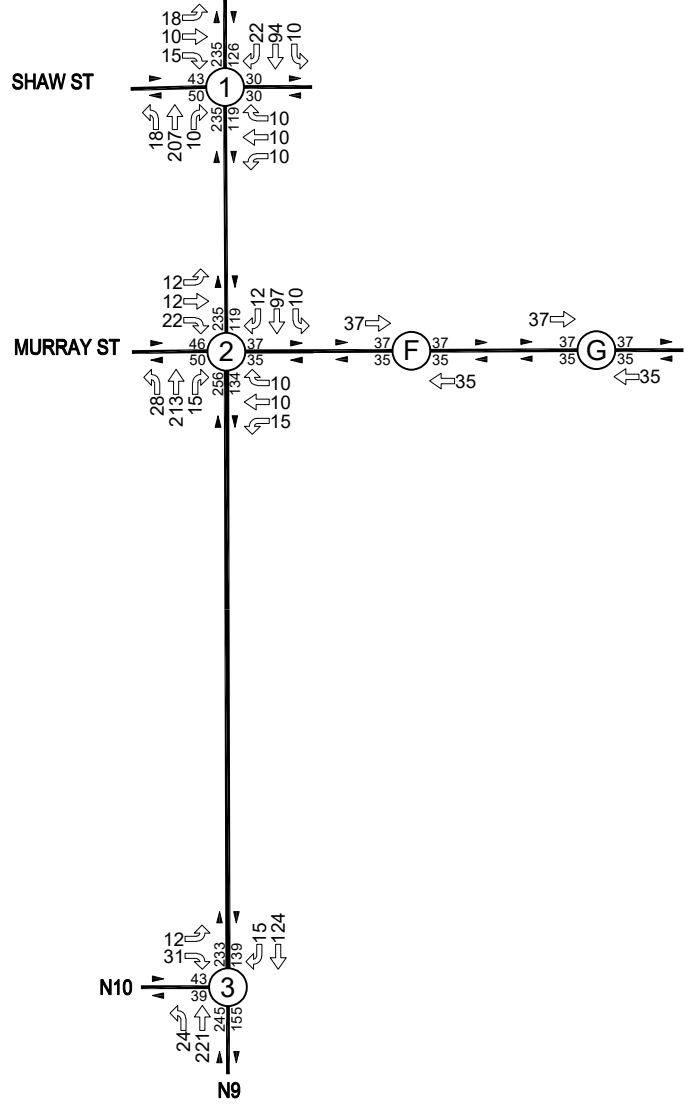
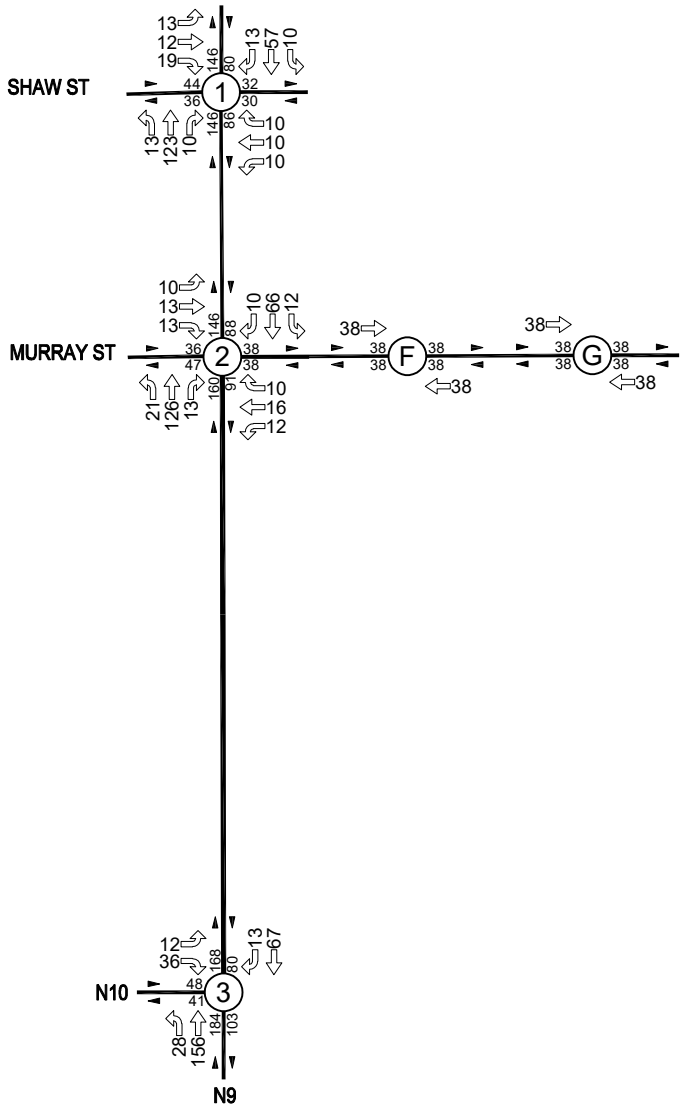

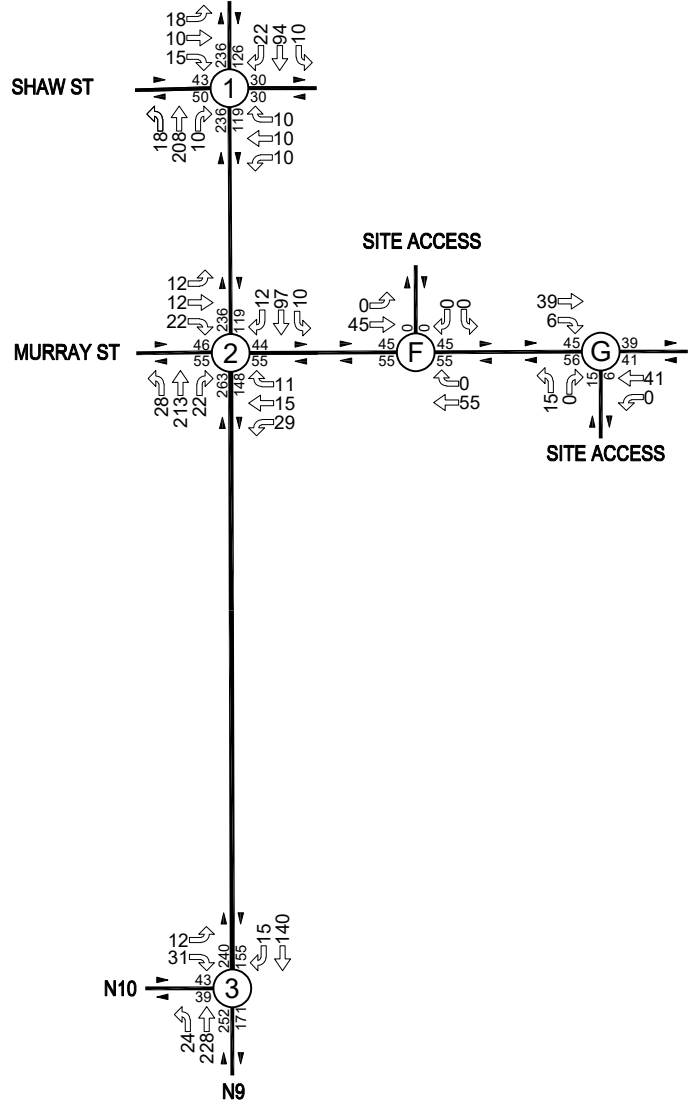
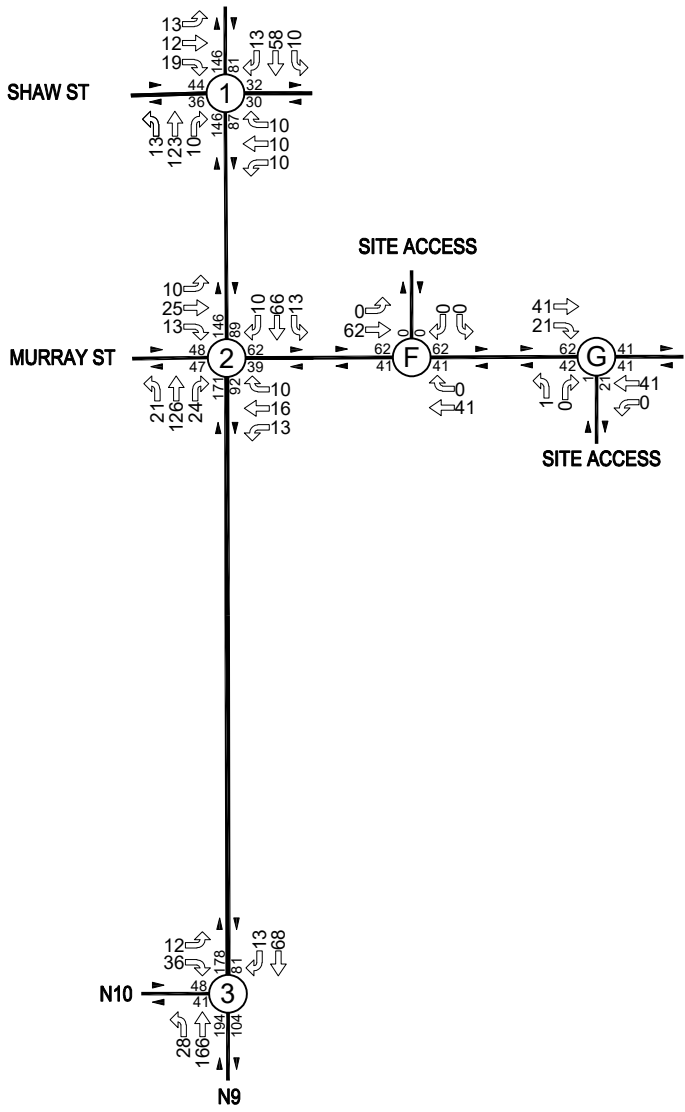

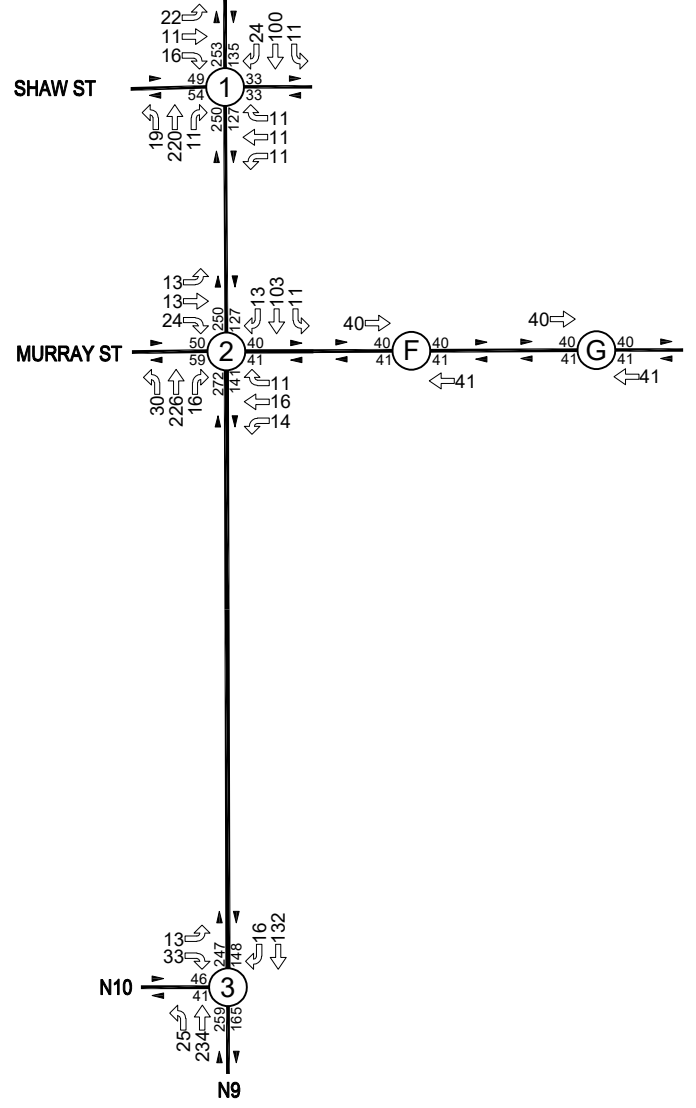
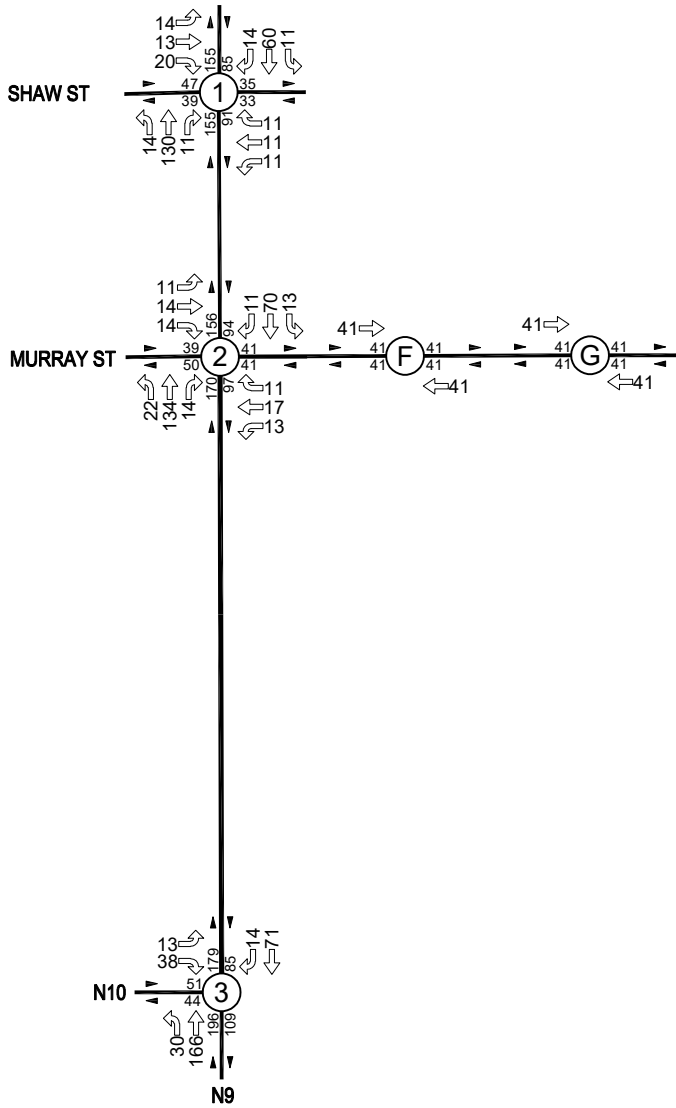

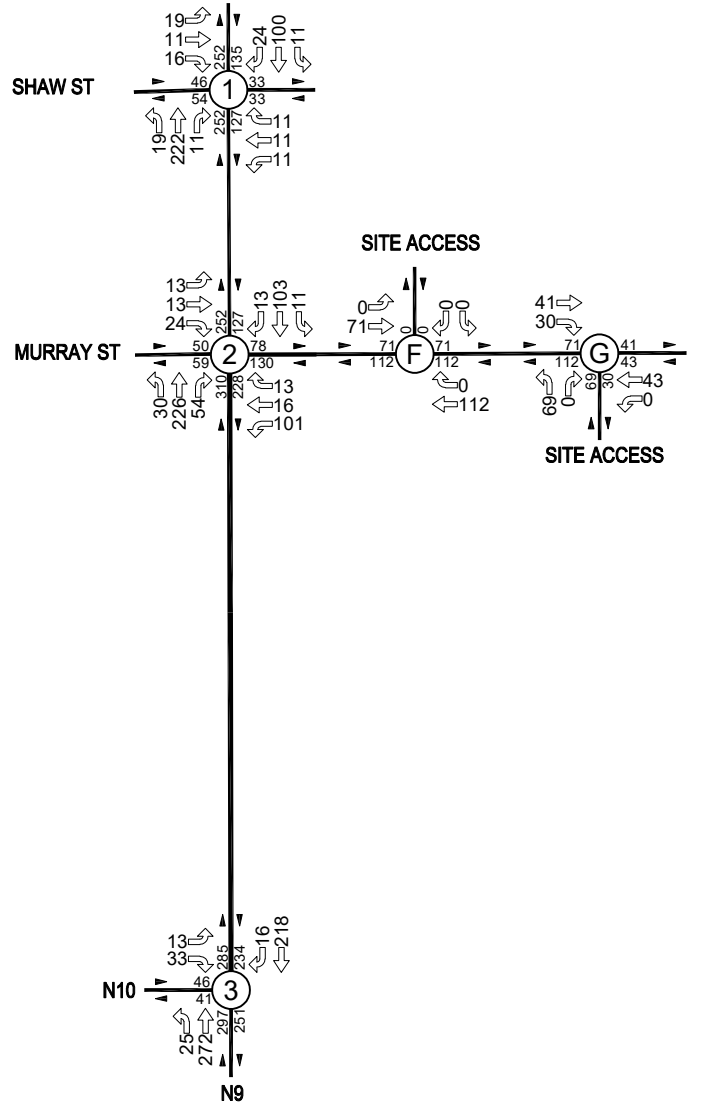
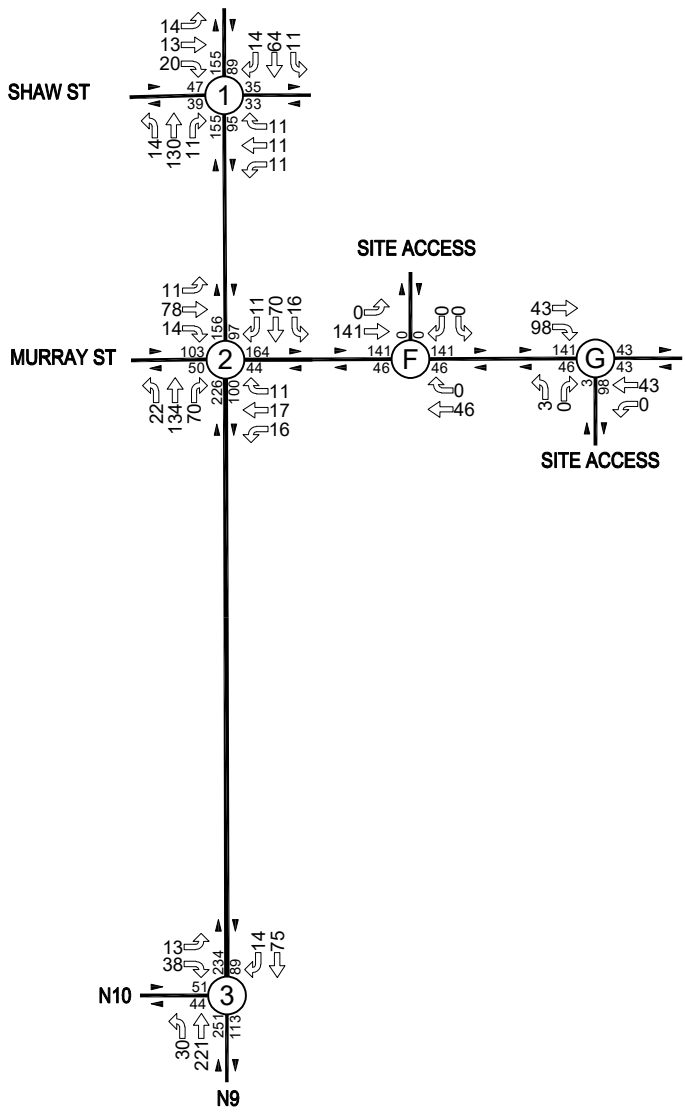



Gerna Van Jaarsveld

Professional Transport Planner

Professional Overview

I am a transport planner with 23 years post-graduate experience. I studied Town and Regional Planning at the University of Pretoria and graduated in 1996. Following my graduation, the South African Institute for Civil Engineering (SAICE) awarded me with a bursary towards my full-time study for a Master's Degree in Transport Planning at the Faculty of Civil Engineering at the University of Pretoria, which I completed in 1998. I am registered as a professional planner with the South African Council for Planners (SACPLAN) – registration number A/2406/2016.

I have gained work experience in South Africa and abroad in both the private and public sector. My private sector employers included Aurecon, WS Atkins, Arup and Hatch Goba. My public-sector employers included the Town Council of Centurion and the Dublin Transport Office. In 2017 I joined SMEC in their Johannesburg office.

I am currently Function Manager for Planning and Traffic Engineering. Some of the projects for which I have been responsible, or where I've had a major involvement, over the past 5 years include the Gauteng Freeway Improvement Project's (GFIP) toll model, other projects for toll concessionaires for example the Bakwena Platinum Corridor Concessionaire's toll model, the Maputo Bypass study for TRAC and the Lusaka to Ndola toll study for Group 5, transport master plans and models for example for large scale precinct development applications in Kwa-Zulu Natal and Mossel Bay, the Johannesburg Road's Agency's 10 year roads master plan and implementation plan, the Jabulani Transport Masterplan (Johannesburg), the Patterson Park Masterplan (Johannesburg), the M1, M2 and M70 Saturn meso-scope transport model and masterplan for the Johannesburg Roads Agency, the Kigali City Transport Masterplan Review (Rwanda), modelling of public transport options for the City of Tshwane's Integrated Rapid Transport Network (IRPTN) using their multi-modal EMME model, decongestion study for the Maseru Bridge Border Post between South Africa and Lesotho, the development of a guideline document carrying out Transport Assessments for the City of Johannesburg, traffic studies for City of Tshwane, the City of Johannesburg's North-East Quadrant Data Collection for minibus-taxi compensation and Gautrain Management Agency's transport planning and feasibility studies through the application of their multi-modal EMME model, the Comprehensive Integrated Transport Plan (CITP) for Lephalale Local Municipality (South Africa), the development of a Parking Policy for City of Johannesburg,

In conclusion, my main field of expertise is Transport Planning, Transport Modelling and Traffic Engineering. I have conducted various Traffic Impact Studies and Transport Planning Studies that varied in scale and size. The focus of my career has to a large extent been on Transport Modelling projects of various scales, using different transport modelling software, of which I am most proficient in SATURN and to a lesser extent EMME, and currently expanding my field of expertise to include PTV Visum. I also have a strong focus on research-type projects and project management.

Personal Info

- ID Nr.: 7405250035085
- Country of Birth: South Africa
- Nationality: South African
- Date joined the Firm: 2017

Years of Industry Experience

21 Years

Countries of Experience

- South Africa
- Republic of Ireland
- United Kingdom

Qualifications and Memberships

- B (TRP) (1996)
- MSc (1998)
- Professional Planner (Pr Pln (SA) A/2406/2016)

Key Skills and Competencies

- Project Management
- Transport Planning
- Transport Modelling
- Demand Modelling
- Simulation Modelling
- Integrated Transport Master Planning
- Non-Motorised Transport Planning
- Toll Feasibility Studies
- Traffic Impact Studies
- Traffic Engineering
- Research

Relevant Project Experience

Herewith-additional information on most relevant projects over recent years (2009 – 2019):

Lephalale Comprehensive Integrated Transport Plan (CITP), | +/- R1 300 000

Date: 2019

Client: Department of Transport

Client Contact Details: [Julius Tefo, Project Manager; Ph (0) 82 413 4535]

Description: A Comprehensive Integrated Transport Plan (CITP) is a statutory document required by the National Land Transport Act No. 5 of 2009 (NLTA). The CITP was prepared according to the minimum requirements for the preparation of integrated transport plans, published in the Government Gazette (No. 40174) in 2016. ITPs are used as tools by planning authorities to provide, plan for, develop and manage all modes of transport within the area of jurisdiction. This CITP covers the area within the boundaries of the Lephalale Local Municipality in the Limpopo Province of South Africa. This CITP was prepared for the period 2020 – 2025.

Role: Project Director

Responsibilities: Gerna was the project director and responsible for the technical review as well as managing client relationships.

North-East Quadrant BRT Minibus-Taxi Compensation, Johannesburg, | +/- R9 500 000

Date: 2019

Client: City of Johannesburg

Client Contact Details: [Gugu Mbambo, Project Manager; Ph (0) 82 301 6826]

Description: This Project aimed to describe the current public (minibus-taxi and bus services) and private transport services and utilisation within the study area through the collection, compilation and analysis of relevant demand, supply and utilization data, which was collected through an array of surveys. Additionally, data was collated from various audited institutions and organisations that informed the direct and indirect operating costs. The fare revenue of informal minibus-taxi public transport services was determined to provide reliable estimates of the profitability of the services. The data was used to verify data provided by the minibus-taxi and bus industry and was utilised in the negotiations to compensate service providers upon the implementation of Bus Rapid Transit (BRT) services.

Role: Project Director

Responsibilities: Gerna was the project director and responsible for the technical review as well as managing client relationships.

Development of a Parking Policy, Johannesburg, | +/- R 270 000

Date: 2018

Client: City of Johannesburg

Client Contact Details: [Nobuntu Ciko Duze, Project Manager; Ph (0) 84 588 3508]

Description: I was responsible for investigating the status quo of parking about existing policies, strategies and plans. This entailed two tasks namely to conduct a desktop study of existing studies, policies, strategies; and to conduct interviews on existing strategies with representatives from the responsible units at and other core stakeholders. The project also presented a valuable opportunity to work alongside the international expert, Paul Barter, to draft a problem statement for the ultimate "Parking Policy/Framework/Strategy" for the City.

Role: Project Director

Responsibilities: Gerna was the project director and responsible for the technical review as well as managing client relationships.

Gautrain Scenario Fare Testing, Johannesburg, | +/- R2 600 000

Date: 2018

Client: Gautrain Management Agency

Client Contact Details: [Victor Shange, Project Manager; Ph (0) 60 995 3059]

Description: A multi-modal EMME model was developed in 2014 for the Gauteng Province to test the feasibility of the Gautrain Rapid Rail Integrated Network (GRRIN). For the Scenario Fare Testing project, this existing model was applied to test the impact of different fare structures on the expected patronage and revenue of the Gautrain, and also the impact on the required infrastructure and operational costs.

Role: Project Director

Responsibilities: Gerna was the project director and responsible for the technical review as well as managing client relationships.

Kigali Transport Master Plan Review and Update, Rwanda, | +/- R1 300 000

Date: 2019

Client: City of Kigali

Client Contact Details: [Enrico Morriello, Project Manager; Ph +250 786 700 257]

Description: A multi-modal PTV Visum model was developed in 2013 for the City of Kigali to develop the transport master plan for the City. The 2013 model was not calibrated to baseline data and simply forecasted the envisioned demand and assumed a mode split between private and public transport. For the review and update of the masterplan, this Visum model was updated by calibrating the private transport component to observed baseline data (household travel survey data) and developing a spreadsheet based public transport model based on observed baseline data.

Role: Project Director

Responsibilities: Gerna was the project director and responsible for the technical review as well as managing client relationships.

M1, M2, M70 Road Masterplan and Simulation Model, Johannesburg, | +/- R 3 700 000

Date: 2017

Client: Johannesburg Roads Agency

Client Contact Details: [Alan Robinson; Project Manager; Ph (0) 62 519 0397]

Description: The development of a SATURN simulation model to test various proposed road infrastructure improvements and to determine the demand that has to be accommodated on the network. The process involved interaction with the City of Johannesburg's multi-modal demand model. The forecast demand flows were extracted from the SATURN model and used to develop the road master plan and provided to the design teams to inform the detailed geometric designs and micro-simulation where relevant.

Role: Project Manager

Responsibilities: Gerna was the project manager and responsible for the simulation model development, forecast modelling and the transport master plan reporting as well as managing client relationships.

EN 4 Maputo Bypass Toll Road Feasibility Study, Johannesburg, | +/- R500 000

Date: 2016

Client: TRAC / ANE

Client Contact Details: [Alan Robinson; Project Manager; Ph (0) 62 519 0397]

Description: When opened to traffic, the Maputo Bypass will provide an alternative route for traffic travelling between the EN4 in the west and the EN1 and the eastern and northern coastal areas of Maputo in the east. As a consequence of the above, there is likely to be an impact on the revenue stream of the Maputo Toll Plaza due to the opening of the Maputo Bypass by ANE. The Maputo Toll Plaza and the EN4/EN2 is operated by Trans African Concessions (TRAC). ANE is proposing to toll the Maputo Bypass in order to mitigate against the potential impact on the revenue stream of the Maputo Toll Plaza. In addition, there is also the possibility of large scale land use development taking place around the location of the future Maputo Bypass and the interchange with the existing EN4. These land use developments may also

have an impact on the revenue stream of the Maputo Toll Plaza. The objective of the traffic study was to determine the compensation to be paid by ANE to TRAC for any losses incurred as a result of the traffic diversion from the Maputo Toll Plaza to the Maputo Bypass. In addition, the impact of the possible tolling of the Maputo Bypass on TRAC and the impact of land use developments in the vicinity of the EN4 and the Maputo Bypass on TRAC had to be taken into account. Traffic survey data was processed and a base year traffic model (SATURN) was developed. The project was put on hold due to internal differences between TRAC and ANE.

Role: Transport Modeller

Responsibilities: Gerna was the transport modeller that formed part of the team responsible for the development of the toll and revenue models.

Transport Assessment Guideline / Manual, Johannesburg, | +/- R1 000 000

Date: 2016

Client: City of Johannesburg

Client Contact Details: [Nobuntu Ciko; Project Manager; Ph (0) 84 3508]

Description: Develop a transport assessment manual in light of the fact that current traffic impact assessment guidelines do not address the impact and proposed mitigation measures on public transport or non-motorised transport adequately. The project involved research into international and local best practice. The document focuses on the methodologies to determine the required mitigation measures considering the vehicle road network, public transport services and non-motorised transport. All services must be accommodated within the road reserve. The aim is to enforce the requirements for applicants to address all modes in the transport assessment.

Role: Project Manager

Responsibilities: Gerna was the project manager and responsible for the research, stakeholder consultation and document development as well as client relationships.

City of Tshwane Integrated Rapid Public Transport Network (IRPTN), Johannesburg, | +/- R1 500 000

Date: 2014

Client: City of Tshwane

Client Contact Details: [Imelda Matlawe; Project Manager; (0) 12 358 7755]

Description: The team responsible for the IRPTN outlined a number of rail and BRT options that could possibly address future travel demand. The City's existing multi-modal EMME model was obtained and reviewed. Various rail and BRT options were developed and tested. The criteria to determine an optimised solution was established to be the scenario that carries the highest demand. Outputs from the various scenarios were presented. A multi-criteria analyses was developed in which the demand extracted from the model was only viewed as one of the criteria used to determine an optimised solution. A report was submitted that outlined the recommendations from the modelling / demand point of view.

Role: Project Manager

Responsibilities: Gerna was the project manager and responsible for the demand modelling, forecast modelling and the model output reporting as well as client relationships.

Jabulani Transport Masterplan, Johannesburg, | +/- R1 000 000

Date: 2016

Client: Johannesburg Development Agency (JDA)

Client Contact Details: [Nthangeni Mulovhedzi; Project Manager; Ph (011) 688 7800]

Description: Jabulani is a centrally located area in Soweto supported by the Inhlanzane rail station and existing BRT and taxi services. Most of the vacant land in the area is owned by a private developer. Recent transport planning has indicated the possibility of increased rail services, the extension of Gautrain to the area and additional BRT service to the area (although not confirmed). The JDA is supporting transit-oriented development (TOD) and is therefore working with the private developer to maximise the development potential of the area. Due to the proposed additional mixed

use development for the area, a transport master plan was requested by the City of Johannesburg. The aim of the plan was to focus specifically on non-motorised transport and public transport strategies. The plan was supported by non-motorised transport surveys and a multi-modal spreadsheet model. Various options were considered, specifically related to the location of a public transport interchange as well as the accommodation of hawkers in the area. The project was subsequently put on hold due to uncertainty with regard to the cycle lane policy and the future of BRT services to the area.

Role: Project Manager

Responsibilities: Gerna was the project manager and responsible for the option development, the development of the spreadsheet model, as well as client relationships.

JRA 10-year Road Master Plan, Johannesburg, | +/- R1 700 000

Date: 2015

Client: Johannesburg Roads Agency (JRA)

Client Contact Details: [Esther Schmidt; Project Manager; Ph (0) 82 374 6247]

Description: The JRA appointed a team to develop an infrastructure master plan and implementation plan to guide their infrastructure expenditure over the next 10 years (2015 -2025). Gerna was responsible for the road infrastructure component of the appointment. The project involved the prioritization of new roads, new bridges and new interchange projects. This included the review of current road planning for the Johannesburg area of jurisdiction, including provincial and national road planning and high level cost estimates for prioritized projects. In the absence of an analytical tool such as a transport model or a demographic database, the project involved the development of a Multi-Criteria Analysis (MCA) Tool. The MCA analyses defined various criteria grouped under the main objectives of mobility, accessibility and sustainability. The total number of possible new road projects exceeded 1000 proposed by various authorities throughout Johannesburg. A desktop study and visual assessment of the scale and number of these projects resulted in a sub-set of 315 of these being identified for further evaluation. The various projects were scored using the MCA tool. All projects were then prioritized based on their score. During the prioritization process, budget considerations were put in the background in order to form a view on the real needs of the city as opposed to only those needs that can be satisfied based on affordability. As a supplementary exercise, an assessment of the road network was carried out using the online Google Traffic tool to determine if the existing planning and policy address localized capacity problems and also if strategic travel demand patterns are adequately addressed by current planning. A number of gaps were identified and recommendations made.

Role: Project Manager

Responsibilities: Gerna was the project manager and responsible for the development of the transport master plan and the delivery of the final report.

Bus Depot Operations Optimisation, Johannesburg, | +/- R800 000

Date: 2015

Client: City of Tshwane

Client Contact Details: [Imelda Matlawe; Project Manager; (0) 12 358 7755]

Description: The client required advice in terms of the future location, size and function of supporting bus facilities such as bus depots, bus layovers and bus waiting areas. The aim was to achieve significant savings in terms of operational costs for the City of Tshwane through the optimization of the required facilities. Furthermore, the advice, based on empirical study, resulted in recommendations regarding the size of land required and the facilities to be provided which achieved significant savings in terms of capital expenditure for the City of Tshwane. As a first port of call, demand modelling information was obtained from the city's most up to date EMME demand model. This information served as an input into a bus operations optimization spreadsheet model. The output from the spreadsheet model was fed back into the EMME demand model for a second iteration. More realistic demand numbers were subsequently output from the second iteration of the EMME demand model for the envisaged short, medium and long term BRT roll-out plan. These numbers were finally used as an input into the bus operations optimization spreadsheet model for a second iteration. The output from the spreadsheet model was used to recommend a particular location, size and functionality for supporting bus facilities for the short, medium and long term. In addition, the final advice was supported by a land use due diligence exercise that involved consultation with town planning specialists.

Role: Project Manager

Responsibilities: Gerna was supported by a team of technical specialists and responsible for delivering the final recommendations to the client.

Gauteng Freeway Improvement Project (GFIP) Toll Feasibility Study, Johannesburg, | +/- R5 000 000

Date: 2010

Client: SANRAL

Client Contact Details: [Alan Robinson; Project Manager; Ph (0) 62 519 0397]

Description: The development of a SATURN buffer model to test various toll levels and to provide outputs for incorporation into the revenue model. The model consisted of 4 time periods and 6 user classes to take account of the different values of time. The development of the revenue model to annualise the predicted revenue also formed part of the scope of works.

Role: Transport Modeller

Responsibilities: Gerna was a transport modeller that formed part of the team responsible for the development of the transport model and the revenue model.

N1 / N4 Bakwena Platinum Toll Road Feasibility Study, Johannesburg, | +/- R2 000 000

Date: 2011

Client: Bakwena

Client Contact Details: [Liam Clarke; Project Manager; Ph (0) 11 519 0400]

Description: The application of the existing toll and revenue models to determine the predicted revenue following various scenarios, including bypasses, different fare levels, various capacity upgrades and different toll strategies / different collection points.

Role: Transport Modeller

Responsibilities: Gerna was a transport modeller that formed part of the team responsible for the application of the existing models.

N1 / N2 Winelands Toll Road Feasibility Study, Johannesburg, | +/- R2 000 000

Date: 2011

Client: SANRAL

Client Contact Details: [Alan Robinson; Project Manager; Ph (0) 62 519 0397]

Description: The development of a SATURN buffer model to test various toll levels and to provide outputs for incorporation into the revenue model. The outputs supported a bid submitted by the concessionaire to design, build and operate the toll roads in the Western Cape.

Role: Transport Modeller

Responsibilities: Gerna was a transport modeller that formed part of the team responsible for the development of the toll and revenue models.

Eastern Region Toll Road Feasibility Study, Johannesburg, | +/- R800 000

Date: 2012

Client: SANRAL

Client Contact Details: [Alan Robinson; Project Manager; Ph (0) 62 519 0397]

Description: SANRAL investigated the possibility of taking ownership of various regional roads in Limpopo, Mpumalanga and Kwa-Zulu Natal Provinces. As part of this investigation, the possibility of tolling these roads as a means to fund the

maintenance and upgrade of these roads was considered. The project involved the development of a SATURN buffer model to test various toll levels and to provide outputs for incorporation into the revenue model.

Role: Transport Modeller

Responsibilities: Gerna was a transport modeller that formed part of the team responsible for the development of the toll and revenue models.

Mossel Bay Transport Master Plan, Johannesburg, | +/- R800 000

Date: 2012

Client: Western Cape Province Transport Department

Client Contact Details: [Alan Robinson; Project Manager; Ph (0) 62 519 0397]

Description: The N2 and alternative R102 was experiencing increased congestion due to the recent expansion of Mossel Bay as well as the envisaged land use developments in the area. The provincial authority requested a transport road master plan to address the future demand. A Saturn simulation model was developed, supported by extensive traffic count surveys, journey time surveys and origin-destination surveys (using numberplate recognition).

Role: Transport Modeller

Responsibilities: Gerna was a transport modeller that formed part of the team responsible for the development of the simulation model and providing outputs to inform the development of the road master plan.

Inyaninga Transport Master Plan, Johannesburg, | +/- R500 000

Date: 2013

Client: Tongaat Hulett

Client Contact Details: [Rory Wilkinson; Project Manager; (0) 31 560 1900]

Description: Inyaninga is a greenfield area close to the King Shaka airport in Kwa-Zulu Natal accessible via the R102 which runs parallel to the N2. The developer proposed a mixed-use development and the Ethekwini Transport Authority required a transport master plan for the area to be developed. A SATURN simulation model was developed for the area based on traffic count surveys and journey time surveys. The master plan recommended some road upgrades as well as a new bridge construction.

Role: Project Manager

Responsibilities: Gerna was the project manager and responsible for the simulation model development, forecast modelling and the transport master plan reporting as well as client relationships.

Westgate Transport Master Plan, Johannesburg, | +/- R750 000

Date: 2012

Client: Johannesburg Development Agency (JDA)

Client Contact Details: [Joy Jacobs, Project Manager; Ph (011) 688 7800]

Description: Westgate is an area located near the M2/Selby Road off-ramp in Johannesburg. The JDA appointed an urban designer to implement their land use and urban environment vision, including non-motorised transport initiatives. The area is earmarked as a major public transport interchange, including BRT and taxi activity. The urban design proposals (including reduction of road space, e.g. pedestrianisation, the widening of sidewalks) as well as the provision of dedicated BRT lanes were simulated in SATURN with a view to best accommodate traffic given the reduced road space.

Role: Project Manager

Responsibilities: Gerna was the project manager and responsible for the simulation model development, forecast modelling and the transport master plan reporting as well as client relationships.

Patterson Park Transport Masterplan, Johannesburg, | +/- R500 000

Date: 2016

Client: Johannesburg Development Agency (JDA)

Client Contact Details: [Joy Jacobs, Project Manager; Ph (011) 688 7800]

Description: Paterson Park is a centrally located area, just east of Louis Botha Road in Johannesburg, with existing BRT services providing access to the area. The park is owned by the Johannesburg Property Company and was earmarked for residential densification in support of the transit-oriented principles applicable to this area. Due to the intensification of the land use proposed, a transport master plan was requested by the City of Johannesburg. The aim of the plan was to focus specifically on non-motorised transport and public transport strategies.

Role: Project Manager

Responsibilities: Gerna was the project manager and responsible for client relationships. She was supported by a team and acted in a review capacity.

Professional History

2017 to date	SMEC	Function Manager Planning and Traffic Engineering
2014-2017	MPA Consulting Engineers	Section Head Transport Planning
2009-2014	Goba / Hatch Goba Consulting Engineers	Transport Engineer
2003-2009	Dublin Transport Office	Senior Executive Transport Planner
2001-2003	Arup Consulting Engineers	Project Engineer
1998-2001	Africon Consulting Engineers	Transport Planner
1997-1998	Centre for Transport Development, University of Pretoria	Research Assistant
1993-1996	Town Council of Centurion	Research Student

Courses & Conferences attended

10 July 2019	1-Day SOUTH AFRICAN TRANSPORT CONFERENCE	SATC, Pretoria, South Africa
15 – 18 October 2018	EMME Demand Modelling course presented by Inro	Adam Harmon, Johannesburg, South Africa
10 – 12 April 2018	Introduction to Macro-Scopic Network Modelling with PTV Visum	Evan Roux (PTV), Pretoria, South Africa
9 - 13 March 2015	5-Day course on DISCRETE CHOICE MODELLING AND STATED CHOICE SURVEY DESIGN	Mark Zuidgeest (UCT), Stephane Hess (ITS, Leeds), Cape Town, South Africa
6 February 2014	Half-Day Conference TRANSPORT FORUM – FREIGHT AND TRANSPORT MODELLING	Prof. JW Joubert, UP and Mr. Cobus Roussouw, Imperial Logistics, Pretoria, South Africa
4 October 2011	1-Day training session BUSINESS COMMUNICATIONS (WRITTEN & SPOKEN)	Marlene Ward, Johannesburg, South Africa
20 September 2011	1-Day training session MANAGEMENT AND LEADERSHIP DEVELOPMENT	Marlene Ward, Johannesburg, South Africa
14 June 2011	1-Day training session THE BASICS OF PROJECT MANAGEMENT	SQDC Business School, Johannesburg, South Africa
10 May 2011	1-Day training session on COMMUNICATION AND RELATIONSHIP MANAGEMENT	Marlene Ward, Johannesburg, South Africa

8 July 2010	1-Day SOUTH AFRICAN TRANSPORT CONFERENCE	SATC, Pretoria, South Africa
8 July 2009	1-Day SOUTH AFRICAN TRANSPORT CONFERENCE	SATC, Pretoria, South Africa
18 June 2008	1-Day TRANSPORT MODELLING conference	Mott MacDonald Consultants with Landor Conferences, Birmingham, UK
11 April 2008	1-Day seminar on Challenges for Today's Transport Modellers	Minnerva Consultants. London, UK
17 – 19 October 2007	3-Day EUROPEAN TRANSPORT CONFERENCE	Association for European Transport, Leiden, Netherlands
27 June 2006	1-Day TRANSPORT MODELLING conference	Mott MacDonald Consultants with Landor Conferences, Birmingham, UK
12 May 2005	1-Day course on MEETING SKILLS	Carr Communications, Dublin, Ireland
12 – 14 April 2005	3-Day beginner OMNITRANS course	Omnitrans Software Developers, Deventer, Netherlands
6 – 8 December 2004	3-Day course for manager and modellers on TRIPS	Citilabs Software Developers, Dublin, Ireland
16 – 18 September 2003	3-Day Introduction to SATURN	Prof Dirck Van Vliet, Institute for Transport Studies, University of Leeds, UK
15 – 17 October 2003	3-Day theoretical course on TRANSPORT MODELLING	Prof. Juan de Dios Ortuzar and Dr Luis Willumsen, Cambridge, UK
10 – 11 June 2002	2-Day basic TRANSYT Workshop	Barbara Chard Consultants, Bournemouth, UK
7 – 9 January 2002	3-Day introductory PARAMICS course	SIAS Consultants, Dunboyne, Ireland

Publications & Papers presented

Brislin A, De Abreu V, Serero G and Van Jaarsveld G. 2015. Feasibility Study on Traffic Decongestion Strategies at Maseru Bridge Border Post. South African Transport Conference. Pretoria

Language Skills

Mother Tongue:	Afrikaans		
Languages	Speak	Read	Write
English	Excellent	Excellent	Excellent
Afrikaans	Excellent	Excellent	Excellent

Certification

I, the undersigned, certify that to the best of my knowledge and belief, this CV correctly describes my qualifications, my experience, and myself. I understand that any wilful misstatement described herein may lead to my disqualification or dismissal, if engaged.

_____ **Date:** _____
(Signature of staff member or authorised representative of the firm) *Day/Month/Year*

Full name of staff member: _____

Full name of authorised representative: _____



Charlotte Xhobiso

Graduate Engineer

Professional Overview

Charlotte is a Graduate Engineer in the Planning and Traffic Engineering Function, with a Bachelor in Engineering degree (Civil Engineering) from the University of Johannesburg (2016). She is currently working in the Planning and Traffic Engineering function in the Johannesburg office.

Charlotte has gained experience in conducting various Traffic Impact Studies which has involved microscopic and macroscopic Simulation Traffic Modelling using SIDRA and PTV Visum, GIS geospatial data management, analysis and visualisation, and conceptual drawings. Her experience also includes signal plans and designs.

Her experience also includes data management and analysis during the NEQ data collection project by handling and analysing Rea Vaya and SANRAL annual data.

She has been involved in Management Services projects where she has worked on and coordinated a small team to conduct water meter audits in Rustenburg and Bloemfontein and also been involved in site investigation, reporting and GIS analysis for Urban Design projects.

Relevant Project Experience

XL0038: Revision of Master Plans and Development of New Green Conceptual, Detailed City Development Plans for Six Cities of Rwanda

Date: 2019 (Ongoing)

Client: Surbana Jurong

Client Contact Details: Enrico Moriello; Project Manager; E
enrico.morriello@surbanajurong.com

Description: The development of a Macro Demand Model to assess travel demand and re-routing of traffic as a result of the socio-economic development plan in the respective secondary cities in Rwanda using VISUM software. Update of the Transportation Masterplan for these cities.

Role: Transport and Traffic Modeller, GIS Specialist

Responsibilities: Transport modelling PTV VISUM, GIS digitising and mapping

PE270: Tswaing Mega City Development SATURN TIA

Date: 2017

Client: Makole Property Developers

Client Contact Details: Mokganyetsi Mashele

Description: SMEC SA has been appointed to conduct a Traffic Impact Study and Site Traffic Assessment for the proposed Tswaing Mega-City Development. The development site is on portion 1 of the farm Tswaing 149 – JR located north of Soshanguve, east of the Twaing Crater. The Tswaing Mega-City Traffic Impact Study evaluated the impact of the new development on the surrounding road network, by

Personal Info

- ID Nr.: 920913 0308 081
- Country of Birth: South Africa
- Nationality: South African
- Date joined the Firm: January 2017

Years of Industry Experience

2 years

Countries of Experience

- South Africa

Qualifications and Memberships

- Bachelor of Engineering, University of Johannesburg, 2016
- Candidate Engineer, The Engineering Council of South Africa (201751297)

Key Skills and Competencies

- Planning and Traffic Engineering
- Data Handling and Analysis
- Transport Modelling
- Traffic Impact Studies
- Software: PTV VISUM, SIDRA, QGIS
- AutoCAD & Microstation Power Draft
- Signal Plans & Design

means of a traffic model, and propose mitigation measures, if required, in order to maintain acceptable level of service at the intersections surrounding the development. The study also evaluated the adequacy of public transport and non-motorised transport (NMT) for the Tswaing Mega-City Development.

Role: Graduate Transport Modeller

Responsibilities: Conduct Site Traffic Assessment, SIDRA modelling, GIS mapping and report writing

JT0042: City of Johannesburg North Eastern Quadrant Data Collection and Profitability of Minibus Taxi Industry | R9.8m

Date: 2018

Client: City of Johannesburg

Client Contact Details: Daisy Dwango, Project Manager; E daisyd@joburg.org.za

Description: The collection, compilation and analysis of private and public transport data in the north-east quadrant area of Johannesburg. This project includes the collection of data on minibus taxis at taxi facilities and on-board surveys of buses.

Role: Transport and Traffic Modeller

Responsibilities: Data handling SANRAL and Rea Vaya annual profile compilation and stakeholder engagement.

JT0045: Vaalbult Colliery Traffic Impact Assessment | R97k

Date: 2018

Client: Vaalbult Mining Company

Client Contact Details: Jakes Van Biljon, Project Manager; Ph (+27)082 499 6582 E jakes@vcmining.co.za

Description: Development of Traffic Impact Assessment with a Traffic Management Plan for the Vaalbult Colliery in Mpumalanga. The aim was to analyse the impact of the mining activities on traffic in the surrounding road network and develop a Traffic Management Plan for midday roadblocks during blasting on a provincial road.

Role: Graduate Engineer

Responsibilities: Development of the traffic impact assessment including analysis and reporting.

JT0041: Gautrain Management Agency GRRIN Scenario Fare Testing | R2.6m

Date: 2018

Client: Gautrain Management Agency

Client Contact Details: Victor Shange, Ph +27 11 086 3533

Description: A multi-modal EMME model was developed in 2014 for the Gauteng Province to test the feasibility of the Gautrain Rapid Rail Integrated Network (GRRIN). For the Scenario Fare Testing project, this existing model was applied to test the impact of different fare structures on the expected patronage and revenue of the Gautrain, and the impact on the required infrastructure and operational costs.

Role: Graduate Engineer

Responsibilities: High Model Shift Assessment sensitivity analysis, public transport time and cost surveys, management and coordination of survey auditors and report writing.

JU0057: City of Ekurhuleni Sanitation Feasibility Study | R350k

Date: 2018

Client: Ekurhuleni Metropolitan Municipality

Description: SMEC South Africa was appointed to conduct a feasibility study to determine optimum solutions for the provision of water and sanitation services to informal settlements in the City of Ekurhuleni (CoE). The feasibility study includes an overview of current services provided in each settlement, operations and maintenance, and possible solution options, which are considered for the implementation of the programme. The feasibility study will provide a framework for the development of business cases for sustainable water and sanitation service provision.

Role: Graduate Engineer

Responsibilities: Site Investigation, problem/needs identification, high level planning and recommendation of solutions, GIS digitisation and report writing.

XL0036: Kigali Transport Master Plan Review and Update, Rwanda | R2.6m

Date: 2018

Client: Surbana Jurong on behalf of City of Kigali

Client Contact Details: Enrico Moriello; Project Manager; E enrico.morriello@surbanajurong.com

Description: A multi-modal PTV Visum model was developed in 2013 for the City of Kigali to develop the transport master plan for the City. The 2013 model was not calibrated to baseline data and simply forecasted the envisioned demand and assumed a mode split between private and public transport. For the review and update of the masterplan, this Visum model was updated by calibrating the private transport component to observed baseline data (household travel survey data) and developing a spreadsheet based public transport model based on observed baseline data.

Role: Graduate Engineer

Responsibilities: Kigali Network on coding PTV Visum

BCM45 - Enhancement of WDM Initiatives (South Africa) | R2m

Date: 2018

Client: Mangaung Metropolitan Municipality

Client Contact Details: Koki Mokhoabane, WDM Manger, Ph +2751 410 6679, E koki.mokhoabane@mangaung.co.za

Description: The project involved performing physical meter audits, logging large consumers and logging of the Discrete Metered Areas within the municipal area, and performing business process mapping of the meter replacement cycle.

Role: Graduate Engineer

Responsibilities: Water Meter Audit GIS and collection data managing

JD0019: Rustenburg Local Municipality AC Pipe Replacement | R7m

Date: 2018

Client: Rustenburg Local Municipality

Client Contact Details: Wanda Simelane, Project Manager, Ph +2782 555 5935, E wsimelane@rustenburg.gov.za

Description: Refurbishment and Replacement of AC Pipes and Upgrading of Water Meters and Aged Connections- Zinniaville and Karlienpark.

Role: Graduate Engineer

Responsibilities: On-site water meter verification survey, data digitising with Qfield. Data Mapping and management with QGIS.

DM0142: Arcus Wind Energy Facilities Traffic Impact Assessment | R170k

Date: 2018

Client: Arcus Consulting

Client Contact Details: Ashlin Bodasing, Project Manager; E ashlinb@arcusconsulting.co.za

Description: Arcus Consultancy Services appointed SMEC South Africa to provide specialist Traffic Engineering services on two proposed Wind Energy Facilities. The project included the development of a Traffic Impact Assessment to assess the impact of each proposed Wind Energy Facility on the surrounding road network, evaluation of transport permits required for abnormal vehicles and make recommendations on access locations and designs.

Role: Graduate Engineer

Responsibilities: Trip generation, trip assignment, trip distribution for the pre-construction, construction, operational, decommissioning phases of the project and report writings.

JT0035: Balfour Park Traffic Impact Study | R130k

Date: 2017

Client: Akweni Group (Pty) Ltd

Description: Development of a high level Traffic Impact Study for a student promenade along Athol Street as part of the urban development of the Balfour Park Precinct.

Eight selected intersections were assessed in terms of intersection capacity, access to surrounding properties and a high level parking assessment was conducted. Focus was placed on NMT accessibility, road safety and universal access in order to ensure that the student promenade was NMT friendly and safe for the use of learners and pedestrians. The deliverable was a Traffic Impact Study report which included an Access and Parking analysis, Public Transport and Non-Motorised Transport chapter.

Role: Graduate Engineer

Responsibilities: Analysis of intersections performance using SIDRA

JD0019: Imbunga City Walk Project | R2.8m

Date: 2017

Client: Kigali City

Description: The City of Kigali appointed SMEC South Africa to assist with traffic engineering solutions in the pedestrian station of KN4 Avenue in Kigali. The task was to assess the impact of the closure of KN4 Avenue to normal traffic and recommend solutions to minimise impact and improve circulation within the city.

Role: Traffic Technologist

Responsibilities: Traffic Signal Plan Designs, High-level construction plan

DM0142: Edendale TIA | R170k

Date: 2017

Client: Sivest

Description: Development of a high level Traffic Impact Assessment to assess the impact of the proposed mixed-use Edendale Town Centre on the surrounding road network. The deliverable was a Traffic Impact Assessment report, which included a Public Transport and Non-Motorised Transport chapter.

Role: Graduate Engineer

Responsibilities: Trip Generation, trip assignment, trip distribution. AutoCAD sticks drawings.

JT0031: Meyerton Sicelo Shiceka ext 5 TIA | R120k

Date: 2017

Client: ASA Group Consultancy

Description: Development of a Traffic Impact Assessment for the Sicelo Shiceka ext 5 residential development with 700 dwelling units. The aim was to test the impact of the residential development on the surrounding road network using SIDRA intersection analysis.

Role: Graduate Engineer

Responsibilities: Trip Generation, trip assignment, trip distribution. AutoCAD sticks drawings.

JT0028: Rustenburg CBD IRPTN TIA | R700k

Date: 2017

Client: LSO Consulting Engineers on behalf of Rustenburg Local Municipality

Client Contact Details: DJ Lourens, Director; Ph 012 803 0961

Description: Development of a Saturn Model to test the impact of the proposed Rustenburg Rapid Transit (RRT) on the Rustenburg CBD intersection capacity. The project aims to test and report on pre-determined geometric layouts and recommend adequate geometric upgrades where required through the introduction of the Rustenburg Rapid Transit corridor. This deliverables include a Traffic Impact Assessment Report, Traffic Signal Design, Access Study Report and a Parking Study report.

Role: Graduate Engineer

Responsibilities: Traffic Signal Plan Designs.

JT0017: Rosebank NMT Design and Implementation | R4m

Date: 2017

Client: Johannesburg Development Agency

Client Contact Details: Mr. Sithandile Xhanti, Project Director; Ph +27 (0)11 688 7800

Description: SMEC South Africa (PTY) Ltd was appointed as Civil Engineer for the Design and Implementation of the Rosebank Non-Motorised Transport and Cycle Lanes Phase1, Phase 2 & Phase 3

Role: Graduate Transport Planner

Responsibility: Generating of SIDRA intersection analysis and Signal Plan Designs.

JT0020: Western Cape Road Safety Strategy | R2.9m

Date: 2017

Client: Western Cape Government – Transport and Public Works

Description: In conjunction with the Universities of Cape Town and Stellenbosch, SMEC has to compile the Western Cape's Road Safety Strategy. The strategy will devise a framework for implementation of road safety principles within the Province.

Role: Graduate Engineer

Responsibility: Research and report writing of Tender Audit Policy, compiling of high level cost estimations and involvement in the Road Traffic Safety Interventions Toolkit.

JT0027: Vanderbijlpark CBD Traffic Flow, Parking and NMT Impact Study | R750k

Date: 2017

Client: Emfuleni Local Municipality

Client Contact Details: Mr. David Letsoalo, Consultant Engineer; Ph +27 (0)72 536 4875

Description: Key issues identified in the Vanderbijlpark CBD are parking capacity problems, traffic congestion, parking bay utilisation, safety, access and mobility. The project aims to upgrade the CBD to encourage efficient use of the road reserve, parking bays and sidewalks, thus relieving traffic congestion and improving traffic safety.

Role: Graduate Engineer

Responsibility: Compilation and report writing of Parking Plan Report

Professional History

January 2017- Current: SMEC South Africa (Pty) Ltd – Graduate Engineer

Courses & Conferences attended

July 2018: South African Transport Conference 2018: 4A Integrated Public Transport Networks: Mapping, Data and ICT
 July 2018: South African Transport Conference 2018: Urban Transport
 March 2018: Special Transport Forum SIG
 March 2018: Internal Public Transport Workshop on BRT Infrastructure
 August 2017: Internal Rail and Public Transport Planning Lecture
 July 2017: South African Transport Conference
 March 2017: Internal SIDRA Training
 January 2017: Internal EMME and Saturn Training

Publications & Papers presented

N/A

Language Skills

Mother Tongue:	Zulu		
Languages	Speak	Read	Write
English	Excellent	Excellent	Excellent
Zulu	Excellent	Fair	Fair
Sotho	Excellent	Fair	Fair
Xhosa	Good	Fair	Fair

Certification

I, the undersigned, certify that to the best of my knowledge and belief, this CV correctly describes my qualifications, my experience, and myself. I understand that any wilful misstatement described herein may lead to my disqualification or dismissal, if engaged.

_____ **Date:** _____
(Signature of staff member or authorised representative of the firm) *Day/Month/Year*

Full name of staff member: _____

Full name of authorised representative: _____



environmental affairs

Department:
Environmental Affairs
REPUBLIC OF SOUTH AFRICA

DETAILS OF THE SPECIALIST, DECLARATION OF INTEREST AND UNDERTAKING UNDER OATH

	(For official use only)
File Reference Number:	
NEAS Reference Number:	DEA/EIA/
Date Received:	

Application for authorisation in terms of the National Environmental Management Act, Act No. 107 of 1998, as amended and the Environmental Impact Assessment (EIA) Regulations, 2014, as amended (the Regulations)

PROJECT TITLE

San Kraal and Phezukomoya Amendment Applications

Kindly note the following:

1. This form must always be used for applications that must be subjected to Basic Assessment or Scoping & Environmental Impact Reporting where this Department is the Competent Authority.
2. This form is current as of 01 September 2018. It is the responsibility of the Applicant / Environmental Assessment Practitioner (EAP) to ascertain whether subsequent versions of the form have been published or produced by the Competent Authority. The latest available Departmental templates are available at <https://www.environment.gov.za/documents/forms>.
3. A copy of this form containing original signatures must be appended to all Draft and Final Reports submitted to the department for consideration.
4. All documentation delivered to the physical address contained in this form must be delivered during the official Departmental Officer Hours which is visible on the Departmental gate.
5. All EIA related documents (includes application forms, reports or any EIA related submissions) that are faxed; emailed; delivered to Security or placed in the Departmental Tender Box will not be accepted, only hardcopy submissions are accepted.

Departmental Details

Postal address:

Department of Environmental Affairs
Attention: Chief Director: Integrated Environmental Authorisations
Private Bag X447
Pretoria
0001

Physical address:

Department of Environmental Affairs
Attention: Chief Director: Integrated Environmental Authorisations
Environment House
473 Steve Biko Road
Arcadia

Queries must be directed to the Directorate: Coordination, Strategic Planning and Support at:
Email: EIAAdmin@environment.gov.za

1. SPECIALIST INFORMATION

Specialist Company Name:	SMEC SOUTH AFRICA		
B-BBEE	Contribution level (indicate 1 to 8 or non-compliant)	1	Percentage Procurement recognition
			135%
Specialist name:	CIERNA VAN JAARSVELD		
Specialist Qualifications:	B(TOWN AND REGIONAL PLANNING); MSc (TRANSPORT PLANNING)		
Professional affiliation/registration:	PROFESSIONAL PLANNER (SA) (A/2406/2016)		
Physical address:	267 KENT AVENUE FERNDALE JOHANNESBURG 2194		
Postal address:	PO BOX 1462 PINEGOWRIE		
Postal code:	2123	Cell:	
Telephone:	(011) 369 0703	Fax:	(011) 886 4589
E-mail:	CIERNA.VAN.JAARSVELD@SMEC.COM		

2. DECLARATION BY THE SPECIALIST

I, CIERNA VAN JAARSVELD, declare that –

- I act as the independent specialist in this application;
- I will perform the work relating to the application in an objective manner, even if this results in views and findings that are not favourable to the applicant;
- I declare that there are no circumstances that may compromise my objectivity in performing such work;
- I have expertise in conducting the specialist report relevant to this application, including knowledge of the Act, Regulations and any guidelines that have relevance to the proposed activity;
- I will comply with the Act, Regulations and all other applicable legislation;
- I have no, and will not engage in, conflicting interests in the undertaking of the activity;
- I undertake to disclose to the applicant and the competent authority all material information in my possession that reasonably has or may have the potential of influencing - any decision to be taken with respect to the application by the competent authority; and - the objectivity of any report, plan or document to be prepared by myself for submission to the competent authority;
- all the particulars furnished by me in this form are true and correct; and
- I realise that a false declaration is an offence in terms of regulation 48 and is punishable in terms of section 24F of the Act.



Signature of the Specialist

SMEC SOUTH AFRICA

Name of Company:

08/08/2019

Date

3. UNDERTAKING UNDER OATH/ AFFIRMATION

I, GERNA VAN JAARVELD, swear under oath / affirm that all the information submitted or to be submitted for the purposes of this application is true and correct.

Germa van Jaarsveld

Signature of the Specialist

SMEC SOUTH AFRICA

Name of Company

08/08/2019

Date

L. Smit

Signature of the Commissioner of Oaths

08 - 08 - 2019

Date

LISA MARY SMIT
Commissioner of Oaths
Reference: RO-12/02/2019
267 Kent Avenue, Ferndale
Randburg, 2194