

# **HOTAZEL SOLAR PHOTOVOLTAIC FACILITY AND ASSOCIATED INFRASTRUCTURE**



## **CONCEPTUAL STORMWATER MANAGEMENT PLAN**

**MAY 2020**



P O Box 381  
Century City  
7441  
Tel. +27 21 555 0400

Rev	Description	Date
0	Issued in Draft	October 2018
1	Final Submission	November 2018
2	Amended Layout	May 2020

This report was prepared and reviewed by the undersigned.

Prepared:

---

Sonet Gerber,  
Civil Technologist

Reviewed:

---

Waseemah Isaacs  
Principal Civil Technologist

This report was prepared by Knight Piésold Ltd. for the account of ABO Wind Hotazel Solar (Pty). Report content reflects Knight Piésold's best judgement based on the information available at the time of preparation. Any use a third party makes of this report, or any reliance on or decisions made based on it is the responsibility of such third parties. Knight Piésold Ltd. accepts no responsibility for damages, if any, suffered by any third party as a result of decisions made or actions based on this report. Any reproductions of this report are uncontrolled and might not be the most recent revision.

## SPECIALIST EXPERTISE

### SONET GERBER

**Profession:** Civil Technologist  
**Position in Firm:** Senior Civil Technologist  
**Qualifications:** PrTech 201470085  
**Years of Experience:** 15 years

**Summary of Experience:** Sonet Gerber is a Senior Civil Technologist in the Transport and Infrastructure division in Knight Piésold's Cape Town Office. She has 15 years of engineering experience. After completing her in-service training at Ninham Shand Consulting Engineers in Port Elizabeth, she started her career abroad working at the London Borough of Newham where she was employed at the Highways Department in 2003 and gaining valuable experience working on various Road Safety Schemes. In recent years, she concentrated on the design and maintenance of various roads and engineering infrastructure projects. She is currently a Civil Technologist in the Roads and Civil Engineering Services Design division in Cape Town.

#### **Specialist Experience:**

**COCT: Public Transport Interchange: Project Manager:** Concept Design and Detail Design.

**Drakenstein Municipality: Assistant Contract Engineer & Resident Engineer:** Bulk Water pipe, HDPE 450mm dia of 2.3km.

**SANRAL: The Periodic Maintenance (Resurfacing) of National Route 12,** Assistant Contracts Engineer of 3 projects running simultaneously, Section 9 between Voetpaddrift and Kimberley, Section 10 between Kimberley and Riverton and Section 10 between Riverton and Windsorton.

**City of Cape Town: Non Motorised Transport Eastern Region Phase 2 Phase 3** Master Planning design, compilation of tender documentation and adjudication. Project Management. Oversee Resident Engineers of individual projects, including site administration.

**Greenfield Properties: Aan De Wijnlanden Phase 2 Phase 5, Eersteriver** Assisting in Development Rights approval, Services Report and Stormwater Management plan and supporting documentation for EIA and Water Use licence. Assistant RE and Contracts Engineer.

**Drakenstein Municipality: Wellington Industrial Area Upgrade** Project Manager team of 6 Specialist sub-consultants in the process of Conduction specialist studies and obtaining rights for the Wellington Industrial Park. KP also appointed to deal with Civil Engineering aspect of the application including for Services report and Stormwater Management Plan

**Greenfield Properties: Aan De Wijnlanden, Eersteriver** Tender documentation, Assistant Resident Engineer and project management.

**City of Cape Town: Non Motorised Transport Eastern Region** Design and draughting, compilation of tender documentation as well as adjudication. Project Management and Resident Engineer for 4 individual projects, including site administration.

**City of Cape Town: Quality Public Spaces Design and draughting,** compilation of tender documentation as well as adjudication. Assistant Resident Engineer for 5 Individual projects, including site administration.

**City of Cape Town: Non Motorised Transport Central Region** Design and draughting, compilation of tender documentation as well as adjudication. Assistant Resident Engineer for 5 individual projects, including site administration.

**City of Cape Town: Non Motorised Transport Central Region** Design and draughting, compilation of tender documentation as well as adjudication. Assistant Resident Engineer for 4 individual projects, including site administration.

**Hout Bay: Pick 'n Pay Shopping Centre Development** Responsible for the design and draughting of civil engineering services for construction, including road signage. Monitoring and site inspections.

**Philippi: Shopping Centre Development** Preparation of civil engineering services drawings for construction.

**Jeffreys Bay Windfarm:** Mainstream Renewable Power South Africa Proposed road cost estimate

**DCD Dorbyl: Foul Sewer Services** Design and draughting. Monitoring and site inspections including site administration.

## SPECIALIST DECLARATION

I, **Sonet Gerber**, as the appointed independent specialist, in terms of the 2014 EIA Regulations, hereby declare that:

- I act as the independent specialist in this application;
- I will perform the work relating to the application in an objective manner, even if this results in views and findings that are not favorable to the applicant;
- I declare that there are no circumstances that may compromise my objectivity in performing such work;
- I have expertise in conducting the specialist report relevant to this application including knowledge of the Act, regulations and any guidelines that have relevance to the proposed activity;
- I will comply with the Act, regulations and all other applicable legislation;
- I have no, and will not engage in, conflicting interests in the undertaking of the activity;
- I undertake to disclose to the applicant and the competent authority all material information in my possession that reasonably has or may have the potential of influencing – any decision to be taken with respect to the application by the competent authority; and – the objectivity of any report, plan or document to be prepared by myself for submission to the competent authority;
- All the particulars furnished by me in this form are true and correct; and
- I realise that a false declaration is an offence in terms of Regulation 71 and is punishable on terms of section 24F of the Act.

Signature of Specialist:

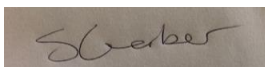

Name of Specialist: Sonet Gerber

Date: 26 May 2020

## Table of Contents

1. INTRODUCTION .....	1
2. DEFINITIONS AND ASSUMPTIONS .....	1
3. EXISTING SITE CONDITIONS .....	2
3.1. Location .....	2
3.2. Topography, Geomorphology and Vegetation (Drainage Characteristics).....	3
3.3. Geology and Soils.....	4
3.4. Climate and Hydrology.....	5
4. STORMWATER CALCULATIONS.....	6
4.1. Runoff Coefficient .....	6
4.2. Time of Concentration.....	8
4.3. Point Intensity .....	8
4.4. Runoff .....	8
5. PROPOSALS FOR STORMWATER MANAGEMENT.....	11
5.1. Side Drains .....	12
5.2. Berms.....	12
5.3. Outlets.....	12
6. EROSION PROTECTION MEASURES .....	13
7. WASTE WATER MANAGEMENT .....	15
8. CONCLUSIONS AND RECOMMENDATIONS.....	16
9. REFERENCES .....	16
10. ANNEXURES .....	17

## List of Figures

Figure 3.1: Locality Plan.....	2
Figure 3.2: Drainage Pattern of Existing Site.....	3
Figure 3.3: Catchment Areas .....	4
Figure 3.4: Monthly Rainfall for Hotazel .....	5
Figure 3.5: Average Monthly Temperatures for Hotazel .....	6
Figure 4.1: Conceptual Layout of PV Panels .....	9
Figure 4.2: Drainage pattern for conceptual layout of PV panels .....	9
Figure 4.3: Access Roads .....	11
Figure 5.1: Typical Berm Detail.....	12
Figure 6.1: Typical Stone Pitched Side Drain .....	13
Figure 6.2: Typical Concrete Lined Side Drain .....	13
Figure 6.3: Typical inlet erosion protection measures .....	14
Figure 6.4: Typical outlet erosion protection measures .....	14

## List of Tables

Table 4.1: Pre-development Runoff Coefficient Percentages.....	7
Table 4.2: Post-development Runoff Coefficient Percentages .....	7

## 1. INTRODUCTION

Knight Piésold Consulting was appointed by ABO Wind Hotazel Solar PV (Pty) Ltd to investigate and compile a Conceptual Stormwater Management Plan for the proposed Hotazel Solar photovoltaic (PV) energy facility and associated infrastructure.

This report should be viewed as a localised high-level study and not as a detailed design report. The objective is purely to demonstrate that stormwater from the new development could be managed and controlled in an optimised and non-destructive manner. The purpose of this study is to prepare a conceptual Stormwater Management Plan (SWMP) to support the Environmental Impact Assessment Process of the proposed Hotazel Solar PV facility.

The SMP includes the following:

- Determining the catchment area of the project site;
- Defining the topography, slope gradients and rainfall intensities;
- Estimating expected floods for the catchment;
- Confirming of existing drainage patterns and streams;
- Proposing drainage elements such as side drains, outlets and other mitigation measures to accommodate the resultant stormwater flows.

## 2. DEFINITIONS AND ASSUMPTIONS

The following assumptions are made on stormwater calculations and are deemed to be adequate for a conceptual investigative report:

- The Rational Method is used for flood calculations, which is widely accepted to be very accurate for areas of this size;
- The recurrence period applied is a 1:50 year design flood;
- There are no watercourses that will affect planning and the design of the solar facility.



### 3. EXISTING SITE CONDITIONS

#### 3.1. Location

The site is situated approximately 3km south-east of Hotazel, see *Figure 3.1*. Other towns in proximity of the project include Kuruman, located approximately 52km south-east, and Kathu located approximately 60km south of the project site. The site falls within Ward 4 of the Joe Morolong Local Municipality of the John Taolo Gaetsewe District Municipality. A railway line runs along the south-western boundary of the project site and traverses the area just west of the project in a north-to-south direction. A formal gravel access road currently provides access from the regional road (R31) to the property. This gravel road then becomes a formal 2-wheel track. The site can be accessed through one of two gates.

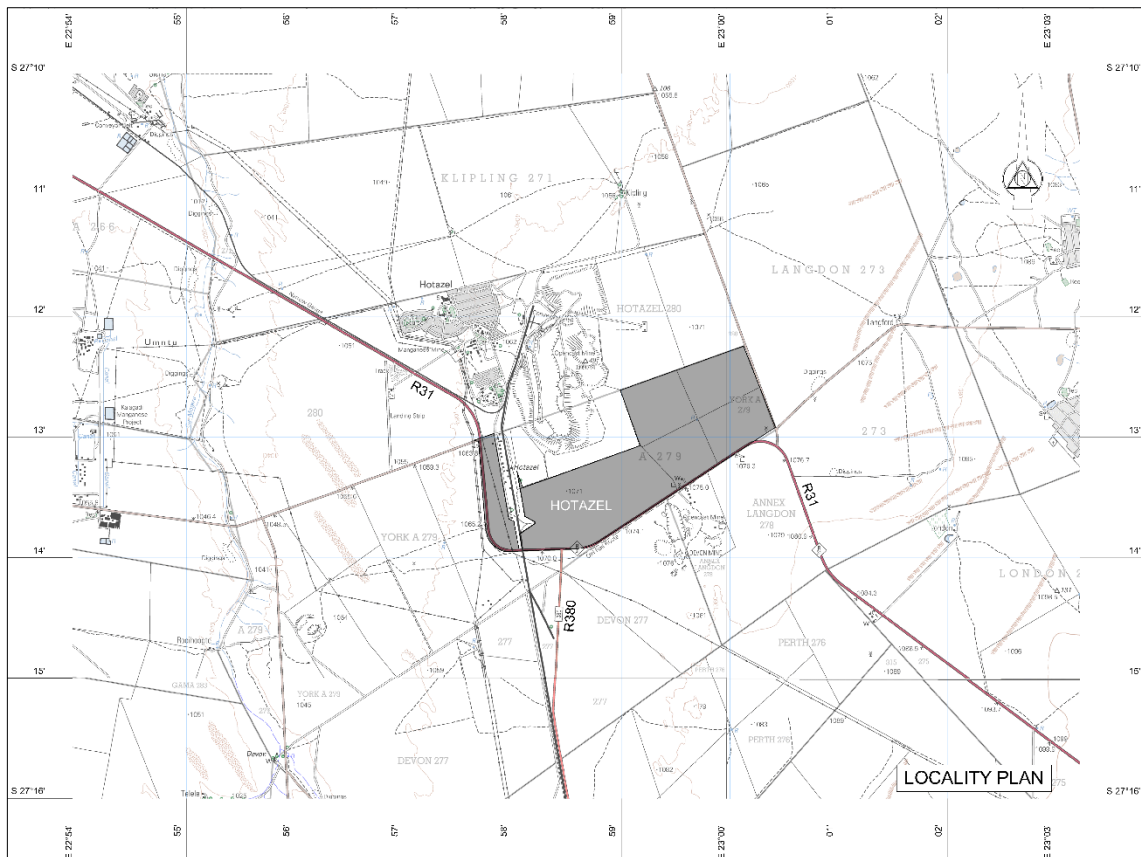

**Figure 3.1:** Locality Plan



### 3.2. Topography, Geomorphology and Vegetation (Drainage Characteristics)

The Northern Cape Province is situated in the north-western extent of South Africa. It is South Africa’s largest Province. The Remaining Extent (Portion 0) of the Farm York A 279 has an almost level topography with a straight shape and a slope gradient of 0.5%. It is currently utilised for limited agricultural purposes. The vegetation that covers the property has been classified as Kathu Bushveld with a well-developed grass layer and a variable density tree layer.

#### 3.2.1. Drainage Patterns and Runoff Characteristics

The approximate total drainage area of the Remaining Extent (Portion 0) of Farm York A 279 is in excess of 636.8 hectares. Although the property does not reflect evidence of any watercourses, the drainage pattern slopes in a north westerly direction, see *Figure 3.2*. The slope gradient for the longest drainage path length within the catchment area is 0.27%.

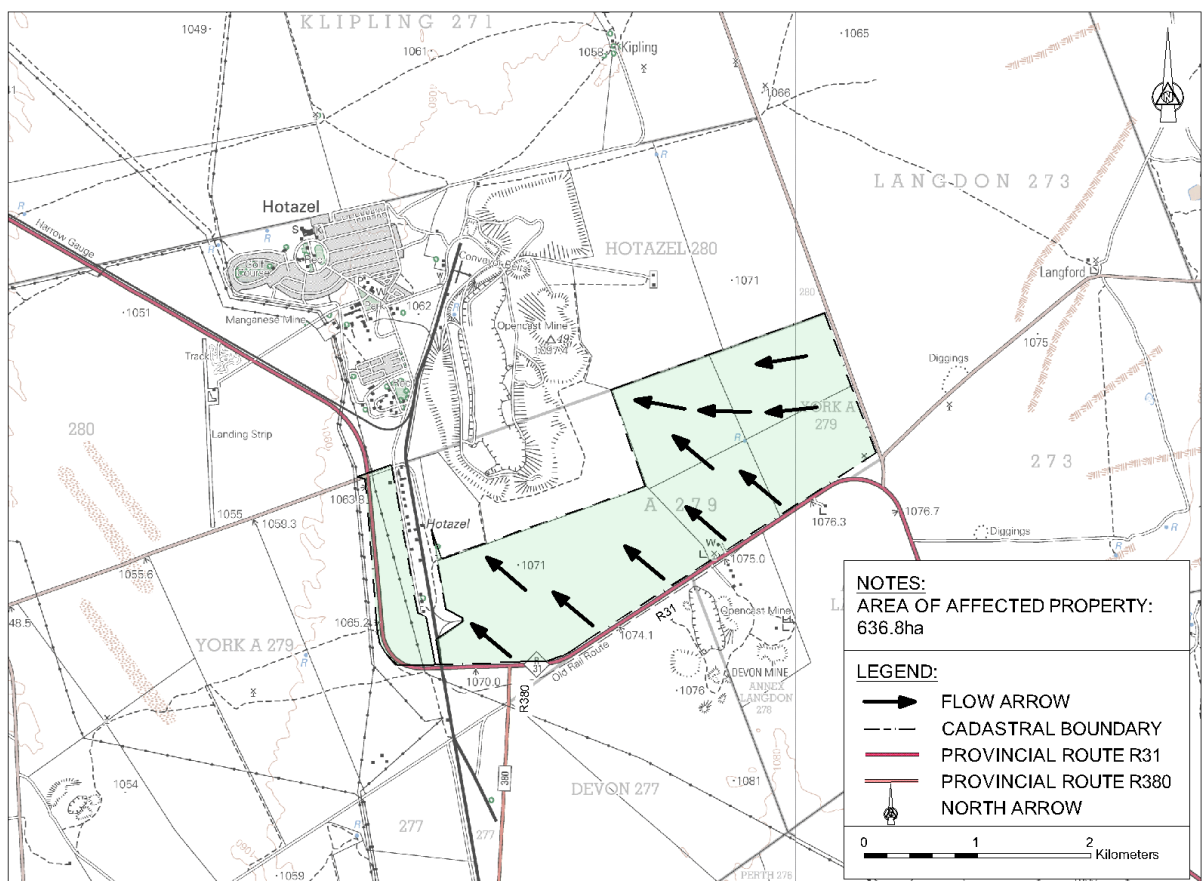

**Figure 3.2:** Drainage Pattern of Remaining Extent (Portion 0) of Farm York A 279

It should be noted that, in the absence of detailed topographical survey information, 1:10 000 orthographical maps together with spot height data taken on site were used to establish the drainage patterns. The greater catchment area is 1 830ha, see *Figure 3.3* below. The sparse vegetation, together with the flat gradient and permeable soils yield very low runoff coefficients.

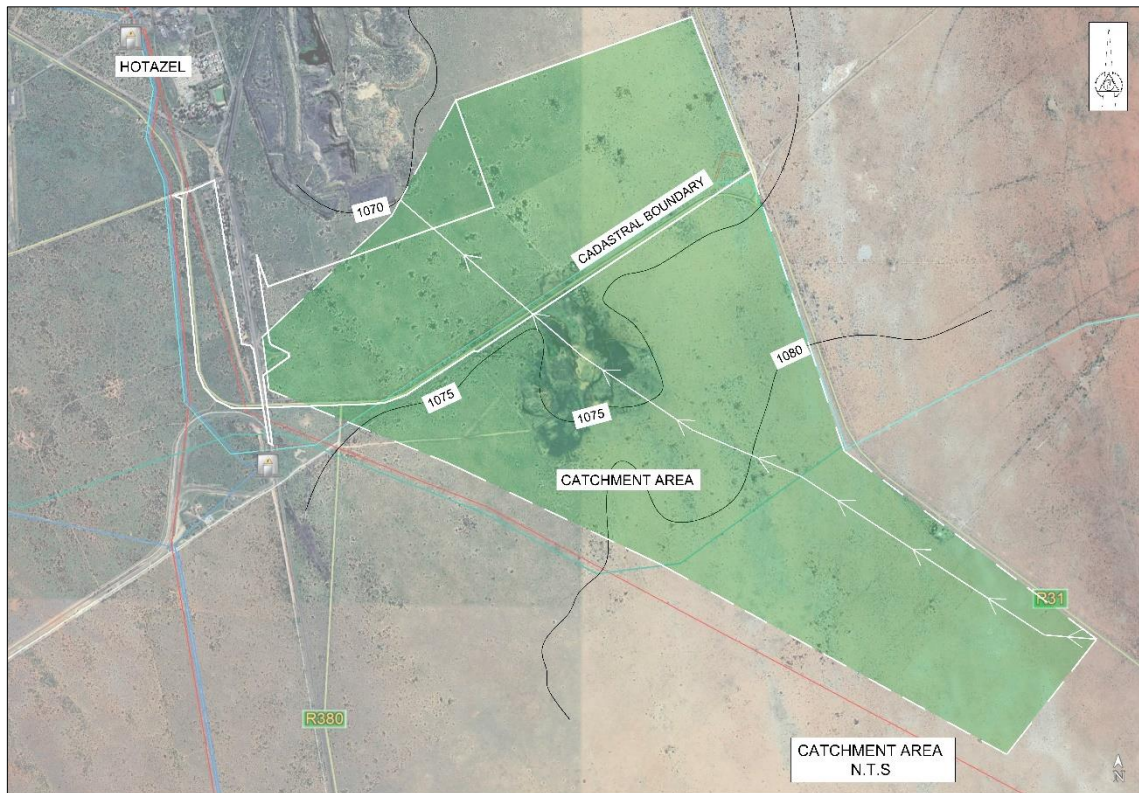

**Figure 3.3:** Catchment Areas

### 3.3. Geology and Soils

A number of manganese mining operations occur within close proximity of the project site. The Langdon Devon Manganese Mine is located immediately south of the project site. As a result, numerous waste rock dumps associated with these manganese mines are located within the vicinity of the project site. The manganese mine located directly to the north of the site is no longer in use and is under rehabilitation with reduced dust emission.

The geological map as well as field studies in the region show that the Kalahari sands in this area are extensively underlain by hardpan calcretes, some of which at least can be assigned to the Mokalanen Formation of the Kalahari Group. Soils in the region are usually red and yellow well drained sandy soil. Lime is generally present in part or most of the landscape and structureless free drained soil may occur. These soils may also have restricted depth, excessive drainage, high erodibility and low natural fertility.

### 3.4. Climate and Hydrology

The Kalahari region has consistent temperatures with summer and early autumn rainfall. Winters are very dry. The wettest part appears on the eastern side of the Kalahari with a Mean Annual Precipitation (MAP) of 500mm and the driest on the western side with a MAP of 120mm. The MAP for the whole Kalahari Ecozone is 250mm per annum. Precipitation is lowest in July, with an average of 2mm, and highest in March, with an average of 66mm (see *Figure 3.4*).

The Northern Cape and Namibia boast the highest solar radiation intensity anywhere in Southern Africa. At an average temperature of 26.1 °C, January is the hottest month of the year. July has the lowest average temperature of the year, which is 11.2 °C; see *Figure 3.5*. The information represented in the Figures below was gathered from the weather station at Winton, situated approximately 46km from the proposed site.

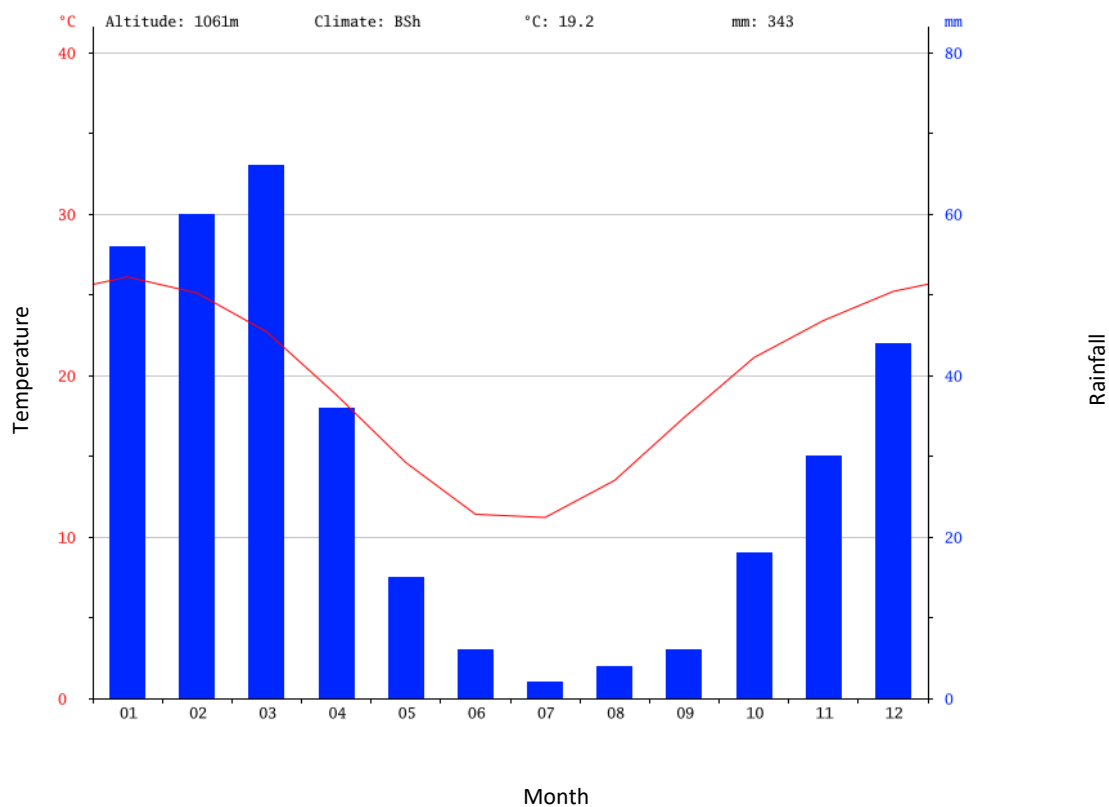

**Figure 3.4:** Monthly Rainfall for Hotazel

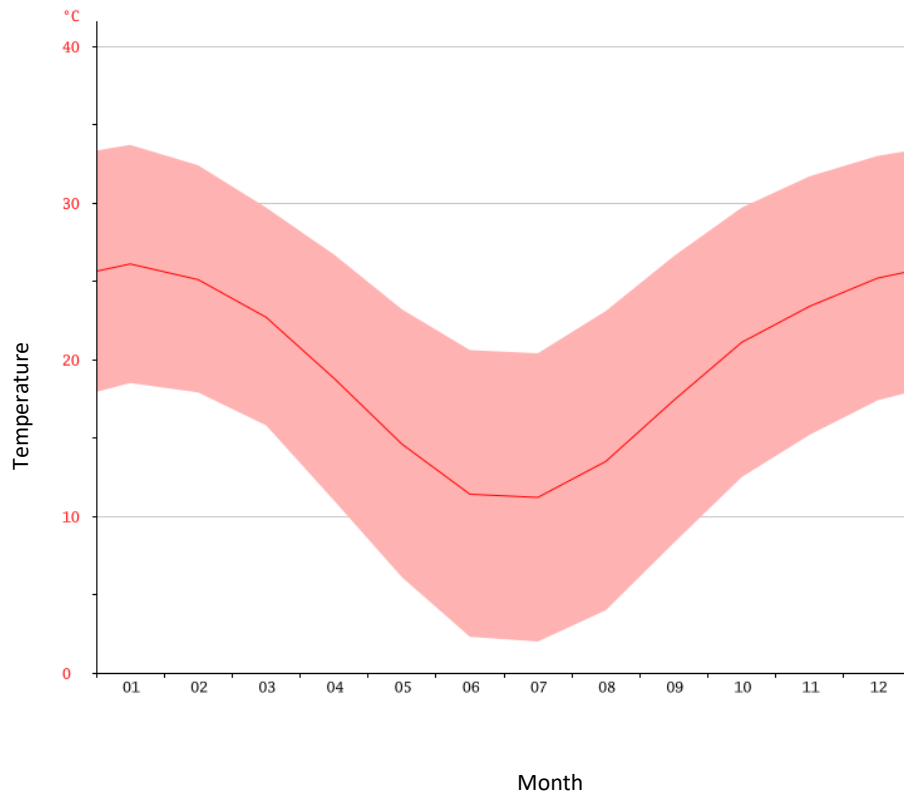

**Figure 3.5:** Average Monthly Temperatures for Hotazel

## 4. STORWATER CALCULATIONS

As mentioned previously, the calculations to determine the run off volumes and intensities of the site are based on the Rational Method with a return period of 1:50 years.

### 4.1. Runoff Coefficient

#### 4.1.1. Pre-development

The pre-development runoff coefficient was calculated by making an allowance for 20% of semi-permeable soil. The site consists mainly of Bushveld with a well-developed grass layer and a variable density tree layer; see run-off coefficient percentages listed in *Table 4.1* below.

**Table 4.1:** Pre-development Runoff Coefficient Percentages

Permeability	% Applied	Vegetation	% Applied
Very	0	Thick bush & Forest	0
Permeable	80	Light Bush & Cultivated Land	30
Semi-Permeable	20	Grasslands	70
Impermeable	0	Bare	0
<i>TOTAL</i>	<i>100</i>	<i>TOTAL</i>	<i>100</i>

Based on the above, the calculated runoff coefficient for the pre-development phase is 0.284 (see *Annexure A* for further detailed calculations).

#### 4.1.2. Post-development

The post-development runoff coefficient takes the installation of the panels into account, as well as the vegetation alterations that may occur post construction. An area of 270ha (approximately 43% of the total property) is required for the development of Hotazel Solar. Even though the PV panels are impermeable, they will be mounted on bases that only cover a small surface area. A small percentage of the run-off coefficient was thus allowed for hardened surface. The Hotazel Solar facility will aim to make use of driven/ rammed piles, or ground/ earth screw mounting systems, and only in certain instances resort to concrete foundations, should geotechnical studies necessitate this. Concrete foundations may be used for the tracker at the end of each row.

During the construction phase, vegetation will be lost, and this may not fully recover because of the shade that will be created by the panels post construction. A further allowance was made by amending the vegetation area when calculating the post-development peak runoff flows by allowing for 20% bare areas or no vegetation. These percentage figures are reflected in *Table 4.2* below.

**Table 4.2:** Post-development Runoff Coefficient Percentages

Permeability	% Applied	Vegetation	% Applied
Very	0	Thick bush & Forest	0
Permeable	75	Light Bush & Cultivated Land	30
Semi-Permeable	20	Grasslands	50
Impermeable	5	Bare	20
<i>TOTAL</i>	<i>100</i>	<i>TOTAL</i>	<i>100</i>

Based on the above, the calculated runoff coefficient for the post-development phase is 0.310 (see *Annexure B* for further detailed calculations).

## 4.2. Time of Concentration

The following formula was used to calculate the time of concentration, which is the time it takes for surface water at the furthest point on the site to reach the lowest area:

$$T_C = \left( \frac{0.87 \times L^2}{1000 \cdot S} \right)^{0.385}$$

Where  $T_C$  = Time of Concentration (hours),  $L$  = Length of waterway (km),  $S$  = average slope.

## 4.3. Point Intensity

Point Intensity is based on standard time of concentration, and information was extracted from rain fall intensity depth graphs for the area.

## 4.4. Runoff

### 4.4.1. PV Area

The runoff distribution of the respective catchment areas will be dictated by the layout of the larger PV area, as well as the internal roads and channels. Each PV area which is a combination of smaller blocks should preferably be orientated in such a way to minimise the impact on natural drainage patterns. A typical PV panel configuration (subject to the final site development plan) is indicated in the *Figure 4.1*, with the resultant drainage pattern indicated in *Figure 4.2*.



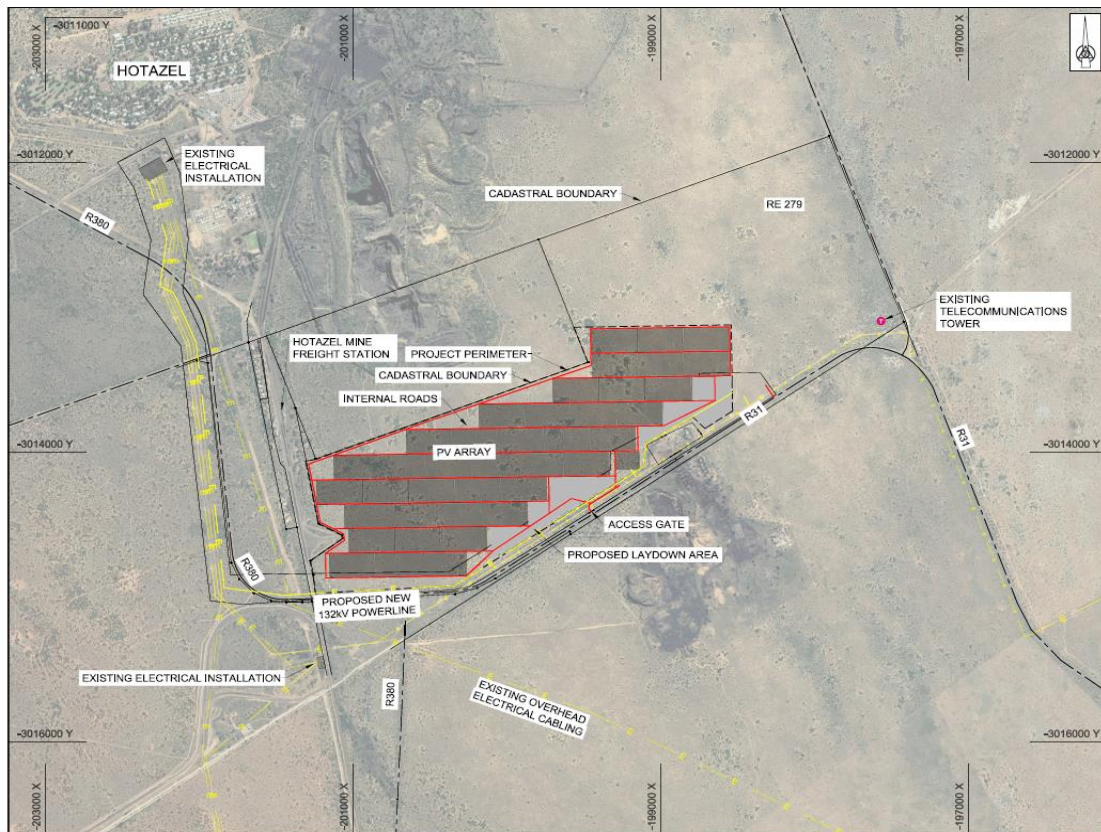

Figure 4.1: Conceptual Layout of PV Panels

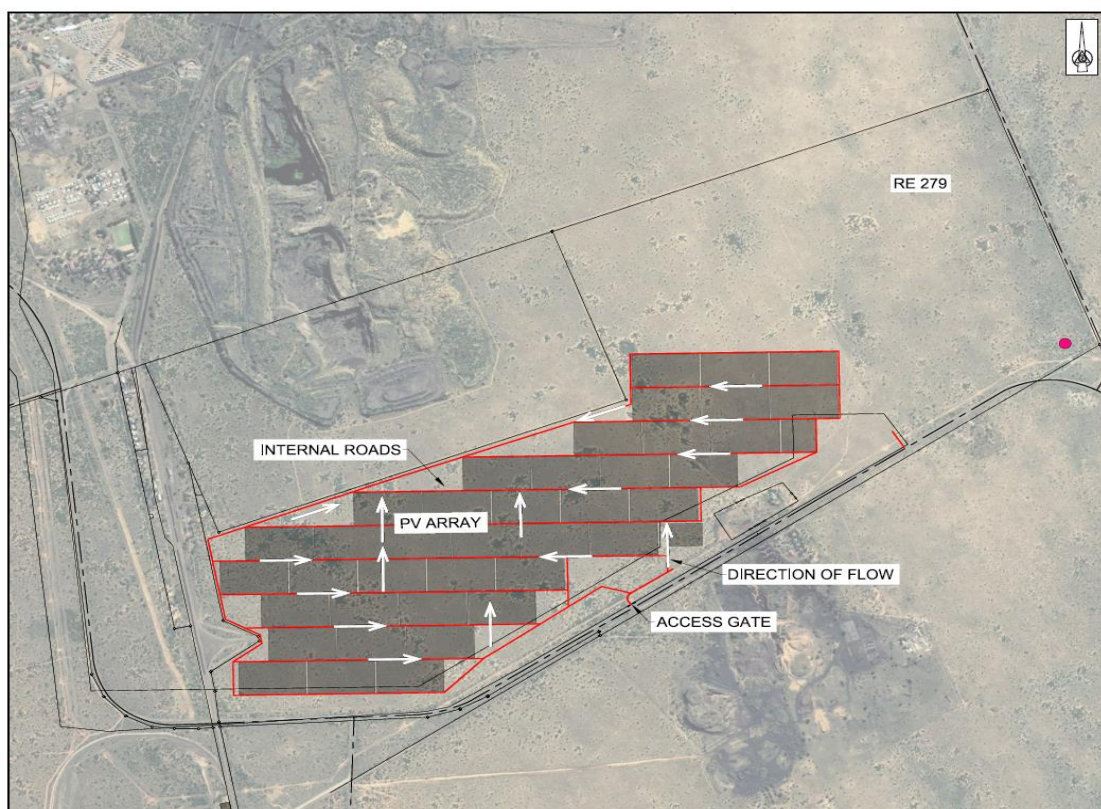

Figure 4.2: Drainage pattern for conceptual layout of PV panels



There are no waterbodies or places of ponding visible on the proposed site.

The 1:50 year flood occurrence for pre- and post-development runoff for the catchment area is shown below:

Catchment Area = 18.3 km<sup>2</sup>

Pre-Development C = 0.284

Post-Development C = 0.310

TC = 2.03 hours

Intensity = 28.3 mm/hr

$$\text{Rational Method Pre-Development } Q = \frac{CIA}{3.6} = 38.97 \text{ m}^3/\text{s}$$

$$\text{Rational Method Post-Development } Q = \frac{CIA}{3.6} = 42.28 \text{ m}^3/\text{s}$$

#### 4.4.2. Access Roads

As mentioned previously, the access road intersects with the R31 (see Figure 4.3) which does have sufficient drainage. Access option 1 is the preferred option for the proposed layout. Access option 2 is analysed as a possible alternative. It is recommended that the first 200m of the access road be upgraded to a hardened (bitumen) surface, to prevent damage to the road edge. This upgrade should allow for sufficient drainage; however the remainder of the access road will remain gravel and provision must be made for drainage thereof.

The run-off across the gravel road is viewed to be very limited. The flow velocity and depth at the various outlets will have to be confirmed during the detailed design stage. The average velocity is in the order of 1.0 m/s for the gentle slopes (0.5%) of the site. Such flows will not cause any serious erosion, but appropriate measures should be implemented at outlets and points of concentration caused by drainage channels. This will reduce the risk of erosion damage. Frequent nominal drainage measures, typically piped culverts and/or mitre drains cut by a grader, must be provided at intervals between 200m to 300m as dictated by the site conditions and must

be taken care of in the detail design. These could also be in-situ formed drifts where the road alignment is close to the natural ground level.

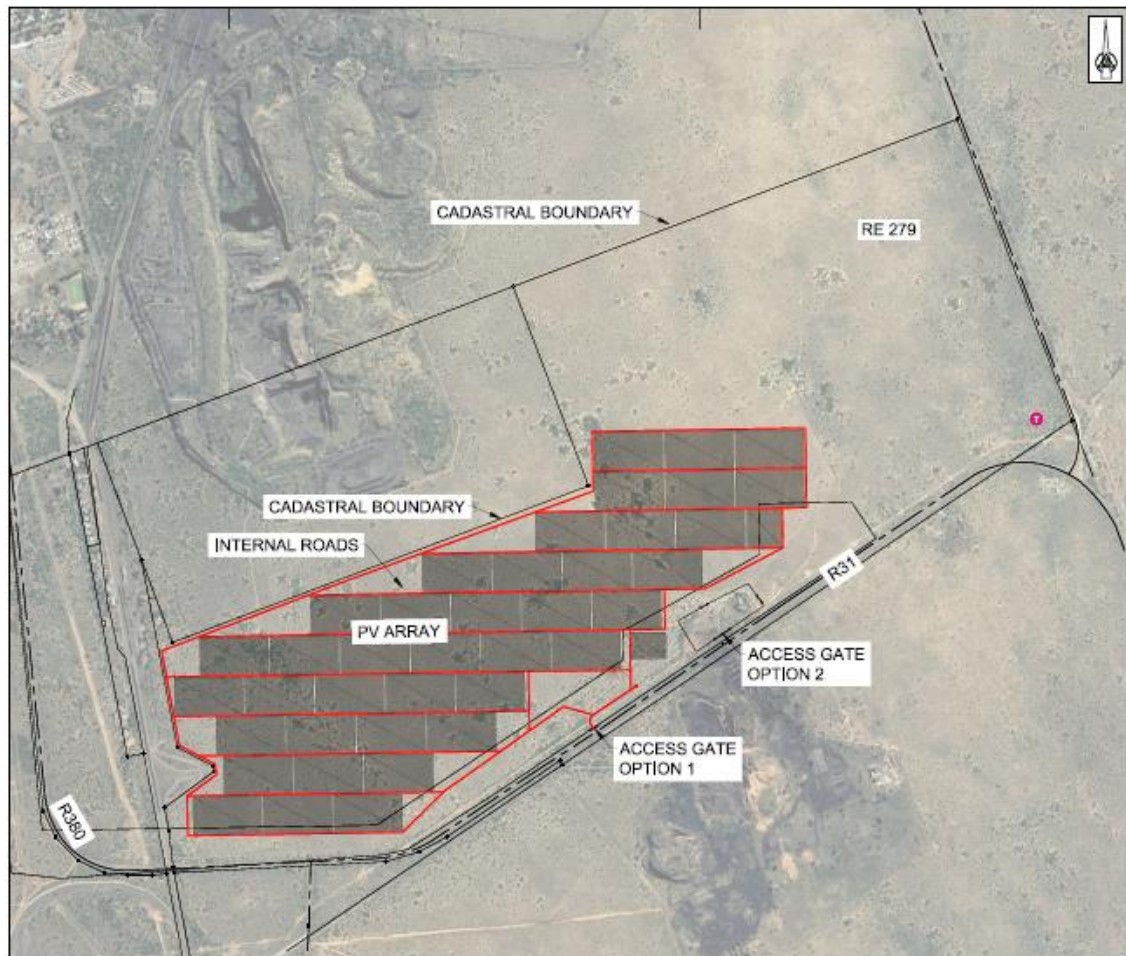

**Figure 4.3:** Access Roads

## 5. PROPOSALS FOR STORMWATER MANAGEMENT

The existing drainage patterns and characteristics should be preserved as far as possible. It is therefore suggested that the existing contours and vegetation be retained and that the internal roads are designed and constructed to minimum standards. The runoff calculations indicate that an additional 3.3 m<sup>3</sup>/s or roughly a 8.4% increase in peak runoff will have to be accommodated when designing the stormwater management measures.

Drainage structures would include smaller diameter pipes (encased in concrete because of the low fill anticipated) or preferably gravel or concrete drifts. These drifts should have cut-off walls on the down-stream side as a minimum requirement.

## 5.1. Side Drains

Open drains will be provided along the proposed internal roads or between PV panels. These drains would be gravel drains with concrete or edge beam protection at road crossings, where required.

## 5.2. Berms

Berms are proposed to prevent external stormwater from entering the PV area and for directing flow to suitable areas of release; see *Figure 5.1* for typical berm details. Cut off drains are proposed on the southern property boundary to reduce runoff from the larger catchment area (see Fig 3.3).

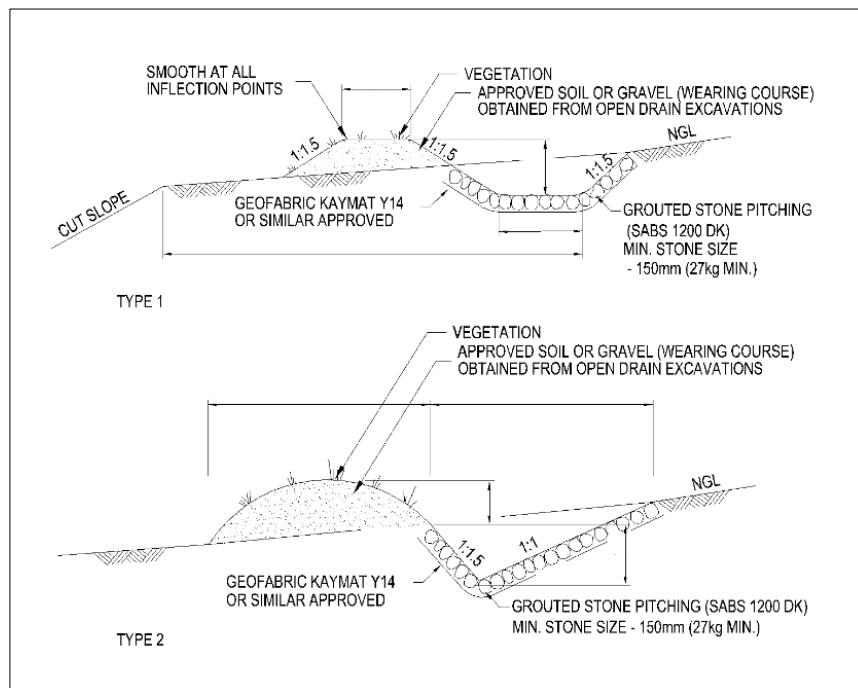

**Figure 5.1:** Typical Berm Detail

## 5.3. Outlets

All culverts on the access roads must be provided with concrete outlets with erosion protection. Side drain outlets should be terminated with suitable erosion protection to reduce the velocity and the flow depth.

## 6. EROSION PROTECTION MEASURES

The volume and velocity of the stormwater runoff must be thoroughly evaluated during the detailed design phase. The following erosion protection measures should be considered:

- Side drains, see *Figures 6.1 and 6.2*
- Inlet and outlet structures, see *Figures 6.3 and 6.4*

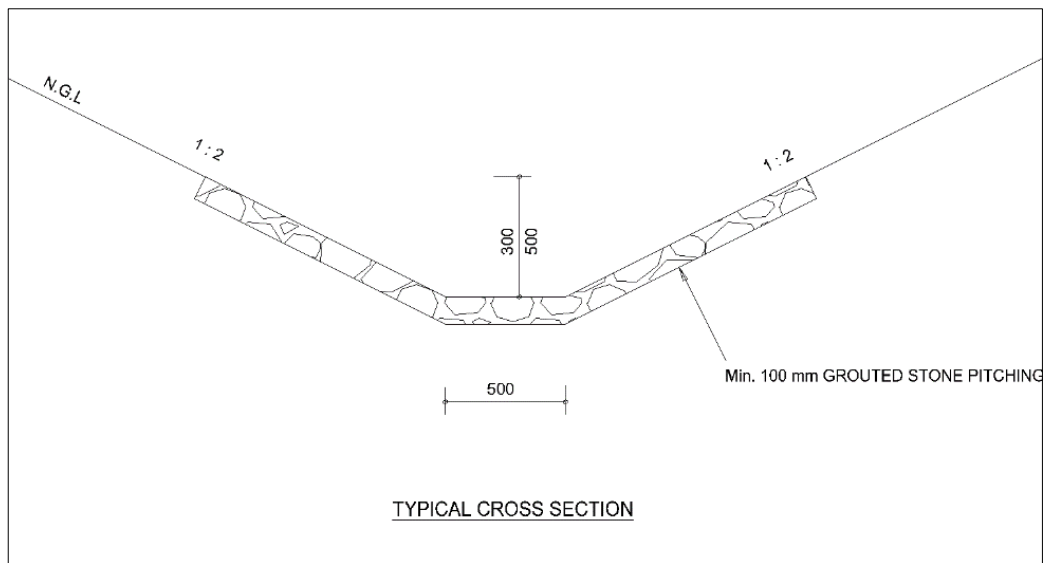

**Figure 6.1:** Typical Stone Pitched Side Drain

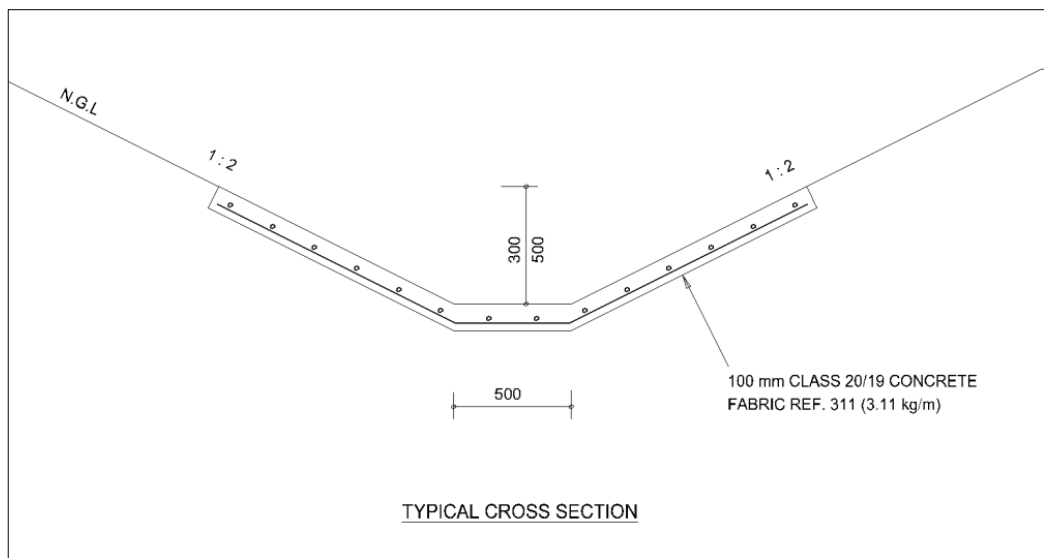

**Figure 6.2:** Typical Concrete Lined Side Drain

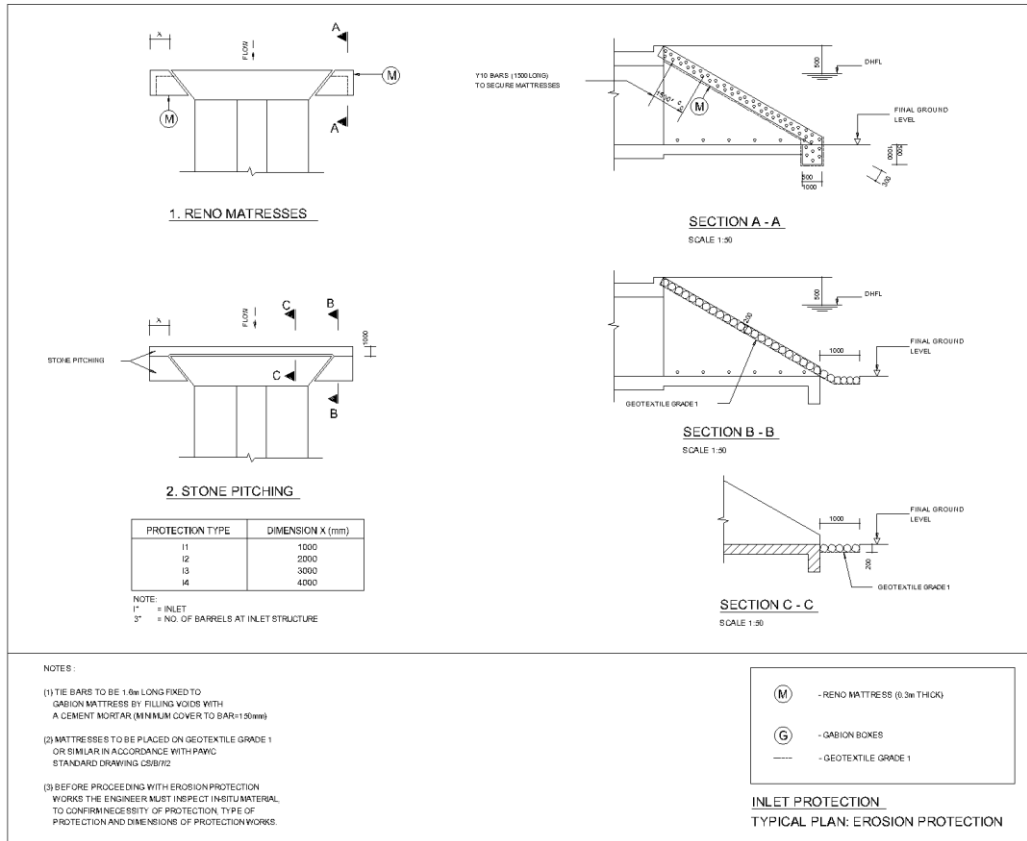

**Figure 6.3:** Typical inlet erosion protection measures

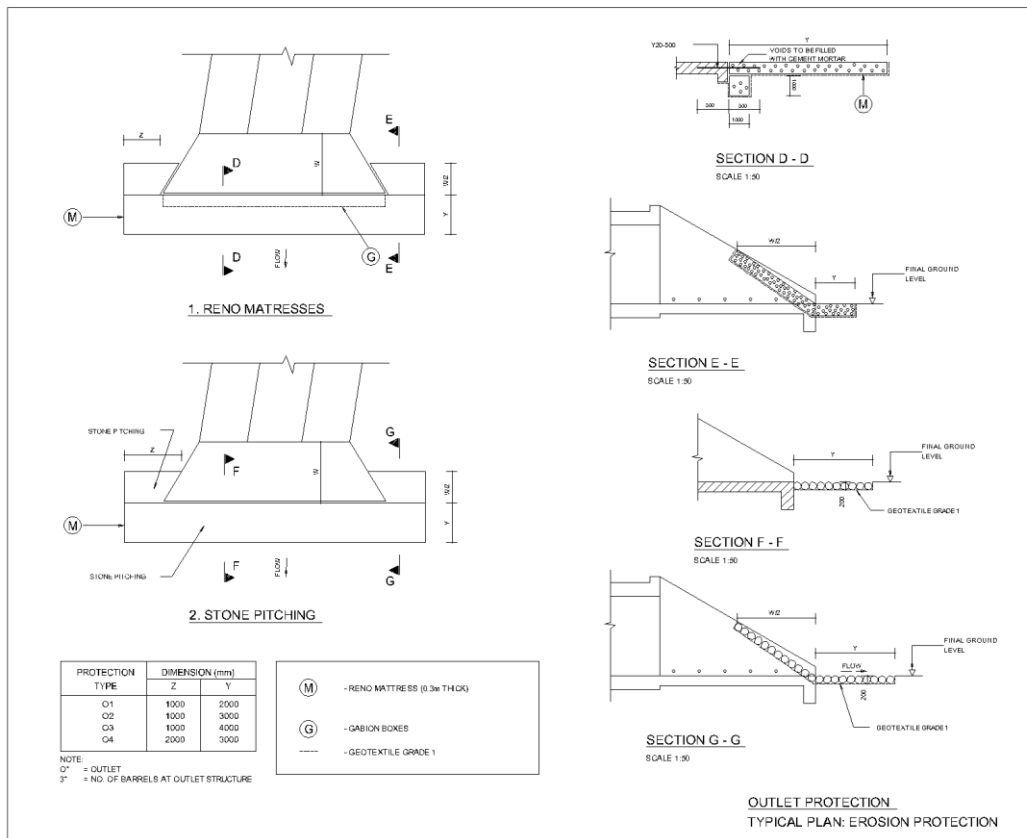

**Figure 6.4:** Typical outlet erosion protection measures

It is envisaged that in combination with the above the following are also likely to be required:

- Stone masonry walls to reduce the flow velocity in steep areas;
- Side Drain Outlets with stone pitching to prevent erosion; and
- Temporary berms and straw bales during construction should streams be identified, to reduce flow and sediment transport during this phase.

During the construction phase, special attention must be given to stormwater so that construction activities do not result in any water ponding, especially in the vicinity of the roads and structures.

## **7. WASTE WATER MANAGEMENT**

Several mines in the area are located to the north-west, south-west and south of the Hotazel Solar site. Venturing closer to these mining areas will expose the PV energy facility to increased dust levels, thus reducing the efficiency of the solar PV modules. After the installation of the panels, the cleaning (washing) of the solar panels is likely to generate small amounts of additional runoff. This process is estimated to occur twice a year and add approximately 1l/m<sup>2</sup> of additional runoff to the site, over a period of approximately 2 weeks. This runoff would however be spread throughout the site, and due to the low localised water volumes would cause minimal, if any, erosion on the site and may even help as a form of dust control. The methods used for washing the panels determine the mitigation measures to be applied. This could be in the form of phasing the washing of panels or optimising the methods used. The overall effect on the site is expected to be very low, provided the cleaning water is free from detergents and includes only approved bio-degradable substances.

Rain will also aid in keeping the PV panels clean. The solar module surfaces are installed at a relatively large incline with gaps between modules. This does not allow significant water build up on the modules while also reducing the energy generated by the falling rain droplets.

On large structures or buildings, appropriate guttering could be used around the building to avoid water erosion caused by roof water flowing off the roof. Wherever practically possible, stormwater run-off from the gutter/roofs should be captured and stored in rainwater tanks. If this water cannot be captured, water should be channelled into energy dissipating structures to spread the water and slow it down to reduce risk of erosion. Such structures could be constructed from precast concrete, loosely packed rock or perforated bags filled with stone.

## 8. CONCLUSIONS AND RECOMMENDATIONS

The additional stormwater runoff generated from the new facility post-development is almost negligible compared to pre-development. It is therefore envisaged that limited stormwater management will be required to reduce the impact of the proposed development on the environment.

By implementing earth drains, lined drains and limited erosion protection structures, the stormwater on the site can easily be accommodated in a safe and non-destructive manner. The development of the site should also be done in accordance with the existing slopes. The contours should be followed closely in order to minimise impacts on the existing drainage patterns.

## 9. REFERENCES

- Various Municipal Management of Urban Stormwater Impacts Policies
- The Georgia Stormwater Management Manual
- The South African National Roads Agency Limited. (2006). Drainage Manual Fully Revised 5th Edition
- Adamson P.T. (1983). Technical Report TR 102. Southern African Storm Rainfall
- Cape Environmental assessment Practitioners: Hotazel Solar, Final Scoping report, September 2018



## 10. ANNEXURES

### Annexure A: Pre-Development Runoff Calculations

#### Flood Frequency Analysis: Rational Method

Project = HATAZEL SOLAR  
 Analysed by = RdV  
 Name of river = N/A  
 Description of site = RE OF FARM YORK A 279 : PRE-DEVELOPED  
 Date = 2020/04/23  
 Area of catchment = 18.3 km<sup>2</sup>  
 Dolomitic area = 0.0 %  
 Mean annual rainfall (MAR) = 326.00 mm  
 Length of longest watercourse = 7.0 km  
 Flow of water = Overland flow  
 Height difference = 19.0 m  
 Value of r for over land flow = Clean soil (r=0,1)  
 Rainfall region = Inland  
 Area distribution = Rural: 100 %, Urban: 0 %, Lakes: 0 %

#### Catchment description - Urban area (%)

Lawns	Residential and industry	Business
Sandy, flat (<2%) 0	Houses 0	City centre 0
Sandy, steep (>7%) 0	Flats 0	Suburban 0
Heavy soil, flat (<2%) 0	Light industry 0	Streets 0
Heavy soil, steep (>7%) 0	Heavy industry 0	Maximum flood 0

#### Catchment description - Rural area (%)

Surface slopes	Permeability	Vegetation
Lakes and pans 0	Very permeable 0	Thick bush & forests 0
Flat area 80	Permeable 80	Light bush & cultivated land 30
Hilly 20	Semi-permeable 20	Grasslands 70
Steep areas 0	Impermeable 0	Bare 0

-----  
 Average slope = 0.00271 m/m  
 Time of concentration = 2.03 h  
 Run-off factor  
 Rural - C1 = 0.284  
 Urban - C2 = 0.000  
 Lakes - C3 = 0.000  
 Combined - C = 0.284

The HRU, Report 2/78, Depth-Duration-Frequency diagram was used to determine the point rainfall.

Return Period (years)	Time of concentration (hours)	Point rainfall (mm)	ARF (%)	Average intensity (mm/h)	Factor Ft	Runoff coefficient (%)	Peak flow (m <sup>3</sup> /s)
1:20	2.03	45.1	98.4	21.9	0.90	25.6	28.41
1:50	2.03	58.7	98.0	28.3	0.95	27.0	38.79
1:100	2.03	72.2	97.5	34.6	1.00	28.4	50.02

Run-off coefficient percentage includes adjustment saturation factors (Ft) for steep and impermeable catchments

Calculated using Utility Programs for Drainage 1.1.0

## Annexure B: Post-Development Runoff Calculations

### Flood Frequency Analysis: Rational Method

Project = HATAZEL SOLAR  
 Analysed by = RdV  
 Name of river = N/A  
 Description of site = RE OF FARM YORK A 279 : POST-DEVELOPED  
 Date = 2020/04/23  
 Area of catchment = 18.3 km<sup>2</sup>  
 Dolomitic area = 0.0 %  
 Mean annual rainfall (MAR) = 326.00 mm  
 Length of longest watercourse = 7.0 km  
 Flow of water = Overland flow  
 Height difference = 19.0 m  
 Value of r for over land flow = Clean soil (r=0,1)  
 Rainfall region = Inland  
 Area distribution = Rural: 100 %, Urban: 0 %, Lakes: 0 %

#### Catchment description - Urban area (%)

Lawns		Residential and industry		Business	
Sandy, flat (<2%)	0	Houses	0	City centre	0
Sandy, steep (>7%)	0	Flats	0	Suburban	0
Heavy soil, flat (<2%)	0	Light industry	0	Streets	0
Heavy soil, steep (>7%)	0	Heavy industry	0	Maximum flood	0

#### Catchment description - Rural area (%)

Surface slopes		Permeability		Vegetation	
Lakes and pans	0	Very permeable	0	Thick bush & forests	0
Flat area	80	Permeable	75	Light bush & cultivated land	30
Hilly	20	Semi-permeable	20	Grasslands	50
Steep areas	0	Impermeable	5	Bare	20

Average slope = 0.00271 m/m

Time of concentration = 2.03 h

Run-off factor

Rural - C1 = 0.310

Urban - C2 = 0.000

Lakes - C3 = 0.000

Combined - C = 0.310

The HRU, Report 2/78, Depth-Duration-Frequency diagram was used to determine the point rainfall.

Return Period (years)	Time of concentration (hours)	Point rainfall (mm)	ARF (%)	Average intensity (mm/h)	Factor Ft	Runoff coefficient (%)	Peak flow (m <sup>3</sup> /s)
1:20	2.03	45.1	98.4	21.9	0.90	27.9	30.96
1:50	2.03	58.7	98.0	28.3	0.95	29.4	42.28
1:100	2.03	72.2	97.5	34.6	1.00	31.0	54.51

Run-off coefficient percentage includes adjustment saturation factors (Ft) for steep and impermeable catchments

Calculated using Utility Programs for Drainage 1.1.0