

Stormwater Management Plan for Soyuz 4 Wind Energy Facility

Report Prepared for

Soyuz 4 (Pty) Ltd



Report Prepared by

The logo for srk consulting, featuring a stylized orange 's' icon followed by the text 'srk consulting' in a grey sans-serif font.

March 2023

Stormwater Management Plan for Soyuz 4 Wind Energy Facility

Soyuz 4 (Pty) Ltd

14th Floor Pier Place, Heerengracht Street,
Foreshore, Cape Town, Western Cape, 8001
South Africa

SRK Consulting (South Africa) (Pty) Ltd.

SRK House
265 Oxford Road
Illovo 2198
Johannesburg
South Africa

Tel: +27 (0) 11 441 1111
Fax: +27 (0) 11 880 8086

e-mail: johannesburg@srk.co.za
website: www.srk.co.za

SRK Project Number 590608
March 2023

Compiled by:

Jennifer Meneghelli
Senior Civil Engineer

Email: jmeneghelli@srk.co.za

Authors:

Seabelo Seroalo; Jennifer Meneghelli

Peer Reviewed by:

Jeandre Thompson
Senior Civil Engineer

Executive Summary

The applicant Soyuz 4 (Pty) Ltd is proposing the development of a commercial Wind Energy Facility (WEF) and associated infrastructure on a site located approximately 22 km South of Britstown within the Emthanjeni Local Municipality and the Pixley ka Seme District Municipality in the Northern Cape Province.

This report documents the Surface Water Specialist Study required for the proposed development. The study aims to facilitate the protection of surface water resources and covers the total proposed project development area. This report serves to support the Environmental Impact Assessment (EIA) process and has been completed in accordance with Appendix 6 of the EIA regulations for specialist reports.

The proposed Soyuz 4 WEF has no identifiable permanent surface water resources. All the stormwater impacts that exist can be managed in a practical and cost-effective manner on site. The moderate to low rainfall and low gradients of the area suggest that the Detailed Design should not vary significantly from the management concepts presented in the report.

The Stormwater Management Plan (SWMP) was created considering the findings from the analysis undertaken as part of this study and presented in this report but should be developed further for Detailed Design by conducting a detailed topographic survey and developing the stormwater layout on the information available and infrastructure layout. The conceptual designs should be developed to Detailed Design, and the final plans should incorporate any environmental specifications required during construction and operation of the facility.

It is recommended that the Soyuz 4 WEF be authorised as the surface water impacts are minimal and the predicted level of change is acceptable. To avoid, manage and mitigate surface water impacts, the interventions in the SWMP should be included in the Environmental Management Program (EMPr) for the activity for both construction and operation phases.

Table of Contents

1	Introduction	1
1.1	Aims and Objectives	1
1.2	Scope of Work.....	1
1.3	Assumptions, Limitations and Exclusions	1
2	Methodology	4
2.1	Site visit.....	4
2.2	Information gathering and review.....	4
2.3	Hydrological baseline assessment.....	4
2.4	Stormwater Management Plan	4
2.5	Reporting.....	4
3	Supporting Information.....	5
3.1	Project Background.....	5
3.2	Site Observations.....	6
3.3	Legislation and Guidelines.....	9
3.4	Natural Conditions.....	9
3.4.1	Climate	9
3.4.2	Topography	9
4	Hydrological Baseline Assessment.....	10
4.1	Regional Drainage	10
4.2	Rainfall	10
4.3	Evaporation	13
5	Soyuz 4 WEF Sub-catchments	13
5.1	Delineation of Sub-catchments	13
5.2	Catchment Parameters	14
5.3	Storm Peaks.....	16
6	Conceptual SWMP.....	17
6.1	Design Criteria and Project Objectives	17
6.2	Delineation of Clean and Dirty Areas.....	17
6.3	SWMP Design Philosophy for a WEF.....	18
6.4	Site Specific Considerations	19
6.4.1	Site Description	19
6.4.2	Positioning of Turbines.....	19
6.4.3	Access Roads	19
6.5	SWMP for Wind Turbine Footprint.....	19
6.5.1	Construction Phase.....	19
6.5.2	Operational Phase.....	20
6.6	SWMP for Access Roads.....	22

6.7 SWMP for Substation and Auxiliary Buildings22

7 Waste and Wastewater Management.....28

8 Erosion and Sediment Transport.....28

9 SWMP Monitoring and Management.....28

10 Surface Water Findings, Impacts and Mitigations.....29

11 Conclusion and Recommendations.....34

References37

List of Tables

Table 4-1 Quaternary catchments over WEF cluster area (WR2012)	10
Table 4-2 Six nearest SAWS to cluster area centroid	11
Table 4-3 Design rainfall data for the site, interpolated from the six closest SAWS	11
Table 4-4 Average Monthly Evaporation (mm) (WR2012)	13
Table 5-1 Conceptual Catchment Characteristics	14
Table 5-2 Peak Flows for Conceptual Catchments in cubic metres per second	16
Table 10-1 Construction and Operations / Maintenance SWMP	30

List of Figures

Figure 1-1 Soyuz 4 Wind Energy Facility Layout Plan and Locality	3
Figure 4-1 Regional Drainage	12
Figure 4-2 Monthly rainfall and evaporation	13
Figure 5-1 Soyuz 4 Wind Energy Facility Sub-Catchments	15
Figure 6-1 Soyuz 4 Wind Energy Facility Site Drainage	21
Figure 6-2 Typical Conceptual Designs of Stormwater Infrastructure	23

Disclaimer

The opinions expressed in this Report have been based on the information supplied to SRK Consulting (South Africa) (Pty) Ltd (SRK) by Soyuz 4 (Pty) Ltd. The opinions in this Report are provided in response to a specific request from the Applicant to do so. SRK has exercised all due care in reviewing the supplied information. Whilst SRK has compared key supplied data with expected values, the accuracy of the results and conclusions from the review are entirely reliant on the accuracy and completeness of the supplied data. SRK does not accept responsibility for any errors or omissions in the supplied information and does not accept any consequential liability arising from commercial decisions or actions resulting from them. Opinions presented in this report apply to the site conditions and features as they existed at the time of SRK's investigations, and those reasonably foreseeable. These opinions do not necessarily apply to conditions and features that may arise after the date of this Report, about which SRK had no prior knowledge nor had the opportunity to evaluate.

1 Introduction

SRK Consulting (South Africa) (Pty) Ltd (SRK) was approached by Soyuz 4 (Pty) Ltd (the Applicant) to develop a Stormwater Management Plan (SWMP) for the proposed development of a commercial Wind Energy Facility (WEF), known as the Soyuz 4 WEF. The proposed site is located 22 km South of Britstown within the Emthanjeni Local Municipality and the Pixley ka Seme District Municipality in the Northern Cape Province. The layout of the development area is shown in Figure 1-1.

The SWMP will inform the Environmental Management Programme (EMPr) for the Environmental Impact Assessment (EIA) application to the Department of Forestry, Fisheries, and the Environment (DFFE). This report has been developed in compliance with Appendix 6 of the National Environmental Management Act (NEMA) (Act 107 of 1998) EIA regulations.

1.1 Aims and Objectives

The aim of this report is firstly to protect surface water resources in accordance with the National Water Act (NWA) (Act 36 of 1998) and secondly to minimise impacts to the natural hydrology of the region by the proposed development by applying appropriate environmental management tools (NEMA).

The objective of this report is to design a conceptual SWMP that protects surface water resources, manages erosion risks, and complies with the relevant regulations and guidelines (listed in Section 2.2) for the construction and operation phases of the Soyuz 4 WEF.

1.2 Scope of Work

The scope of work of this project as per the Applicant's Request for Quotation (RFQ) (4th August 2022) includes but is not limited to the following:

- Review available Geographical Information Systems (GIS) data and undertake site visit to identify and verify areas of interest;
- Review Soyuz 1 WEF layout as supplied by the Applicant;
- Provide recommendations and management / design criteria for the construction and operational phases of the project in consideration of:
 - Risks to watercourses;
 - Presence of natural and proposed drainage systems;
 - Surface flow across the site during low and high rainfall events;
 - Storage requirements for potentially hazardous substances;
 - General stormwater management of the site and pollution mitigation and management;
 - Erosion control; and
 - Provide input to responses raised by stakeholders relating to stormwater concerns.

The SWMP is a conceptual study at this stage, and a detailed survey and SWMP study will need to be undertaken during the design of the required infrastructure.

1.3 Assumptions, Limitations and Exclusions

Completion of the project will be based on the following limitations and assumptions:

- Rainfall across the catchments is homogenous temporally and spatially and aligns with the readings generated using design rainfall;
- Data obtained from site-specific literature, and previous and other professional investigations will be assumed to be valid and true;
- Publicly available topographical data have been used;

- River crossings identification or design is excluded;
- Floodlines are excluded; and
- Any detailed design and engineering drawings are excluded.

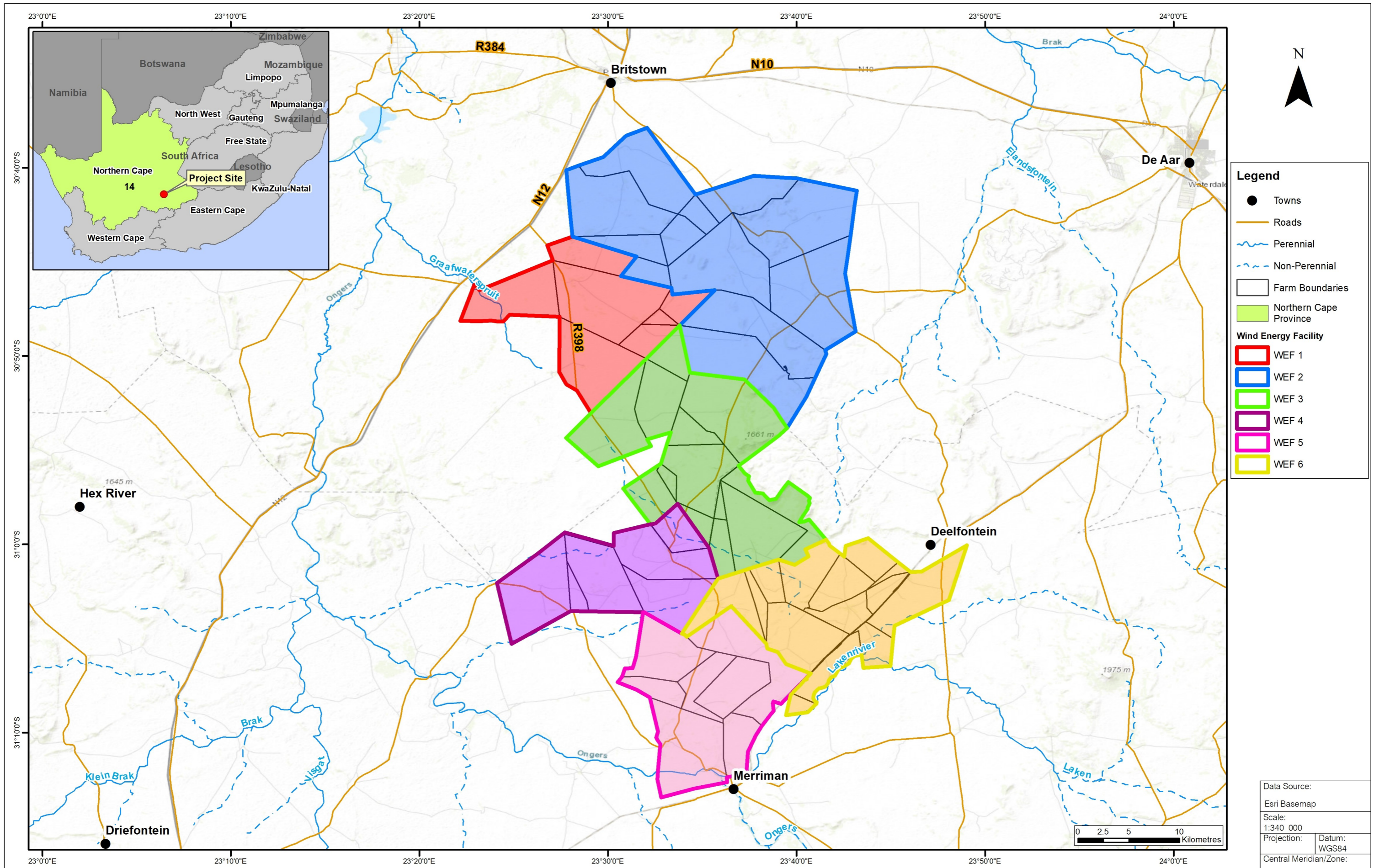

Data Source:	
Esri Basemap	
Scale: 1:340 000	
Projection:	Datum: WGS84
Central Meridian/Zone:	
Date:	Compiled by:
19/10/2022	LEKT
Project No:	Fig No:
590608	
Revision: B	Date: 07 02 2023

2 Methodology

The following methodology was proposed to meet the scope of work.

2.1 Site visit

The site visit was conducted at the onset of the project to supplement the desktop gathered data, for the site, that will be used in this study. The day-long site visit was conducted to assess the conditions in the catchment, as well as drainage conditions on-site.

Observations of the vegetation, relevant drainage features, land use as well as infrastructure within the catchment were made to characterise the catchment conditions and how the conditions impact the run-off in the catchment.

The site visit was carried out on 29th September 2022. This is at the end of the dry season for the Northern Cape area. The relevance of the season does not impact the findings of this assessment. However, it did confirm that rivers and drainage lines on the site are non-perennial as no flow was observed during the site visit.

2.2 Information gathering and review

A thorough investigation of all available literature for the site was reviewed. This included the following:

- Meteorological data for the site such as rainfall, runoff and evaporation;
- Academic studies of the hydrology of the site;
- Acquirement of any existing topographical survey data of the site;
- The preliminary layout of the Soyuz 4 WEF was studied and assessed; and
- National legislation applicable to the project was obtained and reviewed.

2.3 Hydrological baseline assessment

The hydrological baseline assessment makes provision for the observations made during the site assessment as well as considering the following aspects:

- Climate and hydrometeorological analysis for the area;
- Delineation of the sub-catchments up to immediately downstream of the site;
- Determination of the Mean Annual Precipitation (MAP), Mean Annual Runoff (MAR) and Mean Annual Evaporation (MAE) from historical rainfall records from South African Weather Stations (SAWS) and the Water Resources Study of South Africa 2012 (Pitman and Bailey, 2015); and
- Calculation of the design rainfall depths for various return periods and event durations.

2.4 Stormwater Management Plan

A conceptual stormwater management plan (SWMP) (this document) was developed to manage surface runoff flows from the wind turbines and linear infrastructure. Guidelines and policy for the design of stormwater drainage and stormwater management were obtained from GN 704 (1999) and Best Practice Guidelines G1 (DWAf, 2006). Topographical survey data was used to model the stormwater drainage network.

2.5 Reporting

The findings of the application of the methodologies provided above are detailed in this report highlighting the key aspects as required in the scope of works.

3 Supporting Information

This section summarises all available information and assumptions upon which the derivation of the SWMP is based. This is done to highlight how the plan was developed: by matching regulations and guidelines to the specific needs of the project in the local natural conditions. The available information is therefore key to understanding the SWMP.

3.1 Project Background

The applicant Soyuz 4 (Pty) Ltd is proposing the development of a commercial Wind Energy Facility (WEF) and associated infrastructure on a site located approximately 46 km South of Britstown within the Ubuntu Local Municipality and the Pixley ka Seme District Municipality in the Northern Cape Province.

Five additional WEF's are concurrently being considered on the surrounding properties and are assessed by way of separate impact assessment processes contained in the 2014 Environmental Impact Assessment Regulations (GN No. R982, as amended) for listed activities contained in Listing Notices 1, 2 and 3 (GN R983, R984 and R985, as amended). These projects are known as Soyuz 1 WEF, Soyuz 2 WEF, Soyuz 3 WEF, Soyuz 5 WEF and Soyuz 6 WEF.

A preferred project site with an extent of approximately 125 000 ha has been identified as a technically suitable area for the development of the six WEF projects. It is proposed that each WEF will comprise of up to 75 turbines with a contracted capacity of up to 480 MW. It is anticipated that each WEF will have an actual (permanent) footprint of up to 150 ha.

The Soyuz 4 WEF project site covers approximately 14 200 ha and comprises the following farm portions:

- The Farm Altringham No. 19
- The Farm No. 18
- Remaining Extent of the Farm Allemans Dam No. 17
- Remaining Extent (Portion 0) of the Farm Allemans Combuis No. 1
- Remaining Extent of Portion 1 of the Farm Combuisfontein No. 142
- Portion 1 of the Farm Allemans Dam No. 17.

The Soyuz 4 WEF project site is proposed to accommodate the following infrastructure, which will enable the wind farm to supply a contracted capacity of up to 480 MW:

- Up to 75 wind turbines with a maximum hub height of up to 160 m and a rotor diameter of up to 200 m;
- A transformer at the base of each turbine;
- Concrete turbine foundations of up to 1024 m² each;
- Permanent Crane hardstand / blade and tower laydown area / crane boom erection area with a combined maximum footprint 5000 m² at each WTG;
- Temporary concrete batch plants to be located at the construction camp area and the satellite laydown areas;
- Battery Energy Storage System (with a footprint of up to 5 ha);
- Internal up to 132 kV overhead lines between substations. A 300m wide corridor (150m on either side of the proposed route) has been considered to allow for any technical and environmental sensitivity constraints identified during micro-siting prior to layout finalisation. Permanent service roads will be required for the construction and maintenance of the overhead lines. In areas where these overhead lines do not follow an existing or proposed road, additional roads of up to 3m in width will be required. Temporary construction areas beneath each overhead line tower position will also be required;

- Medium voltage (33 kV) cables/powerlines running from wind turbines to the facility substations. The routing will follow existing/proposed access roads and will be buried where possible. If the use of overhead lines is required, the Avifaunal Specialist will be consulted timeously to ensure that a raptor friendly pole design are used, and that appropriate mitigation is implemented pro-actively.
- Up to six permanent met masts;
- Three substations and operation and maintenance facilities (up to 4 ha each) as well as a laydown area (8 000 m²) at each substation for the electrical contractor. Operation and maintenance facilities include a gate house, security building, control centre, offices, warehouses and workshops.
- Three temporary main construction camp areas (up to 12.25 ha each);
- Twelve temporary satellite laydown areas (5 000 m² each).
- Access roads to the site and between project components inclusive of stormwater infrastructure. A 200 m road corridor is being applied for to allow for slight realignments pending technical and environmental sensitivity constraints identified during micro-siting prior to layout finalisation. The final road will have maximum width of 12 m (within the 200 m corridor).

3.2 Site Observations

The Soyuz 4 WEF site was visited by S. Seroalo from SRK Consulting on 29 September 2022. The site terrain was relatively flat with areas of rocky outcrops along the ridges and wide flat areas between. Visible erosion was minimal due to the relatively flat site area. On steeper slopes, erosion was evident on both the R398 gravel road and the berms located on several farms. Sediment wash was evident along the sides of the roads between the different farm sites.

The site's soil is predominantly fine sand with silt. Permeability of the soil on the site area was visually assessed to be semi-permeable to permeable. Judgement erred on the conservative side to ensure that runoff flows were not underestimated for SWMP design purposes. The site has minor drainage lines draining towards the northwesterly direction as well as drainage lines running along sections of the R398 road. No streamflow was observed in any of the drainage lines indicating that these streams are perennial and do not flow in the dry season (when the site visit was carried out). The profile of the channels were relatively shallow and with a depth of less than 500 mm observed and would measure a width of approximately 2 m in most cases. Sediment wash was present in the drainage lines with light shrub found along sections of the drainage lines. As the site has three main rivers, Ongers, Graafwaterspruit and Elandsfontein, the drainage lines will flow towards the rivers tributaries of their respective sub-catchments. The vegetation was observed to be dense, consisting of shrubs and grasses along the site areas, which are also sufficient for animal grazing. Denser vegetation can be found along sections of the drainage lines. A photographic record of the site is shown below.



Photo 3-1 The grassed, flat plains dominating the landscape



Photo 3-2 Rocky outcrops rise steeply above the plains in some areas



Photo 3-3 Typical sand on the site

3.3 Legislation and Guidelines

SWMPs are generally required to support the EMP and Water Use License Applications (WULA). The following was considered when compiling the SWMP:

- Best Practice Guideline G1 for Stormwater Management (Department Water Affairs and Forestry (DWAFF), 2006);
- Regulation 704 of the National Water Act (Department of Water Affairs and Forestry, 4 June 1999).

Municipal regulations, which may introduce specific standards for each municipality, but still adhere to the overall principles of the regulations and guidelines above, should be considered during Detailed Design (if relevant).

The International Finance Corporation (IFC) Performance Standards on Environmental and Social Sustainability (2012) were taken into consideration in the development of this report. A review of the standards revealed that they are prevalent for impacts affecting communities. As the hydrological risks do not affect any communities in this study, the standards were found to not be directly applicable.

3.4 Natural Conditions

3.4.1 Climate

The development lies in a semi-arid climatic region with a mean annual precipitation (MAP) of 286 mm per year. The average MAP for South Africa is 450 mm (Botai, Botai, & Adeola, 2018). In comparison, the site has a much lower rainfall than the average for South Africa, indicating that this is a dry region. The daytime temperature in the Britstown region varies with a high of 31.2 degrees Celsius in January and drops to a low of 25.2 degrees Celsius in June. There are extreme temperature variances between the day and night.

The (Commission, 2012) Climate Classification (Kottek, Grieser, Beck, Rudolf, & Rubel, 2006) divides the climates into five categories: tropical, arid, temperate, continental, and polar. Based on the Koppen-Geiger Climate Classification the WEF cluster area falls into the semi-arid, desert climate. As the site is located in the interior of South Africa, the area can be further classified as a desert area.

3.4.2 Topography

The topography of the entire WEF cluster area has relatively gentle slopes starting from the NNW corner of the cluster to the SSE. The site elevation varies from a minimum of approximately 1035 to a maximum of 1570 meters above sea level (mamsl) over a distance of 29 km, stretching from the NNW corner to the NE side of the area. The area also includes rocky outcrops spread sparsely around the wide flat areas. A geological formation is situated in the eastern region of the WEF cluster which results in drainage of surface water to two larger catchments, with drainage to the NW of the cluster as well as drainage to the SE of the cluster.

The geological formation rises steeply out of the plains to a crest elevation of over 1550 mamsl. This makes it a high point in comparison to the surrounding plains of the cluster area. The total area of the WEF cluster is approximately 1225 km².

4 Hydrological Baseline Assessment

4.1 Regional Drainage

The site lies within the Lower Orange Water Management Area (WMA) and all rivers in this WMA flow into the Orange River, from where flow enters the Atlantic Ocean. As part of the analysis, the quaternary catchment data for the site was extracted from Water Research Commission 2012. The quaternary catchments are shown in Table 4-1, and their respective MAPs are summarized in Table 4-1. From Figure 4-1 the largest quaternary catchment is D61L, with three of the weather stations located in it.

Table 4-1 Quaternary catchments over WEF cluster area (WR2012)

Quaternary catchments over WEF cluster area	
Catchment	MAP
D61L	227
D62C	278
D61B	272
D61C	247
D62A	248

Three main rivers flow through the WEF footprint with tributaries originating from within the footprint. Tributaries to the western side of the area feed the Ongers and Graafwaterspruit Rivers and tributaries to the eastern side of the area feed the Elandsfontein River. Several of the tributaries cross the current R398 road as well as the smaller planned road for the cluster area.

4.2 Rainfall

An analysis of the rainfall data available for the site was undertaken to determine which dataset would best represent the site rainfall and whether each site should have individual rainfall parameters assigned or if rainfall should be assigned to represent the entire WEF cluster area.

The six nearest stations to the site were selected and the design rainfall for each rainfall was extracted from Design Rainfall Estimation software by Schulze and Smithers (Smithers & Schulze, 2002). The metadata for each rainfall station is provided in **Table 4-2**.

The average Mean Annual Precipitation (MAP) for all six weather stations located near the site is 270mm. The station with the lowest MAP is Nieuwejaarsfontein with a value of 247 mm. As quaternary catchment D61L covers a section of each WEF site, it would be deemed the most representative of the rainfall for the cluster. However, the MAP for quaternary catchment D61L is 227 mm as shown in Table 4-1, and is lower than the average MAP for the all the quaternary catchments assessed.

Analysing the data in Table 4-1 indicates that there is an increase in the MAP from the South to the North of the cluster area. The weather station located north of the cluster is Britstown with an MAP of 289 mm. The weather station south of the cluster is Dombiersfontien with an MAP of 236 mm.

Weather station Thomasgat and Lekkervlei lie in the middle of the WEF cluster area and have MAP values on the higher range of data collected for the analysis. For the purposes of the SWMP, the weather station with the higher rainfall data of the two was chosen, as a conservative approach and to ensure that drainage for the WEF is not undersized. The final chosen value for the rainfall station is

Thomasgat, with a MAP 286 mm and rainfall record of 88 year, which was deemed sufficient. The design rainfall to be used for the site is presented in Table 4-3.

Table 4-2 Six nearest SAWS to cluster area centroid

SAWS	Station Name	Record		Lat		Long		Dist.	MAP	Alt.
		Start/End	Years	Deg	Min	Deg	Min	km	mm	mamsl
0168800_W	Nieuwejaarsfontein		64	30	50	23	27	13.1	247	1158
0169005_W	Britstown (Pol)		99	30	35	23	30	35.0	289	1118
0169090_W	Thomasgat	1920 - 2009	80	31	0	23	33	12.0	286	1307
0142153_W	Lekkervlei		82	31	3	23	36	17.7	262	1295
0141664_W	Dombiersfontein		65	31	5	23	23	25.6	236	1207
0169509_W	Deelfontein		52	30	59	23	48	23.4	297	1386

Table 4-3 Design rainfall data for the site, interpolated from the six closest SAWS

Design Rainfall Data (mm)							
Mean annual rainfall	286	mm	Latitude	31	degrees	0	minutes
Altitude	1307	mamsl	Longitude	23	degrees	33	minutes
Storm duration	Return Period (Years)						
	2	5	10	20	50	100	200
5 minutes	6.9	9.8	11.8	13.9	16.7	18.9	21.3
15 minutes	12.2	17.3	20.8	24.5	29.4	33.4	37.5
1 hour	18.4	26	31.4	36.8	44.3	50.2	56.4
1.5 hour	20.8	29.3	35.3	41.5	49.9	56.6	63.5
2 hours	22.6	31.9	38.5	45.1	54.3	61.6	69.2
8 hours	31.2	44	53.1	62.2	74.9	84.9	95.4
24 hours	40.2	56.7	68.4	80.3	96.6	109.5	123
5 day	49.5	69.9	84.4	99	119	135	151.7

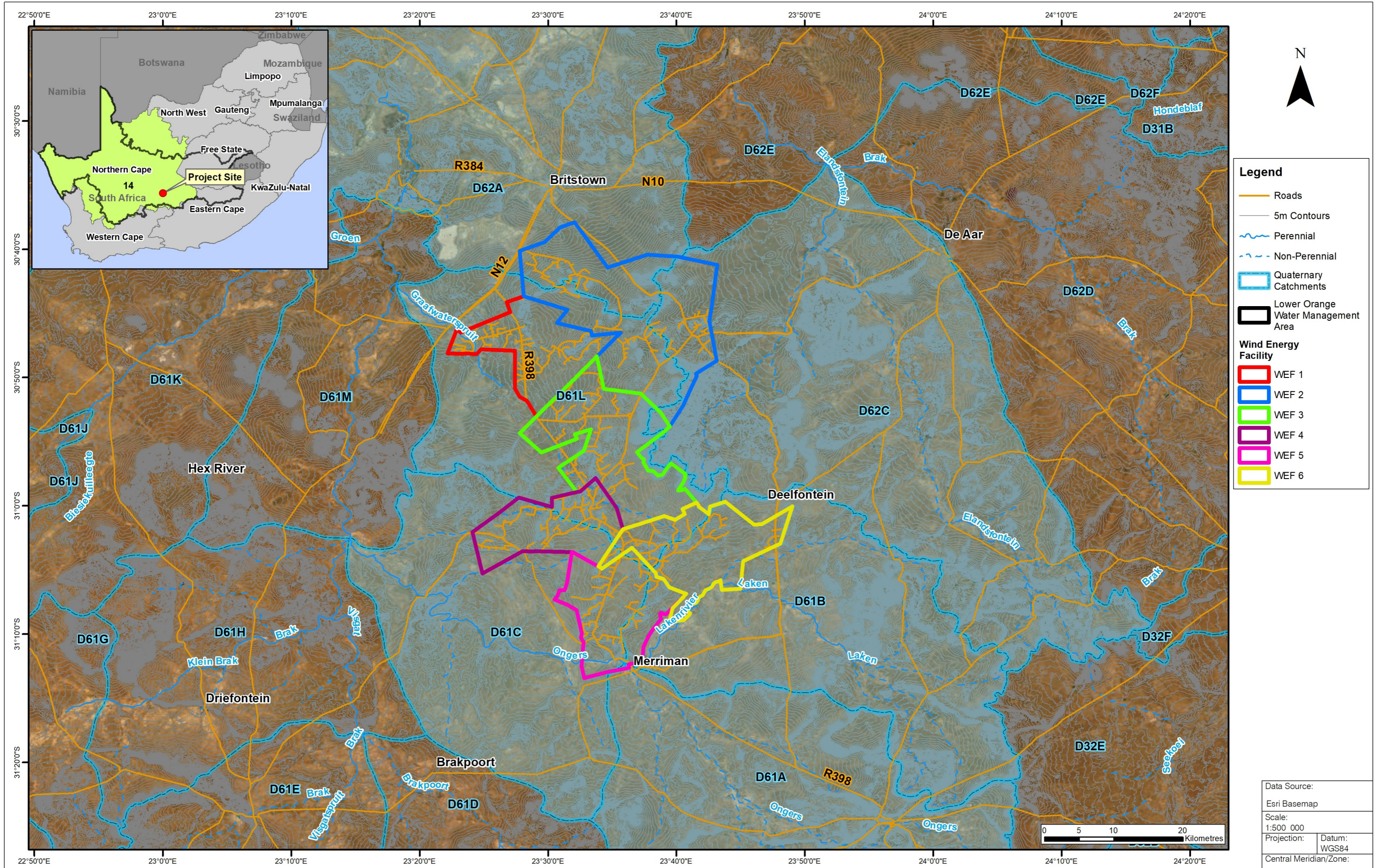

Data Source:	
Esri Basemap	
Scale: 1:500 000	
Projection:	Datum: WGS84
Central Meridian/Zone:	
Date:	Compiled by:
19/10/2022	LEKT
Project No:	Fig No:
590608	

4.3 Evaporation

The evaporation data for the site was extracted from the WRSM database (Bailey & Pitman, 2016). The site lies in the D61 area for evaporation. The average monthly results are provided in Table 4-4 below.

Table 4-4 Average Monthly Evaporation (mm) (WR2012)

Oct	Nov	Dec	Jan	Feb	Mar	Apr	May	Jun	Jul	Aug	Sep
214	261	307	303	224	187	124	87	63	71	106	154

In comparison to the rainfall (see Figure 4-2) the evaporation is significantly greater over the course of the year. This indicates that all precipitation is evaporated.

The evaporation varies throughout the year, with the highest evaporation in the area observed in the month of December and the lowest evaporation occurring in July.

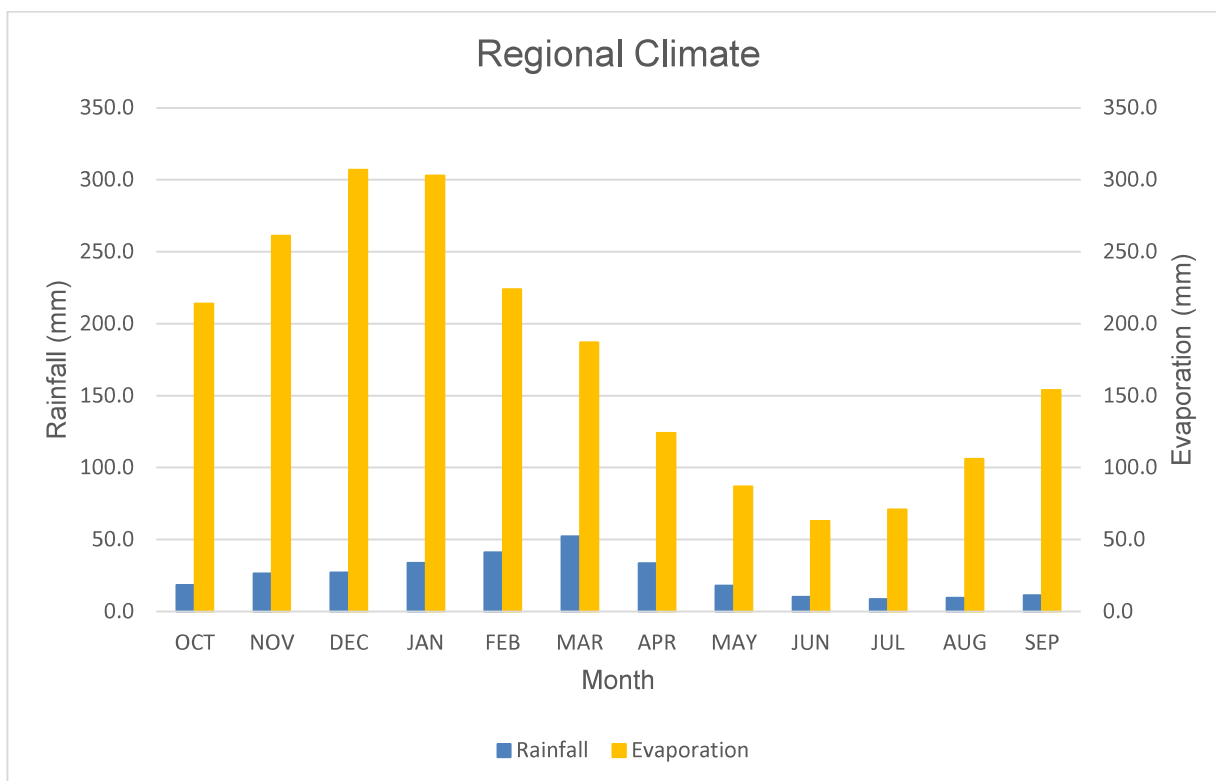

Figure 4-2 Monthly rainfall and evaporation

5 Soyuz 4 WEF Sub-catchments

5.1 Delineation of Sub-catchments

In order to delineate the catchments, a Digital Terrain Model (DTM) was created in order to use GIS techniques to determine these delineations and characterisation of the various catchments. No detailed survey information was available at the time of the study, so 20 metre and 5 metre contours (where available) were sourced from ngi.gov.za and compared to elevation data on Google Earth.

The catchments draining from the site were delineated. The outlet of the catchment was taken as the closest likely discharge point or closest mapped water course.

The catchments are as shown in Figure 5-1 below.

5.2 Catchment Parameters

The slope of a catchment is a very important characteristic in the determination of flood peaks. Steep slopes cause faster runoff shorten the critical duration of flood inducing storms, thus leading to higher rainfall intensities in the runoff formulae. On steep slopes, the vegetation is generally less dense, soil layers are shallower, and there are fewer depressions, all of which cause water to run off more rapidly. The result is that infiltration is reduced, and flood peaks are consequently elevated. For flat catchments such as those encountered on this site, the opposite holds true.

Land use is another critical characteristic as it alters the vegetation present and the degree of soil compaction. Compacted soil is less permeable, and vegetation can slow down stormflows over the land surface. Lastly, the soil type can also be important with some soils allowing quicker infiltration of water. These contribute to the estimation of volume of water stored, infiltrated and ultimately resulting in runoff for each catchment.

Table 5-1 presents the conceptual catchment characteristics used in this study.

Table 5-1 Conceptual Catchment Characteristics

Catchment	Catchment Slope (%)	Catchment Area (km ²)	Permeability (Visual assessment, not lab tested)	Flow type	Vegetation
Catchment A	0.35	1405	Permeable to Semi-Permeable	Overland Flow	Grasslands, Light Bush and farm-lands
Catchment B	0.35	291	Permeable to Semi-Permeable	Overland Flow	Grasslands, Light Bush and farm-lands
Catchment C	0.20	1577	Permeable to Semi-Permeable	Overland Flow	Grasslands, Light Bush and farm-lands
Catchment D	0.33	686	Permeable to Semi-Permeable	Overland Flow	Grasslands, Light Bush and farm-lands
Catchment E	0.30	924	Permeable to Semi-Permeable	Overland Flow	Grasslands, Light Bush and farm-lands
Catchment F	0.37	792	Permeable to Semi-Permeable	Overland Flow	Grasslands, Light Bush and farm-lands
Catchment G	0.30	1682	Permeable to Semi-Permeable	Overland Flow	Grasslands, Light Bush and farm-lands

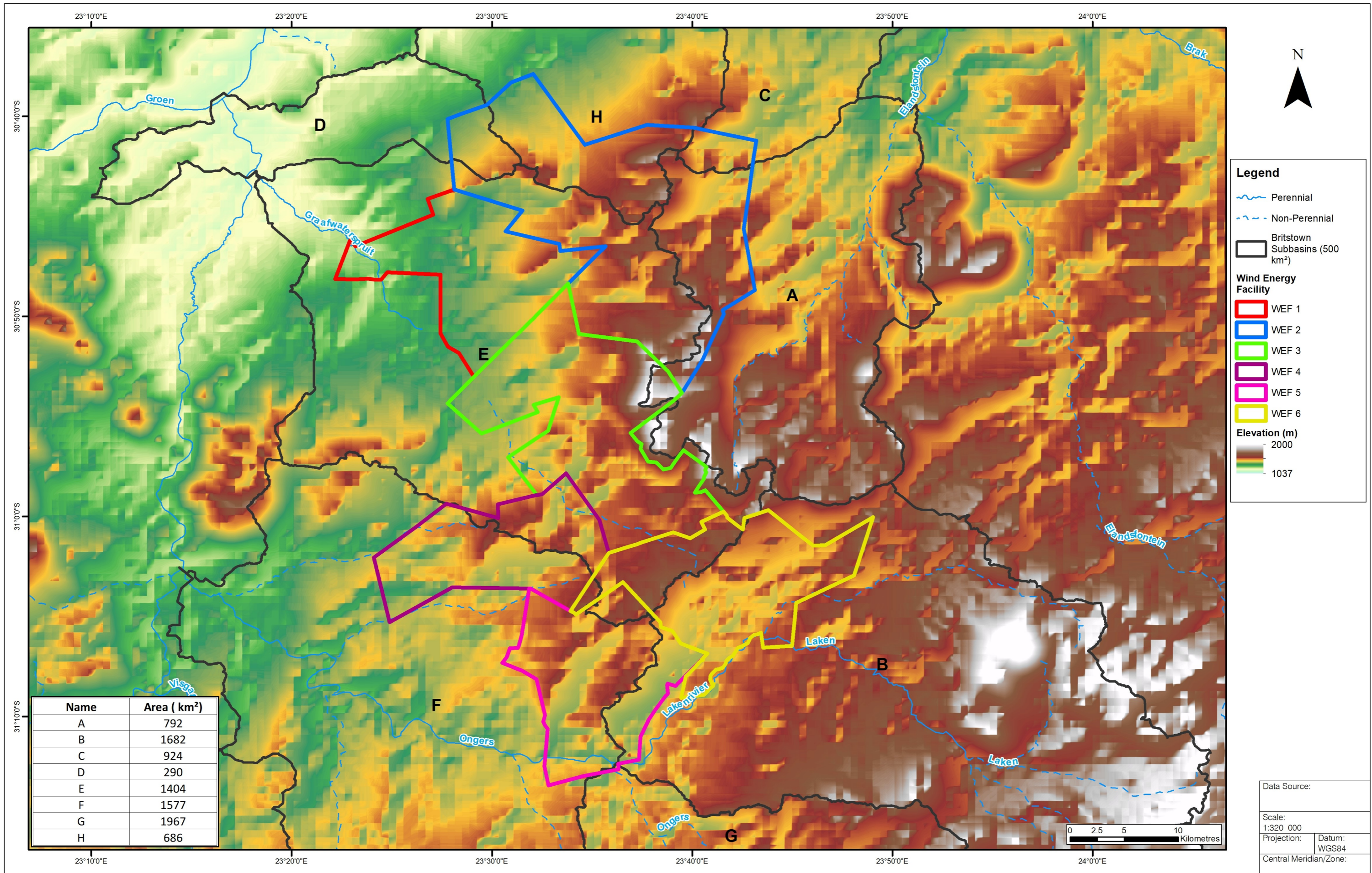

5.3 Storm Peaks

The hydrological and hydraulic parameters of all the catchments contributing towards the study area were calculated and the overland peak flow rates were determined in the study area. The Standard Design Flood (SDF) model was used to estimate peak flow rates based on the catchment parameters and rainfall intensity.

Storm peaks were calculated for the catchments shown in Figure 5-1, and peak flows generated within each sub-catchment are considered conceptual due to lack of detailed contour data (topographical survey data). The peak flows are summarised in Table 5-2 below.

The peaks are relevant to both pre-development and post-development scenarios, because the vegetation, topography and soil conditions will largely remain the same, except where the main buildings (O&M building, stores, etc.) are placed, and this accounts for a negligible proportion of the development area from a surface area viewpoint.

Note that wash water was not considered in the storm peaks, because turbine washing is unlikely to be done in the rainy season, and volumes will be negligible in comparison to storm volumes. The implications of the storm peaks calculated, and their impact on the SWMP, are discussed in Section 6.

Table 5-2 Peak Flows for Conceptual Catchments in cubic metres per second

Catchment	2 Year	5 Year	10 Year	20 Year	50 Year	100 Year
A	26	102	164	233	334	422
B	30	119	193	273	393	494
C	24	93	150	213	305	385
D	12	49	79	111	160	202
E	32	126	204	288	414	522
F	23	89	143	202	291	367
H	20	79	127	180	258	325

6 Conceptual SWMP

6.1 Design Criteria and Project Objectives

As per *Best Practice Guideline - G1: Stormwater Management* (DWAF, 2006) and GN 704 the SWMP for the site will seek to achieve certain objectives based on a philosophy of protecting the receiving environment from hydrological impacts.

- Clean and dirty water should be separated, and it should be ensured that all stormwater structures are designed to keep dirty and clean water separate and can accommodate a defined precipitation event;
- The clean water catchment area should be maximised, and clean water should be routed to a natural watercourse with minimal damage to that watercourse in terms of quantity and frequency of discharge;
- Dirty areas should be minimised, and runoff from these areas contained and either treated to an acceptable quality to discharge to the environment or removed from the site for disposal; and
- Natural watercourses and the environment should be protected from contamination by dirty areas by ensuring that the dirty water cannot enter the clean water system by spillage or seepage.

In addition to these aims, this SWMP has the following project specific objectives were developed based on the site-specific characteristics:

- Stormwater should be directed such that no water flows in an unruly fashion that may jeopardize the safety of personnel or infrastructure, or such that it is a nuisance;
- Protection of the soils by preventing erosion is also a key requirement of the SWMP;
- Minimise modification of the natural topography of the area and avoid any modification of the natural watercourses as far as possible;
- Do not impede surface or subsurface water flows unless unavoidable;
- Include a monitoring and inspection system for spills, leaks and erosion and commit to remediation where needed;
- Review and improve the SWMP regularly;
- Ensure no infrastructure, except road crossings, are built within the watercourses; and
- Do not build infrastructure, in particular infrastructure containing potential pollutants, within 300 m of natural drainage lines.

Government Notice 704 (GN704) was promulgated by the Minister of Water Affairs on 4 June 1999. Government Gazette vol. 408, No. 20119. This notice regulates the use of water for mining and related activities. Although the WEF is not a mining activity, the SWMP uses GN 704 as a guideline for EIA purposes.

6.2 Delineation of Clean and Dirty Areas

The development area is divided into clean and dirty areas as follows:

Dirty areas:

- The workshop where oils and lubricants may be stored and used
- A chemical storage area will be constructed for the operational phase of the project, which will include proper containment and bunding for all chemicals stored on site;
- The medium-voltage transformers (at the inverter stations) placed around the development area, as these will contain oil;

- Transformers at the substation, as these will contain oil;
- The conservancy tanks, as this will contain sewage; and,
- Vehicle wash bay that has a hardstanding surface on which vehicles are washed, generating dirty water which drains to a sump.

Clean areas are deemed to be all areas on the site outside of those stated above as dirty areas.

Requirements for bunding of areas housing potential contaminants are specified in detail in the National Norms and Standards for the Storage of Waste (Notice 926 of 29 November 2013, Department of Environmental Affairs, National Environmental Management: Waste Act 2008, Act No.29 of 2008). The specification, which will apply to the development area, reads as follows: *“bunds having a capacity which can contain at least 110% of the maximum contents of the waste storage facility. Where more than one container or tank is stored, the bund must be capable of storing at least 110% of the largest tank or 25% of the total storage capacity, whichever is greater (in the case of drums the tray or bund size must be at least 25% of total storage capacity).”*

Bunded areas should be sized and sealed to ensure spilled contaminants cannot leak out of the bunded areas.

6.3 SWMP Design Philosophy for a WEF

A typical WEF is a large expanse of land, over the surface of which are located wind turbines, preferably at high points to optimise exposure to wind. The turbines are placed several hundred meters away from one another. A road network provides access to each turbine and the substation. Cables run from the turbines to the substation (it is assumed that all cables are buried). The land within the site footprint on which these components are placed is not altered in any way but the WEF development. Typical stormwater management interventions for each of these components during both construction and operational phases are designed in this section.

The SWMP will be guided by Low Impact Design (LID) principles. LID in land development aims to manage stormwater as close to its source as possible by simulating or enhancing natural processes. This is achieved by interception of rainfall on the catchment surface as it lands by enabling natural infiltration into the soil, increasing surface roughness using vegetation, and aiding soil stability by the establishment of vegetation. LID was selected as a suitable method for several reasons.

Firstly, LID addresses the risk of erosion and downstream sedimentation caused by concentrated flows. Concentrated flow emanating from a catchment has higher velocities and associated streamflow than overland flow. It is desirable to keep peak flow velocity below 1.5 m/s.

Secondly, by reducing concentrated flow, LID minimises alteration of the pre-development hydrograph of the catchments in terms of peak discharge and duration of runoff. This is feasible because the total surface area modified by the WEF components is very small relative to the total surface area of the catchment (in the order of 1 %).

Finally, in terms of water quality there are no water demands, uses, or discharges from a WEF meaning that only stormwater quality needs to be managed. Aside from the dirty areas defined above, the only water contaminant will be suspended solids from disturbed soil during the construction phase and road runoff during construction and operational phases. The LID interventions specified below will effectively reduce the particle load in the water by settling in temporary sumps during construction, and filtering with vegetation lined channels and dissipaters during operation.

6.4 Site Specific Considerations

6.4.1 Site Description

Soyuz 4 WEF is comprised of six farm portions as follows: Combuisfontein; Allemans Dam portions 0 and 1; Farm 18; and Altringham. The total surface area covered is 14 200 ha. The majority of the site area drains to tributaries of the Ongers River that lies to the west of the site. A smaller area in the east of the site drains to the Graafwaterspruit River. The catchments slope gently to the streams. There is no development within the site footprint, aside from the R398 road running through it, minor access roads and a handful of smallholdings. Land use is primarily for pastoral grazing (sheep farming). A rocky outcrop of approximately 20m in height above the plains forms the watershed of the site.

6.4.2 Positioning of Turbines

The 75 wind turbines are scattered throughout SOyuz 4 WEF site area, close to high points. The majority of the turbines are positioned on the crest of the raised rocky area forming the watershed of the site, while others are placed on the top of local rocky outcrops. Due to the turbines being at the higher surface elevations within the catchments, it is expected that their resultant hydrological impacts, such as impedance of flow, will be minimal. No turbines are placed close to drainage lines.

6.4.3 Access Roads

The network of access roads connecting the wind turbines and substations; laydown areas and auxiliary buildings is extensive at approximately 55 km in length in total, and therefore cumulatively will affect a small percentage of surface permeability and infiltration of the catchment.

The Soyuz 4 WEF access road network intersects a tributary of the Ongers River at one point, coinciding with an existing farm road. An intervention will be required at the crossing point to protect the river and its banks from erosion due to traffic and ensure road integrity during rainfall events when there is water flow. Other than this two point, the roads are not predicted to have any impacts on the drainage lines of the site.

6.5 SWMP for Wind Turbine Footprint

The SWMP presented in this section is applicable to all turbines in the WEF for both construction and operational phases. The WEF site drainage is shown in Figure 6-1.

6.5.1 Construction Phase

General principles are given to guide the planning of stormwater during the construction period. The construction period has the greatest hydrological impact and therefore careful planning is essential.

An example of the construction of a wind turbine foundation is shown in Photo 6-1. The foundation of a wind turbine is buried below ground surface, typically at a depth of 3.5 – 4.0 m below natural ground elevation. Thus, earth excavation is required. In addition to the foundation works, a compacted hardstand adjacent to the foundation is required for laydown purposes.

The following interventions are required for stormwater management during construction of the wind turbine:

- Use excavated soil to form a diversion berm on the upslope of the foundation siting. This will serve to divert clean surface runoff from upstream around the works. The upstream contributing

catchment area is expected to be minor because all turbines are sited on high points in the topography. It is still necessary to minimise the water entering the area of disturbed soil.

- Construct a temporary sump at a low point on the boundary of the works. This will serve to collect runoff and allow for settlement of particles out of the water. Pump out to the environment once settled.
- If erosion is observed, place straw bales or grass mats in the area to protect the soil or construct silt fences to capture the eroded material and place back in the erosion gullies.



Photo 6-1 Typical Wind Turbine Foundation Construction

6.5.2 Operational Phase

It is assumed that once constructed, the foundation excavation will be backfilled, topsoiled and grassed. Gravel should be placed around the base of the wind turbine as a LID intervention to encourage infiltration of runoff from the turbine support back into the soil. This will result in clean runoff from the site. It is recommended that runoff be allowed to free-drain back into the environment as overland flow, as opposed to concentrating the flow and introducing a risk of localised erosion at the outlet point.

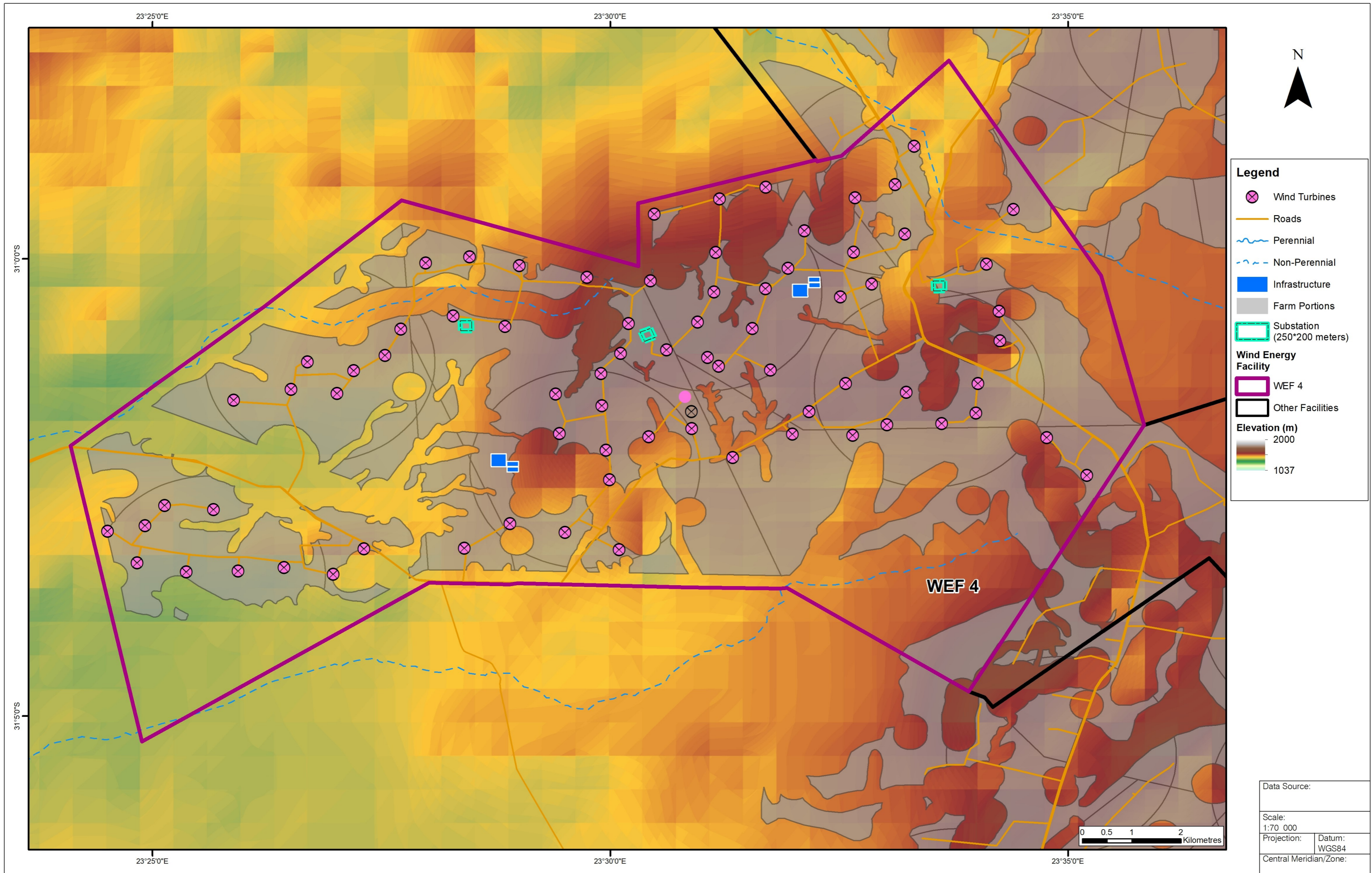

Legend

- Wind Turbines
- Roads
- Perennial
- Non-Perennial
- Infrastructure
- Farm Portions
- Substation (250*200 meters)

Wind Energy Facility

- WEF 4
- Other Facilities

Elevation (m)

- 2000
- 1037

Data Source:	
Scale: 1:70 000	
Projection:	Datum: WGS84
Central Meridian/Zone:	
Date:	Compiled by:
19/10/2022	LEKT
Project No:	Fig No:
590608	
Revision: B	Date: 07 02 2023



SOYUZ WIND ENERGY FACILITY SWMP
WIND ENERGY FACILITY 4 SITE DRAINAGE

6.6 SWMP for Access Roads

It assumed that the access roads will be gravel roads. The following interventions are recommended for stormwater management on the road:

- The roads should be cambered to drain to one side.
- V-drains should be constructed along the length of the road on both sides. The upslope side should be sized to have sufficient capacity to convey runoff from the upstream contributing catchment. The v-drain on the downslope side of the road should have sufficient capacity to contain runoff from the road surface.
- Where the slope is gentle, the v-drains shall be soil, planted with vegetation forming a permeable swale. This is a LID intervention and will facilitate infiltration of flow into the soil, protect against erosion, and allow for settling and filtration of the suspended solids and motor oil that may come from the road.
- Where the slope is steep, the v-drain shall be lined with riprap. This too is permeable but provides greater resistance against scour that may result from velocities of flow from steep slope.
- All v-drains should follow the natural topography of the land and drain ultimately to the watercourse.
- At the outlet of the road drains into the watercourse, an energy dissipater shall be installed. This would consist of gabion mattresses with a step down at the inlet, widening and daylighting to meet natural ground level at which point rip rap shall be placed. This will effectively diminish the flow and reintegrate it into the natural environment, and enter into the watercourse without causing erosion.
- At a shallow road crossing with a watercourse, a drift shall be constructed for traffic. The drift shall be constructed of concrete on compacted soil. The downslope of the drift shall be lined with gabion mattresses and rip rap to dissipate flow over the drift prior to release into the watercourse.
- At deeper road crossings with watercourses, culverts shall be constructed, Culverts are recommended to be concrete, with wing walls and gabion mattresses and rip rap on the downstream side to dissipate the energy of water flowing through the culvert. Number of culvert opening should be maximised to distribute flow as much as possible.

Typical generic conceptual designs, based on the above discussions, were compiled as shown in Figure 6-2.

6.7 SWMP for Substation and Auxiliary Buildings

The stormwater runoff from the substations and auxiliary building will be clean. It is recommended that at outlet point from downpipes, energy dissipation features be installed after which the stormwater can be discharged into the environment.

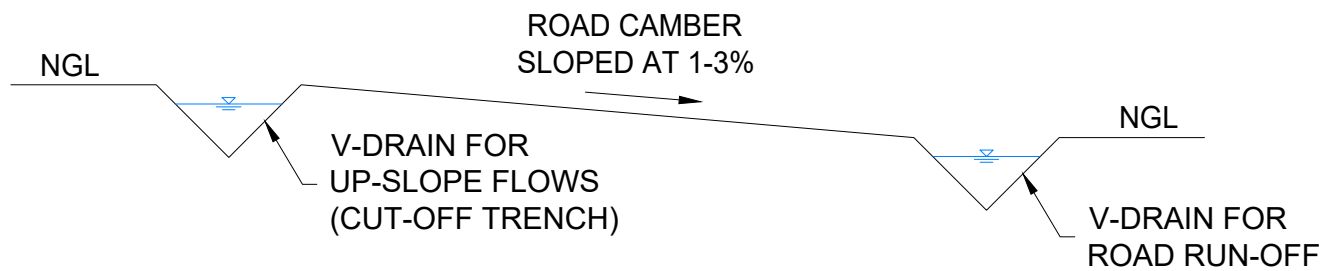

TYPICAL DETAIL
ROAD CROSS SECTION FOR DRAINAGE
 SCALE 1:50

Data Source:	
Scale AS SHOWN	
Date: 02/03/2023	Compiled by: PRJU
Project No. 590608	Fig No. 6-2a

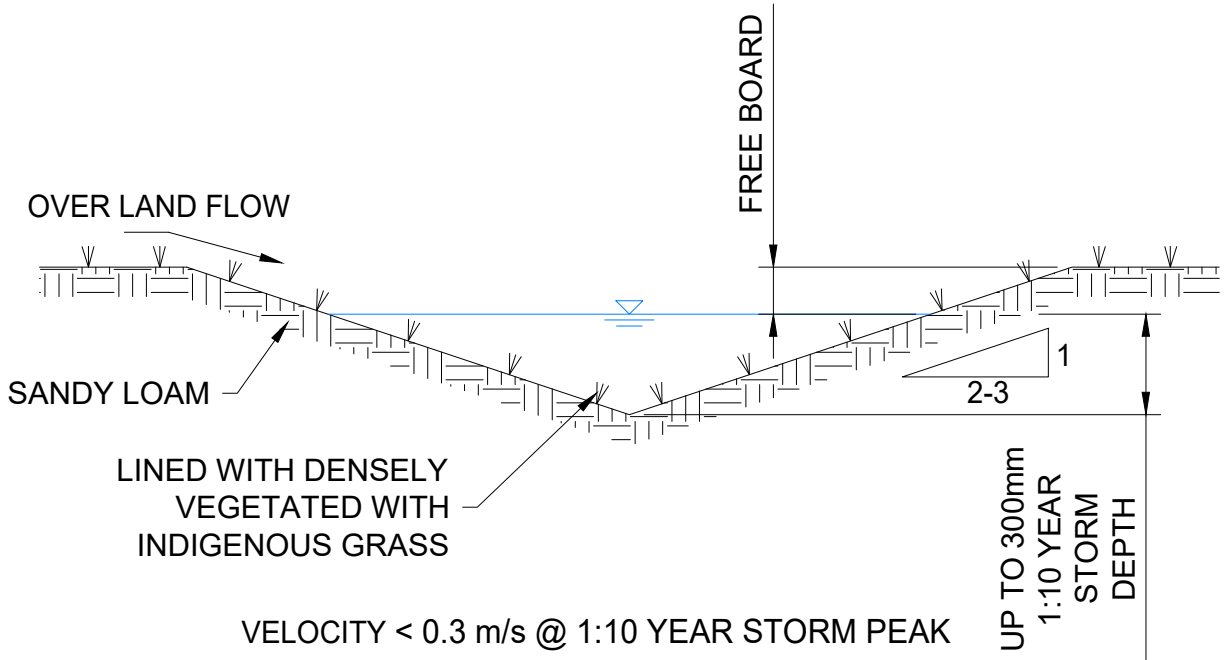

TYPICAL DETAIL
VEGETATED LINED V-DRAIN CROSS SECTION
 SCALE 1:50

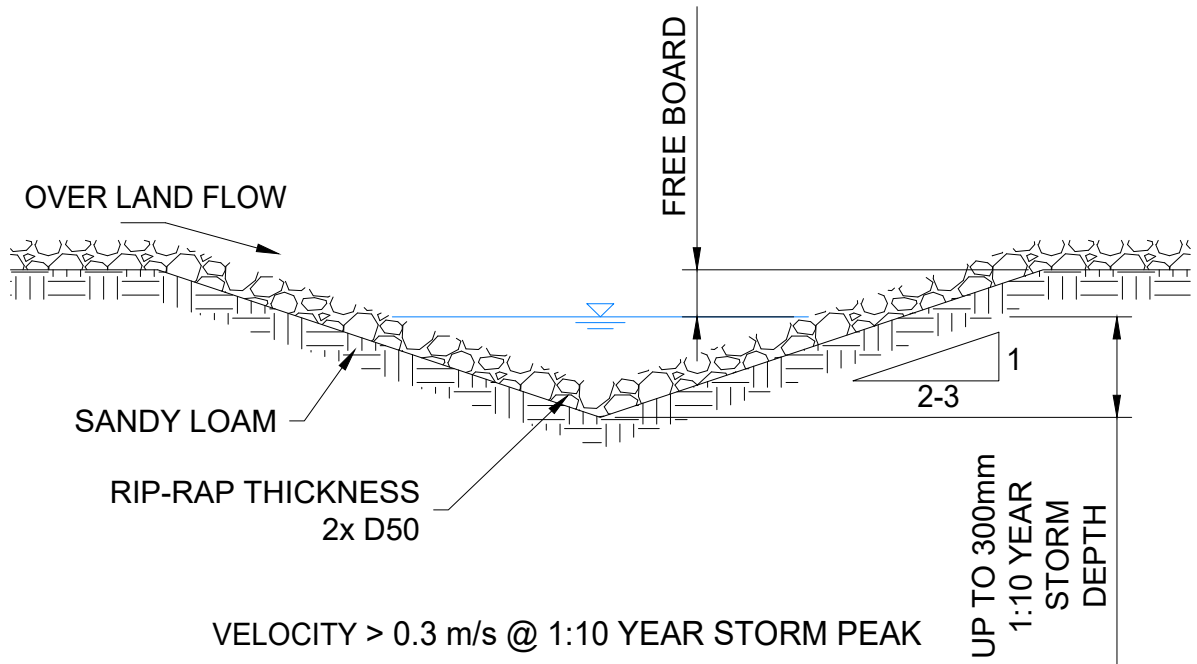

TYPICAL DETAIL
RIP-RAP LINED V-DRAIN CROSS SECTION
 SCALE 1:50

Data Source:	
Scale AS SHOWN	
Date:	Compiled by:
02/03/2023	PRJU
Project No.	Fig No.
590608	6-2b



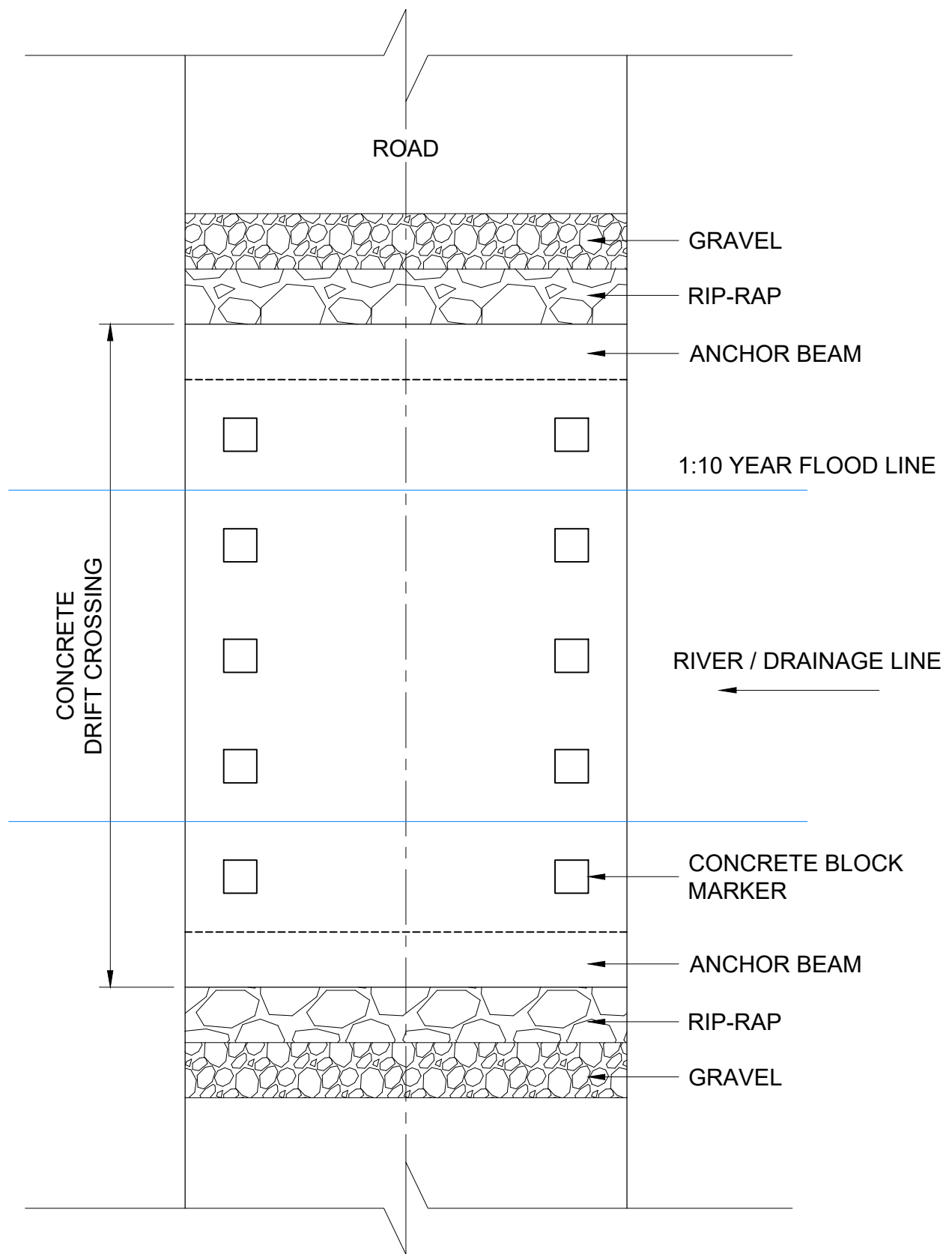

TYPICAL PLAN OF DRIFT CROSSING

SCALE 1:50

Data Source:	
Scale AS SHOWN	
Date:	Compiled by:
02/03/2023	PRJU
Project No.	Fig No.
590608	6-2C



SOYUZ WIND ENERGY FACILITY SWMP
TYPICAL CONCEPTUAL DESIGNS
OF STORMWATER INFRASTRUCTURE

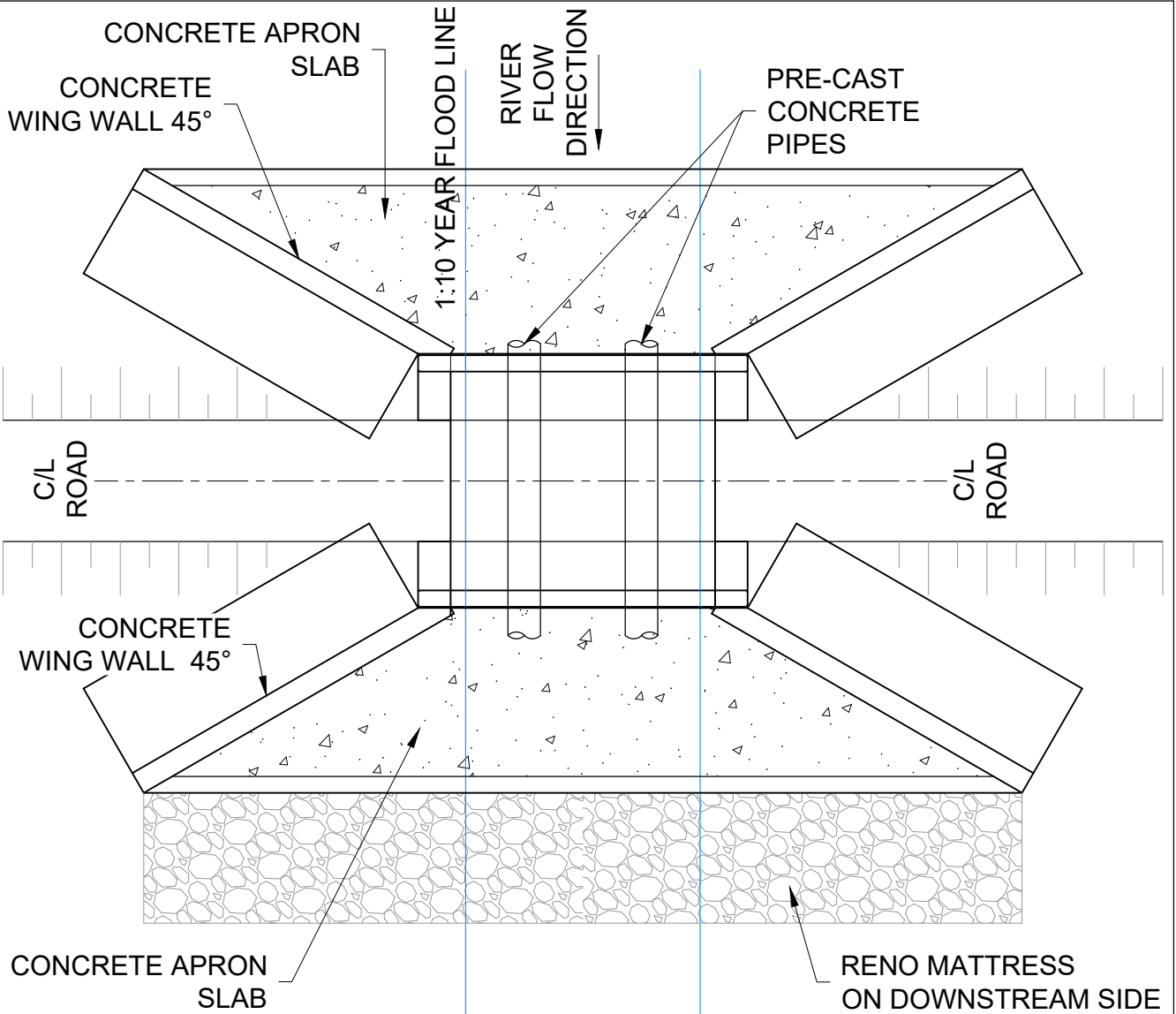

TYPICAL PLAN OF CULVERT

SCALE 1:100

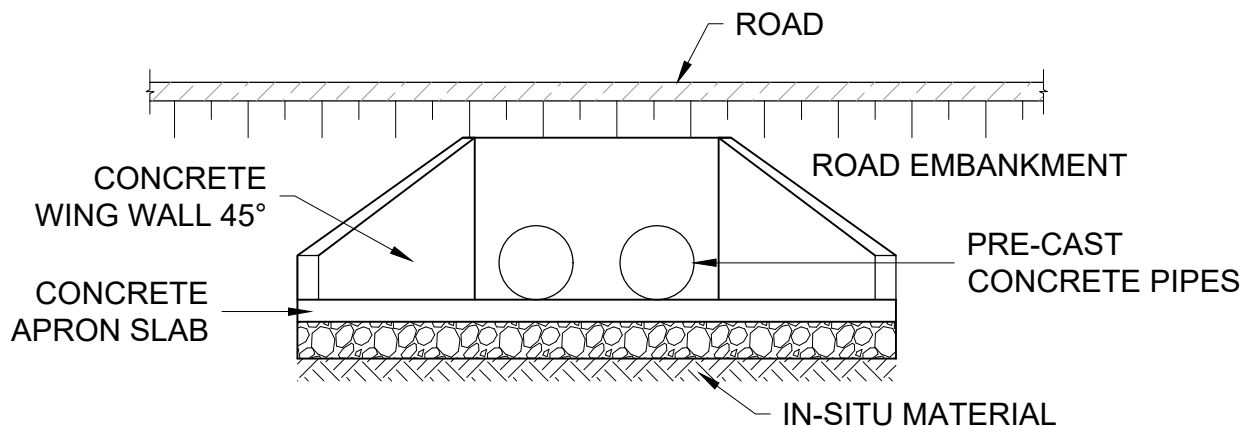

TYPICAL ELEVATION OF CULVERT

SCALE 1:50

Data Source:	
Scale AS SHOWN	
Date: 02/03/2023	Compiled by: PRJU
Project No. 590608	Fig No. 6-2d

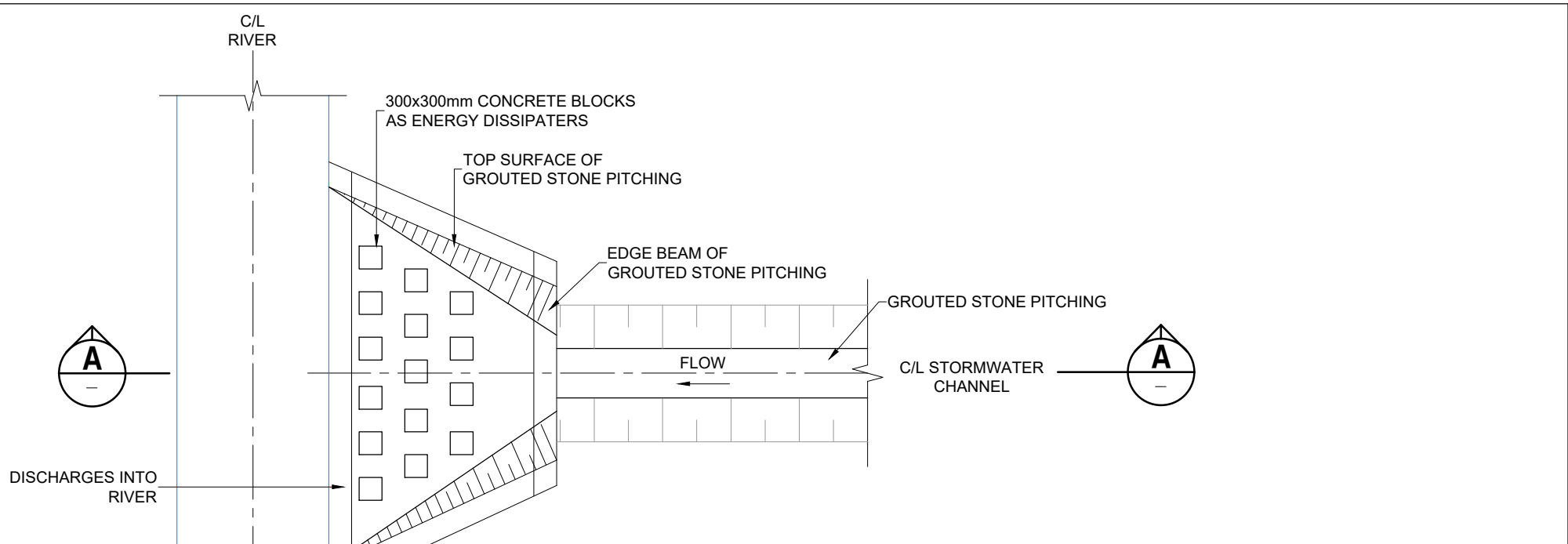

TYPICAL PLAN OF ENERGY DISSIPATER

SCALE 1:50

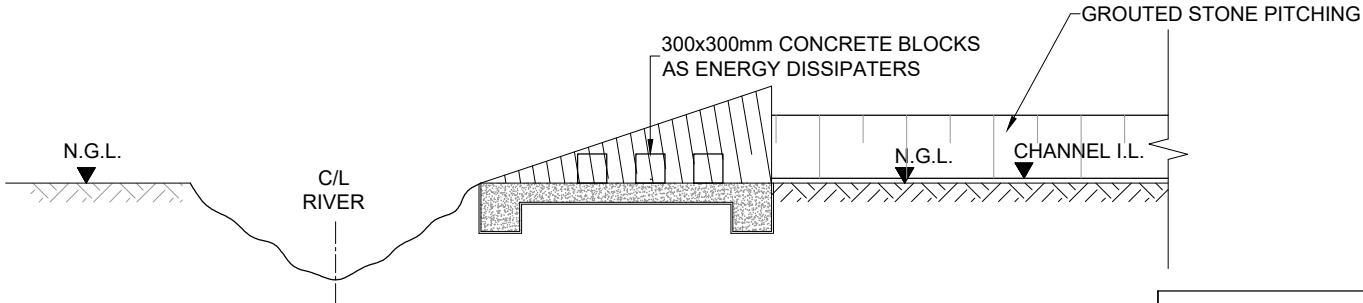

SECTION A-A

SCALE 1:50

Data Source:	
Scale AS SHOWN	
Date:	Compiled by:
02/03/2023	PRJU
Project No.	Fig No.
590608	6-2e

7 Waste and Wastewater Management

Waste will be disposed of at a registered landfill site and domestic wastewater at a licensed wastewater treatment plant (i.e., waste will be treated off site), hence, the SWMP only focuses on temporary storage on site.

Domestic waste should be stored out of the rain and wind, collected regularly and disposed of as is currently proposed for the development.

The conceptual design of the wastewater (sewage) conservancy tank was not within the scope of this report; however, the current conceptual plan was evaluated in terms of the risks that this may pose to surface water. Poor management of the tank is the main risk because the system could fail if the tank is not emptied regularly resulting in overflows. Consequently, a float switch controlled alert system is recommended.

Oil and lubricants in the workshop, and oil from the transformers must be banded as per legal requirements and hence, this was recommended without any alternatives.

8 Erosion and Sediment Transport

In general, the main erosion risks on a wind energy facility are channel outlets, roads, road crossings, foundation excavations and stockpiles. However, based on the site visit, erosion on roads is excluded as a risk as this is unlikely as long as the roads have no significant camber.

In the case of stockpiles and foundation excavations, diversion berms or silt fences are recommended to be placed on the upslope and downslope respectively. Topsoil that is cleared for the development of the turbine footprints and hardstand areas should be stockpiled for the decommissioning and rehabilitation of the facility. The stockpiles, if possible, should have gentle slopes of 1 in 5 or less to encourage revegetation and limit erosion. The stockpile should be banded until it revegetates. The gentler slopes will necessitate a stockpile with a larger surface area. This is considered the lower impact option as it limits erosion even though it disturbs more surface area.

Sometimes, material excavated during construction of the turbine foundations might be significant (cumulative volume). If that is the case, the material should be removed from and disposed of off-site responsibly (e.g., use as cover material on a landfill site).

9 SWMP Monitoring and Management

Monitoring and management are key to the success of a SWMP. The following are therefore included as a key aspect of SWMP:

- Frequent inspections until the success of the design and any unexpected problems are resolved / confirmed and maintenance frequency is determined;
- Review of the plan after a few years to improve, where possible, its practicality, cost-effectiveness or efficacy;
- Alerts that do not rely on a full-time environmental manager on site (which may not be feasible) including:
 - Automatic alert systems for the wastewater conservancy tank (e.g. a float driven switch alert system);
 - Brief, annual refresher training on stormwater protection that should not take more than fifteen minutes for each staff member; and
 - Well placed signs that remind staff members of reporting of incident / issues, as soon as possible and reduce the likelihood that forgetfulness or confusion will prevent reporting.

10 Surface Water Findings, Impacts and Mitigations

The site is undeveloped aside from pastoral farming activities. During the site inspections, the only existing impacts observed were the development of gravel roads and homesteads. The extent of this development, or modified environment, is a small fraction of the total surface area of the site of approximately 14 200 ha (in the order of less than 2 %) and thus can be assumed to have negligible surface water impacts. No overgrazing was observed, so it can be inferred that the pastoral grazing activities do not significantly alter the vegetation or soil characteristics of the area. Therefore, the site is not considered to be modified from its natural condition and thus, it is presumed that no existing hydrological impacts exist.

The cumulative impacts refer to the combined impact on the environment due to past, current, and future anthropogenic activities. As the site is undeveloped and has no existing hydrological impacts, there are no existing impacts that will exacerbate those resulting from the construction and operation of the wind turbines. Therefore the 'cumulative' impacts will be the hydrological impacts associated with the establishment of the wind turbines and associated infrastructure. The cumulative effects of all six WEF's should be considered.

In terms of the level of acceptable change, this could be defined as the extent of modification which does not alter hydrological flow regimes or introduce erosion or soil sedimentation to the environment and watercourses. As the WEF is comprised of isolated turbines, interconnected by access roads, the catchment characteristics will effectively only experience minor change (as opposed to a site with a large surface area of development) and thus are not anticipated to alter the hydrology of the catchment significantly or to push it beyond an acceptable level of change.

In this section is a matrix listing each surface water finding from this study that is required to protect surface water resources from impacts from the proposed activity. An aim, as presented in GN 704 and the Best Practice Guidelines for Stormwater Management (DWAF, 2006) is identified followed by the specific objectives that will achieve this aim. Risk of the impacts is addressed by either avoidance, prevention or mitigation by site practices and planning. Interventions are recommended in detail, in terms of when the risk occurs, which party's responsibility it is to manage, and examples of the practical means of addressing the risk.

These methods of managing the surface water risk introduced by the proposed activity are recommended to be included in the EMPr.

The SWMP, including wastewater management, is summarised in Table 10-1.

Table 10-1 Construction and Operations / Maintenance SWMP

General Principle	Specific Outcomes	When	Ref No.	Focus Area	Action	Responsible Party
Separate clean - and dirty water to ensure clean water remains uncontaminated	Temporary containments and diversion (designed for a 1 in 5-year event)	During contractors site establishment	1	<ul style="list-style-type: none"> Stockpiles; Laydown areas; Workshops; and Any other area likely to generate sediment during a storm event or contain contaminants that can be disbursed. 	Clean water diversions or bunds: Construct stormwater drains or bunds to divert clean runoff around dirty areas. The diversion should be sized for 1 in 5-year event. Typical design will be an excavated earth channel or berms. For the permanent topsoil stockpile, berms and channels to remain in place until stockpile revegetates.	Construction contractor's onsite environmental officer/representative
	Permanent containments and diversions (designed for a 1 in 50-year event)	Constructed prior to operation	2	<ul style="list-style-type: none"> The workshop and chemical stores; Transformers, inverters and substations (if not bunded); and Wastewater conservancy tank. 	Clean water diversions or bunds: Construct stormwater drains or bunds to divert clean runoff around the workshop, chemical stores, transformers, inverters, substations and wastewater conservancy tank. The diversion should be designed for a 1 in 50-year event.	Included in detailed designs of design engineer and carried out by contractor appointed for construction
Collect and, where required, treat dirty water or runoff from any dirty areas.	Dirty water should not have the potential to spill into clean water systems more than once every fifty years (where influenced by stormwater)	Before stockpiles are deposited	3	Stockpiles	Construct silt fences or berms: to prevent the sediment transport into rivers. All stockpiles to be removed after construction phase ends except permanent topsoil stockpile for decommissioning. Berms to remain around topsoil stockpile until it revegetates.	Included in detailed designs of design engineer and carried out by contractor appointed for construction
		Throughout construction	4	Waste	Dispose of landfill, oils and other contaminants offsite	
		During site establishment	5	Sewage	Supply chemical toilets	
		Constructed prior to operation	6	Workshop	Workshop collection drain with oil and grease trap: Construct a small concrete drain collecting all water, potentially containing oils and lubricants, from workshop floor and directing it through an oil and grease trap before discharge (or removing to offsite facility). Floor to be sloped such that all water will collect in drains.	
		Inspect every 3 months for first 2 years and then revise	7	Workshop	The oil and grease traps are to be inspected and, when necessary, cleaned and waste taken to a registered offsite facility	Workshop manager and assurance by environmental manager
		As required when the tank is full	8	Transformers	Dispose of any spent oil, removed from transformers during maintenance, to a registered offsite facility	
		As required when the tank is full	9	The sewage conservancy tank	Regularly collect sewage in the conservancy tank and disposed of at a licensed municipal sewage treatment plant.	
	Bund any hazardous substance or pollutant storage areas (including any oils), as per regulations	Throughout construction	10	General	Construct temporary bunds for any chemicals such as oils or fuel stored on sited during construction. Bunds must contain at least 100% of the volume of the container. If all containers are stored together the bund must store at least 110% of the largest container or 25% of the total storage capacity, whichever is greater. Suitability of the material of bund must be investigated whenever a new substance is added to the bund	Included in detailed designs of design engineer and carried out by contractor appointed for construction
		Constructed prior to operation	11	Transformers	All transformers will be bunded with bund capacity of at least 110% of the maximum volume of oil in the transformer. Transformers and bund will be protected from rainfall by small covers or roof or housed in containers, as applicable.	
			12	The sewage conservancy tank	The sewage conservancy tank will be a closed tank with an automatic alert system.	
During operation: as and when containers are purchased	13	Workshop	Small trays for workshop chemicals: Bund any containers with oils and lubricants by placing them in plastic trays that is at least 100% of the volume of the container. If all containers are stored together the bund needs to store at least 110% of the largest container or 25% of the total storage capacity, whichever is greater. Suitability of the bund must be investigated whenever a new substance is added to the bund.	Workshop manager and assurance by environmental manager		

General Principle	Specific Outcomes	When	Ref No.	Focus Area	Action	Responsible Party
Do not impede surface and subsurface flow along drainage lines	Minimise dirty areas such that surface and subsurface movement of water along the drainage lines is not impeded	Constructed prior to operation	14	The workshop, transformers, wastewater conservancy tank	Place diversion channels directly upstream of dirty areas such that dirty area catchments are minimised in footprint	Included in detailed designs of design engineer and carried out by contractor appointed for construction
	Ensure any engineered clean stormwater drainage directs water to the closest naturally receiving drainage line	Throughout construction	15	<ul style="list-style-type: none"> Laydown areas; and Stockpiles 	Minimise laydown areas and stockpiles. The permanent topsoil stockpile is excluded from this as it will be the natural topsoil from the area and gentler slopes are recommended which will necessitate a larger area.	
			16	All drains	Ensure that any temporary stormwater drains or diversion berms direct water towards the drainage line to which it would naturally flow	
		Constructed prior to operation	17	The workshop, transformers, wastewater conservancy tank	Drains to follow natural topography, Ensure outlets drain towards the natural drainage line that would originally have received flow from that area	
Control, monitor and manage erosion	Prevent erosion in general	Constructed prior to operation	18	All areas	Do not disturb the natural topography or vegetation between the wind turbine installations	Included in detailed designs of design engineer and carried out by contractor appointed for construction
		During operation	19		No stockpiles if possible except for the permanent topsoil stockpile.	Environmental manager
	Minimize erosion in large storm event of 1 in 50- years or greater	Constructed prior to operation	20	All drains	Drains sloped and sized such that velocities do not exceed 1 m/s	Included in detailed designs of design engineer and carried out by contractor appointed for construction
			21	Road crossings	Line all major drifts on road crossings with material sufficient to prevent erosion during high flow (e.g. gravel or concrete). If concrete is used, place a section of riprap (larger rocks) underlain by gravel and with gravel on either side to facilitate a smooth flow transition. Detailed modelling and design of road crossings such that erosion is controlled to be a feature of the detailed design.	
			22	All drains	Dissipaters: At drain outlets widen the channel and use riprap (can be sourced from spoil during construction) or reno mattresses to dissipate stormwater flows	
	Dissipate stormwater at all drainage outlets to velocities unlikely to cause erosion in natural soils for a 1 in 50-year storm event		23	Road crossings	Dissipation at road crossings: Detailed modelling and design of road crossings including riprap (can potentially be sourced from spoil during construction) or reno-mattresses.	
			24	All	Maintain natural topography and vegetation: Do not disturb the natural topography or vegetation where possible	Construction contractors onsite environmental officer/representative
	Prevent erosion in general	Throughout construction	25	All drains	Engineer low velocity temporary drains: Drains sloped and sized such that velocities do not exceed 1 m/s in a 1 in 5-year event	
			26	Road crossings	Engineered temporary drifts: Build roads and road crossings before other infrastructure.	
	Ensure that any chronic erosion is detected and rehabilitated within 6 months	Every 3 months for the first 2 years and annually thereafter	27	<ul style="list-style-type: none"> Drains; Outlet of all Drains; and All-natural drainage lines that cross the access road. 	Inspect all focus areas for erosion. If erosion is found, remediate and redesign the drainage in the area. If erosion is found in a natural drainage line, conduct an assessment and determine the cause. Develop a plan to prevent future erosion.	Environmental manager or hydrologist/engineer/environmental scientist appointed by the environmental manager
Ensure that any acute erosion due to large storm events is detected within 2 weeks.	Install prior to operation	28	Main office	Install a rain gauge that can measure greater than 150 mm.	Included in detailed designs of design engineer and carried out by contractor appointed for construction	
	After a rain event of greater than 150 mm in one day (a 10 year - 24-hour rain event) or when staff notice flood damage.	29	All-natural drainage lines that run through the site	Inspect and remediate acute erosion: Inspect all focus areas for erosion. If erosion is found remediate and redesign the drainage in the area. If erosion is found in a natural drainage line conduct an assessment and determine the cause and develop a plan to prevent future erosion.	Environmental manager or hydrologist/engineer/environmental scientist appointed by the environmental manager	

General Principle	Specific Outcomes	When	Ref No.	Focus Area	Action	Responsible Party
		Design and development prior to operation	30	All	Set up rain data system: Build or buy a basic rain program, preferably electronic, that allows site staff to enter rain data from the rain gauge. Ideally the system should let the environmental manager and site manager when a rainfall event in excess of 150 mm.	
		Daily	31	Main office	Record rain data: Read and record rain gauge daily;	Onsite staff member tasked by the Environmental manager
		Update annually in case of staff change	32		Signs at main office to aid problem reporting: Ensure that a sign providing the following is posed in the reception area, the control room, on each transformer and in the workshop: The name, telephone number and email address of the environmental manager. The sign should state: "If you notice any leaks or spills or erosion anywhere on the property please contact the Environmental Manager by one of these methods..."	Environmental manager
	Training	Annually	33	All	Training: Provide a short briefing to all construction staff on the dynamics of erosion and leaks that covers at least: <ul style="list-style-type: none"> How to identify erosion; How to identify a leak, including car leaks; Where to find contact details of the environmental officer/representative in case of leaks or erosion. 	Environmental manager or hydrologist/engineer/environmental scientist appointed by the environmental manager
	Ensure that any erosion is detected and rehabilitated	After rain events	34		Inspect the site for erosion after rain events. If erosion is found, remediate and redesign the drainage in the area. If erosion is found in a natural drainage line, conduct an assessment to determine the cause and develop a plan to prevent future erosion.	Contractors environmental officer/representative
During site establishment		35	Install a rain gauge that can measure greater than 150 mm. This rain gauge will also be used during operation.			
Monitor and manage stormwater system	Include a monitoring system for spills and leaks such that they are detected as soon as possible.	Once every 2 weeks during Construction	36	All	Leak inspection: regularly check for leaks and for any breaches or evidence of spills or any other problems not in adherence to this SWMP. All cars should also be checked for oil leaks and any leaks found should be stopped immediately, the cause of the leak identified, the problem remediated such that no further leaks occur, and any contaminated soil or water assessed and remediated.	Contractors environmental officer/representative
		Every 3 months for the first 2 years and annually thereafter (Operation)	37		Leak inspection: regularly check for leaks and for any breaches or evidence of spills or any other problems that would indicate that it is not in adherence to this plan. All cars should also be checked for oil leaks during the inspection. Any leaks found should be stopped immediately, the cause of the leak sought, the problem remediated such that no further leaks occur, and any contaminated soil or water assessed and remediated.	Environmental manager or hydrologist/engineer/environmental scientist appointed by the environmental manager
	Continuous	38	Data capture, training and signs: see 32, 33, 34, 35, 36, & 37		Environmental manager and staff in general	
	Construct prior to operation	39	The sewage conservancy tank		Sewage conservancy tank alert system: Install a float switch-controlled alarm that will alert the control room when the conservancy tank has less than 2 weeks of capacity remaining.	Included in detailed designs of design engineer and carried out by contractor appointed for construction
		40	Transformers		Signs at transformers: Post a sign on transformers stating "If you notice any leaks or spills or erosion anywhere on the property please contact reception via one of the following methodsand report it"	
General	Do not build infrastructure within near to watercourses	Detailed design	41	All	Ensure no infrastructure except roads with appropriate hydraulic infrastructure are built within 300 m of a water course. In particular, ensure no dirty areas, that may contain pollutants, are within 300 m of the water course	Design engineer or engineer appointed by the design engineer
	Do not build infrastructure containing potential pollutants in any of the natural drainage lines.		42		Ensure that final infrastructure plans do not propose any potentially polluting infrastructure, such as transformers, workshops or conservancy tanks in the natural drainage lines (currently none are proposed)	

General Principle	Specific Outcomes	When	Ref No.	Focus Area	Action	Responsible Party
	Review and improve stormwater management plan regularly.	Once every 5 years	43		Review and improve the stormwater plan	Environmental manager or engineer appointed by the environmental manager
	Review and inspect	Once every 2 months during construction depending schedule	44		Inspect the site to ensure adherence to the stormwater management plan	Clients' environmental representative or engineer
	Do not place stockpiles or other potentially polluting construction items within 300 m of the watercourse	Detailed design and throughout construction	45		Do not place laydown areas, stockpiles within 300 m of the watercourse	Design engineer or engineer appointed by the design engineer
	General	Detailed design	46		Develop a specific environmental specification for any construction including, but not limited to, the actions in this stormwater management plan and its principles	Clients' environmental representative or specialist
	Prepare for spills	Construction and Operation	47		Procure spill kits and place in areas where fuel or oils are transferred (e.g. workshops)	Environmental manager

11 Conclusion and Recommendations

A specialist surface water study was carried out by SRK to support the EIA application for the Soyuz 4 WEF development in the Northern Cape proposed by the Applicant. It was found that the layout of the Soyuz 4 WEF consists of discrete points where the turbines are erected, interconnected by linear infrastructure (access roads), as well as minor auxiliary buildings and substations. The development is spread over a large area of approximately 14 200 ha meaning that the gross surface area occupied by the components mentioned is small in comparison to the entire footprint of the Soyuz 1 WEF (estimated to be less than 2 %). As hydrology is controlled by sub-catchment surface area characteristics, and the alteration of the surface characteristics is minimal (less than 2 % area modified), it can be concluded that the net impact of the development on hydrology is minor. However, local management of surface runoff is required at the turbine positions (turbine foundation and adjacent hardstand) and along the roads. Interventions to avoid, manage and mitigate potential impacts during both the construction phase and the operational phase are specified in Section 10: SWMP. It was found that the most impacts and risk to surface water resources occurs during the construction phase at the excavation for the turbine foundation.

It is recommended that the proposed activity and all associated infrastructure be authorised as it has been found that surface water impacts resulting from the activity are minimal and within an acceptable level of change. These impacts are summarised below:

- Level of change to runoff regime is minimal, i.e., frequency and magnitude of peak discharges from sub-catchments is not expected to be changed and baseflow is not expected to be impacted.
- Erosion and sedimentation is a risk at the locations of the wind turbines and along the access roads and thus would only occur at localised points which can be prevented.
- As all turbines are positioned at high elevations, it is unlikely that their zone of influence will extend to the watercourses within the site footprint.
- It was found that no turbines are positioned within watercourses and therefore no risk of impact to the riverbeds or banks exists.
- The only constituent of concern that may pollute waterways is suspended solids from disturbed soils. These solids can be managed and allowed to settle out of surface runoff prior to release to the environment. Therefore, the resultant impact on surface water quality will be negligible.

As well as the impacts being minimal, all impacts can be avoided, managed, and mitigated by implementing the SWMP presented in this report. In order to achieve this, all SWMP interventions should be included in the EMP (not repeated here).

It is recommended that the SWMP be developed further during the Detailed Design by:

- Conducting a detailed topographic survey;
- Developing a stormwater layout and designs based on the above information and infrastructure layout plan;
- Sizing the culverts or drifts associated with the proposed road crossings such that they can handle at least the 1:2-year flood event, or a minimum of 600 mm diameter or height (for maintenance purposes);
- Developing conceptual designs into detailed designs with sufficient detail to support construction; and
- The plan should be incorporated into an environmental specification for use during construction and incorporated into the operational environmental management of the site.

In conclusion:

- The proposed facility will have an intrinsically low impact on surface water resources;
- The potential stormwater impacts that do exist can be managed in a practical and cost-effective way; and
- The plan is conceptual, because no detailed contour data is available and only conceptual infrastructure layouts were made available at the time of the study – that said, moderate to low rainfall and low flow gradients characteristic of the area suggest that detailed design should not vary considerably from the concepts presented in this report.

Prepared by

SRK Consulting – Certified Electronic Signature

590608/44873/Report
2299-1656-9737-MENU-10/11/2022
This signature has been printed digitally. The Authority has given permission for its use for this document. The details are stored in the SRK Signature Database.

Jennifer Meneghelli
Senior Civil Engineer

Reviewed by

SRK Consulting – Certified Electronic Signature

590608/44867/Report
2894-123-4148-THJE-04/11/2022
This signature has been printed digitally. The Authority has given permission for its use for this document. The details are stored in the SRK Signature Database.

Jeandre Thompson
Senior Civil Engineer

Approved by

SRK Consulting – Certified Electronic Signature

590608/44877/Report
2801-2009-5570-BAU-1-14/11/2022
This signature has been printed digitally. The Authority has given permission for its use for this document. The details are stored in the SRK Signature Database.

Tiaan Bauman
Partner | Principal Civil Engineer

All data used as source material plus the text, tables, figures, and attachments of this document have been reviewed and prepared in accordance with generally accepted professional engineering and environmental practices.

References

Department of Water Affairs and Forestry. (4 June 1999). GN R 704 Regulations in terms of section 26 of the National Water Act on the Use of Water for Mining and Related Activities aimed at the Protection of Water Resources. Pretoria: Government Gazette .

Department Water Affairs and Forestry. (2006). G1 Best Practice Guideline for Storm Water Management, Best Practice Guidelines for Water Resource Protection in the South African Mining Industry. . Pretoria: Department of Water Affairs and Forestry (Now DWS).

Smithers, J. C., & Schulze, R. W. (2002). Design rainfall and flood estimation in South Africa. Pietermaritzburg: University of Natal.

Appendices

Appendix A: Specialist CVs

Jennifer Meneghelli

Senior Civil Engineer

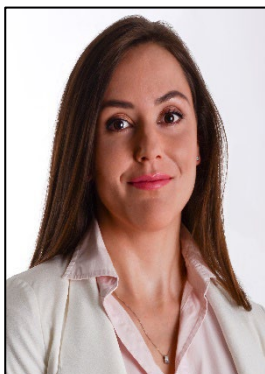

Profession	Civil Engineer BSc (Hons), Civil Engineering, University of the Witwatersrand, South Africa, 2010
Registrations/ Affiliations	Professional Engineer 20180332, ECSA Associate Member 2012862, SAICE Associate Member 26201, WISA
Awards	None

Specialisation

Hydrological assessments: Water resources management: Hydraulic infrastructure at mines: Floodlines : Stormwater management plans : Water balances

Expertise

Jennifer Meneghelli (previously Sandham) has been practicing as a civil engineer for the past 12 years, initially in structural engineering and then in water engineering resources engineering. Her expertise includes:

- Surface water management in the mining, petrochemical, agricultural and urban sectors to conserve and protect natural water resources and minimise the impact of operations on the receiving environment.
- Water balances in which the site is modelled and simulated to predict water flows. From the water balance model, the demands and required storage and treatment or disposal can be determined for operational or forecasting purposes. Compliance with site legislative permits is assessed.
- Water resource planning and management of water quantities and various qualities on a site such that no spill of polluted water to the environment occurs, and site water demands are met.
- Water conservation and demand management plans ensure the optimal and sustainable use of water.
- Hydrological baseline assessments of site localities. The hydrological response of a catchment is determined based on climate, rainfall data and surface characteristics using meteorological data for the area.
- Stormwater management plans (SWMP) for polluting facilities in compliance with the National Water Act (Act No. 36 of 1998), Government Notice Regulation 704 (1999) for Water Use License Applications (WULA), Integrated Waste and Water Management Plans (IWWMP) and Specialist Surface Water Studies for use in Environmental Impact Assessments (EIA).
- Floodline determination using survey data, peak flow calculation and modelling of the river in GeoHECRAS. A backwater analysis is then simulated to estimate water surface elevations.
- Green urban stormwater management infrastructure design. This includes bioretention cells, artificial wetlands and use of bioremediation for the treatment and management of urban runoff.

Jennifer Meneghelli

Senior Civil Engineer

Employment

2022 - present	SRK Consulting (South Africa) (Pty) Ltd, Senior Civil Engineer, Johannesburg
2021 – 2022	GCS Water and Environmental Consultants, Water Resources Engineer, Johannesburg
2018 – 2020	University of the Witwatersrand, master's in science water engineering
2015 – 2018	Jones & Wagener Engineering and Environmental Consultants, Hydrological Engineer, Johannesburg
2014 – 2015	Jacobs Matisis, Civil and Structural Engineer, Secunda.
2012 – 2014	SNC-Lavalin, Civil and Structural Engineer, Johannesburg
2011 – 2012	Roman Rock Consulting Engineers, Junior Civil and Structural Engineer, Johannesburg

Publications Presentation of research at SAICE Stormwater Management Conference (2019).

Languages English – read, write, speak (excellent)
Afrikaans – read, write, speak (basic)

Jennifer Meneghelli

Senior Civil Engineer

Key Experience: Water Resource Engineering

Location: Balfour, Mpumalanga, South Africa
 Project duration & year: 2022
 Client: Sibanye Stillwater
 Name of Project: Burnstone Gold Mine
 Project Description: Underground mining operation development
 Job Title and Duties: Water Resource Engineer, Water Balance
 Value of Project: N/A

Location: Lephalale, Limpopo, South Africa
 Project duration & year: 2021
 Client: Exxaro
 Name of Project: Grootegeluk Solar PV Plant
 Project Description: EIA and WULA for solar PV plant development
 Job Title and Duties: Water Resource Engineer, surface water specialist study
 Value of Project: N/A

Location: Kasiya, Malawi
 Project duration & year: 2021
 Client: Sovereign Metals
 Name of Project: Kasiya Rutile
 Project Description: Prefeasibility study for a proposed rutile mine
 Job Title and Duties: Water Resources Engineer, surface water specialist study
 Value of Project: N/A

Location: Jwaneng, Botswana
 Project duration & year: 2020
 Client: Debswana
 Name of Project: Jwaneng Slimes Dam
 Project Description: Carry out a dam break analysis on the tailings storage facility at a diamond mine
 Job Title and Duties: Hydrological Engineer, Dam Break Analysis
 Value of Project: N/A

Location: Lephalale, Limpopo South Africa
 Project duration & year: 2018
 Client: Eskom
 Name of Project: Medupi Ash Disposal Facility
 Project Description: Design of ash disposal facility
 Job Title and Duties: Hydrological Engineer, Stormwater Management Plan
 Value of Project: N/A

Location: Springs, Gauteng, South Africa
 Project duration & year: 2017
 Client: EnviroServ
 Name of Project: Holfontein Integrated Waste Disposal
 Project Description: Develop a model for operational and forecasting of water resources on the site
 Job Title and Duties: Hydrological Engineer, Water Balance, SWMP
 Value of Project: N/A

Jeandré Thompson

Senior Civil Engineer



Profession	Professional Civil Engineer
Education	BEng (Hons) (Civil), University of Pretoria, 2021 BEng (Civil), University of Pretoria, 2012
Registrations/ Affiliations	Pr Eng, ECSA, 20180244
Awards	None

Specialisation

Hydrology, Stormwater management, Pump stations and pipelines, Lined and unlined dams, Bulk earthworks, Concrete structures, Rehabilitation plans and project / contract / construction management.

Expertise

Jeandré Thompson has been involved in the field of civil engineering for the past 10 years. He started his career spending two years in Malawi as a Design Support Engineer designing drainage and structural elements on the Nacala Corridor Railway.

He has spent a further 8 years designing mine expansion as well as rehabilitation plans, municipal stormwater plans, effluent and water storage dams and various pump and pipeline schemes. He has a very good understanding of drainage and floodwater control, how water interacts with infrastructure and the need for erosion protection.

Working on large international projects has exposed him to a fast array of international design codes such as SABS and SANS (South Africa), Euro Code (Europe), BS (England), the Australian design codes as well as various client specific specifications. Jeandré also has experience in managing design teams and monitoring and managing construction project in accordance with the GCC, NEC and FIDIC.

Employment

2019 – present	SRK Consulting (Pty) Ltd, Senior Civil Engineer, Johannesburg
2014 – 2018	SRK Consulting (Pty) Ltd, Civil Engineer, Johannesburg
2013 – 2014	SRK Consulting Blantyre, Design Support Department Coordinator and Assistant Manager and Civil Engineer, Malawi
2013 – 2013	SRK Consulting Blantyre, Civil Engineer, Malawi

Publications

None

Languages

Afrikaans – read, write, speak
English – read, write, speak

Jeandré Thompson

Senior Civil Engineer

Key Experience: Engineer of Record

Location: Various, South Africa
 Project duration & year: 2021 – Ongoing
 Client: Anglo American Platinum – Process Division
 Name of Project: AAP Engineer of Record
 Project Description: Providing engineer of Record services at the Polokwane, Mortimer and Waterval Smelters, RBMR and PMR.
 Job Title and Duties: Senior Civil Engineer, Assistant EoR
 Managing the EoR works at the various plants. Performing dam and slag pad safety inspections, reporting.
 Preparing ERP, EPP and TARP's
 Controlling Document Register
 Preparing Continuations Reports and Stability Assessments
 Training junior staff
 Value of Project: Professional fees approximately R 5 000 000.00

Key Experience: Dams – Design

Location: Steelpoort, Mpumalanga, South Africa
 Project duration & year: 2021
 Client: Anglo Platinum – Der Brochen Mine
 Name of Project: WRD and dam's expansion project
 Project Description: Preliminary Design of 2 lined dams and Waste Rock Dump for the expansion of the Der Brochen mine – Northern Pit expansion
 Job Title and Duties: Civil Engineer & Project Manager
 Design of dams, compilation of BoQ and Drawings, Reporting and Project Management.
 Value of Project: Capital build cost approximately R 45 Million
 Professional fees approximately R 3 000 000

Location: Limpopo, South Africa
 Project duration & year: 2020
 Client: Loren Louw Farm
 Name of Project: Farm Dam WULA
 Project Description: Design of two unlined dams (approx. 70 000m³ each) for the storage of water from a natural spring
 Job Title and Duties: Civil Engineer
 Design of dams and associated outlet works and spillways, compilation of Report and Drawings.
 Value of Project: Professional fees approximately R 250 000

Location: Steelpoort, Mpumalanga, South Africa
 Project duration & year: 2019
 Client: Anglo Platinum – Der Brochen Mine
 Name of Project: WRD and dam's expansion project
 Project Description: Conceptual Design of 3 lined dams atop a waste rock dump for the expansion of the Der Brochen mine – Northern Pit expansion
 Job Title and Duties: Civil Engineer
 Design of dams, compilation of BoQ and Drawings.
 Value of Project: Capital build cost approximately R 45 Million
 Professional fees approximately R 200 000

Jeandré Thompson

Senior Civil Engineer

Key Experience: Dams – Design

Location: Rustenburg, North West, South Africa
 Project duration & year: 2019 – 2020
 Client: Anglo Platinum Precious Metals Refinery (PMR)
 Name of Project: PMR Dam 2 relining project
 Project Description: Design of Dam 2 – Relining of existing dam (Class A Barrier)
 Job Title and Duties: Civil Engineer
 Design of dam basin and sub soil drainage infrastructure, compilation of BoQ and Drawings.
 Value of Project: Capital build cost approximately R 22 Million
 Professional fees approximately R 1 Million

Location: Kriel, Mpumalanga, South Africa
 Project duration & year: 2019
 Client: Universal Coal, Roodekop Mine
 Name of Project: New PCD. No 2
 Project Description: Design of new lined PCD (Class C-Barrier), spillway, pump station and silt trap
 Job Title and Duties: Civil Engineer and Project Manager
 Dam and spillway design, drawings, BoQ and reporting
 Value of Project: Professional fees R 1 Million

Location: Brakpan, Gauteng, South Africa
 Project duration & year: 2019
 Client: Lonmin Brakpan Precious Metals Refinery (PMR)
 Name of Project: New dams and associated infrastructure
 Project Description: Design of new effluent dams including associated sumps and pumps
 Job Title and Duties: Civil Engineer and Project Manager
 Design of 2 lined dams (Class A and Class C Barriers), sub soil drainage system, 3 pump stations and pipelines, remediation of contaminated groundwater table, geotechnical and contamination investigation and sampling
 Value of Project: Professional fees approximately R 3.5 Million

Location: Ogies, Mpumalanga, South Africa
 Project duration & year: 2018
 Client: ESKOM, Kendal Power Station
 Name of Project: Kendal Ash Dam GN 704
 Project Description: Design of 3 return water dams for the Kendal Ash Dam Complex
 Job Title and Duties: Civil Engineer
 Geotechnical design and stability assessment of GN 704 compliance dams
 Value of Project: Capital build cost approximately R 20 Million

Location: Mothae, Lesotho
 Project duration & year: 2018
 Client: Mothae Mines
 Name of Project: Mothae mine expansion
 Project Description: Conceptual design of 1 000 000 m3 dam in Mothae River.
 Job Title and Duties: Civil Engineer
 Conceptual design of earth embankment dam to store 1 000 000 m3 of fresh water, location selection and associated pumping line to deliver fresh water to the mine.
 Value of Project: Capital build cost approximately USD 90 million

Jeandré Thompson

Senior Civil Engineer

Key Experience: Dams – Design

Location: Rustenburg, North West, South Africa
 Project duration & year: 2017
 Client: Anglo Platinum Precious Metals Refinery (PMR)
 Name of Project: PMR Dam 1 and Dam 3A relining project
 Project Description: Design of Dam 1 and Dam 3A – Relining of existing dams
 Job Title and Duties: Civil Engineer
 Design of dam basin and sub soil drainage infrastructure, compilation of BoQ and Drawings.
 Value of Project: Capital build cost approximately R 22 Million
 Professional fees approximately R 1 Million

Key Experience: Dams - Construction

Location: Brakpan, Gauteng, South Africa
 Project duration & year: 2021 – Ongoing
 Client: Lonmin Brakpan Precious Metals Refinery (PMR)
 Name of Project: New dams and associated infrastructure
 Project Description: Construction monitoring and Contracts management of two new lined dams, HDPE pipelines and pump stations
 Job Title and Duties: Civil Engineer and Project Manager
 Quality Control, Project and Contract Management and reporting
 Value of Project: Capital build cost approximately R 20 Million
 Professional fees approximately R 3.5 Million

Location: Rustenburg, North West, South Africa
 Project duration & year: 2017 – 2019
 Client: Anglo Platinum Precious Metals Refinery (PMR)
 Name of Project: PMR Dam 1 and Dam 3A relining project
 Project Description: Relining of Dam 1 (Class A Barrier) and Dam 3A (Class C Barrier)
 Job Title and Duties: Civil Engineer
 Construction monitoring and design support.
 Value of Project: Capital build cost approximately R 22 Million
 Professional fees approximately R 2 Million

Key Experience: Dams – Safety Inspections and Dam Breach Studies

Location: Fort Dauphin, Madagascar
 Project duration & year: 2021 – Ongoing
 Client: Rio Tinto
 Name of Project: QMM Dam Breach Assessment
 Project Description: Dam Breach Study of dam's (13 in total) complex at QMM Mandena, Rio Tinto
 Job Title and Duties: Civil Engineer
 Dam breach modelling and reporting
 Value of Project: Professional fees approximately R 1 000 000.00

Location: Rustenburg, North West, South Africa
 Project duration & year: 2021
 Client: Anglo Platinum Base Metals Refinery (RBMR)
 Name of Project: RBMR Dam 3B Dam Breach Assessment
 Project Description: Dam Breach Study of Dam 3B at the RBMR complex
 Job Title and Duties: Civil Engineer
 Dam breach modelling and reporting
 Value of Project: Professional fees approximately R 400 000.00

Jeandré Thompson

Senior Civil Engineer

Key Experience: Dams – Safety Inspections and Dam Breach Studies

Location: Rustenburg, North West, South Africa
 Project duration & year: 2020
 Client: Anglo Platinum Precious Metals Refinery (PMR)
 Name of Project: PMR Dam Saftey Office - Dam Saftey Inspection – 5 Yearly
 Project Description: 5 Yearly Dam Saftey Inspection of Dam 4 and 5 at the PMR
 Job Title and Duties: Civil Engineer
 Dam safety inspection and reporting
 Assisting APP with works
 Value of Project: Professional fees approximately R 200 000.00

Location: Rustenburg, North West, South Africa
 Project duration & year: 2020
 Client: Anglo Platinum Precious Metals Refinery (PMR)
 Name of Project: PMR Dam Saftey Inspection
 Project Description: Dam Saftey Inspection of Dam 1, 2, 3A, 3B, 4 and 5, 6E and 6W at the PMR – 2 yearly inspection
 Job Title and Duties: Civil Engineer
 Dam safety inspection and reporting
 Value of Project: Professional fees approximately R 100 000.00

Location: Rustenburg, North West, South Africa
 Project duration & year: 2018
 Client: Anglo Platinum Precious Metals Refinery (PMR)
 Name of Project: PMR Dam Saftey Inspection
 Project Description: Dam Saftey Inspection of Dam 1, 2, 3A, 3B, 4 and 5, 6E and 6W at the PMR – 2 yearly inspection
 Job Title and Duties: Civil Engineer
 Dam safety inspection and reporting
 Value of Project: Professional fees approximately R 100 000.00

Key Experience: Hydrology

Location: Centurion, Gauteng, South Africa
 Project duration & year: 2020
 Client: Pretor
 Name of Project: River Falls Office Park
 Project Description: Flood risk management of the River Falls office park when the Hennops River floods
 Job Title and Duties: Civil Engineer
 Hydrology, reporting and project management.
 Value of Project: Professional fees approximately R 50 000

Location: Upington, Northern Cape, South Africa
 Project duration & year: 2019 – 2020
 Client: Atlantic Renewable Energy Partner
 Name of Project: AREP Solar Farms
 Project Description: Stormwater Master Plan of new solar developments
 Job Title and Duties: Civil Engineer
 Hydrology, drawings, reporting and project management.
 Value of Project: Professional fees approximately R 200 000

Jeandré Thompson

Senior Civil Engineer

Key Experience: Hydrology

Location: Rustenburg, North West, South Africa
 Project duration & year: 2019 – 2020
 Client: Anglo Platinum Precious Metals Refinery (PMR)
 Name of Project: PMR Dam 3A stormwater diversion
 Project Description: Diversion of clean stormwater around Dam 3A with contaminated stormwater flowing into Dam 3A
 Job Title and Duties: Civil Engineer
 Hydrology, hydraulics design, structural design, drawings, BoQ and documentation.
 Value of Project: Capital build cost approximately R 1.5 Million
 Professional fees approximately R 200 000

Location: Centurion, Gauteng, South Africa
 Project duration & year: 2019
 Client: Sorex Estate
 Name of Project: Sorex Estate floodline
 Project Description: Floodline study and risk management
 Job Title and Duties: Civil Engineer
 Review existing infrastructure, assess bearing capacity of retaining wall, updating of floodlines and report.
 Value of Project: R 120 000

Location: Secunda, Mpumalanga, South Africa
 Project duration & year: 2018 – 2019
 Client: Sasol, Impumelelo Mine
 Name of Project: Sasol GN 704 Audit
 Project Description: GN 704 audit on Impumelelo Mine to ensure compliance
 Job Title and Duties: Civil Engineer
 Review existing infrastructure, determine clean, semi dirty and dirty water catchments and peak discharges, assess capacity of water infrastructure and compile report.
 Value of Project: R 150 000

Location: Welkom, Free State, South Africa
 Project duration & year: 2018 – 2019
 Client: Sibanya Stillwater, Beatrix Mine
 Name of Project: Beatrix Stormwater Management Plan
 Project Description: Stormwater Management Plan review and updating and Erosion Management Plan
 Job Title and Duties: Civil Engineer
 Review existing infrastructure, determine clean, semi dirty and dirty water catchments and peak discharges, assess capacity of water infrastructure and compile report.
 Compile erosion management plan
 Value of Project: R 350 000

Jeandré Thompson

Senior Civil Engineer

Key Experience: Mine development and upgrade plans

Location: Mpumalanga, South Africa
 Project duration & year: 2022 – Ongoing
 Client: Northam Platinum, Booyse dal
 Name of Project: Booyse dal ROM Pad
 Project Description: Design of new ROM Pad for Booyse dal operations
 Job Title and Duties: Senior Civil Engineer – Project Manager
 Design, site investigations, planning, reporting and project management
 Value of Project: Professional fees approximately R 1 800 000

Location: Segilola, Nigeria
 Project duration & year: 2021
 Client: Thor Resources
 Name of Project: Segilola Water Management Design
 Project Description: Design of pit dewatering borehole system, stormwater management and pit water management plan
 Job Title and Duties: Civil Engineer – Project Manager
 Borehole design, pumping and water management designs, reporting and project management
 Value of Project: Professional fees approximately R 1 500 000

Location: Steelpoort, Mpumalanga, South Africa
 Project duration & year: 2021
 Client: Anglo Platinum – Der Brochen Mine
 Name of Project: WRD and dam's expansion project
 Project Description: Design of Waste Rock Dump for the expansion of the Der Brochen mine – Northern Pit expansion – WULA Design
 Job Title and Duties: Civil Engineer – Project manager
 Design of WRD, compilation of BoQ and Drawings.
 Value of Project: Capital build cost approximately R 45 Million
 Professional fees approximately R 3 000 000

Location: Polokwane, Limpopo, South Africa
 Project duration & year: 2020 – Ongoing
 Client: AngloPlatinum – Polokwane Metallurgical Complex
 Name of Project: Polokwane Smelter slag dump - Phase 5 B, C and D expansion
 Project Description: Design of the Phase 5 B, C and D slag pads of capacity expansion
 Job Title and Duties: Civil Engineer
 Project management and review, drawings, reporting
 Value of Project: Professional fees approximately R 500 000

Location: Rustenburg, North West, South Africa
 Project duration & year: 2020
 Client: Impala Platinum Mines – Smelter
 Name of Project: Impala Slag Dump CoP
 Project Description: Updating of the Operations and Maintenance Manual and CoP
 Job Title and Duties: Civil Engineer
 Project management and review and reporting
 Value of Project: Professional fees approximately R 200 000

Jeandré Thompson

Senior Civil Engineer

Key Experience: Mine development and upgrade plans

Location: Polokwane, Limpopo, South Africa
 Project duration & year: 2020 – 2021
 Client: AngloPlatinum – Polokwane Metallurgical Complex
 Name of Project: Polokwane Smelter slag dump stability assessment
 Project Description: Stability assessment of the existing Polokwane Smelter slag dump and updating of the Operations and Maintenance Manual
 Job Title and Duties: Civil Engineer
 Project management and review, updating of O&M Manual
 Value of Project: Professional fees approximately R 200 000

Location: Marikana, Limpopo, South Africa
 Project duration & year: 2020
 Client: Sibanye Stillwater – WPL
 Name of Project: WPL Silt Trap
 Project Description: Design of new silt trap for TD6 at SDWA
 Job Title and Duties: Civil Engineer
 Design of silt trap, compilation of BoQ, drawings and reporting.
 Value of Project: Capital build cost approximately R 45 Million
 Professional fees approximately R 200 000

Location: Steelpoort, Mpumalanga, South Africa
 Project duration & year: 2019
 Client: Anglo Platinum – Der Brochen Mine
 Name of Project: WRD and dam's expansion project
 Project Description: Design of Waste Rock Dump for the expansion of the Der Brochen mine – Northern Pit expansion – Concept Design
 Job Title and Duties: Civil Engineer
 Design of WRD, compilation of BoQ and Drawings.
 Value of Project: Capital build cost approximately R 45 Million
 Professional fees approximately R 200 000

Location: Northwest, South Africa
 Project duration & year: 2019 – 2020
 Client: Harmony Gold – Kalgold
 Name of Project: WRD expansion project
 Project Description: Design of 3 waste rock dumps for the expansion of the Kalgold Mine WULA
 Job Title and Duties: Civil Engineer
 Design of WRDs, compilation of BoQ and Drawings.
 Value of Project: Professional fees approximately R 400 000

Location: Lumbumbashi, Democratic Republic of the Congo
 Project duration & year: 2015
 Client: Trafigura
 Name of Project: Lubumbashi Trafigura facilities
 Project Description: Rail and truck loading facility at the Lubumbashi facility for Trafigura.
 Job Title and Duties: Civil Engineer
 Stormwater design for a railway siding in line with Regulation 704. Design included drains, sumps, silt traps, oil and grease traps and a dirty water retention dam.
 Design of platforms for truck loading areas
 Value of Project: Capital build cost approximately USD 5 Million

Jeandré Thompson

Senior Civil Engineer

Key Experience: Mine development and upgrade plans

Location: Obuasi, Ghana
 Project duration & year: 2014 – 2015
 Client: AngloGold Ashanti
 Name of Project: Obuasi Storm Water Management Project
 Project Description: Storm water management construction designs for AngloGold Ashanti's mine close to Obuasi, Ghana. The design of 3 large channels and several road crossings culverts, lining of return water and storage dams, pumping systems for return water dams and filling of low areas where ponding occurs.

Job Title and Duties: Civil Engineer
 Designing the channels and energy dissipation structures, lining material, culverts and necessary earthworks.

Value of Project: Capital build cost approximately USD 5.06 Million

Location: Obuasi, Ghana
 Project duration & year: 2014
 Client: AngloGold Ashanti
 Name of Project: Obuasi Storm Water Management Project
 Project Description: Feasibility Study of a storm water management plan and dam linings for AngloGold Ashanti's mine close to Obuasi, Ghana. The design of 16 large channels and several road crossings culverts, lining of return water and storage dams, pumping systems for return water dams and filling of low areas where ponding occurs, perimeter fencing and internal roads drainage.

Job Title and Duties: Civil Engineer
 Hydrological study and drainage designing, road crossing culverts, perimeter fence line and roadside drainage as well as the compiling of the Bill of Quantities and design and feasibility study reports.

Value of Project: Capital build cost approximately USD 22.5 Million

Key Experience: Mine rehabilitation

Location: Rapholo River, Limpopo, South Africa
 Project duration & year: 2020
 Client: Anglo – Bekoni Mine
 Name of Project: Rapholo River Rehabilitant
 Project Description: Design of river rehabilitation plan to limit the impact of erosion on the riverbanks

Job Title and Duties: Civil Engineer and Project Manager
 Hydrology, modelling, design and reporting.

Value of Project: Capital build cost approximately R 25 Million
 Professional fees approximately R 800 000

Jeandré Thompson

Senior Civil Engineer

Key Experience: Mine rehabilitation

Location: South Africa, North West
 Project duration & year: 2017 - 2018
 Client: Sibanye-Stillwater
 Name of Project: Driefontein Rock dump No. 6 Rehabilitation plan
 Project Description: Development of a rehabilitation plan for the closure and rehabilitation of the No. 6 Rock Dump at the Sibanye-Stillwater Driefontein mine complex.
 Job Title and Duties: Civil Engineer
 Initial site investigations, closure concept, shaping and erosion protection of the rehabilitated area, stormwater hydrology and infrastructure design, drawings and bill of quantities, cost estimating and reporting.
 Value of Project: Capital build cost approximately R 12.5 million

Location: South Africa, Limpopo
 Project duration & year: 2016
 Client: Anglo American Platinum
 Name of Project: Mortimer Slag Stockpile Rehabilitation plan
 Project Description: Development of a rehabilitation plan for the closure of the Mortimer Slag Stockpile at the Union mine complex.
 Job Title and Duties: Civil Engineer
 Initial site investigations, closure concept, shaping and stability assessment of the residue deposit, drawings and bill of quantities, cost estimating and reporting.
 Value of Project: Capital build cost approximately R 40 million

Location: South Africa
 Project duration & year: 2015 – 2019
 Client: Mintek
 Name of Project: Derelict and Abandoned Mine Rehabilitation Project of South Africa

- Streatham (Burgersfort – Limpopo)
- Ga-Madiba (Mafefe - Limpopo)
- Betle (Mafefe - Limpopo)
- Mang la Mang (Mafefe - Limpopo)
- Masaneng (Masaneng - Northern Cape)
- Heuningvlei (Heuningvlei - Northern Cape)
- Sithilo (Sithilo - KwaZulu-Natal)

 Project Description: Design and construction monitor of the closure of several asbestos mines across South Africa as part of the Abandoned and Derelict Mines Rehabilitation Programme for the Department of Mineral Resources.
 Job Title and Duties: Civil Engineer, Project Manager and Construction Supervisor
 Initial site investigations, closure concept, preliminary and detailed designs (geotechnical, structural and hydraulic design, flood lines, and reporting), tender documentation, construction monitoring and closure documentation.
 Value of Project: Confidential (consultants' fee value > R 35 million)

Jeandré Thompson

Senior Civil Engineer

Key Experience: Water treatment works

Location: Tshwane, Gauteng, South Africa
 Project duration & year: 2017 – Ongoing
 Client: Department of Public Works
 Name of Project: Dept Public Works Sewerage Works
 Project Description: Upgrade and expansions to Sewerage Treatment Works owned and operated by Dept Public Works
 Job Title and Duties: Civil Engineer
 Engineer with responsibility for design and assist the design manager in general civil engineering works for the upgrade of various plants.
 Duties include:

- Design of structures, tanks and pipelines;
- Bill of Quantities;
- Specifications and Drawings, and
- Surveying and as-built measurements of existing structures.

 Value of Project: Capital build cost approximately R 150 million

Key Experience: Groundwater remediation

Location: Sasolburg, Free State, South Africa
 Project duration & year: 2018 – 2021
 Client: Sasol
 Name of Project: Bunsen Street PRB
 Project Description: Design of cut-off trench and PRB to effectively treat the groundwater in the Bunsen Street area.
 Job Title and Duties: Civil Engineer and Project Manager
 Design of trench and filter, sump and pipeline, drawings, BoQ, reporting, construction and project management
 Value of Project: Capital build cost approximately R 2.5 Million

Location: Brakpan, Gauteng, South Africa
 Project duration & year: 2018 – 2019
 Client: Lonmin Brakpan Precious Metals Refinery (PMR)
 Name of Project: Cut-off Trench Detail Design
 Project Description: Design of cut-off trenches around new effluent dam including associated sump and pump.
 Job Title and Duties: Civil Engineer and Project Manager
 Hydrogeological model design, trench and filter design, sump and pipeline design, drawings, BoQ, reporting and project management
 Value of Project: Capital build cost approximately R 1 Million

Location: Sasolburg, Free State, South Africa
 Project duration & year: 2017 - 2018
 Client: Sasol
 Name of Project: Groundwater remediation plan
 Project Description: Estimating the provisions needed for rehabilitation of the contaminated upper water table
 Job Title and Duties: Civil Engineer
 Design of cut-off and abstraction trenches, permeable reactive barriers and pumping systems
 Value of Project: Confidential (consultants' value > R 10 million)

Jeandré Thompson

Senior Civil Engineer

Key Experience: Pumps and pipelines

Location: Polokwane, Limpopo, South Africa
 Project duration & year: 2018
 Client: Anglo American Polokwane Smelter
 Name of Project: Return Water Pipeline
 Project Description: Design of return water pumping line from new pollution control dam to return water dam. 25 mm steel pipeline and automatically activated dual standby pumphouse
 Job Title and Duties: Civil Engineer
 Pumps station and pipeline design, drawings, BoQ and reporting
 Value of Project: Capital build cost approximately R 4 Million

Location: Langebaan, Western Cape, South Africa
 Project duration & year: 2016
 Client: Elandsfontein
 Name of Project: Elandsfontein Phosphate Mine Dewatering – Engineering Design
 Project Description: Feasibility Study and detailed design of the dewatering borehole and pumping scheme for the open pit at the Elandsfontein Phosphate mine.
 Job Title and Duties: Civil Engineer
 Engineer with responsibility of designing the pump and pipeline system that utilised 36 boreholes to dewater the pit area, pumping along two-delivery line of approx. 2 km to a balancing reservoir and discharging into reinjection boreholes. Compilation of Bill of Quantities and review of drawings.
 Value of Project: Capital build cost approximately R 50 Million

Key Experience: Railways

Location: Malawi
 Project duration & year: 2013 - 2014
 Client: Vale Limited
 Name of Project: Nacala Corridor Project
 Project Description: Section 3 and 5 of the Nacala Corridor Project, consisting of 140 km of new railway (Greenfields) and upgrade of 100 km of existing track (Brownfields). Total project running from Moatize in Mozambique, through the south of Malawi and to the port of Nacala on the east coast of Mozambique.
 Job Title and Duties: Design Support Department Coordinator and Civil Engineer
 Engineer with responsibility for drainage and earthworks design and assist the design manager in general civil engineering work.
 Duties:

- Coordinate Design and CAD department workflow and deliverables
- Carryout drainage design where required due to design changes
- Review contractor drainage design proposal and other value engineering
- Review method statement, materials proposal, and concrete design mix reports
- Review and respond to drainage related correspondence and other technical issues
- Provide design support to the production manager, RE and ARE
- Design of water course deviations and embankment protection
- Checking and controlling of drawings and documents for redesign work in CH 70 to CH 75
- Deal with site queries requiring drainage design and other technical and civil input
- Liaise with the contractor, the client and specialist consultants on technical matters
- Manages the drawing and the departments register

 Value of Project: Capital build cost approximately USD900 million

Jeandré Thompson

Senior Civil Engineer

Key Experience: Roads

Location:	Rustenburg, North West, South Africa
Project duration & year:	2017
Client:	Anglo Platinum Precious Metals Refinery (PMR)
Name of Project:	PMR Dam Relining Project
Project Description:	Provision of access road to dams including laydown areas and culverts
Job Title and Duties:	Civil Engineer Engineer with responsibility for drainage and earthworks design and assist the design manager in general civil engineering work. Duties: <ul style="list-style-type: none">• Design of access road and tie in to existing public road• Culvert crossings• Access control area, laydown and turning areas• Access ramps to dams
Value of Project:	Capital build cost approximately R 3.5 million

Christiaan Michiel Bauman

Partner | Principal Civil Engineer



Profession	Professional Civil Engineer
Education	Nat Dip, ADR, University of Pretoria / AFSA, 2007 Cert, Advanced Project Management, University of Pretoria, 2003 BEng, Civil, University of Pretoria, 1996
Registrations/ Affiliations	Pr. Eng., ECSA, 20020219 Pr. CPM, SACPCMP, D/1385/2006 Member, SAICE, 090925
Awards	None

Specialisation Hydraulics, storm water management, water / wastewater treatment plants, pump stations, pipelines, earth dams, tailings storage facilities, project / contract / construction management, dispute resolution.

Expertise Tiaan Bauman has been involved in the field of civil engineering for the past 25 years. His expertise includes:

- contract / project management;
- dispute resolution;
- design of pump stations and pipelines;
- design of storm water management systems;
- design of water / sewage treatment plants;
- design of dams;
- tailings storage facilities.

Employment

2020 – present	SRK Consulting (Pty) Ltd, Partner, Johannesburg, RSA
2019 - 2020	SRK Consulting (Pty) Ltd, Associate Partner, Johannesburg, RSA
2014 – 2019	SRK Consulting (Pty) Ltd, Principal Civil Engineer, Johannesburg, RSA
2013 – 2014	Quanta Services Africa (Pty) Ltd, Project Manager, Kempton Park, RSA
2006 – 2013	Golder Associates Africa (Pty) Ltd, Divisional Leader, Midrand, RSA
2004 – 2006	Golder Associates Africa (Pty) Ltd, Musina Project Office, RSA
2002 – 2004	Golder Associates Africa (Pty) Ltd, Design Engineer/Project Manager, Johannesburg, South Africa
1997 – 2002	GFJ (Pty) Ltd, Junior Civil Engineer, Pretoria, South Africa

Publications Poster Presentation at the 2002 WISA Conference: Filter Integrity Assessment at the Midvaal Water Care Company

Languages Afrikaans – read, write, speak
English – read, write, speak

Christiaan Michiel Bauman

Partner | Principal Civil Engineer

Key Experience

Dams

Location:	Mokopane, Limpopo
Project duration & year:	2021
Client:	Anglo American Platinum – Mogalakwena Operations
Name of Project:	Mogalakwena South Concentrators – Relining of the SWS Dam
Project Description:	Relining Design of the MSC SWS Dam
Job Title and Duties:	Lead Engineer responsible for the design
Value of Project:	N/A
Location:	Rustenburg, North-West Province
Project duration & year:	2021
Client:	Siyabanye StillWater – Marikana
Name of Project:	Dam Safety Inspection of TD2 Return Water Dam
Project Description:	Five Yearly DSO Dam Safety Inspection. Compile DSE report for submission to DWS DSO.
Job Title and Duties:	Lead Engineer - Approved Professional Person (APP)
Value of Project:	N/A
Location:	Rustenburg, North-West Province
Project duration & year:	2020
Client:	Anglo American Platinum – Precious Metals Refiners
Name of Project:	Safety Inspection of Process Water Dams 1, 2, 3A, 3B, 4, 5, 6E & 6W
Project Description:	Interim Dam Safety Inspection of the process water effluent dams. Compile inspection report for submission to Anglo PMR.
Job Title and Duties:	Lead Engineer. Conduct Inspection and Compile Report.
Value of Project:	N/A
Location:	Rustenburg, North-West Province
Project duration & year:	2019
Client:	Anglo American Platinum – Precious Metals Refiners
Name of Project:	Relining of Dam #3A
Project Description:	Design / quality control of the liner system for the existing storm water dam
Job Title and Duties:	Design lead
Value of Project:	N/A
Location:	Limpopo, South Africa
Project duration & year:	2020
Client:	Private Farmer
Name of Project:	Farm Dam Design
Project Description:	Design of a New 230,000m ³ earth embankment water storage dam
Job Title and Duties:	Lead Engineer / Lead Designer
Value of Project:	N/A
Location:	Rustenburg, North-West Province
Client:	Anglo American Platinum – Precious Metals Refiners
Name of Project:	Relining of Dam #2
Project Description:	Design of the realigning of the existing process effluent dam (Multiple HDPE liners)
Job Title and Duties:	Design lead
Value of Project:	R 20m
Location:	Rustenburg, North-West Province
Client:	Anglo American Platinum – Precious Metals Refiners
Name of Project:	Dam 3A Storm Water Management
Project Description:	Design of a Storm Water Diversion Structure
Job Title and Duties:	Project Manager / Design lead
Value of Project:	R 2.5m

Christiaan Michiel Bauman

Partner | Principal Civil Engineer

Key Experience

Dams

Location:	Gauteng, South Africa
Client:	Siyabanya Stillwater
Name of Project:	Refurbishment of existing Storm / Dirty Water Dams
Project Description:	Design of liner and pumping system
Job Title and Duties:	Project Director / Reviewer
Value of Project:	R 5m
Location:	Mpumalanga, South Africa
Client:	South32 - Khutala Colliery
Name of Project:	Interim Dam safety Evaluation
Project Description:	Interim Dam Safety Evaluations of various process dams (7 off)
Job Title and Duties:	Principal Engineer / Reviewer
Value of Project:	N/A
Location:	Limpopo, South Africa
Client:	Anglo Platinum
Name of Project:	Mogalakwena 3 rd Concentrator
Project Description:	Preliminary Design of a new HDPE lined Pollution Control Dam (PCD)
Job Title and Duties:	Project Manager / Design Lead
Value of Project:	N/A
Location:	Kwazulu Natal, South Africa
Client:	Tronox KZN Sands
Name of Project:	Valley Return Water Dam Safety Evaluation
Project Description:	Safety Inspection of Dam as required by DWS
Job Title and Duties:	Assisting the APP / Compiling Safety Evaluation Report
Location:	Ogies, South Africa
Client:	Eskom – Kendal Power Station
Name of Project:	Storm Water Management Infrastructure (GN704 Compliance)
Project Description:	Detail Design of the Storm Water Management infrastructure around the ASH Dump Extension including the design of three (3) new dams
Job Title and Duties:	Project Management / Design Lead
Value of Project:	Approx. R 300m
Location:	Limpopo, South Africa
Project duration & year:	Current
Client:	Anglo Platinum
Name of Project:	Mogalakwena Bufferdam
Project Description:	Design of new HDPE lined Bufferdam (1.5 million m ³)
Job Title and Duties:	Project Manager / Design Lead for the new Mogalakwena Mine Buffer Dam (Capacity: 1.5Mm ³)
Value of Project:	Approx. R 500 m
Location:	Thabazimbi, Limpopo Province
Client:	Anglo American Platinum
Name of Project:	Safety Evaluation Inspection
Project Description:	Safety Inspection of Bierspruit Dam
Job Title and Duties:	Project Manager: Assisting the APP / Compiling Safety Evaluation Report
Value of Project:	N/A
Location:	Lesotho
Client:	Lucapa Diamond Company
Name of Project:	Mothae Diamond Mine Development / Expansion
Project Description:	Design of Stormwater and Water Supply Infrastructure including new Gravity Concrete Dam
Job Title and Duties:	Assisting the Design Lead
Value of Project:	N/A

Christiaan Michiel Bauman

Partner | Principal Civil Engineer

Key Experience

Dams	
Location:	Rustenburg, North-West Province
Client:	Anglo American Platinum – Precious Metals Refiners
Name of Project:	Relining of Dam #1
Project Description:	Design of the realigning of the existing process effluent dam (Multiple HDPE liners)
Job Title and Duties:	Design lead
Value of Project:	R 25m
Location:	North-West, South Africa
Client:	Lonmin PLC
Name of Project:	Tailings Dam 6 Expansion Project
Project Description:	Design of new TSF Infrastructure – Storage Dams
Job Title and Duties:	Project Management / Design Engineer
Value of Project:	R 12m (Fees)
Location:	Limpopo, South Africa
Client:	Anglo Platinum, Mogalakwena Mine
Name of Project:	Buffer Dam Trade-off Study
Project Description:	Trade-off study for the construction of Buffer Dams
Job Title and Duties:	Project Manager / Design Engineer
Value of Project:	R 0.5m (Fees)
Location:	Obuasi, Ghana
Client:	Anglo Gold Ashanti
Name of Project:	Obuasi Storm Water Management
Project Description:	Design of Storm Water Management Systems including channels and upgrade of existing storm water dams with HDPE liner systems
Job Title and Duties:	Project Management / Design Engineer
Value of Project:	USD 22 m (Estimated)
Location:	Standerton, South Africa
Client:	Anglo American Thermal Coal
Name of Project:	Construction of a new Brine Disposal Facility
Project Description:	Earthworks (Dams with Multiple HDPE liners system), Concrete Works, Pipelines
Job Title and Duties:	Construction Project Manager
Value of Project:	R160m
Location:	Witbank, South Africa
Client:	Vanchem Vanadium Products (Pty) Ltd
Name of Project:	Construction of a New Waste Disposal Facility
Project Description:	Earthworks (Dams with multiple HDPE liners systems) Concrete Works, Pipelines
Job Title and Duties:	Construction Project manager
Value of Project:	R90m
Location:	Pharaborwa, South Africa
Project duration & year:	2002
Client:	Palabora Mining Company Limited
Name of Project:	Stormwater Management System (Earthdams)
Project Description:	Design of new earth storm retaining dams inside the Palabora Open Pit
Job Title and Duties:	Design Engineer
Value of Project:	R30m

Christiaan Michiel Bauman

Partner | Principal Civil Engineer

Key Experience

Storm Water

Location:	Steelpoort, South Africa
Project duration & year:	2021
Client:	Anglo American Platinum (AAP)
Name of Project:	Mareesburg Tailings Dam Project
Project Description:	Design of the TSF Upstream PMF Storm Water Channel
Job Title and Duties:	Lead design Engineer
Value of Project:	N/A
Location:	Limpopo, South Africa
Project duration & year:	2021
Client:	Anglo American Platinum – Mogalakwena Operations
Name of Project:	Mogalakwena South Concentrators – SWS Dam Silt Trap Implementation
Project Description:	Assisting AAP with the SWS Dam Silt Trap Implementation
Job Title and Duties:	Design Engineer.
Value of Project:	N/A
Location:	Rustenburg, North-West Province
Project duration & year:	2021
Client:	Anglo American Platinum – Rustenburg Base Metal Refinery (RBMR)
Name of Project:	Dam 3B Inlet Channel Assessment
Project Description:	Hydraulic Modelling of Dam 3B Inlet Channel
Job Title and Duties:	Lead Engineer – Project Management
Value of Project:	N/A
Location:	Rustenburg, North-West Province
Project duration & year:	2021
Client:	Anglo American Platinum – Rustenburg Base Metal Refinery (RBMR)
Name of Project:	Dam 3B Dam Break Analysis
Project Description:	Modelling of RBMR Dam 3B Dam Break Analysis.
Job Title and Duties:	Lead Engineer – Project Management
Value of Project:	N/A
Location:	Northern Cape, South Africa
Client:	South 32 (Wessels Mine)
Name of Project:	Wessels Mine Storm Water Design
Project Description:	Design of various storm water measures around the mine including Pollution Control Dams (GN 704), Storm Water Drains
Job Title and Duties:	Project Management / Design Lead
Value of Project:	R 50 m (estimated)
Location:	Limpopo, South Africa
Client:	Anglo American Platinum
Name of Project:	Mareesburg TSF
Project Description:	Design of various Storm Water Management Infrastructure around the new TSF
Job Title and Duties:	Design Lead on SW infrastructure
Value of Project:	N/A
Location:	Mokopane, South Africa
Client:	Anglo Platinum
Name of Project:	Mogalakwena GN704
Project Description:	Various Storm Water Management Projects
Job Title and Duties:	Project Manager / Design Lead for the Regulation 704 stormwater management project
Value of Project:	R2.0m (Fees)

Christiaan Michiel Bauman

Partner | Principal Civil Engineer

Key Experience

Storm Water

Location: Tete, Mozambique
 Client: Vale, Mozambique
 Name of Project: Various Storm Water Management Projects
 Project Description: Design of various storm water measures
 Job Title and Duties: Civil design lead for the design of various storm water measures
 Value of Project: USD 10m

Location: Ogies, South Africa
 Client: Eskom – Kendal Power Station
 Name of Project: Storm Water Management (GN704 Compliance)
 Project Description: Concept Design of Storm Water Management around ASH Dump
 Job Title and Duties: Project Management / Design Engineer
 Value of Project: N/A

Location: Ogies, South Africa
 Client: Rietspruit Mine
 Name of Project: Rietspruit Storm Water management Project
 Project Description: Earthworks and Gabions Construction
 Job Title and Duties: EPC Construction Manager
 Value of Project: R 15m

Key Experience

Water- and Wastewater Treatment

Location: Pretoria, South Africa
 Client: Department of Public Works
 Name of Project: Upgrading of ten (10) WWTW surrounding Pretoria
 Project Description: Design of the upgrading of various WWTW's (0.5 MI/d – 2 MI/d)
 Job Title and Duties: Civil Design Lead for the design of the upgrade
 Value of Project: R 150 m (estimated)

Location: Pretoria, South Africa
 Client: NECSA
 Name of Project: Construction of a Wastewater Treatment Plant (1MI /day)
 Project Description: Earthworks, Concrete Structures, Pipeline, Pump Station, Commissioning - Value
 Job Title and Duties: Construction Project Manager
 Value of Project: R20 m

Location: Pullenshope, South Africa
 Client: Optimum Coal Mine (Pty) Ltd
 Name of Project: Optimum Mine Water Reclamation Plant Project
 Project Description: Hazardous Facility with multiple HDPE liners system, Concrete Works, Mechanical Works, Pipelines (18.75MI/d),
 Job Title and Duties: EPCM Contract Manager (Client Representative)
 Value of Project: R550m

Location: Pretoria South Africa
 Client: City of Tshwane Metropolitan Municipality
 Name of Project: Module 4 Extension to the Sunderland Ridge Wastewater Treatment Works (20 MI/d)
 Project Description: Earthworks, Concrete Works, Mechanical Works, Pipelines)
 Job Title and Duties: Site Supervision (Resident Engineer) of new 20MI/day extension
 Value of Project: R130m

Christiaan Michiel Bauman

Partner | Principal Civil Engineer

Key Experience

Water- and Wastewater Treatment

Location: Zeerust, South Africa
 Client: Zeerust Local Municipality
 Name of Project: Rehabilitation of the Motswedi Water Treatment Plant (2MI/day)
 Project Description: Design of new rapid gravity filters for the Water Treatment Plant
 Job Title and Duties: Design Engineer
 Value of Project: R10m

Location: Thohoyandou, South Africa
 Client: Department of Water Affairs
 Name of Project: Nandoni Water Treatment Plant (60MI/day)
 Project Description: The design of the Nandoni Water Treatment Plant
 Job Title and Duties: Hydraulic and Civil design of the Water Treatment Plant
 Value of Project: N/A

Key Experience

Water- and Wastewater Treatment

Location: Asmara, Eritrea
 Client: Eritrea Government
 Name of Project: Eritrea Water Treatment Plant
 Project Description: Hydraulic and Civil design of the Water Treatment Plant
 Job Title and Duties: Design Engineer
 Value of Project: N/A

Location: Pretoria, South Africa
 Client: Pretoria Municipality
 Name of Project: Extension to the Rietvlei Water Treatment Plant
 Project Description: Design and Supervision of the open bed GAC gravity filters (20 MI/d)
 Job Title and Duties: Hydraulic and Civil Design
 Value of Project: N/A

Location: Heidelberg, South Africa
 Client: Heidelberg Municipality
 Name of Project: Ratanda Wastewater Treatment Plant
 Project Description: Hydraulic and Civil design of the Sewage Treatment Plant (5 MI/d)
 Job Title and Duties: Design Engineer
 Value of Project: N/A

Key Experience

Pumps and Pipelines

Location: Vereeniging, South Africa
 Client: Rand Water
 Name of Project: Pump Station Mass Balance Software
 Project Description: Design and Installation of Mass Balance Software
 Job Title and Duties: Design Engineer
 Value of Project: N/A

Location: Hartbeespoort, South Africa
 Client: Schoemansville Municipality
 Name of Project: Extensions to the Schoemansville High Lift Pump Station
 Project Description: Civil and Mechanical design of the High Lift Pump Station
 Job Title and Duties: Design Engineer

Christiaan Michiel Bauman

Partner | Principal Civil Engineer

Key Experience

Location:	Pretoria, South Africa
Client:	Department of Public Works
Name of Project:	Upgrading of ten (10) WWTW surrounding Pretoria
Project Description:	Design of a new rising main from Baviaanspoort Correctional services to Baviaanspoort Municipal WWTW (280 mm HDPE) including surge analysis and mitigation measures
Job Title and Duties:	Design lead for the design of the upgrade
Value of Project:	N/A
Location:	Tete, Mozambique
Client:	Vale, Mozambique
Name of Project:	Water Management and Dust Suppression
Project Description:	Design of pipeline (315 mm HDPE), pump stations and storage tanks for dust suppression including surge analysis and mitigation measures
Job Title and Duties:	Design lead for the design of the dust suppression system
Value of Project:	USD 5m
Client:	Elandsfontein Mine
Name of Project:	Pit De-watering Project
Project Description:	Design of a pit dewatering system including, boreholes, pipelines (380 mm HDPE), pumps, storage reservoirs and re-injection boreholes, including surge analysis and mitigation measures
Job Title and Duties:	Project Manager / Design Lead
Value of Project:	R 0.8m (Fees)
Location:	Phalaborwa, South Africa
Client:	Palabora Mining Company Limited
Name of Project:	Stormwater Management Pumping Stations (Phase II)
Project Description:	New high lift pumping station (2500kW installed capacity) and pipelines (500mm dia, 64 Bar, 3km) inside the open Pit including surge analysis and mitigation measures
Job Title and Duties:	Civil and mechanical Design (incl. contract administration)
Value of Project:	R50m
Location:	Phalaborwa, South Africa
Client:	Palabora Mining Company Limited
Name of Project:	Stormwater Management Pumping Stations (Phase I)
Project Description:	New High Lift Pimping Stations (4x850kW installed capacity) and pipelines (400mm dia, 36 Bar, 12km) inside the open Pit including surge analysis and mitigation measures
Job Title and Duties:	Civil and Mechanical design (incl. contract administration)
Value of Project:	R35m
Location:	Johannesburg, South Africa
Client:	South Deep
Name of Project:	Tailings Delivery Pipelines
Project Description:	Design of Tailings delivery Pipelines and Pumps
Job Title and Duties:	Design Engineer
Value of Project:	N/A
Location:	Hartbeespoort, South Africa
Client:	Schoemansville Municipality
Name of Project:	Kommandonek Rising and Gravity Mains
Project Description:	Design of the 250 / 300mm ductile iron rising and gravity mains including surge analysis and mitigation measures
Job Title and Duties:	Design Engineer
Value of Project:	N/A

Christiaan Michiel Bauman

Partner | Principal Civil Engineer

Key Experience

Pumps and Pipelines

Location: Thohoyandou, South Africa
 Client: Department of Water Affairs
 Name of Project: Nandoni High Lift Pumping Station
 Project Description: Civil and Mechanical design of the Nandoni Water Treatment Plant high lift pumping station (Approx. 1.5 m³ / d), 800 mm Dia Steel pipe including surge analysis and mitigation measures
 Job Title and Duties: Design Engineer
 Value of Project: N/A

Location: Pretoria, South Africa
 Client: Pretoria Municipality
 Name of Project: Extensions to the Rietvlei High Lift Pump Station
 Project Description: Mechanical and Civil design including potable water pipeline (700mm Dia Steel) design, surge analysis and mitigation measures
 Job Title and Duties: Design Engineer
 Value of Project: N/A

Key Experience

Tailings Related

Location: Steelpoort, South Africa
 Client: Anglo Platinum
 Name of Project: Maresburg Tailings Dam Project
 Project Description: Options Analysis for Alternative Tailings Deposition Method
 Job Title and Duties: Project Manager for the Options Analysis Study Project
 Value of Project: N/A

Location: Steelpoort, South Africa
 Client: Anglo Platinum
 Name of Project: Twickenham Tailings Dam Project
 Project Description: Feasibility study for the new Twickenham Tailings Storage Facility
 Job Title and Duties: Part of team conducting feasibility study mainly responsible for the water management.
 Value of Project: R 10m (fees)

Location: Steelpoort, South Africa
 Client: Anglo Platinum
 Name of Project: Maresburg Tailings Dam Project
 Project Description: Feasibility study for the replacement of the existing Helena Tailings Storage Facility
 Job Title and Duties: Part of team conducting feasibility study mainly responsible for the water management.
 Value of Project: R 15m (Fees)

Location: Steelpoort, South Africa
 Client: Anglo Platinum
 Name of Project: Twickenham Tailings Dam Project
 Project Description: Feasibility study for the new Twickenham Tailings Storage Facility
 Job Title and Duties: Part of team conducting feasibility study mainly responsible for the water management.
 Value of Project: R 10m (fees)

Christiaan Michiel Bauman

Partner | Principal Civil Engineer

Key Experience

Location:
Client:
Name of Project:
Project Description:

Job Title and Duties:

Value of Project:

Tailings Related

Steelpoort, South Africa
Anglo Platinum
Mareesburg Tailings Dam Project
Feasibility study for the replacement of the existing Mareesburg Tailings Storage Facility

Part of team conducting feasibility study mainly responsible for the water management.
R 15m (Fees)

Location:
Client:
Name of Project:
Project Description:
Job Title and Duties:
Value of Project:

Moatize (Tete Province), Mozambique
VALE Mozambique
Tailings Storage Facility
Earthworks Concrete Works, Mechanical Works, Pipelines
Part-time Technical Assistance during Constructions
R300m
Project won a commendation on the 2011 CSA awards functions

Location:
Client:
Name of Project:
Project Description:

Job Title and Duties:
Value of Project:

Alldays, South Africa
De Beers Consolidated Mines – Venetia Mine Operation
Construction of a New Fine Residue Deposit Facility
New Fines Residue Deposit Facility (Earthworks, Concrete Works Mechanical Works, pipelines
Project Office / Site Supervision (Resident Engineer)
R110m

Key Experience

Location:
Client:
Name of Project:
Project Description:
Job Title and Duties:
Value of Project:

General Civil Engineering

Rustenburg, North-West Province
Anglo American Platinum – Precious Metals Refiners
Emergency Storage Pad
Design of the Emergency Storage Pad
Project Management / Design Lead
N/A

Location:
Client:
Name of Project:
Project Description:
Job Title and Duties:
Value of Project:

Marikana, South Africa
Lonmin Platinum Marikana Smelter
Dual Alkali Effluent Sump
Design of new concrete Emergency Effluent Sump
Project Management / Design Lead
R 12 m

Location:
Client:
Name of Project:
Project Description:
Job Title and Duties:

Limpopo, South Africa
Anglo Platinum
Mogalakwena 3rd Concentrator
Preliminary Design of the new live stockpile's foundations
Project Manager / Design Lead

Location:
Client:
Name of Project:
Project Description:
Job Title and Duties:
Value of Project:

Johannesburg, South Africa
City Power
City power emergency Restoration Project
Restoration of Transmission lines after damage
Project Manager
R13.5 m

Appendix B: Specialist Declaration



environmental affairs

Department:
Environmental Affairs
REPUBLIC OF SOUTH AFRICA

DETAILS OF THE SPECIALIST, DECLARATION OF INTEREST AND UNDERTAKING UNDER OATH

	(For official use only)
File Reference Number:	
NEAS Reference Number:	DEA/EIA/
Date Received:	

Application for authorisation in terms of the National Environmental Management Act, Act No. 107 of 1998, as amended and the Environmental Impact Assessment (EIA) Regulations, 2014, as amended (the Regulations)

PROJECT TITLE

PROPOSED SOYUZ 4 WIND ENERGY FACILITY IN THE NORTHERN CAPE PROVINCE

Kindly note the following:

1. This form must always be used for applications that must be subjected to Basic Assessment or Scoping & Environmental Impact Reporting where this Department is the Competent Authority.
2. This form is current as of 01 September 2018. It is the responsibility of the Applicant / Environmental Assessment Practitioner (EAP) to ascertain whether subsequent versions of the form have been published or produced by the Competent Authority. The latest available Departmental templates are available at <https://www.environment.gov.za/documents/forms>.
3. A copy of this form containing original signatures must be appended to all Draft and Final Reports submitted to the department for consideration.
4. All documentation delivered to the physical address contained in this form must be delivered during the official Departmental Officer Hours which is visible on the Departmental gate.
5. All EIA related documents (includes application forms, reports or any EIA related submissions) that are faxed; emailed; delivered to Security or placed in the Departmental Tender Box will not be accepted, only hardcopy submissions are accepted.

Departmental Details

Postal address:

Department of Environmental Affairs
Attention: Chief Director: Integrated Environmental Authorisations
Private Bag X447
Pretoria
0001

Physical address:

Department of Environmental Affairs
Attention: Chief Director: Integrated Environmental Authorisations
Environment House
473 Steve Biko Road
Arcadia

Queries must be directed to the Directorate: Coordination, Strategic Planning and Support at:
Email: EIAAdmin@environment.gov.za

1. SPECIALIST INFORMATION

Specialist Company Name:	SRK CONSULTING (PTY) LTD			
B-BBEE	Contribution level (indicate 1 to 8 or non-compliant)	1	Percentage Procurement recognition	135 %
Specialist name:	JENNIFER MENEGHELLI			
Specialist Qualifications:	BSC CIVIL ENGINEERING			
Professional affiliation/registration:	PROFESSIONAL ENGINEER 20180332 ENGINEERING COUNCIL OF SOUTH AFRICA			
Physical address:	265 OXFORD ROAD, ILLOVO 2196 JOHANNESBURG SOUTH AFRICA			
Postal address:	P.O. BOX 55291 NORTHLANDS 2116 JOHANNESBURG SOUTH AFRICA			
Postal code:	2116	Cell:	076 576 2470	
Telephone:	011 441 1111	Fax:	086 555 0944	
E-mail:	JMENEGHELLI@SRK.CO.ZA			

2. DECLARATION BY THE SPECIALIST

I, JENNIFER MENEGHELLI, declare that –

- I act as the independent specialist in this application;
- I will perform the work relating to the application in an objective manner, even if this results in views and findings that are not favourable to the applicant;
- I declare that there are no circumstances that may compromise my objectivity in performing such work;
- I have expertise in conducting the specialist report relevant to this application, including knowledge of the Act, Regulations and any guidelines that have relevance to the proposed activity;
- I will comply with the Act, Regulations and all other applicable legislation;
- I have no, and will not engage in, conflicting interests in the undertaking of the activity;
- I undertake to disclose to the applicant and the competent authority all material information in my possession that reasonably has or may have the potential of influencing - any decision to be taken with respect to the application by the competent authority; and - the objectivity of any report, plan or document to be prepared by myself for submission to the competent authority;
- all the particulars furnished by me in this form are true and correct; and
- I realise that a false declaration is an offence in terms of regulation 48 and is punishable in terms of section 24F of the Act.

SRK Consulting - Certified Electronic Signature

590237/44954/Report
9786-51-813-MENU-30/01/2023
This signature has been printed digitally. The Author has given permission for its use for this document. The details are stored in the SRK Signature Database.

Signature of the Specialist

SRK CONSULTING (PTY) LTD

Name of Company:

2023/01/30

Date

Details of Specialist, Declaration and Undertaking Under Oath

3. UNDERTAKING UNDER OATH/ AFFIRMATION

I, JENNIFER MENEGHELLI, swear under oath / affirm that all the information submitted or to be submitted for the purposes of this application is true and correct.



Signature of the Specialist

SRK CONSULTING (PTY) LTD

Name of Company

2022/11/15

Date



ALLAN ROBERT LABRUM
COMMISSIONER OF OATHS
~~REGISTERED~~ PRACTISING ATTORNEY / EX OFFICIO
12 PRIVET CRESCENT, RANDPARK RIDGE
EXT 24. RANDBURG

Signature of the Commissioner of Oaths

15/11/2022

Date

Appendix C: Checklist for Appendix 6 of GN 326 EIA Regulations (2017) – Specialist Reports

Requirements from Appendix 6 of GN 326 EIA Regulation 2017	Chapter
(a) Details of - (i) The specialist who prepare the report; and (ii) The expertise of that specialist to compile a specialist report including a curriculum vitae.	Appendix A
(b) A declaration that the specialist is independent in a form as may be specified by the competent authority.	Appendix B
(c) An indication of the scope of, and purpose for which, the report was prepared.	Section 1.
(cA) An indication of the quality and age of base data used for the specialist report.	Section 2. and 4.
(cB) A description of existing impacts on the site, cumulative impacts of the proposed development and levels of acceptable change.	Section 10.
(d) The duration, date and season of the site investigation and the relevance of the season to the outcome of the assessment.	Section 2.
(e) A description of the methodology adopted in preparing the report or carrying out the specialised process inclusive of equipment and modelling used.	Section 2.
(f) Details of an assessment of the specific identified sensitivity of the site related to the proposed activity or activities and its associated structures and infrastructure, inclusive of a site plan identifying site alternatives.	Section 6 and 10.
(g) An identification of any areas to be avoided, including buffers.	Section 6.
(h) A map superimposing the activity including the associated structures and infrastructure on the environmental sensitivities of the site including areas to be avoided, including buffers.	Section 6.
(i) A description of any assumptions made and uncertainties or gaps in knowledge.	Section 1.
(j) A description of the findings and potential implications of such findings on the impact of the proposed activity or activities.	Section 10.
(k) Any mitigation measures for inclusion in the EMPr.	Section 10.
(l) Any conditions for inclusion in the environmental authorisation.	Section 10.
(m) Any monitoring requirements for inclusion in the EMPr or environmental authorisation.	Section 9.
(n) A reasoned opinion – (i) as to whether the proposed activity, activities or portions thereof should be authorised. (iA) regarding the acceptability of the proposed activity or activities; and (ii) if the opinion is that the proposed activity, activities or portions thereof should be authorised, any avoidance, management, and mitigation measures that should be included in the EMPr, and where applicable, the closure plan.	Section 11.
<i>(o) Description of any consultation process that was undertaken during preparing the specialist report</i>	<i>None required.</i>
<i>(p) A summary and copies of any comments received during any consultation process and where applicable all responses thereto</i>	<i>None required.</i>
<i>(q) Any other information requested by the competent authority</i>	<i>None required.</i>

Appendix D: SDF Peak Flow Calculation



590608: Appendix D - Britstown WEF Cluster Standard Design Flood (SDF) Calculations

1. Introduction and Scope of Report

The peak flows of the sub-catchments delineated within the Britstown study area were calculated using the SDF method outlined in the Drainage Manual (reference). The calculations and steps are outlined in the Section 2.

2. Standard Design Flood Calculations

2.1 Step 1: Identify the drainage basin in which the site is located

The Britstown WEF cluster is located within SDF Basin 12 as determined from the SDF Drainage Basin map in Figure 1 below.

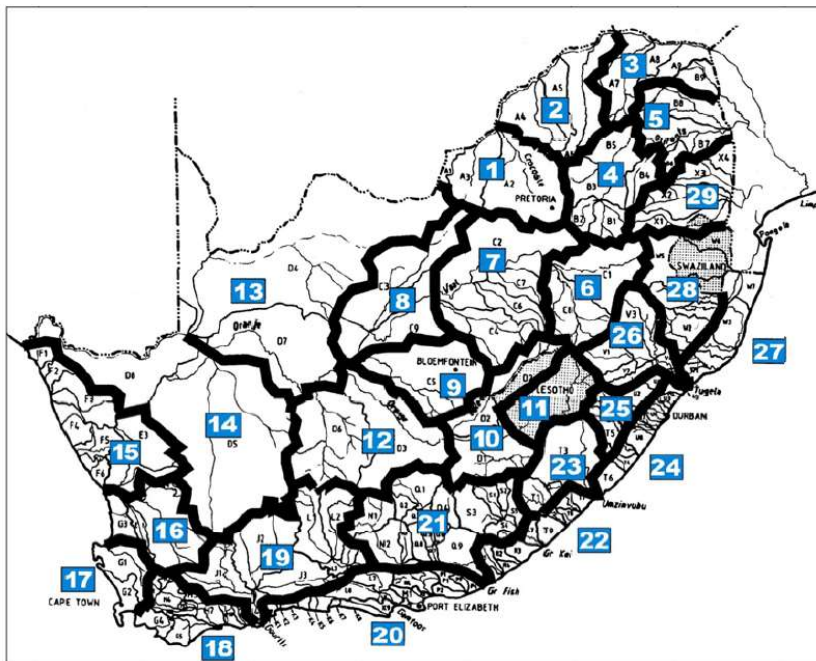

Figure 1: SDF Drainage Basin Map

Partners R Armstrong, P Aucamp, JS Bartels, CM Bauman, N Brien, JM Brown, LSE Coetser, CD Dalglish, BM Engelsman, R Gardiner, M Hinsch, SG Jones, W Jordaan, WC Joughin, DA Killan, F Lake, JA Lake, NG Macfarlane, V Maharaj, I Mahomed, HAC Meintjes, MJ Morris, DH Mossop, GP Nel, VS Reddy, S Reuther, PJ Shepherd, T Shepherd, MJ Sim, JS Stiff, M van Huyssteen, AT van Zyl, MD Wanless, CJ Wessels, ML Wertz, A Wood

Directors WC Joughin, V Maharaj, T McGurk, VS Reddy, T Shepherd, JS Stiff, AT van Zyl

Associate Partners PL Burnmeister, LI Boshoff, T Claassen, SA de Villiers, IT Doku, M du Toit, LM Linzer, B Mabenge, JI Mainama, RD O'Brien, AM Robertshaw, LC Shand

Consultants JR Dixon, PrEng, GC Howell, PrEng, PhD, WC Joughin, PrEng, MSc, PR Labrum, PrEng, LM Linzer, PrSci Nat, PhD, SA Lorentz, PhD, RRW McNeill, PrTech Eng, HAC Meintjes, PrEng, MSc, PN Rosewarne, PrSci Nat, MSc, VM Simposya, PrSci Nat, AA Smithen, PrEng, TR Stacey, PrEng, DSc, PJ Terbrugge, PrSci Nat, MSc, HFJ Theart, PrSci Nat, PhD, DJ Venter, PrTech Eng

African Offices:

Cape Town	+ 27 (0) 21 659 3060
Durban	+ 27 (0) 31 279 1200
East London	+ 27 (0) 43 748 6292
Johannesburg	+ 27 (0) 11 441 1111
Pietermaritzburg	+ 27 (0) 33 347 5069
Gqeberha (Port Elizabeth)	+ 27 (0) 41 509 4800
Pretoria	+ 27 (0) 12 361 9821
Accra	+ 23 (3) 24 485 0928
Lubumbashi	+ 243 (0) 81 999 9775

Group Offices:

Africa
 Asia
 Australia
 Europe
 North America
 South America



2.2 Step 2 - 5: Catchment characteristics

The delineation of the catchments were undertaken using HEC-HMS. A resolution of 500 km² was used for the minimum sizing of the catchments, due to the size of the cluster area. The catchment characteristics were extracted from the model and the values are provided in Table 1 below.

Table 1: Catchment characteristics

Sub-catchment	SDF Basin (Step 1)	Catchment Area (Step 2)	Longest Flow Length (Step 3)	10-85 Flowpath Slope (m/m)	T _c (hrs) (Step 5)	T _c (min)
E	12	1404.5	81.1	0.004	20.1	1205.4
D	12	290.9	40.8	0.003	10.2	609.6
F	12	1577.1	88.4	0.002	37.9	2272.8
H	12	686.1	58.7	0.003	15.6	936.7
C	12	924.2	61.2	0.003	18.0	1079.4
A	12	792.3	56.5	0.004	13.2	794.7
B	12	1682.2	91.1	0.003	26.9	1611.1

2.3 Step 6: Point precipitation

The point precipitation was obtained from the Design Rainfall Estimation software (Smithers & Schulze, 2002). The storm event values were obtained for the specified rainfall station Thomasgat (0169090_W). Linear interpolation was used to calculate the point precipitation based on the calculated time of concentration.

Table 2: Point precipitation

Point Precipitation (mm) (Step 6)								
Sub-catchment	T _c (hrs)	2	5	10	20	50	100	200
E	20.1	38.5	54.5	65.7	77.1	92.7	105.1	118.0
D	10.2	32.8	46.3	55.9	65.5	78.8	89.4	100.4
F	37.9	46.1	64.7	78.1	91.8	110.5	125.1	140.7
H	15.6	36.4	51.3	61.9	72.6	87.3	99.1	111.3
C	18.0	37.6	53.0	64.0	75.1	90.3	102.4	115.0
A	13.2	34.9	49.3	59.5	69.8	83.9	95.2	107.0
B	26.9	41.4	58.3	70.4	82.7	99.5	112.8	126.7

2.4 Step 7: Rainfall intensity

The point precipitation was multiplied by the area reduction factor (Table 3) to determine the average rainfall over the catchment (Table 4) for the required return period. The corresponding rainfall intensity was obtained by dividing the value by the time of concentration (T_c).

Table 3: Area reduction factor

Area Reduction Factor (Step 7.1)								
Sub-catchment	T _c (hrs)	2	5	10	20	50	100	200
E	20.1	85.2	85.2	85.2	85.2	85.2	85.2	85.2
D	10.2	94.6	94.6	94.6	94.6	94.6	94.6	94.6
F	37.9	84.4	84.4	84.4	84.4	84.4	84.4	84.4
H	15.6	89.7	89.7	89.7	89.7	89.7	89.7	89.7
C	18.0	87.8	87.8	87.8	87.8	87.8	87.8	87.8
A	13.2	88.8	88.8	88.8	88.8	88.8	88.8	88.8
B	26.9	84.0	84.0	84.0	84.0	84.0	84.0	84.0

Table 4: Average rainfall

Average Rainfall % (Step 7.2)								
Sub-catchment	Tc (hrs)	2	5	10	20	50	100	200
E	20.1	32.8	46.4	55.9	65.7	79.0	89.5	100.5
D	10.2	31.0	43.8	52.9	62.0	74.6	84.6	95.0
F	37.9	38.9	54.6	66.0	77.5	93.3	105.6	118.8
H	15.6	32.6	46.0	55.5	65.1	78.3	88.8	99.8
C	18.0	33.0	46.6	56.2	65.9	79.3	89.9	101.0
A	13.2	31.0	43.8	52.8	62.0	74.5	84.6	95.0
B	26.9	34.8	49.0	59.2	69.4	83.6	94.7	106.4

Table 5: Rainfall intensity

Rainfall Intensity I _r (Step 7.3)								
Sub-catchment	Tc (hrs)	2	5	10	20	50	100	200
E	20.1	1.6	2.3	2.8	3.3	3.9	4.5	5.0
D	10.2	3.1	4.3	5.2	6.1	7.3	8.3	9.4
F	37.9	1.0	1.4	1.7	2.0	2.5	2.8	3.1
H	15.6	2.1	2.9	3.6	4.2	5.0	5.7	6.4
C	18.0	1.8	2.6	3.1	3.7	4.4	5.0	5.6
A	13.2	2.3	3.3	4.0	4.7	5.6	6.4	7.2
B	26.9	1.3	1.8	2.2	2.6	3.1	3.5	4.0

2.5 Step 8: Run-off coefficient

The following parameters were obtained from **Table 3B.1: Information required for the calculation of the SDF** in the Drainage Manual:

Table 6: Drainage Basin 12 – information required for SDF calculation

Basin	SAWS Station Number	SAWS Site	M (mm)	R (mm)	C ₂ (%)	C ₁₀₀ (%)	MAP (mm)	MAE (mm)
12	143 258	Scheurfontein	23	52	5	30	290	2100

The table below (**Table 3.12** in the Drainage Manual) provided the return period factor Y_T.

Table 7: Return period Factor Y_T

T	2	5	10	20	50	100	200
Y _T	0	0.84	1.28	1.64	2.05	2.33	2.58

The parameters from Table 3B.1 as well as the return period factors in Table 3.12 were used as inputs to calculate the run-off coefficient for the range of return periods required.

$$C_T = \frac{C_2}{100} + \left(\frac{Y_T}{2.33} \right) \left(\frac{C_{100}}{100} - \frac{C_2}{100} \right)$$

Equation 1: Run-off coefficient

Table 8: Run-off Coefficient

Run-off coefficient C_T (Step 8)								
Sub-catchment	T_c (hrs)	2	5	10	20	50	100	200
E	20.1	0.1	0.1	0.2	0.2	0.3	0.3	0.3
D	10.2	0.1	0.1	0.2	0.2	0.3	0.3	0.3
F	37.9	0.1	0.1	0.2	0.2	0.3	0.3	0.3
H	15.6	0.1	0.1	0.2	0.2	0.3	0.3	0.3
C	18.0	0.1	0.1	0.2	0.2	0.3	0.3	0.3
A	13.2	0.1	0.1	0.2	0.2	0.3	0.3	0.3
B	26.9	0.1	0.1	0.2	0.2	0.3	0.3	0.3

2.6 Step 9: Peak Flows

The parameters C_T , I_T , and A were used as inputs for the calculation of the peak flows.

$$Q_T = \frac{C_T I_T A}{3,6}$$

Equation 2: SDF Peak flow calculation

Table 9: SDF Peak flow values

Peak Flows Q_T (Step 9)									
Sub-catchment	T_c (hrs)	Area	2	5	10	20	50	100	200
E	20.1	1404.54	32	126	204	288	414	522	638
D	10.2	290.91	12	49	79	111	160	202	247
F	37.9	1577.08	23	89	143	202	291	367	449
H	15.6	686.10	20	79	127	180	258	325	398
C	18.0	924.24	24	93	150	213	305	385	471
A	13.2	792.35	26	102	164	233	334	422	516
B	26.9	1682.25	30	119	193	273	393	494	605