



APPENDIX H:  
Public Participation for  
the EIA Phase  
PART 2

## APPENDICES

ENVIRONMENTAL IMPACT ASSESSMENT REPORT: Scoping and Environmental Impact Assessment (EIA) Process for the Proposed Development of a Solar Photovoltaic (PV) Facility (Kudu Solar Facility 3) and associated infrastructure, near De Aar, Northern Cape Province

---



# CONTENTS

<b>APPENDIX H.4: CORRESPONDENCE AND PROOF OF CORRESPONDENCE SENT TO STAKEHOLDERS FOR THE DRAFT EIA REPORT RELEASE</b>	<b>4</b>
1. Letter 5 sent via email to I&APs, Stakeholders and Organs of State: Notification of the Release of the Draft EIA Report for a 30-day Comment Period	5
2. Email 5 sent to I&APs, Stakeholders and Organs of State on 2 June 2023	7
3. Proof of SMS Text Messages sent to I&APs, Stakeholders and Organs of State (where cell phone numbers are available) on 3 June 2023	20
4. Proof of Upload of the DEIAR to the CSIR Project Website	29
5. Proof of Upload of the DEIAR to Google Drive (Kudu Solar Facility 3)	30
6. Proof of Upload of the DEIAR to SAHRIS (Kudu Solar Facility 3)	31
7. Follow-Up/ Reminder Email sent to all I&APs, Stakeholders, and Organs of State on 8 June 2023	32
8. Proof of Delivery of Follow Up/ Reminder Email sent to all I&APs, Stakeholders, and Organs of State on 8 June 2023	35
9. Follow-Up/ Reminder Email sent to all I&APs, Stakeholders, and Organs of State on 21 June 2023	39
10. Proof of Delivery of Follow Up/ Reminder Email sent to all I&APs, Stakeholders, and Organs of State on 21 June 2023	42
11. Proof of SMS Reminder Text Message sent to all I&APs, Stakeholders, and Organs of State (where cell phone numbers were available) on 21 June 2023	46
12. Personalised Reminder Email sent to key I&APs, Stakeholders and Organs of State (as determined by the DFFE) between 21 and 27 June 2023	56
13. Proof of Delivery of Personalised Reminder Email sent to key I&APs, Stakeholders and Organs of State (as determined by the DFFE) between 21 and 27 June 2023	80
14. Proof of Telephonic Communication and Communication Attempts with Key Stakeholders and I&APs between 26 and 28 June 2028	84
15. Proof of WhatsApp Communication with Key Stakeholders and I&APs between 26 June and 4 July 2023	87
16. Proof of SMS and Telephonic Communication with a Renosterberg Local Municipality Councillor	94
17. Reminder/ Notification of the Closure of Comment Period Email sent to all I&APs, Stakeholders and Organs of State on 3 July 2023	96

## APPENDICES

### ENVIRONMENTAL IMPACT ASSESSMENT REPORT: Scoping and Environmental Impact Assessment (EIA) Process for the Proposed Development of a Solar Photovoltaic (PV) Facility (Kudu Solar Facility 3) and associated infrastructure, near De Aar, Northern Cape Province

---

18. Proof of Delivery of the Notification of the Closure of the Comment Period Email sent to key I&APs, Stakeholders and Organs of State on 3 July 2023	99
19. Read Receipts of All Email Communication to Stakeholders During the DEIAR Release Phase	103
20. Automatic Replies Received in Response to All Email Communication Sent to Stakeholders During the DEIAR Release Phase	111

#### **APPENDIX H.5: PROOF OF SUBMISSION OF THE DRAFT EIA REPORT AND AMENDED APPLICATION FORM TO THE DFFE \_\_\_\_\_ 113**

1. Copy of Email sent to the DFFE for Submission of the DEIAR and Amended Application Form on 2 June 2023 (Kudu Solar Facility 3)	114
2. Proof of Upload of the DEIAR to the DFFE Novell S-Filer System on 2 June 2023 (Kudu Solar Facility 3)	115
3. DFFE Acknowledgement of Receipt of the DEIAR (Kudu Solar Facility 3)	116

#### **APPENDIX H.6: COMMENTS RECEIVED FROM STAKEHOLDERS DURING THE 30-DAY REVIEW OF THE DRAFT EIA REPORT \_\_\_\_\_ 117**

1. Comments Received from the Department of Forestry, Fisheries and the Environment (DFFE)	118
1.1 The DFFE Directorate: Integrated Environmental Authorisation (Kudu Solar Facility 3)	118
1.2 The DFFE Directorate: Biodiversity Conservation	122
1.3 The DFFE Directorate: Protected Areas	126
2. Comments received from the Department of Agriculture, Land Reform and Rural Development	127
3. Comments received from the South African Civil Aviation Authority (SACAA)	134
4. Comments received from the South African Heritage Resources Agency (SAHRA)	154
5. Comments received from the Department of Defence (DoD)	166
6. Comments received from the Department of Water and Sanitation (DWS)	168
7. Comments received from Eskom	175
8. Comments received from the Northern Cape Department of Agriculture, Environmental Affairs, Rural Development and Land Reform (DAEARDLR)	189
9. Comments received from the Northern Cape Provincial Heritage Resource Authorities	192
10. Comments received from General Stakeholders and I&APS	197

## APPENDICES

ENVIRONMENTAL IMPACT ASSESSMENT REPORT: Scoping and Environmental Impact Assessment (EIA) Process for the Proposed Development of a Solar Photovoltaic (PV) Facility (Kudu Solar Facility 3) and associated infrastructure, near De Aar, Northern Cape Province

---

### **APPENDIX H.4: CORRESPONDENCE AND PROOF OF CORRESPONDENCE SENT TO STAKEHOLDERS FOR THE DRAFT EIA REPORT RELEASE**

*App. H.4/...*

## APPENDICES

# ENVIRONMENTAL IMPACT ASSESSMENT REPORT: Scoping and Environmental Impact Assessment (EIA) Process for the Proposed Development of a Solar Photovoltaic (PV) Facility (Kudu Solar Facility 3) and associated infrastructure, near De Aar, Northern Cape Province

### 1. Letter 5 sent via email to I&APs, Stakeholders and Organs of State: Notification of the Release of the Draft EIA Report for a 30-day Comment Period



#### CSIR Environmental Management Services

Postnet Suite 367, Private Bag x10, Musgrave Road, 4062  
Tel: 031 242 2300  
Email: [ems@csir.co.za](mailto:ems@csir.co.za)

02 June 2023

Dear Interested and/or Affected Party,

**RE: NOTIFICATION OF THE COMMENCEMENT OF THE ENVIRONMENTAL IMPACT ASSESSMENT (EIA) PHASE AND THE AVAILABILITY OF 12 x DRAFT EIA REPORTS FOR A 30-DAY REVIEW PERIOD FOR THE PROPOSED DEVELOPMENT OF 12 x SOLAR PHOTOVOLTAIC (PV) FACILITIES (I.E. KUDU SOLAR FACILITIES 1 TO 12) AND ITS ASSOCIATED INFRASTRUCTURE, NEAR DE AAR, NORTHERN CAPE (DFFE REFERENCE NUMBERS: 14/12/16/3/3/2/2244/45/46/47/48/49/50/51/52/53/54/55)**

The Project Developer, ABO Wind renewable energies (Pty) Ltd, is proposing the development of 12 Solar Photovoltaic (PV) Facilities and associated infrastructure to be located north-east of the town of De-Aar in the Northern Cape Province. The proposed projects are located within the Renosterberg Local Municipality and Pixley Ka Seme District Municipality, and they form part of a cluster of the following developments:

- **PROJECTS 1 TO 12:** The proposed development of 12 Solar PV Facilities and associated infrastructure (i.e., Kudu Solar Facility 1 to Kudu Solar Facility 12).
- **PROJECTS 13 TO 24:** The proposed development of switching stations and collector stations at each on-site substation complex, located at each of the 12 Kudu Solar Facilities, and up to 12 x 132 kV overhead power lines connecting each Solar PV Facility to the proposed collector stations or up to the proposed Main Transmission Substation (MTS).
- **PROJECT 25:** The proposed development of an independent 400/132 kV MTS, including associated infrastructure at the MTS.
- **PROJECT 26:** The proposed development of a 400 kV Loop-In-Loop-Out (LILO) from the existing Hydra-Perseus 400 kV overhead power line to the proposed MTS.

The Draft Scoping Reports for these 12 proposed Solar PV Facilities were made available to all registered Interested and/or Affected Parties (I&APs), Organs of State and key relevant stakeholders for a 30-day review period that extended from 09 December 2022 to 30 January 2023 (excluding the DFFE regulated shutdown period). All comments and issues raised as part of the review period were captured in the detailed Comments and Responses Reports and addressed, where applicable, in the Final Scoping Reports. The Final Scoping Reports were submitted to the DFFE on 11 February 2023 for consideration in line with Regulation 21 (1) and 22 of the 2014 NEMA EIA Regulations (as amended). The twelve letters of acceptance of the Final Scoping Reports were signed by DFFE between 24 March 2023 and 29 March 2023.

The proposed Kudu Solar Facilities will comprise various infrastructure, such as a solar field, building infrastructure, an on-site substation complex, a Battery Energy Storage System (BESS), as well as associated infrastructure (e.g., laydown area; internal roads; fencing; storm water channels; panel maintenance and cleaning area; underground low voltage cables or cable trays; and 22 or 33 kV internal underground power lines). The proposed projects trigger various listed activities in terms of the 2014 NEMA EIA Regulations (as amended); with Activity 1 of Listing Notice 2 (GN R325) serving as the main activity. Chapter 4 of the Draft EIA Reports details the listed activities, which require authorisation and thus form part of these Scoping and EIA Processes. Note that separate Applications for Environmental Authorisation (EA), i.e., one for each Kudu Solar Facility project, have been submitted to the National Department of Forestry, Fisheries, and the Environment (DFFE), as the Competent Authority, along with the Draft EIA Reports for comment.

Projects 1 to 12 are not located within any of the Renewable Energy Development Zones (REDZs) gazetted in Government Notice (GN) 114 on 16 February 2018; and GN 144 on 26 February 2021. Therefore, the proposed projects are subject to full Scoping and Environmental Impact Assessment (EIA) Processes and a decision-making period of 107 days, in terms of the National Environmental Management Act (Act 107 of 1998, as amended) (NEMA) and the 2014 NEMA EIA Regulations (as amended). The Scoping and EIA Processes for Projects 1 to 12 are currently being undertaken, whereas the relevant environmental impact assessment processes for Projects 13 to 26 will be undertaken at a later stage. An integrated Public Participation Process (PPP) is being undertaken for the proposed projects, as well as all applications necessary in respect of other applicable legislation.

Board members: Prof. T. Majozo (Chairperson), Dr A. Childs, Dr R. Masango, Mr S. Masie,  
Ms T. Mokhabuki, Dr V. Mthethwa, Mr J. Netshitenzhe, Dr C. Render, Mr C. Shariff, Dr T. Dlamini (CEO)

[www.csir.co.za](http://www.csir.co.za)

## APPENDICES

### ENVIRONMENTAL IMPACT ASSESSMENT REPORT: Scoping and Environmental Impact Assessment (EIA) Process for the Proposed Development of a Solar Photovoltaic (PV) Facility (Kudu Solar Facility 3) and associated infrastructure, near De Aar, Northern Cape Province

---

In line with Regulation 41 (2) (b) of the 2014 NEMA EIA Regulations (as amended), as a registered stakeholder and Interested and/or Affected Party (I&AP) on the project database, **you are hereby notified of the commencement of the EIA Phase and the availability of the Draft EIA Reports for the 12 proposed Kudu Solar Facility projects for a 30-day review period, which extends from 02 June 2023 to 03 July 2023 (excluding public holidays).**

The Draft EIA Reports and Executive Summaries can be accessed on the project website (<https://www.csir.co.za/environmental-impact-assessment>). As a supplementary mechanism, the Draft EIA Reports along with the Executive Summaries, the detailed Comments and Responses Reports and all associated appendices can also be downloaded from the following link on Google Drive: [https://bit.ly/KUDU\\_SOLAR\\_PV](https://bit.ly/KUDU_SOLAR_PV)

Should you wish to register as an I&AP and/or provide comments on the Draft EIA Report, you are kindly requested to send your name, contact details (with an indication of your interest in these projects) and any project-related comments to the Project Manager at the contact details provided below **no later than 03 July 2023**:

- **Attention:** Rohaida Abed
- **Email:** [ems@csir.co.za](mailto:ems@csir.co.za)
- **Postal address:** Postnet Suite 367  
Private Bag x10  
Musgrave Road  
4062
- **Tel:** 031 242 2300

All comments and issues raised as part of the review period on the Draft EIA Reports will be captured in the detailed Comments and Responses Reports and addressed, where relevant and applicable, and included with the Final EIA Reports which will be submitted to the DFFE for decision-making in terms of Regulation 23 (1) (a) and 24 of the 2014 NEMA EIA Regulations (as amended). As a registered I&AP on these projects, you will be duly informed of the submission of the Final EIA Reports to the DFFE for decision-making, as well as the outcome of the DFFE's decision on the Final EIA Reports for these proposed projects.

In accordance with the Protection of Personal Information Act (Act No. 4 of 2013), CSIR will conduct itself responsibly when collecting, processing, storing and sharing any personal information collected for the purposes of PPP in terms of the 2014 NEMA EIA Regulations (as amended). By registering as an I&AP and/or submitting information and comments, you consent to the collection, collation, processing, and storing of such information and the use and disclosure of such information for the aforementioned purpose (<https://www.csir.co.za/csir-privacy-notice>). If you would like to opt out of communications on these projects, please do so by responding to this correspondence via email.

We thank you in advance for your participation in these Scoping and EIA Processes. Should you have any queries or require additional information, or should you struggle to access the documentation at any of the above links, please do not hesitate to contact the undersigned using the contact details provided above.

Sincerely,



Paul Lochner *Registered EAP*  
EMS Manager and Project Leader  
CSIR - Environmental Management Services



Rohaida Abed *Pr. Sci. Nat.; Registered EAP*  
Project Manager  
CSIR - Environmental Management Services

## APPENDICES

ENVIRONMENTAL IMPACT ASSESSMENT REPORT: Scoping and Environmental Impact Assessment (EIA) Process for the Proposed Development of a Solar Photovoltaic (PV) Facility (Kudu Solar Facility 3) and associated infrastructure, near De Aar, Northern Cape Province

---

### 2. Email 5 sent to I&APs, Stakeholders and Organs of State on 2 June 2023

---

Email 1 sent from [ems@csir.co.za](mailto:ems@csir.co.za)

---

**From:** EMS <ems@csir.co.za>  
**Sent:** Friday, 02 June 2023 19:37  
**To:** EMS  
**Subject:** Availability of Draft EIA Reports for Comment - Kudu Solar PV  
**Attachments:** Cover Letter to I&APs\_DEIRs\_Kudu Solar 1-12\_June2023.pdf

**Categories:** This message has been archived by Retain on June 15 2023 09:28  
**Bcc:**

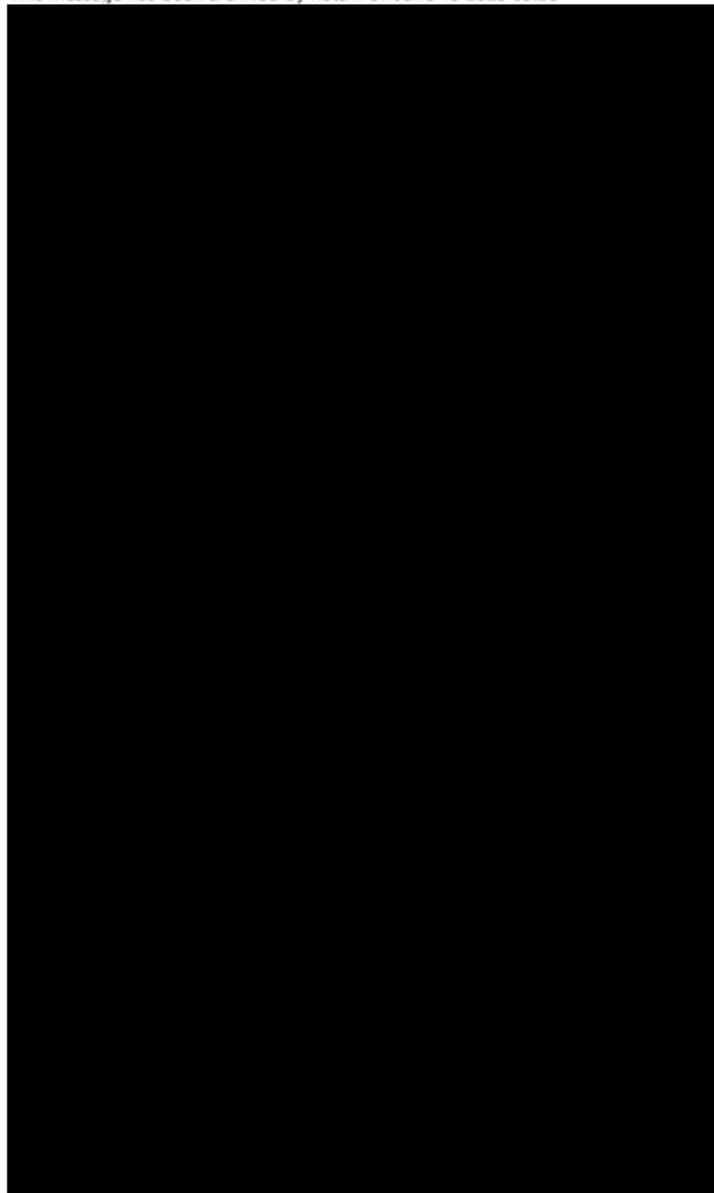

**APPENDICES**

**ENVIRONMENTAL IMPACT ASSESSMENT REPORT: Scoping and Environmental Impact Assessment (EIA) Process for the Proposed Development of a Solar Photovoltaic (PV) Facility (Kudu Solar Facility 3) and associated infrastructure, near De Aar, Northern Cape Province**

---

**Bcc:**

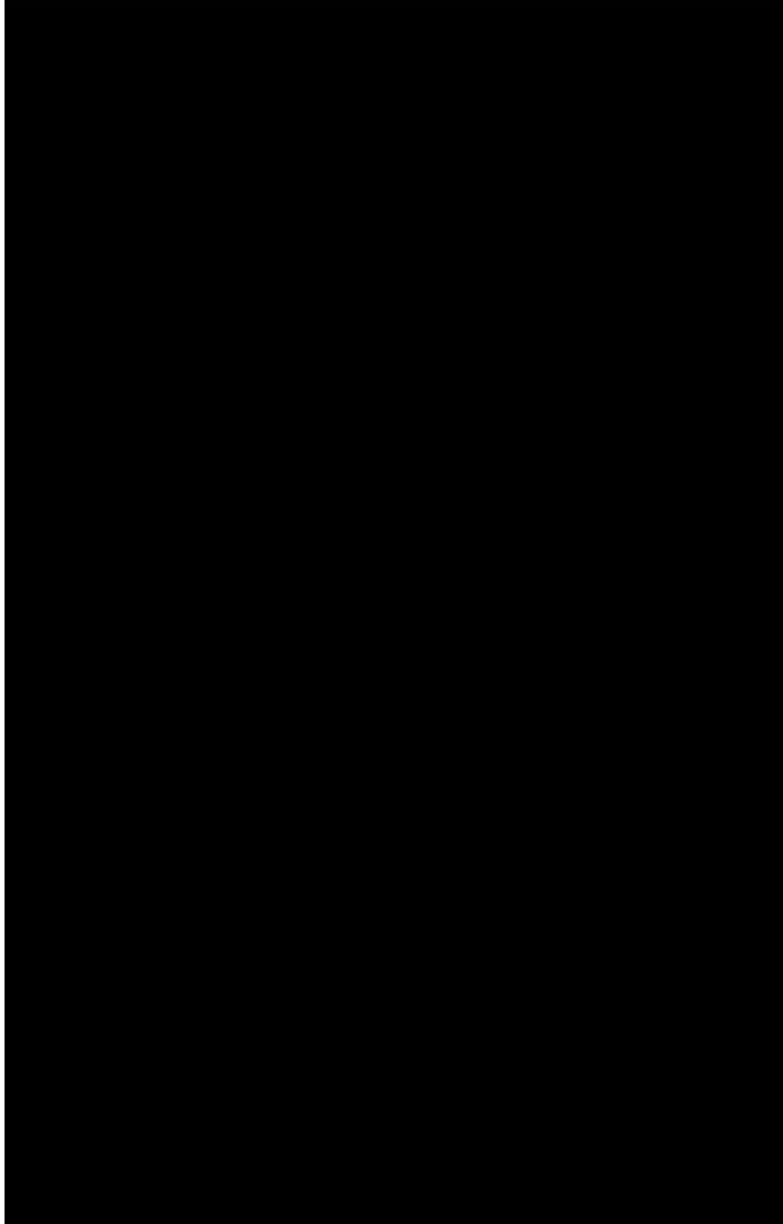

Dear Interested and Affected Party / Stakeholder,

**RE: NOTIFICATION OF THE RELEASE OF THE DRAFT EIA REPORTS FOR A 30-DAY COMMENT PERIOD FOR THE PROPOSED DEVELOPMENT OF 12 SOLAR PHOTOVOLTAIC (PV) FACILITIES (I.E. KUDU SOLAR FACILITIES) AND VARIOUS ASSOCIATED INFRASTRUCTURE, NEAR DE AAR, NORTHERN CAPE**

National Department of Forestry, Fisheries, the Environment (DFFE) Reference Numbers:

Kudu Solar Facility 1: 14/12/16/3/3/2/2244  
Kudu Solar Facility 2: 14/12/16/3/3/2/2245  
Kudu Solar Facility 3: 14/12/16/3/3/2/2246  
Kudu Solar Facility 4: 14/12/16/3/3/2/2247

Kudu Solar Facility 5: 14/12/16/3/3/2/2248  
Kudu Solar Facility 6: 14/12/16/3/3/2/2249  
Kudu Solar Facility 7: 14/12/16/3/3/2/2250  
Kudu Solar Facility 8: 14/12/16/3/3/2/2251

Kudu Solar Facility 9: 14/12/16/3/3/2/2252  
Kudu Solar Facility 10: 14/12/16/3/3/2/2253  
Kudu Solar Facility 11: 14/12/16/3/3/2/2254  
Kudu Solar Facility 12: 14/12/16/3/3/2/2255



## APPENDICES

### ENVIRONMENTAL IMPACT ASSESSMENT REPORT: Scoping and Environmental Impact Assessment (EIA) Process for the Proposed Development of a Solar Photovoltaic (PV) Facility (Kudu Solar Facility 3) and associated infrastructure, near De Aar, Northern Cape Province

---

The Project Applicants are proposing to develop the Kudu Solar Photovoltaic (PV) cluster, consisting of up to 12 Solar PV Facilities, associated infrastructure and Electricity Grid Infrastructure (EGI), north-east of the town of De Aar, in the Renosterberg Local Municipality and Pixley Ka Seme District Municipality, in the Northern Cape Province. The generation capacity of each PV Facility will range from approximately 50 MWac to up to 350 MWac.

The proposed projects are not located within any of the gazetted Renewable Energy Development Zones (as gazetted in Government Notice R114; 16 February 2018). Therefore, the proposed Solar PV Facilities are subject to a Scoping and Environmental Impact Assessment (S&EIA) process and a decision-making period of 107 days, in terms of the 2014 National Environmental Management Act (Act 107 of 1998, as amended) (NEMA) EIA Regulations (as amended).

The Draft Scoping Reports for the proposed projects were made available to all potential and registered Interested and/or Affected Parties (I&APs), Organs of State and relevant key stakeholders for a 30-day comment period, which extended from 9 December 2022 to 30 January 2023 (excluding public holidays and the regulated shutdown period). All comments and issues raised as part of the comment period were captured in the Comments and Responses Report and addressed, where relevant and applicable, in the Final Scoping Reports. The Final Scoping Reports were submitted to the DFFE on 11 February 2023 for consideration in line with Regulation 21(1) and 22 of the 2014 NEMA EIA Regulations (as amended). The DFFE notified the appointed EAP (CSIR) of the Department's acceptance of the Final Scoping Reports in March 2023.

In line with Regulation 23(1) (a) and 24 of the 2014 NEMA EIA Regulations (as amended), the Draft EIA Reports have been compiled and you are hereby notified of the availability of these reports for a 30-day commenting period, extending from **2 June 2023 to 3 July 2023** (excluding public holidays).

The Draft EIA Reports and Executive Summaries can be accessed via the project website at the link below:

- Project website: <https://www.csir.co.za/environmental-impact-assessment>

The Draft EIA Reports inclusive of all appendices can be accessed via the Google Drive project folder at the link below:

- Google Drive: [https://bit.ly/KUDU\\_SOLAR\\_PV](https://bit.ly/KUDU_SOLAR_PV)

You are kindly requested to register your interest and submit any comments you may have on the Draft EIA Reports to the CSIR by **3 July 2023** (details are provided below and in the attached).

Please do not hesitate to contact us should you have any queries relating to the above.

In accordance with the Protection of Personal Information Act (Act 4 of 2013), the CSIR will conduct itself responsibly when collecting, processing, storing and sharing any personal information collected for the purposes of Public Participation Processes (PPP) in terms of the 2014 NEMA EIA Regulations (as amended). By registering as an Interested and Affected Party (I&AP) and/or submitting information and comments, you consent to the collection, collation, processing, and storing of such information and the use and disclosure of such information for the aforementioned purpose (<https://www.csir.co.za/csir-privacy-notice>). If you would like to opt out of communications on this project, please do so by responding to this correspondence via email.

Kind Regards,  
Rohaida Abed

CSIR Environmental Management Services  
E-mail: [ems@csir.co.za](mailto:ems@csir.co.za)  
Postal Address: Postnet Suite 367, Private Bag x10, Musgrave Road, 4062  
Tel: 031 242 2300

## APPENDICES

### ENVIRONMENTAL IMPACT ASSESSMENT REPORT: Scoping and Environmental Impact Assessment (EIA) Process for the Proposed Development of a Solar Photovoltaic (PV) Facility (Kudu Solar Facility 3) and associated infrastructure, near De Aar, Northern Cape Province

#### Email 2 sent from [kudosolarpvprojects@gmail.com](mailto:kudosolarpvprojects@gmail.com)

6/6/23, 11:58 AM

Gmail - Availability of Draft EIA Reports for Comment - Kudu Solar PV Facilities near De Aar, Northern Cape



Kudu Solar PV Projects <kudosolarpvprojects@gmail.com>

#### Availability of Draft EIA Reports for Comment - Kudu Solar PV Facilities near De Aar, Northern Cape

25 messages

kudosolarpvprojects@gmail.com <kudosolarpvprojects@gmail.com>

2 June 2023 at 21:25

To: EMS <ems@csir.co.za>

Cc: kudosolarpvprojects@gmail.com, EMS <ems@csir.co.za>

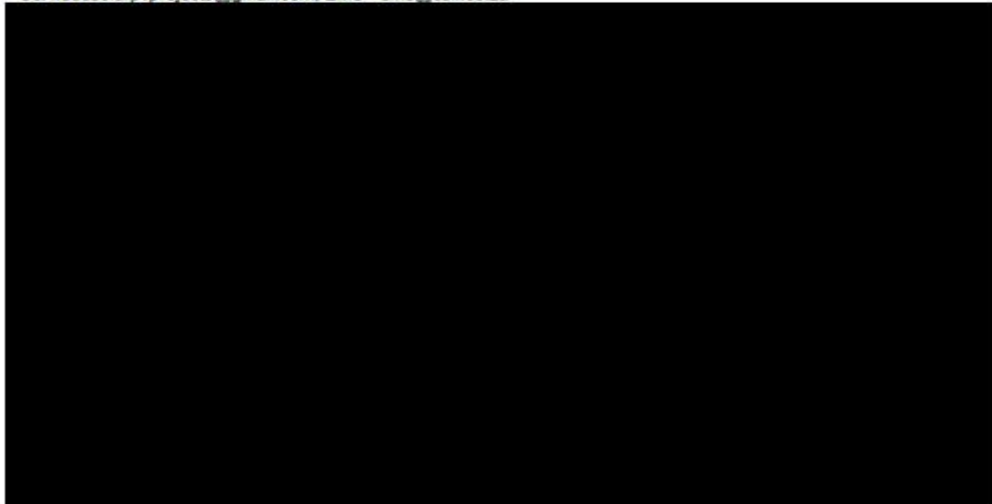

Dear Stakeholders and I&APs,

**RE: NOTIFICATION OF THE RELEASE OF THE DRAFT EIA REPORTS FOR A 30-DAY COMMENT PERIOD FOR THE PROPOSED DEVELOPMENT OF 12 SOLAR PHOTOVOLTAIC (PV) FACILITIES (I.E. KUDU SOLAR FACILITIES) AND VARIOUS ASSOCIATED INFRASTRUCTURE, NEAR DE AAR, NORTHERN CAPE**

National Department of Forestry, Fisheries, the Environment (DFFE) Reference Numbers:

Kudu Solar Facility 1: 14/12/16/3/3/2/2244

Kudu Solar Facility 5: 14/12/16/3/3/2/2248

Kudu Solar Facility 9: 14/12/16/3/3/2/2252

Kudu Solar Facility 2: 14/12/16/3/3/2/2245

Kudu Solar Facility 6: 14/12/16/3/3/2/2249

Kudu Solar Facility 10: 14/12/16/3/3/2/2253

Kudu Solar Facility 3: 14/12/16/3/3/2/2246

Kudu Solar Facility 7: 14/12/16/3/3/2/2250

Kudu Solar Facility 11: 14/12/16/3/3/2/2254

Kudu Solar Facility 4: 14/12/16/3/3/2/2247

Kudu Solar Facility 8: 14/12/16/3/3/2/2251

Kudu Solar Facility 12: 14/12/16/3/3/2/2255

The Project Applicants are proposing to develop the Kudu Solar Photovoltaic (PV) cluster, consisting of up to 12 Solar PV Facilities, associated infrastructure and Electricity Grid Infrastructure (EGI), north-east of the town of De Aar, in the Renosterberg Local Municipality and Pixley Ka Seme District Municipality, in the Northern Cape Province. The generation capacity of each PV Facility will range from approximately 50 MWac to up to 350 MWac.

The proposed projects are not located within any of the gazetted Renewable Energy Development Zones (as gazetted in Government Notice R114; 18 February 2018). Therefore, the proposed Solar PV Facilities are subject to a Scoping and Environmental Impact Assessment (S&EIA) process and a decision-making period of 107 days, in terms of the 2014 National Environmental Management Act (Act 107 of 1998, as amended) (NEMA) EIA Regulations (as amended).

<https://mail.google.com/mail/u/0/?ik=75de3eb4ab&view=pt&search=all&permthid=thread-f:1767620188354394899&siml=msg-f:176762018835...> 1/83

## APPENDICES

### ENVIRONMENTAL IMPACT ASSESSMENT REPORT: Scoping and Environmental Impact Assessment (EIA) Process for the Proposed Development of a Solar Photovoltaic (PV) Facility (Kudu Solar Facility 3) and associated infrastructure, near De Aar, Northern Cape Province

---

6/6/23, 11:58 AM

Gmail - Availability of Draft EIA Reports for Comment - Kudu Solar PV Facilities near De Aar, Northern Cape

The Draft Scoping Reports for the proposed projects were made available to all potential and registered Interested and/or Affected Parties (I&APs), Organs of State and relevant key stakeholders for a 30-day comment period, which extended from 9 December 2022 to 30 January 2023 (excluding public holidays and the regulated shutdown period). All comments and issues raised as part of the comment period were captured in the Comments and Responses Report and addressed, where relevant and applicable, in the Final Scoping Reports. The Final Scoping Reports were submitted to the DFFE on 11 February 2023 for consideration in line with Regulation 21(1) and 22 of the 2014 NEMA EIA Regulations (as amended). The DFFE notified the appointed EAP (CSIR) of the Department's acceptance of the Final Scoping Reports in March 2023.

In line with Regulation 23(1) (a) and 24 of the 2014 NEMA EIA Regulations (as amended), the Draft EIA Reports have been compiled and you are hereby notified of the availability of these reports for a 30-day commenting period, extending from 2 June 2023 to 3 July 2023 (excluding public holidays).

The Draft EIA Reports and Executive Summaries can be accessed via the project website at the link below:

- Project website: <https://www.csir.co.za/environmental-impact-assessment>

The Draft EIA Reports inclusive of all appendices can be accessed via the Google Drive project folder at the link below:

- Google Drive: [https://bit.ly/KUDU\\_SOLAR\\_PV](https://bit.ly/KUDU_SOLAR_PV)

You are kindly requested to register your interest and submit any comments you may have on the Draft EIA Reports to the CSIR by 3 July 2023 (details are provided below and in the attached).

Please do not hesitate to contact us should you have any queries relating to the above.

In accordance with the Protection of Personal Information Act (Act 4 of 2013), the CSIR will conduct itself responsibly when collecting, processing, storing and sharing any personal information collected for the purposes of Public Participation Processes (PPP) in terms of the 2014 NEMA EIA Regulations (as amended). By registering as an Interested and Affected Party (I&AP) and/or submitting information and comments, you consent to the collection, collation, processing, and storing of such information and the use and disclosure of such information for the aforementioned purpose (<https://www.csir.co.za/csir-privacy-notice>). If you would like to opt out of communications on this project, please do so by responding to this correspondence via email.

Kind Regards,

Rohaida Abed

CSIR Environmental Management Services

E-mail: [ems@csir.co.za](mailto:ems@csir.co.za)

Postal Address: Postnet Suite 367, Private Bag x10, Musgrave Road, 4062

Tel: 031 242 2300

---

APPENDICES

ENVIRONMENTAL IMPACT ASSESSMENT REPORT: Scoping and Environmental Impact Assessment (EIA) Process for the Proposed Development of a Solar Photovoltaic (PV) Facility (Kudu Solar Facility 3) and associated infrastructure, near De Aar, Northern Cape Province

---

Email 3 sent from [kudosolarpvprojects@gmail.com](mailto:kudosolarpvprojects@gmail.com)

6/6/23, 11:35 AM

Gmail - Availability of Draft EIA Reports for Comment - Kudu Solar PV Facilities near De Aar, Northern Cape



Kudu Solar PV Projects <kudosolarpvprojects@gmail.com>

---

**Availability of Draft EIA Reports for Comment - Kudu Solar PV Facilities near De Aar, Northern Cape**

41 messages

---

Kudu Solar PV Projects <kudosolarpvprojects@gmail.com>

2 June 2023 at 21:41

To: EMS <ems@csir.co.za>

Cc: EMS <ems@csir.co.za>, Kudu Solar PV Projects <kudosolarpvprojects@gmail.com>

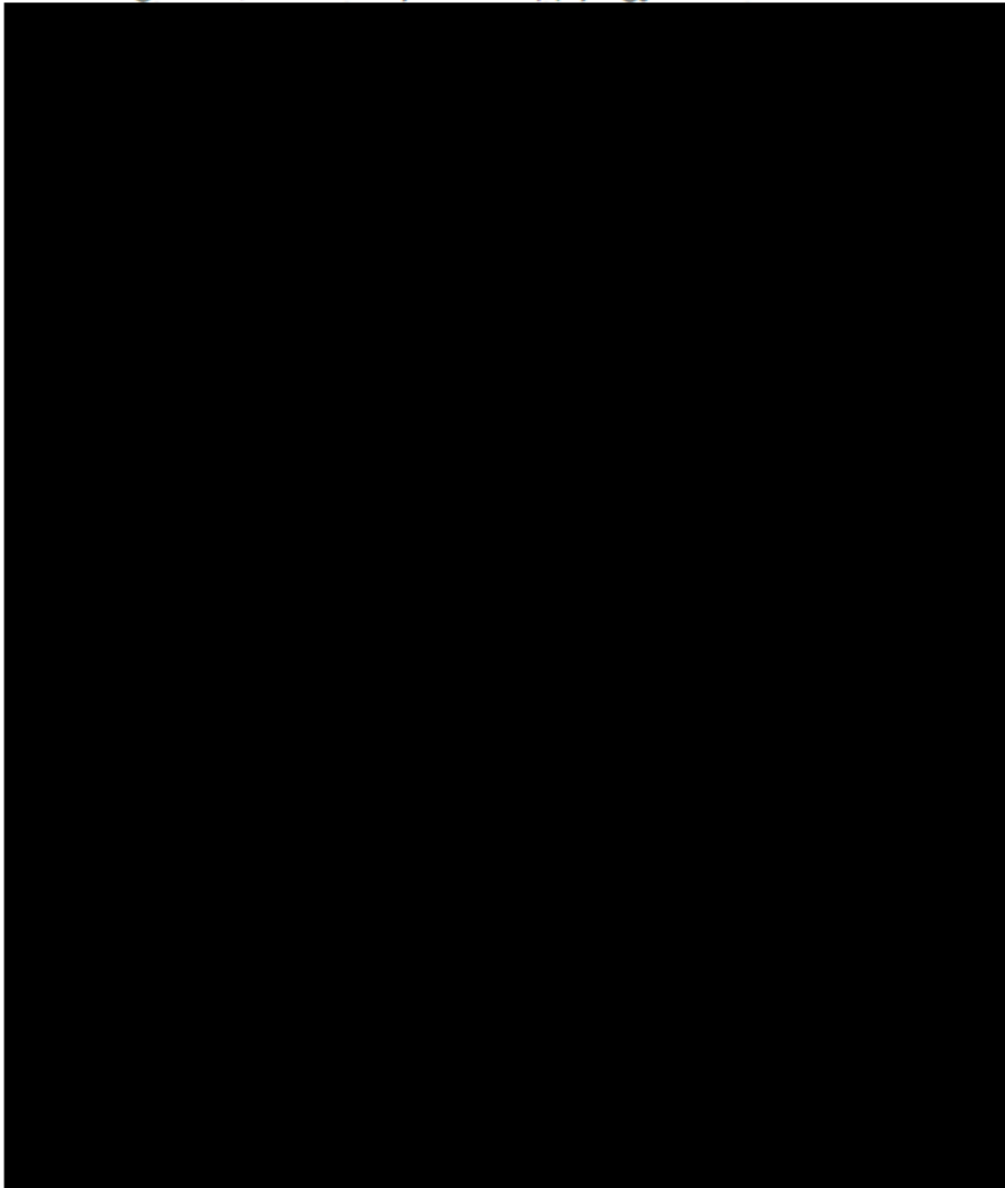

<https://mail.google.com/mail/u/0/?ik=75de3eb4ab&view-pt&search=all&permthid=thread-a:r-6579510032529566155&simpl-msg-a:r762854519...> 1/27

## APPENDICES

# ENVIRONMENTAL IMPACT ASSESSMENT REPORT: Scoping and Environmental Impact Assessment (EIA) Process for the Proposed Development of a Solar Photovoltaic (PV) Facility (Kudu Solar Facility 3) and associated infrastructure, near De Aar, Northern Cape Province

6/6/23, 11:35 AM

Gmail - Availability of Draft EIA Reports for Comment - Kudu Solar PV Facilities near De Aar, Northern Cape



Dear Stakeholders and I&APs,

**RE: NOTIFICATION OF THE RELEASE OF THE DRAFT EIA REPORTS FOR A 30-DAY COMMENT PERIOD FOR THE PROPOSED DEVELOPMENT OF 12 SOLAR PHOTOVOLTAIC (PV) FACILITIES (I.E. KUDU SOLAR FACILITIES) AND VARIOUS ASSOCIATED INFRASTRUCTURE, NEAR DE AAR, NORTHERN CAPE**

National Department of Forestry, Fisheries, the Environment (DFFE) Reference Numbers:

Kudu Solar Facility 1: 14/12/16/3/3/2/2244	Kudu Solar Facility 6: 14/12/16/3/3/2/2248	Kudu Solar Facility 9: 14/12/16/3/3/2/2252
Kudu Solar Facility 2: 14/12/16/3/3/2/2246	Kudu Solar Facility 8: 14/12/16/3/3/2/2248	Kudu Solar Facility 10: 14/12/16/3/3/2/2260
Kudu Solar Facility 3: 14/12/16/3/3/2/2248	Kudu Solar Facility 7: 14/12/16/3/3/2/2250	Kudu Solar Facility 11: 14/12/16/3/3/2/2264
Kudu Solar Facility 4: 14/12/16/3/3/2/2247	Kudu Solar Facility 5: 14/12/16/3/3/2/2251	Kudu Solar Facility 12: 14/12/16/3/3/2/2266

The Project Applicants are proposing to develop the Kudu Solar Photovoltaic (PV) cluster, consisting of up to 12 Solar PV Facilities, associated infrastructure and Electricity Grid Infrastructure (EGI), north-east of the town of De Aar, in the Renosterberg Local Municipality and Pixley Ka Seme District Municipality, in the Northern Cape Province. The generation capacity of each PV Facility will range from approximately 50 MWac to up to 350 MWac.

The proposed projects are not located within any of the gazetted Renewable Energy Development Zones (as gazetted in Government Notice R114; 16 February 2018). Therefore, the proposed Solar PV Facilities are subject to a Scoping and Environmental Impact Assessment (S&EIA) process and a decision-making period of 107 days, in terms of the 2014 National Environmental Management Act (Act 107 of 1998, as amended) (NEMA) EIA Regulations (as amended).

The Draft Scoping Reports for the proposed projects were made available to all potential and registered Interested and/or Affected Parties (I&APs), Organs of State and relevant key stakeholders for a 30-day comment period, which extended from 9 December 2022 to 30 January 2023 (excluding public holidays and the regulated shutdown period). All comments and issues raised as part of the comment period were captured in the Comments and Responses Report and addressed, where relevant and applicable, in the Final Scoping Reports. The Final Scoping Reports were submitted to the DFFE on 11 February 2023 for consideration in line with Regulation 21(1) and 22 of the 2014 NEMA EIA Regulations (as amended). The DFFE notified the appointed EAP (CSIR) of the Department's acceptance of the Final Scoping Reports in March 2023.

In line with Regulation 23(1) (a) and 24 of the 2014 NEMA EIA Regulations (as amended), the Draft EIA Reports have been compiled and you are hereby notified of the availability of these reports for a 30-day commenting period, extending from 2 June 2023 to 3 July 2023 (excluding public holidays).

The Draft EIA Reports and Executive Summaries can be accessed via the project website at the link below:

- Project website: <https://www.csir.co.za/environmental-impact-assessment>

The Draft EIA Reports inclusive of all appendices can be accessed via the Google Drive project folder at the link below:

- Google Drive: [https://bit.ly/KUDU\\_SOLAR\\_PV](https://bit.ly/KUDU_SOLAR_PV)

You are kindly requested to register your interest and submit any comments you may have on the Draft EIA Reports to the CSIR by 3 July 2023 (details are provided below and in the attached).

Please do not hesitate to contact us should you have any queries relating to the above.

In accordance with the Protection of Personal Information Act (Act 4 of 2013), the CSIR will conduct itself responsibly when collecting, processing, storing and sharing any personal information collected for the purposes of Public Participation Processes (PPP) in terms of the 2014 NEMA EIA Regulations (as amended). By registering as

<https://mail.google.com/mail/u/0/?ik=75de3eb4ab&view-pt&search=all&permthid=thread-a:r-6579510032529566155&siml=msg-a:r762854519...> 2/27

## APPENDICES

### ENVIRONMENTAL IMPACT ASSESSMENT REPORT: Scoping and Environmental Impact Assessment (EIA) Process for the Proposed Development of a Solar Photovoltaic (PV) Facility (Kudu Solar Facility 3) and associated infrastructure, near De Aar, Northern Cape Province

---

6/6/23, 11:35 AM

Gmail - Availability of Draft EIA Reports for Comment - Kudu Solar PV Facilities near De Aar, Northern Cape

an Interested and Affected Party (I&AP) and/or submitting information and comments, you consent to the collection, collation, processing, and storing of such information and the use and disclosure of such information for the aforementioned purpose (<https://www.csir.co.za/csir-privacy-notice>). If you would like to opt out of communications on this project, please do so by responding to this correspondence via email.

Kind Regards,  
Rohaida Abed

CSIR Environmental Management Services  
E-mail: [ems@csir.co.za](mailto:ems@csir.co.za)  
Postal Address: Postnet Suite 367, Private Bag x10, Musgrave Road, 4062  
Tel: 031 242 2300

## APPENDICES

### ENVIRONMENTAL IMPACT ASSESSMENT REPORT: Scoping and Environmental Impact Assessment (EIA) Process for the Proposed Development of a Solar Photovoltaic (PV) Facility (Kudu Solar Facility 3) and associated infrastructure, near De Aar, Northern Cape Province

#### Email 4 sent from [kudosolarpvprojects@gmail.com](mailto:kudosolarpvprojects@gmail.com)

6/6/23, 11:48 AM

Gmail - Availability of Draft EIA Reports for Comment - Kudu Solar PV Facilities near De Aar, Northern Cape



Kudu Solar PV Projects <kudosolarpvprojects@gmail.com>

#### Availability of Draft EIA Reports for Comment - Kudu Solar PV Facilities near De Aar, Northern Cape

1 message

Kudu Solar PV Projects <kudosolarpvprojects@gmail.com>  
To: EMS <ems@csir.co.za>

2 June 2023 at 22:11

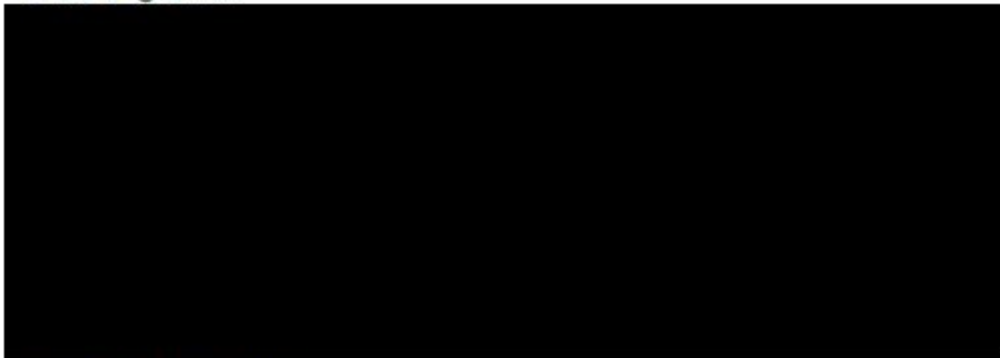

Dear Stakeholders and I&APs,

**RE: NOTIFICATION OF THE RELEASE OF THE DRAFT EIA REPORTS FOR A 30-DAY COMMENT PERIOD FOR THE PROPOSED DEVELOPMENT OF 12 SOLAR PHOTOVOLTAIC (PV) FACILITIES (I.E. KUDU SOLAR FACILITIES) AND VARIOUS ASSOCIATED INFRASTRUCTURE, NEAR DE AAR, NORTHERN CAPE**

National Department of Forestry, Fisheries, the Environment (DFFE) Reference Numbers:

Kudu Solar Facility 1: 14/12/16/3/3/2/2244	Kudu Solar Facility 5: 14/12/16/3/3/2/2248	Kudu Solar Facility 9: 14/12/16/3/3/2/2252
Kudu Solar Facility 2: 14/12/16/3/3/2/2245	Kudu Solar Facility 6: 14/12/16/3/3/2/2249	Kudu Solar Facility 10: 14/12/16/3/3/2/2253
Kudu Solar Facility 3: 14/12/16/3/3/2/2246	Kudu Solar Facility 7: 14/12/16/3/3/2/2250	Kudu Solar Facility 11: 14/12/16/3/3/2/2254
Kudu Solar Facility 4: 14/12/16/3/3/2/2247	Kudu Solar Facility 8: 14/12/16/3/3/2/2251	Kudu Solar Facility 12: 14/12/16/3/3/2/2255

The Project Applicants are proposing to develop the Kudu Solar Photovoltaic (PV) cluster, consisting of up to 12 Solar PV Facilities, associated infrastructure and Electricity Grid Infrastructure (EGI), north-east of the town of De Aar, in the Renosterberg Local Municipality and Pixley Ka Seme District Municipality, in the Northern Cape Province. The generation capacity of each PV Facility will range from approximately 50 MWac to up to 350 MWac.

The proposed projects are not located within any of the gazetted Renewable Energy Development Zones (as gazetted in Government Notice R114; 16 February 2018). Therefore, the proposed Solar PV Facilities are subject to a Scoping and Environmental Impact Assessment (S&EIA) process and a decision-making period of 107 days, in terms of the 2014 National Environmental Management Act (Act 107 of 1998, as amended) (NEMA) EIA Regulations (as amended).

The Draft Scoping Reports for the proposed projects were made available to all potential and registered Interested and/or Affected Parties (I&APs), Organs of State and relevant key stakeholders for a 30-day comment period, which extended from 9 December 2022 to 30 January 2023 (excluding public holidays and the regulated shutdown period). All comments and issues raised as part of the comment period were captured in the Comments and Responses Report and addressed, where relevant and applicable, in the Final Scoping Reports. The Final Scoping Reports were submitted to the DFFE on 11 February 2023 for consideration in line with Regulation 21(1) and 22 of the 2014 NEMA EIA Regulations (as amended). The DFFE notified the appointed EAP (CSIR) of the Department's acceptance of the Final Scoping Reports in March 2023.

In line with Regulation 23(1) (a) and 24 of the 2014 NEMA EIA Regulations (as amended), the Draft EIA Reports have been compiled and you are hereby notified of the availability of these reports for a 30-day commenting period, extending from 2 June 2023 to 3 July 2023 (excluding public holidays).

<https://mail.google.com/mail/u/0/?ik=75de3eb4ab&view-pt&search=all&permthid=thread-ar7639394475010037210&siml=msg-ar-8067770274...> 1/2

## APPENDICES

### ENVIRONMENTAL IMPACT ASSESSMENT REPORT: Scoping and Environmental Impact Assessment (EIA) Process for the Proposed Development of a Solar Photovoltaic (PV) Facility (Kudu Solar Facility 3) and associated infrastructure, near De Aar, Northern Cape Province

---

6/6/23, 11:48 AM

Gmail - Availability of Draft EIA Reports for Comment - Kudu Solar PV Facilities near De Aar, Northern Cape

The Draft EIA Reports and Executive Summaries can be accessed via the project website at the link below:

- Project website: <https://www.csir.co.za/environmental-impact-assessment>

The Draft EIA Reports inclusive of all appendices can be accessed via the Google Drive project folder at the link below:

- Google Drive: [https://bit.ly/KUDU\\_SOLAR\\_PV](https://bit.ly/KUDU_SOLAR_PV)

You are kindly requested to register your interest and submit any comments you may have on the Draft EIA Reports to the CSIR by 3 July 2023 (details are provided below and in the attached).

Please do not hesitate to contact us should you have any queries relating to the above.

In accordance with the Protection of Personal Information Act (Act 4 of 2013), the CSIR will conduct itself responsibly when collecting, processing, storing and sharing any personal information collected for the purposes of Public Participation Processes (PPP) in terms of the 2014 NEMA EIA Regulations (as amended). By registering as an Interested and Affected Party (I&AP) and/or submitting information and comments, you consent to the collection, collation, processing, and storing of such information and the use and disclosure of such information for the aforementioned purpose (<https://www.csir.co.za/csir-privacy-notice>). If you would like to opt out of communications on this project, please do so by responding to this correspondence via email.

Kind Regards,  
Rohaida Abed

CSIR Environmental Management Services

E-mail: [ems@csir.co.za](mailto:ems@csir.co.za)

Postal Address: Postnet Suite 367, Private Bag x10, Musgrave Road, 4062

Tel: 031 242 2300

---

 Cover Letter to I&APs\_DEIRs\_Kudu Solar 1-12\_June2023.pdf  
144K



## APPENDICES

### ENVIRONMENTAL IMPACT ASSESSMENT REPORT: Scoping and Environmental Impact Assessment (EIA) Process for the Proposed Development of a Solar Photovoltaic (PV) Facility (Kudu Solar Facility 3) and associated infrastructure, near De Aar, Northern Cape Province

#### Email 5 sent from [kudosolarpvprojects@gmail.com](mailto:kudosolarpvprojects@gmail.com)

6/6/23, 11:52 AM

Gmail - Availability of Draft EIA Reports for Comment - Kudu Solar PV Facilities near De Aar, Northern Cape



Kudu Solar PV Projects <kudosolarpvprojects@gmail.com>

#### Availability of Draft EIA Reports for Comment - Kudu Solar PV Facilities near De Aar, Northern Cape

6 messages

Kudu Solar PV Projects <kudosolarpvprojects@gmail.com>  
To: EMS <ems@csir.co.za>

2 June 2023 at 22:13

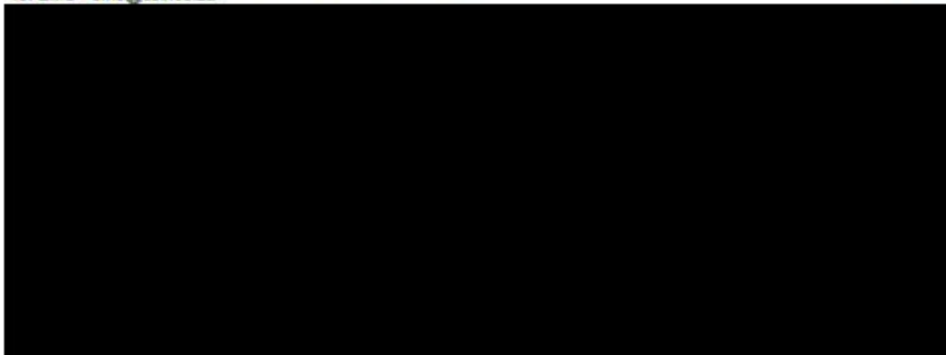

Dear Stakeholders and I&APs,

**RE: NOTIFICATION OF THE RELEASE OF THE DRAFT EIA REPORTS FOR A 30-DAY COMMENT PERIOD FOR THE PROPOSED DEVELOPMENT OF 12 SOLAR PHOTOVOLTAIC (PV) FACILITIES (I.E. KUDU SOLAR FACILITIES) AND VARIOUS ASSOCIATED INFRASTRUCTURE, NEAR DE AAR, NORTHERN CAPE**

National Department of Forestry, Fisheries, the Environment (DFFE) Reference Numbers:

Kudu Solar Facility 1: 14/12/16/3/3/2/2244	Kudu Solar Facility 5: 14/12/16/3/3/2/2248	Kudu Solar Facility 9: 14/12/16/3/3/2/2252
Kudu Solar Facility 2: 14/12/16/3/3/2/2245	Kudu Solar Facility 6: 14/12/16/3/3/2/2249	Kudu Solar Facility 10: 14/12/16/3/3/2/2253
Kudu Solar Facility 3: 14/12/16/3/3/2/2246	Kudu Solar Facility 7: 14/12/16/3/3/2/2250	Kudu Solar Facility 11: 14/12/16/3/3/2/2254
Kudu Solar Facility 4: 14/12/16/3/3/2/2247	Kudu Solar Facility 8: 14/12/16/3/3/2/2251	Kudu Solar Facility 12: 14/12/16/3/3/2/2255

The Project Applicants are proposing to develop the Kudu Solar Photovoltaic (PV) cluster, consisting of up to 12 Solar PV Facilities, associated infrastructure and Electricity Grid Infrastructure (EGI), north-east of the town of De Aar, in the Renosterberg Local Municipality and Pixley Ka Seme District Municipality, in the Northern Cape Province. The generation capacity of each PV Facility will range from approximately 50 MWac to up to 350 MWac.

The proposed projects are not located within any of the gazetted Renewable Energy Development Zones (as gazetted in Government Notice R114; 16 February 2018). Therefore, the proposed Solar PV Facilities are subject to a Scoping and Environmental Impact Assessment (S&EIA) process and a decision-making period of 107 days, in terms of the 2014 National Environmental Management Act (Act 107 of 1998, as amended) (NEMA) EIA Regulations (as amended).

The Draft Scoping Reports for the proposed projects were made available to all potential and registered Interested and/or Affected Parties (I&APs), Organs of State and relevant key stakeholders for a 30-day comment period, which extended from 9 December 2022 to 30 January 2023 (excluding public holidays and the regulated shutdown period). All comments and issues raised as part of the comment period were captured in the Comments and Responses Report and addressed, where relevant and applicable, in the Final Scoping Reports. The Final Scoping Reports were submitted to the DFFE on 11 February 2023 for consideration in line with Regulation 21(1) and 22 of the 2014 NEMA EIA Regulations (as amended). The DFFE notified the appointed EAP (CSIR) of the Department's acceptance of the Final Scoping Reports in March 2023.

In line with Regulation 23(1) (a) and 24 of the 2014 NEMA EIA Regulations (as amended), the Draft EIA Reports have been compiled and you are hereby notified of the availability of these reports for a 30-day commenting period, extending from 2 June 2023 to 3 July 2023 (excluding public holidays).

<https://mail.google.com/mail/u/0/?ik=75de3eb4ab&view-pt&search=all&permthid=thread-a74823058420660512803&siml=msg-arrf4574363857...> 1/8

## APPENDICES

### ENVIRONMENTAL IMPACT ASSESSMENT REPORT: Scoping and Environmental Impact Assessment (EIA) Process for the Proposed Development of a Solar Photovoltaic (PV) Facility (Kudu Solar Facility 3) and associated infrastructure, near De Aar, Northern Cape Province

#### Email 6 sent from [emspublicparticipation@gmail.com](mailto:emspublicparticipation@gmail.com)

6/6/23, 12:12 PM

Gmail - Availability of Draft EIA Reports for Comment - Kudu Solar PV Facilities near De Aar, Northern Cape



EMS Public Participation <[emspublicparticipation@gmail.com](mailto:emspublicparticipation@gmail.com)>

#### Availability of Draft EIA Reports for Comment - Kudu Solar PV Facilities near De Aar, Northern Cape

1 message

EMS Public Participation <[emspublicparticipation@gmail.com](mailto:emspublicparticipation@gmail.com)>

Fri, Jun 2, 2023 at 10:44 PM

To: [ems@csir.co.za](mailto:ems@csir.co.za)

Cc: EMS Public Participation <[emspublicparticipation@gmail.com](mailto:emspublicparticipation@gmail.com)>

Dear Stakeholders and I&APs,

**RE: NOTIFICATION OF THE RELEASE OF THE DRAFT EIA REPORTS FOR A 30-DAY COMMENT PERIOD FOR THE PROPOSED DEVELOPMENT OF 12 SOLAR PHOTOVOLTAIC (PV) FACILITIES (I.E. KUDU SOLAR FACILITIES) AND VARIOUS ASSOCIATED INFRASTRUCTURE, NEAR DE AAR, NORTHERN CAPE**

National Department of Forestry, Fisheries, the Environment (DFFE) Reference Numbers: 14/12/16/3/3/2/2244 to 14/12/16/3/3/2/2255

The Project Applicants are proposing to develop the Kudu Solar Photovoltaic (PV) cluster, consisting of up to 12 Solar PV Facilities, associated infrastructure and Electricity Grid Infrastructure (EGI), north-east of the town of De Aar, in the Renosterberg Local Municipality and Pixley Ka Seme District Municipality, in the Northern Cape Province. The generation capacity of each PV Facility will range from approximately 50 MWac to up to 350 MWac.

The proposed projects are not located within any of the gazetted Renewable Energy Development Zones (as gazetted in Government Notice R114; 16 February 2018). Therefore, the proposed Solar PV Facilities are subject to a Scoping and Environmental Impact Assessment (S&EIA) process and a decision-making period of 107 days, in terms of the 2014 National Environmental Management Act (Act 107 of 1998, as amended) (NEMA) EIA Regulations (as amended).

The Draft Scoping Reports for the proposed projects were made available to all potential and registered interested and/or Affected Parties (I&APs), Organs of State and relevant key stakeholders for a 30-day comment period, which extended from 9 December 2022 to 30 January 2023 (excluding public holidays and the regulated shutdown period). All comments and issues raised as part of the comment period were captured in the Comments and Responses Report and addressed, where relevant and applicable, in the Final Scoping Reports. The Final Scoping Reports were submitted to the DFFE on 11 February 2023 for consideration in line with Regulation 21(1) and 22 of the 2014 NEMA EIA Regulations (as amended). The DFFE notified the appointed EAP (CSIR) of the Department's acceptance of the Final Scoping Reports in March 2023.

In line with Regulation 23(1) (a) and 24 of the 2014 NEMA EIA Regulations (as amended), the Draft EIA Reports have been compiled and you are hereby notified of the availability of these reports for a 30-day commenting period, extending from 2 June 2023 to 3 July 2023 (excluding public holidays).

The Draft EIA Reports and Executive Summaries can be accessed via the project website at the link below:

Project website: <https://www.csir.co.za/environmental-impact-assessment>

The Draft EIA Reports inclusive of all appendices can be accessed via the Google Drive project folder at the link below:

Google Drive: [https://bit.ly/KUDU\\_SOLAR\\_PV](https://bit.ly/KUDU_SOLAR_PV)

<https://mail.google.com/mail/u/0/?ik=2c61e531fa&view=pt&search=all&permthid=thread-a:r5414205524856163889&siml=msg-arc54224679452...> 1/2

## APPENDICES

### ENVIRONMENTAL IMPACT ASSESSMENT REPORT: Scoping and Environmental Impact Assessment (EIA) Process for the Proposed Development of a Solar Photovoltaic (PV) Facility (Kudu Solar Facility 3) and associated infrastructure, near De Aar, Northern Cape Province

---

6/6/23, 12:12 PM

Gmail - Availability of Draft EIA Reports for Comment - Kudu Solar PV Facilities near De Aar, Northern Cape

You are kindly requested to register your interest and submit any comments you may have on the Draft EIA Reports to the CSIR by 3 July 2023 (details are provided below and in the attached).

Please do not hesitate to contact us should you have any queries relating to the above.

In accordance with the Protection of Personal Information Act (Act 4 of 2013), the CSIR will conduct itself responsibly when collecting, processing, storing and sharing any personal information collected for the purposes of Public Participation Processes (PPP) in terms of the 2014 NEMA EIA Regulations (as amended). By registering as an Interested and Affected Party (I&AP) and/or submitting information and comments, you consent to the collection, collation, processing, and storing of such information and the use and disclosure of such information for the aforementioned purpose (<https://www.csir.co.za/csir-privacy-notice>). If you would like to opt out of communications on this project, please do so by responding to this correspondence via email.

Kind Regards,

Rohaida Abed

CSIR Environmental Management Services

E-mail: [ems@csir.co.za](mailto:ems@csir.co.za)

Postal Address: Postnet Suite 367, Private Bag x10, Musgrave Road, 4062

Tel: 031 242 2300

---

 **Cover Letter to I&APs\_DEIRs\_Kudu Solar 1-12\_June2023.pdf**  
144K

## APPENDICES

ENVIRONMENTAL IMPACT ASSESSMENT REPORT: Scoping and Environmental Impact Assessment (EIA) Process for the Proposed Development of a Solar Photovoltaic (PV) Facility (Kudu Solar Facility 3) and associated infrastructure, near De Aar, Northern Cape Province

---

### 3. Proof of SMS Text Messages sent to I&APs, Stakeholders and Organs of State (where cell phone numbers are available) on 3 June 2023

**Copy of text included in the SMS:** Dear Stakeholder, Draft EIA Reports for the proposed Kudu Solar Facilities 1-12 near De Aar, NC, are available for comment until 3 July 2023. Visit [https://bit.ly/KUDU\\_SOLAR\\_PV](https://bit.ly/KUDU_SOLAR_PV) or [https://bit.ly/CSIR\\_EIA](https://bit.ly/CSIR_EIA) to access the reports. To send comments, queries or to opt out of future communication on these projects, email [ems@csir.co.za](mailto:ems@csir.co.za). Regards, CSIR EMS Team ([https://bit.ly/CSIR\\_privacy](https://bit.ly/CSIR_privacy))

created_time	msisdn	status_text	origin_address	delivered_time	batch_id
2023-06-03 15:54:14.0		Delivered to phone		2023-06-03 15:54:00.0	1788523770
2023-06-03 15:54:14.0		Delivered to phone		2023-06-03 15:54:00.0	1788523770
2023-06-03 15:54:14.0		Delivered to phone		2023-06-03 15:54:00.0	1788523770
2023-06-03 15:54:14.0		Delivered to phone		2023-06-03 15:54:00.0	1788523770
2023-06-03 15:54:14.0		Delivered to phone		2023-06-03 15:54:00.0	1788523770
2023-06-03 15:54:14.0		Delivered to phone		2023-06-03 15:54:00.0	1788523770
2023-06-03 15:54:14.0		Delivered to phone		2023-06-03 15:54:00.0	1788523770
2023-06-03 15:54:14.0		Delivered to phone		2023-06-03 15:54:00.0	1788523770
2023-06-03 15:54:14.0		Delivered to phone		2023-06-03 15:54:00.0	1788523770
2023-06-03 15:54:14.0		Delivered to phone		2023-06-03 15:54:00.0	1788523770
2023-06-03 15:54:14.0		Delivered to phone		2023-06-03 15:54:00.0	1788523770
2023-06-03 15:54:14.0		Delivered to phone		2023-06-03 15:54:00.0	1788523770
2023-06-03 15:54:14.0		Delivered to phone		2023-06-03 15:54:00.0	1788523770
2023-06-03 15:54:14.0		Delivered to phone		2023-06-03 15:54:00.0	1788523770
2023-06-03 15:54:14.0		Delivered to phone		2023-06-03 15:54:00.0	1788523770
2023-06-03 15:54:14.0		Delivered to phone		2023-06-03 15:54:00.0	1788523770
2023-06-03 15:54:14.0		Delivered to phone		2023-06-03 15:54:00.0	1788523770
2023-06-03 15:54:14.0		Delivered to phone		2023-06-03 15:54:00.0	1788523770
2023-06-03 15:54:14.0		Delivered to phone		2023-06-03 15:54:00.0	1788523770
2023-06-03 15:54:14.0		Delivered to phone		2023-06-03 15:54:00.0	1788523770
2023-06-03 15:54:14.0		Delivered to phone		2023-06-03 15:54:00.0	1788523770
2023-06-03 15:54:14.0		Delivered to phone		2023-06-03 15:54:00.0	1788523770
2023-06-03 15:54:14.0		Delivered to phone		2023-06-03 15:54:00.0	1788523770
2023-06-03 15:54:14.0		Delivered to phone		2023-06-03 15:54:00.0	1788523770

**APPENDICES**

ENVIRONMENTAL IMPACT ASSESSMENT REPORT: Scoping and Environmental Impact Assessment (EIA) Process for the Proposed Development of a Solar Photovoltaic (PV) Facility (Kudu Solar Facility 3) and associated infrastructure, near De Aar, Northern Cape Province

---

<b>created_time</b>	<b>msisdn</b>	<b>status_text</b>	<b>origin_address</b>	<b>delivered_time</b>	<b>batch_id</b>
2023-06-03 15:54:14.0		Delivered to phone		2023-06-03 15:54:00.0	1788523770
2023-06-03 15:54:14.0		Delivered to phone		2023-06-03 15:54:00.0	1788523770
2023-06-03 15:54:14.0		Delivered to phone		2023-06-03 15:54:00.0	1788523770
2023-06-03 15:54:14.0		Delivered to phone		2023-06-03 15:54:00.0	1788523770
2023-06-03 15:54:14.0		Delivered to phone		2023-06-03 15:55:00.0	1788523770
2023-06-03 15:54:14.0		Delivered to phone		2023-06-03 15:54:00.0	1788523770
2023-06-03 15:54:14.0		Delivered to phone		2023-06-03 15:54:00.0	1788523770
2023-06-03 15:54:14.0		Delivered to phone		2023-06-03 15:54:00.0	1788523770
2023-06-03 15:54:14.0		Delivered to phone		2023-06-03 15:54:00.0	1788523770
2023-06-03 15:54:14.0		Delivered to phone		2023-06-03 15:54:00.0	1788523770
2023-06-03 15:54:14.0		Delivered to phone		2023-06-03 15:54:00.0	1788523770
2023-06-03 15:54:14.0		Delivered to phone		2023-06-03 15:55:00.0	1788523770
2023-06-03 15:54:14.0		Delivered to phone		2023-06-03 15:54:00.0	1788523770
2023-06-03 15:54:14.0		Delivered to phone		2023-06-03 15:54:00.0	1788523770
2023-06-03 15:54:14.0		Delivered to phone		2023-06-03 15:54:00.0	1788523770
2023-06-03 15:54:14.0		Failed		2023-06-04 11:54:00.0	1788523770
2023-06-03 15:54:14.0		Failed		2023-06-05 07:54:00.0	1788523770
2023-06-03 15:54:14.0		Failed		2023-06-04 21:54:00.0	1788523770
2023-06-03 15:54:14.0		Delivered to phone		2023-06-03 15:54:00.0	1788523770
2023-06-03 15:54:14.0		Delivered to phone		2023-06-03 15:54:00.0	1788523770
2023-06-03 15:54:14.0		Delivered to phone		2023-06-03 15:54:00.0	1788523770
2023-06-03 15:54:14.0		Delivered to phone		2023-06-03 15:54:00.0	1788523770
2023-06-03 15:54:14.0		Delivered to phone		2023-06-03 15:54:00.0	1788523770
2023-06-03 15:54:14.0		Delivered to phone		2023-06-03 15:54:00.0	1788523770
2023-06-03 15:54:14.0		Delivered to phone		2023-06-03 15:54:00.0	1788523770
2023-06-03 15:54:14.0		Delivered to phone		2023-06-03 15:55:00.0	1788523770
2023-06-03 15:54:14.0		Delivered to phone		2023-06-03 15:54:00.0	1788523770
2023-06-03 15:54:14.0		Delivered to phone		2023-06-03 15:54:00.0	1788523770
2023-06-03 15:54:14.0		Delivered to phone		2023-06-03 15:54:00.0	1788523770
2023-06-03 15:54:14.0		Delivered to phone		2023-06-03 15:54:00.0	1788523770

**APPENDICES**

ENVIRONMENTAL IMPACT ASSESSMENT REPORT: Scoping and Environmental Impact Assessment (EIA) Process for the Proposed Development of a Solar Photovoltaic (PV) Facility (Kudu Solar Facility 3) and associated infrastructure, near De Aar, Northern Cape Province

---

<b>created_time</b>	<b>msisdn</b>	<b>status_text</b>	<b>origin_address</b>	<b>delivered_time</b>	<b>batch_id</b>
2023-06-03 15:54:14.0		Delivered to phone		2023-06-03 15:54:00.0	1788523770
2023-06-03 15:54:14.0		Delivered to phone		2023-06-03 15:54:00.0	1788523770
2023-06-03 15:54:14.0		Delivered to phone		2023-06-03 15:54:00.0	1788523770
2023-06-03 15:54:14.0		Delivered to phone		2023-06-03 15:54:00.0	1788523770
2023-06-03 15:54:14.0		Delivered to phone		2023-06-03 15:54:00.0	1788523770
2023-06-03 15:54:14.0		Delivered to phone		2023-06-03 15:54:00.0	1788523770
2023-06-03 15:54:14.0		Delivered to phone		2023-06-04 14:54:00.0	1788523770
2023-06-03 15:54:14.0		Delivered to phone		2023-06-04 14:59:00.0	1788523770
2023-06-03 15:54:14.0		Delivered to phone		2023-06-04 14:57:00.0	1788523770
2023-06-03 15:54:14.0		Delivered to phone		2023-06-03 15:54:00.0	1788523770
2023-06-03 15:54:14.0		Delivered to phone		2023-06-03 15:54:00.0	1788523770
2023-06-03 15:54:14.0		Delivered to phone		2023-06-03 15:54:00.0	1788523770
2023-06-03 15:54:14.0		Delivered to phone		2023-06-03 15:54:00.0	1788523770
2023-06-03 15:54:14.0		Delivered to phone		2023-06-03 15:54:00.0	1788523770
2023-06-03 15:54:14.0		Delivered to phone		2023-06-03 15:54:00.0	1788523770
2023-06-03 15:54:14.0		Delivered to phone		2023-06-03 15:54:00.0	1788523770
2023-06-03 15:54:14.0		Failed		2023-06-03 15:54:00.0	1788523770
2023-06-03 15:54:14.0		Failed		2023-06-03 15:54:00.0	1788523770
2023-06-03 15:54:14.0		Failed		2023-06-03 15:54:00.0	1788523770
2023-06-03 15:54:14.0		Delivered to phone		2023-06-03 15:54:00.0	1788523770
2023-06-03 15:54:14.0		Delivered to phone		2023-06-03 15:54:00.0	1788523770
2023-06-03 15:54:14.0		Delivered to phone		2023-06-03 15:54:00.0	1788523770
2023-06-03 15:54:14.0		Delivered to phone		2023-06-03 15:54:00.0	1788523770
2023-06-03 15:54:14.0		Delivered to phone		2023-06-03 15:54:00.0	1788523770
2023-06-03 15:54:14.0		Delivered to phone		2023-06-03 15:54:00.0	1788523770
2023-06-03 15:54:14.0		Delivered to phone		2023-06-03 15:54:00.0	1788523770
2023-06-03 15:54:14.0		Delivered to phone		2023-06-03 15:55:00.0	1788523770
2023-06-03 15:54:14.0		Delivered to phone		2023-06-03 15:54:00.0	1788523770
2023-06-03 15:54:14.0		Delivered to phone		2023-06-03 15:54:00.0	1788523770
2023-06-03 15:54:14.0		Delivered to phone		2023-06-03 15:54:00.0	1788523770
2023-06-03 15:54:14.0		Delivered to phone		2023-06-03 15:54:00.0	1788523770

APPENDICES

ENVIRONMENTAL IMPACT ASSESSMENT REPORT: Scoping and Environmental Impact Assessment (EIA) Process for the Proposed Development of a Solar Photovoltaic (PV) Facility (Kudu Solar Facility 3) and associated infrastructure, near De Aar, Northern Cape Province

created_time	msisdn	status_text	origin_address	delivered_time	batch_id
2023-06-03 15:54:14.0		Delivered to phone		2023-06-03 15:55:00.0	1788523770
2023-06-03 15:54:14.0		Delivered to phone		2023-06-03 15:54:00.0	1788523770
2023-06-03 15:54:14.0		Delivered to phone		2023-06-03 15:55:00.0	1788523770
2023-06-03 15:54:14.0		Delivered to phone		2023-06-03 15:54:00.0	1788523770
2023-06-03 15:54:14.0		Delivered to phone		2023-06-03 15:54:00.0	1788523770
2023-06-03 15:54:14.0		Delivered to phone		2023-06-03 15:54:00.0	1788523770
2023-06-03 15:54:14.0		Delivered to phone		2023-06-03 15:54:00.0	1788523770
2023-06-03 15:54:14.0		Delivered to phone		2023-06-03 15:55:00.0	1788523770
2023-06-03 15:54:14.0		Delivered to phone		2023-06-03 15:54:00.0	1788523770
2023-06-03 15:54:14.0		Delivered to phone		2023-06-03 15:55:00.0	1788523770
2023-06-03 15:54:14.0		Delivered to phone		2023-06-03 15:54:00.0	1788523770
2023-06-03 15:54:14.0		Delivered to phone		2023-06-03 15:54:00.0	1788523770
2023-06-03 15:54:14.0		Delivered to phone		2023-06-03 15:54:00.0	1788523770
2023-06-03 15:54:14.0		Delivered to phone		2023-06-03 15:54:00.0	1788523770
2023-06-03 15:54:14.0		Delivered to phone		2023-06-03 15:54:00.0	1788523770
2023-06-03 15:54:14.0		Delivered to phone		2023-06-03 15:55:00.0	1788523770
2023-06-03 15:54:14.0		Delivered to phone		2023-06-03 15:54:00.0	1788523770
2023-06-03 15:54:14.0		Delivered to phone		2023-06-03 15:54:00.0	1788523770
2023-06-03 15:54:14.0		Delivered to phone		2023-06-03 17:22:00.0	1788523770
2023-06-03 15:54:14.0		Delivered to phone		2023-06-03 17:23:00.0	1788523770
2023-06-03 15:54:14.0		Delivered to phone		2023-06-03 17:30:00.0	1788523770
2023-06-03 15:54:14.0		Delivered to phone		2023-06-03 15:54:00.0	1788523770
2023-06-03 15:54:14.0		Delivered to phone		2023-06-03 15:54:00.0	1788523770
2023-06-03 15:54:14.0		Delivered to phone		2023-06-03 15:54:00.0	1788523770
2023-06-03 15:54:14.0		Delivered to phone		2023-06-03 15:54:00.0	1788523770
2023-06-03 15:54:14.0		Delivered to phone		2023-06-03 15:54:00.0	1788523770
2023-06-03 15:54:14.0		Delivered to phone		2023-06-03 15:54:00.0	1788523770
2023-06-03 15:54:14.0		Delivered to phone		2023-06-03 15:54:00.0	1788523770
2023-06-03 15:54:14.0		Delivered to phone		2023-06-03 15:54:00.0	1788523770
2023-06-03 15:54:14.0		Delivered to phone		2023-06-03 15:54:00.0	1788523770

**APPENDICES**

ENVIRONMENTAL IMPACT ASSESSMENT REPORT: Scoping and Environmental Impact Assessment (EIA) Process for the Proposed Development of a Solar Photovoltaic (PV) Facility (Kudu Solar Facility 3) and associated infrastructure, near De Aar, Northern Cape Province

---

<b>created_time</b>	<b>msisdn</b>	<b>status_text</b>	<b>origin_address</b>	<b>delivered_time</b>	<b>batch_id</b>
2023-06-03 15:54:14.0		Delivered to phone		2023-06-03 15:54:00.0	1788523770
2023-06-03 15:54:14.0		Delivered to phone		2023-06-03 15:54:00.0	1788523770
2023-06-03 15:54:14.0		Delivered to phone		2023-06-03 15:54:00.0	1788523770
2023-06-03 15:54:14.0		Delivered to phone		2023-06-03 15:54:00.0	1788523770
2023-06-03 15:54:14.0		Delivered to phone		2023-06-03 15:54:00.0	1788523770
2023-06-03 15:54:14.0		Delivered to phone		2023-06-05 17:17:00.0	1788523770
2023-06-03 15:54:14.0		Delivered to phone		2023-06-05 17:17:00.0	1788523770
2023-06-03 15:54:14.0		Delivered to phone		2023-06-05 17:19:00.0	1788523770
2023-06-03 15:54:14.0		Failed: delivery to network failed			1788523770
2023-06-03 15:54:14.0		Failed: delivery to network failed			1788523770
2023-06-03 15:54:14.0		Failed: delivery to network failed			1788523770
2023-06-03 15:54:14.0		Delivered to phone		2023-06-03 15:54:00.0	1788523770
2023-06-03 15:54:14.0		Delivered to phone		2023-06-03 15:54:00.0	1788523770
2023-06-03 15:54:14.0		Delivered to phone		2023-06-03 15:54:00.0	1788523770
2023-06-03 15:54:14.0		Delivered to phone		2023-06-03 17:41:00.0	1788523770
2023-06-03 15:54:14.0		Delivered to phone		2023-06-03 17:41:00.0	1788523770
2023-06-03 15:54:14.0		Delivered to phone		2023-06-03 17:41:00.0	1788523770
2023-06-03 15:54:14.0		Delivered to phone		2023-06-03 15:54:00.0	1788523770
2023-06-03 15:54:14.0		Delivered to phone		2023-06-03 15:54:00.0	1788523770
2023-06-03 15:54:14.0		Delivered to phone		2023-06-03 15:54:00.0	1788523770
2023-06-03 15:54:14.0		Delivered to phone		2023-06-03 15:54:00.0	1788523770
2023-06-03 15:54:14.0		Failed: delivery to network failed			1788523770
2023-06-03 15:54:14.0		Failed: delivery to network failed			1788523770
2023-06-03 15:54:14.0		Failed: delivery to network failed			1788523770
2023-06-03 15:54:14.0		Delivered to phone		2023-06-03 15:54:00.0	1788523770
2023-06-03 15:54:14.0		Delivered to phone		2023-06-03 15:54:00.0	1788523770



**APPENDICES**

ENVIRONMENTAL IMPACT ASSESSMENT REPORT: Scoping and Environmental Impact Assessment (EIA) Process for the Proposed Development of a Solar Photovoltaic (PV) Facility (Kudu Solar Facility 3) and associated infrastructure, near De Aar, Northern Cape Province

---

<b>created_time</b>	<b>msisdn</b>	<b>status_text</b>	<b>origin_address</b>	<b>delivered_time</b>	<b>batch_id</b>
2023-06-03 15:54:14.0		Delivered to phone		2023-06-03 15:54:00.0	1788523770
2023-06-03 15:54:14.0		Delivered to phone		2023-06-03 15:54:00.0	1788523770
2023-06-03 15:54:14.0		Delivered to phone		2023-06-03 15:54:00.0	1788523770
2023-06-03 15:54:14.0		Delivered to phone		2023-06-03 15:54:00.0	1788523770
2023-06-03 15:54:14.0		Delivered to phone		2023-06-03 15:54:00.0	1788523770
2023-06-03 15:54:14.0		Delivered to phone		2023-06-03 15:54:00.0	1788523770
2023-06-03 15:54:14.0		Delivered to phone		2023-06-03 15:54:00.0	1788523770
2023-06-03 15:54:14.0		Delivered to phone		2023-06-03 15:54:00.0	1788523770
2023-06-03 15:54:14.0		Delivered to phone		2023-06-03 15:54:00.0	1788523770
2023-06-03 15:54:14.0		Delivered to phone		2023-06-03 15:54:00.0	1788523770
2023-06-03 15:54:14.0		Delivered to phone		2023-06-03 15:54:00.0	1788523770
2023-06-03 15:54:14.0		Delivered to phone		2023-06-03 15:54:00.0	1788523770
2023-06-03 15:54:14.0		Delivered to phone		2023-06-03 15:54:00.0	1788523770
2023-06-03 15:54:14.0		Delivered to phone		2023-06-03 15:54:00.0	1788523770
2023-06-03 15:54:14.0		Delivered to phone		2023-06-03 15:54:00.0	1788523770
2023-06-03 15:54:14.0		Delivered to phone		2023-06-03 15:54:00.0	1788523770
2023-06-03 15:54:14.0		Delivered to phone		2023-06-03 15:54:00.0	1788523770
2023-06-03 15:54:14.0		Failed		2023-06-03 16:04:00.0	1788523770
2023-06-03 15:54:14.0		Failed		2023-06-03 16:04:00.0	1788523770
2023-06-03 15:54:14.0		Failed		2023-06-03 16:04:00.0	1788523770
2023-06-03 15:54:14.0		Delivered to phone		2023-06-03 15:55:00.0	1788523770
2023-06-03 15:54:14.0		Delivered to phone		2023-06-03 15:54:00.0	1788523770
2023-06-03 15:54:14.0		Delivered to phone		2023-06-03 15:55:00.0	1788523770
2023-06-03 15:54:14.0		Delivered to phone		2023-06-03 15:54:00.0	1788523770
2023-06-03 15:54:14.0		Delivered to phone		2023-06-03 15:54:00.0	1788523770
2023-06-03 15:54:14.0		Delivered to phone		2023-06-03 15:54:00.0	1788523770
2023-06-03 15:54:14.0		Delivered to phone		2023-06-03 15:54:00.0	1788523770
2023-06-03 15:54:14.0		Delivered to phone		2023-06-03 15:54:00.0	1788523770
2023-06-03 15:54:14.0		Delivered to phone		2023-06-03 15:54:00.0	1788523770
2023-06-03 15:54:14.0		Delivered to phone		2023-06-03 15:54:00.0	1788523770
2023-06-03 15:54:14.0		Delivered to phone		2023-06-03 15:54:00.0	1788523770
2023-06-03 15:54:14.0		Delivered to phone		2023-06-03 17:08:00.0	1788523770

**APPENDICES**

ENVIRONMENTAL IMPACT ASSESSMENT REPORT: Scoping and Environmental Impact Assessment (EIA) Process for the Proposed Development of a Solar Photovoltaic (PV) Facility (Kudu Solar Facility 3) and associated infrastructure, near De Aar, Northern Cape Province

---

<b>created_time</b>	<b>msisdn</b>	<b>status_text</b>	<b>origin_address</b>	<b>delivered_time</b>	<b>batch_id</b>
2023-06-03 15:54:14.0		Delivered to phone		2023-06-03 17:11:00.0	1788523770
2023-06-03 15:54:14.0		Delivered to phone		2023-06-03 17:09:00.0	1788523770
2023-06-03 15:54:14.0		Delivered to phone		2023-06-03 15:55:00.0	1788523770
2023-06-03 15:54:14.0		Delivered to phone		2023-06-03 15:54:00.0	1788523770
2023-06-03 15:54:14.0		Delivered to phone		2023-06-03 15:54:00.0	1788523770
2023-06-03 15:54:14.0		Delivered to phone		2023-06-03 15:54:00.0	1788523770
2023-06-03 15:54:14.0		Delivered to phone		2023-06-03 15:54:00.0	1788523770
2023-06-03 15:54:14.0		Delivered to phone		2023-06-03 15:55:00.0	1788523770
2023-06-03 15:54:14.0		Failed		2023-06-03 16:04:00.0	1788523770
2023-06-03 15:54:14.0		Failed		2023-06-03 16:04:00.0	1788523770
2023-06-03 15:54:14.0		Failed		2023-06-03 16:04:00.0	1788523770
2023-06-03 15:54:14.0		Delivered to phone		2023-06-03 15:54:00.0	1788523770
2023-06-03 15:54:14.0		Delivered to phone		2023-06-03 15:54:00.0	1788523770
2023-06-03 15:54:14.0		Delivered to phone		2023-06-03 15:54:00.0	1788523770
2023-06-03 15:54:14.0		Delivered to phone		2023-06-03 15:54:00.0	1788523770
2023-06-03 15:54:14.0		Delivered to phone		2023-06-03 15:54:00.0	1788523770
2023-06-03 15:54:14.0		Delivered to phone		2023-06-03 15:54:00.0	1788523770
2023-06-03 15:54:14.0		Delivered to phone		2023-06-03 15:54:00.0	1788523770
2023-06-03 15:54:14.0		Delivered to phone		2023-06-03 15:54:00.0	1788523770
2023-06-03 15:54:14.0		Delivered to phone		2023-06-03 15:54:00.0	1788523770
2023-06-03 15:54:14.0		Delivered to phone		2023-06-03 15:54:00.0	1788523770
2023-06-03 15:54:14.0		Delivered to phone		2023-06-03 15:54:00.0	1788523770
2023-06-03 15:54:14.0		Failed		2023-06-03 16:04:00.0	1788523770
2023-06-03 15:54:14.0		Failed		2023-06-03 16:04:00.0	1788523770
2023-06-03 15:54:14.0		Failed		2023-06-03 16:04:00.0	1788523770
2023-06-03 15:54:14.0		Delivered to phone		2023-06-03 15:54:00.0	1788523770
2023-06-03 15:54:14.0		Delivered to phone		2023-06-03 15:54:00.0	1788523770
2023-06-03 15:54:14.0		Delivered to phone		2023-06-03 15:54:00.0	1788523770
2023-06-03 15:54:14.0		Delivered to phone		2023-06-03 15:54:00.0	1788523770
2023-06-03 15:54:14.0		Delivered to phone		2023-06-03 15:54:00.0	1788523770
2023-06-03 15:54:14.0		Delivered to phone		2023-06-03 15:54:00.0	1788523770
2023-06-03 15:54:14.0		Delivered to phone		2023-06-03 15:54:00.0	1788523770
2023-06-03 15:54:14.0		Delivered to phone		2023-06-03 15:54:00.0	1788523770

**APPENDICES**

ENVIRONMENTAL IMPACT ASSESSMENT REPORT: Scoping and Environmental Impact Assessment (EIA) Process for the Proposed Development of a Solar Photovoltaic (PV) Facility (Kudu Solar Facility 3) and associated infrastructure, near De Aar, Northern Cape Province

---

<b>created_time</b>	<b>msisdn</b>	<b>status_text</b>	<b>origin_address</b>	<b>delivered_time</b>	<b>batch_id</b>
2023-06-03 15:54:14.0		Delivered to phone		2023-06-03 15:54:00.0	1788523770
2023-06-03 15:54:14.0		Delivered to phone		2023-06-03 15:54:00.0	1788523770
2023-06-03 15:54:14.0		Delivered to phone		2023-06-03 15:54:00.0	1788523770
2023-06-03 15:54:14.0		Delivered to phone		2023-06-03 15:54:00.0	1788523770
2023-06-03 15:54:14.0		Delivered to phone		2023-06-03 15:54:00.0	1788523770
2023-06-03 15:54:14.0		Delivered to phone		2023-06-03 15:54:00.0	1788523770
2023-06-03 15:54:14.0		Delivered to phone		2023-06-03 15:54:00.0	1788523770
2023-06-03 15:54:14.0		Delivered to phone		2023-06-03 15:54:00.0	1788523770
2023-06-03 15:54:14.0		Delivered to phone		2023-06-03 15:54:00.0	1788523770
2023-06-03 15:54:14.0		Delivered to phone		2023-06-03 15:54:00.0	1788523770
2023-06-03 15:54:14.0		Delivered to phone		2023-06-03 15:54:00.0	1788523770
2023-06-03 15:54:14.0		Delivered to phone		2023-06-03 15:54:00.0	1788523770
2023-06-03 15:54:14.0		Delivered to phone		2023-06-03 15:54:00.0	1788523770
2023-06-03 15:54:14.0		Delivered to phone		2023-06-03 15:54:00.0	1788523770
2023-06-03 15:54:14.0		Delivered to phone		2023-06-03 15:54:00.0	1788523770
2023-06-03 15:54:14.0		Delivered to phone		2023-06-03 15:55:00.0	1788523770
2023-06-03 15:54:14.0		Delivered to phone		2023-06-03 15:54:00.0	1788523770
2023-06-03 15:54:14.0		Delivered to phone		2023-06-03 15:54:00.0	1788523770
2023-06-03 15:54:14.0		Delivered to phone		2023-06-03 15:54:00.0	1788523770
2023-06-03 15:54:14.0		Delivered to phone		2023-06-03 15:57:00.0	1788523770
2023-06-03 15:54:14.0		Delivered to phone		2023-06-03 15:59:00.0	1788523770
2023-06-03 15:54:14.0		Delivered to phone		2023-06-03 16:24:00.0	1788523770
2023-06-03 15:54:14.0		Delivered to phone		2023-06-03 15:54:00.0	1788523770
2023-06-03 15:54:14.0		Delivered to phone		2023-06-03 15:55:00.0	1788523770
2023-06-03 15:54:14.0		Delivered to phone		2023-06-03 15:54:00.0	1788523770
2023-06-03 15:54:14.0		Delivered to phone		2023-06-03 18:05:00.0	1788523770
2023-06-03 15:54:14.0		Delivered to phone		2023-06-03 16:03:00.0	1788523770
2023-06-03 15:54:14.0		Delivered to phone		2023-06-03 18:05:00.0	1788523770
2023-06-03 15:54:14.0		Delivered to phone		2023-06-03 15:54:00.0	1788523770
2023-06-03 15:54:14.0		Delivered to phone		2023-06-03 15:54:00.0	1788523770
2023-06-03 15:54:14.0		Delivered to phone		2023-06-03 15:54:00.0	1788523770
2023-06-03 15:54:14.0		Delivered to phone		2023-06-03 15:54:00.0	1788523770
2023-06-03 15:54:14.0		Delivered to phone		2023-06-03 15:54:00.0	1788523770
2023-06-03 15:54:14.0		Delivered to phone		2023-06-03 15:54:00.0	1788523770
2023-06-03 15:54:14.0		Delivered to phone		2023-06-03 15:54:00.0	1788523770
2023-06-03 15:54:14.0		Delivered to phone		2023-06-03 15:54:00.0	1788523770
2023-06-03 15:54:14.0		Delivered to phone		2023-06-03 15:54:00.0	1788523770

**APPENDICES**

ENVIRONMENTAL IMPACT ASSESSMENT REPORT: Scoping and Environmental Impact Assessment (EIA) Process for the Proposed Development of a Solar Photovoltaic (PV) Facility (Kudu Solar Facility 3) and associated infrastructure, near De Aar, Northern Cape Province

---

<b>created_time</b>	<b>msisdn</b>	<b>status_text</b>	<b>origin_address</b>	<b>delivered_time</b>	<b>batch_id</b>
2023-06-03 15:54:14.0		Delivered to phone		2023-06-03 15:54:00.0	1788523770
2023-06-03 15:54:14.0		Delivered to phone		2023-06-03 15:54:00.0	1788523770
2023-06-03 15:54:14.0		Delivered to phone		2023-06-03 15:54:00.0	1788523770
2023-06-03 15:54:14.0		Delivered to phone		2023-06-03 15:54:00.0	1788523770
2023-06-03 15:54:14.0		Delivered to phone		2023-06-03 15:54:00.0	1788523770
2023-06-03 15:54:14.0		Delivered to phone		2023-06-03 15:54:00.0	1788523770
2023-06-03 15:54:14.0		Delivered to phone		2023-06-03 15:54:00.0	1788523770
2023-06-03 15:54:14.0		Delivered to phone		2023-06-03 15:54:00.0	1788523770
2023-06-03 15:54:14.0		Delivered to phone		2023-06-03 15:54:00.0	1788523770
2023-06-03 15:54:14.0		Delivered to phone		2023-06-03 15:54:00.0	1788523770
2023-06-03 15:54:14.0		Delivered to phone		2023-06-03 15:54:00.0	1788523770
2023-06-03 15:54:14.0		Delivered to phone		2023-06-03 15:54:00.0	1788523770
2023-06-03 15:54:14.0		Delivered to phone		2023-06-03 15:54:00.0	1788523770
2023-06-03 15:54:14.0		Delivered to phone		2023-06-03 15:54:00.0	1788523770
2023-06-03 15:54:14.0		Delivered to phone		2023-06-03 15:54:00.0	1788523770
2023-06-03 15:54:14.0		Delivered to phone		2023-06-03 15:54:00.0	1788523770
2023-06-03 15:54:14.0		Delivered to phone		2023-06-03 15:54:00.0	1788523770
2023-06-03 15:54:14.0		Delivered to phone		2023-06-03 15:54:00.0	1788523770
2023-06-03 15:54:14.0		Delivered to phone		2023-06-03 15:54:00.0	1788523770
2023-06-03 15:54:14.0		Delivered to phone		2023-06-03 15:54:00.0	1788523770
2023-06-03 15:54:14.0		Delivered to phone		2023-06-03 15:54:00.0	1788523770
2023-06-03 15:54:14.0		Failed: delivery to network failed			1788523770
2023-06-03 15:54:14.0		Failed: delivery to network failed			1788523770
2023-06-03 15:54:14.0		Failed: delivery to network failed			1788523770
2023-06-03 15:54:14.0		Delivered to phone		2023-06-03 15:55:00.0	1788523770
2023-06-03 15:54:14.0		Delivered to phone		2023-06-03 15:55:00.0	1788523770
2023-06-03 15:54:14.0		Delivered to phone		2023-06-03 15:55:00.0	1788523770

## APPENDICES

# ENVIRONMENTAL IMPACT ASSESSMENT REPORT: Scoping and Environmental Impact Assessment (EIA) Process for the Proposed Development of a Solar Photovoltaic (PV) Facility (Kudu Solar Facility 3) and associated infrastructure, near De Aar, Northern Cape Province

### 4. Proof of Upload of the DEIAR to the CSIR Project Website

The screenshot displays a web browser window with the URL [csir.co.za/environmental-impact-assessment](https://csir.co.za/environmental-impact-assessment). The page features the CSIR logo and a navigation menu. The main content area is a table with the following structure:

Project Name	Location
Scoping and Environmental Impact Assessment (EIA) Processes for the Proposed Development of the Kudu Solar Photovoltaic (PV) Facilities and associated infrastructure, near De Aar, Northern Cape Province: Scoping and EIA Reports for the Proposed Development of the Kudu Solar Photovoltaic (PV) Facilities	
Facility 1: <ul style="list-style-type: none"><li>Draft EIA report</li><li>Executive Summary</li></ul>	
Facility 2: <ul style="list-style-type: none"><li>Draft EIA report</li><li>Executive summary</li></ul>	
Facility 3: <ul style="list-style-type: none"><li>Draft EIA report</li><li>Executive summary</li></ul>	
Facility 4: <ul style="list-style-type: none"><li>Draft EIA report</li><li>Executive summary</li></ul>	
Facility 5: <ul style="list-style-type: none"><li>Draft EIA report</li><li>Executive summary</li></ul>	
Facility 6: <ul style="list-style-type: none"><li>Draft EIA report</li><li>Executive summary</li></ul>	ABO Wind renewable energies (Pty) Ltd
Facility 7: <ul style="list-style-type: none"><li>Draft EIA report</li><li>Executive summary</li></ul>	Northern Cape
Facility 8: <ul style="list-style-type: none"><li>Draft EIA report</li><li>Executive summary</li></ul>	
Facility 9: <ul style="list-style-type: none"><li>Draft EIA report</li><li>Executive summary</li></ul>	
Facility 10: <ul style="list-style-type: none"><li>Draft EIA report</li><li>Executive summary</li></ul>	
Facility 11: <ul style="list-style-type: none"><li>Draft EIA report</li><li>Executive summary</li></ul>	
Facility 12: <ul style="list-style-type: none"><li>Draft EIA report</li><li>Executive summary</li></ul>	

At the bottom of the page, there is a footer that reads: "For more information, contact [ems@csir.co.za](mailto:ems@csir.co.za) or visit <https://bit.ly/3UIETdC>".

## APPENDICES

### ENVIRONMENTAL IMPACT ASSESSMENT REPORT: Scoping and Environmental Impact Assessment (EIA) Process for the Proposed Development of a Solar Photovoltaic (PV) Facility (Kudu Solar Facility 3) and associated infrastructure, near De Aar, Northern Cape Province

#### 5. Proof of Upload of the DEIAR to Google Drive (Kudu Solar Facility 3)

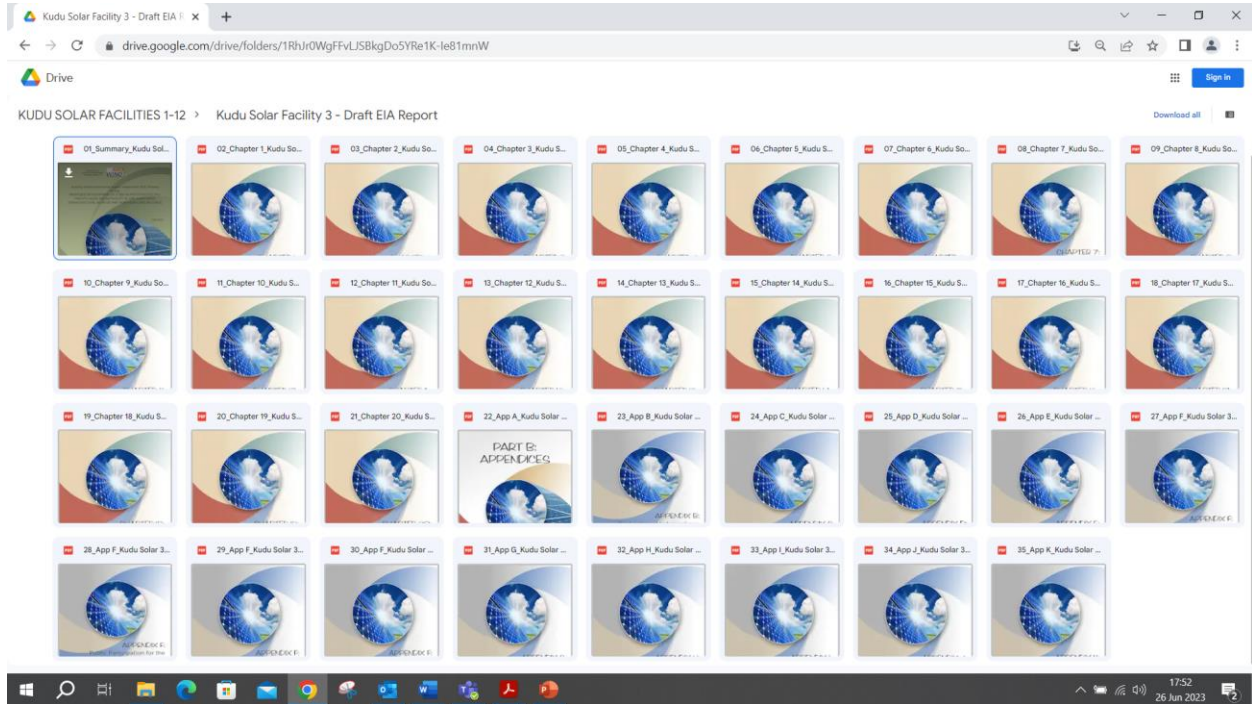

## APPENDICES

# ENVIRONMENTAL IMPACT ASSESSMENT REPORT: Scoping and Environmental Impact Assessment (EIA) Process for the Proposed Development of a Solar Photovoltaic (PV) Facility (Kudu Solar Facility 3) and associated infrastructure, near De Aar, Northern Cape Province

## 6. Proof of Upload of the DEIAR to SAHRIS (Kudu Solar Facility 3)

Kudu Solar Facility 3 | SAHRA

sahris.sahra.org.za/cases/kudu-solar-facility-3

### Kudu Solar Facility 3

Log in or register to post comments 45 reads

**CaseHeader** LocationInfo Admin

Status: Closed (Approved)

HeritageAuthority(s): SAHRA  
NBKG

Case Type: Section 38 (B) - Statutory Comment Required

Development Type: Renewable Energy  
Solar

ProposalDescription:  
Kudu Solar Facility 1 (Pty) Ltd to Kudu Solar Facility 12 (Pty) Ltd is proposing to develop 12 Solar Photovoltaic (PV) power generation facilities and associated Electrical Grid Infrastructure (EGI), north-east of the town of De Aar, in the Renosterberg Local Municipality and Pixley Ka Seme District Municipality, in the Northern Cape Province. Scoping and Environmental Impact Assessment (EIA) Processes are currently being undertaken for the 12 Solar PV facilities. Separate Basic Assessment (BA) and/or EGI Standard Registration processes will be commissioned separately, once finalised, for the EGI projects. This case is for the proposed Kudu Solar Facility 3, and the Applicant is Kudu Solar Facility 3 (Pty) Ltd.

ApplicationDate: Sunday, December 11, 2022 - 20:53

CaseID: 20338

OtherReferences:

CaseReference	Department	Application Type	DeadlineDate	ContactPerson
14/12/16/3/2/2246	Department of Forestry, Fisheries and the Environment	NEMA	03/07/2023	Makhosi Yeni

Heritage Reports: Kudu Solar Facility 3 Heritage Scoping Report  
Kudu Solar Facility and EGI Palaeontology SSV  
Kudu Solar Facility and EGI Palaeontology SSV EIA Phase

ReferenceList:

**AdditionalDocuments**

1. Draft Scoping Report Kudu Solar Facility 3
2. Appendix C Maps Kudu Solar Facility 3
3. Appendix E PPP Kudu Solar Facility 3
4. Appendix F Pre-App Consultation Kudu Solar Facility 3
5. Appendix G.5 VIA Scoping Level Kudu Solar Facility 3
6. Final Scoping Report Kudu Solar Facility 3\_Part 1 (Summary to Ch 2)
7. Final Scoping Report Kudu Solar Facility 3\_Part 2 (Ch 3 to Ch 7)
8. Appendix E PPP Part 1\_FSR\_Kudu Solar Facility 3
9. Appendix E PPP Part 2\_FSR\_Kudu Solar Facility 3
10. Appendix E PPP Part 3\_CRR\_FSR\_Kudu Solar Facility 3
11. Draft EIA Report\_Chapter 10\_VIA\_Kudu Solar Facility 3
12. Draft EIA Report\_Appendix H\_PPP EIA Phase\_Kudu Solar Facility 3
13. Draft EIA Report\_Appendix I\_EMPR for PV\_Kudu Solar Facility 3
14. Draft EIA Report\_Appendix J\_EMPR for Substations\_Kudu Solar Facility 3
15. Draft EIA Report\_Executive Summary\_Kudu Solar Facility 3
16. Draft EIA Report\_Appendix C\_Maps\_Kudu Solar Facility 3

Back to Top

South African Heritage Resources Agency (SAHRA)  
111 Hamington Street  
Cape Town  
8001

PO Box 4637  
Cape Town, 8000  
Tel 021 462 4502/Fax 021 462 4509  
Email info@sahra.org.za  
Web www.sahra.org.za

An agency of the Department of Arts & Culture

Powered by Drupal

Site best viewed using Google Chrome  
Disclaimer

15°C Partly sunny 19:43 04 Jul 2023

## APPENDICES

ENVIRONMENTAL IMPACT ASSESSMENT REPORT: Scoping and Environmental Impact Assessment (EIA) Process for the Proposed Development of a Solar Photovoltaic (PV) Facility (Kudu Solar Facility 3) and associated infrastructure, near De Aar, Northern Cape Province

---

### 7. Follow-Up/ Reminder Email sent to all I&APs, Stakeholders, and Organs of State on 8 June 2023

---

**From:** EMS <ems@csir.co.za>  
**Sent:** Thursday, 08 June 2023 09:20  
**To:** EMS  
**Subject:** RE: Reminder of the Availability of Draft EIA Reports for Comment - Kudu Solar PV  
**Attachments:** Cover Letter to I&APs\_DEIRs\_Kudu Solar 1-12\_June2023.pdf

**Categories:** This message has been archived by Retain on June 20 2023 13:13  
**Bcc:**

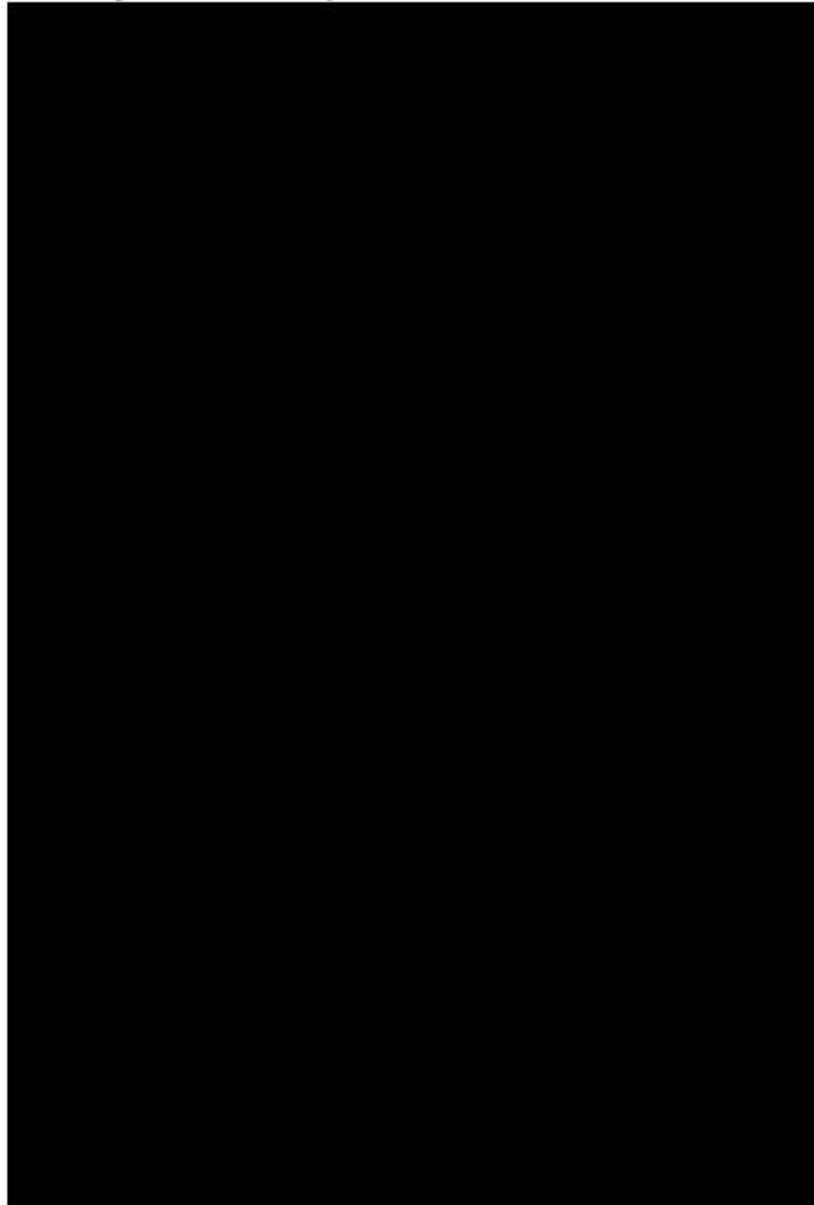



## APPENDICES

ENVIRONMENTAL IMPACT ASSESSMENT REPORT: Scoping and Environmental Impact Assessment (EIA) Process for the Proposed Development of a Solar Photovoltaic (PV) Facility (Kudu Solar Facility 3) and associated infrastructure, near De Aar, Northern Cape Province

---

**Bcc:**

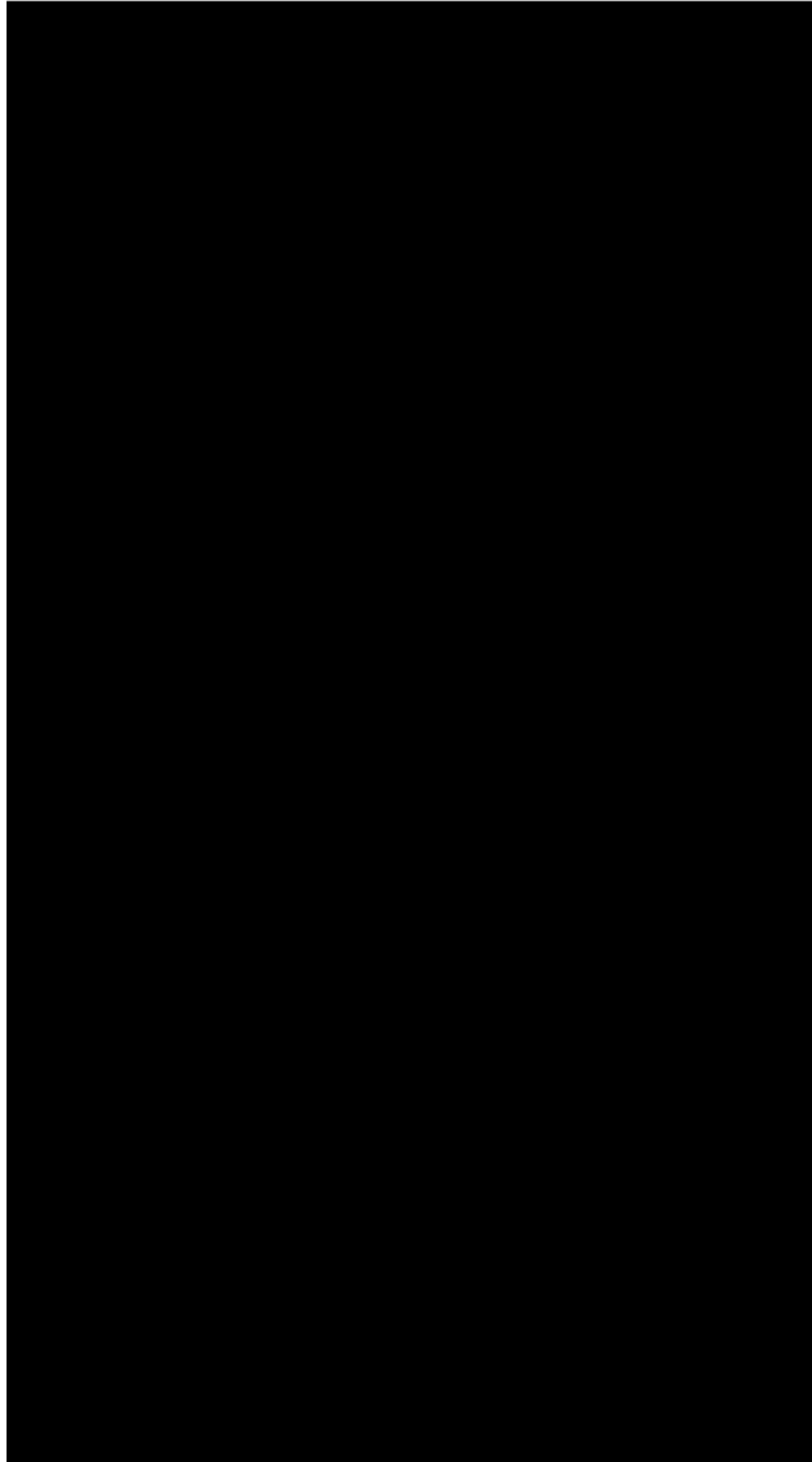

## APPENDICES

### ENVIRONMENTAL IMPACT ASSESSMENT REPORT: Scoping and Environmental Impact Assessment (EIA) Process for the Proposed Development of a Solar Photovoltaic (PV) Facility (Kudu Solar Facility 3) and associated infrastructure, near De Aar, Northern Cape Province

---

Dear Interested and Affected Party / Stakeholder,

**RE: REMINDER OF THE RELEASE OF THE DRAFT EIA REPORTS FOR A 30-DAY COMMENT PERIOD FOR THE PROPOSED DEVELOPMENT OF 12 SOLAR PHOTOVOLTAIC (PV) FACILITIES (I.E. KUDU SOLAR FACILITIES) AND VARIOUS ASSOCIATED INFRASTRUCTURE, NEAR DE AAR, NORTHERN CAPE**

National Department of Forestry, Fisheries, the Environment (DFFE) Reference Numbers:

Kudu Solar Facility 1: 14/12/16/3/3/2/2244	Kudu Solar Facility 5: 14/12/16/3/3/2/2248	Kudu Solar Facility 9: 14/12/16/3/3/2/2252
Kudu Solar Facility 2: 14/12/16/3/3/2/2245	Kudu Solar Facility 6: 14/12/16/3/3/2/2249	Kudu Solar Facility 10: 14/12/16/3/3/2/2253
Kudu Solar Facility 3: 14/12/16/3/3/2/2246	Kudu Solar Facility 7: 14/12/16/3/3/2/2250	Kudu Solar Facility 11: 14/12/16/3/3/2/2254
Kudu Solar Facility 4: 14/12/16/3/3/2/2247	Kudu Solar Facility 8: 14/12/16/3/3/2/2251	Kudu Solar Facility 12: 14/12/16/3/3/2/2255

Further to the email notification below, this serves as a reminder that the 30-day public comment period on the Draft EIA Reports for the proposed 12 Solar Photovoltaic (PV) facilities (i.e. Kudu Solar Facilities) and various associated infrastructure, near De Aar, Northern Cape, closes on 3 July 2023.

As indicated below the Draft EIA Reports can be accessed as follows:

- Google Drive: [https://bit.ly/KUDU\\_SOLAR\\_PV](https://bit.ly/KUDU_SOLAR_PV)
- Project website: <https://www.csir.co.za/environmental-impact-assessment>

You are kindly requested to register your interest and submit any comments you may have on the Draft EIA Reports to the CSIR by 3 July 2023 (details are provided below and in the attached).

Thank you to those of you that have already provided comment.

Please do not hesitate to contact us should you have any queries relating to the above.

In accordance with the Protection of Personal Information Act (Act 4 of 2013), the CSIR will conduct itself responsibly when collecting, processing, storing and sharing any personal information collected for the purposes of Public Participation Processes (PPP) in terms of the 2014 NEMA EIA Regulations (as amended). By registering as an Interested and Affected Party (I&AP) and/or submitting information and comments, you consent to the collection, collation, processing, and storing of such information and the use and disclosure of such information for the aforementioned purpose (<https://www.csir.co.za/csir-privacy-notice>). If you would like to opt out of communications on this project, please do so by responding to this correspondence via email.

Kind Regards,  
Rohaida Abed

CSIR Environmental Management Services  
E-mail: [ems@csir.co.za](mailto:ems@csir.co.za)  
Postal Address: Postnet Suite 367, Private Bag x10, Musgrave Road, 4062  
Tel: 031 242 2300

---

## APPENDICES

### ENVIRONMENTAL IMPACT ASSESSMENT REPORT: Scoping and Environmental Impact Assessment (EIA) Process for the Proposed Development of a Solar Photovoltaic (PV) Facility (Kudu Solar Facility 3) and associated infrastructure, near De Aar, Northern Cape Province

#### 8. Proof of Delivery of Follow Up/ Reminder Email sent to all I&APs, Stakeholders, and Organs of State on 8 June 2023

EMS - Delivery Receipts						By Date <span style="font-size: small;">v</span> <span style="font-size: small;">↑</span>
From	Subject	Received	Size	Categories	Mention	
<b>▼ Last Month</b>						
	<b>post... Undeliverable: RE: Reminder of the Availabilit...</b> <span style="font-size: x-small;">Fri 09 Ju... 441 KB</span> <a href="#">This me...</a>	Delivery has failed to these recipients or groups:				
	<b>post... Undeliverable: RE: Reminder of the Availabilit...</b> <span style="font-size: x-small;">Fri 09 Ju... 445 KB</span> <a href="#">This me...</a>	Delivery has failed to these recipients or groups:				
	<b>post... Delivered: RE: Reminder of the Availability of ...</b> <span style="font-size: x-small;">Thu 08 J... 141 KB</span> <a href="#">This me...</a>	You don't often get email from postmaster@outlook.com. Learn why this is important < <a href="https://aka.ms/LearnAboutSenderIdentification">https://aka.ms/LearnAboutSenderIdentification</a> >				
	<b>Mail D... Undeliverable: Renewable Energy Applications: O...</b> <span style="font-size: x-small;">Thu 08 Ju... 31 KB</span> <a href="#">This mess...</a>	[You don't often get email from mailer-daemon@pta-smg4.csir.co.za. Learn why this is important at <a href="https://aka.ms/LearnAboutSenderIdentification">https://aka.ms/LearnAboutSenderIdentification</a> ] This is				
	<b>Mail D... Undeliverable: Reminder of the Availability of Dra...</b> <span style="font-size: x-small;">Thu 08 Ju... 31 KB</span> <a href="#">This mess...</a>	[You don't often get email from mailer-daemon@pta-smg3.csir.co.za. Learn why this is important at <a href="https://aka.ms/LearnAboutSenderIdentification">https://aka.ms/LearnAboutSenderIdentification</a> ] This is				
	<b>Mail ... Relayed: Reminder of the Availability of Draft...</b> <span style="font-size: x-small;">Thu 08 J... 76 KB</span> <a href="#">This me...</a>	[You don't often get email from mailer-daemon@pta-smg3.csir.co.za. Learn why this is important at <a href="https://aka.ms/LearnAboutSenderIdentification">https://aka.ms/LearnAboutSenderIdentification</a> ] This is				
	<b>Mail ... Relayed: Reminder of the Availability of Draft...</b> <span style="font-size: x-small;">Thu 08 J... 68 KB</span> <a href="#">This me...</a>	[You don't often get email from mailer-daemon@pta-smg3.csir.co.za. Learn why this is important at <a href="https://aka.ms/LearnAboutSenderIdentification">https://aka.ms/LearnAboutSenderIdentification</a> ] This is				
	<b>post... Delivered: RE: Reminder of the Availability of ...</b> <span style="font-size: x-small;">Thu 08 J... 139 KB</span> <a href="#">This me...</a>	Your message has been delivered to the following recipients:				
	<b>post... Delivered: RE: Reminder of the Availability of ...</b> <span style="font-size: x-small;">Thu 08 J... 139 KB</span> <a href="#">This me...</a>	Your message has been delivered to the following recipients:				
	<b>post... Undeliverable: RE: Reminder of the Availabilit...</b> <span style="font-size: x-small;">Thu 08 J... 410 KB</span> <a href="#">This me...</a>	You don't often get email from postmaster@transnet.net. Learn why this is important < <a href="https://aka.ms/LearnAboutSenderIdentification">https://aka.ms/LearnAboutSenderIdentification</a> >				
	<b>post... Undeliverable: RE: Reminder of the Availabilit...</b> <span style="font-size: x-small;">Thu 08 J... 409 KB</span> <a href="#">This me...</a>	You don't often get email from postmaster@transnet.net. Learn why this is important < <a href="https://aka.ms/LearnAboutSenderIdentification">https://aka.ms/LearnAboutSenderIdentification</a> >				
	<b>Mail ... Relayed: Reminder of the Availability of Draft...</b> <span style="font-size: x-small;">Thu 08 J... 81 KB</span> <a href="#">This me...</a>	[You don't often get email from mailer-daemon@pta-smg3.csir.co.za. Learn why this is important at <a href="https://aka.ms/LearnAboutSenderIdentification">https://aka.ms/LearnAboutSenderIdentification</a> ] This is				
	<b>post... Delivered: RE: Reminder of the Availability of ...</b> <span style="font-size: x-small;">Thu 08 J... 144 KB</span> <a href="#">This me...</a>	You don't often get email from postmaster@dws.gov.za. Learn why this is important < <a href="https://aka.ms/LearnAboutSenderIdentification">https://aka.ms/LearnAboutSenderIdentification</a> >				
	<b>Mail ... Undeliverable: Reminder of the Availability of...</b> <span style="font-size: x-small;">Thu 08 J... 41 KB</span> <a href="#">This me...</a>	[You don't often get email from mailer-daemon@mx1.dot.gov.za. Learn why this is important at <a href="https://aka.ms/LearnAboutSenderIdentification">https://aka.ms/LearnAboutSenderIdentification</a> ] This is				
	<b>post... Delivered: RE: Reminder of the Availability of ...</b> <span style="font-size: x-small;">Thu 08 J... 141 KB</span> <a href="#">This me...</a>	Your message has been delivered to the following recipients:				
	<b>post... Delivered: RE: Reminder of the Availability of ...</b> <span style="font-size: x-small;">Thu 08 J... 144 KB</span> <a href="#">This me...</a>	You don't often get email from postmaster@dws.gov.za. Learn why this is important < <a href="https://aka.ms/LearnAboutSenderIdentification">https://aka.ms/LearnAboutSenderIdentification</a> >				
	<b>post... Delivered: RE: Reminder of the Availability of ...</b> <span style="font-size: x-small;">Thu 08 J... 142 KB</span> <a href="#">This me...</a>	You don't often get email from postmaster@dws.gov.za. Learn why this is important < <a href="https://aka.ms/LearnAboutSenderIdentification">https://aka.ms/LearnAboutSenderIdentification</a> >				
	<b>post... Delivered: RE: Reminder of the Availability of ...</b> <span style="font-size: x-small;">Thu 08 J... 140 KB</span> <a href="#">This me...</a>	Your message has been delivered to the following recipients:				
	<b>post... Delivered: RE: Reminder of the Availability of ...</b> <span style="font-size: x-small;">Thu 08 J... 140 KB</span> <a href="#">This me...</a>	Your message has been delivered to the following recipients:				
	<b>post... Delivered: RE: Reminder of the Availability of ...</b> <span style="font-size: x-small;">Thu 08 J... 145 KB</span> <a href="#">This me...</a>	You don't often get email from postmaster@dws.gov.za. Learn why this is important < <a href="https://aka.ms/LearnAboutSenderIdentification">https://aka.ms/LearnAboutSenderIdentification</a> >				
	<b>post... Delivered: RE: Reminder of the Availability of ...</b> <span style="font-size: x-small;">Thu 08 J... 145 KB</span> <a href="#">This me...</a>	You don't often get email from postmaster@dws.gov.za. Learn why this is important < <a href="https://aka.ms/LearnAboutSenderIdentification">https://aka.ms/LearnAboutSenderIdentification</a> >				
	<b>post... Delivered: RE: Reminder of the Availability of ...</b> <span style="font-size: x-small;">Thu 08 J... 145 KB</span> <a href="#">This me...</a>	You don't often get email from postmaster@dws.gov.za. Learn why this is important < <a href="https://aka.ms/LearnAboutSenderIdentification">https://aka.ms/LearnAboutSenderIdentification</a> >				
	<b>post... Delivered: RE: Reminder of the Availability of ...</b> <span style="font-size: x-small;">Thu 08 J... 145 KB</span> <a href="#">This me...</a>	You don't often get email from postmaster@dws.gov.za. Learn why this is important < <a href="https://aka.ms/LearnAboutSenderIdentification">https://aka.ms/LearnAboutSenderIdentification</a> >				
	<b>post... Delivered: RE: Reminder of the Availability of ...</b> <span style="font-size: x-small;">Thu 08 J... 145 KB</span> <a href="#">This me...</a>	You don't often get email from postmaster@dws.gov.za. Learn why this is important < <a href="https://aka.ms/LearnAboutSenderIdentification">https://aka.ms/LearnAboutSenderIdentification</a> >				
	<b>post... Delivered: RE: Reminder of the Availability of ...</b> <span style="font-size: x-small;">Thu 08 J... 142 KB</span> <a href="#">This me...</a>	You don't often get email from postmaster@corp.akuoenergy.com. Learn why this is important < <a href="https://aka.ms/LearnAboutSenderIdentification">https://aka.ms/LearnAboutSenderIdentification</a> >				

## APPENDICES

### ENVIRONMENTAL IMPACT ASSESSMENT REPORT: Scoping and Environmental Impact Assessment (EIA) Process for the Proposed Development of a Solar Photovoltaic (PV) Facility (Kudu Solar Facility 3) and associated infrastructure, near De Aar, Northern Cape Province

EMS - Delivery Receipts						By Date <span style="font-size: small;">v</span> <span style="font-size: small;">↑</span>
				From	Subject	Received   Size   Categories   Mention
				post...	<b>Delivered: RE: Reminder of the Availability of ...</b> Thu 08 J... 138 KB <b>This me...</b> You don't often get email from postmaster@g7energies.com. Learn why this is important <https://aka.ms/LearnAboutSenderIdentification>	
				post...	<b>Delivered: RE: Reminder of the Availability of ...</b> Thu 08 J... 138 KB <b>This me...</b> You don't often get email from postmaster@g7energies.com. Learn why this is important <https://aka.ms/LearnAboutSenderIdentification>	
				post...	<b>Delivered: RE: Reminder of the Availability of ...</b> Thu 08 J... 138 KB <b>This me...</b> You don't often get email from postmaster@g7energies.com. Learn why this is important <https://aka.ms/LearnAboutSenderIdentification>	
				post...	<b>Delivered: RE: Reminder of the Availability of ...</b> Thu 08 J... 138 KB <b>This me...</b> You don't often get email from postmaster@g7energies.com. Learn why this is important <https://aka.ms/LearnAboutSenderIdentification>	
				post...	<b>Delivered: RE: Reminder of the Availability of ...</b> Thu 08 J... 138 KB <b>This me...</b> You don't often get email from postmaster@g7energies.com. Learn why this is important <https://aka.ms/LearnAboutSenderIdentification>	
				post...	<b>Delivered: RE: Reminder of the Availability of ...</b> Thu 08 J... 138 KB <b>This me...</b> You don't often get email from postmaster@g7energies.com. Learn why this is important <https://aka.ms/LearnAboutSenderIdentification>	
				post...	<b>Delivered: RE: Reminder of the Availability of ...</b> Thu 08 J... 138 KB <b>This me...</b> You don't often get email from postmaster@g7energies.com. Learn why this is important <https://aka.ms/LearnAboutSenderIdentification>	
				post...	<b>Delivered: RE: Reminder of the Availability of ...</b> Thu 08 J... 138 KB <b>This me...</b> You don't often get email from postmaster@g7energies.com. Learn why this is important <https://aka.ms/LearnAboutSenderIdentification>	
				post...	<b>Delivered: RE: Reminder of the Availability of ...</b> Thu 08 J... 138 KB <b>This me...</b> You don't often get email from postmaster@g7energies.com. Learn why this is important <https://aka.ms/LearnAboutSenderIdentification>	
				post...	<b>Delivered: RE: Reminder of the Availability of ...</b> Thu 08 J... 138 KB <b>This me...</b> You don't often get email from postmaster@g7energies.com. Learn why this is important <https://aka.ms/LearnAboutSenderIdentification>	
				post...	<b>Delivered: RE: Reminder of the Availability of ...</b> Thu 08 J... 141 KB <b>This me...</b> You don't often get email from postmaster@r-n.co.za. Learn why this is important <https://aka.ms/LearnAboutSenderIdentification>	
				post...	<b>Delivered: RE: Reminder of the Availability of ...</b> Thu 08 J... 138 KB <b>This me...</b> Your message has been delivered to the following recipients:	
				post...	<b>Delivered: RE: Reminder of the Availability of ...</b> Thu 08 J... 145 KB <b>This me...</b> You don't often get email from postmaster@vodafone.com. Learn why this is important <https://aka.ms/LearnAboutSenderIdentification>	
				post...	<b>Delivered: RE: Reminder of the Availability of ...</b> Thu 08 J... 141 KB <b>This me...</b> You don't often get email from postmaster@g7energies.com. Learn why this is important <https://aka.ms/LearnAboutSenderIdentification>	
				post...	<b>Delivered: RE: Reminder of the Availability of ...</b> Thu 08 J... 145 KB <b>This me...</b> You don't often get email from postmaster@vodafone.com. Learn why this is important <https://aka.ms/LearnAboutSenderIdentification>	
				post...	<b>Delivered: RE: Reminder of the Availability of ...</b> Thu 08 J... 145 KB <b>This me...</b> You don't often get email from postmaster@vodafone.com. Learn why this is important <https://aka.ms/LearnAboutSenderIdentification>	
				post...	<b>Delivered: RE: Reminder of the Availability of ...</b> Thu 08 J... 145 KB <b>This me...</b> You don't often get email from postmaster@vodafone.com. Learn why this is important <https://aka.ms/LearnAboutSenderIdentification>	
				post...	<b>Delivered: RE: Reminder of the Availability of ...</b> Thu 08 J... 145 KB <b>This me...</b> You don't often get email from postmaster@vodafone.com. Learn why this is important <https://aka.ms/LearnAboutSenderIdentification>	
				post...	<b>Delivered: RE: Reminder of the Availability of ...</b> Thu 08 J... 145 KB <b>This me...</b> You don't often get email from postmaster@vodafone.com. Learn why this is important <https://aka.ms/LearnAboutSenderIdentification>	
				post...	<b>Delivered: RE: Reminder of the Availability of ...</b> Thu 08 J... 145 KB <b>This me...</b> You don't often get email from postmaster@vodafone.com. Learn why this is important <https://aka.ms/LearnAboutSenderIdentification>	
				post...	<b>Delivered: RE: Reminder of the Availability of ...</b> Thu 08 J... 139 KB <b>This me...</b> You don't often get email from postmaster@outlook.com. Learn why this is important <https://aka.ms/LearnAboutSenderIdentification>	
				post...	<b>Undeliverable: RE: Reminder of the Availabilit...</b> Thu 08 J... 410 KB <b>This me...</b> You don't often get email from postmaster@transnet.net. Learn why this is important <https://aka.ms/LearnAboutSenderIdentification>	
				Mail ...	<b>Delivered: Reminder of the Availability of Dra...</b> Thu 08 J... 85 KB <b>This me...</b> [You don't often get email from mailer-daemon@server.itdesign.co.za. Learn why this is important at https://aka.ms/LearnAboutSenderIdentification ] This	
				Mail ...	<b>Relayed: Reminder of the Availability of Draft...</b> Thu 08 J... 88 KB <b>This me...</b> [You don't often get email from mailer-daemon@pta-smg3.csir.co.za. Learn why this is important at https://aka.ms/LearnAboutSenderIdentification ] This is	
				post...	<b>Delivered: RE: Reminder of the Availability of ...</b> Thu 08 J... 142 KB <b>This me...</b> You don't often get email from postmaster@dws.gov.za. Learn why this is important <https://aka.ms/LearnAboutSenderIdentification>	
				post...	<b>Delivered: RE: Reminder of the Availability of ...</b> Thu 08 J... 140 KB <b>This me...</b> You don't often get email from postmaster@dws.gov.za. Learn why this is important <https://aka.ms/LearnAboutSenderIdentification>	

## APPENDICES

### ENVIRONMENTAL IMPACT ASSESSMENT REPORT: Scoping and Environmental Impact Assessment (EIA) Process for the Proposed Development of a Solar Photovoltaic (PV) Facility (Kudu Solar Facility 3) and associated infrastructure, near De Aar, Northern Cape Province

EMS - Delivery Receipts						By Date <span style="font-size: small;">v</span> <span style="font-size: small;">↑</span>
					From	Subject
					Received	Size
					Categories	Mention
					<b>Mail ... Relayed: Reminder of the Availability of Draft...</b> Thu 08 J... 123 KB <b>This me...</b>	
					[You don't often get email from mailer-daemon@pta-smg3.csir.co.za. Learn why this is important at https://aka.ms/LearnAboutSenderIdentification ] This is	
					<b>post... Delivered: RE: Reminder of the Availability of ...</b> Thu 08 J... 130 KB <b>This me...</b>	
					You don't often get email from postmaster@weathersa.co.za. Learn why this is important <https://aka.ms/LearnAboutSenderIdentification>	
					<b>Mail ... Undeliverable: Reminder of the Availability of...</b> Thu 08 J... 39 KB <b>This me...</b>	
					[You don't often get email from mailer-daemon@pta-smg3.csir.co.za. Learn why this is important at https://aka.ms/LearnAboutSenderIdentification ] This is	
					<b>post... Delivered: RE: Reminder of the Availability of ...</b> Thu 08 J... 130 KB <b>This me...</b>	
					You don't often get email from postmaster@weathersa.co.za. Learn why this is important <https://aka.ms/LearnAboutSenderIdentification>	
					<b>post... Delivered: RE: Reminder of the Availability of ...</b> Thu 08 J... 131 KB <b>This me...</b>	
					You don't often get email from postmaster@weathersa.co.za. Learn why this is important <https://aka.ms/LearnAboutSenderIdentification>	
					<b>Mail ... Relayed: Reminder of the Availability of Draft...</b> Thu 08 J... 110 KB <b>This me...</b>	
					[You don't often get email from mailer-daemon@pta-smg3.csir.co.za. Learn why this is important at https://aka.ms/LearnAboutSenderIdentification ] This is	
					<b>Mail ... Relayed: Reminder of the Availability of Draft...</b> Thu 08 J... 116 KB <b>This me...</b>	
					[You don't often get email from mailer-daemon@pta-smg3.csir.co.za. Learn why this is important at https://aka.ms/LearnAboutSenderIdentification ] This is	
					<b>Mail ... Undeliverable: Reminder of the Availability of...</b> Thu 08 J... 38 KB <b>This me...</b>	
					[You don't often get email from mailer-daemon@pta-smg3.csir.co.za. Learn why this is important at https://aka.ms/LearnAboutSenderIdentification ] This is	
					<b>Mail ... Delivered: Reminder of the Availability of Dra...</b> Thu 08 J... 88 KB <b>This me...</b>	
					[You don't often get email from mailer-daemon@pv33p00im-smtpin034.me.com. Learn why this is important at	
					<b>post... Delivered: RE: Reminder of the Availability of ...</b> Thu 08 J... 142 KB <b>This me...</b>	
					You don't often get email from postmaster@birdlife.org.za. Learn why this is important <https://aka.ms/LearnAboutSenderIdentification>	
					<b>post... Delivered: RE: Reminder of the Availability of ...</b> Thu 08 J... 142 KB <b>This me...</b>	
					You don't often get email from postmaster@birdlife.org.za. Learn why this is important <https://aka.ms/LearnAboutSenderIdentification>	
					<b>post... Delivered: RE: Reminder of the Availability of ...</b> Thu 08 J... 142 KB <b>This me...</b>	
					You don't often get email from postmaster@birdlife.org.za. Learn why this is important <https://aka.ms/LearnAboutSenderIdentification>	
					<b>post... Delivered: RE: Reminder of the Availability of ...</b> Thu 08 J... 135 KB <b>This me...</b>	
					You don't often get email from postmaster@nocci.co.za. Learn why this is important <https://aka.ms/LearnAboutSenderIdentification>	
					<b>MAIL... Failure Notice</b> Thu 08 J... 138 KB <b>This me...</b>	
					[You don't often get email from mailer-daemon@yahoo.com. Learn why this is important at https://aka.ms/LearnAboutSenderIdentification ]	
					<b>post... Delivered: RE: Reminder of the Availability of ...</b> Thu 08 J... 138 KB <b>This me...</b>	
					You don't often get email from postmaster@agrink.co.za. Learn why this is important <https://aka.ms/LearnAboutSenderIdentification>	
					<b>post... Delivered: RE: Reminder of the Availability of ...</b> Thu 08 J... 137 KB <b>This me...</b>	
					You don't often get email from postmaster@outlook.com. Learn why this is important <https://aka.ms/LearnAboutSenderIdentification>	
					<b>post... Delivered: RE: Reminder of the Availability of ...</b> Thu 08 J... 135 KB <b>This me...</b>	
					You don't often get email from postmaster@africoainvestments.co.za. Learn why this is important	
					<b>post... Delivered: RE: Reminder of the Availability of ...</b> Thu 08 J... 140 KB <b>This me...</b>	
					You don't often get email from postmaster@scatecsolar.onmicrosoft.com. Learn why this is important	
					<b>post... Delivered: RE: Reminder of the Availability of ...</b> Thu 08 J... 137 KB <b>This me...</b>	
					You don't often get email from postmaster@outlook.com. Learn why this is important <https://aka.ms/LearnAboutSenderIdentification>	
					<b>Mail ... Undeliverable: Reminder of the Availability of...</b> Thu 08 J... 42 KB <b>This me...</b>	
					[You don't often get email from mailer-daemon@mailcape.saao.ac.za. Learn why this is important at https://aka.ms/LearnAboutSenderIdentification ]	
					<b>Mail ... Delivered: Reminder of the Availability of Dra...</b> Thu 08 J... 79 KB <b>This me...</b>	
					[You don't often get email from mailer-daemon@spe11.ucebox.co.za. Learn why this is important at https://aka.ms/LearnAboutSenderIdentification ]	
					<b>post... Delivered: RE: Reminder of the Availability of ...</b> Thu 08 J... 136 KB <b>This me...</b>	
					You don't often get email from postmaster@agrink.co.za. Learn why this is important <https://aka.ms/LearnAboutSenderIdentification>	
					<b>post... Delivered: RE: Reminder of the Availability of ...</b> Thu 08 J... 139 KB <b>This me...</b>	
					You don't often get email from postmaster@netorg6186573.onmicrosoft.com. Learn why this is important	
					<b>post... Delivered: RE: Reminder of the Availability of ...</b> Thu 08 J... 136 KB <b>This me...</b>	
					You don't often get email from postmaster@mulilo.com. Learn why this is important <https://aka.ms/LearnAboutSenderIdentification>	
					<b>Mail ... Undeliverable: Reminder of the Availability of...</b> Thu 08 J... 45 KB <b>This me...</b>	
					[You don't often get email from mailer-daemon@pta-smg3.csir.co.za. Learn why this is important at https://aka.ms/LearnAboutSenderIdentification ] This is	
					<b>Mail ... Relayed: Reminder of the Availability of Draft...</b> Thu 08 J... 83 KB <b>This me...</b>	
					[You don't often get email from mailer-daemon@hostserv.co.za. Learn why this is important at https://aka.ms/LearnAboutSenderIdentification ]	

## APPENDICES

### ENVIRONMENTAL IMPACT ASSESSMENT REPORT: Scoping and Environmental Impact Assessment (EIA) Process for the Proposed Development of a Solar Photovoltaic (PV) Facility (Kudu Solar Facility 3) and associated infrastructure, near De Aar, Northern Cape Province

EMS - Delivery Receipts By Date v ↑

	From	Subject	Received	Size	Categories	Mention
	post...	<b>Delivered: RE: Reminder of the Availability of ...</b> Thu 08 J... 137 KB <b>This me...</b> You don't often get email from postmaster@netorg7356748.onmicrosoft.com. Learn why this is important				
	Mail ...	<b>Relayed: Reminder of the Availability of Draft...</b> Thu 08 J... 83 KB <b>This me...</b> [You don't often get email from mailer-daemon@hostserv.co.za. Learn why this is important at <a href="https://aka.ms/LearnAboutSenderIdentification">https://aka.ms/LearnAboutSenderIdentification</a> ]				
	post...	<b>Delivered: RE: Reminder of the Availability of ...</b> Thu 08 J... 137 KB <b>This me...</b> You don't often get email from postmaster@wessa.co.za. Learn why this is important < <a href="https://aka.ms/LearnAboutSenderIdentification">https://aka.ms/LearnAboutSenderIdentification</a> >				
	Mail ...	<b>Relayed: Reminder of the Availability of Draft...</b> Thu 08 J... 103 KB <b>This me...</b> [You don't often get email from mailer-daemon@pta-smg3.csir.co.za. Learn why this is important at <a href="https://aka.ms/LearnAboutSenderIdentification">https://aka.ms/LearnAboutSenderIdentification</a> ] This is				
	post...	<b>Delivered: RE: Reminder of the Availability of ...</b> Thu 08 J... 134 KB <b>This me...</b> You don't often get email from postmaster@africoainvestments.co.za. Learn why this is important				
	Mail ...	<b>Relayed: Reminder of the Availability of Draft...</b> Thu 08 J... 77 KB <b>This me...</b> [You don't often get email from mailer-daemon@luke.voffice.co.za. Learn why this is important at <a href="https://aka.ms/LearnAboutSenderIdentification">https://aka.ms/LearnAboutSenderIdentification</a> ]				
	Mail ...	<b>Relayed: Reminder of the Availability of Draft...</b> Thu 08 J... 112 KB <b>This me...</b> [You don't often get email from mailer-daemon@pta-smg3.csir.co.za. Learn why this is important at <a href="https://aka.ms/LearnAboutSenderIdentification">https://aka.ms/LearnAboutSenderIdentification</a> ] This is				
	Mail D...	<b>Relayed: Reminder of the Availability of Draft EIA ...</b> Thu 08 Ju... 73 KB <b>This mess...</b> [You don't often get email from mailer-daemon@pta-smg3.csir.co.za. Learn why this is important at <a href="https://aka.ms/LearnAboutSenderIdentification">https://aka.ms/LearnAboutSenderIdentification</a> ] This is				
	Micros...	<b>Delivered: RE: Reminder of the Availability of Draf...</b> Thu 08 Ju... 294 KB <b>This mess...</b> Your message has been delivered to the following recipients:				
	Micros...	<b>Delivered: RE: Reminder of the Availability of Draf...</b> Thu 08 Ju... 294 KB <b>This mess...</b> Your message has been delivered to the following recipients:				
	Micros...	<b>Delivered: RE: Reminder of the Availability of Draf...</b> Thu 08 Ju... 294 KB <b>This mess...</b> Your message has been delivered to the following recipients:				

## APPENDICES

ENVIRONMENTAL IMPACT ASSESSMENT REPORT: Scoping and Environmental Impact Assessment (EIA) Process for the Proposed Development of a Solar Photovoltaic (PV) Facility (Kudu Solar Facility 3) and associated infrastructure, near De Aar, Northern Cape Province

---

### 9. Follow-Up/ Reminder Email sent to all I&APs, Stakeholders, and Organs of State on 21 June 2023

---

**From:** EMS <ems@csir.co.za>  
**Sent:** Wednesday, 21 June 2023 17:22  
**To:** EMS  
**Subject:** RE: Reminder of the Availability of Draft EIA Reports for Comment - Kudu Solar PV

**Categories:** This message has been archived by Retain on June 29 2023 00:49  
**Bcc:**

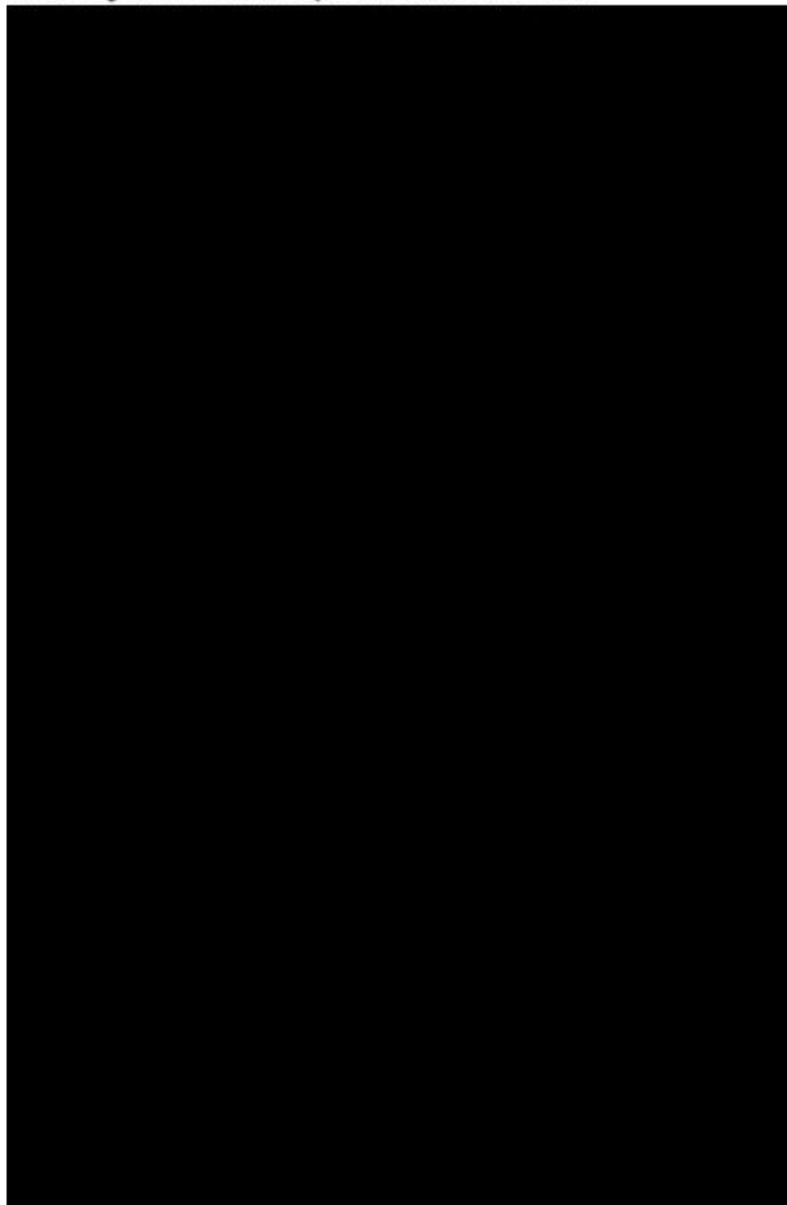

## APPENDICES

ENVIRONMENTAL IMPACT ASSESSMENT REPORT: Scoping and Environmental Impact Assessment (EIA) Process for the Proposed Development of a Solar Photovoltaic (PV) Facility (Kudu Solar Facility 3) and associated infrastructure, near De Aar, Northern Cape Province

---

**Bcc:**

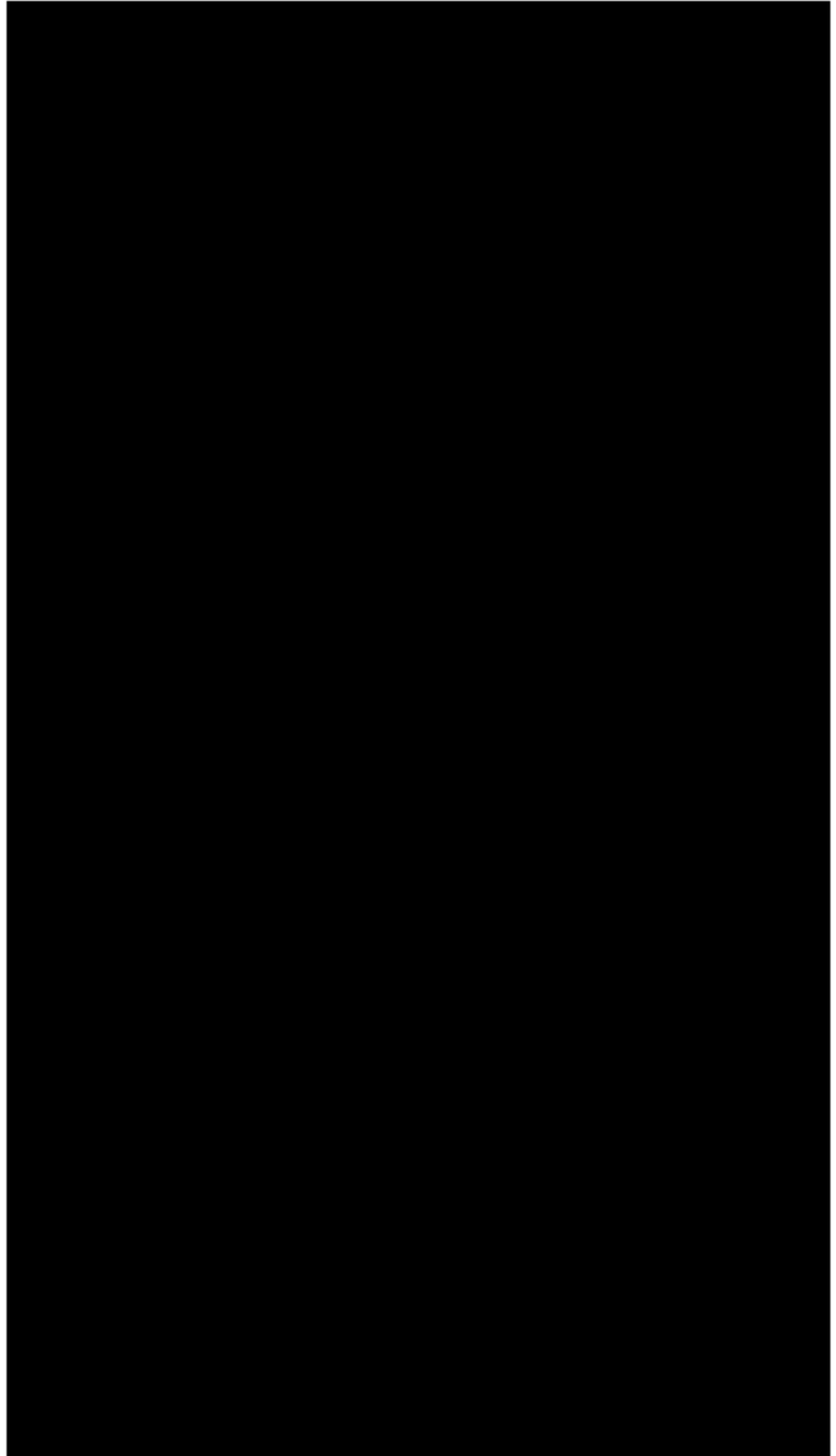



## APPENDICES

### ENVIRONMENTAL IMPACT ASSESSMENT REPORT: Scoping and Environmental Impact Assessment (EIA) Process for the Proposed Development of a Solar Photovoltaic (PV) Facility (Kudu Solar Facility 3) and associated infrastructure, near De Aar, Northern Cape Province

---

Dear Interested and Affected Party / Stakeholder,

**RE: REMINDER OF THE RELEASE OF THE DRAFT EIA REPORTS FOR A 30-DAY COMMENT PERIOD FOR THE PROPOSED DEVELOPMENT OF 12 SOLAR PHOTOVOLTAIC (PV) FACILITIES (I.E. KUDU SOLAR FACILITIES) AND VARIOUS ASSOCIATED INFRASTRUCTURE, NEAR DE AAR, NORTHERN CAPE**

National Department of Forestry, Fisheries, the Environment (DFFE) Reference Numbers:

Kudu Solar Facility 1: 14/12/16/3/3/2/2244	Kudu Solar Facility 5: 14/12/16/3/3/2/2248	Kudu Solar Facility 9: 14/12/16/3/3/2/2252
Kudu Solar Facility 2: 14/12/16/3/3/2/2245	Kudu Solar Facility 6: 14/12/16/3/3/2/2249	Kudu Solar Facility 10: 14/12/16/3/3/2/2253
Kudu Solar Facility 3: 14/12/16/3/3/2/2246	Kudu Solar Facility 7: 14/12/16/3/3/2/2250	Kudu Solar Facility 11: 14/12/16/3/3/2/2254
Kudu Solar Facility 4: 14/12/16/3/3/2/2247	Kudu Solar Facility 8: 14/12/16/3/3/2/2251	Kudu Solar Facility 12: 14/12/16/3/3/2/2255

Further to the email notifications below, this serves as an additional reminder that the 30-day public comment period on the Draft EIA Reports for the proposed 12 Solar Photovoltaic (PV) facilities (i.e. Kudu Solar Facilities) and various associated infrastructure, near De Aar, Northern Cape, closes on 3 July 2023.

As indicated below, the Draft EIA Reports can be accessed as follows:

- Google Drive: [https://bit.ly/KUDU\\_SOLAR\\_PV](https://bit.ly/KUDU_SOLAR_PV)
- Project website: <https://www.csir.co.za/environmental-impact-assessment>

You are kindly requested to register your interest and submit any comments you may have on the Draft EIA Reports to the CSIR by 3 July 2023 (details are provided below).

Thank you to those of you that have already provided comment.

Please do not hesitate to contact us should you have any queries relating to the above.

In accordance with the Protection of Personal Information Act (Act 4 of 2013), the CSIR will conduct itself responsibly when collecting, processing, storing and sharing any personal information collected for the purposes of Public Participation Processes (PPP) in terms of the 2014 NEMA EIA Regulations (as amended). By registering as an Interested and Affected Party (I&AP) and/or submitting information and comments, you consent to the collection, collation, processing, and storing of such information and the use and disclosure of such information for the aforementioned purpose (<https://www.csir.co.za/csir-privacy-notice>). If you would like to opt out of communications on this project, please do so by responding to this correspondence via email.

Kind Regards,  
Rohaida Abed

CSIR Environmental Management Services  
E-mail: [ems@csir.co.za](mailto:ems@csir.co.za)  
Postal Address: Postnet Suite 367, Private Bag x10, Musgrave Road, 4062  
Tel: 031 242 2300

---

## APPENDICES

### ENVIRONMENTAL IMPACT ASSESSMENT REPORT: Scoping and Environmental Impact Assessment (EIA) Process for the Proposed Development of a Solar Photovoltaic (PV) Facility (Kudu Solar Facility 3) and associated infrastructure, near De Aar, Northern Cape Province

#### 10. Proof of Delivery of Follow Up/ Reminder Email sent to all I&APs, Stakeholders, and Organs of State on 21 June 2023

EMS - Delivery Receipts						By Date <span style="font-size: small;">v</span> <span style="font-size: small;">↑</span>
From	Subject	Received	Size	Categories	Mention	
	ivisse... Return Receipt (read): RE: Reminder of the Av...	Wed 21 Jun 202...	42 KB	This m...		
<small>[You don't often get email from ivisser@pkscdm.gov.za. Learn why this is important at https://aka.ms/LearnAboutSenderIdentification ]</small>						
	Mail ... Relayed: Reminder of the Availability of Draft...	Wed 21 Jun 202...	68 KB	This m...		
<small>[You don't often get email from mailer-daemon@pta-smg4.csir.co.za. Learn why this is important at https://aka.ms/LearnAboutSenderIdentification ] This is</small>						
	post... Undeliverable: RE: Reminder of the Availabilit...	Wed 21 Jun 202...	196 KB	This m...		
<small>You don't often get email from postmaster@transnet.net. Learn why this is important &lt;https://aka.ms/LearnAboutSenderIdentification&gt;</small>						
	post... Undeliverable: RE: Reminder of the Availabilit...	Wed 21 Jun 202...	196 KB	This m...		
<small>You don't often get email from postmaster@transnet.net. Learn why this is important &lt;https://aka.ms/LearnAboutSenderIdentification&gt;</small>						
	Mail ... Delivered: Reminder of the Availability of Dra...	Wed 21 Jun 202...	84 KB	This m...		
<small>[You don't often get email from mailer-daemon@server.itdesign.co.za. Learn why this is important at https://aka.ms/LearnAboutSenderIdentification ] This</small>						
	Mail ... Relayed: Reminder of the Availability of Draft...	Wed 21 Jun 202...	85 KB	This m...		
<small>[You don't often get email from mailer-daemon@pta-smg4.csir.co.za. Learn why this is important at https://aka.ms/LearnAboutSenderIdentification ] This is</small>						
	Mail D... Relayed: Reminder of the Availability of Draft EIA ...	Wed 21 Jun 2023 ...	120 KB	This me...		
<small>[You don't often get email from mailer-daemon@pta-smg4.csir.co.za. Learn why this is important at https://aka.ms/LearnAboutSenderIdentification ] This is</small>						
	Mail ... Undeliverable: Reminder of the Availability of...	Wed 21 Jun 202...	39 KB	This m...		
<small>[You don't often get email from mailer-daemon@pta-smg4.csir.co.za. Learn why this is important at https://aka.ms/LearnAboutSenderIdentification ] This is</small>						
	Mail ... Undeliverable: Reminder of the Availability of...	Wed 21 Jun 202...	42 KB	This m...		
<small>[You don't often get email from mailer-daemon@mx1.dot.gov.za. Learn why this is important at https://aka.ms/LearnAboutSenderIdentification ]</small>						
	postm... Delivered: RE: Reminder of the Availability of Draf...	Wed 21 Jun 2023 ...	146 KB	This me...		
<small>You don't often get email from postmaster@vodafone.com. Learn why this is important &lt;https://aka.ms/LearnAboutSenderIdentification&gt;</small>						
	post... Delivered: RE: Reminder of the Availability of ...	Wed 21 Jun 202...	144 KB	This m...		
<small>You don't often get email from postmaster@vodafone.com. Learn why this is important &lt;https://aka.ms/LearnAboutSenderIdentification&gt;</small>						
	post... Delivered: RE: Reminder of the Availability of ...	Wed 21 Jun 202...	144 KB	This m...		
<small>You don't often get email from postmaster@vodafone.com. Learn why this is important &lt;https://aka.ms/LearnAboutSenderIdentification&gt;</small>						
	admi... Undeliverable: RE: Reminder of the Availabilit...	Wed 21 Jun 202...	90 KB	This m...		
<small>You don't often get email from admin-postmaster@dwa.gov.za. Learn why this is important &lt;https://aka.ms/LearnAboutSenderIdentification&gt;</small>						
	post... Delivered: RE: Reminder of the Availability of ...	Wed 21 Jun 202...	144 KB	This m...		
<small>You don't often get email from postmaster@vodafone.com. Learn why this is important &lt;https://aka.ms/LearnAboutSenderIdentification&gt;</small>						
	Mail ... Relayed: Reminder of the Availability of Draft...	Wed 21 Jun 202...	116 KB	This m...		
<small>[You don't often get email from mailer-daemon@pta-smg4.csir.co.za. Learn why this is important at https://aka.ms/LearnAboutSenderIdentification ] This is</small>						
	post... Delivered: RE: Reminder of the Availability of ...	Wed 21 Jun 202...	144 KB	This m...		
<small>You don't often get email from postmaster@vodafone.com. Learn why this is important &lt;https://aka.ms/LearnAboutSenderIdentification&gt;</small>						
	post... Delivered: RE: Reminder of the Availability of ...	Wed 21 Jun 202...	140 KB	This m...		
<small>You don't often get email from postmaster@g7energies.com. Learn why this is important &lt;https://aka.ms/LearnAboutSenderIdentification&gt;</small>						
	Mail ... Relayed: Reminder of the Availability of Draft...	Wed 21 Jun 202...	118 KB	This m...		
<small>[You don't often get email from mailer-daemon@pta-smg4.csir.co.za. Learn why this is important at https://aka.ms/LearnAboutSenderIdentification ] This is</small>						
	Mail ... Undeliverable: Reminder of the Availability of...	Wed 21 Jun 202...	38 KB	This m...		
<small>[You don't often get email from mailer-daemon@pta-smg4.csir.co.za. Learn why this is important at https://aka.ms/LearnAboutSenderIdentification ] This is</small>						
	post... Delivered: RE: Reminder of the Availability of ...	Wed 21 Jun 202...	144 KB	This m...		
<small>You don't often get email from postmaster@vodafone.com. Learn why this is important &lt;https://aka.ms/LearnAboutSenderIdentification&gt;</small>						
	post... Delivered: RE: Reminder of the Availability of ...	Wed 21 Jun 202...	140 KB	This m...		
<small>You don't often get email from postmaster@g7energies.com. Learn why this is important &lt;https://aka.ms/LearnAboutSenderIdentification&gt;</small>						
	Mail ... Delivered: Reminder of the Availability of Dra...	Wed 21 Jun 202...	84 KB	This m...		
<small>[You don't often get email from mailer-daemon@mr55p00im-qukt02070302.me.com. Learn why this is important at</small>						
	post... Delivered: RE: Reminder of the Availability of ...	Wed 21 Jun 202...	140 KB	This m...		
<small>You don't often get email from postmaster@g7energies.com. Learn why this is important &lt;https://aka.ms/LearnAboutSenderIdentification&gt;</small>						
	post... Delivered: RE: Reminder of the Availability of ...	Wed 21 Jun 202...	128 KB	This m...		
<small>You don't often get email from postmaster@weathersa.co.za. Learn why this is important &lt;https://aka.ms/LearnAboutSenderIdentification&gt;</small>						
	post... Delivered: RE: Reminder of the Availability of ...	Wed 21 Jun 202...	135 KB	This m...		
<small>You don't often get email from postmaster@netorg7356748.onmicrosoft.com. Learn why this is important</small>						
	post... Delivered: RE: Reminder of the Availability of ...	Wed 21 Jun 202...	140 KB	This m...		
<small>You don't often get email from postmaster@g7energies.com. Learn why this is important &lt;https://aka.ms/LearnAboutSenderIdentification&gt;</small>						

## APPENDICES

### ENVIRONMENTAL IMPACT ASSESSMENT REPORT: Scoping and Environmental Impact Assessment (EIA) Process for the Proposed Development of a Solar Photovoltaic (PV) Facility (Kudu Solar Facility 3) and associated infrastructure, near De Aar, Northern Cape Province

EMS - Delivery Receipts						By Date <span style="font-size: small;">v</span> <span style="font-size: small;">↑</span>
				From	Subject	Received
						Size
						Categories
						Mention
				post...	<b>Delivered: RE: Reminder of the Availability of ...</b> Wed 21 Jun 202... 144 KB This m...	
You don't often get email from postmaster@vodafone.com. Learn why this is important <https://aka.ms/LearnAboutSenderIdentification>						
				post...	<b>Undeliverable: RE: Reminder of the Availabilit...</b> Wed 21 Jun 202... 195 KB This m...	
You don't often get email from postmaster@transnet.net. Learn why this is important <https://aka.ms/LearnAboutSenderIdentification>						
				post...	<b>Delivered: RE: Reminder of the Availability of ...</b> Wed 21 Jun 202... 128 KB This m...	
You don't often get email from postmaster@weathersa.co.za. Learn why this is important <https://aka.ms/LearnAboutSenderIdentification>						
				post...	<b>Delivered: RE: Reminder of the Availability of ...</b> Wed 21 Jun 202... 142 KB This m...	
You don't often get email from postmaster@dws.gov.za. Learn why this is important <https://aka.ms/LearnAboutSenderIdentification>						
				post...	<b>Delivered: RE: Reminder of the Availability of ...</b> Wed 21 Jun 202... 140 KB This m...	
You don't often get email from postmaster@g7energies.com. Learn why this is important <https://aka.ms/LearnAboutSenderIdentification>						
				post...	<b>Delivered: RE: Reminder of the Availability of ...</b> Wed 21 Jun 202... 142 KB This m...	
You don't often get email from postmaster@dws.gov.za. Learn why this is important <https://aka.ms/LearnAboutSenderIdentification>						
				post...	<b>Delivered: RE: Reminder of the Availability of ...</b> Wed 21 Jun 202... 140 KB This m...	
You don't often get email from postmaster@dws.gov.za. Learn why this is important <https://aka.ms/LearnAboutSenderIdentification>						
				post...	<b>Delivered: RE: Reminder of the Availability of ...</b> Wed 21 Jun 202... 138 KB This m...	
You don't often get email from postmaster@g7energies.com. Learn why this is important <https://aka.ms/LearnAboutSenderIdentification>						
				post...	<b>Delivered: RE: Reminder of the Availability of ...</b> Wed 21 Jun 202... 128 KB This m...	
You don't often get email from postmaster@weathersa.co.za. Learn why this is important <https://aka.ms/LearnAboutSenderIdentification>						
				post...	<b>Delivered: RE: Reminder of the Availability of ...</b> Wed 21 Jun 202... 138 KB This m...	
You don't often get email from postmaster@g7energies.com. Learn why this is important <https://aka.ms/LearnAboutSenderIdentification>						
				post...	<b>Delivered: RE: Reminder of the Availability of ...</b> Wed 21 Jun 202... 138 KB This m...	
You don't often get email from postmaster@g7energies.com. Learn why this is important <https://aka.ms/LearnAboutSenderIdentification>						
				post...	<b>Delivered: RE: Reminder of the Availability of ...</b> Wed 21 Jun 202... 142 KB This m...	
You don't often get email from postmaster@dws.gov.za. Learn why this is important <https://aka.ms/LearnAboutSenderIdentification>						
				post...	<b>Delivered: RE: Reminder of the Availability of ...</b> Wed 21 Jun 202... 138 KB This m...	
You don't often get email from postmaster@g7energies.com. Learn why this is important <https://aka.ms/LearnAboutSenderIdentification>						
				post...	<b>Delivered: RE: Reminder of the Availability of ...</b> Wed 21 Jun 202... 140 KB This m...	
Your message has been delivered to the following recipients:						
				post...	<b>Delivered: RE: Reminder of the Availability of ...</b> Wed 21 Jun 202... 137 KB This m...	
You don't often get email from postmaster@agrink.co.za. Learn why this is important <https://aka.ms/LearnAboutSenderIdentification>						
				post...	<b>Delivered: RE: Reminder of the Availability of ...</b> Wed 21 Jun 202... 140 KB This m...	
You don't often get email from postmaster@g7energies.com. Learn why this is important <https://aka.ms/LearnAboutSenderIdentification>						
				post...	<b>Delivered: RE: Reminder of the Availability of ...</b> Wed 21 Jun 202... 137 KB This m...	
You don't often get email from postmaster@g7energies.com. Learn why this is important <https://aka.ms/LearnAboutSenderIdentification>						
				post...	<b>Delivered: RE: Reminder of the Availability of ...</b> Wed 21 Jun 202... 137 KB This m...	
You don't often get email from postmaster@outlook.com. Learn why this is important <https://aka.ms/LearnAboutSenderIdentification>						
				Mail ...	<b>Delivered: Reminder of the Availability of Dra...</b> Wed 21 Jun 202... 77 KB This m...	
[You don't often get email from mailer-daemon@spe5.ucebox.co.za. Learn why this is important at https://aka.ms/LearnAboutSenderIdentification ]						
				post...	<b>Delivered: RE: Reminder of the Availability of ...</b> Wed 21 Jun 202... 137 KB This m...	
You don't often get email from postmaster@birdlife.org.za. Learn why this is important <https://aka.ms/LearnAboutSenderIdentification>						
				post...	<b>Delivered: RE: Reminder of the Availability of ...</b> Wed 21 Jun 202... 137 KB This m...	
You don't often get email from postmaster@birdlife.org.za. Learn why this is important <https://aka.ms/LearnAboutSenderIdentification>						
				post...	<b>Delivered: RE: Reminder of the Availability of ...</b> Wed 21 Jun 202... 139 KB This m...	
You don't often get email from postmaster@corp.akuoenergy.com. Learn why this is important <https://aka.ms/LearnAboutSenderIdentification>						
				post...	<b>Delivered: RE: Reminder of the Availability of ...</b> Wed 21 Jun 202... 138 KB This m...	
Your message has been delivered to the following recipients:						
				post...	<b>Delivered: RE: Reminder of the Availability of ...</b> Wed 21 Jun 202... 134 KB This m...	
You don't often get email from postmaster@africoastinvestments.co.za. Learn why this is important						
				Mail ...	<b>Undeliverable: Reminder of the Availability of...</b> Wed 21 Jun 202... 41 KB This m...	
[You don't often get email from mailer-daemon@mailcape.sao.ac.za. Learn why this is important at https://aka.ms/LearnAboutSenderIdentification ]						
				post...	<b>Delivered: RE: Reminder of the Availability of ...</b> Wed 21 Jun 202... 142 KB This m...	
You don't often get email from postmaster@dws.gov.za. Learn why this is important <https://aka.ms/LearnAboutSenderIdentification>						

## APPENDICES

### ENVIRONMENTAL IMPACT ASSESSMENT REPORT: Scoping and Environmental Impact Assessment (EIA) Process for the Proposed Development of a Solar Photovoltaic (PV) Facility (Kudu Solar Facility 3) and associated infrastructure, near De Aar, Northern Cape Province

EMS - Delivery Receipts							By Date <span style="font-size: small;">v</span> <span style="font-size: small;">↑</span>
					From	Subject	Received
							Size
							Categories
							Mention
					post...	<b>Delivered: RE: Reminder of the Availability of ...</b> Wed 21 Jun 202... 138 KB This m...	
						You don't often get email from postmaster@r-n.co.za. Learn why this is important <https://aka.ms/LearnAboutSenderIdentification>	
					post...	<b>Delivered: RE: Reminder of the Availability of ...</b> Wed 21 Jun 202... 139 KB This m...	
						You don't often get email from postmaster@scatecsolar.onmicrosoft.com. Learn why this is important	
					post...	<b>Delivered: RE: Reminder of the Availability of ...</b> Wed 21 Jun 202... 138 KB This m...	
						Your message has been delivered to the following recipients:	
					post...	<b>Delivered: RE: Reminder of the Availability of ...</b> Wed 21 Jun 202... 135 KB This m...	
						You don't often get email from postmaster@outlook.com. Learn why this is important <https://aka.ms/LearnAboutSenderIdentification>	
					post...	<b>Delivered: RE: Reminder of the Availability of ...</b> Wed 21 Jun 202... 136 KB This m...	
						Your message has been delivered to the following recipients:	
					post...	<b>Delivered: RE: Reminder of the Availability of ...</b> Wed 21 Jun 202... 137 KB This m...	
						Your message has been delivered to the following recipients:	
					post...	<b>Delivered: RE: Reminder of the Availability of ...</b> Wed 21 Jun 202... 142 KB This m...	
						You don't often get email from postmaster@dws.gov.za. Learn why this is important <https://aka.ms/LearnAboutSenderIdentification>	
					post...	<b>Delivered: RE: Reminder of the Availability of ...</b> Wed 21 Jun 202... 137 KB This m...	
						You don't often get email from postmaster@agrink.co.za. Learn why this is important <https://aka.ms/LearnAboutSenderIdentification>	
					post...	<b>Delivered: RE: Reminder of the Availability of ...</b> Wed 21 Jun 202... 137 KB This m...	
						You don't often get email from postmaster@birdlife.org.za. Learn why this is important <https://aka.ms/LearnAboutSenderIdentification>	
					post...	<b>Delivered: RE: Reminder of the Availability of ...</b> Wed 21 Jun 202... 142 KB This m...	
						You don't often get email from postmaster@dws.gov.za. Learn why this is important <https://aka.ms/LearnAboutSenderIdentification>	
					post...	<b>Delivered: RE: Reminder of the Availability of ...</b> Wed 21 Jun 202... 140 KB This m...	
						You don't often get email from postmaster@dws.gov.za. Learn why this is important <https://aka.ms/LearnAboutSenderIdentification>	
					post...	<b>Delivered: RE: Reminder of the Availability of ...</b> Wed 21 Jun 202... 138 KB This m...	
						You don't often get email from postmaster@dws.gov.za. Learn why this is important <https://aka.ms/LearnAboutSenderIdentification>	
					post...	<b>Delivered: RE: Reminder of the Availability of ...</b> Wed 21 Jun 202... 137 KB This m...	
						Your message has been delivered to the following recipients:	
					post...	<b>Delivered: RE: Reminder of the Availability of ...</b> Wed 21 Jun 202... 142 KB This m...	
						You don't often get email from postmaster@dws.gov.za. Learn why this is important <https://aka.ms/LearnAboutSenderIdentification>	
					post...	<b>Delivered: RE: Reminder of the Availability of ...</b> Wed 21 Jun 202... 135 KB This m...	
						You don't often get email from postmaster@wessa.co.za. Learn why this is important <https://aka.ms/LearnAboutSenderIdentification>	
					post...	<b>Delivered: RE: Reminder of the Availability of ...</b> Wed 21 Jun 202... 138 KB This m...	
						You don't often get email from postmaster@netorg6186573.onmicrosoft.com. Learn why this is important	
					post...	<b>Delivered: RE: Reminder of the Availability of ...</b> Wed 21 Jun 202... 137 KB This m...	
						You don't often get email from postmaster@mulilo.com. Learn why this is important <https://aka.ms/LearnAboutSenderIdentification>	
					MAIL...	<b>Failure Notice</b> Wed 21 Jun 202... 121 KB This m...	
						[You don't often get email from mailer-daemon@yahoo.com. Learn why this is important at https://aka.ms/LearnAboutSenderIdentification ]	
					post...	<b>Delivered: RE: Reminder of the Availability of ...</b> Wed 21 Jun 202... 132 KB This m...	
						You don't often get email from postmaster@africoastinvestments.co.za. Learn why this is important	
					post...	<b>Delivered: RE: Reminder of the Availability of ...</b> Wed 21 Jun 202... 134 KB This m...	
						You don't often get email from postmaster@nocci.co.za. Learn why this is important <https://aka.ms/LearnAboutSenderIdentification>	
					Mail ...	<b>Relayed: Reminder of the Availability of Draft...</b> Wed 21 Jun 202... 113 KB This m...	
						[You don't often get email from mailer-daemon@pta-smg4.csir.co.za. Learn why this is important at https://aka.ms/LearnAboutSenderIdentification ] This is	
					Mail ...	<b>Undeliverable: Reminder of the Availability of...</b> Wed 21 Jun 202... 44 KB This m...	
						[You don't often get email from mailer-daemon@pta-smg4.csir.co.za. Learn why this is important at https://aka.ms/LearnAboutSenderIdentification ] This is	
					Mail ...	<b>Relayed: Reminder of the Availability of Draft...</b> Wed 21 Jun 202... 75 KB This m...	
						[You don't often get email from mailer-daemon@luke.voffice.co.za. Learn why this is important at https://aka.ms/LearnAboutSenderIdentification ]	
					Mail ...	<b>Relayed: Reminder of the Availability of Draft...</b> Wed 21 Jun 202... 79 KB This m...	
						[You don't often get email from mailer-daemon@hostserv.co.za. Learn why this is important at https://aka.ms/LearnAboutSenderIdentification ]	
					Mail ...	<b>Relayed: Reminder of the Availability of Draft...</b> Wed 21 Jun 202... 112 KB This m...	
						[You don't often get email from mailer-daemon@pta-smg4.csir.co.za. Learn why this is important at https://aka.ms/LearnAboutSenderIdentification ] This is	
					Mail ...	<b>Relayed: Reminder of the Availability of Draft...</b> Wed 21 Jun 202... 79 KB This m...	
						[You don't often get email from mailer-daemon@hostserv.co.za. Learn why this is important at https://aka.ms/LearnAboutSenderIdentification ]	

## APPENDICES

### ENVIRONMENTAL IMPACT ASSESSMENT REPORT: Scoping and Environmental Impact Assessment (EIA) Process for the Proposed Development of a Solar Photovoltaic (PV) Facility (Kudu Solar Facility 3) and associated infrastructure, near De Aar, Northern Cape Province

EMS - Delivery Receipts By Date v ↑

	From	Subject	Received	Size	Categories	Mention
		<b>Mail ... Relayed: Reminder of the Availability of Draft...</b> Wed 21 Jun 202... 68 KB <b>This m...</b> <small>[You don't often get email from mailer-daemon@pta-smg4.csir.co.za. Learn why this is important at <a href="https://aka.ms/LearnAboutSenderIdentification">https://aka.ms/LearnAboutSenderIdentification</a> ] This is</small>				
		<b>Micro... Delivered: RE: Reminder of the Availability of ...</b> Wed 21 Jun 202... 98 KB <b>This m...</b> <small>Your message has been delivered to the following recipients:</small>				
		<b>Micro... Delivered: RE: Reminder of the Availability of ...</b> Wed 21 Jun 202... 98 KB <b>This m...</b> <small>Your message has been delivered to the following recipients:</small>				
		<b>Micro... Delivered: RE: Reminder of the Availability of ...</b> Wed 21 Jun 202... 98 KB <b>This m...</b> <small>Your message has been delivered to the following recipients:</small>				
		<b>Mail ... Relayed: Reminder of the Availability of Draft...</b> Wed 21 Jun 202... 65 KB <b>This m...</b> <small>[You don't often get email from mailer-daemon@pta-smg4.csir.co.za. Learn why this is important at <a href="https://aka.ms/LearnAboutSenderIdentification">https://aka.ms/LearnAboutSenderIdentification</a> ] This is</small>				
		<b>Micro... Delivered: RE: Reminder of the Availability of ...</b> Wed 21 Jun 202... 166 KB <b>This m...</b> <small>Your message has been delivered to the following recipients:</small>				
	Mmbo...	<b>Not read: Reminder of the Availability of Draft El...</b> Wed 21 Jun 2023 ... 50 KB <b>This me...</b> <small>You don't often get email from mmboneni.mutheiwana@dmre.gov.za. Learn why this is important</small>				
		<b>post... Delivered: [EXTERNAL]RE: Reminder - Availab...</b> Wed 21 Jun 202... 137 KB <b>This m...</b> <small>You don't often get email from postmaster@daerl.co.za. Learn why this is important &lt;<a href="https://aka.ms/LearnAboutSenderIdentification">https://aka.ms/LearnAboutSenderIdentification</a>&gt;</small>				
		<b>Mail ... Relayed: Reminder - Availability of Draft EIA ...</b> Wed 21 Jun 202... 72 KB <b>This m...</b> <small>This is the mail system at host pta-smg1.csir.co.za. Your message was successfully delivered to the destination(s) listed below. If the message was</small>				
		<b>Mail ... Relayed: Reminder - Availability of Draft EIA ...</b> Wed 21 Jun 202... 69 KB <b>This m...</b> <small>[You don't often get email from mailer-daemon@pta-smg4.csir.co.za. Learn why this is important at <a href="https://aka.ms/LearnAboutSenderIdentification">https://aka.ms/LearnAboutSenderIdentification</a> ] This is</small>				
		<b>Micro... Delivered: RE: Reminder - Availability of Draft...</b> Wed 21 Jun 202... 115 KB <b>This m...</b> <small>Your message has been delivered to the following recipients:</small>				
	admi...	<b>Undeliverable: RE: Reminder - Availability of ...</b> Wed 21 Jun 202... 91 KB <b>This m...</b> <small>You don't often get email from admin-postmaster@dwa.gov.za. Learn why this is important &lt;<a href="https://aka.ms/LearnAboutSenderIdentification">https://aka.ms/LearnAboutSenderIdentification</a>&gt;</small>				
		<b>Mail ... Undeliverable: Reminder - Availability of Draf...</b> Wed 21 Jun 202... 31 KB <b>This m...</b> <small>[You don't often get email from mailer-daemon@pta-smg3.csir.co.za. Learn why this is important at <a href="https://aka.ms/LearnAboutSenderIdentification">https://aka.ms/LearnAboutSenderIdentification</a> ] This is</small>				
		<b>Mail ... Undeliverable: Reminder - Availability of Draf...</b> Wed 21 Jun 202... 36 KB <b>This m...</b> <small>[You don't often get email from mailer-daemon@pta-smg3.csir.co.za. Learn why this is important at <a href="https://aka.ms/LearnAboutSenderIdentification">https://aka.ms/LearnAboutSenderIdentification</a> ] This is</small>				

## APPENDICES

ENVIRONMENTAL IMPACT ASSESSMENT REPORT: Scoping and Environmental Impact Assessment (EIA) Process for the Proposed Development of a Solar Photovoltaic (PV) Facility (Kudu Solar Facility 3) and associated infrastructure, near De Aar, Northern Cape Province

---

### 11. Proof of SMS Reminder Text Message sent to all I&APs, Stakeholders, and Organs of State (where cell phone numbers were available) on 21 June 2023

**Copy of text included in the SMS:** Dear Stakeholder, Reminder that the comment period on the Draft EIA Reports for the proposed Kudu Solar Facilities 1-12 near De Aar, NC, closes 3 July 20<sub>23</sub>. Visit [https://bit.ly/KUDU\\_SOLAR\\_PV](https://bit.ly/KUDU_SOLAR_PV) or [https://bit.ly/CSIR\\_EIA](https://bit.ly/CSIR_EIA) to access the reports. To send comments, queries or to opt out of future communication on these projects, email [ems@csir.co.za](mailto:ems@csir.co.za). Regards, CSIR EMS Team ([https://bit.ly/CSIR\\_privacy](https://bit.ly/CSIR_privacy))

created_time	msisdn	status_text	origin_address	delivered_time	batch_id
2023-06-21 14:23:11.0		Delivered to phone		2023-06-21 14:23:00.0	1796604934
2023-06-21 14:23:11.0		Delivered to phone		2023-06-21 14:23:00.0	1796604934
2023-06-21 14:23:11.0		Delivered to phone		2023-06-21 14:23:00.0	1796604934
2023-06-21 14:23:11.0		Delivered to phone		2023-06-21 14:23:00.0	1796604934
2023-06-21 14:23:11.0		Delivered to phone		2023-06-21 14:23:00.0	1796604934
2023-06-21 14:23:11.0		Delivered to phone		2023-06-21 14:23:00.0	1796604934
2023-06-21 14:23:11.0		Delivered to phone		2023-06-21 14:34:00.0	1796604934
2023-06-21 14:23:11.0		Delivered to phone		2023-06-21 14:34:00.0	1796604934
2023-06-21 14:23:11.0		Delivered to phone		2023-06-21 14:34:00.0	1796604934
2023-06-21 14:23:11.0		Delivered to phone		2023-06-21 14:23:00.0	1796604934
2023-06-21 14:23:11.0		Delivered to phone		2023-06-21 14:23:00.0	1796604934
2023-06-21 14:23:11.0		Delivered to phone		2023-06-21 14:23:00.0	1796604934
2023-06-21 14:23:11.0		Delivered to phone		2023-06-21 14:23:00.0	1796604934
2023-06-21 14:23:11.0		Delivered to phone		2023-06-21 14:23:00.0	1796604934
2023-06-21 14:23:11.0		Delivered to phone		2023-06-21 14:23:00.0	1796604934
2023-06-21 14:23:11.0		Delivered to phone		2023-06-21 14:23:00.0	1796604934
2023-06-21 14:23:11.0		Delivered to phone		2023-06-21 14:23:00.0	1796604934
2023-06-21 14:23:11.0		Delivered to phone		2023-06-21 14:23:00.0	1796604934
2023-06-21 14:23:11.0		Delivered to phone		2023-06-21 14:23:00.0	1796604934
2023-06-21 14:23:11.0		Delivered to phone		2023-06-21 14:23:00.0	1796604934
2023-06-21 14:23:11.0		Delivered to phone		2023-06-21 14:23:00.0	1796604934

**APPENDICES**

ENVIRONMENTAL IMPACT ASSESSMENT REPORT: Scoping and Environmental Impact Assessment (EIA) Process for the Proposed Development of a Solar Photovoltaic (PV) Facility (Kudu Solar Facility 3) and associated infrastructure, near De Aar, Northern Cape Province

---

<b>created_time</b>	<b>msisdn</b>	<b>status_text</b>	<b>origin_address</b>	<b>delivered_time</b>	<b>batch_id</b>
2023-06-21 14:23:11.0		Delivered to phone		2023-06-21 14:23:00.0	1796604934
2023-06-21 14:23:11.0		Delivered to phone		2023-06-21 14:23:00.0	1796604934
2023-06-21 14:23:11.0		Delivered to phone		2023-06-21 14:23:00.0	1796604934
2023-06-21 14:23:11.0		Delivered to phone		2023-06-21 14:23:00.0	1796604934
2023-06-21 14:23:11.0		Delivered to phone		2023-06-21 14:23:00.0	1796604934
2023-06-21 14:23:11.0		Delivered to phone		2023-06-21 14:24:00.0	1796604934
2023-06-21 14:23:11.0		Delivered to phone		2023-06-21 14:23:00.0	1796604934
2023-06-21 14:23:11.0		Delivered to phone		2023-06-21 14:23:00.0	1796604934
2023-06-21 14:23:11.0		Delivered to phone		2023-06-21 14:24:00.0	1796604934
2023-06-21 14:23:11.0		Delivered to phone		2023-06-21 14:23:00.0	1796604934
2023-06-21 14:23:11.0		Delivered to phone		2023-06-21 14:23:00.0	1796604934
2023-06-21 14:23:11.0		Delivered to phone		2023-06-21 14:23:00.0	1796604934
2023-06-21 14:23:11.0		Delivered to phone		2023-06-21 14:24:00.0	1796604934
2023-06-21 14:23:11.0		Delivered to phone		2023-06-21 14:23:00.0	1796604934
2023-06-21 14:23:11.0		Delivered to phone		2023-06-21 14:23:00.0	1796604934
2023-06-21 14:23:11.0		Delivered to phone		2023-06-21 14:23:00.0	1796604934
2023-06-21 14:23:11.0		Delivered to phone		2023-06-21 14:23:00.0	1796604934
2023-06-21 14:23:11.0		Delivered to phone		2023-06-21 14:23:00.0	1796604934
2023-06-21 14:23:11.0		Delivered to phone		2023-06-21 14:23:00.0	1796604934
2023-06-21 14:23:11.0		Failed		2023-06-22 10:23:00.0	1796604934
2023-06-21 14:23:11.0		Failed		2023-06-22 20:23:00.0	1796604934
2023-06-21 14:23:11.0		Failed: message expired		2023-06-23 14:23:00.0	1796604934
2023-06-21 14:23:11.0		Delivered to phone		2023-06-21 14:23:00.0	1796604934
2023-06-21 14:23:11.0		Delivered to phone		2023-06-21 14:23:00.0	1796604934
2023-06-21 14:23:11.0		Delivered to phone		2023-06-21 14:23:00.0	1796604934
2023-06-21 14:23:11.0		Delivered to phone		2023-06-21 14:23:00.0	1796604934
2023-06-21 14:23:11.0		Delivered to phone		2023-06-21 14:23:00.0	1796604934
2023-06-21 14:23:11.0		Delivered to phone		2023-06-21 14:23:00.0	1796604934
2023-06-21 14:23:11.0		Delivered to phone		2023-06-21 14:23:00.0	1796604934
2023-06-21 14:23:11.0		Delivered to phone		2023-06-21 14:23:00.0	1796604934

**APPENDICES**

ENVIRONMENTAL IMPACT ASSESSMENT REPORT: Scoping and Environmental Impact Assessment (EIA) Process for the Proposed Development of a Solar Photovoltaic (PV) Facility (Kudu Solar Facility 3) and associated infrastructure, near De Aar, Northern Cape Province

---

<b>created_time</b>	<b>msisdn</b>	<b>status_text</b>	<b>origin_address</b>	<b>delivered_time</b>	<b>batch_id</b>
2023-06-21 14:23:11.0		Delivered to phone		2023-06-21 14:23:00.0	1796604934
2023-06-21 14:23:11.0		Delivered to phone		2023-06-21 14:23:00.0	1796604934
2023-06-21 14:23:11.0		Delivered to phone		2023-06-21 14:23:00.0	1796604934
2023-06-21 14:23:11.0		Delivered to phone		2023-06-21 14:23:00.0	1796604934
2023-06-21 14:23:11.0		Delivered to phone		2023-06-21 14:23:00.0	1796604934
2023-06-21 14:23:11.0		Delivered to phone		2023-06-21 14:23:00.0	1796604934
2023-06-21 14:23:11.0		Delivered to phone		2023-06-21 14:23:00.0	1796604934
2023-06-21 14:23:11.0		Delivered to phone		2023-06-21 14:23:00.0	1796604934
2023-06-21 14:23:11.0		Delivered to phone		2023-06-21 14:23:00.0	1796604934
2023-06-21 14:23:11.0		Delivered to phone		2023-06-21 14:23:00.0	1796604934
2023-06-21 14:23:11.0		Delivered to phone		2023-06-21 14:23:00.0	1796604934
2023-06-21 14:23:11.0		Delivered to phone		2023-06-21 14:23:00.0	1796604934
2023-06-21 14:23:11.0		Delivered to phone		2023-06-21 14:23:00.0	1796604934
2023-06-21 14:23:11.0		Delivered to phone		2023-06-21 14:23:00.0	1796604934
2023-06-21 14:23:11.0		Delivered to phone		2023-06-21 14:23:00.0	1796604934
2023-06-21 14:23:11.0		Delivered to phone		2023-06-21 14:23:00.0	1796604934
2023-06-21 14:23:11.0		Delivered to phone		2023-06-21 14:23:00.0	1796604934
2023-06-21 14:23:11.0		Delivered to phone		2023-06-21 14:23:00.0	1796604934
2023-06-21 14:23:11.0		Delivered to phone		2023-06-21 14:23:00.0	1796604934
2023-06-21 14:23:11.0		Delivered to phone		2023-06-21 14:23:00.0	1796604934
2023-06-21 14:23:11.0		Delivered to phone		2023-06-21 14:23:00.0	1796604934
2023-06-21 14:23:11.0		Delivered to phone		2023-06-21 14:23:00.0	1796604934
2023-06-21 14:23:11.0		Failed		2023-06-21 14:23:00.0	1796604934
2023-06-21 14:23:11.0		Failed		2023-06-21 14:23:00.0	1796604934
2023-06-21 14:23:11.0		Failed		2023-06-21 14:23:00.0	1796604934
2023-06-21 14:23:11.0		Delivered to phone		2023-06-21 14:23:00.0	1796604934
2023-06-21 14:23:11.0		Delivered to phone		2023-06-21 14:23:00.0	1796604934
2023-06-21 14:23:11.0		Delivered to phone		2023-06-21 14:23:00.0	1796604934
2023-06-21 14:23:11.0		Delivered to phone		2023-06-21 14:24:00.0	1796604934
2023-06-21 14:23:11.0		Delivered to phone		2023-06-21 14:23:00.0	1796604934
2023-06-21 14:23:11.0		Delivered to phone		2023-06-21 14:23:00.0	1796604934
2023-06-21 14:23:11.0		Delivered to phone		2023-06-21 14:23:00.0	1796604934



**APPENDICES**

ENVIRONMENTAL IMPACT ASSESSMENT REPORT: Scoping and Environmental Impact Assessment (EIA) Process for the Proposed Development of a Solar Photovoltaic (PV) Facility (Kudu Solar Facility 3) and associated infrastructure, near De Aar, Northern Cape Province

---

created_time	msisdn	status_text	origin_address	delivered_time	batch_id
2023-06-21 14:23:11.0		Delivered to phone		2023-06-21 14:23:00.0	1796604934
2023-06-21 14:23:11.0		Delivered to phone		2023-06-21 14:23:00.0	1796604934
2023-06-21 14:23:11.0		Delivered to phone		2023-06-21 14:23:00.0	1796604934
2023-06-21 14:23:11.0		Delivered to phone		2023-06-21 14:23:00.0	1796604934
2023-06-21 14:23:11.0		Delivered to phone		2023-06-21 14:23:00.0	1796604934
2023-06-21 14:23:11.0		Delivered to phone		2023-06-21 14:23:00.0	1796604934
2023-06-21 14:23:11.0		Delivered to phone		2023-06-21 14:36:00.0	1796604934
2023-06-21 14:23:11.0		Delivered to phone		2023-06-21 14:32:00.0	1796604934
2023-06-21 14:23:11.0		Delivered to phone		2023-06-21 14:36:00.0	1796604934
2023-06-21 14:23:11.0		Delivered to phone		2023-06-21 14:23:00.0	1796604934
2023-06-21 14:23:11.0		Delivered to phone		2023-06-21 14:23:00.0	1796604934
2023-06-21 14:23:11.0		Delivered to phone		2023-06-21 14:23:00.0	1796604934
2023-06-21 14:23:11.0		Delivered to phone		2023-06-21 14:23:00.0	1796604934
2023-06-21 14:23:11.0		Delivered to phone		2023-06-21 15:23:00.0	1796604934
2023-06-21 14:23:11.0		Delivered to phone		2023-06-21 15:23:00.0	1796604934
2023-06-21 14:23:11.0		Delivered to phone		2023-06-21 14:23:00.0	1796604934
2023-06-21 14:23:11.0		Delivered to phone		2023-06-21 14:23:00.0	1796604934
2023-06-21 14:23:11.0		Delivered to phone		2023-06-21 14:23:00.0	1796604934
2023-06-21 14:23:11.0		Delivered to phone		2023-06-21 14:24:00.0	1796604934
2023-06-21 14:23:11.0		Delivered to phone		2023-06-21 14:23:00.0	1796604934
2023-06-21 14:23:11.0		Delivered to phone		2023-06-21 14:23:00.0	1796604934
2023-06-21 14:23:11.0		Delivered to phone		2023-06-21 14:24:00.0	1796604934
2023-06-21 14:23:11.0		Delivered to phone		2023-06-21 14:23:00.0	1796604934
2023-06-21 14:23:11.0		Delivered to phone		2023-06-21 14:23:00.0	1796604934
2023-06-21 14:23:11.0		Delivered to phone		2023-06-21 14:23:00.0	1796604934
2023-06-21 14:23:11.0		Delivered to phone		2023-06-21 14:23:00.0	1796604934
2023-06-21 14:23:11.0		Delivered to phone		2023-06-21 14:23:00.0	1796604934
2023-06-21 14:23:11.0		Delivered to phone		2023-06-21 14:23:00.0	1796604934
2023-06-21 14:23:11.0		Delivered to phone		2023-06-21 14:23:00.0	1796604934
2023-06-21 14:23:11.0		Delivered to phone		2023-06-21 14:23:00.0	1796604934
2023-06-21 14:23:11.0		Delivered to phone		2023-06-21 14:23:00.0	1796604934
2023-06-21 14:23:11.0		Delivered to phone		2023-06-21 14:23:00.0	1796604934
2023-06-21 14:23:11.0		Delivered to phone		2023-06-21 14:23:00.0	1796604934

**APPENDICES**

ENVIRONMENTAL IMPACT ASSESSMENT REPORT: Scoping and Environmental Impact Assessment (EIA) Process for the Proposed Development of a Solar Photovoltaic (PV) Facility (Kudu Solar Facility 3) and associated infrastructure, near De Aar, Northern Cape Province

---

<b>created_time</b>	<b>msisdn</b>	<b>status_text</b>	<b>origin_address</b>	<b>delivered_time</b>	<b>batch_id</b>
2023-06-21 14:23:11.0		Delivered to phone		2023-06-21 14:24:00.0	1796604934
2023-06-21 14:23:11.0		Delivered to phone		2023-06-21 14:23:00.0	1796604934
2023-06-21 14:23:11.0		Delivered to phone		2023-06-21 14:23:00.0	1796604934
2023-06-21 14:23:11.0		Delivered to phone		2023-06-21 14:23:00.0	1796604934
2023-06-21 14:23:11.0		Failed		2023-06-23 05:23:00.0	1796604934
2023-06-21 14:23:11.0		Failed		2023-06-23 05:23:00.0	1796604934
2023-06-21 14:23:11.0		Failed		2023-06-23 05:23:00.0	1796604934
2023-06-21 14:23:11.0		Delivered to phone		2023-06-21 14:23:00.0	1796604934
2023-06-21 14:23:11.0		Delivered to phone		2023-06-21 14:23:00.0	1796604934
2023-06-21 14:23:11.0		Delivered to phone		2023-06-21 14:23:00.0	1796604934
2023-06-21 14:23:11.0		Failed		2023-06-22 19:04:00.0	1796604934
2023-06-21 14:23:11.0		Failed		2023-06-23 08:21:00.0	1796604934
2023-06-21 14:23:11.0		Failed		2023-06-22 17:55:00.0	1796604934
2023-06-21 14:23:11.0		Failed: delivery to network failed			1796604934
2023-06-21 14:23:11.0		Failed: delivery to network failed			1796604934
2023-06-21 14:23:11.0		Failed: delivery to network failed			1796604934
2023-06-21 14:23:11.0		Delivered to phone		2023-06-21 14:23:00.0	1796604934
2023-06-21 14:23:11.0		Delivered to phone		2023-06-21 14:23:00.0	1796604934
2023-06-21 14:23:11.0		Delivered to phone		2023-06-21 14:23:00.0	1796604934
2023-06-21 14:23:11.0		Delivered to phone		2023-06-21 14:23:00.0	1796604934
2023-06-21 14:23:11.0		Delivered to phone		2023-06-21 14:23:00.0	1796604934
2023-06-21 14:23:11.0		Delivered to phone		2023-06-21 14:23:00.0	1796604934
2023-06-21 14:23:11.0		Delivered to phone		2023-06-21 14:23:00.0	1796604934
2023-06-21 14:23:11.0		Delivered to phone		2023-06-21 14:23:00.0	1796604934
2023-06-21 14:23:11.0		Delivered to phone		2023-06-21 14:23:00.0	1796604934
2023-06-21 14:23:11.0		Failed: delivery to network failed			1796604934

**APPENDICES**

ENVIRONMENTAL IMPACT ASSESSMENT REPORT: Scoping and Environmental Impact Assessment (EIA) Process for the Proposed Development of a Solar Photovoltaic (PV) Facility (Kudu Solar Facility 3) and associated infrastructure, near De Aar, Northern Cape Province

---

<b>created_time</b>	<b>msisdn</b>	<b>status_text</b>	<b>origin_address</b>	<b>delivered_time</b>	<b>batch_id</b>
2023-06-21 14:23:11.0		Failed: delivery to network failed			1796604934
2023-06-21 14:23:11.0		Failed: delivery to network failed			1796604934
2023-06-21 14:23:11.0		Delivered to phone		2023-06-21 14:23:00.0	1796604934
2023-06-21 14:23:11.0		Delivered to phone		2023-06-21 14:23:00.0	1796604934
2023-06-21 14:23:11.0		Delivered to phone		2023-06-21 14:23:00.0	1796604934
2023-06-21 14:23:11.0		Delivered to phone		2023-06-21 14:23:00.0	1796604934
2023-06-21 14:23:11.0		Delivered to phone		2023-06-21 14:23:00.0	1796604934
2023-06-21 14:23:11.0		Delivered to phone		2023-06-21 14:23:00.0	1796604934
2023-06-21 14:23:11.0		Delivered to phone		2023-06-21 14:23:00.0	1796604934
2023-06-21 14:23:11.0		Delivered to phone		2023-06-21 14:23:00.0	1796604934
2023-06-21 14:23:11.0		Delivered to phone		2023-06-21 14:23:00.0	1796604934
2023-06-21 14:23:11.0		Delivered to phone		2023-06-21 14:23:00.0	1796604934
2023-06-21 14:23:11.0		Delivered to phone		2023-06-21 14:23:00.0	1796604934
2023-06-21 14:23:11.0		Delivered to phone		2023-06-21 14:23:00.0	1796604934
2023-06-21 14:23:11.0		Delivered to phone		2023-06-21 14:23:00.0	1796604934
2023-06-21 14:23:11.0		Delivered to phone		2023-06-21 15:04:00.0	1796604934
2023-06-21 14:23:11.0		Delivered to phone		2023-06-21 15:00:00.0	1796604934
2023-06-21 14:23:11.0		Delivered to phone		2023-06-21 15:06:00.0	1796604934
2023-06-21 14:23:11.0		Failed		2023-06-21 14:33:00.0	1796604934
2023-06-21 14:23:11.0		Failed		2023-06-21 14:33:00.0	1796604934
2023-06-21 14:23:11.0		Failed		2023-06-21 15:19:00.0	1796604934
2023-06-21 14:23:11.0		Delivered to phone		2023-06-21 15:23:00.0	1796604934
2023-06-21 14:23:11.0		Delivered to phone		2023-06-21 14:23:00.0	1796604934
2023-06-21 14:23:11.0		Delivered to phone		2023-06-21 15:23:00.0	1796604934
2023-06-21 14:23:11.0		Delivered to phone		2023-06-21 14:23:00.0	1796604934
2023-06-21 14:23:11.0		Delivered to phone		2023-06-21 14:23:00.0	1796604934

**APPENDICES**

ENVIRONMENTAL IMPACT ASSESSMENT REPORT: Scoping and Environmental Impact Assessment (EIA) Process for the Proposed Development of a Solar Photovoltaic (PV) Facility (Kudu Solar Facility 3) and associated infrastructure, near De Aar, Northern Cape Province

---

<b>created_time</b>	<b>msisdn</b>	<b>status_text</b>	<b>origin_address</b>	<b>delivered_time</b>	<b>batch_id</b>
2023-06-21 14:23:11.0		Delivered to phone		2023-06-21 14:23:00.0	1796604934
2023-06-21 14:23:11.0		Delivered to phone		2023-06-21 14:23:00.0	1796604934
2023-06-21 14:23:11.0		Delivered to phone		2023-06-21 14:24:00.0	1796604934
2023-06-21 14:23:11.0		Delivered to phone		2023-06-21 14:23:00.0	1796604934
2023-06-21 14:23:11.0		Delivered to phone		2023-06-21 14:32:00.0	1796604934
2023-06-21 14:23:11.0		Delivered to phone		2023-06-21 14:30:00.0	1796604934
2023-06-21 14:23:11.0		Delivered to phone		2023-06-21 14:34:00.0	1796604934
2023-06-21 14:23:11.0		Delivered to phone		2023-06-21 14:23:00.0	1796604934
2023-06-21 14:23:11.0		Delivered to phone		2023-06-21 14:23:00.0	1796604934
2023-06-21 14:23:11.0		Delivered to phone		2023-06-21 14:24:00.0	1796604934
2023-06-21 14:23:11.0		Delivered to phone		2023-06-21 14:23:00.0	1796604934
2023-06-21 14:23:11.0		Delivered to phone		2023-06-21 14:23:00.0	1796604934
2023-06-21 14:23:11.0		Delivered to phone		2023-06-21 14:23:00.0	1796604934
2023-06-21 14:23:11.0		Delivered to phone		2023-06-21 14:23:00.0	1796604934
2023-06-21 14:23:11.0		Failed		2023-06-21 14:33:00.0	1796604934
2023-06-21 14:23:11.0		Failed		2023-06-21 14:33:00.0	1796604934
2023-06-21 14:23:11.0		Failed		2023-06-21 14:33:00.0	1796604934
2023-06-21 14:23:11.0		Delivered to phone		2023-06-21 20:35:00.0	1796604934
2023-06-21 14:23:11.0		Delivered to phone		2023-06-21 20:35:00.0	1796604934
2023-06-21 14:23:11.0		Delivered to phone		2023-06-21 20:35:00.0	1796604934
2023-06-21 14:23:11.0		Delivered to phone		2023-06-21 14:23:00.0	1796604934
2023-06-21 14:23:11.0		Delivered to phone		2023-06-21 14:23:00.0	1796604934
2023-06-21 14:23:11.0		Delivered to phone		2023-06-21 14:23:00.0	1796604934
2023-06-21 14:23:11.0		Delivered to phone		2023-06-21 14:23:00.0	1796604934
2023-06-21 14:23:11.0		Delivered to phone		2023-06-21 14:23:00.0	1796604934
2023-06-21 14:23:11.0		Delivered to phone		2023-06-21 14:23:00.0	1796604934
2023-06-21 14:23:11.0		Delivered to phone		2023-06-21 14:23:00.0	1796604934
2023-06-21 14:23:11.0		Failed		2023-06-21 14:33:00.0	1796604934
2023-06-21 14:23:11.0		Failed		2023-06-21 14:33:00.0	1796604934
2023-06-21 14:23:11.0		Failed		2023-06-21 14:33:00.0	1796604934
2023-06-21 14:23:11.0		Delivered to phone		2023-06-21 14:23:00.0	1796604934

**APPENDICES**

ENVIRONMENTAL IMPACT ASSESSMENT REPORT: Scoping and Environmental Impact Assessment (EIA) Process for the Proposed Development of a Solar Photovoltaic (PV) Facility (Kudu Solar Facility 3) and associated infrastructure, near De Aar, Northern Cape Province

---

<b>created_time</b>	<b>msisdn</b>	<b>status_text</b>	<b>origin_address</b>	<b>delivered_time</b>	<b>batch_id</b>
2023-06-21 14:23:11.0		Delivered to phone		2023-06-21 14:23:00.0	1796604934
2023-06-21 14:23:11.0		Delivered to phone		2023-06-21 14:23:00.0	1796604934
2023-06-21 14:23:11.0		Delivered to phone		2023-06-21 14:23:00.0	1796604934
2023-06-21 14:23:11.0		Delivered to phone		2023-06-21 14:23:00.0	1796604934
2023-06-21 14:23:11.0		Delivered to phone		2023-06-21 14:23:00.0	1796604934
2023-06-21 14:23:11.0		Delivered to phone		2023-06-21 14:23:00.0	1796604934
2023-06-21 14:23:11.0		Delivered to phone		2023-06-21 15:23:00.0	1796604934
2023-06-21 14:23:11.0		Delivered to phone		2023-06-21 15:23:00.0	1796604934
2023-06-21 14:23:11.0		Delivered to phone		2023-06-21 14:23:00.0	1796604934
2023-06-21 14:23:11.0		Delivered to phone		2023-06-21 14:23:00.0	1796604934
2023-06-21 14:23:11.0		Delivered to phone		2023-06-21 14:23:00.0	1796604934
2023-06-21 14:23:11.0		Delivered to phone		2023-06-21 14:26:00.0	1796604934
2023-06-21 14:23:11.0		Delivered to phone		2023-06-21 14:26:00.0	1796604934
2023-06-21 14:23:11.0		Delivered to phone		2023-06-21 14:26:00.0	1796604934
2023-06-21 14:23:11.0		Delivered to phone		2023-06-21 14:23:00.0	1796604934
2023-06-21 14:23:11.0		Delivered to phone		2023-06-21 14:23:00.0	1796604934
2023-06-21 14:23:11.0		Delivered to phone		2023-06-21 14:23:00.0	1796604934
2023-06-21 14:23:11.0		Delivered to phone		2023-06-21 15:14:00.0	1796604934
2023-06-21 14:23:11.0		Delivered to phone		2023-06-21 16:34:00.0	1796604934
2023-06-21 14:23:11.0		Delivered to phone		2023-06-21 15:14:00.0	1796604934
2023-06-21 14:23:11.0		Delivered to phone		2023-06-21 14:23:00.0	1796604934
2023-06-21 14:23:11.0		Delivered to phone		2023-06-21 14:23:00.0	1796604934
2023-06-21 14:23:11.0		Delivered to phone		2023-06-21 14:23:00.0	1796604934
2023-06-21 14:23:11.0		Delivered to phone		2023-06-21 16:54:00.0	1796604934
2023-06-21 14:23:11.0		Delivered to phone		2023-06-21 16:52:00.0	1796604934
2023-06-21 14:23:11.0		Delivered to phone		2023-06-21 16:50:00.0	1796604934
2023-06-21 14:23:11.0		Delivered to phone		2023-06-21 16:54:00.0	1796604934
2023-06-21 14:23:11.0		Delivered to phone		2023-06-21 16:50:00.0	1796604934
2023-06-21 14:23:11.0		Delivered to phone		2023-06-21 16:38:00.0	1796604934

**APPENDICES**

ENVIRONMENTAL IMPACT ASSESSMENT REPORT: Scoping and Environmental Impact Assessment (EIA) Process for the Proposed Development of a Solar Photovoltaic (PV) Facility (Kudu Solar Facility 3) and associated infrastructure, near De Aar, Northern Cape Province

---

<b>created_time</b>	<b>msisdn</b>	<b>status_text</b>	<b>origin_address</b>	<b>delivered_time</b>	<b>batch_id</b>
2023-06-21 14:23:11.0		Delivered to phone		2023-06-21 14:23:00.0	1796604934
2023-06-21 14:23:11.0		Delivered to phone		2023-06-21 14:23:00.0	1796604934
2023-06-21 14:23:11.0		Delivered to phone		2023-06-21 14:23:00.0	1796604934
2023-06-21 14:23:11.0		Delivered to phone		2023-06-21 14:23:00.0	1796604934
2023-06-21 14:23:11.0		Delivered to phone		2023-06-21 14:23:00.0	1796604934
2023-06-21 14:23:11.0		Delivered to phone		2023-06-21 14:23:00.0	1796604934
2023-06-21 14:23:11.0		Delivered to phone		2023-06-21 14:23:00.0	1796604934
2023-06-21 14:23:11.0		Delivered to phone		2023-06-21 14:23:00.0	1796604934
2023-06-21 14:23:11.0		Delivered to phone		2023-06-21 14:23:00.0	1796604934
2023-06-21 14:23:11.0		Delivered to phone		2023-06-21 14:23:00.0	1796604934
2023-06-21 14:23:11.0		Delivered to phone		2023-06-21 14:23:00.0	1796604934
2023-06-21 14:23:11.0		Delivered to phone		2023-06-21 14:23:00.0	1796604934
2023-06-21 14:23:11.0		Delivered to phone		2023-06-21 14:23:00.0	1796604934
2023-06-21 14:23:11.0		Delivered to phone		2023-06-21 14:23:00.0	1796604934
2023-06-21 14:23:11.0		Delivered to phone		2023-06-21 14:51:00.0	1796604934
2023-06-21 14:23:11.0		Delivered to phone		2023-06-21 14:51:00.0	1796604934
2023-06-21 14:23:11.0		Delivered to phone		2023-06-21 14:51:00.0	1796604934
2023-06-21 14:23:11.0		Delivered to phone		2023-06-21 14:51:00.0	1796604934
2023-06-21 14:23:11.0		Delivered to phone		2023-06-21 16:04:00.0	1796604934
2023-06-21 14:23:11.0		Delivered to phone		2023-06-21 16:04:00.0	1796604934
2023-06-21 14:23:11.0		Delivered to phone		2023-06-21 16:04:00.0	1796604934
2023-06-21 14:23:11.0		Delivered to phone		2023-06-21 14:23:00.0	1796604934
2023-06-21 14:23:11.0		Delivered to phone		2023-06-21 14:23:00.0	1796604934
2023-06-21 14:23:11.0		Delivered to phone		2023-06-21 14:23:00.0	1796604934
2023-06-21 14:23:11.0		Delivered to phone		2023-06-21 14:23:00.0	1796604934
2023-06-21 14:23:11.0		Delivered to phone		2023-06-21 14:23:00.0	1796604934
2023-06-21 14:23:11.0		Delivered to phone		2023-06-21 14:23:00.0	1796604934
2023-06-21 14:23:11.0		Delivered to phone		2023-06-21 14:23:00.0	1796604934
2023-06-21 14:23:11.0		Failed: delivery to network failed			1796604934
2023-06-21 14:23:11.0		Failed: delivery to network failed			1796604934
2023-06-21 14:23:11.0		Failed: delivery to network failed			1796604934

## APPENDICES

ENVIRONMENTAL IMPACT ASSESSMENT REPORT: Scoping and Environmental Impact Assessment (EIA) Process for the Proposed Development of a Solar Photovoltaic (PV) Facility (Kudu Solar Facility 3) and associated infrastructure, near De Aar, Northern Cape Province

---

<b>created_time</b>	<b>msisdn</b>	<b>status_text</b>	<b>origin_address</b>	<b>delivered_time</b>	<b>batch_id</b>
2023-06-21 14:23:11.0		Delivered to phone		2023-06-21 14:23:00.0	1796604934
2023-06-21 14:23:11.0		Delivered to phone		2023-06-21 14:23:00.0	1796604934
2023-06-21 14:23:11.0		Delivered to phone		2023-06-21 14:23:00.0	1796604934

## APPENDICES

ENVIRONMENTAL IMPACT ASSESSMENT REPORT: Scoping and Environmental Impact Assessment (EIA) Process for the Proposed Development of a Solar Photovoltaic (PV) Facility (Kudu Solar Facility 3) and associated infrastructure, near De Aar, Northern Cape Province

---

### 12. Personalised Reminder Email sent to key I&APs, Stakeholders and Organs of State (as determined by the DFFE) between 21 and 27 June 2023

#### Personalised reminder email sent to officials at the Department of Water and Sanitation (DWS)

**From:** EMS  
**Sent:** Wednesday, 21 June 2023 14:18  
**To:** MeiM@dwa.gov.za; ranwedzim@dwa.gov.za; CloeteS@dws.gov.za; JansenMe@dws.gov.za; kgapholam@dws.gov.za; SchwartzC@dws.gov.za; SekwailaK@dws.gov.za; AckermanP@dws.gov.za; masindit@dws.gov.za; FranksL@dws.gov.za; MokhoantleL@dws.gov.za; mahunonyanem@dws.gov.za; VanDykG@dws.gov.za; FeniN2@dwa.gov.za  
**Cc:** EMS  
**Subject:** RE: Reminder - Availability of Draft EIA Reports for Comment - Kudu Solar PV - DWS

Good day DWS Officials

I trust that you are well.

We are kindly following up on the Kudu PV Projects, as per our communications below.

Please let us know if the Department of Water and Sanitation has any comments on the Draft EIA Reports for the Kudu PV Projects? If so, please kindly send through your comments by **3 July 2023**.

If the Department does not have any comments, please also kindly confirm.

The proposed projects are intended to be submitted in next rounds of the REIPPPP, and any applications for WUL or GA will be undertaken post Environmental Authorisation (should it be granted).

Thank you for your assistance with this.

Kind Regards,  
Rohaida

CSIR Environmental Management Services  
E-mail: [ems@csir.co.za](mailto:ems@csir.co.za)  
Postal Address: Postnet Suite 367, Private Bag x10, Musgrave Road, 4062  
Tel: 031 242 2300



## APPENDICES

ENVIRONMENTAL IMPACT ASSESSMENT REPORT: Scoping and Environmental Impact Assessment (EIA) Process for the Proposed Development of a Solar Photovoltaic (PV) Facility (Kudu Solar Facility 3) and associated infrastructure, near De Aar, Northern Cape Province

---

### Personalised reminder email sent to officials at the Northern Cape Department of Agriculture, Environmental Affairs, Rural Development and Land Reform (NC DAERDLR)

**From:** EMS  
**Sent:** Wednesday, 21 June 2023 14:26  
**To:** elsabe.dtec; nuys.denc@gmail.com; oriba.denc@gmail.com; oriba@ncpg.gov.za; Samantha De la Fontaine; sdelafontaine@daerl.co.za  
**Cc:** EMS  
**Subject:** RE: Reminder - Availability of Draft EIA Reports for Comment - Kudu Solar PV - NC DAEARDLR

Good day Northern Cape Department of Agriculture, Environmental Affairs, Rural Development and Land Reform Officials

I trust that you are well.

We are kindly following up on the Kudu PV Projects, as per our communications below.

Please let us know if the Northern Cape Department of Agriculture, Environmental Affairs, Rural Development and Land Reform has any comments on the Draft EIA Reports for the Kudu PV Projects? If so, please kindly send through your comments by **3 July 2023**.

If the Department does not have any comments, please also kindly confirm.

Chapter 20 of the Draft EIA Reports provide a summary of the key impact assessment, specialist findings, sensitivities and mapping.

Thank you for your assistance with this. We look forward to your feedback.

Kind Regards,  
Rohaida

CSIR Environmental Management Services  
E-mail: [ems@csir.co.za](mailto:ems@csir.co.za)  
Postal Address: Postnet Suite 367, Private Bag x10, Musgrave Road, 4062  
Tel: 031 242 2300

## APPENDICES

### ENVIRONMENTAL IMPACT ASSESSMENT REPORT: Scoping and Environmental Impact Assessment (EIA) Process for the Proposed Development of a Solar Photovoltaic (PV) Facility (Kudu Solar Facility 3) and associated infrastructure, near De Aar, Northern Cape Province

---

#### Personalised reminder email sent to officials at the DFFE Directorate: Protected Areas

**From:** EMS  
**Sent:** Thursday, 22 June 2023 12:45  
**To:** EMS  
**Cc:** Tnethononda@dffe.gov.za; RMagodi@dffe.gov.za  
**Subject:** RE: Reminder of the Availability of Draft EIA Reports for Comment - Kudu Solar PV  
**Attachments:** 2021\_11\_03\_Land\_portions.kmz

Dear Officials at the DFFE Directorate: Protected Areas

I hope this email finds you well.

I am kindly following up on the proposed development of twelve Solar Photovoltaic (PV) Facilities (Kudu Solar Facilities 1 to 12) and associated infrastructure, near De Aar, Northern Cape Province, as per our communications (copied here). Attached is the KMZ file of the farm portions that form part of the study area.

Please note that the 30-day comment period on the Draft Environmental Impact Assessment Reports for the proposed projects closes on **3 July 2023**.

Should the Department still wish to submit comments on the Draft EIA Reports for the above-mentioned projects, please send your comments in writing to [ems@csir.co.za](mailto:ems@csir.co.za).

If the Department does not have any comments on the Draft EIA Reports for the above-mentioned projects, kindly acknowledge this email and state that the Department does not have any comments on these projects.

Thank you in advance.

Kind Regards  
Helen Antonopoulos

CSIR Environmental Management Services  
E-mail: [ems@csir.co.za](mailto:ems@csir.co.za)  
Postal Address: Postnet Suite 367, Private Bag x10, Musgrave Road, 4062  
Tel: 031 242 2300

---

## APPENDICES

ENVIRONMENTAL IMPACT ASSESSMENT REPORT: Scoping and Environmental Impact Assessment (EIA) Process for the Proposed Development of a Solar Photovoltaic (PV) Facility (Kudu Solar Facility 3) and associated infrastructure, near De Aar, Northern Cape Province

---

### Personalised reminder email sent to an official at Eskom

**From:** EMS <ems@csir.co.za>

**Sent:** Wednesday, 21 June 2023 14:49

**To:** John Geeringh <GeerinJH@eskom.co.za>

**Cc:** EMS <ems@csir.co.za>

**Subject:** [CAUTION:EXTERNAL EMAIL] RE: Reminder of the Availability of Draft EIA Reports for Comment - Kudu Solar PV - Eskom

Hi John

I hope that you are well.

No trouble at all. Please let us know if Eskom has any comments on the Draft EIA Reports for the Kudu PV Projects? If so, please kindly send through your comments by **3 July 2023**.

If Eskom does not have any comments, please also kindly confirm.

We look forward to your feedback.

Kind Regards,  
Rohaida

CSIR Environmental Management Services

E-mail: [ems@csir.co.za](mailto:ems@csir.co.za)

Postal Address: Postnet Suite 367, Private Bag x10, Musgrave Road, 4062

Tel: 031 242 2300

## APPENDICES

### ENVIRONMENTAL IMPACT ASSESSMENT REPORT: Scoping and Environmental Impact Assessment (EIA) Process for the Proposed Development of a Solar Photovoltaic (PV) Facility (Kudu Solar Facility 3) and associated infrastructure, near De Aar, Northern Cape Province

---

#### Personalised reminder email sent to officials at the Department of Transport (DoT)

**From:** EMS  
**Sent:** Thursday, 22 June 2023 12:47  
**To:** EMS  
**Cc:** info@dot.gov.za; TransportMinistry@dot.gov.za; ItumelengL@dot.gov.za; MsibiN@dot.gov.za  
**Subject:** RE: Reminder of the Availability of Draft EIA Reports for Comment - Kudu Solar PV

Dear Officials at the Department of Transport

I hope this email finds you well.

I am kindly following up on the proposed development of twelve Solar Photovoltaic (PV) Facilities (Kudu Solar Facilities 1 to 12) and associated infrastructure, near De Aar, Northern Cape Province, as per our communications (copied here).

Please note that the 30-day comment period on the Draft Environmental Impact Assessment Reports for the proposed projects closes on **3 July 2023**.

Should the Department still wish to submit comments on the Draft EIA Reports for the above-mentioned projects, please send your comments in writing to [ems@csir.co.za](mailto:ems@csir.co.za).

If the Department does not have any comments on the Draft EIA Reports for the above-mentioned projects, kindly acknowledge this email and state that the Department does not have any comments on these projects.

Thank you in advance.

Kind Regards  
Helen Antonopoulos

CSIR Environmental Management Services  
E-mail: [ems@csir.co.za](mailto:ems@csir.co.za)  
Postal Address: Postnet Suite 367, Private Bag x10, Musgrave Road, 4062  
Tel: 031 242 2300

## APPENDICES

### ENVIRONMENTAL IMPACT ASSESSMENT REPORT: Scoping and Environmental Impact Assessment (EIA) Process for the Proposed Development of a Solar Photovoltaic (PV) Facility (Kudu Solar Facility 3) and associated infrastructure, near De Aar, Northern Cape Province

---

#### Personalised reminder email sent to an official at the Department of Energy (DoE)

**From:** EMS  
**Sent:** Thursday, 22 June 2023 12:48  
**To:** EMS  
**Cc:** Mpho.Mabaso@dmre.gov.za  
**Subject:** RE: Reminder of the Availability of Draft EIA Reports for Comment - Kudu Solar PV

Dear Official at the Department of Energy

I hope this email finds you well.

I am kindly following up on the proposed development of twelve Solar Photovoltaic (PV) Facilities (Kudu Solar Facilities 1 to 12) and associated infrastructure, near De Aar, Northern Cape Province, as per our communications (copied here).

Please note that the 30-day comment period on the Draft Environmental Impact Assessment Reports for the proposed projects closes on **3 July 2023**.

Should the Department still wish to submit comments on the Draft EIA Reports for the above-mentioned projects, please send your comments in writing to [ems@csir.co.za](mailto:ems@csir.co.za).

If the Department does not have any comments on the Draft EIA Reports for the above-mentioned projects, kindly acknowledge this email and state that the Department does not have any comments on these projects.

Thank you in advance.

Kind Regards  
Helen Antonopoulos

CSIR Environmental Management Services  
E-mail: [ems@csir.co.za](mailto:ems@csir.co.za)  
Postal Address: Postnet Suite 367, Private Bag x10, Musgrave Road, 4062  
Tel: 031 242 2300

## APPENDICES

### ENVIRONMENTAL IMPACT ASSESSMENT REPORT: Scoping and Environmental Impact Assessment (EIA) Process for the Proposed Development of a Solar Photovoltaic (PV) Facility (Kudu Solar Facility 3) and associated infrastructure, near De Aar, Northern Cape Province

---

#### Personalised reminder email sent to officials at the National Energy Regulator of South Africa (NERSA)

**From:** EMS  
**Sent:** Thursday, 22 June 2023 12:53  
**To:** EMS  
**Cc:** andile.gxasheka@nersa.org.za; charles.hlebel@nersa.org.za; sweetness.malete@nersa.org.za; poppie.mahlangu@nersa.org.za; siphwe.khumalo@nersa.org.za; tamai.hore@nersa.org.za  
**Subject:** RE: Reminder of the Availability of Draft EIA Reports for Comment - Kudu Solar PV

Dear Officials at the National Energy Regulator of South Africa

I hope this email finds you well.

I am kindly following up on the proposed development of twelve Solar Photovoltaic (PV) Facilities (Kudu Solar Facilities 1 to 12) and associated infrastructure, near De Aar, Northern Cape Province, as per our communications (copied here).

Please note that the 30-day comment period on the Draft Environmental Impact Assessment Reports for the proposed projects closes on **3 July 2023**.

Should the Department still wish to submit comments on the Draft EIA Reports for the above-mentioned projects, please send your comments in writing to [ems@csir.co.za](mailto:ems@csir.co.za).

If the Department does not have any comments on the Draft EIA Reports for the above-mentioned projects, kindly acknowledge this email and state that the Department does not have any comments on these projects.

Thank you in advance.

Kind Regards  
Helen Antonopoulos

CSIR Environmental Management Services  
E-mail: [ems@csir.co.za](mailto:ems@csir.co.za)  
Postal Address: Postnet Suite 367, Private Bag x10, Musgrave Road, 4062  
Tel: 031 242 2300

---

## APPENDICES

ENVIRONMENTAL IMPACT ASSESSMENT REPORT: Scoping and Environmental Impact Assessment (EIA) Process for the Proposed Development of a Solar Photovoltaic (PV) Facility (Kudu Solar Facility 3) and associated infrastructure, near De Aar, Northern Cape Province

---

### Personalised reminder emails sent to officials at the Department of Defence (DoD) / South African National Defence Force (SANDF)

**From:** EMS <ems@csir.co.za>  
**Sent:** Thursday, 22 June 2023 13:03  
**To:** EMS  
**Subject:** RE: Reminder of the Availability of Draft EIA Reports for Comment - Kudu Solar PV

**Categories:** This message has been archived by Retain on June 30 2023 02:45  
**Bcc:** [REDACTED]

Dear Officials at the Department of Defence (DoD) / South African National Defence Force (SANDF)

I hope this email finds you well.

I am kindly following up on the proposed development of twelve Solar Photovoltaic (PV) Facilities (Kudu Solar Facilities 1 to 12) and associated infrastructure, near De Aar, Northern Cape Province, as per our communications.

Please note that the 30-day comment period on the Draft Environmental Impact Assessment Reports for the proposed projects closes on **3 July 2023**.

Should the Department still wish to submit comments on the Draft EIA Reports for the above-mentioned projects, please send your comments in writing to [ems@csir.co.za](mailto:ems@csir.co.za).

If the Department does not have any comments on the Draft EIA Reports for the above-mentioned projects, kindly acknowledge this email and state that the Department does not have any comments on these projects.

Thank you in advance.

Kind Regards  
Helen Antonopoulos

CSIR Environmental Management Services  
E-mail: [ems@csir.co.za](mailto:ems@csir.co.za)  
Postal Address: Postnet Suite 367, Private Bag x10, Musgrave Road, 4062  
Tel: 031 242 2300

**From:** EMS <ems@csir.co.za>  
**Sent:** Wednesday, 28 June 2023 13:51  
**To:** [REDACTED]  
**Subject:** FW: Renewable Energy Applications: Outstanding information to complete  
**Attachments:** 2021\_11\_03\_Land\_portions.kmz; 2023-03-14\_Kudu\_Buildable Areas.kmz

Goeie middag [REDACTED]

Baie dankie dat u my oproep vroeër vandag geneem het.

Soos bespreek, sien asseblief die aangehede KMZs vir die voorgestelde ontwikkeling van die Kudu Sonkragfasiliteite, geleë naby Petrusville en Philipstown in die Noord-Kaap.

Laat weet asseblief as u enige verdere inligting benodig rakende die projekte.

Baie dankie  
Helen Antonopoulos

## APPENDICES

ENVIRONMENTAL IMPACT ASSESSMENT REPORT: Scoping and Environmental Impact Assessment (EIA) Process for the Proposed Development of a Solar Photovoltaic (PV) Facility (Kudu Solar Facility 3) and associated infrastructure, near De Aar, Northern Cape Province

---

### Personalised reminder email sent to officials at the Air Traffic and Navigation Services (ATNS) & the Civil Aviation Authorities (CAA)

**From:** EMS  
**Sent:** Thursday, 22 June 2023 13:06  
**To:** EMS  
**Subject:** RE: Reminder of the Availability of Draft EIA Reports for Comment - Kudu Solar PV

Dear Officials at the Air Traffic and Navigation Services (ATNS) & the Civil Aviation Authorities (CAA)

I hope this email finds you well.

I am kindly following up on the proposed development of twelve Solar Photovoltaic (PV) Facilities (Kudu Solar Facilities 1 to 12) and associated infrastructure, near De Aar, Northern Cape Province, as per our communications (copied here).

Please note that the 30-day comment period on the Draft Environmental Impact Assessment Reports for the proposed projects closes on **3 July 2023**.

Should the ATNS/ CAA still wish to submit comments on the Draft EIA Reports for the above-mentioned projects, please send your comments in writing to [ems@csir.co.za](mailto:ems@csir.co.za).

If the ATNS/ CAA does not have any comments on the Draft EIA Reports for the above-mentioned projects, kindly acknowledge this email and state that the ATNS/ CAA does not have any comments on these projects.

Thank you in advance.

Kind Regards  
Helen Antonopoulos

CSIR Environmental Management Services  
E-mail: [ems@csir.co.za](mailto:ems@csir.co.za)  
Postal Address: Postnet Suite 367, Private Bag x10, Musgrave Road, 4062  
Tel: 031 242 2300



## APPENDICES

### ENVIRONMENTAL IMPACT ASSESSMENT REPORT: Scoping and Environmental Impact Assessment (EIA) Process for the Proposed Development of a Solar Photovoltaic (PV) Facility (Kudu Solar Facility 3) and associated infrastructure, near De Aar, Northern Cape Province

---

#### Personalised reminder email sent to officials at the AgriSA and Agri Northern Cape

**From:** EMS  
**Sent:** Thursday, 22 June 2023 13:09  
**To:** EMS  
**Cc:** janse@agrisa.co.za; ontvangs@agrink.co.za; bestuurder@agrink.co.za  
**Subject:** RE: Reminder of the Availability of Draft EIA Reports for Comment - Kudu Solar PV

Dear Officials at AgriSA and Agri Northern Cape

I hope this email finds you well.

I am kindly following up on the proposed development of twelve Solar Photovoltaic (PV) Facilities (Kudu Solar Facilities 1 to 12) and associated infrastructure, near De Aar, Northern Cape Province, as per our communications (copied here).

Please note that the 30-day comment period on the Draft Environmental Impact Assessment Reports for the proposed projects closes on **3 July 2023**.

Should AgriSA/ Agri NC still wish to submit comments on the Draft EIA Reports for the above-mentioned projects, please send your comments in writing to [ems@csir.co.za](mailto:ems@csir.co.za).

If the AgriSA/ Agri NC does not have any comments on the Draft EIA Reports for the above-mentioned projects, kindly acknowledge this email and state that the AgriSA/ Agri NC does not have any comments on these projects.

Thank you in advance.

Kind Regards  
Helen Antonopoulos

CSIR Environmental Management Services  
E-mail: [ems@csir.co.za](mailto:ems@csir.co.za)  
Postal Address: Postnet Suite 367, Private Bag x10, Musgrave Road, 4062  
Tel: 031 242 2300

## APPENDICES

ENVIRONMENTAL IMPACT ASSESSMENT REPORT: Scoping and Environmental Impact Assessment (EIA) Process for the Proposed Development of a Solar Photovoltaic (PV) Facility (Kudu Solar Facility 3) and associated infrastructure, near De Aar, Northern Cape Province

---

### Personalised reminder email sent to officials at the Northern Cape Heritage Resources Authority (NCHRA)

**From:** EMS  
**Sent:** Thursday, 22 June 2023 13:11  
**To:** EMS  
**Cc:** rtimothy@nbkb.org.za; rcwangae@nbkb.org.za  
**Subject:** RE: Reminder of the Availability of Draft EIA Reports for Comment - Kudu Solar PV

Dear Officials at the Northern Cape Heritage Resources Authority (NCHRA)

I hope this email finds you well.

I am kindly following up on the proposed development of twelve Solar Photovoltaic (PV) Facilities (Kudu Solar Facilities 1 to 12) and associated infrastructure, near De Aar, Northern Cape Province, as per our communications (copied here).

Please note that the 30-day comment period on the Draft Environmental Impact Assessment Reports for the proposed projects closes on **3 July 2023**.

Should the NCHRA still wish to submit comments on the Draft EIA Reports for the above-mentioned projects, please send your comments in writing to [ems@csir.co.za](mailto:ems@csir.co.za).

If the NCHRA does not have any comments on the Draft EIA Reports for the above-mentioned projects, kindly acknowledge this email and state that the NCHRA does not have any comments on these projects.

Thank you in advance.

Kind Regards  
Helen Antonopoulos

CSIR Environmental Management Services  
E-mail: [ems@csir.co.za](mailto:ems@csir.co.za)  
Postal Address: Postnet Suite 367, Private Bag x10, Musgrave Road, 4062  
Tel: 031 242 2300

## APPENDICES

ENVIRONMENTAL IMPACT ASSESSMENT REPORT: Scoping and Environmental Impact Assessment (EIA) Process for the Proposed Development of a Solar Photovoltaic (PV) Facility (Kudu Solar Facility 3) and associated infrastructure, near De Aar, Northern Cape Province

---

### Personalised reminder email sent to officials at the Pixley Ka Seme District Municipality (PKSDM)

**From:** EMS <ems@csir.co.za>  
**Sent:** Thursday, 22 June 2023 13:14  
**To:** EMS  
**Subject:** RE: Reminder of the Availability of Draft EIA Reports for Comment - Kudu Solar PV

**Categories:** This message has been archived by Retain on June 30 2023 02:45

**Bcc:**



Dear Officials at the Pixley Ka Seme District Municipality (PKSDM)

I hope this email finds you well.

I am kindly following up on the proposed development of twelve Solar Photovoltaic (PV) Facilities (Kudu Solar Facilities 1 to 12) and associated infrastructure, near De Aar, Northern Cape Province, as per our communications (copied here).

Please note that the 30-day comment period on the Draft Environmental Impact Assessment Reports for the proposed projects closes on **3 July 2023**.

Should the PKSDM still wish to submit comments on the Draft EIA Reports for the above-mentioned projects, please send your comments in writing to [ems@csir.co.za](mailto:ems@csir.co.za).

If the PKSDM does not have any comments on the Draft EIA Reports for the above-mentioned projects, kindly acknowledge this email and state that the PKSDM does not have any comments on these projects.

Thank you in advance.

Kind Regards  
Helen Antonopoulos

CSIR Environmental Management Services  
E-mail: [ems@csir.co.za](mailto:ems@csir.co.za)  
Postal Address: Postnet Suite 367, Private Bag x10, Musgrave Road, 4062  
Tel: 031 242 2300

---

## APPENDICES

ENVIRONMENTAL IMPACT ASSESSMENT REPORT: Scoping and Environmental Impact Assessment (EIA) Process for the Proposed Development of a Solar Photovoltaic (PV) Facility (Kudu Solar Facility 3) and associated infrastructure, near De Aar, Northern Cape Province

---

### Personalised reminder email sent to officials at the Renosterberg Local Municipality (RLM)

**From:** EMS <ems@csir.co.za>  
**Sent:** Thursday, 22 June 2023 13:16  
**To:** EMS  
**Subject:** RE: Reminder of the Availability of Draft EIA Reports for Comment - Kudu Solar PV

**Categories:** This message has been archived by Retain on June 30 2023 02:45

**Bcc:**



Dear Officials at the Renosterberg Local Municipality (RLM)

I hope this email finds you well.

I am kindly following up on the proposed development of twelve Solar Photovoltaic (PV) Facilities (Kudu Solar Facilities 1 to 12) and associated infrastructure, near De Aar, Northern Cape Province, as per our communications (copied here).

Please note that the 30-day comment period on the Draft Environmental Impact Assessment Reports for the proposed projects closes on **3 July 2023**.

Should the RLM still wish to submit comments on the Draft EIA Reports for the above-mentioned projects, please send your comments in writing to [ems@csir.co.za](mailto:ems@csir.co.za).

If the RLM does not have any comments on the Draft EIA Reports for the above-mentioned projects, kindly acknowledge this email and state that the RLM does not have any comments on these projects.

Thank you in advance.

Kind Regards  
Helen Antonopoulos

CSIR Environmental Management Services  
E-mail: [ems@csir.co.za](mailto:ems@csir.co.za)  
Postal Address: Postnet Suite 367, Private Bag x10, Musgrave Road, 4062  
Tel: 031 242 2300

## APPENDICES

ENVIRONMENTAL IMPACT ASSESSMENT REPORT: Scoping and Environmental Impact Assessment (EIA) Process for the Proposed Development of a Solar Photovoltaic (PV) Facility (Kudu Solar Facility 3) and associated infrastructure, near De Aar, Northern Cape Province

---

### Personalised reminder email sent to a councilor at the Renosterberg Local Municipality

**From:** EMS <ems@csir.co.za>  
**Sent:** Monday, 26 June 2023 16:31  
**To:** EMS  
**Cc:** [REDACTED]  
**Subject:** RE: Reminder of the Availability of Draft EIA Reports for Comment - Kudu Solar PV

**Categories:** This message has been archived by Retain on July 04 2023 07:38

Goeie middag Meneer Posthumus

Baie dankie dat u my oproep vroeër geneem het en vir u tyd. Ek waardeer dit opreg.

Soos bespreek, sien asseblief die e-posse hieronder vir inligting rakende die 12x Kudu Sonfasiliteite. Kommentaar kan gerig word aan die WNNR Omgewingsbestuursdiense met e-posadres [ems@csir.co.za](mailto:ems@csir.co.za) tot en met Maandag 3 Julie 2023.

U is meer as welkom om my per selfoon (060 829 0202) of per e-pos te kontak indien u enige vrae het of verdere inligting veris.

Baie dankie  
Helen Antonopoulos

---

### Personalised reminder email sent to officials at the Endangered Wildlife Trust (EWT)

**From:** EMS  
**Sent:** Thursday, 22 June 2023 13:19  
**To:** EMS  
**Cc:** eia@ewt.org.za; bonnies@ewt.org.za; wep@ewt.org.za; cobust@ewt.org.za  
**Subject:** RE: Reminder of the Availability of Draft EIA Reports for Comment - Kudu Solar PV

Dear Officials at the Endangered Wildlife Trust (EWT)

I hope this email finds you well.

I am kindly following up on the proposed development of twelve Solar Photovoltaic (PV) Facilities (Kudu Solar Facilities 1 to 12) and associated infrastructure, near De Aar, Northern Cape Province, as per our communications (copied here).

Please note that the 30-day comment period on the Draft Environmental Impact Assessment Reports for the proposed projects closes on **3 July 2023**.

Should the organisation still wish to submit comments on the Draft EIA Reports for the above-mentioned projects, please send your comments in writing to [ems@csir.co.za](mailto:ems@csir.co.za).

If the organisation does not have any comments on the Draft EIA Reports for the above-mentioned projects, kindly acknowledge this email and state that the organisation does not have any comments on these projects.

Thank you in advance.

Kind Regards  
Helen Antonopoulos

CSIR Environmental Management Services  
E-mail: [ems@csir.co.za](mailto:ems@csir.co.za)  
Postal Address: Postnet Suite 367, Private Bag x10, Musgrave Road, 4062  
Tel: 031 242 2300

---

## APPENDICES

ENVIRONMENTAL IMPACT ASSESSMENT REPORT: Scoping and Environmental Impact Assessment (EIA) Process for the Proposed Development of a Solar Photovoltaic (PV) Facility (Kudu Solar Facility 3) and associated infrastructure, near De Aar, Northern Cape Province

---

### Personalised reminder email sent to officials at BirdLife SA

**From:** EMS <ems@csir.co.za>  
**Sent:** Thursday, 22 June 2023 13:21  
**To:** EMS  
**Cc:** info@birdlife.org.za; advocacy@birdlife.org.za; Sam Ralston  
**Subject:** RE: Reminder of the Availability of Draft EIA Reports for Comment - Kudu Solar PV

**Categories:** This message has been archived by Retain on June 30 2023 02:45  
**Bcc:** spothil@gmail.com

Dear Officials at the BirdLife SA

I hope this email finds you well.

I am kindly following up on the proposed development of twelve Solar Photovoltaic (PV) Facilities (Kudu Solar Facilities 1 to 12) and associated infrastructure, near De Aar, Northern Cape Province, as per our communications (copied here).

Please note that the 30-day comment period on the Draft Environmental Impact Assessment Reports for the proposed projects closes on **3 July 2023**.

Should the organisation still wish to submit comments on the Draft EIA Reports for the above-mentioned projects, please send your comments in writing to [ems@csir.co.za](mailto:ems@csir.co.za).

If the organisation does not have any comments on the Draft EIA Reports for the above-mentioned projects, kindly acknowledge this email and state that the organisation does not have any comments on these projects.

Thank you in advance.

Kind Regards  
Helen Antonopoulos

CSIR Environmental Management Services  
E-mail: [ems@csir.co.za](mailto:ems@csir.co.za)  
Postal Address: Postnet Suite 367, Private Bag x10, Musgrave Road, 4062  
Tel: 031 242 2300

---

## APPENDICES

ENVIRONMENTAL IMPACT ASSESSMENT REPORT: Scoping and Environmental Impact Assessment (EIA) Process for the Proposed Development of a Solar Photovoltaic (PV) Facility (Kudu Solar Facility 3) and associated infrastructure, near De Aar, Northern Cape Province

---

### Personalised reminder email sent to officials at EarthLife Africa

**From:** EMS <ems@csir.co.za>  
**Sent:** Thursday, 22 June 2023 13:22  
**To:** EMS  
**Subject:** RE: Reminder of the Availability of Draft EIA Reports for Comment - Kudu Solar PV

**Categories:** This message has been archived by Retain on June 30 2023 02:45  
**Bcc:** seccp@earthlife.org.za; mabule@ghouse.org.za

Dear Officials at EarthLife Africa

I hope this email finds you well.

I am kindly following up on the proposed development of twelve Solar Photovoltaic (PV) Facilities (Kudu Solar Facilities 1 to 12) and associated infrastructure, near De Aar, Northern Cape Province, as per our communications (copied here).

Please note that the 30-day comment period on the Draft Environmental Impact Assessment Reports for the proposed projects closes on **3 July 2023**.

Should the organisation still wish to submit comments on the Draft EIA Reports for the above-mentioned projects, please send your comments in writing to [ems@csir.co.za](mailto:ems@csir.co.za).

If the organisation does not have any comments on the Draft EIA Reports for the above-mentioned projects, kindly acknowledge this email and state that the organisation does not have any comments on these projects.

Thank you in advance.

Kind Regards  
Helen Antonopoulos

CSIR Environmental Management Services  
E-mail: [ems@csir.co.za](mailto:ems@csir.co.za)  
Postal Address: Postnet Suite 367, Private Bag x10, Musgrave Road, 4062  
Tel: 031 242 2300

---

## APPENDICES

ENVIRONMENTAL IMPACT ASSESSMENT REPORT: Scoping and Environmental Impact Assessment (EIA) Process for the Proposed Development of a Solar Photovoltaic (PV) Facility (Kudu Solar Facility 3) and associated infrastructure, near De Aar, Northern Cape Province

---

### Personalised reminder email sent to officials at the Sustainable Energy Society of Southern Africa (SESSA)

**From:** EMS  
**Sent:** Thursday, 22 June 2023 13:23  
**To:** EMS  
**Cc:** office@sessa.org.za  
**Subject:** RE: Reminder of the Availability of Draft EIA Reports for Comment - Kudu Solar PV

Dear Officials at the Sustainable Energy Society of Southern Africa (SESSA)

I hope this email finds you well.

I am kindly following up on the proposed development of twelve Solar Photovoltaic (PV) Facilities (Kudu Solar Facilities 1 to 12) and associated infrastructure, near De Aar, Northern Cape Province, as per our communications (copied here).

Please note that the 30-day comment period on the Draft Environmental Impact Assessment Reports for the proposed projects closes on **3 July 2023**.

Should the organisation still wish to submit comments on the Draft EIA Reports for the above-mentioned projects, please send your comments in writing to [ems@csir.co.za](mailto:ems@csir.co.za).

If the organisation does not have any comments on the Draft EIA Reports for the above-mentioned projects, kindly acknowledge this email and state that the organisation does not have any comments on these projects.

Thank you in advance.

Kind Regards  
Helen Antonopoulos

CSIR Environmental Management Services  
E-mail: [ems@csir.co.za](mailto:ems@csir.co.za)  
Postal Address: Postnet Suite 367, Private Bag x10, Musgrave Road, 4062  
Tel: 031 242 2300

---



## APPENDICES

ENVIRONMENTAL IMPACT ASSESSMENT REPORT: Scoping and Environmental Impact Assessment (EIA) Process for the Proposed Development of a Solar Photovoltaic (PV) Facility (Kudu Solar Facility 3) and associated infrastructure, near De Aar, Northern Cape Province

---

### Personalised reminder email sent to officials at the Wildlife and Environment Society of South Africa (WESSA)

**From:** EMS  
**Sent:** Thursday, 22 June 2023 13:27  
**To:** EMS  
**Cc:** wessanc@yahoo.com; morgan.griffiths@wessa.co.za  
**Subject:** RE: Reminder of the Availability of Draft EIA Reports for Comment - Kudu Solar PV

Dear Officials at the Wildlife and Environment Society of South Africa (WESSA)

I hope this email finds you well.

I am kindly following up on the proposed development of twelve Solar Photovoltaic (PV) Facilities (Kudu Solar Facilities 1 to 12) and associated infrastructure, near De Aar, Northern Cape Province, as per our communications (copied here).

Please note that the 30-day comment period on the Draft Environmental Impact Assessment Reports for the proposed projects closes on **3 July 2023**.

Should the organisation still wish to submit comments on the Draft EIA Reports for the above-mentioned projects, please send your comments in writing to [ems@csir.co.za](mailto:ems@csir.co.za).

If the organisation does not have any comments on the Draft EIA Reports for the above-mentioned projects, kindly acknowledge this email and state that the organisation does not have any comments on these projects.

Thank you in advance.

Kind Regards  
Helen Antonopoulos

CSIR Environmental Management Services  
E-mail: [ems@csir.co.za](mailto:ems@csir.co.za)  
Postal Address: Postnet Suite 367, Private Bag x10, Musgrave Road, 4062  
Tel: 031 242 2300

---

## APPENDICES

### ENVIRONMENTAL IMPACT ASSESSMENT REPORT: Scoping and Environmental Impact Assessment (EIA) Process for the Proposed Development of a Solar Photovoltaic (PV) Facility (Kudu Solar Facility 3) and associated infrastructure, near De Aar, Northern Cape Province

---

#### Personalised reminder email sent to an official at the World Wildlife Fund

**From:** EMS  
**Sent:** Thursday, 22 June 2023 13:29  
**To:** EMS  
**Cc:** mduplessis@wwf.org.za  
**Subject:** RE: Reminder of the Availability of Draft EIA Reports for Comment - Kudu Solar PV

Dear Dr Du Plessis

I hope this email finds you well.

I am kindly following up on the proposed development of twelve Solar Photovoltaic (PV) Facilities (Kudu Solar Facilities 1 to 12) and associated infrastructure, near De Aar, Northern Cape Province, as per our communications (copied here).

Please note that the 30-day comment period on the Draft Environmental Impact Assessment Reports for the proposed projects closes on **3 July 2023**.

Should the WWF still wish to submit comments on the Draft EIA Reports for the above-mentioned projects, please send your comments in writing to [ems@csir.co.za](mailto:ems@csir.co.za).

If the organisation does not have any comments on the Draft EIA Reports for the above-mentioned projects, kindly acknowledge this email and state that the organisation does not have any comments on these projects.

Thank you in advance.

Kind Regards  
Helen Antonopoulos

CSIR Environmental Management Services  
E-mail: [ems@csir.co.za](mailto:ems@csir.co.za)  
Postal Address: Postnet Suite 367, Private Bag x10, Musgrave Road, 4062  
Tel: 031 242 2300

---

## APPENDICES

ENVIRONMENTAL IMPACT ASSESSMENT REPORT: Scoping and Environmental Impact Assessment (EIA) Process for the Proposed Development of a Solar Photovoltaic (PV) Facility (Kudu Solar Facility 3) and associated infrastructure, near De Aar, Northern Cape Province

---

### Personalised reminder emails sent to adjacent, surrounding, or nearby landowners

**From:** EMS <ems@csir.co.za>  
**Sent:** Monday, 26 June 2023 14:32  
**To:** EMS  
**Cc:** [REDACTED]  
**Subject:** RE: Herinnering van die Beskikbaarheid van die Konsep Omgewingsimpakverslae vir Kommentaar - Kudu Sonkragfasiliteite

**Categories:** This message has been archived by Retain on July 04 2023 07:38

Goeie middag [REDACTED]

Ek het u vroeër vandag probeer skakel namens die Wetenskaplike en Nywerheidsnavorsingsraad (WNNR). Die WNNR is aangestel deur ABO Wind (Edms) Bk as die onafhanklike omgewingskonsultant vir die voorgestelde ontwikkeling van die Kudu Sonkragfasiliteite, geleë naby Petrusville en Philipstown in die Noord-Kaap.

As 'n geïdentifiseerde aangrensende grondeienaar, wil ons u graag herinner dat die publieke deelname periode op 03 Julie 2023 sluit, indien u kommentaar wil lewer op die projekte. U kan u kommentaar rig aan die WNNR Omgewingsbestuursdiense met e-posadres [ems@csir.co.za](mailto:ems@csir.co.za).

U is meer as welkom om my per selfoon [REDACTED] of per e-pos [REDACTED] te kontak indien u enige vrae het of verdere inligting vereis.

Baie dankie  
Helen Antonopoulos (WNNR)

---

**From:** EMS <ems@csir.co.za>  
**Sent:** Monday, 26 June 2023 14:36  
**To:** EMS  
**Cc:** [REDACTED]  
**Subject:** RE: Herinnering van die Beskikbaarheid van die Konsep Omgewingsimpakverslae vir Kommentaar - Kudu Sonkragfasiliteite

**Categories:** This message has been archived by Retain on July 04 2023 07:38

Goeie middag [REDACTED]

Ek het u vroeër vandag probeer skakel namens die Wetenskaplike en Nywerheidsnavorsingsraad (WNNR). Die WNNR is aangestel deur ABO Wind (Edms) Bk as die onafhanklike omgewingskonsultant vir die voorgestelde ontwikkeling van die Kudu Sonkragfasiliteite, geleë naby Petrusville en Philipstown in die Noord-Kaap.

As 'n geïdentifiseerde aangrensende grondeienaar, wil ons u graag herinner dat die publieke deelname periode op 03 Julie 2023 sluit, indien u kommentaar wil lewer op die projekte. U kan u kommentaar rig aan die WNNR Omgewingsbestuursdiense met e-posadres [ems@csir.co.za](mailto:ems@csir.co.za).

U is meer as welkom om my per selfoon [REDACTED] of per e-pos [REDACTED] te kontak indien u enige vrae het of verdere inligting vereis.

Baie dankie  
Helen Antonopoulos (WNNR)

---

## APPENDICES

### ENVIRONMENTAL IMPACT ASSESSMENT REPORT: Scoping and Environmental Impact Assessment (EIA) Process for the Proposed Development of a Solar Photovoltaic (PV) Facility (Kudu Solar Facility 3) and associated infrastructure, near De Aar, Northern Cape Province

---

**From:** EMS <ems@csir.co.za>  
**Sent:** Monday, 26 June 2023 14:55  
**To:** EMS  
**Cc:** [REDACTED]  
**Subject:** RE: Herinnering van die Beskikbaarheid van die Konsep Omgewingsimpakverslae vir Kommentaar - Kudu Sonkragfasiliteite

**Categories:** This message has been archived by Retain on July 04 2023 07:38

Goeie middag [REDACTED]

Ek het u vroeër vandag probeer skakel namens die Wetenskaplike en Nywerheidsnavorsingsraad (WNNR). Die WNNR is aangestel deur ABO Wind (Edms) Bk as die onafhanklike omgewingskonsultant vir die voorgestelde ontwikkeling van die Kudu Sonkragfasiliteite, geleë naby Petrusville en Philipstown in die Noord-Kaap.

As 'n geïdentifiseerde aangrensende grondeienaar, wil ons u graag herinner dat die publieke deelname periode op 03 Julie 2023 sluit, indien u kommentaar wil lewer op die projekte. U kan u kommentaar rig aan die WNNR Omgewingsbestuursdiense met e-posadres [ems@csir.co.za](mailto:ems@csir.co.za).

U is meer as welkom om my per selfoon [REDACTED] of per e-pos [REDACTED] te kontak indien u enige vrae het of verdere inligting vereis.

Baie dankie  
Helen Antonopoulos (WNNR)

---

**From:** EMS <ems@csir.co.za>  
**Sent:** Monday, 26 June 2023 15:03  
**To:** EMS  
**Cc:** [REDACTED]  
**Subject:** RE: Herinnering van die Beskikbaarheid van die Konsep Omgewingsimpakverslae vir Kommentaar - Kudu Sonkragfasiliteite

**Categories:** This message has been archived by Retain on July 04 2023 07:38

Goeie middag [REDACTED]

Ek het u vroeër vandag probeer skakel namens die Wetenskaplike en Nywerheidsnavorsingsraad (WNNR). Die WNNR is aangestel deur ABO Wind (Edms) Bk as die onafhanklike omgewingskonsultant vir die voorgestelde ontwikkeling van die Kudu Sonkragfasiliteite, geleë naby Petrusville en Philipstown in die Noord-Kaap.

As 'n geïdentifiseerde aangrensende grondeienaar, wil ons u graag herinner dat die publieke deelname periode op 03 Julie 2023 sluit, indien u kommentaar wil lewer op die projekte. U kan u kommentaar rig aan die WNNR Omgewingsbestuursdiense met e-posadres [ems@csir.co.za](mailto:ems@csir.co.za).

U is meer as welkom om my per selfoon [REDACTED] of per e-pos [REDACTED] te kontak indien u enige vrae het of verdere inligting vereis.

Baie dankie  
Helen Antonopoulos (WNNR)

---

## APPENDICES

### ENVIRONMENTAL IMPACT ASSESSMENT REPORT: Scoping and Environmental Impact Assessment (EIA) Process for the Proposed Development of a Solar Photovoltaic (PV) Facility (Kudu Solar Facility 3) and associated infrastructure, near De Aar, Northern Cape Province

---

**From:** EMS <ems@csir.co.za>  
**Sent:** Monday, 26 June 2023 15:11  
**To:** EMS  
**Cc:** [REDACTED]  
**Subject:** RE: Herinnering van die Beskikbaarheid van die Konsep Omgewingsimpakverslae vir Kommentaar - Kudu Sonkragfasiliteite

**Categories:** This message has been archived by Retain on July 04 2023 07:38

Goeie middag [REDACTED]

Ek het u vroeër vandag probeer skakel namens die Wetenskaplike en Nywerheidsnavorsingsraad (WNNR). Die WNNR is aangestel deur ABO Wind (Edms) Bk as die onafhanklike omgewingskonsultant vir die voorgestelde ontwikkeling van die Kudu Sonkragfasiliteite, geleë naby Petrusville en Philipstown in die Noord-Kaap.

As 'n geïdentifiseerde aangrensende grondeienaar, wil ons u graag herinner dat die publieke deelname periode op 03 Julie 2023 sluit, indien u kommentaar wil lewer op die projekte. U kan u kommentaar rig aan die WNNR Omgewingsbestuursdiense met e-posadres [ems@csir.co.za](mailto:ems@csir.co.za).

U is meer as welkom om my per selfoon [REDACTED] of per e-pos [REDACTED] te kontak indien u enige vrae het of verdere inligting vereis.

Baie dankie  
Helen Antonopoulos (WNNR)

---

**From:** EMS <ems@csir.co.za>  
**Sent:** Monday, 26 June 2023 15:21  
**To:** EMS  
**Cc:** [REDACTED]  
**Subject:** RE: Herinnering van die Beskikbaarheid van die Konsep Omgewingsimpakverslae vir Kommentaar - Kudu Sonkragfasiliteite

**Categories:** This message has been archived by Retain on July 04 2023 07:38

Goeie middag [REDACTED]

Baie dankie dat u my oproep vroeër geneem het. Indien u om kommentaar wil lewer op die twaalf Kudu Sonkragfasiliteite, kan u u kommentaar rig aan die WNNR Omgewingsbestuursdiense met e-posadres [ems@csir.co.za](mailto:ems@csir.co.za) teen Maandag 03 Julie 2023.

U is meer as welkom om my per selfoon [REDACTED] of per e-pos [REDACTED] te kontak indien u enige vrae het of verdere inligting vereis.

Baie dankie  
Helen Antonopoulos (WNNR)

---

## APPENDICES

### ENVIRONMENTAL IMPACT ASSESSMENT REPORT: Scoping and Environmental Impact Assessment (EIA) Process for the Proposed Development of a Solar Photovoltaic (PV) Facility (Kudu Solar Facility 3) and associated infrastructure, near De Aar, Northern Cape Province

---

**From:** EMS <ems@csir.co.za>  
**Sent:** Monday, 26 June 2023 15:28  
**To:** EMS  
**Cc:** [REDACTED]  
**Subject:** RE: Herinnering van die Beskikbaarheid van die Konsep Omgewingsimpakverslae vir Kommentaar - Kudu Sonkragfasiliteite

**Categories:** This message has been archived by Retain on July 04 2023 07:38

Goeie middag [REDACTED]

Ek het u vroeër vandag probeer skakel namens die Wetenskaplike en Nywerheidsnavorsingsraad (WNNR). Die WNNR is aangestel deur ABO Wind (Edms) Bk as die onafhanklike omgewingskonsultant vir die voorgestelde ontwikkeling van die Kudu Sonkragfasiliteite, geleë naby Petrusville en Philipstown in die Noord-Kaap.

As 'n geïdentifiseerde aangrensende grondeienaar, wil ons u graag herinner dat die publieke deelname periode op 03 Julie 2023 sluit, indien u kommentaar wil lewer op die projekte. U kan u kommentaar rig aan die WNNR Omgewingsbestuursdiense met e-posadres [ems@csir.co.za](mailto:ems@csir.co.za).

U is meer as welkom om my per selfoon [REDACTED] of per e-pos [REDACTED] te kontak indien u enige vrae het of verdere inligting vereis.

Baie dankie  
Helen Antonopoulos (WNNR)

---

**From:** EMS <ems@csir.co.za>  
**Sent:** Monday, 26 June 2023 15:35  
**To:** EMS  
**Cc:** [REDACTED]  
**Subject:** RE: Herinnering van die Beskikbaarheid van die Konsep Omgewingsimpakverslae vir Kommentaar - Kudu Sonkragfasiliteite

**Categories:** This message has been archived by Retain on July 04 2023 07:38

Goeie middag [REDACTED]

Die WNNR is aangestel deur ABO Wind (Edms) Bk as die onafhanklike omgewingskonsultant vir die voorgestelde ontwikkeling van die Kudu Sonkragfasiliteite, geleë naby Petrusville en Philipstown in die Noord-Kaap.

As 'n Geïnteresseerde en/of Belanghebbende Party (G&BP), wil ons u graag herinner dat die publieke deelname periode op 03 Julie 2023 sluit, indien u kommentaar wil lewer op die projekte. U kan u kommentaar rig aan die WNNR Omgewingsbestuursdiense met e-posadres [ems@csir.co.za](mailto:ems@csir.co.za).

U is meer as welkom om my per selfoon [REDACTED] of per e-pos [REDACTED] te kontak indien u enige vrae het of verdere inligting vereis.

Baie dankie  
Helen Antonopoulos (WNNR)

---

## APPENDICES

ENVIRONMENTAL IMPACT ASSESSMENT REPORT: Scoping and Environmental Impact Assessment (EIA) Process for the Proposed Development of a Solar Photovoltaic (PV) Facility (Kudu Solar Facility 3) and associated infrastructure, near De Aar, Northern Cape Province

---

**From:** EMS <ems@csir.co.za>  
**Sent:** Wednesday, 28 June 2023 12:06  
**To:** EMS  
**Cc:** [REDACTED]  
**Subject:** RE: Herinnering van die Besikbaarheid van die Konsep Omgewingsimpakverslae vir  
Kommentaar - Kudu Sonkragfasiliteite

Goeie middag [REDACTED]

Dankie dat u my oproep vroeër geneem het. Indien u om kommentaar wil lewer op die twaalf Kudu Sonkragfasiliteite, kan u u kommentaar rig aan die WNNR Omgewingsbestuursdiense met e-posadres [ems@csir.co.za](mailto:ems@csir.co.za) teen Maandag 03 Julie 2023.

Baie dankie  
Helen Antonopoulos

---

## APPENDICES

### ENVIRONMENTAL IMPACT ASSESSMENT REPORT: Scoping and Environmental Impact Assessment (EIA) Process for the Proposed Development of a Solar Photovoltaic (PV) Facility (Kudu Solar Facility 3) and associated infrastructure, near De Aar, Northern Cape Province

#### 13. Proof of Delivery of Personalised Reminder Email sent to key I&APs, Stakeholders and Organs of State (as determined by the DFFE) between 21 and 27 June 2023

EMS - Delivery Receipts						By Date ▾ ↑
From	Subject	Received ▾	Size	Categories	Mention	
Mail D...	Relayed: Reminder of the Availability of Draft EIA ...	Wed 21 Jun 2023 1...	73 KB	This me...		[You don't often get email from mailer-daemon@pta-smg4.csir.co.za. Learn why this is important at https://aka.ms/LearnAboutSenderIdentification ] This is
Micros...	Delivered: RE: Reminder of the Availability of Draf...	Wed 21 Jun 2023 1...	174 KB	This me...		Your message has been delivered to the following recipients:
Mmbo...	Not read: Reminder of the Availability of Draft EI...	Wed 21 Jun 2023 1...	50 KB	This me...		You don't often get email from mmboneni.mutheiwana@dmre.gov.za. Learn why this is important
postm...	Delivered: [EXTERNAL]RE: Reminder - Availability ...	Wed 21 Jun 2023 1...	145 KB	This me...		You don't often get email from postmaster@daerl.co.za. Learn why this is important <https://aka.ms/LearnAboutSenderIdentification>
Mail D...	Relayed: Reminder - Availability of Draft EIA Repo...	Wed 21 Jun 2023 1...	81 KB	This me...		This is the mail system at host pta-smg1.csir.co.za. Your message was successfully delivered to the destination(s) listed below. If the message was
Mail D...	Relayed: Reminder - Availability of Draft EIA Repo...	Wed 21 Jun 2023 1...	77 KB	This me...		[You don't often get email from mailer-daemon@pta-smg4.csir.co.za. Learn why this is important at https://aka.ms/LearnAboutSenderIdentification ] This is
Micros...	Delivered: RE: Reminder - Availability of Draft EIA ...	Wed 21 Jun 2023 1...	124 KB	This me...		Your message has been delivered to the following recipients:
admin-...	Undeliverable: RE: Reminder - Availability of Draf...	Wed 21 Jun 2023 1...	94 KB	This me...		You don't often get email from admin-postmaster@dwa.gov.za. Learn why this is important <https://aka.ms/LearnAboutSenderIdentification>
Mail D...	Undeliverable: Reminder - Availability of Draft EIA...	Wed 21 Jun 2023 1...	38 KB	This me...		[You don't often get email from mailer-daemon@pta-smg3.csir.co.za. Learn why this is important at https://aka.ms/LearnAboutSenderIdentification ] This is
Mail D...	Undeliverable: Reminder - Availability of Draft EIA...	Wed 21 Jun 2023 1...	39 KB	This me...		[You don't often get email from mailer-daemon@pta-smg3.csir.co.za. Learn why this is important at https://aka.ms/LearnAboutSenderIdentification ] This is
post...	Undeliverable: RE: Reminder of the Availabilit...	Fri 23 Jun 2023 1...	236 KB	This m...		Delivery has failed to these recipients or groups:
postm...	Delivered: RE: Date and Location of Public Partici...	Fri 23 Jun 2023 14:...	135 KB	This me...		You don't often get email from postmaster@africoainvestments.co.za. Learn why this is important
Micro...	Delivered: RE: Date and Location of Public Par...	Fri 23 Jun 2023 1...	52 KB	This m...		Your message has been delivered to the following recipients:
Micro...	Delivered: RE: Date and Location of Public Par...	Fri 23 Jun 2023 1...	51 KB	This m...		Your message has been delivered to the following recipients:
Mail ...	Relayed: Reminder of the Availability of Draf...	Fri 23 Jun 2023 1...	68 KB	This m...		This is the mail system at host pta-smg1.csir.co.za. Your message was successfully delivered to the destination(s) listed below. If the message was
Mail ...	Relayed: Reminder of the Availability of Draf...	Fri 23 Jun 2023 1...	71 KB	This m...		This is the mail system at host pta-smg1.csir.co.za. Your message was successfully delivered to the destination(s) listed below. If the message was
Micros...	Delivered: RE: Reminder of the Availability of Draf...	Fri 23 Jun 2023 11:...	459 KB	This me...		Your message has been delivered to the following recipients:
postm...	Delivered: RE: Reminder of the Availability of Draf...	Fri 23 Jun 2023 10:...	169 KB	This me...		You don't often get email from postmaster@birdlife.org.za. Learn why this is important <https://aka.ms/LearnAboutSenderIdentification>
post...	Delivered: RE: Reminder of the Availability of ...	Fri 23 Jun 2023 1...	160 KB	This m...		You don't often get email from postmaster@birdlife.org.za. Learn why this is important <https://aka.ms/LearnAboutSenderIdentification>
post...	Delivered: RE: Reminder of the Availability of ...	Fri 23 Jun 2023 1...	161 KB	This m...		You don't often get email from postmaster@birdlife.org.za. Learn why this is important <https://aka.ms/LearnAboutSenderIdentification>
Micros...	Delivered: RE: Reminder of the Availability of Draf...	Fri 23 Jun 2023 10:...	234 KB	This me...		Your message has been delivered to the following recipients:
Micros...	Delivered: RE: Kudu solar facilities 1-12 Northern ...	Fri 23 Jun 2023 10:...	60 KB	This me...		Your message has been delivered to the following recipients:
post...	Delivered: RE: Reminder of the Availability of ...	Thu 22 Jun 2023 ...	131 KB	This m...		You don't often get email from postmaster@outlook.com. Learn why this is important <https://aka.ms/LearnAboutSenderIdentification>



## APPENDICES

### ENVIRONMENTAL IMPACT ASSESSMENT REPORT: Scoping and Environmental Impact Assessment (EIA) Process for the Proposed Development of a Solar Photovoltaic (PV) Facility (Kudu Solar Facility 3) and associated infrastructure, near De Aar, Northern Cape Province

EMS - Delivery Receipts						By Date <span style="font-size: small;">v</span> <span style="font-size: small;">↑</span>			
				From	Subject	Received <span style="font-size: small;">v</span>	Size	Categories	Mention
				post...	<b>Undeliverable: RE: Reminder of the Availabilit...</b>	Thu 22 Jun 2023 ...	233 KB	This m...	
Delivery has failed to these recipients or groups:									
				post...	<b>Undeliverable: RE: Reminder of the Availabilit...</b>	Thu 22 Jun 2023 ...	238 KB	This m...	
Delivery has failed to these recipients or groups:									
				Mail D...	Relayed: Reminder of the Availability of Draft EIA ...	Thu 22 Jun 2023 1...	72 KB	This me...	
[You don't often get email from mailer-daemon@pta-smg3.csir.co.za. Learn why this is important at <a href="https://aka.ms/LearnAboutSenderIdentification">https://aka.ms/LearnAboutSenderIdentification</a> ] This is									
				post...	<b>Delivered: RE: Reminder of the Availability of ...</b>	Thu 22 Jun 2023 ...	137 KB	This m...	
You don't often get email from postmaster@wessa.co.za. Learn why this is important < <a href="https://aka.ms/LearnAboutSenderIdentification">https://aka.ms/LearnAboutSenderIdentification</a> >									
				Mail ...	<b>Undeliverable: Reminder of the Availability of...</b>	Thu 22 Jun 2023 ...	36 KB	This m...	
[You don't often get email from mailer-daemon@pta-smg3.csir.co.za. Learn why this is important at <a href="https://aka.ms/LearnAboutSenderIdentification">https://aka.ms/LearnAboutSenderIdentification</a> ] This is									
				Mail ...	<b>Relayed: Reminder of the Availability of Draft...</b>	Thu 22 Jun 2023 ...	69 KB	This m...	
[You don't often get email from mailer-daemon@pta-smg2.csir.co.za. Learn why this is important at <a href="https://aka.ms/LearnAboutSenderIdentification">https://aka.ms/LearnAboutSenderIdentification</a> ] This is									
				Mail ...	<b>Relayed: Reminder of the Availability of Draft...</b>	Thu 22 Jun 2023 ...	68 KB	This m...	
[You don't often get email from mailer-daemon@pta-smg4.csir.co.za. Learn why this is important at <a href="https://aka.ms/LearnAboutSenderIdentification">https://aka.ms/LearnAboutSenderIdentification</a> ] This is									
				Mail ...	<b>Relayed: Reminder of the Availability of Draft...</b>	Thu 22 Jun 2023 ...	79 KB	This m...	
[You don't often get email from mailer-daemon@hostserv.co.za. Learn why this is important at <a href="https://aka.ms/LearnAboutSenderIdentification">https://aka.ms/LearnAboutSenderIdentification</a> ]									
				post...	<b>Delivered: RE: Reminder of the Availability of ...</b>	Thu 22 Jun 2023 ...	140 KB	This m...	
You don't often get email from postmaster@birdlife.org.za. Learn why this is important < <a href="https://aka.ms/LearnAboutSenderIdentification">https://aka.ms/LearnAboutSenderIdentification</a> >									
				post...	<b>Delivered: RE: Reminder of the Availability of ...</b>	Thu 22 Jun 2023 ...	139 KB	This m...	
You don't often get email from postmaster@birdlife.org.za. Learn why this is important < <a href="https://aka.ms/LearnAboutSenderIdentification">https://aka.ms/LearnAboutSenderIdentification</a> >									
				post...	<b>Delivered: RE: Reminder of the Availability of ...</b>	Thu 22 Jun 2023 ...	140 KB	This m...	
You don't often get email from postmaster@birdlife.org.za. Learn why this is important < <a href="https://aka.ms/LearnAboutSenderIdentification">https://aka.ms/LearnAboutSenderIdentification</a> >									
				Mail D...	Relayed: Reminder of the Availability of Draft EIA ...	Thu 22 Jun 2023 1...	74 KB	This me...	
[You don't often get email from mailer-daemon@pta-smg4.csir.co.za. Learn why this is important at <a href="https://aka.ms/LearnAboutSenderIdentification">https://aka.ms/LearnAboutSenderIdentification</a> ] This is									
				Mail ...	<b>Relayed: Reminder of the Availability of Draft...</b>	Thu 22 Jun 2023 ...	75 KB	This m...	
This is the mail system at host pta-smg1.csir.co.za. Your message was successfully delivered to the destination(s) listed below. If the message was									
				Mail D...	Relayed: Reminder of the Availability of Draft EIA ...	Thu 22 Jun 2023 1...	79 KB	This me...	
[You don't often get email from mailer-daemon@pta-smg3.csir.co.za. Learn why this is important at <a href="https://aka.ms/LearnAboutSenderIdentification">https://aka.ms/LearnAboutSenderIdentification</a> ] This is									
				Mail D...	Undeliverable: Reminder of the Availability of Dra...	Thu 22 Jun 2023 1...	36 KB	This me...	
[You don't often get email from mailer-daemon@pta-smg3.csir.co.za. Learn why this is important at <a href="https://aka.ms/LearnAboutSenderIdentification">https://aka.ms/LearnAboutSenderIdentification</a> ] This is									
				Mail D...	Relayed: Reminder of the Availability of Draft EIA ...	Thu 22 Jun 2023 1...	87 KB	This me...	
This is the mail system at host pta-smg1.csir.co.za. Your message was successfully delivered to the destination(s) listed below. If the message was									
				Mail ...	<b>Undeliverable: Reminder of the Availability of...</b>	Thu 22 Jun 2023 ...	34 KB	This m...	
This is the mail system at host pta-smg1.csir.co.za. I'm sorry to have to inform you that your message could not be delivered to one or more recipients.									
				post...	<b>Delivered: RE: Reminder of the Availability of ...</b>	Thu 22 Jun 2023 ...	134 KB	This m...	
You don't often get email from postmaster@outlook.com. Learn why this is important < <a href="https://aka.ms/LearnAboutSenderIdentification">https://aka.ms/LearnAboutSenderIdentification</a> >									
				Mail ...	<b>Relayed: Reminder of the Availability of Draft...</b>	Thu 22 Jun 2023 ...	71 KB	This m...	
[You don't often get email from mailer-daemon@pta-smg4.csir.co.za. Learn why this is important at <a href="https://aka.ms/LearnAboutSenderIdentification">https://aka.ms/LearnAboutSenderIdentification</a> ] This is									
				post...	<b>Delivered: RE: Reminder of the Availability of ...</b>	Thu 22 Jun 2023 ...	138 KB	This m...	
You don't often get email from postmaster@agrink.co.za. Learn why this is important < <a href="https://aka.ms/LearnAboutSenderIdentification">https://aka.ms/LearnAboutSenderIdentification</a> >									
				post...	<b>Delivered: RE: Reminder of the Availability of ...</b>	Thu 22 Jun 2023 ...	138 KB	This m...	
You don't often get email from postmaster@agrink.co.za. Learn why this is important < <a href="https://aka.ms/LearnAboutSenderIdentification">https://aka.ms/LearnAboutSenderIdentification</a> >									
				post...	<b>Delivered: RE: Reminder of the Availability of ...</b>	Thu 22 Jun 2023 ...	139 KB	This m...	
Your message has been delivered to the following recipients:									
				Mail ...	<b>Relayed: Reminder of the Availability of Draft...</b>	Thu 22 Jun 2023 ...	74 KB	This m...	
[You don't often get email from mailer-daemon@pta-smg2.csir.co.za. Learn why this is important at <a href="https://aka.ms/LearnAboutSenderIdentification">https://aka.ms/LearnAboutSenderIdentification</a> ] This is									
				post...	<b>Delivered: RE: Reminder of the Availability of ...</b>	Thu 22 Jun 2023 ...	130 KB	This m...	
You don't often get email from postmaster@outlook.com. Learn why this is important < <a href="https://aka.ms/LearnAboutSenderIdentification">https://aka.ms/LearnAboutSenderIdentification</a> >									
				Mail D...	Relayed: Reminder of the Availability of Draft EIA ...	Thu 22 Jun 2023 1...	75 KB	This me...	
[You don't often get email from mailer-daemon@pta-smg2.csir.co.za. Learn why this is important at <a href="https://aka.ms/LearnAboutSenderIdentification">https://aka.ms/LearnAboutSenderIdentification</a> ] This is									
				Mail ...	<b>Undeliverable: Reminder of the Availability of...</b>	Thu 22 Jun 2023 ...	30 KB	This m...	
[You don't often get email from mailer-daemon@pta-smg4.csir.co.za. Learn why this is important at <a href="https://aka.ms/LearnAboutSenderIdentification">https://aka.ms/LearnAboutSenderIdentification</a> ] This is									

## APPENDICES

### ENVIRONMENTAL IMPACT ASSESSMENT REPORT: Scoping and Environmental Impact Assessment (EIA) Process for the Proposed Development of a Solar Photovoltaic (PV) Facility (Kudu Solar Facility 3) and associated infrastructure, near De Aar, Northern Cape Province

EMS - Delivery Receipts						By Date ▾ ↑
From	Subject	Received ▾	Size	Categories	Mention	
	<b>Mail ... Relayed: Reminder of the Availability of Draft...</b> Thu 22 Jun 2023 ... 77 KB <b>This ...</b>					
	[You don't often get email from mailer-daemon@pta-smg4.csir.co.za. Learn why this is important at <a href="https://aka.ms/LearnAboutSenderIdentification">https://aka.ms/LearnAboutSenderIdentification</a> ] This is					
	postm... Delivered: RE: Reminder of the Availability of Draf... Thu 22 Jun 2023 1... 141 KB This me...					
	Your message has been delivered to the following recipients:					
	<b>Mail ... Undeliverable: Reminder of the Availability of...</b> Thu 22 Jun 2023 ... 38 KB <b>This m...</b>					
	[You don't often get email from mailer-daemon@mx1.dot.gov.za. Learn why this is important at <a href="https://aka.ms/LearnAboutSenderIdentification">https://aka.ms/LearnAboutSenderIdentification</a> ]					
	Mail D... Relayed: Reminder of the Availability of Draft EIA ... Thu 22 Jun 2023 1... 79 KB This me...					
	[You don't often get email from mailer-daemon@pta-smg2.csir.co.za. Learn why this is important at <a href="https://aka.ms/LearnAboutSenderIdentification">https://aka.ms/LearnAboutSenderIdentification</a> ] This is					
	Mail D... Relayed: Reminder of the Availability of Draft EIA ... Thu 22 Jun 2023 1... 75 KB This me...					
	This is the mail system at host pta-smg1.csir.co.za. Your message was successfully delivered to the destination(s) listed below. If the message was					
	Mail D... Relayed: Renewable Energy Applications: Outstan... Wed 28 Jun 2023 1... 66 KB					
	[You don't often get email from mailer-daemon@pta-smg3.csir.co.za. Learn why this is important at <a href="https://aka.ms/LearnAboutSenderIdentification">https://aka.ms/LearnAboutSenderIdentification</a> ] This is					
	<b>Mail ... Relayed: Herinnering van die Besikbaarheid ...</b> Wed 28 Jun 2023 ... 64 KB					
	[You don't often get email from mailer-daemon@pta-smg2.csir.co.za. Learn why this is important at <a href="https://aka.ms/LearnAboutSenderIdentification">https://aka.ms/LearnAboutSenderIdentification</a> ] This is					
	Micro... Delivered: RE: Herinnering van die Besikbaarheid... Wed 28 Jun 2023 1... 98 KB					
	Your message has been delivered to the following recipients:					
	Mail D... Undeliverable: Reminder of the Availability of Dra... Tue 27 Jun 2023 1... 29 KB					
	[You don't often get email from mailer-daemon@pta-smg3.csir.co.za. Learn why this is important at <a href="https://aka.ms/LearnAboutSenderIdentification">https://aka.ms/LearnAboutSenderIdentification</a> ] This is					
	<b>Micro... Delivered: RE: Kudu solar facilities 1-12 North...</b> Tue 27 Jun 2023 ... 62 KB					
	Your message has been delivered to the following recipients:					
	<b>Mail ... Relayed: Availability of Draft EIA Reports for ...</b> Tue 27 Jun 2023 ... 75 KB					
	This is the mail system at host pta-smg1.csir.co.za. Your message was successfully delivered to the destination(s) listed below. If the message was					
	<b>Micro... Delivered: RE: Availability of Draft EIA Report...</b> Tue 27 Jun 2023 ... 145 KB					
	Your message has been delivered to the following recipients:					
	<b>post... Delivered: RE: Letters for Comments - Kudu S...</b> Tue 27 Jun 2023 ... 146 KB					
	You don't often get email from postmaster@dws.gov.za. Learn why this is important < <a href="https://aka.ms/LearnAboutSenderIdentification">https://aka.ms/LearnAboutSenderIdentification</a> >					
	<b>post... Delivered: RE: Letters for Comments - Kudu S...</b> Tue 27 Jun 2023 ... 145 KB					
	You don't often get email from postmaster@dws.gov.za. Learn why this is important < <a href="https://aka.ms/LearnAboutSenderIdentification">https://aka.ms/LearnAboutSenderIdentification</a> >					
	<b>post... Delivered: RE: Letters for Comments - Kudu S...</b> Tue 27 Jun 2023 ... 142 KB					
	You don't often get email from postmaster@dws.gov.za. Learn why this is important < <a href="https://aka.ms/LearnAboutSenderIdentification">https://aka.ms/LearnAboutSenderIdentification</a> >					
	<b>Micro... Delivered: RE: Letters for Comments - Kudu S...</b> Tue 27 Jun 2023 ... 211 KB					
	Your message has been delivered to the following recipients:					
	Mail D... Undeliverable: Reminder of the Availability of Dra... Mon 26 Jun 2023 1... 29 KB This me...					
	[You don't often get email from mailer-daemon@pta-smg4.csir.co.za. Learn why this is important at <a href="https://aka.ms/LearnAboutSenderIdentification">https://aka.ms/LearnAboutSenderIdentification</a> ] This is					
	Mail D... Undeliverable: Reminder of the Availability of Dra... Mon 26 Jun 2023 1... 30 KB This me...					
	[You don't often get email from mailer-daemon@pta-smg4.csir.co.za. Learn why this is important at <a href="https://aka.ms/LearnAboutSenderIdentification">https://aka.ms/LearnAboutSenderIdentification</a> ] This is					
	Mail D... Relayed: Reminder of the Availability of Draft EIA ... Mon 26 Jun 2023 1... 66 KB This me...					
	This is the mail system at host pta-smg1.csir.co.za. Your message was successfully delivered to the destination(s) listed below. If the message was					
	<b>Micro... Delivered: RE: Reminder of the Availability of ...</b> Mon 26 Jun 2023 ... 98 KB <b>This m...</b>					
	Your message has been delivered to the following recipients:					
	<b>Mail ... Relayed: Herinnering van die Besikbaarheid ...</b> Mon 26 Jun 2023 ... 65 KB <b>This m...</b>					
	This is the mail system at host pta-smg1.csir.co.za. Your message was successfully delivered to the destination(s) listed below. If the message was					
	<b>Micro... Delivered: RE: Herinnering van die Besikbaar...</b> Mon 26 Jun 2023 ... 99 KB <b>This m...</b>					
	Your message has been delivered to the following recipients:					
	<b>Mail ... Undeliverable: Herinnering van die Besikbaar...</b> Mon 26 Jun 2023 ... 29 KB <b>This m...</b>					
	[You don't often get email from mailer-daemon@pta-smg2.csir.co.za. Learn why this is important at <a href="https://aka.ms/LearnAboutSenderIdentification">https://aka.ms/LearnAboutSenderIdentification</a> ] This is					
	<b>Mail ... Relayed: Herinnering van die Besikbaarheid ...</b> Mon 26 Jun 2023 ... 66 KB <b>This m...</b>					
	[You don't often get email from mailer-daemon@pta-smg2.csir.co.za. Learn why this is important at <a href="https://aka.ms/LearnAboutSenderIdentification">https://aka.ms/LearnAboutSenderIdentification</a> ] This is					

## APPENDICES

### ENVIRONMENTAL IMPACT ASSESSMENT REPORT: Scoping and Environmental Impact Assessment (EIA) Process for the Proposed Development of a Solar Photovoltaic (PV) Facility (Kudu Solar Facility 3) and associated infrastructure, near De Aar, Northern Cape Province

EMS - Delivery Receipts						By Date <span style="font-size: small;">v</span> <span style="font-size: small;">↑</span>
From	Subject	Received	Size	Categories	Mention	
	<b>Micro... Delivered: RE: Herinnering van die Beskikbaar...</b>	Mon 26 Jun 2023 ...	100 KB	This m...		
Your message has been delivered to the following recipients:						
	<b>Mail ... Relayed: Herinnering van die Beskikbaarheid ...</b>	Mon 26 Jun 2023 ...	65 KB	This m...		
[You don't often get email from mailer-daemon@pta-smg3.csir.co.za. Learn why this is important at <a href="https://aka.ms/LearnAboutSenderIdentification">https://aka.ms/LearnAboutSenderIdentification</a> ] This is						
	<b>Micro... Delivered: RE: Herinnering van die Beskikbaar...</b>	Mon 26 Jun 2023 ...	99 KB	This m...		
Your message has been delivered to the following recipients:						
	<b>post... Delivered: RE: Herinnering van die Beskikbaar...</b>	Mon 26 Jun 2023 ...	130 KB	This m...		
You don't often get email from postmaster@outlook.com. Learn why this is important < <a href="https://aka.ms/LearnAboutSenderIdentification">https://aka.ms/LearnAboutSenderIdentification</a> >						
	<b>Micro... Delivered: RE: Herinnering van die Beskikbaar...</b>	Mon 26 Jun 2023 ...	99 KB	This m...		
Your message has been delivered to the following recipients:						
	<b>Mail ... Relayed: Herinnering van die Beskikbaarheid ...</b>	Mon 26 Jun 2023 ...	65 KB	This m...		
[You don't often get email from mailer-daemon@pta-smg3.csir.co.za. Learn why this is important at <a href="https://aka.ms/LearnAboutSenderIdentification">https://aka.ms/LearnAboutSenderIdentification</a> ] This is						
	<b>Micro... Delivered: RE: Herinnering van die Beskikbaar...</b>	Mon 26 Jun 2023 ...	99 KB	This m...		
Your message has been delivered to the following recipients:						
	<b>Mail ... Relayed: Herinnering van die Beskikbaarheid ...</b>	Mon 26 Jun 2023 ...	65 KB	This m...		
[You don't often get email from mailer-daemon@pta-smg3.csir.co.za. Learn why this is important at <a href="https://aka.ms/LearnAboutSenderIdentification">https://aka.ms/LearnAboutSenderIdentification</a> ] This is						
	<b>Micro... Delivered: RE: Herinnering van die Beskikbaar...</b>	Mon 26 Jun 2023 ...	99 KB	This m...		
Your message has been delivered to the following recipients:						
	<b>Mail ... Relayed: Herinnering van die Beskikbaarheid ...</b>	Mon 26 Jun 2023 ...	65 KB	This m...		
This is the mail system at host pta-smg1.csir.co.za. Your message was successfully delivered to the destination(s) listed below. If the message was						
	<b>Micro... Delivered: RE: Herinnering van die Beskikbaar...</b>	Mon 26 Jun 2023 ...	99 KB	This m...		
Your message has been delivered to the following recipients:						

## APPENDICES

ENVIRONMENTAL IMPACT ASSESSMENT REPORT: Scoping and Environmental Impact Assessment (EIA) Process for the Proposed Development of a Solar Photovoltaic (PV) Facility (Kudu Solar Facility 3) and associated infrastructure, near De Aar, Northern Cape Province

































































### 14. Proof of Telephonic Communication and Communication Attempts with Key Stakeholders and I&APs between 26 and 28 June 2028

#### Telephonic Communication and Communication Attempts via Rainbow Telephony

##### Voicemail

 Sorry but you have no voicemail associated with your account

##### Call History

	 Outgoing	00:05	Jun 28, 2:21 PM		
	 Outgoing	07:27	Jun 28, 12:21 PM		
	 Outgoing		Jun 28, 12:16 PM		
	 Outgoing	01:28	Jun 28, 11:56 AM		
	 Outgoing	04:18	Jun 28, 11:50 AM		
	 Outgoing		Jun 28, 11:46 AM		
	 Outgoing		Jun 28, 11:13 AM		
	 Outgoing		Jun 28, 11:13 AM		
	 Incoming	16:13	Jun 26, 3:50 PM		
	 Outgoing		Jun 26, 3:44 PM		
	 Outgoing	00:07	Jun 26, 3:22 PM		
	 Outgoing	04:28	Jun 26, 3:14 PM		
	 Outgoing	00:08	Jun 26, 2:56 PM		
	 Outgoing		Jun 26, 2:37 PM		
	 Outgoing	00:06	Jun 26, 2:32 PM		
	 Outgoing	00:05	Jun 26, 2:19 PM		

## APPENDICES

ENVIRONMENTAL IMPACT ASSESSMENT REPORT: Scoping and Environmental Impact Assessment (EIA) Process for the Proposed Development of a Solar Photovoltaic (PV) Facility (Kudu Solar Facility 3) and associated infrastructure, near De Aar, Northern Cape Province

---

### Telephonic Communication via Personal Cell Phone

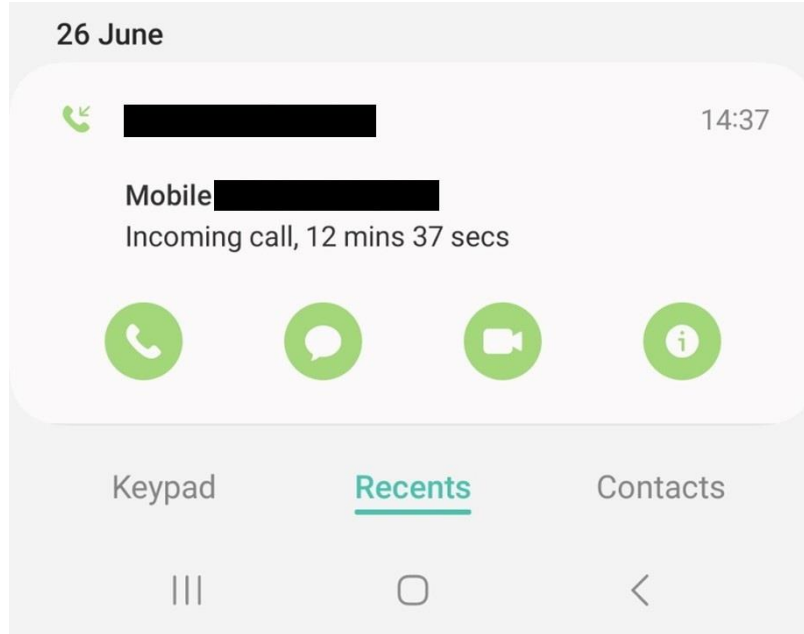

## APPENDICES

### ENVIRONMENTAL IMPACT ASSESSMENT REPORT: Scoping and Environmental Impact Assessment (EIA) Process for the Proposed Development of a Solar Photovoltaic (PV) Facility (Kudu Solar Facility 3) and associated infrastructure, near De Aar, Northern Cape Province

#### Telephonic Communication and Communication Attempts via WhatsApp

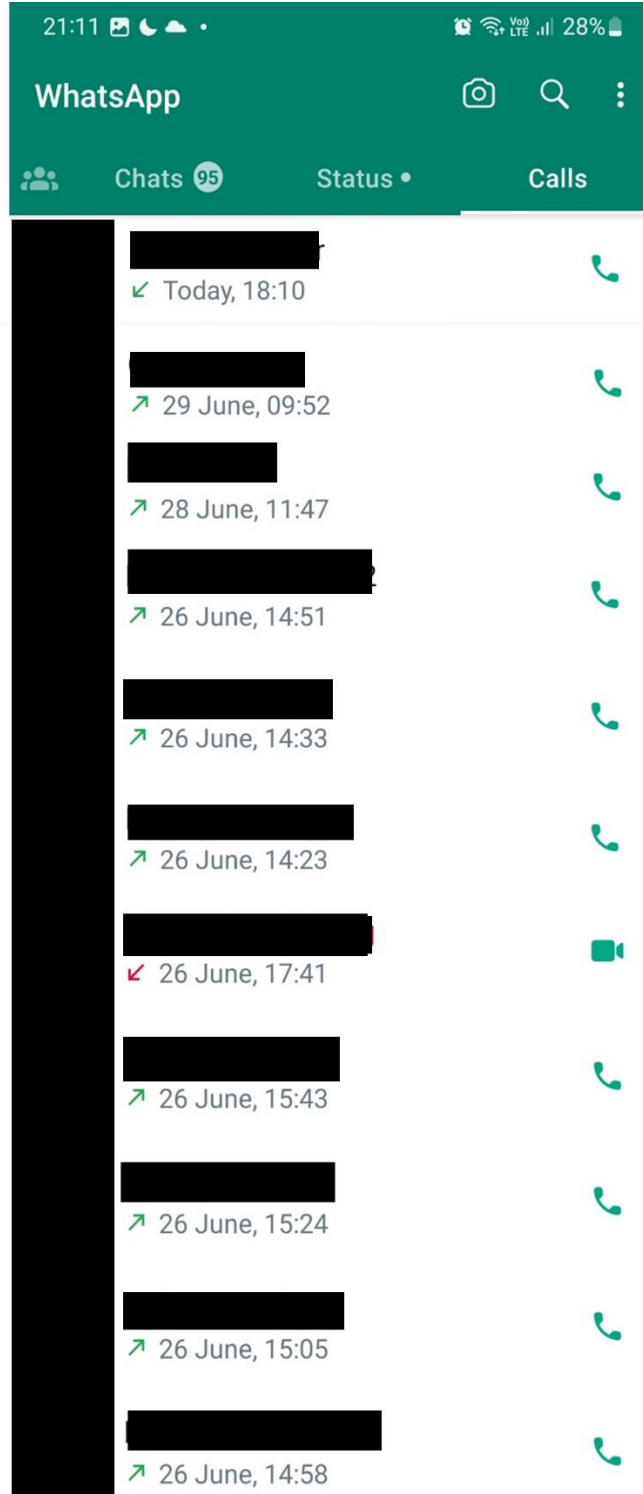

## APPENDICES

ENVIRONMENTAL IMPACT ASSESSMENT REPORT: Scoping and Environmental Impact Assessment (EIA) Process for the Proposed Development of a Solar Photovoltaic (PV) Facility (Kudu Solar Facility 3) and associated infrastructure, near De Aar, Northern Cape Province

### 15. Proof of WhatsApp Communication with Key Stakeholders and I&APs between 26 June and 4 July 2023

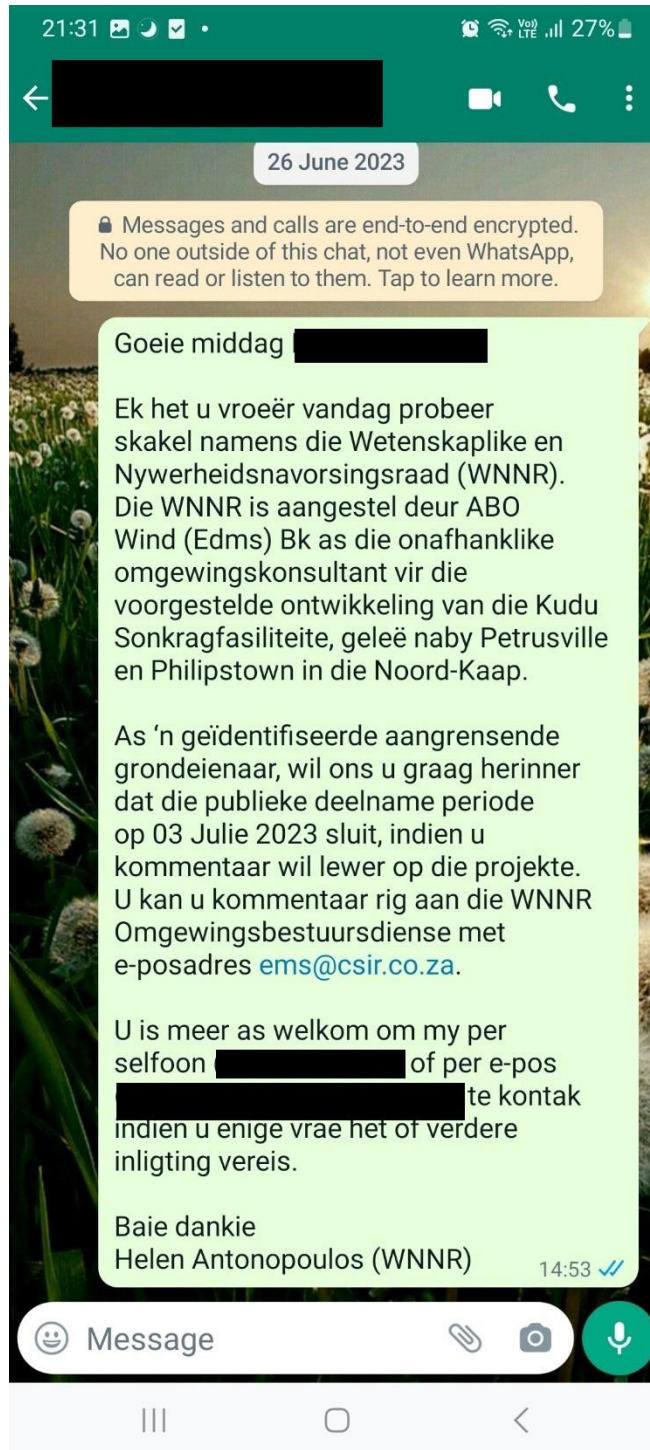

## APPENDICES

### ENVIRONMENTAL IMPACT ASSESSMENT REPORT: Scoping and Environmental Impact Assessment (EIA) Process for the Proposed Development of a Solar Photovoltaic (PV) Facility (Kudu Solar Facility 3) and associated infrastructure, near De Aar, Northern Cape Province





## APPENDICES

### ENVIRONMENTAL IMPACT ASSESSMENT REPORT: Scoping and Environmental Impact Assessment (EIA) Process for the Proposed Development of a Solar Photovoltaic (PV) Facility (Kudu Solar Facility 3) and associated infrastructure, near De Aar, Northern Cape Province



## APPENDICES

### ENVIRONMENTAL IMPACT ASSESSMENT REPORT: Scoping and Environmental Impact Assessment (EIA) Process for the Proposed Development of a Solar Photovoltaic (PV) Facility (Kudu Solar Facility 3) and associated infrastructure, near De Aar, Northern Cape Province

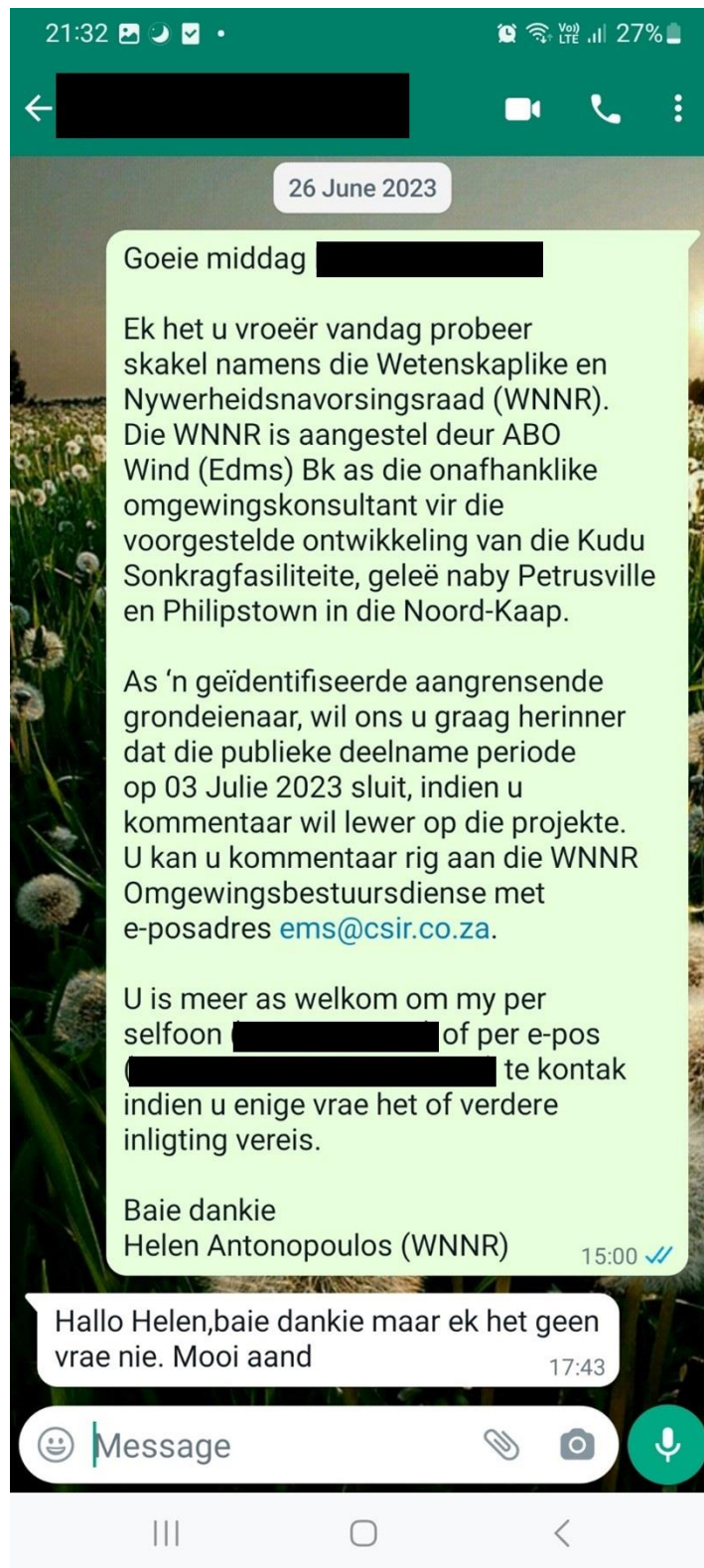

## APPENDICES

### ENVIRONMENTAL IMPACT ASSESSMENT REPORT: Scoping and Environmental Impact Assessment (EIA) Process for the Proposed Development of a Solar Photovoltaic (PV) Facility (Kudu Solar Facility 3) and associated infrastructure, near De Aar, Northern Cape Province

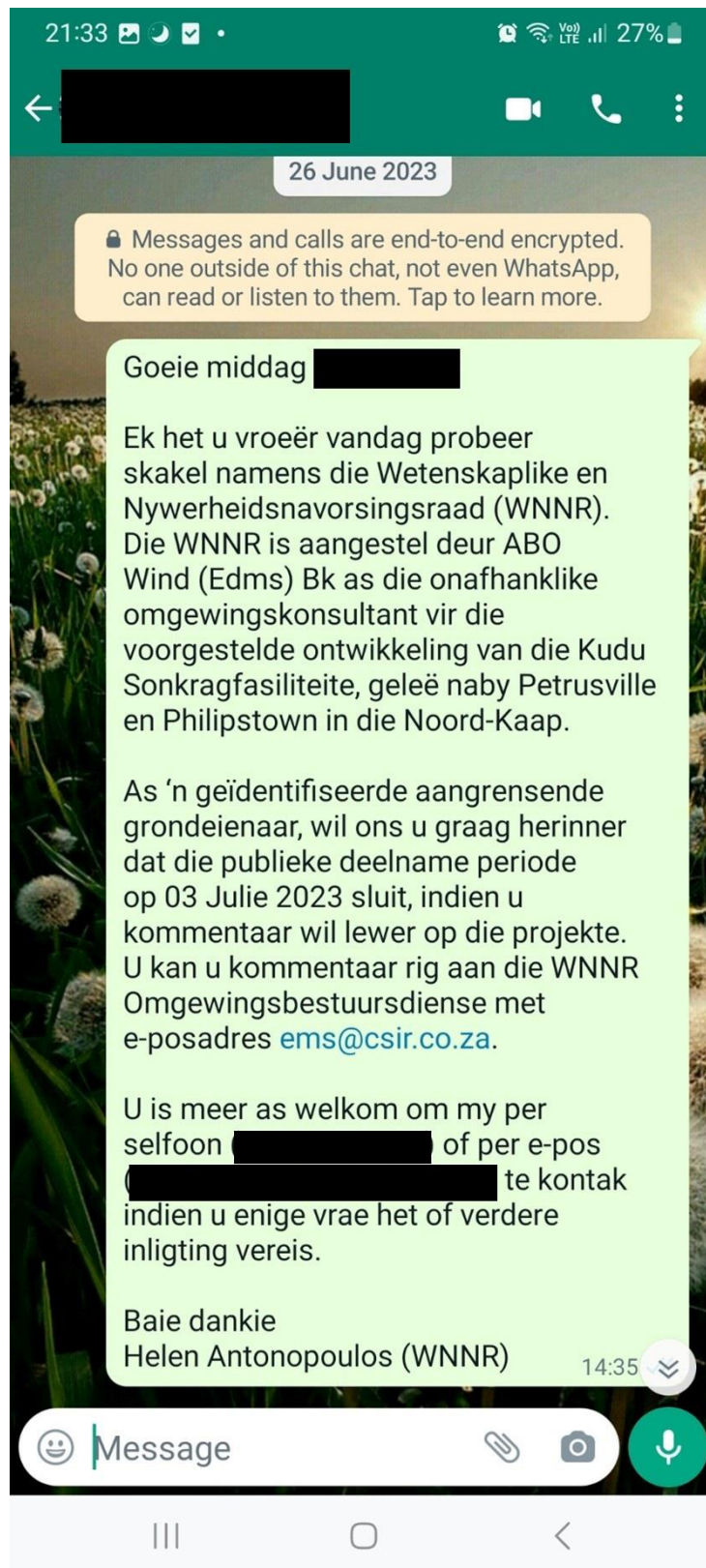

## APPENDICES

### ENVIRONMENTAL IMPACT ASSESSMENT REPORT: Scoping and Environmental Impact Assessment (EIA) Process for the Proposed Development of a Solar Photovoltaic (PV) Facility (Kudu Solar Facility 3) and associated infrastructure, near De Aar, Northern Cape Province



## APPENDICES

### ENVIRONMENTAL IMPACT ASSESSMENT REPORT: Scoping and Environmental Impact Assessment (EIA) Process for the Proposed Development of a Solar Photovoltaic (PV) Facility (Kudu Solar Facility 3) and associated infrastructure, near De Aar, Northern Cape Province



## APPENDICES

ENVIRONMENTAL IMPACT ASSESSMENT REPORT: Scoping and Environmental Impact Assessment (EIA) Process for the Proposed Development of a Solar Photovoltaic (PV) Facility (Kudu Solar Facility 3) and associated infrastructure, near De Aar, Northern Cape Province

### 16. Proof of SMS and Telephonic Communication with a Renosterberg Local Municipality Councillor



## APPENDICES

### ENVIRONMENTAL IMPACT ASSESSMENT REPORT: Scoping and Environmental Impact Assessment (EIA) Process for the Proposed Development of a Solar Photovoltaic (PV) Facility (Kudu Solar Facility 3) and associated infrastructure, near De Aar, Northern Cape Province

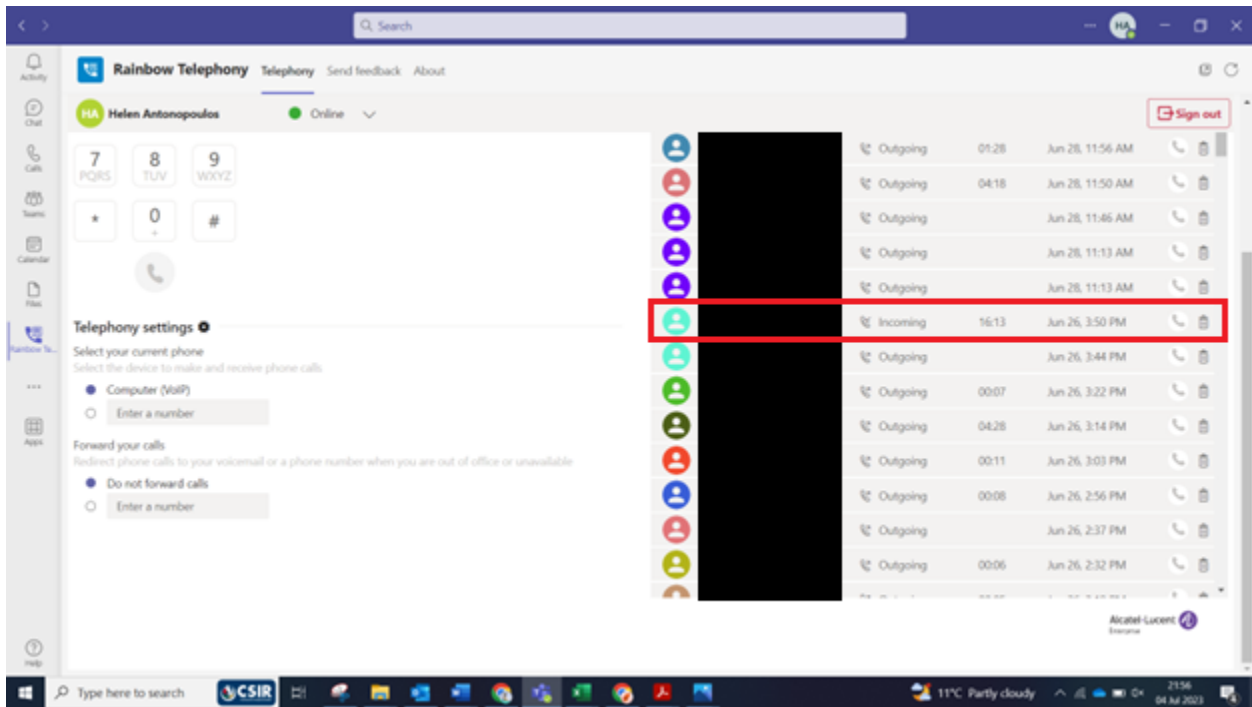

## APPENDICES

ENVIRONMENTAL IMPACT ASSESSMENT REPORT: Scoping and Environmental Impact Assessment (EIA) Process for the Proposed Development of a Solar Photovoltaic (PV) Facility (Kudu Solar Facility 3) and associated infrastructure, near De Aar, Northern Cape Province

---

### 17. Reminder/ Notification of the Closure of Comment Period Email sent to all I&APs, Stakeholders and Organs of State on 3 July 2023

---

**From:** EMS <ems@csir.co.za>  
**Sent:** Monday, 03 July 2023 09:24  
**To:** EMS  
**Subject:** Closure of the Comment Period on the Draft EIA Reports for the Proposed Development of the 12 Kudu Solar Photovoltaic Facilities, near De Aar, Northern Cape

**Bcc:**

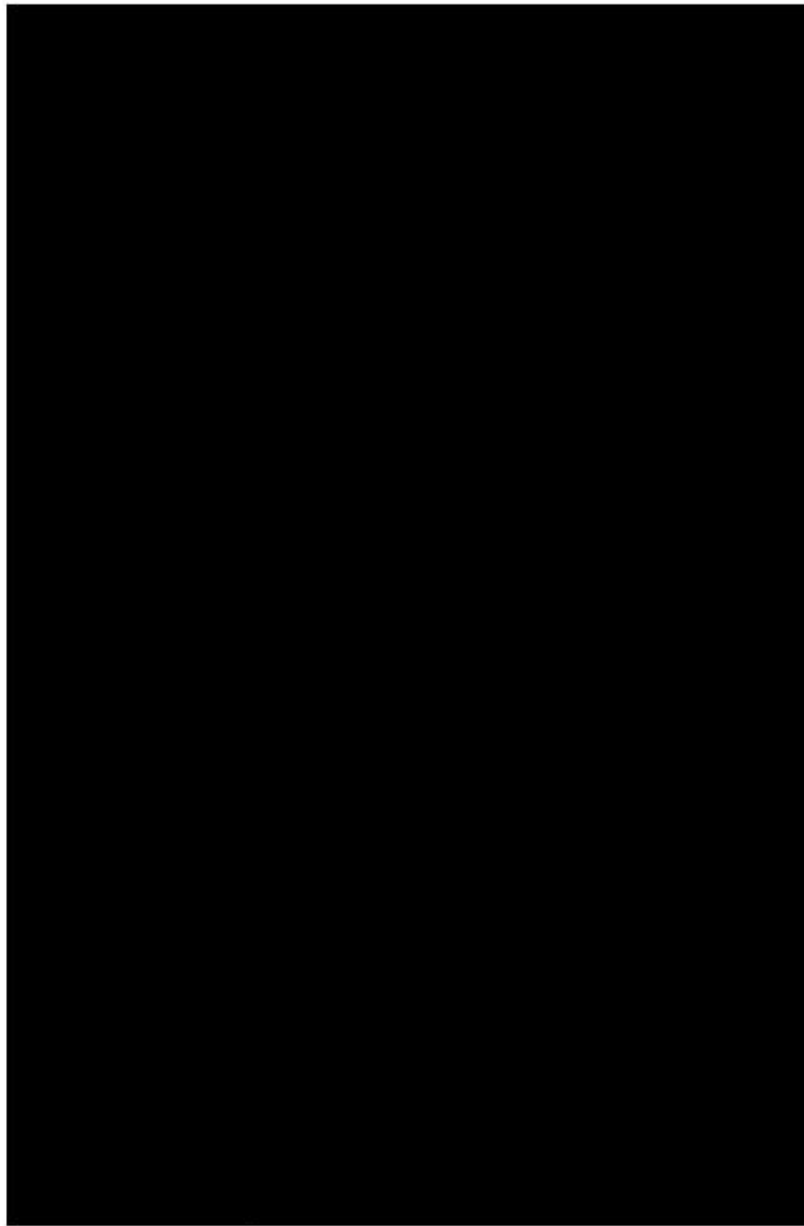



## APPENDICES

ENVIRONMENTAL IMPACT ASSESSMENT REPORT: Scoping and Environmental Impact Assessment (EIA) Process for the Proposed Development of a Solar Photovoltaic (PV) Facility (Kudu Solar Facility 3) and associated infrastructure, near De Aar, Northern Cape Province

---

**Bcc:**

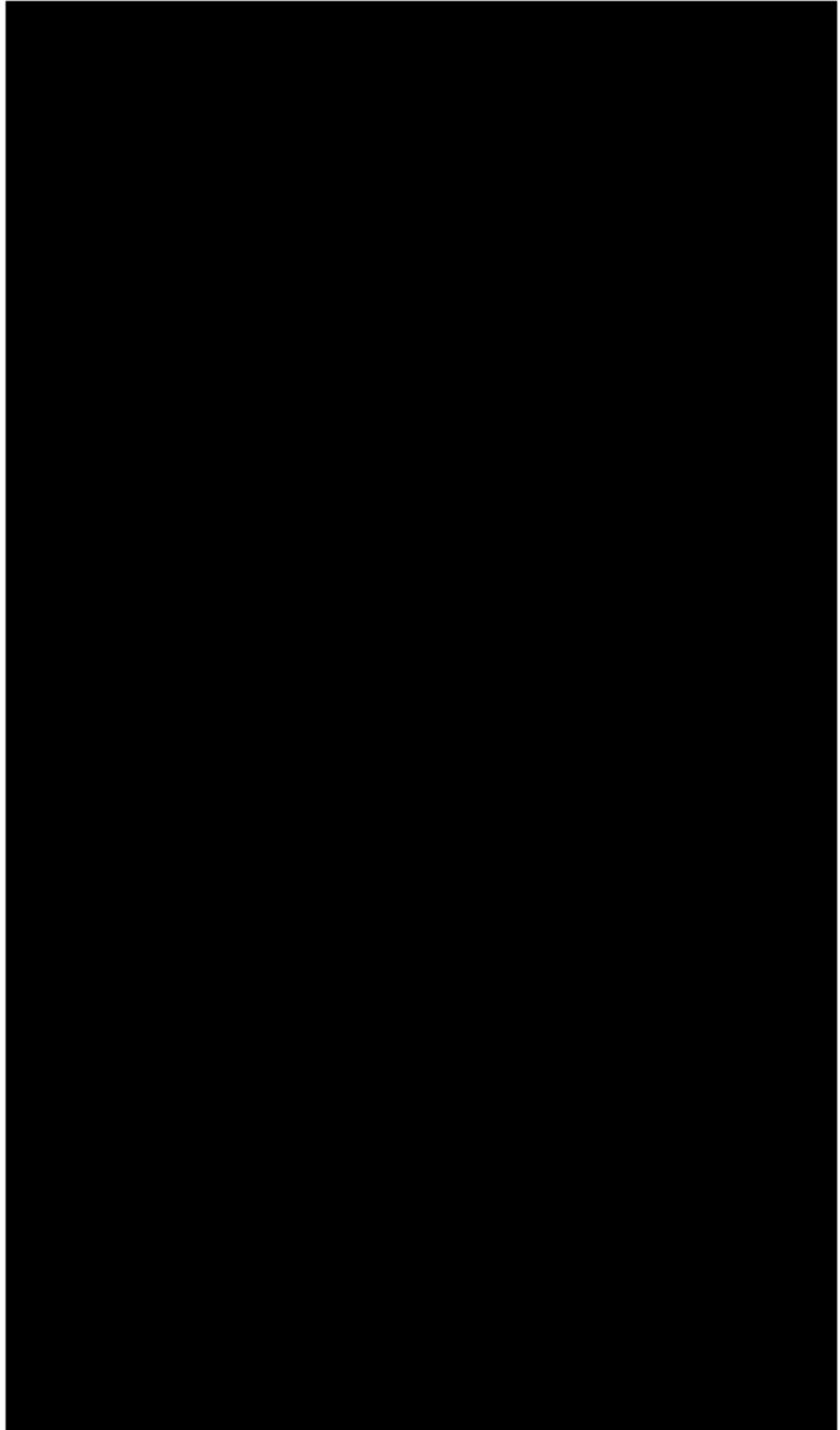

## APPENDICES

ENVIRONMENTAL IMPACT ASSESSMENT REPORT: Scoping and Environmental Impact Assessment (EIA) Process for the Proposed Development of a Solar Photovoltaic (PV) Facility (Kudu Solar Facility 3) and associated infrastructure, near De Aar, Northern Cape Province

---

Dear Interested and Affected Party / Stakeholder,

**RE: CLOSURE OF THE COMMENT PERIOD ON THE DRAFT ENVIRONMENTAL IMPACT ASSESSMENT REPORTS FOR THE PROPOSED DEVELOPMENT 12 SOLAR PHOTOVOLTAIC (PV) FACILITIES (I.E. KUDU SOLAR FACILITIES) AND VARIOUS ASSOCIATED INFRASTRUCTURE, NEAR DE AAR, NORTHERN CAPE**

This serves as a notification that the 30-day public comment period on the Draft Environmental Impact Assessment (EIA) Reports for the proposed 12 Kudu Solar Facilities closes today (i.e., Monday 3 July 2023).

Should you still wish to submit comments on the Draft EIA Reports for the above-mentioned projects, please send your comments in writing to [ems@csir.co.za](mailto:ems@csir.co.za) latest by midnight, Monday 3 July 2023, details are provided below:

The Draft EIA Reports and executive summary can be accessed via the project website at the weblink below:

- <https://www.csir.co.za/environmental-impact-assessment>

The Draft EIA Reports inclusive of all appendices can be accessed via the Google Drive project folder at the weblink below:

- [https://bit.ly/KUDU\\_SOLAR\\_PV](https://bit.ly/KUDU_SOLAR_PV)

Please note that comments or input received after midnight on Monday 3 July 2023 may not be considered.

Note that copies of all comments received from potential and registered I&APs and relevant key stakeholders during the review of the Draft EIA Reports will be incorporated into the Comments and Responses Reports, which will be included separately with the Final EIA Reports. The Final EIA Reports will then be submitted to the DFFE for decision-making in line with Regulation 23(1) (a) (b) of the 2014 NEMA EIA Regulations (as amended).

Please do not hesitate to contact us should you have any queries relating to the above or should you experience difficulties to access the documentation at the links provided above.

Kind Regards,  
Rohaida Abed

CSIR Environmental Management Services  
E-mail: [ems@csir.co.za](mailto:ems@csir.co.za)  
Postal Address: Postnet Suite 367, Private Bag x10, Musgrave Road, 4062  
Tel: 031 242 2300

Disclaimer: In accordance with the Protection of Personal Information Act (Act 4 of 2013), the CSIR will conduct itself responsibly when collecting, processing, storing, and sharing any personal information collected for the purposes of Public Participation Processes (PPP) in terms of the 2014 NEMA EIA Regulations (as amended). By registering as an Interested and Affected Party (I&AP) and/or submitting information and comments, you consent to the collection, collation, processing, and storing of such information and the use and disclosure of such information for the aforementioned purpose (<https://www.csir.co.za/csir-privacy-notice>). If you would like to opt out of communications on this project, please do so by responding to this correspondence via email.

---

## APPENDICES

### ENVIRONMENTAL IMPACT ASSESSMENT REPORT: Scoping and Environmental Impact Assessment (EIA) Process for the Proposed Development of a Solar Photovoltaic (PV) Facility (Kudu Solar Facility 3) and associated infrastructure, near De Aar, Northern Cape Province

#### 18. Proof of Delivery of the Notification of the Closure of the Comment Period Email sent to key I&APs, Stakeholders and Organs of State on 3 July 2023

EMS - Delivery Receipts		By Date ▾ ↑
From	Subject	Received ▾
<b>Today</b>		
postm...	Undeliverable: Closure of the Comment Period o...	Tue 04 Jul 2023 09:... 241 KB
Delivery has failed to these recipients or groups:		
<b>Yesterday</b>		
post...	<b>Delivered: Closure of the Comment Period on ...</b>	<b>Mon 03 Jul 2023 ... 140 KB</b>
You don't often get email from postmaster@outlook.com. Learn why this is important <https://aka.ms/LearnAboutSenderIdentification>		
Mail ...	<b>Relayed: Draft EIA Reports for the Proposed D...</b>	<b>Mon 03 Jul 2023 ... 71 KB</b>
[You don't often get email from mailer-daemon@pta-smg3.csir.co.za. Learn why this is important at https://aka.ms/LearnAboutSenderIdentification ] This is		
Micro...	<b>Delivered: RE: Draft EIA Reports for the Propo...</b>	<b>Mon 03 Jul 2023 ... 184 KB</b>
Your message has been delivered to the following recipients:		
Mail ...	<b>Relayed: Draft EIA Reports for the Proposed D...</b>	<b>Mon 03 Jul 2023 ... 70 KB</b>
This is the mail system at host pta-smg1.csir.co.za. Your message was successfully delivered to the destination(s) listed below. If the message was		
Micro...	<b>Delivered: RE: Draft EIA Reports for the Propo...</b>	<b>Mon 03 Jul 2023 ... 174 KB</b>
Your message has been delivered to the following recipients:		
postm...	Undeliverable: Closure of the Comment Period o...	Mon 03 Jul 2023 0... 201 KB
You don't often get email from postmaster@transnet.net. Learn why this is important <https://aka.ms/LearnAboutSenderIdentification>		
post...	<b>Undeliverable: Closure of the Comment Perio...</b>	<b>Mon 03 Jul 2023 ... 200 KB</b>
You don't often get email from postmaster@transnet.net. Learn why this is important <https://aka.ms/LearnAboutSenderIdentification>		
post...	<b>Delivered: Closure of the Comment Period on ...</b>	<b>Mon 03 Jul 2023 ... 146 KB</b>
Your message has been delivered to the following recipients:		
Mail ...	<b>Undeliverable: Closure of the Comment Perio...</b>	<b>Mon 03 Jul 2023 ... 37 KB</b>
[You don't often get email from mailer-daemon@mx1.dot.gov.za. Learn why this is important at https://aka.ms/LearnAboutSenderIdentification ]		
post...	<b>Undeliverable: Closure of the Comment Perio...</b>	<b>Mon 03 Jul 2023 ... 200 KB</b>
You don't often get email from postmaster@transnet.net. Learn why this is important <https://aka.ms/LearnAboutSenderIdentification>		
Mail ...	<b>Delivered: Closure of the Comment Period on ...</b>	<b>Mon 03 Jul 2023 ... 81 KB</b>
[You don't often get email from mailer-daemon@server.itdesign.co.za. Learn why this is important at https://aka.ms/LearnAboutSenderIdentification ] This		
Mail ...	<b>Relayed: Closure of the Comment Period on t...</b>	<b>Mon 03 Jul 2023 ... 114 KB</b>
[You don't often get email from mailer-daemon@pta-smg3.csir.co.za. Learn why this is important at https://aka.ms/LearnAboutSenderIdentification ] This is		
post...	<b>Delivered: Closure of the Comment Period on ...</b>	<b>Mon 03 Jul 2023 ... 134 KB</b>
You don't often get email from postmaster@weathersa.co.za. Learn why this is important <https://aka.ms/LearnAboutSenderIdentification>		
Mail ...	<b>Undeliverable: Closure of the Comment Perio...</b>	<b>Mon 03 Jul 2023 ... 33 KB</b>
[You don't often get email from mailer-daemon@pta-smg3.csir.co.za. Learn why this is important at https://aka.ms/LearnAboutSenderIdentification ] This is		
post...	<b>Delivered: Closure of the Comment Period on ...</b>	<b>Mon 03 Jul 2023 ... 134 KB</b>
You don't often get email from postmaster@weathersa.co.za. Learn why this is important <https://aka.ms/LearnAboutSenderIdentification>		
post...	<b>Delivered: Closure of the Comment Period on ...</b>	<b>Mon 03 Jul 2023 ... 134 KB</b>
You don't often get email from postmaster@weathersa.co.za. Learn why this is important <https://aka.ms/LearnAboutSenderIdentification>		
post...	<b>Delivered: Closure of the Comment Period on ...</b>	<b>Mon 03 Jul 2023 ... 147 KB</b>
You don't often get email from postmaster@vodafone.com. Learn why this is important <https://aka.ms/LearnAboutSenderIdentification>		
post...	<b>Delivered: Closure of the Comment Period on ...</b>	<b>Mon 03 Jul 2023 ... 147 KB</b>
You don't often get email from postmaster@dws.gov.za. Learn why this is important <https://aka.ms/LearnAboutSenderIdentification>		
admi...	<b>Undeliverable: Closure of the Comment Perio...</b>	<b>Mon 03 Jul 2023 ... 87 KB</b>
You don't often get email from admin-postmaster@dwa.gov.za. Learn why this is important <https://aka.ms/LearnAboutSenderIdentification>		
post...	<b>Delivered: Closure of the Comment Period on ...</b>	<b>Mon 03 Jul 2023 ... 147 KB</b>
You don't often get email from postmaster@vodafone.com. Learn why this is important <https://aka.ms/LearnAboutSenderIdentification>		
post...	<b>Delivered: Closure of the Comment Period on ...</b>	<b>Mon 03 Jul 2023 ... 147 KB</b>
You don't often get email from postmaster@vodafone.com. Learn why this is important <https://aka.ms/LearnAboutSenderIdentification>		
Mail ...	<b>Relayed: Closure of the Comment Period on t...</b>	<b>Mon 03 Jul 2023 ... 111 KB</b>
[You don't often get email from mailer-daemon@pta-smg3.csir.co.za. Learn why this is important at https://aka.ms/LearnAboutSenderIdentification ] This is		
post...	<b>Delivered: Closure of the Comment Period on ...</b>	<b>Mon 03 Jul 2023 ... 147 KB</b>
You don't often get email from postmaster@vodafone.com. Learn why this is important <https://aka.ms/LearnAboutSenderIdentification>		

## APPENDICES

### ENVIRONMENTAL IMPACT ASSESSMENT REPORT: Scoping and Environmental Impact Assessment (EIA) Process for the Proposed Development of a Solar Photovoltaic (PV) Facility (Kudu Solar Facility 3) and associated infrastructure, near De Aar, Northern Cape Province

EMS - Delivery Receipts						By Date <span style="font-size: small;">v</span> <span style="font-size: small;">↑</span>
📧	🔍	📄	📧	📧	📧	📧
From	Subject	Received	Size	Categories	Mention	📧
	<b>Mail ... Relayed: Closure of the Comment Period on t...</b> <b>Mon 03 Jul 2023 ...</b> <b>113 KB</b>					[You don't often get email from mailer-daemon@pta-smg3.csir.co.za. Learn why this is important at <a href="https://aka.ms/LearnAboutSenderIdentification">https://aka.ms/LearnAboutSenderIdentification</a> ] This is
	<b>post... Delivered: Closure of the Comment Period on ...</b> <b>Mon 03 Jul 2023 ...</b> <b>147 KB</b>					You don't often get email from postmaster@vodafone.com. Learn why this is important < <a href="https://aka.ms/LearnAboutSenderIdentification">https://aka.ms/LearnAboutSenderIdentification</a> >
	<b>post... Delivered: Closure of the Comment Period on ...</b> <b>Mon 03 Jul 2023 ...</b> <b>147 KB</b>					You don't often get email from postmaster@vodafone.com. Learn why this is important < <a href="https://aka.ms/LearnAboutSenderIdentification">https://aka.ms/LearnAboutSenderIdentification</a> >
	<b>Mail ... Undeliverable: Closure of the Comment Perio...</b> <b>Mon 03 Jul 2023 ...</b> <b>34 KB</b>					[You don't often get email from mailer-daemon@pta-smg3.csir.co.za. Learn why this is important at <a href="https://aka.ms/LearnAboutSenderIdentification">https://aka.ms/LearnAboutSenderIdentification</a> ] This is
	<b>post... Delivered: Closure of the Comment Period on ...</b> <b>Mon 03 Jul 2023 ...</b> <b>147 KB</b>					You don't often get email from postmaster@vodafone.com. Learn why this is important < <a href="https://aka.ms/LearnAboutSenderIdentification">https://aka.ms/LearnAboutSenderIdentification</a> >
	<b>post... Delivered: Closure of the Comment Period on ...</b> <b>Mon 03 Jul 2023 ...</b> <b>147 KB</b>					You don't often get email from postmaster@dws.gov.za. Learn why this is important < <a href="https://aka.ms/LearnAboutSenderIdentification">https://aka.ms/LearnAboutSenderIdentification</a> >
	<b>post... Delivered: Closure of the Comment Period on ...</b> <b>Mon 03 Jul 2023 ...</b> <b>139 KB</b>					You don't often get email from postmaster@outlook.com. Learn why this is important < <a href="https://aka.ms/LearnAboutSenderIdentification">https://aka.ms/LearnAboutSenderIdentification</a> >
	<b>post... Delivered: Closure of the Comment Period on ...</b> <b>Mon 03 Jul 2023 ...</b> <b>145 KB</b>					You don't often get email from postmaster@g7energies.com. Learn why this is important < <a href="https://aka.ms/LearnAboutSenderIdentification">https://aka.ms/LearnAboutSenderIdentification</a> >
	<b>post... Delivered: Closure of the Comment Period on ...</b> <b>Mon 03 Jul 2023 ...</b> <b>145 KB</b>					You don't often get email from postmaster@g7energies.com. Learn why this is important < <a href="https://aka.ms/LearnAboutSenderIdentification">https://aka.ms/LearnAboutSenderIdentification</a> >
	<b>post... Delivered: Closure of the Comment Period on ...</b> <b>Mon 03 Jul 2023 ...</b> <b>145 KB</b>					You don't often get email from postmaster@g7energies.com. Learn why this is important < <a href="https://aka.ms/LearnAboutSenderIdentification">https://aka.ms/LearnAboutSenderIdentification</a> >
	<b>post... Delivered: Closure of the Comment Period on ...</b> <b>Mon 03 Jul 2023 ...</b> <b>144 KB</b>					Your message has been delivered to the following recipients:
	<b>post... Delivered: Closure of the Comment Period on ...</b> <b>Mon 03 Jul 2023 ...</b> <b>141 KB</b>					You don't often get email from postmaster@outlook.com. Learn why this is important < <a href="https://aka.ms/LearnAboutSenderIdentification">https://aka.ms/LearnAboutSenderIdentification</a> >
	<b>Mail ... Delivered: Closure of the Comment Period on ...</b> <b>Mon 03 Jul 2023 ...</b> <b>81 KB</b>					[You don't often get email from mailer-daemon@ms13p00im-qlt33111302.me.com. Learn why this is important at
	<b>post... Delivered: Closure of the Comment Period on ...</b> <b>Mon 03 Jul 2023 ...</b> <b>145 KB</b>					You don't often get email from postmaster@g7energies.com. Learn why this is important < <a href="https://aka.ms/LearnAboutSenderIdentification">https://aka.ms/LearnAboutSenderIdentification</a> >
	<b>post... Delivered: Closure of the Comment Period on ...</b> <b>Mon 03 Jul 2023 ...</b> <b>144 KB</b>					Your message has been delivered to the following recipients:
	<b>post... Delivered: Closure of the Comment Period on ...</b> <b>Mon 03 Jul 2023 ...</b> <b>145 KB</b>					You don't often get email from postmaster@dws.gov.za. Learn why this is important < <a href="https://aka.ms/LearnAboutSenderIdentification">https://aka.ms/LearnAboutSenderIdentification</a> >
	<b>post... Delivered: Closure of the Comment Period on ...</b> <b>Mon 03 Jul 2023 ...</b> <b>145 KB</b>					You don't often get email from postmaster@g7energies.com. Learn why this is important < <a href="https://aka.ms/LearnAboutSenderIdentification">https://aka.ms/LearnAboutSenderIdentification</a> >
	<b>post... Delivered: Closure of the Comment Period on ...</b> <b>Mon 03 Jul 2023 ...</b> <b>145 KB</b>					You don't often get email from postmaster@g7energies.com. Learn why this is important < <a href="https://aka.ms/LearnAboutSenderIdentification">https://aka.ms/LearnAboutSenderIdentification</a> >
	<b>Mail ... Undeliverable: Closure of the Comment Perio...</b> <b>Mon 03 Jul 2023 ...</b> <b>35 KB</b>					[You don't often get email from mailer-daemon@mailcape.sao.ac.za. Learn why this is important at <a href="https://aka.ms/LearnAboutSenderIdentification">https://aka.ms/LearnAboutSenderIdentification</a> ] ]
	<b>post... Delivered: Closure of the Comment Period on ...</b> <b>Mon 03 Jul 2023 ...</b> <b>142 KB</b>					You don't often get email from postmaster@r-n.co.za. Learn why this is important < <a href="https://aka.ms/LearnAboutSenderIdentification">https://aka.ms/LearnAboutSenderIdentification</a> >
	<b>post... Delivered: Closure of the Comment Period on ...</b> <b>Mon 03 Jul 2023 ...</b> <b>145 KB</b>					You don't often get email from postmaster@g7energies.com. Learn why this is important < <a href="https://aka.ms/LearnAboutSenderIdentification">https://aka.ms/LearnAboutSenderIdentification</a> >
	<b>post... Delivered: Closure of the Comment Period on ...</b> <b>Mon 03 Jul 2023 ...</b> <b>141 KB</b>					You don't often get email from postmaster@corp.akuoenergy.com. Learn why this is important < <a href="https://aka.ms/LearnAboutSenderIdentification">https://aka.ms/LearnAboutSenderIdentification</a> >
	<b>post... Delivered: Closure of the Comment Period on ...</b> <b>Mon 03 Jul 2023 ...</b> <b>141 KB</b>					You don't often get email from postmaster@agrink.co.za. Learn why this is important < <a href="https://aka.ms/LearnAboutSenderIdentification">https://aka.ms/LearnAboutSenderIdentification</a> >
	<b>MAIL... Failure Notice</b> <b>Mon 03 Jul 2023 ...</b> <b>118 KB</b>					[You don't often get email from mailer-daemon@yahoo.com. Learn why this is important at <a href="https://aka.ms/LearnAboutSenderIdentification">https://aka.ms/LearnAboutSenderIdentification</a> ] ]
	<b>post... Delivered: Closure of the Comment Period on ...</b> <b>Mon 03 Jul 2023 ...</b> <b>145 KB</b>					You don't often get email from postmaster@g7energies.com. Learn why this is important < <a href="https://aka.ms/LearnAboutSenderIdentification">https://aka.ms/LearnAboutSenderIdentification</a> >
	<b>post... Delivered: Closure of the Comment Period on ...</b> <b>Mon 03 Jul 2023 ...</b> <b>147 KB</b>					You don't often get email from postmaster@dws.gov.za. Learn why this is important < <a href="https://aka.ms/LearnAboutSenderIdentification">https://aka.ms/LearnAboutSenderIdentification</a> >

## APPENDICES

### ENVIRONMENTAL IMPACT ASSESSMENT REPORT: Scoping and Environmental Impact Assessment (EIA) Process for the Proposed Development of a Solar Photovoltaic (PV) Facility (Kudu Solar Facility 3) and associated infrastructure, near De Aar, Northern Cape Province

EMS - Delivery Receipts										By Date <span style="font-size: small;">v</span> <span style="font-size: small;">↑</span>
					From	Subject	Received <span style="font-size: small;">v</span>	Size	Categories	Mention <span style="font-size: small;">v</span>
					post...	<b>Delivered: Closure of the Comment Period on ... Mon 03 Jul 2023 ...</b> 141 KB You don't often get email from postmaster@birdlife.org.za. Learn why this is important <https://aka.ms/LearnAboutSenderIdentification>				
					post...	<b>Delivered: Closure of the Comment Period on ... Mon 03 Jul 2023 ...</b> 147 KB You don't often get email from postmaster@dws.gov.za. Learn why this is important <https://aka.ms/LearnAboutSenderIdentification>				
					post...	<b>Delivered: Closure of the Comment Period on ... Mon 03 Jul 2023 ...</b> 145 KB You don't often get email from postmaster@dws.gov.za. Learn why this is important <https://aka.ms/LearnAboutSenderIdentification>				
					post...	<b>Delivered: Closure of the Comment Period on ... Mon 03 Jul 2023 ...</b> 141 KB You don't often get email from postmaster@birdlife.org.za. Learn why this is important <https://aka.ms/LearnAboutSenderIdentification>				
					post...	<b>Delivered: Closure of the Comment Period on ... Mon 03 Jul 2023 ...</b> 140 KB You don't often get email from postmaster@wessa.co.za. Learn why this is important <https://aka.ms/LearnAboutSenderIdentification>				
					post...	<b>Delivered: Closure of the Comment Period on ... Mon 03 Jul 2023 ...</b> 142 KB Your message has been delivered to the following recipients:				
					post...	<b>Delivered: Closure of the Comment Period on ... Mon 03 Jul 2023 ...</b> 147 KB You don't often get email from postmaster@dws.gov.za. Learn why this is important <https://aka.ms/LearnAboutSenderIdentification>				
					post...	<b>Delivered: Closure of the Comment Period on ... Mon 03 Jul 2023 ...</b> 147 KB You don't often get email from postmaster@dws.gov.za. Learn why this is important <https://aka.ms/LearnAboutSenderIdentification>				
					post...	<b>Delivered: Closure of the Comment Period on ... Mon 03 Jul 2023 ...</b> 141 KB You don't often get email from postmaster@birdlife.org.za. Learn why this is important <https://aka.ms/LearnAboutSenderIdentification>				
					post...	<b>Delivered: Closure of the Comment Period on ... Mon 03 Jul 2023 ...</b> 139 KB You don't often get email from postmaster@outlook.com. Learn why this is important <https://aka.ms/LearnAboutSenderIdentification>				
					post...	<b>Delivered: Closure of the Comment Period on ... Mon 03 Jul 2023 ...</b> 147 KB You don't often get email from postmaster@dws.gov.za. Learn why this is important <https://aka.ms/LearnAboutSenderIdentification>				
					post...	<b>Delivered: Closure of the Comment Period on ... Mon 03 Jul 2023 ...</b> 140 KB You don't often get email from postmaster@netorg7356748.onmicrosoft.com. Learn why this is important				
					post...	<b>Delivered: Closure of the Comment Period on ... Mon 03 Jul 2023 ...</b> 145 KB You don't often get email from postmaster@g7energies.com. Learn why this is important <https://aka.ms/LearnAboutSenderIdentification>				
					post...	<b>Delivered: Closure of the Comment Period on ... Mon 03 Jul 2023 ...</b> 143 KB Your message has been delivered to the following recipients:				
					post...	<b>Delivered: Closure of the Comment Period on ... Mon 03 Jul 2023 ...</b> 141 KB You don't often get email from postmaster@agrlink.co.za. Learn why this is important <https://aka.ms/LearnAboutSenderIdentification>				
					Mail ...	<b>Delivered: Closure of the Comment Period on ... Mon 03 Jul 2023 ...</b> 74 KB [You don't often get email from mailer-daemon@spe16.ucebox.co.za. Learn why this is important at https://aka.ms/LearnAboutSenderIdentification ]				
					post...	<b>Delivered: Closure of the Comment Period on ... Mon 03 Jul 2023 ...</b> 143 KB Your message has been delivered to the following recipients:				
					post...	<b>Delivered: Closure of the Comment Period on ... Mon 03 Jul 2023 ...</b> 142 KB You don't often get email from postmaster@mullio.com. Learn why this is important <https://aka.ms/LearnAboutSenderIdentification>				
					Mail ...	<b>Relayed: Closure of the Comment Period on t... Mon 03 Jul 2023 ...</b> 76 KB [You don't often get email from mailer-daemon@hostserv.co.za. Learn why this is important at https://aka.ms/LearnAboutSenderIdentification ]				
					post...	<b>Delivered: Closure of the Comment Period on ... Mon 03 Jul 2023 ...</b> 142 KB You don't often get email from postmaster@g7energies.com. Learn why this is important <https://aka.ms/LearnAboutSenderIdentification>				
					post...	<b>Delivered: Closure of the Comment Period on ... Mon 03 Jul 2023 ...</b> 145 KB You don't often get email from postmaster@scatecsolar.onmicrosoft.com. Learn why this is important				
					post...	<b>Delivered: Closure of the Comment Period on ... Mon 03 Jul 2023 ...</b> 145 KB You don't often get email from postmaster@g7energies.com. Learn why this is important <https://aka.ms/LearnAboutSenderIdentification>				
					post...	<b>Delivered: Closure of the Comment Period on ... Mon 03 Jul 2023 ...</b> 139 KB You don't often get email from postmaster@nocco.co.za. Learn why this is important <https://aka.ms/LearnAboutSenderIdentification>				
					Mail ...	<b>Relayed: Closure of the Comment Period on t... Mon 03 Jul 2023 ...</b> 70 KB [You don't often get email from mailer-daemon@luke.voffice.co.za. Learn why this is important at https://aka.ms/LearnAboutSenderIdentification ]				
					post...	<b>Delivered: Closure of the Comment Period on ... Mon 03 Jul 2023 ...</b> 140 KB You don't often get email from postmaster@africoastinvestments.co.za. Learn why this is important				
					Mail ...	<b>Undeliverable: Closure of the Comment Perio... Mon 03 Jul 2023 ...</b> 38 KB [You don't often get email from mailer-daemon@pta-smg3.csir.co.za. Learn why this is important at https://aka.ms/LearnAboutSenderIdentification ] This is				

## APPENDICES

### ENVIRONMENTAL IMPACT ASSESSMENT REPORT: Scoping and Environmental Impact Assessment (EIA) Process for the Proposed Development of a Solar Photovoltaic (PV) Facility (Kudu Solar Facility 3) and associated infrastructure, near De Aar, Northern Cape Province

EMS - Delivery Receipts By Date v ↑

From	Subject	Received	Size	Categories	Mention					
	<b>Mail ...</b> Relayed: Closure of the Comment Period on t... <b>Mon 03 Jul 2023 ... 107 KB</b> <small>[You don't often get email from mailer-daemon@pta-smg3.csir.co.za. Learn why this is important at <a href="https://aka.ms/LearnAboutSenderIdentification">https://aka.ms/LearnAboutSenderIdentification</a> ] This is</small>									
	<b>post...</b> Delivered: Closure of the Comment Period on ... <b>Mon 03 Jul 2023 ... 143 KB</b> <small>You don't often get email from postmaster@dws.gov.za. Learn why this is important &lt;<a href="https://aka.ms/LearnAboutSenderIdentification">https://aka.ms/LearnAboutSenderIdentification</a>&gt;</small>									
	<b>post...</b> Delivered: Closure of the Comment Period on ... <b>Mon 03 Jul 2023 ... 141 KB</b> <small>You don't often get email from postmaster@netorg6186573.onmicrosoft.com. Learn why this is important</small>									
	<b>post...</b> Delivered: Closure of the Comment Period on ... <b>Mon 03 Jul 2023 ... 137 KB</b> <small>You don't often get email from postmaster@africoastinvestments.co.za. Learn why this is important</small>									
	Mail D... Relayed: Closure of the Comment Period on the ... <b>Mon 03 Jul 2023 0... 108 KB</b> <small>[You don't often get email from mailer-daemon@pta-smg3.csir.co.za. Learn why this is important at <a href="https://aka.ms/LearnAboutSenderIdentification">https://aka.ms/LearnAboutSenderIdentification</a> ] This is</small>									
	<b>Mail ...</b> Relayed: Closure of the Comment Period on t... <b>Mon 03 Jul 2023 ... 76 KB</b> <small>[You don't often get email from mailer-daemon@hostserv.co.za. Learn why this is important at <a href="https://aka.ms/LearnAboutSenderIdentification">https://aka.ms/LearnAboutSenderIdentification</a> ]</small>									
	<b>Mail ...</b> Relayed: Closure of the Comment Period on t... <b>Mon 03 Jul 2023 ... 65 KB</b> <small>[You don't often get email from mailer-daemon@pta-smg4.csir.co.za. Learn why this is important at <a href="https://aka.ms/LearnAboutSenderIdentification">https://aka.ms/LearnAboutSenderIdentification</a> ] This is</small>									
	<b>Micro...</b> Delivered: Closure of the Comment Period on ... <b>Mon 03 Jul 2023 ... 104 KB</b> <small>Your message has been delivered to the following recipients:</small>									
	<b>Micro...</b> Delivered: Closure of the Comment Period on ... <b>Mon 03 Jul 2023 ... 104 KB</b> <small>Your message has been delivered to the following recipients:</small>									
	<b>Micro...</b> Delivered: Closure of the Comment Period on ... <b>Mon 03 Jul 2023 ... 104 KB</b> <small>Your message has been delivered to the following recipients:</small>									

## APPENDICES

### ENVIRONMENTAL IMPACT ASSESSMENT REPORT: Scoping and Environmental Impact Assessment (EIA) Process for the Proposed Development of a Solar Photovoltaic (PV) Facility (Kudu Solar Facility 3) and associated infrastructure, near De Aar, Northern Cape Province

#### 19. Read Receipts of All Email Communication to Stakeholders During the DEIAR Release Phase

Read receipts sent to [ems@csir.co.za](mailto:ems@csir.co.za)

EMS - Read Receipts		By Date	↑		
From	Subject	Received	Size	Categories	Mention
<b>Yesterday</b>					
☑	Karen ...	Read: Closure of the Comment Period on the ...	Tue 04 Jul 2023 ...	58 KB	Your message
☑	[REDACTED]	Read: Closure of the Comment Period on the Dra...	Tue 04 Jul 2023 1...	60 KB	You don't often get email from [REDACTED]. Learn why this is important < <a href="https://aka.ms/LearnAboutSenderIdentification">https://aka.ms/LearnAboutSenderIdentification</a> > Your
☒	Pale P...	Not read: Closure of the Comment Period on ...	Tue 04 Jul 2023 ...	52 KB	You don't often get email from [REDACTED]. Learn why this is important < <a href="https://aka.ms/LearnAboutSenderIdentification">https://aka.ms/LearnAboutSenderIdentification</a> > Your
📧	[REDACTED]	Read: Closure of the Comment Period on the ...	Tue 04 Jul 2023 ...	41 KB	
☑	Wentz...	Read: Closure of the Comment Period on the ...	Tue 04 Jul 2023 ...	43 KB	Your message
📧	dmota...	Read: Closure of the Comment Period on the ...	Tue 04 Jul 2023 ...	38 KB	[The e-mail server of the sender could not be verified (SPF Record)] <end>
📧	Them...	Read: Closure of the Comment Period on the ...	Tue 04 Jul 2023 ...	47 KB	Disclaimer The information contained in this e-mail may be confidential, legally privileged and protected by law. Access by the intended recipient only is
📧	pixley...	Read: Closure of the Comment Period on the Dra...	Tue 04 Jul 2023 0...	40 KB	[You don't often get email from pixley@ablieswireless.co.za. Learn why this is important at <a href="https://aka.ms/LearnAboutSenderIdentification">https://aka.ms/LearnAboutSenderIdentification</a> ]
<b>Monday</b>					
📧	idh@p...	Read: Closure of the Comment Period on the ...	Mon 03 Jul 2023...	38 KB	[The e-mail server of the sender could not be verified (SPF Record)] <end>
☑	[REDACTED]	Read: RE: Reminder of the Availability of Draft EI...	Mon 03 Jul 2023 ...	39 KB	You don't often get email from [REDACTED]. Learn why this is important < <a href="https://aka.ms/LearnAboutSenderIdentification">https://aka.ms/LearnAboutSenderIdentification</a> > Your
☑	[REDACTED]	Read: RE: Reminder of the Availability of Draf...	Mon 03 Jul 2023...	38 KB	Your message
📧	sbaas...	Read: Closure of the Comment Period on the ...	Mon 03 Jul 2023...	37 KB	[The e-mail server of the sender could not be verified (SPF Record)] <end>
☑	Tebeg...	Read: Draft EIA Reports for the Proposed Dev...	Mon 03 Jul 2023...	41 KB	Your message
☑	Tebeg...	Read: Draft EIA Reports for the Proposed Dev...	Mon 03 Jul 2023...	40 KB	Your message
☑	Ntsike...	Read: Closure of the Comment Period on the ...	Mon 03 Jul 2023...	49 KB	You don't often get email from ntsikelelo.kika@dmre.gov.za. Learn why this is important < <a href="https://aka.ms/LearnAboutSenderIdentification">https://aka.ms/LearnAboutSenderIdentification</a> > Your
☑	Veroni...	Read: Closure of the Comment Period on the ...	Mon 03 Jul 2023...	58 KB	Your message
☑	[REDACTED]	Read: Closure of the Comment Period on the ...	Mon 03 Jul 2023...	48 KB	You don't often get email from [REDACTED]. Learn why this is important < <a href="https://aka.ms/LearnAboutSenderIdentification">https://aka.ms/LearnAboutSenderIdentification</a> >
☑	Seten...	Read: Closure of the Comment Period on the ...	Mon 03 Jul 2023...	50 KB	Your message
☑	Mahla...	Read: Closure of the Comment Period on the ...	Mon 03 Jul 2023...	41 KB	Your message
📧	emoffi...	Read: Closure of the Comment Period on the ...	Mon 03 Jul 2023...	38 KB	[The e-mail server of the sender could not be verified (SPF Record)] <end>
☒	Mahlat...	Not read: Reminder of the Availability of Draft EI...	Mon 03 Jul 2023 ...	41 KB	Your message
☒	Michell...	Not read: Closure of the Comment Period on the...	Mon 03 Jul 2023 ...	34 KB	[The e-mail server of the sender could not be verified (SPF Record)] Your message
📧	[REDACTED]	Read: Closure of the Comment Period on the ...	Mon 03 Jul 2023...	70 KB	[The e-mail server of the sender failed SPF checks and maybe malicious (SPF Record)]
☑	Cloete...	Read: Closure of the Comment Period on the ...	Mon 03 Jul 2023...	48 KB	Your message
☑	Info Dot	Read: Closure of the Comment Period on the ...	Mon 03 Jul 2023...	34 KB	[The e-mail server of the sender could not be verified (SPF Record)] Your message
☑	[REDACTED]	Read: Closure of the Comment Period on the ...	Mon 03 Jul 2023...	49 KB	You don't often get email from [REDACTED]. Learn why this is important

## APPENDICES

### ENVIRONMENTAL IMPACT ASSESSMENT REPORT: Scoping and Environmental Impact Assessment (EIA) Process for the Proposed Development of a Solar Photovoltaic (PV) Facility (Kudu Solar Facility 3) and associated infrastructure, near De Aar, Northern Cape Province

EMS - Read Receipts					By Date <span style="font-size: small;">v</span> <span style="font-size: small;">↑</span>
🔍	📧	📄	📧	📧	📧
From	Subject	Received	Size	Categories	Mention
	Sydne... Read: Closure of the Comment Period on the ... <small>Your message</small>	Mon 03 Jul 2023...	41 KB		
	pixley... Read: Closure of the Comment Period on the ... <small>[You don't often get email from pixley@albieswireless.co.za. Learn why this is important at https://aka.ms/LearnAboutSenderIdentification ]</small>	Mon 03 Jul 2023...	43 KB		
	Azrah ... Read: Closure of the Comment Period on the ... <small>Your message</small>	Mon 03 Jul 2023...	40 KB		
	Howar... Read: Closure of the Comment Period on the ... <small>&lt; Your message</small>	Mon 03 Jul 2023...	45 KB		
	██████ Read: Closure of the Comment Period on the ... <small>[You don't often get email from ██████. Learn why this is important at https://aka.ms/LearnAboutSenderIdentification ]</small>	Mon 03 Jul 2023...	43 KB		
	ivisser... Read: Closure of the Comment Period on the ... <small>[You don't often get email from ivisser@plsdm.gov.za. Learn why this is important at https://aka.ms/LearnAboutSenderIdentification ]</small>	Mon 03 Jul 2023...	42 KB		
	██████ Read: Closure of the Comment Period on the ... <small>Your message</small>	Mon 03 Jul 2023...	51 KB		
	Janse... Read: Closure of the Comment Period on the ... <small>Your message</small>	Mon 03 Jul 2023...	49 KB		
	Bestu... Read: Closure of the Comment Period on the ... <small>Your message</small>	Mon 03 Jul 2023...	49 KB		
	██████ Read: Closure of the Comment Period on the ... <small>[You don't often get email from ██████. Learn why this is important at https://aka.ms/LearnAboutSenderIdentification ]</small>	Mon 03 Jul 2023...	36 KB		
	Chris S... Read: Closure of the Comment Period on the Dra... <small>Your message</small>	Mon 03 Jul 2023 ...	56 KB		
	Annette... Read: Closure of the Comment Period on the Dra... <small>Disclaimer The information contained in this e-mail may be confidential, legally privileged and protected by law. Access by the intended recipient only is</small>	Mon 03 Jul 2023 ...	47 KB		
	Mama... Read: Closure of the Comment Period on the ... <small>Your message</small>	Mon 03 Jul 2023...	48 KB		
	██████ Read: Closure of the Comment Period on the ... <small>You don't often get email from ██████. Learn why this is important</small>	Mon 03 Jul 2023...	49 KB		
	Natash... Read: Closure of the Comment Period on the Dra... <small>[The e-mail server of the sender failed SPF checks and maybe malicious (SPF Record)] Natasha Higgitt</small>	Mon 03 Jul 2023 ...	71 KB		
	██████ Read: Closure of the Comment Period on the ... <small>Your message</small>	Mon 03 Jul 2023...	35 KB		
	Rohal... Read: Closure of the Comment Period on the ... <small>Your message</small>	Mon 03 Jul 2023...	21 KB		
	Rohaid... Read: Closure of the Comment Period on the Dra... <small>Your message</small>	Mon 03 Jul 2023 ...	22 KB		
<b>▼ Sunday</b>					
	Leseg... Not read: Reminder of the Availability of Draf... <small>[The e-mail server of the sender could not be verified (SPF Record)] Your message</small>	Sun 02 Jul 2023 ...	35 KB		
<b>▼ Last Week</b>					
	EMS Read: Kudu solar facilities 1-12 Northern Cape <small>Your message</small>	Fri 30 Jun 2023 ...	20 KB		
	██████ Not read: Reminder of the Availability of Draf... <small>You don't often get email from ██████. Learn why this is important &lt;https://aka.ms/LearnAboutSenderIdentification&gt;</small>	Thu 29 Jun 2023...	37 KB		✓
	██████ Read: FW: Renewable Energy Applications: Ou... <small>Your message</small>	Thu 29 Jun 2023...	32 KB		
	██████ Read: Herinnering van die Besikbaarheid van... <small>Your message</small>	Wed 28 Jun 202...	39 KB		
	Cloete... Read: Letters for Comments - Kudu Solar PV -... <small>Your message</small>	Tue 27 Jun 2023...	49 KB		
	Thembl... Read: Kudu solar facilities 1-12 Northern Cape <small>Disclaimer The information contained in this e-mail may be confidential, legally privileged and protected by law. Access by the intended recipient only is</small>	Tue 27 Jun 2023 ...	45 KB		



## APPENDICES

### ENVIRONMENTAL IMPACT ASSESSMENT REPORT: Scoping and Environmental Impact Assessment (EIA) Process for the Proposed Development of a Solar Photovoltaic (PV) Facility (Kudu Solar Facility 3) and associated infrastructure, near De Aar, Northern Cape Province

EMS - Read Receipts							By Date ▾ ↑
From	Subject	Received	Size	Categories	Mention		
Tebeg...	Read: Availability of Draft EIA Reports for Co...	Tue 27 Jun 2023...	40 KB			Your message	
Janse...	Read: Letters for Comments - Kudu Solar PV ...	Tue 27 Jun 2023...	47 KB			Your message	
idh@p...	Read: Reminder of the Availability of Draft EI...	Tue 27 Jun 2023...	39 KB			[The e-mail server of the sender could not be verified (SPF Record)] Your message	
idh@p...	Read: Reminder of the Availability of Draft EI...	Tue 27 Jun 2023...	38 KB			[The e-mail server of the sender could not be verified (SPF Record)] Your message	
██████	Read: Herinnering van die Besikbaarheid van...	Mon 26 Jun 202...	39 KB	This m...		[The e-mail server of the sender could not be verified (SPF Record)] Your message	
EMS	Read: Herinnering van die Besikbaarheid van...	Mon 26 Jun 202...	21 KB	This m...		Your message	
EMS	Read: Herinnering van die Besikbaarheid van...	Mon 26 Jun 202...	21 KB	This m...		Your message	
dmota...	Read: Reminder of the Availability of Draft EI...	Mon 26 Jun 202...	39 KB	This m...		[The e-mail server of the sender could not be verified (SPF Record)] Your message	
Mpho ...	Not read: Reminder of the Availability of Draf...	Mon 26 Jun 202...	48 KB	This m...		Your message	
▼ Two Weeks Ago							
dmota...	Read: Reminder of the Availability of Draft EIA Re...	Fri 23 Jun 2023 2...	39 KB	This me...		[The e-mail server of the sender could not be verified (SPF Record)] Your message	
██████	Read: Date and Location of Public Participatio...	Fri 23 Jun 2023 ...	48 KB	This m...		You don't often get email from ████████. Learn why this is important	
Poppi...	Read: Reminder of the Availability of Draft EI...	Fri 23 Jun 2023 ...	41 KB	This m...		You don't often get email from poppie.mahlangu@nersa.org.za. Learn why this is important <https://aka.ms/LearnAboutSenderIdentification>	
██████	Read: Reminder of the Availability of Draft EI...	Fri 23 Jun 2023 ...	48 KB	This m...		You don't often get email from ████████. Learn why this is important	
Lizell ...	Read: Reminder of the Availability of Draft EI...	Fri 23 Jun 2023 ...	38 KB	This m...		Your message	
Sam R...	Read: RE: Reminder of the Availability of Draf...	Fri 23 Jun 2023 ...	47 KB	This m...		[The e-mail server of the sender failed SPF checks and maybe malicious (SPF Record)] Your message	
Them...	Read: Kudu solar facilities 1-12 Northern Cape	Fri 23 Jun 2023 ...	46 KB	This m...		Disclaimer: The information contained in this e-mail may be confidential, legally privileged and protected by law. Access by the intended recipient only is	
emoffi...	Read: Reminder of the Availability of Draft EI...	Fri 23 Jun 2023 ...	39 KB	This m...		[The e-mail server of the sender could not be verified (SPF Record)] Your message	
pixley...	Read: Reminder of the Availability of Draft EI...	Fri 23 Jun 2023 ...	41 KB	This m...		You don't often get email from pixley@albieswireless.co.za. Learn why this is important <https://aka.ms/LearnAboutSenderIdentification>	
Julliet...	Read: Reminder of the Availability of Draft EI...	Thu 22 Jun 2023...	40 KB	This m...		Your message	
██████	Read: Reminder of the Availability of Draft EI...	Thu 22 Jun 2023...	40 KB	This m...		You don't often get email from ████████. Learn why this is important <https://aka.ms/LearnAboutSenderIdentification>	
██████	Read: Reminder of the Availability of Draft EI...	Thu 22 Jun 2023...	40 KB	This m...		You don't often get email from ████████. Learn why this is important <https://aka.ms/LearnAboutSenderIdentification>	
██████	Read: RE: Reminder of the Availability of Draf...	Thu 22 Jun 2023...	33 KB	This m...		Your message	
Lizell ...	Read: Reminder of the Availability of Draft EI...	Thu 22 Jun 2023...	38 KB	This m...		Your message	
Sam Ra...	Read: RE: Reminder of the Availability of Draft EI...	Thu 22 Jun 2023 ...	51 KB	This me...		[The e-mail server of the sender failed SPF checks and maybe malicious (SPF Record)] Your message	
otshek...	Read: Reminder of the Availability of Draft EI...	Thu 22 Jun 2023...	39 KB	This m...		[The e-mail server of the sender could not be verified (SPF Record)] Your message	
Morga...	Read: Reminder of the Availability of Draft EI...	Thu 22 Jun 2023...	48 KB	This m...		Your message	

## APPENDICES

### ENVIRONMENTAL IMPACT ASSESSMENT REPORT: Scoping and Environmental Impact Assessment (EIA) Process for the Proposed Development of a Solar Photovoltaic (PV) Facility (Kudu Solar Facility 3) and associated infrastructure, near De Aar, Northern Cape Province

EMS - Read Receipts							By Date ▾ ↑
	From	Subject	Received ▾	Size	Categories	Mention	
	Michel...	Not read: Reminder of the Availability of Draf...	Thu 22 Jun 2023...	36 KB	This m...		
		You don't often get email from phenyam@dot.gov.za. Learn why this is important <https://aka.ms/LearnAboutSenderIdentification>					
	Bestu...	Read: Reminder of the Availability of Draft El...	Thu 22 Jun 2023...	48 KB	This m...		
		Your message					
	Leseg...	Read: Reminder of the Availability of Draft El...	Thu 22 Jun 2023...	34 KB	This m...		
		[The e-mail server of the sender could not be verified (SPF Record)] Your message					
	Howar...	Read: Reminder of the Availability of Draft El...	Thu 22 Jun 2023...	44 KB	This m...		
		< Your message >					
	asibek...	Read: Reminder of the Availability of Draft El...	Thu 22 Jun 2023...	39 KB	This m...		
		[The e-mail server of the sender could not be verified (SPF Record)] Your message					
	Info Dot	Read: RE: Reminder of the Availability of Draft El...	Thu 22 Jun 2023 ...	35 KB	This me...		
		You don't often get email from info@dot.gov.za. Learn why this is important <https://aka.ms/LearnAboutSenderIdentification>					
	Poppie...	Read: Reminder of the Availability of Draft EIA Re...	Thu 22 Jun 2023 ...	40 KB	This me...		
		You don't often get email from poppie.mahlangu@nersa.org.za. Learn why this is important <https://aka.ms/LearnAboutSenderIdentification>					
	██████	Read: Reminder of the Availability of Draft El...	Thu 22 Jun 2023...	50 KB	This m...		
		Your message					
	██████	Read: Reminder of the Availability of Draft El...	Thu 22 Jun 2023...	59 KB	This m...		
		You don't often get email from ████████. Learn why this is important <https://aka.ms/LearnAboutSenderIdentification> Your					
	██████	Read: Reminder of the Availability of Draft El...	Thu 22 Jun 2023...	50 KB	This m...		
		You don't often get email from ████████. Learn why this is important <https://aka.ms/LearnAboutSenderIdentification>					
	emoffi...	Read: Reminder of the Availability of Draft El...	Thu 22 Jun 2023...	41 KB	This m...		
		You don't often get email from emoffice@pkisdms.gov.za. Learn why this is important <https://aka.ms/LearnAboutSenderIdentification>					
	Chris ...	Read: RE: Reminder of the Availability of Draf...	Thu 22 Jun 2023...	56 KB	This m...		
		Your message					
	██████	Read: Reminder of the Availability of Draft El...	Thu 22 Jun 2023...	43 KB	This m...		
		Your message					
	sbaas...	Read: Reminder of the Availability of Draft El...	Thu 22 Jun 2023...	40 KB	This m...		
		You don't often get email from sbaas@pkisdms.gov.za. Learn why this is important <https://aka.ms/LearnAboutSenderIdentification>					
	Morga...	Read: Reminder of the Availability of Draft El...	Thu 22 Jun 2023...	48 KB	This m...		
		Your message					
	Nicole...	Read: Reminder of the Availability of Draft El...	Thu 22 Jun 2023...	40 KB	This m...		
		Your message					
	Azrah ...	Read: RE: Reminder of the Availability of Draf...	Thu 22 Jun 2023...	39 KB	This m...		
		Your message					
	██████	Read: Reminder of the Availability of Draft EIA Re...	Thu 22 Jun 2023 ...	51 KB	This me...		
		You don't often get email from ████████. Learn why this is important <https://aka.ms/LearnAboutSenderIdentification>					
	██████	Read: RE: Reminder of the Availability of Draft El...	Thu 22 Jun 2023 ...	46 KB	This me...		
		Your message					
	██████	Read: Reminder of the Availability of Draft EIA Re...	Thu 22 Jun 2023 ...	45 KB	This me...		
		You don't often get email from ████████. Learn why this is important <https://aka.ms/LearnAboutSenderIdentification>					
	Jansen ...	Read: Reminder of the Availability of Draft EIA Re...	Thu 22 Jun 2023 ...	49 KB	This me...		
		Your message					
	Bestu...	Read: Reminder of the Availability of Draft El...	Thu 22 Jun 2023...	50 KB	This m...		
		You don't often get email from bestuurder@agrink.co.za. Learn why this is important <https://aka.ms/LearnAboutSenderIdentification> Your					
	Them...	Read: Reminder of the Availability of Draft El...	Thu 22 Jun 2023...	46 KB	This m...		
		[You don't often get email from thembiny@dalrdd.gov.za. Learn why this is important at https://aka.ms/LearnAboutSenderIdentification ] Disclaimer The					
	██████	Read: Reminder of the Availability of Draft El...	Thu 22 Jun 2023...	49 KB	This m...		
		Your message					
	TFR911	Read: Reminder of the Availability of Draft El...	Thu 22 Jun 2023...	44 KB	This m...		
		You don't often get email from ████████. Learn why this is important <https://aka.ms/LearnAboutSenderIdentification> Your message					
	Cloete...	Read: Reminder of the Availability of Draft El...	Thu 22 Jun 2023...	49 KB	This m...		
		Your message					

## APPENDICES

### ENVIRONMENTAL IMPACT ASSESSMENT REPORT: Scoping and Environmental Impact Assessment (EIA) Process for the Proposed Development of a Solar Photovoltaic (PV) Facility (Kudu Solar Facility 3) and associated infrastructure, near De Aar, Northern Cape Province

EMS - Read Receipts							By Date <span style="font-size: small;">v</span> <span style="font-size: small;">↑</span>
	From	Subject	Received	Size	Categories	Mention	
	otahek...	Read: Reminder of the Availability of Draft El...	Thu 22 Jun 2023...	39 KB	This m...		
<small>[The e-mail server of the sender could not be verified (SPF Record)] Your message</small>							
	Riaan ...	Read: RE: Reminder of the Availability of Draf...	Thu 22 Jun 2023...	42 KB	This m...		
<small>Your message</small>							
	Van D...	Read: Reminder of the Availability of Draft El...	Thu 22 Jun 2023...	50 KB	This m...		
<small>You don't often get email from vandykg@dws.gov.za. Learn why this is important &lt;https://aka.ms/LearnAboutSenderIdentification&gt; Your</small>							
	Natas...	Read: Reminder of the Availability of Draft El...	Thu 22 Jun 2023...	69 KB	This m...		
<small>[The e-mail server of the sender failed SPF checks and maybe malicious (SPF Record)] Natasha Higgitt</small>							
	Wentz...	Read: Reminder of the Availability of Draft El...	Thu 22 Jun 2023...	43 KB	This m...		
<small>Your message</small>							
	Lucius...	Read: RE: Reminder of the Availability of Draf...	Thu 22 Jun 2023...	43 KB	This m...		
<small>&lt; Your message</small>							
	██████	Not read: Reminder of the Availability of Draf...	Thu 22 Jun 2023...	43 KB	This m...		
<small>You don't often get email from ████████. Learn why this is important &lt;https://aka.ms/LearnAboutSenderIdentification&gt;</small>							
	pixley...	Read: Reminder of the Availability of Draft El...	Thu 22 Jun 2023...	41 KB	This m...		
<small>You don't often get email from pixley@albieswireless.co.za. Learn why this is important &lt;https://aka.ms/LearnAboutSenderIdentification&gt;</small>							
	Saman...	Read: [EXTERNAL]RE: Reminder - Availability ...	Wed 21 Jun 202...	48 KB	This m...		
<small>You don't often get email from sdelafontaine@daerl.co.za. Learn why this is important &lt;https://aka.ms/LearnAboutSenderIdentification&gt;</small>							
	Franco...	Read: RE: Reminder of the Availability of Draf...	Wed 21 Jun 202...	34 KB	This m...		
<small>Your message</small>							
	Craig ...	Read: Reminder of the Availability of Draft El...	Wed 21 Jun 202...	48 KB	This m...		
<small>Your message</small>							
	Rohai...	Read: Reminder of the Availability of Draft El...	Wed 21 Jun 202...	21 KB	This m...		
<small>Your message</small>							
	Sharo...	Read: Reminder of the Availability of Draft El...	Wed 21 Jun 202...	46 KB	This m...		
<small>Your message</small>							
	Sharo...	Read: RE: Reminder of the Availability of Draf...	Wed 21 Jun 202...	45 KB	This m...		
<small>Your message</small>							
	Info Dot	Read: RE: Reminder of the Availability of Draft El...	Wed 21 Jun 2023 ...	35 KB	This me...		
<small>You don't often get email from info@dot.gov.za. Learn why this is important &lt;https://aka.ms/LearnAboutSenderIdentification&gt;</small>							
	██████	Read: Reminder of the Availability of Draft El...	Wed 21 Jun 202...	44 KB	This m...		
<small>Your message</small>							
	██████	Read: Reminder of the Availability of Draft El...	Wed 21 Jun 202...	49 KB	This m...		
<small>Your message</small>							
	██████	Not read: Reminder of the Availability of Draft El...	Mon 19 Jun 2023 ...	57 KB	This me...		
<small>You don't often get email from ████████. Learn why this is important &lt;https://aka.ms/LearnAboutSenderIdentification&gt;</small>							
	EWT E...	Read: Reminder of the Availability of Draft El...	Sun 18 Jun 2023...	42 KB	This m...		
<small>Your message</small>							
<b>Three Weeks Ago</b>							
	Mahlal...	Not read: Reminder of the Availability of Draft El...	Tue 13 Jun 2023 ...	41 KB	This me...		
<small>Your message</small>							
	██████	Read: Reminder of the Availability of Draft El...	Mon 12 Jun 202...	38 KB	This m...		
<small>Your message</small>							
	asibek...	Read: Reminder of the Availability of Draft El...	Mon 12 Jun 202...	41 KB	This m...		
<small>You don't often get email from asibeko@pkisdms.gov.za. Learn why this is important &lt;https://aka.ms/LearnAboutSenderIdentification&gt;</small>							
	Thivh...	Read: Reminder of the Availability of Draft El...	Mon 12 Jun 202...	40 KB	This m...		
<small>Your message</small>							
	Info Dot	Read: RE: Reminder of the Availability of Draf...	Mon 12 Jun 202...	36 KB	This m...		
<small>You don't often get email from info@dot.gov.za. Learn why this is important &lt;https://aka.ms/LearnAboutSenderIdentification&gt;</small>							
<b>Last Month</b>							
	██████	Not read: Reminder of the Availability of Draf...	Fri 09 Jun 2023 ...	51 KB	This m...		
<small>You don't often get email from ████████. Learn why this is important &lt;https://aka.ms/LearnAboutSenderIdentification&gt; Your</small>							

## APPENDICES

### ENVIRONMENTAL IMPACT ASSESSMENT REPORT: Scoping and Environmental Impact Assessment (EIA) Process for the Proposed Development of a Solar Photovoltaic (PV) Facility (Kudu Solar Facility 3) and associated infrastructure, near De Aar, Northern Cape Province

EMS - Read Receipts							By Date ▾ ↑
	From	Subject	Received	Size	Categories	Mention	
	doorn...	Read: Reminder of the Availability of Draft El...	Fri 09 Jun 2023 ...	41 KB	This m...		
You don't often get email from doornkloofnr@gmail.com. Learn why this is important <https://aka.ms/LearnAboutSenderIdentification>							
	Annet...	Read: Reminder of the Availability of Draft El...	Thu 08 Jun 2023...	46 KB	This m...		
Disclaimer The information contained in this e-mail may be confidential, legally privileged and protected by law. Access by the intended recipient only is							
	Morga...	Read: Reminder of the Availability of Draft El...	Thu 08 Jun 2023...	48 KB	This m...		
Your message							
	Chris ...	Read: RE: Reminder of the Availability of Draf...	Thu 08 Jun 2023...	56 KB	This m...		
Your message							
	Howar...	Read: Reminder of the Availability of Draft El...	Thu 08 Jun 2023...	44 KB	This m...		
< Your message							
	Craig ...	Not read: Reminder of the Availability of Draf...	Thu 08 Jun 2023...	49 KB	This m...		
Your message							
	Lucky ...	Read: Reminder of the Availability of Draft El...	Thu 08 Jun 2023...	47 KB	This m...		
[You don't often get email from lucky.legodi@dalrtd.gov.za. Learn why this is important at https://aka.ms/LearnAboutSenderIdentification ] Disclaimer The							
	dmota...	Read: Reminder of the Availability of Draft El...	Thu 08 Jun 2023...	39 KB	This m...		
[The e-mail server of the sender could not be verified (SPF Record)] Your message							
	Azrah ...	Read: RE: Reminder of the Availability of Draf...	Thu 08 Jun 2023...	40 KB	This m...		
Your message							
	██████	Read: Reminder of the Availability of Draft EIA Re...	Thu 08 Jun 2023 ...	46 KB	This me...		
Your message							
	██████	Read: Reminder of the Availability of Draft El...	Thu 08 Jun 2023...	39 KB	This m...		
Your message							
	emoffi...	Read: Reminder of the Availability of Draft El...	Thu 08 Jun 2023...	41 KB	This m...		
You don't often get email from emoffice@pkstdm.gov.za. Learn why this is important <https://aka.ms/LearnAboutSenderIdentification>							
	otshek...	Read: Reminder of the Availability of Draft El...	Thu 08 Jun 2023...	39 KB	This m...		
[The e-mail server of the sender could not be verified (SPF Record)] Your message							
	Makh...	Read: Reminder of the Availability of Draft El...	Thu 08 Jun 2023...	40 KB	This m...		
Your message							
	idh@p...	Read: Reminder of the Availability of Draft El...	Thu 08 Jun 2023...	40 KB	This m...		
You don't often get email from idh@pkstdm.gov.za. Learn why this is important <https://aka.ms/LearnAboutSenderIdentification>							
	Jansen ...	Read: Reminder of the Availability of Draft EIA Re...	Thu 08 Jun 2023 ...	49 KB	This me...		
Your message							
	Poppi...	Read: Reminder of the Availability of Draft El...	Thu 08 Jun 2023...	37 KB	This m...		
You don't often get email from poppie.mahlangu@nersa.org.za. Learn why this is important <https://aka.ms/LearnAboutSenderIdentification>							
	Mama...	Read: Reminder of the Availability of Draft El...	Thu 08 Jun 2023...	49 KB	This m...		
You don't often get email from mamabefu.modpa@dmre.gov.za. Learn why this is important <https://aka.ms/LearnAboutSenderIdentification>							
	██████	Read: Reminder of the Availability of Draft El...	Thu 08 Jun 2023...	43 KB	This m...		
Your message							
	Julliet...	Read: Reminder of the Availability of Draft El...	Thu 08 Jun 2023...	40 KB	This m...		
Your message							
	Rohaid...	Read: Reminder of the Availability of Draft EIA Re...	Thu 08 Jun 2023 ...	21 KB	This me...		
Your message							
	ivisser...	Read: Reminder of the Availability of Draft El...	Thu 08 Jun 2023...	41 KB	This m...		
You don't often get email from ivisser@pkstdm.gov.za. Learn why this is important <https://aka.ms/LearnAboutSenderIdentification>							
	Joseph...	Read: Reminder of the Availability of Draft EIA Re...	Thu 08 Jun 2023 ...	50 KB	This me...		
You don't often get email from joren@attorneys.law.za. Learn why this is important <https://aka.ms/LearnAboutSenderIdentification>							
	██████	Read: Reminder of the Availability of Draft El...	Thu 08 Jun 2023...	36 KB	This m...		
You don't often get email from ██████████. Learn why this is important <https://aka.ms/LearnAboutSenderIdentification> Your							
	Natas...	Read: Reminder of the Availability of Draft El...	Thu 08 Jun 2023...	69 KB	This m...		
[The e-mail server of the sender failed SPF checks and maybe malicious (SPF Record)] Natasha Higgitt							
	Mpho ...	Read: Reminder of the Availability of Draft El...	Thu 08 Jun 2023...	48 KB	This m...		
Your message							

## APPENDICES

### ENVIRONMENTAL IMPACT ASSESSMENT REPORT: Scoping and Environmental Impact Assessment (EIA) Process for the Proposed Development of a Solar Photovoltaic (PV) Facility (Kudu Solar Facility 3) and associated infrastructure, near De Aar, Northern Cape Province

EMS - Read Receipts						By Date <span style="font-size: small;">v</span> <span style="font-size: small;">↑</span>			
				From	Subject	Received <span style="font-size: small;">v</span>	Size	Categories	Mention <span style="font-size: small;">v</span>
<input checked="" type="checkbox"/>				Mpho ...	Read: Reminder of the Availability of Draft EIA Re...	Thu 08 Jun 2023 ...	56 KB	This me...	
				Your message					
<input checked="" type="checkbox"/>				Nokuk...	Read: Reminder of the Availability of Draft EI...	Thu 08 Jun 2023...	69 KB	This m...	
				[The e-mail server of the sender failed SPF checks and maybe malicious (SPF Record)] Nokukhanya Khumalo					
<input checked="" type="checkbox"/>				pixley...	Read: Reminder of the Availability of Draft EI...	Thu 08 Jun 2023...	42 KB	This m...	
				You don't often get email from pixley@albieswireless.co.za. Learn why this is important <https://aka.ms/LearnAboutSenderIdentification>					
<input checked="" type="checkbox"/>				Christ...	Not read: [CAUTION:EXTERNAL EMAIL] RE: Re...	Thu 08 Jun 2023...	50 KB	This m...	
				Your message					
<input checked="" type="checkbox"/>				Sebenz...	Not read: [CAUTION:EXTERNAL EMAIL] RE: Remi...	Thu 08 Jun 2023 ...	52 KB	This me...	
				You don't often get email from vilakazs@eskom.co.za. Learn why this is important <https://aka.ms/LearnAboutSenderIdentification> Your					
<input checked="" type="checkbox"/>				Athish...	Not read: [CAUTION:EXTERNAL EMAIL] RE: Re...	Thu 08 Jun 2023...	50 KB	This m...	
				Your message					
<input checked="" type="checkbox"/>				Seten...	Not read: [CAUTION:EXTERNAL EMAIL] RE: Re...	Thu 08 Jun 2023...	52 KB	This m...	
				You don't often get email from mampursd@eskom.co.za. Learn why this is important <https://aka.ms/LearnAboutSenderIdentification> Your					
<input checked="" type="checkbox"/>				John ...	Not read: [CAUTION:EXTERNAL EMAIL] RE: Re...	Thu 08 Jun 2023...	50 KB	This m...	
				Your message					
<input checked="" type="checkbox"/>				Jayan...	Not read: [CAUTION:EXTERNAL EMAIL] RE: Re...	Thu 08 Jun 2023...	52 KB	This m...	
				You don't often get email from haridaj@eskom.co.za. Learn why this is important <https://aka.ms/LearnAboutSenderIdentification> Your					
<input checked="" type="checkbox"/>				David ...	Not read: [CAUTION:EXTERNAL EMAIL] RE: Re...	Thu 08 Jun 2023...	50 KB	This m...	
				Your message					
				EMS	Test	Mon 05 Jun 2023 ...	20 KB	This me...	
<input checked="" type="checkbox"/>				Mpho ...	Read: Availability of Draft EIA Reports for Comm...	Mon 05 Jun 2023 ...	47 KB	This me...	
				Your message					
<input checked="" type="checkbox"/>				Mama...	Read: Availability of Draft EIA Reports for Comm...	Sun 04 Jun 2023 ...	49 KB	This me...	
				You don't often get email from mamabefu.modipa@dmre.gov.za. Learn why this is important <https://aka.ms/LearnAboutSenderIdentification>					

## APPENDICES

### ENVIRONMENTAL IMPACT ASSESSMENT REPORT: Scoping and Environmental Impact Assessment (EIA) Process for the Proposed Development of a Solar Photovoltaic (PV) Facility (Kudu Solar Facility 3) and associated infrastructure, near De Aar, Northern Cape Province

Read receipts sent to [kudosolarpvprojects@gmail.com](mailto:kudosolarpvprojects@gmail.com)

Yesterday				
	[Redacted]	Read: Availability of Draft EIA Reports for Comment - Kudu Solar PV Facilities near De Aar, Northern Cape	Tue 04 Jul 2023 15:48	13 KB
	Your message			
Two Weeks Ago				
	[Redacted]	Read: Availability of Draft EIA Reports for Comment - Kudu Solar PV Facilities near De Aar, Northern Cape	Tue 20 Jun 2023 16:07	8 KB
	Your message			
Three Weeks Ago				
	asibeko@pkstdm.gov...	Read: Availability of Draft EIA Reports for Comment - Kudu Solar PV Facilities near De Aar, Northern Cape	Mon 12 Jun 2023 18:40	8 KB
	Your message			
	Info Dot	Read: Availability of Draft EIA Reports for Comment - Kudu Solar PV Facilities near De Aar, Northern Cape	Mon 12 Jun 2023 10:43	7 KB
	Your message			
Last Month				
	Cloete Shaun	Not read: Availability of Draft EIA Reports for Comment - Kudu Solar PV Facilities near De Aar, Northern ...	Wed 07 Jun 2023 20:30	13 KB
	Your message			
	Howard Hendricks	Read: Availability of Draft EIA Reports for Comment - Kudu Solar PV Facilities near De Aar, Northern Cape	Wed 07 Jun 2023 18:40	17 KB
	< Your message			
	emoffice@pkstdm.go...	Read: Availability of Draft EIA Reports for Comment - Kudu Solar PV Facilities near De Aar, Northern Cape	Wed 07 Jun 2023 12:21	8 KB
	Your message			
	[Redacted]	Read: Availability of Draft EIA Reports for Comment - Kudu Solar PV Facilities near De Aar, Northern Cape	Mon 05 Jun 2023 16:31	13 KB
	Your message			
	idh@pkstdm.gov.za	Read: Availability of Draft EIA Reports for Comment - Kudu Solar PV Facilities near De Aar, Northern Cape	Mon 05 Jun 2023 10:24	8 KB
	Your message			
	Jansen Melinda(UPN)	Read: Availability of Draft EIA Reports for Comment - Kudu Solar PV Facilities near De Aar, Northern Cape	Mon 05 Jun 2023 09:18	13 KB
	Your message			
	[Redacted]	Read: Availability of Draft EIA Reports for Comment - Kudu Solar PV Facilities near De Aar, Northern Cape	Mon 05 Jun 2023 08:25	8 KB
	Your message			
	dmotaung@pkstdm....	Read: Availability of Draft EIA Reports for Comment - Kudu Solar PV Facilities near De Aar, Northern Cape	Mon 05 Jun 2023 07:48	8 KB
	Your message			
	Rohaida Abed	Read: Availability of Draft EIA Reports for Comment - Kudu Solar PV Facilities near De Aar, Northern Cape	Sun 04 Jun 2023 18:43	13 KB
	Your message			
	[Redacted]	Read: Availability of Draft EIA Reports for Comment - Kudu Solar PV Facilities near De Aar, Northern Cape	Sat 03 Jun 2023 09:20	7 KB
	Your message			

## APPENDICES

### ENVIRONMENTAL IMPACT ASSESSMENT REPORT: Scoping and Environmental Impact Assessment (EIA) Process for the Proposed Development of a Solar Photovoltaic (PV) Facility (Kudu Solar Facility 3) and associated infrastructure, near De Aar, Northern Cape Province

#### 20. Automatic Replies Received in Response to All Email Communication Sent to Stakeholders During the DEIAR Release Phase

##### Auto-replies sent to [ems@csir.co.za](mailto:ems@csir.co.za)

EMS - Auto Replies					By Date ▾ ↑
From	Subject	Received	Size	Categories	Mention
<b>Monday</b>					
John ...	Automatic reply: Closure of the Comment ...	Mon 03 ...	55 KB		
[The e-mail server of the sender could not be verified (SPF Record)] I am on annual leave and will not be able to respond to e-mails until 10 July 2023					
Natas...	Automatic reply: Closure of the Comment ...	Mon 03 ...	59 KB		
Thank you for your email. Please note that I am onboarding and training new staff 3rd, 4th, 6th and 7th July. I will attend to emails when available.					
Const...	Automatic reply: Closure of the Comment ...	Mon 03 ...	47 KB		
[The e-mail server of the sender could not be verified (SPF Record)] Good Day Please note that I am currently out of office on annual leave. Regards					
Cobu...	Automatic reply: Closure of the Comment ...	Mon 03 ...	49 KB		
You don't often get email from cobust@ewt.org.za. Learn why this is important < <a href="https://aka.ms/LearnAboutSenderIdentification">https://aka.ms/LearnAboutSenderIdentification</a> >					
Janse...	Automatic reply: Closure of the Comment ...	Mon 03 ...	54 KB		
Please note that I will be away from the office until 17 July 2023. For urgent matters, please contact Andrea Campher at andrea@agrisa.co.za or Agri SA's					
Popp...	Automatic reply: Closure of the Comment ...	Mon 03 ...	44 KB		
You don't often get email from poppie.mahlangu@nersa.org.za. Learn why this is important < <a href="https://aka.ms/LearnAboutSenderIdentification">https://aka.ms/LearnAboutSenderIdentification</a> >					
Sama...	Change of Email Address Re: Closure of the...	Mon 03 ...	40 KB		
Hello,					
<b>Two Weeks Ago</b>					
Noku...	Automatic reply: Reminder of the Availabil...	Wed 21 ...	59 KB	This me...	
I am working outside the office from 21 June to 23 June 2023, I will have limited access to my emails during the day. For any urgent queries , please contact					
Anne...	Automatic reply: Reminder of the Availabil...	Wed 21 ...	39 KB	This me...	
You don't often get email from annelizac@dalrrd.gov.za. Learn why this is important < <a href="https://aka.ms/LearnAboutSenderIdentification">https://aka.ms/LearnAboutSenderIdentification</a> >					
Franc...	Automatic reply: Reminder of the Availabil...	Wed 21 ...	37 KB	This me...	
[The e-mail server of the sender could not be verified (SPF Record)] Good day. Please note that I am currently on leave and will be back in office on 11					
Abon...	Automatic reply: Reminder of the Availabil...	Wed 21 ...	57 KB	This me...	
You don't often get email from abongile.mgqada@vodacom.co.za. Learn why this is important < <a href="https://aka.ms/LearnAboutSenderIdentification">https://aka.ms/LearnAboutSenderIdentification</a> >					
Const...	Automatic reply: Reminder of the Availabil...	Wed 21 ...	46 KB	This me...	
[The e-mail server of the sender could not be verified (SPF Record)] Good Day Please note that I am currently out of office on annual leave. Regards					
Anne...	Automatic reply: Reminder of the Availabil...	Wed 21 ...	36 KB	This me...	
[The e-mail server of the sender could not be verified (SPF Record)] Good day I am out of office until further notice. For all other enquiries contact our					
Sama...	Automatic reply: [EXTERNAL]RE: Reminder ...	Wed 21 ...	51 KB	This me...	
Thank you for your e-mail. Please note that I'm currently out of office. I will respond on your e-mail once I'm back in office Monday, 26 June 2023. <end>					
Sama...	Change of Email Address RE: Reminder - A...	Wed 21 ...	40 KB	This me...	
Hello,					
<b>Last Month</b>					
██████	Automatic reply: Reminder of the Availabil...	Thu 08 J...	52 KB	This me...	
You don't often get email from ██████████. Learn why this is important < <a href="https://aka.ms/LearnAboutSenderIdentification">https://aka.ms/LearnAboutSenderIdentification</a> >					
Chris...	Automatic reply: Reminder of the Availabil...	Thu 08 J...	54 KB	This me...	
[The e-mail server of the sender could not be verified (SPF Record)] I am currently on site with limited acces to email. I will attend to your request on					
Sama...	Change of Email Address RE: Reminder of t...	Thu 08 J...	40 KB	This me...	
Hello,					
Elsab...	Out of office reply RE: Reminder of the Ava...	Thu 08 J...	38 KB	This me...	
Please note that I will not be in office until 18 June 2023. Please contact reception (053 807 7300) to direct you to someone who can assist you with your					

## APPENDICES

### ENVIRONMENTAL IMPACT ASSESSMENT REPORT: Scoping and Environmental Impact Assessment (EIA) Process for the Proposed Development of a Solar Photovoltaic (PV) Facility (Kudu Solar Facility 3) and associated infrastructure, near De Aar, Northern Cape Province

#### Auto-replies sent to [kudosolarpvprojects@gmail.com](mailto:kudosolarpvprojects@gmail.com)

All Unread By Date ▾ ↑

From	Subject	Received ▾	Size	🔍
<b>Last Month</b>				
██████████ I'm on Leave Will return to office on June 13	Automatic reply: Availability of Draft EIA Reports for Comment - Kudu Solar PV Facilities near De Aar, No...	Mon 05 Jun 2023 08:51	17 KB	
Portia Makitla	Automatic reply: Availability of Draft EIA Reports for Comment - Kudu Solar PV Facilities near De Aar, No... Please be advised that I am out of office until the 13th January 2023.	Fri 02 Jun 2023 23:49	12 KB	
Cobus Theron	Automatic reply: Availability of Draft EIA Reports for Comment - Kudu Solar PV Facilities near De Aar, No... Hi, Thank you for your mail. We are hosting our EWT connection week from 29 May to 2 June. As result I may not be able to respond promptly. Please WA	Fri 02 Jun 2023 23:36	12 KB	
EWT EIA Applications	Automatic reply: Availability of Draft EIA Reports for Comment - Kudu Solar PV Facilities near De Aar, No... Please note that this email address is an internal repository for development application documents only. Submissions to this email will not be considered as	Fri 02 Jun 2023 23:35	10 KB	

#### Auto-replies sent to [emspublicparticipation@gmail.com](mailto:emspublicparticipation@gmail.com)

All Unread By Date ▾ ↑

From	Subject	Received ▾	Size	🔍
<b>Last Month</b>				
EWT EIA Applications	Automatic reply: Availability of Draft EIA Reports for Comment - Kudu Solar PV Facilities near De Aar, No... Please note that this email address is an internal repository for development application documents only. Submissions to this email will not be considered as	Sat 03 Jun 2023 00:48	10 KB	
Cobus Theron	Automatic reply: Availability of Draft EIA Reports for Comment - Kudu Solar PV Facilities near De Aar, No... Hi, Thank you for your mail. We are hosting our EWT connection week from 29 May to 2 June. As result I may not be able to respond promptly. Please WA	Sat 03 Jun 2023 00:26	12 KB	



## APPENDICES

ENVIRONMENTAL IMPACT ASSESSMENT REPORT: Scoping and Environmental Impact Assessment (EIA) Process for the Proposed Development of a Solar Photovoltaic (PV) Facility (Kudu Solar Facility 3) and associated infrastructure, near De Aar, Northern Cape Province

---

### **APPENDIX H.5: PROOF OF SUBMISSION OF THE DRAFT EIA REPORT AND AMENDED APPLICATION FORM TO THE DFFE**

*App. H.5/...*

## APPENDICES

# ENVIRONMENTAL IMPACT ASSESSMENT REPORT: Scoping and Environmental Impact Assessment (EIA) Process for the Proposed Development of a Solar Photovoltaic (PV) Facility (Kudu Solar Facility 3) and associated infrastructure, near De Aar, Northern Cape Province

## 1. Copy of Email sent to the DFFE for Submission of the DEIAR and Amended Application Form on 2 June 2023 (Kudu Solar Facility 3)

**Rohaida Abed**

**From:** Rohaida Abed  
**Sent:** Friday, 02 June 2023 14:39  
**To:** EIA Applications  
**Cc:** Makhosi Yeni; Olivia Letlalo; Mahlatshe Shubane; Du Toit Malherbe; Petrus Scheepers; Rob Invernizzi; Paul Lochner; Helen Antonopoulos; Sonto Mkhize; Phindile Mthembu; Rohaida Abed  
**Subject:** 14/12/16/3/3/2/2246: Submission of Draft EIA Report and Amended EA Application: Kudu Solar Facility 3  
**Attachments:** 01\_DFFE Cover Letter\_Kudu Solar Facility 3\_DEIAR\_June2023.pdf; Kudu Solar Facility 3\_DEIAR\_Proof of Submission.PNG; Document Control Form\_Kudu Solar Facility 3\_June2023.pdf

**Categories:** This message has been archived by Retain on June 17 2023 07:08  
**Tracking:**

Recipient	Delivery	Read
EIA Applications		
Makhosi Yeni		
Olivia Letlalo		
Mahlatshe Shubane		
Du Toit Malherbe		
Petrus Scheepers		
Rob Invernizzi		
Paul Lochner	Delivered: 02 Jun 2023 14:39	
Helen Antonopoulos	Delivered: 02 Jun 2023 14:39	
Sonto Mkhize	Delivered: 02 Jun 2023 14:39	
Phindile Mthembu	Delivered: 02 Jun 2023 14:39	Read: 02 Jun 2023 15:10
Rohaida Abed		

Good day,

**DFFE Reference Number: 14/12/16/3/3/2/2246**

**SCOPING AND ENVIRONMENTAL IMPACT ASSESSMENT (EIA) PROCESS FOR THE PROPOSED DEVELOPMENT OF A SOLAR PHOTOVOLTAIC (PV) FACILITY (KUDU SOLAR FACILITY 3) AND ASSOCIATED INFRASTRUCTURE, NEAR DE AAR, NORTHERN CAPE PROVINCE**

Kindly note that the Draft EIA Report and Amended Application for Environmental Authorisation (EA), inclusive of all supporting appendices, as well as a Cover Letter for the above proposed Kudu Solar Facility 3 project (DFFE Reference Number: 14/12/16/3/3/2/2246) have been uploaded to the Novell S-File system for comment.

Please note that a pre-application meeting took place with the Competent Authority, the National Department of Forestry, Fisheries and the Environment (DFFE) on 26 April 2022 (Reference Number: 2022-04-0005), in order to discuss and agree on various aspects with the DFFE prior to release of the Draft Scoping Report. Refer to Appendix 1 of the Amended Application for EA for the proof of such correspondence, as well as Appendix D of the Draft EIA Report.

The Draft Scoping Report was made available to stakeholders and registered Interested and/or Affected Parties (I&APs) for a 30-day comment period extending from 9 December 2022 to 30 January 2023 (excluding the regulated shutdown period).

The Final Scoping Report was submitted to DFFE in February 2023. The DFFE provided written acceptance of the Final Scoping Report in March 2023.

The Draft EIA Report is being made available to potential and registered I&APs, Organs of State and relevant key stakeholders for a 30-day comment period extending from 2 June 2023 to 3 July 2023 (excluding public holidays).

The proposed project forms part of a cluster of twelve (12) Solar Facilities (i.e. Kudu Solar Facility 1 to Kudu Solar Facility 12) and are located on adjoining farm portions.

Separate Amended Applications for EA and Draft EIA Reports for each project have been compiled and are being uploaded to the system in parallel (separate emails are being sent for these).

The relevant DFFE officials have been copied on this email.

This submission is in line with the "Process for Submitting files to the CD IEA\_082022" document. To this end, please find attached to this email:

- Cover Letter to DFFE regarding submission of the Draft EIA Report for the abovementioned project;
- Proof of upload of the Amended Application for EA, Draft EIA Report and Appendices (i.e. Screenshot of the upload); and
- Document Control Form.

Kindly note that the Cover Letter is also included as part of the zipped folder uploaded.

We trust that you find this submission in order, and we look forward to your feedback.

Please do not hesitate to contact us should you have any queries relating to the above.

Thank you and kind regards,  
Rohaida



## APPENDICES

### ENVIRONMENTAL IMPACT ASSESSMENT REPORT: Scoping and Environmental Impact Assessment (EIA) Process for the Proposed Development of a Solar Photovoltaic (PV) Facility (Kudu Solar Facility 3) and associated infrastructure, near De Aar, Northern Cape Province

#### 2. Proof of Upload of the DEIAR to the DFFE Novell S-File System on 2 June 2023 (Kudu Solar Facility 3)

<input type="checkbox"/>	Name	Size	Modified
<input type="checkbox"/>	Mossel Bay Energy Wind Farm EA Amendmen.zip	6,674 KB	Jun 2, 2023 8:23 AM
<input type="checkbox"/>	Draft EIR_De Rust South_14-12-16-3-3-2-2261.zip	142,279 KB	Jun 2, 2023 2:18 PM
<input type="checkbox"/>	Draft EIR_De Rust PV2_14-12-16-3-3-2-2260.zip	99,069 KB	Jun 2, 2023 2:18 PM
<input type="checkbox"/>	Draft EIR_De Rust PV1_14-12-16-3-3-2-2259.zip	99,448 KB	Jun 2, 2023 2:17 PM
<input type="checkbox"/>	Draft EIR_De Rust North_14-12-16-3-3-2-2262.zip	155,951 KB	Jun 2, 2023 2:17 PM
<input checked="" type="checkbox"/>	14-12-16-3-3-2-2246_Kudu Solar Facility 3_DEIAR.zip	245,432 KB	Jun 2, 2023 1:57 PM
<input type="checkbox"/>	14-12-16-3-3-2-2245_Kudu Solar Facility 2_DEIAR.zip	245,272 KB	Jun 2, 2023 1:57 PM
<input type="checkbox"/>	14-12-16-3-3-2-2244_Kudu Solar Facility 1_DEIAR.zip	245,464 KB	Jun 2, 2023 1:56 PM
<input type="checkbox"/>	14-12-16-3-3-1-2347_Impala SPP Part 1 Amendment		Jun 2, 2023 2:56 PM
<input type="checkbox"/>	01 Unallocated - PLEASE DO NOT UPLOAD INTO OR DELETE THIS FOLDER		Jun 2, 2023 11:35 AM
<input type="checkbox"/>	00 Allocated - PLEASE DO NOT UPLOAD INTO OR DELETE THIS FOLDER		Jun 2, 2023 2:07 PM

1-11 of 11

## APPENDICES

### ENVIRONMENTAL IMPACT ASSESSMENT REPORT: Scoping and Environmental Impact Assessment (EIA) Process for the Proposed Development of a Solar Photovoltaic (PV) Facility (Kudu Solar Facility 3) and associated infrastructure, near De Aar, Northern Cape Province

---

#### 3. DFFE Acknowledgement of Receipt of the DEIAR (Kudu Solar Facility 3)

---

**Rohaida Abed**

---

**From:** Lydia Kutu <LKutu@dffe.gov.za>  
**Sent:** Tuesday, 06 June 2023 11:04  
**To:** Rohaida Abed; Du Toit Malherbe; Petrus Scheepers; Rob Invernizzi; Paul Lochner; Helen Antonopoulos; Sonto Mkize; Phindile Mthembu; Rohaida Abed  
**Cc:** Makhosi Yeni; ElAAdmin; Salome Mambane  
**Subject:** 14/12/16/3/3/2/2246

Dear Sir/Madam

**ACKNOWLEDGEMENT OF RECEIPT OF THE DRAFT ENVIRONMENTAL IMPACT ASSESSMENT REPORT AND AMENDED APPLICATION FORM FOR THE PROPOSED DEVELOPMENT OF A SOLAR PHOTOVOLTAIC (PV) FACILITY (KUDU SOLAR FACILITY 3) AND ASSOCIATED INFRASTRUCTURE, NEAR DE AAR, NORTHERN CAPE PROVINCE.**

The Department confirms having received the Draft Environmental Impact Assessment Report and Amended Application Form for the abovementioned project on 02 June 2023. You have submitted these documents to comply with the National Environmental Management Act, 1998 (Act No. 107 of 1998) and the Environmental Impact Assessment (EIA) Regulations, 2014, as amended.

Please take note of Regulation 40(3) of the EIA Regulations, 2014, as amended, which states that *"Potential or registered interested and affected parties, including the competent authority, may be provided with an opportunity to comment on reports and plans contemplated in subregulation (1) prior to submission of an application but must be provided with an opportunity to comment on such reports once an application has been submitted to the competent authority."*

Further note that in terms of Regulation 45 of the EIA Regulations, 2014, as amended, this application will lapse if the applicant fails to meet any of the time-frames prescribed in terms of these Regulations, unless an extension has been granted in terms of Regulation 3(7) of these Regulations.

You are hereby reminded of Section 24F of the National Environmental Management Act 1998 (Act No. 107 of 1998), as amended, that no activity may commence prior to an Environmental Authorisation being granted by the Department.

Kind Regards,  
Lydia Kutu  
Integrated Environmental Authorisations:  
Coordination, Strategic Planning and Support  
Tel: **(012) 399 9370**  
Email: [LKutu@dffe.gov.za](mailto:LKutu@dffe.gov.za)

*To God be the Glory!!!*

## APPENDICES

ENVIRONMENTAL IMPACT ASSESSMENT REPORT: Scoping and Environmental Impact Assessment (EIA) Process for the Proposed Development of a Solar Photovoltaic (PV) Facility (Kudu Solar Facility 3) and associated infrastructure, near De Aar, Northern Cape Province

---

### **APPENDIX H.6: COMMENTS RECEIVED FROM STAKEHOLDERS DURING THE 30-DAY REVIEW OF THE DRAFT EIA REPORT**

*App. H.6/...*

## APPENDICES

ENVIRONMENTAL IMPACT ASSESSMENT REPORT: Scoping and Environmental Impact Assessment (EIA) Process for the Proposed Development of a Solar Photovoltaic (PV) Facility (Kudu Solar Facility 3) and associated infrastructure, near De Aar, Northern Cape Province

---

### 1. Comments Received from the Department of Forestry, Fisheries and the Environment (DFFE)

---

#### 1.1 The DFFE Directorate: Integrated Environmental Authorisation (Kudu Solar Facility 3)

---

---

**From:** Ephron Maradwa <EMaradwa@dffe.gov.za>  
**Sent:** Thursday, June 29, 2023 2:17 PM  
**To:** Rohaida Abed <RAbed@csir.co.za>  
**Cc:** Paul Lochner <PLochner@csir.co.za>; Makhosi Yeni <MYeni@dffe.gov.za>; Salome Mambane <SMAMBANE@dffe.gov.za>; EIAAdmin <EIAAdmin@dffe.gov.za>; Lydia Kutu <LKutu@dffe.gov.za>; sdelafontaine@gmail.com; Petrus.Scheepers@abo-wind.com  
**Subject:** 14/12/16/3/3/2/2246

Good day.

Please find herein the attached letter for the above mentioned.

**Please do not respond to this mailbox with any queries related to the decision been issued. All queries on the attached decision must be directed to official whose contact details is listed as enquiries.**

I hope you find all in order.

**EIA Applications**  
Integrated Environmental Authorisations  
Department of Forestry, Fisheries and the Environment

**Please note that this email is for the receipt and processing of online applications only, and is not monitored for responses. All queries must be directed to [EIAAdmin@dffe.gov.za](mailto:EIAAdmin@dffe.gov.za).**

**You are advised that this mailbox has a 48 hour response time.**

*Please note that this mailbox has a 5mb mail limit. No zip files are to be attached in any email.*

## APPENDICES

### ENVIRONMENTAL IMPACT ASSESSMENT REPORT: Scoping and Environmental Impact Assessment (EIA) Process for the Proposed Development of a Solar Photovoltaic (PV) Facility (Kudu Solar Facility 3) and associated infrastructure, near De Aar, Northern Cape Province

---



forestry, fisheries  
& the environment

Department:  
Forestry, Fisheries and the Environment  
REPUBLIC OF SOUTH AFRICA

Private Bag X 447- PRETORIA 0001- Environment House 473 Steve Biko Road, Arcadia, - PRETORIA

DFFE Reference: 14/12/16/3/3/2/2246

Enquiries: Ms Olivia Letlalo

Telephone: (012) 399 8815 E-mail: oletlalo@dffe.gov.za

Paul Lochner  
Council for Scientific and Industrial Research (CSIR)  
PO Box 320  
STELLENBOSCH  
7599

Telephone Number: +27 21 888 2486/2400  
Cell phone Number: [REDACTED]  
Email Address: [PLochner@csir.co.za](mailto:PLochner@csir.co.za) / [RAbed@csir.co.za](mailto:RAbed@csir.co.za)

PER MAIL / E-MAIL

Dear Mr Lochner

#### COMMENTS ON THE DRAFT ENVIRONMENTAL IMPACT ASSESSMENT REPORT FOR THE PROPOSED KUDU SOLAR FACILITY 3 AND ASSOCIATED INFRASTRUCTURE NEAR DE AAR IN THE NORTHERN CAPE PROVINCE

The application for Environmental Authorisation (EA) and Draft Environmental Impact Assessment Report (EIAr) received by the Competent Authority (CA) on 02 June 2023, refer.

This letter serves to inform you that the following information must be included in the final EIAr:

##### a) Listed Activities

- On page 9 of the Summary for the proposed development, it has been noted that the component includes switching station and collector station (~2 ha), which will be undertaken in a separate application. You were requested in the letter dated 27 March 2023, to exclude these infrastructures as part of the component for the proposed development, however, the information has not been removed. Please ensure only relevant components related to the proposed development are included in the final EIAr.
- It has been noted that activity 4 and 23 of Listing Notice 3 have been applied due the Critical Biodiversity Area been affected by the proposed development. However, figure 4-2 in Chapter 7 indicate that the site falls within an Ecological Support Area. Therefore, you are requested to clarify the applicability of this listed activity considering that listed activity in the EIA Regulation, 2014 as amended only refers to the Critical biodiversity areas as identified in systematic biodiversity plans adopted by the competent authority or in bioregional plans.
- It has been noted that in the description of the project for triggered listed activities under LN 3, it has been indicated that the activities are triggered because the "Northern Cape DAEARDLR confirmed that the Critical Biodiversity Area identified in a systematic biodiversity plan has been adopted by the CA. Therefore, you are requested to include the confirmation letter in the final EIAr and reference it in the description of the project.

*M*

## APPENDICES

### ENVIRONMENTAL IMPACT ASSESSMENT REPORT: Scoping and Environmental Impact Assessment (EIA) Process for the Proposed Development of a Solar Photovoltaic (PV) Facility (Kudu Solar Facility 3) and associated infrastructure, near De Aar, Northern Cape Province

---

Chief Directorate: Integrated Environmental Authorisations

---

- It has been noted that activity 15 of Listing Notice (LN) 2 has been applied for because 34ha of indigenous vegetation will be cleared. You are requested to indicate in the description of the project, the type of indigenous vegetation that would be cleared for the proposed development.
- Please ensure that all relevant listed activities are applied for, are specific and can be linked to the development activity or infrastructure as described in the project description. Only activities applicable to the development must be applied for and assessed.
- If the activities applied for in the application form differ from those mentioned in the final EIAR, an amended application form must be submitted. Please note that the Department's application form template has been amended and can be downloaded from the following link <https://www.environment.gov.za/documents/forms>.

#### b) Specialist Assessments

- According to figure 4-5 in Chapter 7: Terrestrial Biodiversity, Plant and Animal species assessment report dated May 2023, the proposed Kudu solar facility 3 is located within an area with White Grassland habitat, which is considered moderately sensitive, suitable for foraging and nesting for fauna species including reptile like Puffadders and Cobras, small mammals like squirrels and mongoose, and grassland birds. Based on the above, please provide clarity as to why the site is considered suitable for the proposed development.
- Furthermore, it has been indicated in the aforesaid specialist report that watercourse habitat performs important ecosystem functions such as regulating water runoff and creating suitable conditions important for the survival of many fauna species including foraging and breeding habitat. Therefore, you are requested to show the watercourses on site as well as floodplains (as shown on figure 7 and 10, page 8-26 and 30 of Chapter 8: Aquatic Biodiversity) and wetlands and ensure the watercourses and its buffer zone are not affected by the proposed development.
- During the review of the draft EIAR, it has been noted that the specialists refer to the study area and not specific site development, therefore, you are requested to ensure the following is considered and be incorporated in the final report:
  - Considering that the specialists were undertaken for the whole study area (for cluster projects), you are requested to provide a summary in a table format of each specialist, indicating sensitive features to be affected on a specific site development layout plan and the recommendation for the proposed development.
  - Further to the above, you are requested to provide in the final report a development layout plan that shows the sensitive features in relation to the proposed development.
  - ✓ The CA acknowledge that specialist studies are conducted, however, advise that studies that are conducted in accordance with the Procedures for the Assessment and Minimum Criteria for Reporting on identified Environmental Themes in terms of Sections 24(5)(a) and (h) and 44 of the National Environmental Management Act, 1998, when applying for Environmental Authorisation, which were promulgated in Government Notice No. 320 of 20 March 2020 (i.e., "the Protocols"), and in Government Notice No. 1150 of 30 October 2020, are included in the final EIAR. Additionally, the protocols specify that an assessment must be prepared by a specialist who is an expert in the field and is SACNASP registered for e.g. an aquatic assessment must be prepared by a specialist registered with SACNASP, with expertise in the field of aquatics sciences.
- Please note that comments dated 27 March 2023 are still valid and must be addressed accordingly in the final EIAR.

#### c) Cumulative Assessment

- Please note that comments dated 27 March 2023 are still valid and must be addressed accordingly in the final EIAR.



## APPENDICES

### ENVIRONMENTAL IMPACT ASSESSMENT REPORT: Scoping and Environmental Impact Assessment (EIA) Process for the Proposed Development of a Solar Photovoltaic (PV) Facility (Kudu Solar Facility 3) and associated infrastructure, near De Aar, Northern Cape Province

---

Chief Directorate: Integrated Environmental Authorisations

---

#### d) Layout & Sensitivity Maps

- The CA acknowledge the inclusion of the layout maps in Chapter 20 of the draft EIAR, however, request that only a layout showing the proposed Kudu solar facility 3 with sensitive features must be submitted with the final EIAR.
- It has been noted that the proposed development overlaps the area identified as high sensitive as per figure 20-4 in Chapter 20, therefore, you are advised to submit with the final EIAR, a layout map that does not affect sensitive areas.
- Please provide a layout map which indicates the following:
  - The PV development area.
  - Position of all infrastructure e.g., panels, BESS, on-site substations, grid connection etc.
  - Permanent laydown area footprint.
  - All supporting onsite infrastructure e.g., roads (existing and proposed).
  - Substation(s) and/or transformer(s) sites including their entire footprint.
  - All existing infrastructure on the site.
  - The location of sensitive environmental features on site e.g., CBAs, provincially protected species such as *Aloe broomii*, *Jamesbrittenia tysonii* and *Ruschia intricate*, Eagle nest, heritage sites, visual sites as indicated on page 20-5 of Chapter 20, wetlands and drainage lines – 35m, koppies, etc. that will be affected.
  - Buffer areas; and
  - All "no-go" areas.
- The above map must be overlain with a sensitivity map and a cumulative map which shows neighbouring renewable energy developments and existing grid infrastructure. All available biodiversity information must be used in the finalisation of the map and infrastructure must not encroach on highly sensitive areas as far as possible.
- Ensure that similar colours are not used to differentiate between infrastructure. i.e., items must be easily distinguishable in the Legend.
- Google maps will not be accepted for decision-making purposes.

#### e) Public Participation Process

- You are advised to undertake PPP as per the requirements of the EIA Regulations, 2014 as amended and ensure comments raised in the letter dated 27 March 2023 are adequately addressed.

#### f) Environmental Management Programme (EMPr)

- The EMPr for the facility must comply with the requirements of Appendix 4 in the EIA Regulation, as amended.
- It has been noted that the EMPr for the substation has been submitted with the draft EIAR, however, you are advised to ensure that the generic EMPr in line with the generic EMPr that complies with the GN 435 of March 2022 is submit with the final report. You are also advised to sign Part B: Section 2 of the generic EMPr and ensure a copy of an originally signed generic EMPr is be submitted with the final EIAR.
- In addition, if any specific environmental sensitivities/attributes are present on the site which require more specific impact management outcomes and impact management actions, not included in the pre-approved generic EMPr template, to manage impacts, those impact management outcomes and actions must be included in section C of the generic EMPr.

#### General

Please also ensure that the final EIAR includes the period for which the Environmental Authorisation is required and the date on which the activity will be concluded as per Appendix 3 of the NEMA EIA Regulations, 2014, as amended.

DFFE Reference: 14/12/16/3/3/2246

Comments on the draft Environmental Impact Assessment Report for the proposed Kudu solar facility 3 and associated infrastructure near De Aar in the Northern Cape Province

M

## APPENDICES

### ENVIRONMENTAL IMPACT ASSESSMENT REPORT: Scoping and Environmental Impact Assessment (EIA) Process for the Proposed Development of a Solar Photovoltaic (PV) Facility (Kudu Solar Facility 3) and associated infrastructure, near De Aar, Northern Cape Province

---

#### 1.2 The DFFE Directorate: Biodiversity Conservation

---

**From:** Kamogelo Mathetja <KMathetja@dffe.gov.za>  
**Sent:** Monday, June 5, 2023 4:11 PM  
**To:** Kudu Solar PV Projects <kudusolarpvprojects@gmail.com>  
**Cc:** Mashudu Mudau <MaMudau@dffe.gov.za>; Tebego Kgaphola <tkgaphola1@dffe.gov.za>; Mashudu Mudau <MaMudau@dffe.gov.za>  
**Subject:** RE: Availability of Draft EIA Reports for Comment - Kudu Solar PV Facilities near De Aar, Northern Cape

Dear Sir/Madam

DFFE Directorate: Biodiversity Conservation hereby acknowledge receipt of the invitation to review and comment on the project mentioned on the subject line. Kindly note that the project has been allocated to Mrs P Makitla and Ms M Mudau (Both copied on this email). In addition, kindly share the shapefiles of the development footprints/application site with the Case Officers.

Please note: All Public Participation Process documents related to Biodiversity EIA review and any other Biodiversity EIA queries must be submitted to the Directorate: Biodiversity Conservation at Email: [BCAdmin@environment.gov.za](mailto:BCAdmin@environment.gov.za) for attention of Mr Seoka Lekota

Regards,

Kamogelo

**From:** Portia Makitla <PMakitla@dffe.gov.za>  
**Sent:** Monday, July 3, 2023 12:46 PM  
**To:** EMS <ems@csir.co.za>  
**Cc:** Mashudu Mudau <MaMudau@dffe.gov.za>; Tebego Kgaphola <tkgaphola1@dffe.gov.za>  
**Subject:** Draft EIA Reports for the Proposed Development of the 12 Kudu Solar Photovoltaic Facilities, near De Aar, Northern Cape

Good day,

Herewith please find the aforementioned project comments.

*Thanks & Regards* 

Ms. Mashienyane Portia Makitla  
**B&C: Biodiversity Mainstreaming & EIA**  
Department of Forestry, Fisheries and the Environment  
Environment House  
473 Steve Biko and Soutpansberg Streets  
PRETORIA  
Tel: (012) 399 9411  
E-mail: [pmakitla@dffe.gov.za](mailto:pmakitla@dffe.gov.za)  
Call Centre: 086 111 2468

## APPENDICES

### ENVIRONMENTAL IMPACT ASSESSMENT REPORT: Scoping and Environmental Impact Assessment (EIA) Process for the Proposed Development of a Solar Photovoltaic (PV) Facility (Kudu Solar Facility 3) and associated infrastructure, near De Aar, Northern Cape Province

---



forestry, fisheries  
& the environment

Department:  
Forestry, Fisheries and the Environment  
REPUBLIC OF SOUTH AFRICA

Private Bag X447, Pretoria, 0001, Environment House, 473 Steve Biko Road, Pretoria, 0002 Tel: +27 12 399 9000, Fax: + 27 86 625 1042

Reference: KUDU OV FACILITIES  
Enquiries: Ms M Mudau/ T Kgaphola  
Telephone: (012) 399 9411 E-mail: [pmakita@dfre.gov.za](mailto:pmakita@dfre.gov.za)

Rohaida Abed  
CSIR  
P. O. Box 320  
Stellenbosch  
7599

Telephone Number: (+ 27) 21 888 2400  
Email Address: [ems@csir.co.za](mailto:ems@csir.co.za)

#### PER E-MAIL

Dear Sir/Madam

#### COMMENTS ON THE DRAFT ENVIRONMENTAL IMPACT ASSESSMENT REPORTS FOR THE PROPOSED DEVELOPMENT OF A SOLAR PHOTOVOLTAIC (PV) FACILITIES AND ASSOCIATED INFRASTRUCTURE, NEAR DE AAR, NORTHERN CAPE PROVINCE

The Directorate: Biodiversity Conservation reviewed and evaluated the draft report.

Based on the information provided in the reports, the entire site and all identified buildable areas and development footprints, are located within the ESA, the ESA is due to the site being in the Platberg-Karoo Conservancy (not formally protected), the vegetation units and important wetland and river features. Five Species of Conservation Concern (SCC) species were recorded during the site surveys, namely Blue Crane, Martial Eagle, Verreaux's Eagle, Cape Vultures and White-backed Vulture. However, it is noted that the recommendations of the Aquatic and Avifauna Specialists have been taken into consideration in the layout planning, and sensitive areas have been avoided accordingly. The protected tree *Boscia albitrunca* occurs in the Shrubby Grassland at the base of a Koppie. The overall sensitivity of the site is considered medium, with some landscape features, including the Koppies, as medium sensitivity.

Most of the cumulative negative impacts were rated with a low post mitigation impact significance for the construction phase, apart from Terrestrial. A similar trend is applicable to the operational phase, Avifauna impacts being rated as moderate.

Based on the above the Directorate Biodiversity Conservation is of the view that with stringent mitigation measures the development impacts can be mitigated to acceptable level.



Batho pele- putting people first

## APPENDICES

### ENVIRONMENTAL IMPACT ASSESSMENT REPORT: Scoping and Environmental Impact Assessment (EIA) Process for the Proposed Development of a Solar Photovoltaic (PV) Facility (Kudu Solar Facility 3) and associated infrastructure, near De Aar, Northern Cape Province

---

**COMMENTS ON THE DRAFT ENVIRONMENTAL IMPACT ASSESSMENT REPORTS FOR THE PROPOSED DEVELOPMENT OF A SOLAR PHOTOVOLTAIC (PV) FACILITY (KUDU SOLAR FACILITY 1) AND ASSOCIATED INFRASTRUCTURE, NEAR DE AAR, NORTHERN CAPE PROVINCE**

All Public Participation Process documents related to Biodiversity EIA review and any other Biodiversity EIA queries must be submitted to the Directorate: Biodiversity Conservation at Email: [BCAdmin@environment.gov.za](mailto:BCAdmin@environment.gov.za) for attention of **Mr Seoka Lekota**.

Yours faithfully



**Mr. Seoka Lekota**  
Control Biodiversity Officer Grade B: Biodiversity Conservation  
Department of Forestry, Fisheries & the Environment  
Letter signed by: Ms P Makitla  
Designation: Control Biodiversity Officer  
Date: 03/07/2023

## APPENDICES

ENVIRONMENTAL IMPACT ASSESSMENT REPORT: Scoping and Environmental Impact Assessment (EIA) Process for the Proposed Development of a Solar Photovoltaic (PV) Facility (Kudu Solar Facility 3) and associated infrastructure, near De Aar, Northern Cape Province

---

**From:** EMS <ems@csir.co.za>  
**Sent:** Monday, July 3, 2023 2:29 PM  
**To:** Portia Makitla <PMakitla@dffe.gov.za>  
**Cc:** Mashudu Mudau <MaMudau@dffe.gov.za>; Tebego Kgaphola <tkgaphola1@dffe.gov.za>; EMS <ems@csir.co.za>  
**Subject:** RE: Draft EIA Reports for the Proposed Development of the 12 Kudu Solar Photovoltaic Facilities, near De Aar, Northern Cape

Dear Portia

Thank you very much for the comments on the proposed Kudu Solar Facilities. Please kindly confirm that these comments apply to **all 12 Kudu Solar Facilities** (and not just Kudu Solar Facility 1)?

Kind Regards  
Rohaida

**From:** Portia Makitla <PMakitla@dffe.gov.za>  
**Sent:** Monday, 03 July 2023 14:40  
**To:** EMS  
**Cc:** Mashudu Mudau; Tebego Kgaphola  
**Subject:** RE: Draft EIA Reports for the Proposed Development of the 12 Kudu Solar Photovoltaic Facilities, near De Aar, Northern Cape

Dear Rohaida

The comments applies to all the proposed facilities.

*Thanks & Regards*



Ms. Mashienyane Portia Makitla  
**B&C: Biodiversity Mainstreaming & EIA**  
Department of Forestry, Fisheries and the Environment  
Environment House  
473 Steve Biko and Soutpansberg Streets  
PRETORIA  
Tel: (012) 399 9411  
E-mail: [pmakitla@dffe.gov.za](mailto:pmakitla@dffe.gov.za)  
Call Centre: 086 111 2468



## APPENDICES

### ENVIRONMENTAL IMPACT ASSESSMENT REPORT: Scoping and Environmental Impact Assessment (EIA) Process for the Proposed Development of a Solar Photovoltaic (PV) Facility (Kudu Solar Facility 3) and associated infrastructure, near De Aar, Northern Cape Province

#### 1.3 The DFFE Directorate: Protected Areas

**From:** Lindokuhle Vilakati <LVilakati@dffe.gov.za>  
**Sent:** Wednesday, 05 July 2023 15:22  
**To:** EMS  
**Cc:** Thivhulawi Nethononda; Karl Naude  
**Subject:** Comments on the Draft EIA Reports for Kudu Solar PV  
**Attachments:** PA Register Overview.PNG

Dear Rohaida

The Directorate: Protected Areas Planning and Management Effectiveness (PAPME), would like to thank you for the opportunity to review the Draft EIA Reports for the proposed 12 Solar Photovoltaic (PV) facilities (i.e. Kudu Solar Facilities) and various associated infrastructure, near De Aar, Northern Cape .

After conducting the review of the availed documents, we have noted that the proposed developments will not take place within any kind of protected areas recognized in terms of Section 9 of the National Environmental Management: Protected Areas Act (NEMPAA), Act No. 57 of 2003 and their buffers. The PAPME directorate provides comments or input on the projects which are affecting the National Protected Areas and National Protected Areas Expansion Strategy (NPAES).

Kind Regards,  
Lindokuhle Vilakati

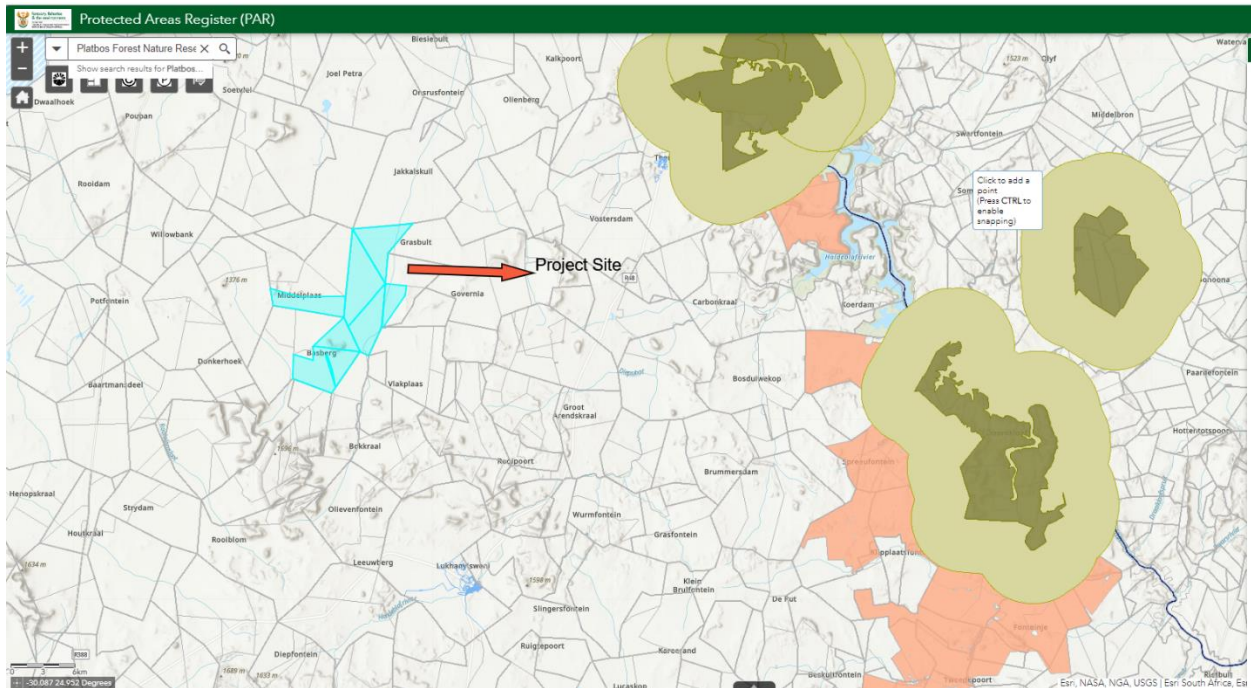

## APPENDICES

ENVIRONMENTAL IMPACT ASSESSMENT REPORT: Scoping and Environmental Impact Assessment (EIA) Process for the Proposed Development of a Solar Photovoltaic (PV) Facility (Kudu Solar Facility 3) and associated infrastructure, near De Aar, Northern Cape Province

---

### 2. Comments received from the Department of Agriculture, Land Reform and Rural Development

---

**From:** Annette Geertsema <AnnetteS@Dalrrd.gov.za>  
**Sent:** Thursday, 08 June 2023 15:33  
**To:** EMS  
**Subject:** RE: Kudu Solar Facilities - Draft EIA Report for Comment + Title Deed - Email 1 of 2

**Categories:** This message has been archived by Retain on June 20 2023 13:07

Good day

The information is appreciated and you will receive an acknowledgement of receipt shortly.

Regards  
Annette

**From:** Annette Geertsema <AnnetteS@Dalrrd.gov.za>  
**Sent:** Friday, 09 June 2023 08:08  
**To:** EMS  
**Subject:** RE: Kudu Solar Facilities - Draft EIA Report for Comment + Title Deed - Email 1 of 2

**Categories:** This message has been archived by Retain on June 20 2023 13:07

Good day

The information is appreciated and you will receive an acknowledgement of receipt shortly.

Regards  
Annette

## APPENDICES

### ENVIRONMENTAL IMPACT ASSESSMENT REPORT: Scoping and Environmental Impact Assessment (EIA) Process for the Proposed Development of a Solar Photovoltaic (PV) Facility (Kudu Solar Facility 3) and associated infrastructure, near De Aar, Northern Cape Province

---

**From:** Barbara De Lange <BarbaraD@Dalrrd.gov.za>  
**Sent:** Monday, 12 June 2023 13:58  
**To:** EMS

You don't often get email from barbarad@dalrrd.gov.za. [Learn why this is important](#)

good day  
please receive reference number for application Barberg 88 & Grasspan 40 ( various farms ) & ( various portions ) ( Kudu Solar 1 & 2 )  
Rezoning  
2023\_06\_0057  
E mail  
[thembin@dalrrd.gov.za](mailto:thembin@dalrrd.gov.za)  
regards  
Barbara de lange

#### Disclaimer

The information contained in this e-mail may be confidential, legally privileged and protected by law. Access by the intended recipient only is authorised. If you are not the intended recipient, kindly notify the sender immediately. Unauthorised use, copying or dissemination hereof is strictly prohibited. Save for bona fide departmental purposes, the Department of Agriculture, Land Reform and Rural Development does not accept responsibility for the contents or opinions expressed in this e-mail, nor does it warrant this communication to be free from errors, contamination, interference or interception.

**From:** Agriland <AgrilandC@Dalrrd.gov.za>  
**Sent:** Tuesday, 13 June 2023 16:25  
**To:** EMS  
**Cc:** Mashudu Marubini  
**Subject:** AgriLand reference number: 2023\_06\_0057 - Subdivision of Agricultural Land (Act70 of 1970)

Dear Csir,

The Department hereby acknowledge receipt of your application for Barberg 88 Graspan 40 Annex Wolvekuil 41 Wolvekuil 43 Wolvekuilen 42 ( Kudu Solar 1 & 2 ) ( Various Portions ).

The reference number for your application is: 2023\_06\_0057

Best regards,

AgriLand System  
(Auto-generated e-mail - Please do NOT reply)

#### Disclaimer

The information contained in this e-mail may be confidential, legally privileged and protected by law. Access by the intended recipient only is authorised. If you are not the intended recipient, kindly notify the sender immediately. Unauthorised use, copying or dissemination hereof is strictly prohibited. Save for bona fide departmental purposes, the Department of Agriculture, Land Reform and Rural Development does not accept responsibility for the contents or opinions expressed in this e-mail, nor does it warrant this communication to be free from errors, contamination, interference or interception.



## APPENDICES

### ENVIRONMENTAL IMPACT ASSESSMENT REPORT: Scoping and Environmental Impact Assessment (EIA) Process for the Proposed Development of a Solar Photovoltaic (PV) Facility (Kudu Solar Facility 3) and associated infrastructure, near De Aar, Northern Cape Province

---

**From:** Thembi Nyoka <ThembiNy@dalrrd.gov.za>  
**Sent:** Wednesday, 14 June 2023 10:27  
**To:** EMS  
**Subject:** Kudu solar facilities 1-12 Northern Cape

You don't often get email from thembiny@dalrrd.gov.za. [Learn why this is important](#)

Good morning

Kindly forward me the hectares of each property that are involved in the project and the total footprint that will be used for the whole project. I am the official working with your application. I need that information so as to process your application further.

Do not hesitate to call me for more.

I hope you will find this in order,

Kind regards

Thembi

*Thembi Nyoka  
Department of Rural Development and Land Reform  
Delpen Building  
Pretoria  
012 319 7538*

## APPENDICES

### ENVIRONMENTAL IMPACT ASSESSMENT REPORT: Scoping and Environmental Impact Assessment (EIA) Process for the Proposed Development of a Solar Photovoltaic (PV) Facility (Kudu Solar Facility 3) and associated infrastructure, near De Aar, Northern Cape Province

**From:** EMS <ems@csir.co.za>  
**Sent:** Tuesday, June 20, 2023 5:14 PM  
**To:** Thembi Nyoka <ThembiNy@dalrrd.gov.za>  
**Cc:** EMS <ems@csir.co.za>  
**Subject:** RE: Kudu solar facilities 1-12 Northern Cape

Dear Thembi

Thank you for your email.

Please kindly see below a table of the hectares of each property that forms part of the study area for all 12 Kudu Solar Facilities:

No	Title Deed descriptions	Size	Entity
1	Remaining Extent of the Farm Bas Berg No. 88, situated in the Pixley Ka Seme District municipality, Registration Division Philipstown, Northern Cape Province in extent 770,2315 (SEVEN SEVEN ZERO comma TWO THREE ONE FIVE) Hectares.	770,2315 ha	
2	Remaining Extent of Portion 3 of the Farm Bas Berg No. 88, situated in the Pixley Ka Seme District municipality, Registration Division Philipstown, Northern Cape Province in extent of 1687,3612 (ONE SIX EIGHT SEVEN comma THREE SIX ONE TWO) Hectares.	1687,3612	
3	Portion 4 (Portion of portion 3) of the Farm Bas Berg No. 88 situated in the Pixley Ka Seme District municipality, Registration Division Philipstown, Northern Cape Province in extent of 25,7008 (TWO FIVE comma SEVEN ZERO ZERO EIGHT) Hectares.	25,7008	
4	Remaining Extent of Portion 2 (Middel Plaats) (a portion of Portion 1) of the farm GRASSPAN No. 40, situated in the Registration Division of Philipstown, in extent One Thousand and Fifty-Four comma Three Six Two Two (1054,3622) Hectares.	1054,3622	
5	REMAINING EXTENT of the farm ANNEX WOLVE KUIL No. 41, situated in the Registration Division of PHILIPSTOWN, NORTHERN CAPE PROVINCE in extent of 1127,8542 (ONE THOUSAND ONE HUNDRED AND TWENTY SEVEN COMMA EIGHT FIVE FOUR TWO) hectares.	1127,8542	
6	PORTION 1 (WOLVE KUIL WEST) of the farm ANNEX WOLVE KUIL No. 41, situated in the Registration Division of PHILIPSTOWN, NORTHERN CAPE PROVINCE in extent of 1707,7421 (ONE THOUSAND SEVEN HUNDRED AND SEVEN COMMA SEVEN FOUR TWO ONE) hectares.	1707,7421	
7	PORTION 2 of the farm WOLVE KUIL No. 43, situated in the Registration Division of PHILIPSTOWN, NORTHERN CAPE PROVINCE in extent of 1238,3425 (ONE THOUSAND AND THIRTY-EIGHT COMMA THREE FOUR TWO FIVE) hectares.	1238,3425	
8	REMAINING EXTENT of the farm WOLVE KUILEN No. 42, situated in the Registration Division of PHILIPSTOWN, NORTHERN CAPE PROVINCE in extent of 521,3489 (FIVE HUNDRED AND TWENTY-ONE COMMA THREE FOUR EIGHT NINE) hectares.	521,3489	
	<b>Total</b>	<b>8 132,94</b>	

## APPENDICES

### ENVIRONMENTAL IMPACT ASSESSMENT REPORT: Scoping and Environmental Impact Assessment (EIA) Process for the Proposed Development of a Solar Photovoltaic (PV) Facility (Kudu Solar Facility 3) and associated infrastructure, near De Aar, Northern Cape Province

---

The total footprint of the entire project (i.e. all 12 PV Facilities) is 3268 ha.

Please kindly let me know if you need any additional information.

Comments on the Draft EIA Report close on 3 July 2023. We look forward to your comments.

Thanks  
Rohaida

CSIR Environmental Management Services  
E-mail: [ems@csir.co.za](mailto:ems@csir.co.za)  
Postal Address: Postnet Suite 367, Private Bag x10, Musgrave Road, 4062  
Tel: 031 242 2300

**From:** EMS <[ems@csir.co.za](mailto:ems@csir.co.za)>  
**Sent:** Friday, 23 June 2023 10:27  
**To:** Thembi Nyoka; Mashudu Marubini; Annette Geertsema; Barbara De Lange  
**Cc:** EMS  
**Subject:** RE: Kudu solar facilities 1-12 Northern Cape

**Categories:** This message has been archived by Retain on July 01 2023 06:15

Good day DALRRD officials

I trust that you are well. I am kindly querying if the reference number **2023\_06\_0057** applies to all 12 Kudu Solar Facilities? We received the following auto-generated email:

*Dear Csir,*

*The Department hereby acknowledge receipt of your application for Barberg 88 Graspan 40 Annex Wolvekuil 41 Wolvekuil 43 Wolvekuilen 42 ( Kudu Solar 1 & 2 ) ( Various Portions ).*

*The reference number for your application is: 2023\_06\_0057*

*Best regards,*

*AgriLand System  
(Auto-generated e-mail - Please do NOT reply)*

Please kindly indicate if you have received the info below, and if you are able to comment on the projects by 3 July 2023?

Thank you and kind regards,  
Rohaida

CSIR Environmental Management Services  
E-mail: [ems@csir.co.za](mailto:ems@csir.co.za)  
Postal Address: Postnet Suite 367, Private Bag x10, Musgrave Road, 4062  
Tel: 031 242 2300

## APPENDICES

ENVIRONMENTAL IMPACT ASSESSMENT REPORT: Scoping and Environmental Impact Assessment (EIA) Process for the Proposed Development of a Solar Photovoltaic (PV) Facility (Kudu Solar Facility 3) and associated infrastructure, near De Aar, Northern Cape Province

---

**From:** Thembi Nyoka <ThembiNy@dalrrd.gov.za>  
**Sent:** Wednesday, 28 June 2023 13:40  
**To:** EMS  
**Subject:** RE: Kudu solar facilities 1-12 Northern Cape

Good day

Your application is on step 5 of 8 waiting for the committee and it included all projects

**From:** EMS <ems@csir.co.za>  
**Sent:** Tuesday, 27 June 2023 12:47  
**To:** Thembi Nyoka  
**Cc:** EMS  
**Subject:** RE: Kudu solar facilities 1-12 Northern Cape

**Categories:** This message has been archived by Retain on July 05 2023 04:40

Dear Thembi

Thanks for your reply.

Please could you kindly provide a cell number that I can contact you on? I have tried calling your landline but the call does not go through.

Alternatively, you can contact me on [REDACTED]

Does the reference number apply to all 12 Kudu Solar Facilities?

When is the next committee meeting? Kindly note that the comment period closes on 3 July 2023. Please could you kindly send us comments by 3 July 2023.

Kind Regards,  
Rohaida

CSIR Environmental Management Services  
E-mail: ems@csir.co.za  
Postal Address: Postnet Suite 367, Private Bag x10, Musgrave Road, 4062  
Tel: 031 242 2300

## APPENDICES

### ENVIRONMENTAL IMPACT ASSESSMENT REPORT: Scoping and Environmental Impact Assessment (EIA) Process for the Proposed Development of a Solar Photovoltaic (PV) Facility (Kudu Solar Facility 3) and associated infrastructure, near De Aar, Northern Cape Province

---

**From:** Thembi Nyoka <ThembiNy@dalrrd.gov.za>  
**Sent:** Friday, 23 June 2023 11:56  
**To:** EMS  
**Subject:** RE: Kudu solar facilities 1-12 Northern Cape

Good day

Your application is on step 5 of 8 waiting to be presented in the Delegate of the Minister for the next committee meeting.

I hope you will find this in order,

Kind regards

Thembi

## APPENDICES

ENVIRONMENTAL IMPACT ASSESSMENT REPORT: Scoping and Environmental Impact Assessment (EIA) Process for the Proposed Development of a Solar Photovoltaic (PV) Facility (Kudu Solar Facility 3) and associated infrastructure, near De Aar, Northern Cape Province

---

### 3. Comments received from the South African Civil Aviation Authority (SACAA)

**From:** Lizell Stroh <StrohL@caa.co.za>  
**Sent:** Thursday, 22 June 2023 15:35  
**To:** EMS  
**Cc:** Doris Khoza; Simphiwe Masilela  
**Subject:** RE: Reminder of the Availability of Draft EIA Reports for Comment - Kudu Solar PV  
**Attachments:** New Obstacle Regulations 26TH AMENDMENT.pdf; Obstacles - Development around Aerodromes.pdf

**Categories:** This message has been archived by Retain on June 30 2023 02:41

Good day, future sake kindly send all EIA communication to [Obstacles@caa.co.za](mailto:Obstacles@caa.co.za).

kindly find the "link" as from the caa website, on information and the process and procedure requires to be follow, towards solar projects proposed.

[www.caa.co.za](http://www.caa.co.za)

[www.caa.co.za/industry-information/obstacles/](http://www.caa.co.za/industry-information/obstacles/) kindly scroll down on the Notices for the respected information. Obstacle Notice 1/2022 – Appointment of New Windfarm and Solar Obstacle Application Service Provider

Kindly be advised, Air Traffic and Navigation Services (ATNS) has been appointed as the Obstacle application Service Provider for Windfarms on 1 May 2021. They will be also responsible for Solar Obstacle Applications from the 1<sup>st</sup> of February 2022. All new Solar applications must be lodged to [obstacles@atns.co.za](mailto:obstacles@atns.co.za) or contact Graham Mondzinger (Obstacle Evaluator) at 062 002 1621.

Their responsibility would pertain to the assessments, maintenance, and all other related matters in respect to Windfarms and Solar assessments.

Kindly confirm the Transmission line proposed towards the projects, as this would affect Aviation operations.

Kindly find information on Development around Airports and extract to the Obstacle Regulations Part 139.01.30 as information.

Kind regards

Lizell Stroh  
Obstacle Inspector  
Aerodrome Infrastructure  
Tel: 011 545 1232 | Cell: [REDACTED] | Email: [strohl@caa.co.za](mailto:strohl@caa.co.za) | <http://www.caa.co.za>

Follow us on    

**APPENDICES**

**ENVIRONMENTAL IMPACT ASSESSMENT REPORT: Scoping and Environmental Impact Assessment (EIA) Process for the Proposed Development of a Solar Photovoltaic (PV) Facility (Kudu Solar Facility 3) and associated infrastructure, near De Aar, Northern Cape Province**

---

**DEPARTMENT OF TRANSPORT**

**CIVIL AVIATION ACT, 2009 (ACT NO. 13 of 2009)**

**TWENTY - SIXTH AMENDMENT OF THE CIVIL AVIATION REGULATIONS, 2023**

*(The English Text is the official text of the Regulations)*

---

I, Sindisiwe Chikunga, Minister of Transport, hereby, in terms of section 155(1) of the Civil Aviation Act, 2009 (Act No. 13 of 2009), make the Regulations set out in the Schedule hereunder.

  
**Ms Sindisiwe Chikunga, MP**  
**Minister of Transport**

**Date:** 2023/03/17

## APPENDICES

ENVIRONMENTAL IMPACT ASSESSMENT REPORT: Scoping and Environmental Impact Assessment (EIA) Process for the Proposed Development of a Solar Photovoltaic (PV) Facility (Kudu Solar Facility 3) and associated infrastructure, near De Aar, Northern Cape Province

---

### 139.01.30

(1) A holder of an aerodrome licence shall monitor a concerned aerodrome and its surroundings to assess permanent or temporary obstacle limitation and penetration surfaces, to establish if any obstacle has an impact on the safety of aircraft operations at such aerodrome.

(2) If an assessment referred to in subregulation (1) identifies any obstacle that negatively impacts on aircraft safety, a holder of an aerodrome licence shall take appropriate action to mitigate the risk and restrict or remove such obstacle.

(3) A holder of an aerodrome licence shall not erect or allow to be erected, without the prior approval of the Director, a building, structure, or object which projects above a slope of 1 in 20 and which is within 3 000 m measured from the nearest point on a boundary of such aerodrome or heliport.

(4) An object, whether temporary or permanent, which projects above the obstacle limitation surfaces within a radius of 8 km as measured from an aerodrome reference point shall be marked as prescribed in Document SA-CATS 139.

(5) An object, whether temporary or permanent, which projects above the obstacle limitation surfaces beyond a radius of 8 km and constitutes a potential hazard to aircraft, shall be marked as prescribed in Document SA-CATS 139.

(6) A holder of an aerodrome licence shall not erect or allow to be erected, without the prior approval of the Director, a building or object which constitutes an obstruction or potential hazard to an aircraft operating in a navigable airspace in the vicinity of an aerodrome, or navigation aid, or which will adversely affect the performance of a radio navigation or ILS.

(7) A holder of an aerodrome licence shall not erect or allow to be erected, without the prior approval of the Director, an object higher than 45 m above the



## APPENDICES

### ENVIRONMENTAL IMPACT ASSESSMENT REPORT: Scoping and Environmental Impact Assessment (EIA) Process for the Proposed Development of a Solar Photovoltaic (PV) Facility (Kudu Solar Facility 3) and associated infrastructure, near De Aar, Northern Cape Province

---

mean level of a landing area or within 8 km measured from the nearest point on a boundary of an aerodrome.

(8) A holder of an aerodrome licence shall not erect or allow to be erected, without the prior approval of the Director a building, structure, or object which projects above a slope of 1 in 20 and which is within 3 000 m measured from the nearest point on a boundary of an aerodrome or heliport.

(9) A holder of an aerodrome licence shall not erect or allow to be erected, without the prior approval of the Director, a building, structure or other object which will project above the obstacle limitation surfaces of an aerodrome or heliport.

(10) A person or authority involved in land development, shall not compromise air safety by authorising or developing any land or erecting a building or obstacle on such land.”:

(d) the insertion in Subpart 2 in the arrangements of regulations of the following Subpart:

#### **“SUBPART 2: LICENSING AND OPERATION OF AERODROMES**

- 139.02.1 Requirements for licence
- 139.02.2 Application for licence or amendment thereof
- 139.02.3 Processing of application for licence or amendment thereof
- 139.02.4 Adjudication of application for licence or amendment thereof
- 139.02.5 **[[Issuing]** Issuance of licence
  - 139.02.6 Period of validity
  - 139.02.7 Transferability
  - 139.02.8 Renewal of licence
  - 139.02.9 Licence of intent
  - 139.02.10 Aerodrome design requirements

## APPENDICES

ENVIRONMENTAL IMPACT ASSESSMENT REPORT: Scoping and Environmental Impact Assessment (EIA) Process for the Proposed Development of a Solar Photovoltaic (PV) Facility (Kudu Solar Facility 3) and associated infrastructure, near De Aar, Northern Cape Province

---



### Information Document

#### Development around Aerodromes

Developers planning developments and more specifically housing developments around aerodromes should take cognisance of the following: -

1. The most critical part of flight is the take off. Far less critical but never the less still potentially dangerous is the landing.
2. An incident relating to a take off and landing should be rated as probable, i.e. it will happen, sooner or later.
3. The noise of any aircraft taking off is in the vicinity of 100 decibel <sup>(1)</sup> (dB). At 60 m above the ground, a sound level of more than 100 dBA <sup>(2)</sup> can be realised. (See SANS standard below).

The extent of existing and future aircraft noise over a proposed development must be determined to ensure that the township layout and land uses are in line with **Chapter 6 of the Draft White Paper on National Civil Aviation Policy** and the applicable laws.

Failure to comply with the above will result in the creation of an environment that is not compatible with residential and associated land uses.

4. High levels of exhaust gasses emitted at low levels especially at take off where aircraft engines are at maximum power.
5. Risk of chemical pollutants like fuel, lubricants and pesticides (from crop spraying aircraft) etc.
6. Navigation equipment of different types, radiating electromagnetic energy in different frequency bands. From the **Medium Frequency** (MF) band (low hundreds of Kilohertz below the "Broadcast AM band"), to the **Very High Frequency** (VHF) band (above the "Broadcast FM" band starting at 108 Megahertz), to the **Ultra High Frequency** (UHF) band (above M-net and e-TV frequencies) and to frequencies in the **Microwave bands** are used on and around aerodromes. These

<sup>(1)</sup> The decibel (dB) is used to measure sound level. The dB is a logarithmic unit used to describe a ratio where the log base is 10. 10 dB would represent a 10-fold increase, 20 dB a 100-fold increase, 60 dB a million fold increase etc., in the level.

<sup>(2)</sup> The decibel A-weighted (dBA) relates to the response of the human ear where 0dB is the threshold of hearing, i.e. the smallest sound a human can hear.

## APPENDICES

### ENVIRONMENTAL IMPACT ASSESSMENT REPORT: Scoping and Environmental Impact Assessment (EIA) Process for the Proposed Development of a Solar Photovoltaic (PV) Facility (Kudu Solar Facility 3) and associated infrastructure, near De Aar, Northern Cape Province

---

facilities are most often placed on the extended centre line of runways. The effects of long term radiation from navigation equipment especially on children that could be playing in the vicinity of such equipment, has not been proven. **The only safeguard from electromagnetic radiation is distance.**

7. Structures built in the near vicinity of an aerodrome, especially in the approach path to a runway, has the potential to interfere with the proper operation of navigational equipment, both on the ground and on airborne equipment. In addition, expected spin-offs from such developments such as lights, sunlight reflections from roofs, trees that will grow high in time and smoke also have the potential to endanger aviation.

Furthermore, factories in the vicinity of aerodromes emitting large volumes of hot air/gasses can seriously affect the flying conditions of aircraft by producing high velocity ascending airflow being replaced by high velocity descending airflow. This could head to loss of control of aircraft by the rapid succession of down then up and down again forces exerted on aircraft, which in severe cases could also lead to structural damage to aircraft.

**It can hence reasonably be deduced that especially the approach areas to an aerodrome are neither safe nor healthy to live in.** It is against this background, that the areas in line with a runway was traditionally zoned for "Agriculture" in the immediate proximity of an aerodrome and for "Light industry" in the adjacent area.

#### SANS Standard 10117

1	2
Type of district	Equivalent continuous day/night rating levels ( $L_{\text{dnt},v}$ ) dBA
<b>RESIDENTIAL DISTRICTS2</b>	
a) Low Density (<25 units/hectare) (Schools, churches, educational)	45
b) Medium Density (<25 to 100 units/hectare) (Schools, churches, educational)	50
c) High Density (>100 units/hectare) (Schools, churches, educational, conference)	55
<b>NON-RESIDENTIAL DISTRICTS</b>	
d) Commercial districts (Retail shopping, offices, consulting rooms)	60
e) Commercial/ industrial districts (Central business, district motor trade, warehousing, etc)	65
f) Agriculture (livestock and breeding) Cemeteries	65
g) Industrial (Manufacturing, assembly, repairing, packaging, bus depots, builders yards, etc)	70
h) Agriculture, land tenure, (not livestock), picnic facilities, open spaces (vacant land)	75
i) Forbidden areas – no development allowed	>80

Source: SABS 0117 (Ed.2)

## APPENDICES

### ENVIRONMENTAL IMPACT ASSESSMENT REPORT: Scoping and Environmental Impact Assessment (EIA) Process for the Proposed Development of a Solar Photovoltaic (PV) Facility (Kudu Solar Facility 3) and associated infrastructure, near De Aar, Northern Cape Province

---

#### The following should be noted: -

It is clear that all legislation effecting such development is seldom properly investigated, especially as far as noise is concerned.

#### From a national level, noise is regulated by six acts, namely:

- *The Constitution of the Republic of South Africa Act, 1996* (Act No. 108 of 1996).
- *The Environment Conservation Act, 1989* (Act No 73 of 1989).
- *The Standards Act, 1982* (Act No 30 of 1982).
- *The Road Traffic Act, 1996* (Act No 93 of 1996). (And attendant Regulations).
- *The Civil Aviation Act, 2009*, (Act No 13 of 2009).
- *The Occupational Health and Safety Act, 1993* (Act No 85 of 1993).

#### Other relevant legislation is:

*EIA Regulations*  
*National/Provincial Noise Control Regulations.*  
*National Policy on Aircraft Noise and Engine Emissions.*

#### Issues

- i) The legal proving of noise impact/noise disturbance/noise nuisance requires that an appropriate scientific and technical approach be applied in any investigation/evaluation of any noise-related problem.
- ii) Requirements placed on new developments/rezoning/consent uses regarding noise impact evaluation require a uniform and scientific approach.

#### Scope and Details

- i) Noise measurement and calculations shall be undertaken in accordance with the appropriate standards. Reference to a standard is deemed to be a reference to the latest edition of that standard.
- ii) The procedure set out in **SANS 10328 (SABS 0328)**, *Methods for Environmental Noise Impact Assessments* shall be used as a guide for all noise impact investigations.
- iii) **SANS 10103:2003**, *The Measurement and Rating of Environmental Noise with Respect to Land Use, Health, Annoyance and to Speech Communications* is to be used as the specific reference for *the acceptable rating levels for noise in districts*. Also all noise measurement surveys are to be undertaken in accordance with this standard.
- iv) **SANS 10210 (SABS 0210)**, *Calculating and Predicting Road Traffic Noise* is to be used to calculate *supplementary* controlled areas related to road traffic as well as any road traffic problem noise levels.

## APPENDICES

ENVIRONMENTAL IMPACT ASSESSMENT REPORT: Scoping and Environmental Impact Assessment (EIA) Process for the Proposed Development of a Solar Photovoltaic (PV) Facility (Kudu Solar Facility 3) and associated infrastructure, near De Aar, Northern Cape Province

---

- v) **SANS 10117:2003**, *Calculation and Prediction of Aircraft Noise around Airports for Land Use Purposes* is to be used to calculate the noisiness index related to the establishment of *supplementary controlled areas* around airports and military air bases.  
**SANS 10117** specifies that the Integrated Noise Model (INM) which has been developed and issued by the Federal Aviation Administration (FAA) is to be used to calculate the noise contours around airports.
- vi) **SANS 10357 (SABS 0357)**, *The Calculation of Sound Propagation by the Concave Method* is to be used for the calculation of *supplementary controlled areas* related to any major noise source(s).
- vii) The procedures set out in **SANS 10181 (SABS 0181)**, *The Measurement of Noise Emitted by Road Vehicles when Stationary* and **SANS 10205 (SABS 0205)**, *The Measurement of Noise Emitted by Motor Vehicles in Motion* will be used for the monitoring of individual motor vehicles.
- viii) Procedures are set out in the various SABS ISO Acoustics Codes of Practice.

It is most likely that most, if not all of the development will fall in an area where the noise level would exceed the 55 dBA limit set for residential development.

- **Section 24 of the Constitution** provides that *"everyone has the right ... to an environment that is not harmful to their health or well-being; and ... to have the environment protected for the benefit of present and future generations through reasonable legislative and other measures that*
  - (i) *prevent pollution and ecological degradation;*
  - (ii) *promote conservation; and*
  - (iii) *secure ecologically sustainable development and use of natural resources while promoting justifiable economic and social development."*

The Constitution thus, compels government to give effect to people's environmental rights and places government under a legal duty to act as a responsible custodian of the nation's environment. This would apply to developments around airports.

**CIVIL AVIATION REGULATIONS, 2011 to the CIVIL AVIATION ACT, 2009 (ACT NO 13 OF 2009)**

**Regulations from The Civil Aviation Act relating to Obstacles**  
(Extract)

**Obstacle limitations and markings outside aerodrome or heliport**  
139.01.30

## APPENDICES

### ENVIRONMENTAL IMPACT ASSESSMENT REPORT: Scoping and Environmental Impact Assessment (EIA) Process for the Proposed Development of a Solar Photovoltaic (PV) Facility (Kudu Solar Facility 3) and associated infrastructure, near De Aar, Northern Cape Province

---

(1) All objects, whether temporary or permanent, which project above the horizontal surface within a specified radius of 8 kilometers as measured from the aerodrome reference point should be marked as specified in Document SA-CATS 139.

(2) Any other object which projects the horizontal surface beyond these radii or above the conical surface and which constitutes a potential hazard to aircraft must be marked as specified in Document SA-CATS 139.

(3) Buildings or other objects which will constitute an obstruction or potential hazard to aircraft moving in the navigable air space in the vicinity of an aerodrome, or navigation aid, or which will adversely affect the performance of the radio navigation or instrument landing systems, must not be erected or allowed to come into existence without the prior approval of the Director.

(4) No buildings or objects higher than 45 meters above the mean level of the landing area, or, in the case of a water aerodrome or heliport, the normal level of the water, must without the approval of the Director be erected within a distance of 8 kilometer measured from the nearest point on the boundary of an aerodrome or heliport.

(5) No building, structure or object which projects above a slope of 1 in 20 and which is within 3000 meters measured from the nearest point on the boundary of an aerodrome or heliport must, without the prior approval of the Director be erected or be allowed to come into existence.

(6) No building, structure or other object which will project above the approach, transitional or horizontal surfaces of an aerodrome or heliport must, without the prior approval of the Director, be erected or allowed to come into existence.

(7) The obstacle limitation surface as prescribed in Document SA-CATS 139 must be clear of any penetration of obstacles temporary or otherwise.

(8) In the event of a conflict of interest between land use authorities and air space users, air safety must be regarded as predominant and not to be compromised by land development projects or other obstacles.

#### **Protection of radio sites**

##### **171.03.3**

No structure or object, whether natural or artificial, which have the potential of interfering or degrading radio signals for the purpose of aviation safety, shall be allowed to come in existence or to move or be moved within the surfaces and slopes as prescribed in the Document SA-CATS 171.

#### **Endangering safety**

##### **91.01.10**

(1) No person shall, through any act or omission –

## APPENDICES

### ENVIRONMENTAL IMPACT ASSESSMENT REPORT: Scoping and Environmental Impact Assessment (EIA) Process for the Proposed Development of a Solar Photovoltaic (PV) Facility (Kudu Solar Facility 3) and associated infrastructure, near De Aar, Northern Cape Province

---

- (a) endanger the safety of an aircraft or person therein; or
- (b) cause or permit an aircraft to endanger the safety of any person or property.

(2) No person shall cause, by any means, a beam of light or other energy source, either visible or not, to be emitted towards any aircraft or air traffic control tower or any person therein such that there would be the potential for causing blindness or otherwise adversely affecting the ability of such person to safely carry out his or her duties.

#### **Part 188.00.1** Makes non compliance of the above an offence

1. In accordance with the **Civil Aviation Regulations (CAR)** to the **Civil Aviation Act (Act 13 of 2009)**, the standards of the International Civil Aviation Organisation (ICAO) are applicable.
2. ICAO annex 14 stipulates that all new developments in the approach area shall be below 1,6% (slope of 1: 62,5), if a slope of not exceeding 2% (slope of 1:50) does not already exist. In which case this slope (2% or lower) shall be maintained. The approach area starts at a point 60 m **beyond** the end of the runway and 150 m either side of the extended centre line, diverging by 15% (10 degrees) outwards from this point outwards.

#### **Conclusion**

The aerodrome license holder should register safeguarding maps with the Local Planning Authorities and should receive, from the Local Planning Authority, copies of applications for developments in and within the vicinity of the aerodrome.

If against the above background, developers still persist on continuing with development, the existence of mentioned dangers should be reflected in the establishment conditions.

## APPENDICES

ENVIRONMENTAL IMPACT ASSESSMENT REPORT: Scoping and Environmental Impact Assessment (EIA) Process for the Proposed Development of a Solar Photovoltaic (PV) Facility (Kudu Solar Facility 3) and associated infrastructure, near De Aar, Northern Cape Province

---

**From:** EMS <ems@csir.co.za>

**Sent:** Friday, June 23, 2023 11:16 AM

**To:** Lizell Stroh <StrohL@caa.co.za>

**Cc:** Doris Khoza <KhozaD@caa.co.za>; Simphiwe Masilela <Masilelas@caa.co.za>; EMS <ems@csir.co.za>; Obstacles <Obstacles@caa.co.za>

**Subject:** RE: Reminder of the Availability of Draft EIA Reports for Comment - Kudu Solar PV

Dear Lizell

Thanks for your email and the information. Noted, we have added "[Obstacles@caa.co.za](mailto:Obstacles@caa.co.za)" to the email.

The proposed project is not located on any extended runway centreline, nor is it located within 3 km of an aerodrome or heliport. The De Aar Aerodrome is located approximately 54 km south-west of the study area; and the Petrusville Aerodrome is located approximately 25 km north-east of the study area.

The power lines for the proposed projects are not being assessed in these EIAs for the PV Facilities. Separate Environmental Assessment processes will be undertaken for the power lines in due course. We will communicate the details once finalised.

Please let me know if you have any feedback on the above?

Kind Regards,  
Rohaida

CSIR Environmental Management Services

E-mail: [ems@csir.co.za](mailto:ems@csir.co.za)

Postal Address: Postnet Suite 367, Private Bag x10, Musgrave Road, 4062

Tel: 031 242 2300



## APPENDICES

### ENVIRONMENTAL IMPACT ASSESSMENT REPORT: Scoping and Environmental Impact Assessment (EIA) Process for the Proposed Development of a Solar Photovoltaic (PV) Facility (Kudu Solar Facility 3) and associated infrastructure, near De Aar, Northern Cape Province

---

**From:** Lizell Stroh <StrohL@caa.co.za>  
**Sent:** Friday, 23 June 2023 12:22  
**To:** EMS  
**Cc:** Doris Khoza; Simphiwe Masilela; Obstacles  
**Subject:** RE: Reminder of the Availability of Draft EIA Reports for Comment - Kudu Solar PV

Good day Rohaida, your information is noted, kindly always consider the SAAF towards proposal/future proposals in not previous considered .

Contacts for your information: [REDACTED]

Kind regards

Lizell Stroh  
Obstacle Inspector  
Aerodrome Infrastructure  
Tel: 011 545 1232 | Cell: [REDACTED] | Email: [strohl@caa.co.za](mailto:strohl@caa.co.za) | <http://www.caa.co.za>

Follow us on    

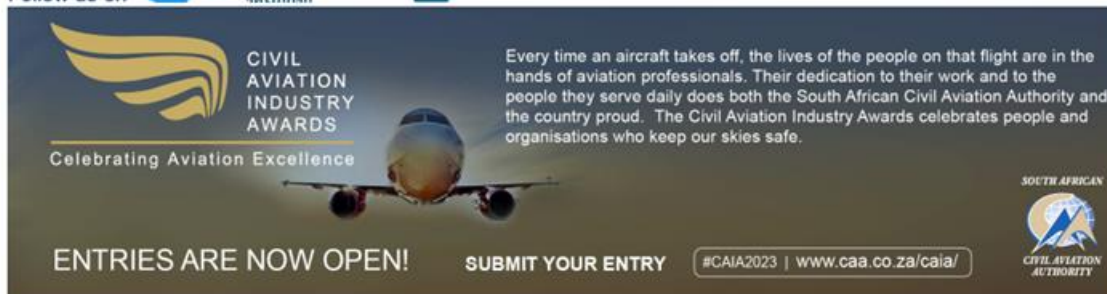

**CIVIL AVIATION INDUSTRY AWARDS**  
Celebrating Aviation Excellence

Every time an aircraft takes off, the lives of the people on that flight are in the hands of aviation professionals. Their dedication to their work and to the people they serve daily does both the South African Civil Aviation Authority and the country proud. The Civil Aviation Industry Awards celebrates people and organisations who keep our skies safe.

**ENTRIES ARE NOW OPEN!**    **SUBMIT YOUR ENTRY**    #CAIA2023 | [www.caa.co.za/caia/](http://www.caa.co.za/caia/)

SOUTH AFRICAN CIVIL AVIATION AUTHORITY

## APPENDICES

### ENVIRONMENTAL IMPACT ASSESSMENT REPORT: Scoping and Environmental Impact Assessment (EIA) Process for the Proposed Development of a Solar Photovoltaic (PV) Facility (Kudu Solar Facility 3) and associated infrastructure, near De Aar, Northern Cape Province

---

**From:** Simphiwe Masilela <Masilelas@caa.co.za>  
**Sent:** Monday, 03 July 2023 16:25  
**To:** EMS  
**Subject:** RE: Closure of the Comment Period on the Draft EIA Reports for the Proposed Development of the 12 Kudu Solar Photovoltaic Facilities, near De Aar, Northern Cape  
**Attachments:** Obstacles - Development around Aerodromes.pdf; Part 139 01 30 Regulations.pdf

Good day,

The SACAA has no objection to the proposed development, however, a formal obstacle assessment must be conducted in order to determine whether the proposed will affect the safety of flights in any way.

Kindly note that the SACAA has transferred the assessments for Solar and Wind energy applications to Air Traffic and Navigation Services (ATNS) as published on the SACAA website.

Their responsibility would pertain to the assessments, maintenance, and all other related matters in respect to Solar assessments.

The contact details for ATNS are:

Obstacle Evaluator  
ATNS Head Office  
Tel: +2711 6071000 (Ask for Obstacle Evaluators)  
Email: [Obstacles@atns.co.za](mailto:Obstacles@atns.co.za)

For any other obstacle applications, kindly refer to the current obstacle application procedures and processes to follow, as per the SACAA website:

Find attached information for Developments around aerodromes and prescribed in SACAA Regulations, processes, and procedures to follow.

More information can be obtained at <http://www.caa.co.za>. Click on information for industry under 'Obstacles'. There is a fee applicable to the said application as well, which is currently R1020 (any changes to this fee will be published on the website). Assessments will commence upon receipt of payment and once the database is updated.

Applications must be forwarded to [obstacles@caa.co.za](mailto:obstacles@caa.co.za) together with the following:

- A kmz/kml (Google Earth) file reflecting the footprint to the proposed development site.
- Provide coordinates (deg, min, sec), Height and Elevation.
- Also indicate the highest structure of the project (to the top)

Should you require more information please contact the inspectorate at [obstacles@caa.co.za](mailto:obstacles@caa.co.za)

Regards 

Ms. Simphiwe Masilela

Inspector: Obstacles

Aerodrome Infrastructure

Cell: [REDACTED] Tel: [REDACTED] Email: [masilelas@caa.co.za](mailto:masilelas@caa.co.za) | [www.caa.co.za](http://www.caa.co.za)

## APPENDICES

ENVIRONMENTAL IMPACT ASSESSMENT REPORT: Scoping and Environmental Impact Assessment (EIA) Process for the Proposed Development of a Solar Photovoltaic (PV) Facility (Kudu Solar Facility 3) and associated infrastructure, near De Aar, Northern Cape Province

---



### Information Document

#### Development around Aerodromes

Developers planning developments and more specifically housing developments around aerodromes should take cognisance of the following: -

1. The most critical part of flight is the take off. Far less critical but never the less still potentially dangerous is the landing.
2. An incident relating to a take off and landing should be rated as probable, i.e. it will happen, sooner or later.
3. The noise of any aircraft taking off is in the vicinity of 100 decibel<sup>(1)</sup> (dB). At 60 m above the ground, a sound level of more than 100 dBA<sup>(2)</sup> can be realised. (See SANS standard below).

The extent of existing and future aircraft noise over a proposed development must be determined to ensure that the township layout and land uses are in line with **Chapter 6 of the Draft White Paper on National Civil Aviation Policy** and the applicable laws.

Failure to comply with the above will result in the creation of an environment that is not compatible with residential and associated land uses.

4. High levels of exhaust gasses emitted at low levels especially at take off where aircraft engines are at maximum power.
5. Risk of chemical pollutants like fuel, lubricants and pesticides (from crop spraying aircraft) etc.
6. Navigation equipment of different types, radiating electromagnetic energy in different frequency bands. From the **Medium Frequency (MF)** band (low hundreds of Kilohertz below the "Broadcast AM band"), to the **Very High Frequency (VHF)** band (above the "Broadcast FM" band starting at 108 Megahertz), to the **Ultra High Frequency (UHF)** band (above M-net and e-TV frequencies) and to frequencies in the **Microwave bands** are used on and around aerodromes. These

<sup>(1)</sup> The decibel (**dB**) is used to measure sound level. The dB is a logarithmic unit used to describe a ratio where the log base is 10. 10 dB would represent a 10-fold increase, 20 dB a 100-fold increase, 60 dB a million fold increase etc., in the level.

<sup>(2)</sup> The decibel A-weighted (**dBA**) relates to the response of the human ear where 0dB is the threshold of hearing, i.e. the smallest sound a human can hear.

## APPENDICES

### ENVIRONMENTAL IMPACT ASSESSMENT REPORT: Scoping and Environmental Impact Assessment (EIA) Process for the Proposed Development of a Solar Photovoltaic (PV) Facility (Kudu Solar Facility 3) and associated infrastructure, near De Aar, Northern Cape Province

---

facilities are most often placed on the extended centre line of runways. The effects of long term radiation from navigation equipment especially on children that could be playing in the vicinity of such equipment, has not been proven. **The only safeguard from electromagnetic radiation is distance.**

7. Structures built in the near vicinity of an aerodrome, especially in the approach path to a runway, has the potential to interfere with the proper operation of navigational equipment, both on the ground and on airborne equipment. In addition, expected spin-offs from such developments such as lights, sunlight reflections from roofs, trees that will grow high in time and smoke also have the potential to endanger aviation.  
Furthermore, factories in the vicinity of aerodromes emitting large volumes of hot air/gasses can seriously affect the flying conditions of aircraft by producing high velocity ascending airflow being replaced by high velocity descending airflow. This could head to loss of control of aircraft by the rapid succession of down then up and down again forces exerted on aircraft, which in severe cases could also lead to structural damage to aircraft.

**It can hence reasonably be deduced that especially the approach areas to an aerodrome are neither safe nor healthy to live in.** It is against this background, that the areas in line with a runway was traditionally zoned for "Agriculture" in the immediate proximity of an aerodrome and for "Light industry" in the adjacent area.

#### SANS Standard 10117

1	2
Type of district	Equivalent continuous day/night rating levels ( $L_{\text{Aeq,24h}}$ ) dBA
<b>RESIDENTIAL DISTRICTS<sup>2</sup></b>	
a) Low Density (<25 units/hectare) (Schools, churches, educational)	45
b) Medium Density (<25 to 100 units/hectare) (Schools, churches, educational)	50
c) High Density (>100 units/hectare) (Schools, churches, educational, conference)	55
<b>NON-RESIDENTIAL DISTRICTS</b>	
d) Commercial districts (Retail shopping, offices, consulting rooms)	60
e) Commercial/ industrial districts (Central business, district motor trade, warehousing, etc)	65
f) Agriculture (livestock and breeding) Cemeteries	65
g) Industrial (Manufacturing, assembly, repairing, packaging, bus depots, builders yards, etc)	70
h) Agriculture, land tenure, (not livestock), picnic facilities, open spaces (vacant land)	75
i) Forbidden areas – no development allowed	>80

Source: SABS 0117 (Ed.2)

## APPENDICES

### ENVIRONMENTAL IMPACT ASSESSMENT REPORT: Scoping and Environmental Impact Assessment (EIA) Process for the Proposed Development of a Solar Photovoltaic (PV) Facility (Kudu Solar Facility 3) and associated infrastructure, near De Aar, Northern Cape Province

---

#### The following should be noted: -

It is clear that all legislation effecting such development is seldom properly investigated, especially as far as noise is concerned.

#### From a national level, noise is regulated by six acts, namely:

- *The Constitution of the Republic of South Africa Act, 1996* (Act No. 108 of 1996).
- *The Environment Conservation Act, 1989* (Act No 73 of 1989).
- *The Standards Act, 1982* (Act No 30 of 1982).
- *The Road Traffic Act, 1996* (Act No 93 of 1996). (And attendant Regulations).
- *The Civil Aviation Act, 2009*, (Act No 13 of 2009).
- *The Occupational Health and Safety Act, 1993* (Act No 85 of 1993).

#### Other relevant legislation is:

*EIA Regulations*  
*National/Provincial Noise Control Regulations.*  
*National Policy on Aircraft Noise and Engine Emissions.*

#### Issues

- i) The legal proving of noise impact/noise disturbance/noise nuisance requires that an appropriate scientific and technical approach be applied in any investigation/evaluation of any noise-related problem.
- ii) Requirements placed on new developments/rezoning/consent uses regarding noise impact evaluation require a uniform and scientific approach.

#### Scope and Details

- i) Noise measurement and calculations shall be undertaken in accordance with the appropriate standards. Reference to a standard is deemed to be a reference to the latest edition of that standard.
- ii) The procedure set out in **SANS 10328 (SABS 0328)**, *Methods for Environmental Noise Impact Assessments* shall be used as a guide for all noise impact investigations.
- iii) **SANS 10103:2003**, *The Measurement and Rating of Environmental Noise with Respect to Land Use, Health, Annoyance and to Speech Communications* is to be used as the specific reference for *the acceptable rating levels for noise in districts*. Also all noise measurement surveys are to be undertaken in accordance with this standard.
- iv) **SANS 10210 (SABS 0210)**, *Calculating and Predicting Road Traffic Noise* is to be used to calculate *supplementary* controlled areas related to road traffic as well as any road traffic problem noise levels.

## APPENDICES

ENVIRONMENTAL IMPACT ASSESSMENT REPORT: Scoping and Environmental Impact Assessment (EIA) Process for the Proposed Development of a Solar Photovoltaic (PV) Facility (Kudu Solar Facility 3) and associated infrastructure, near De Aar, Northern Cape Province

---

- v) **SANS 10117:2003**, *Calculation and Prediction of Aircraft Noise around Airports for Land Use Purposes* is to be used to calculate the noisiness index related to the establishment of *supplementary controlled areas* around airports and military air bases.  
**SANS 10117** specifies that the Integrated Noise Model (INM) which has been developed and issued by the Federal Aviation Administration (FAA) is to be used to calculate the noise contours around airports.
- vi) **SANS 10357 (SABS 0357)**, *The Calculation of Sound Propagation by the Concave Method* is to be used for the calculation of *supplementary controlled areas* related to any major noise source(s).
- vii) The procedures set out in **SANS 10181 (SABS 0181)**, *The Measurement of Noise Emitted by Road Vehicles when Stationary* and **SANS 10205 (SABS 0205)**, *The Measurement of Noise Emitted by Motor Vehicles in Motion* will be used for the monitoring of individual motor vehicles.
- viii) Procedures are set out in the various SABS ISO Acoustics Codes of Practice.

It is most likely that most, if not all of the development will fall in an area where the noise level would exceed the 55 dBA limit set for residential development.

- **Section 24 of the Constitution** provides that *"everyone has the right ... to an environment that is not harmful to their health or well-being; and ... to have the environment protected for the benefit of present and future generations through reasonable legislative and other measures that*
  - (i) *prevent pollution and ecological degradation;*
  - (ii) *promote conservation; and*
  - (iii) *secure ecologically sustainable development and use of natural resources while promoting justifiable economic and social development."*

The Constitution thus, compels government to give effect to people's environmental rights and places government under a legal duty to act as a responsible custodian of the nation's environment. This would apply to developments around airports.

**CIVIL AVIATION REGULATIONS, 2011 to the CIVIL AVIATION ACT, 2009 (ACT NO 13 OF 2009)**

**Regulations from The Civil Aviation Act relating to Obstacles**  
(Extract)

**Obstacle limitations and markings outside aerodrome or heliport**  
**139.01.30**

## APPENDICES

### ENVIRONMENTAL IMPACT ASSESSMENT REPORT: Scoping and Environmental Impact Assessment (EIA) Process for the Proposed Development of a Solar Photovoltaic (PV) Facility (Kudu Solar Facility 3) and associated infrastructure, near De Aar, Northern Cape Province

---

(1) All objects, whether temporary or permanent, which project above the horizontal surface within a specified radius of 8 kilometers as measured from the aerodrome reference point should be marked as specified in Document SA-CATS 139.

(2) Any other object which projects the horizontal surface beyond these radii or above the conical surface and which constitutes a potential hazard to aircraft must be marked as specified in Document SA-CATS 139.

(3) Buildings or other objects which will constitute an obstruction or potential hazard to aircraft moving in the navigable air space in the vicinity of an aerodrome, or navigation aid, or which will adversely affect the performance of the radio navigation or instrument landing systems, must not be erected or allowed to come into existence without the prior approval of the Director.

(4) No buildings or objects higher than 45 meters above the mean level of the landing area, or, in the case of a water aerodrome or heliport, the normal level of the water, must without the approval of the Director be erected within a distance of 8 kilometer measured from the nearest point on the boundary of an aerodrome or heliport.

(5) No building, structure or object which projects above a slope of 1 in 20 and which is within 3000 meters measured from the nearest point on the boundary of an aerodrome or heliport must, without the prior approval of the Director be erected or be allowed to come into existence.

(6) No building, structure or other object which will project above the approach, transitional or horizontal surfaces of an aerodrome or heliport must, without the prior approval of the Director, be erected or allowed to come into existence.

(7) The obstacle limitation surface as prescribed in Document SA-CATS 139 must be clear of any penetration of obstacles temporary or otherwise.

(8) In the event of a conflict of interest between land use authorities and air space users, air safety must be regarded as predominant and not to be compromised by land development projects or other obstacles.

#### **Protection of radio sites** 171.03.3

No structure or object, whether natural or artificial, which have the potential of interfering or degrading radio signals for the purpose of aviation safety, shall be allowed to come in existence or to move or be moved within the surfaces and slopes as prescribed in the Document SA-CATS 171.

#### **Endangering safety** 91.01.10

(1) No person shall, through any act or omission –

## APPENDICES

### ENVIRONMENTAL IMPACT ASSESSMENT REPORT: Scoping and Environmental Impact Assessment (EIA) Process for the Proposed Development of a Solar Photovoltaic (PV) Facility (Kudu Solar Facility 3) and associated infrastructure, near De Aar, Northern Cape Province

---

- (a) endanger the safety of an aircraft or person therein; or
- (b) cause or permit an aircraft to endanger the safety of any person or property.

(2) No person shall cause, by any means, a beam of light or other energy source, either visible or not, to be emitted towards any aircraft or air traffic control tower or any person therein such that there would be the potential for causing blindness or otherwise adversely affecting the ability of such person to safely carry out his or her duties.

#### **Part 188.00.1** Makes non compliance of the above an offence

1. In accordance with the **Civil Aviation Regulations (CAR)** to the **Civil Aviation Act (Act 13 of 2009)**, the standards of the International Civil Aviation Organisation (ICAO) are applicable.
2. ICAO annex 14 stipulates that all new developments in the approach area shall be below 1,6% (slope of 1: 62,5), if a slope of not exceeding 2% (slope of 1:50) does not already exist. In which case this slope (2% or lower) shall be maintained. The approach area starts at a point 60 m **beyond** the end of the runway and 150 m either side of the extended centre line, diverging by 15% (10 degrees) outwards from this point outwards.

#### **Conclusion**

The aerodrome license holder should register safeguarding maps with the Local Planning Authorities and should receive, from the Local Planning Authority, copies of applications for developments in and within the vicinity of the aerodrome.

If against the above background, developers still persist on continuing with development, the existence of mentioned dangers should be reflected in the establishment conditions.



## APPENDICES

### ENVIRONMENTAL IMPACT ASSESSMENT REPORT: Scoping and Environmental Impact Assessment (EIA) Process for the Proposed Development of a Solar Photovoltaic (PV) Facility (Kudu Solar Facility 3) and associated infrastructure, near De Aar, Northern Cape Province

---



#### CIVIL AVIATION ACT, 2009 (ACT NO 13 OF 2009)

#### CIVIL AVIATION REGULATIONS, 2011 (26<sup>TH</sup> AMENDMENT REGULATIONS)

##### Obstacle limitations and markings outside aerodrome or heliport

###### CAR: Part 139.01.30

- (1) A holder of an aerodrome licence shall monitor a concerned aerodrome and its surroundings to assess permanent or temporary obstacle limitation and penetration surfaces, to establish if any obstacle has an impact on the safety of aircraft operations at such aerodrome.
- (2) If an assessment referred to in subregulation (1) identifies any obstacle that negatively impacts on aircraft safety, a holder of an aerodrome licence shall take appropriate action to mitigate the risk and restrict or remove such obstacle.
- (3) A holder of an aerodrome licence shall not erect or allow to be erected, without the prior approval of the Director, a building, structure, or object which projects above a slope of 1 in 20 and which is within 3 000 m measured from the nearest point on a boundary of such aerodrome or heliport.
- (4) An object, whether temporary or permanent, which projects above the obstacle limitation surfaces within a radius of 8 km as measured from an aerodrome reference point shall be marked as prescribed in Document SA-CATS 139.
- (5) An object, whether temporary or permanent, which projects above the obstacle limitation surfaces beyond a radius of 8 km and constitutes a potential hazard to aircraft, shall be marked as prescribed in Document SA-CATS 139.
- (6) A holder of an aerodrome licence shall not erect or allow to be erected, without the prior approval of the Director, a building or object which constitutes an obstruction or potential hazard to an aircraft operating in a navigable airspace in the vicinity of an aerodrome, or navigation aid, or which will adversely affect the performance of a radio navigation or ILS.
- (7) A holder of an aerodrome licence shall not erect or allow to be erected, without the prior approval of the Director, an object higher than 45 m above the mean level of a landing area or within 8 km measured from the nearest point on a boundary of an aerodrome.
- (8) A holder of an aerodrome licence shall not erect or allow to be erected, without the prior approval of the Director a building, structure, or object which projects above a slope of 1 in 20 and which is within 3 000 m measured from the nearest point on a boundary of an aerodrome or heliport.
- (9) A holder of an aerodrome licence shall not erect or allow to be erected, without the prior approval of the Director, a building, structure or other object which will project above the obstacle limitation surfaces of an aerodrome or heliport.
- (10) A person or authority involved in land development, shall not compromise air safety by authorising or developing any land or erecting a building or obstacle on such land.

## APPENDICES

### ENVIRONMENTAL IMPACT ASSESSMENT REPORT: Scoping and Environmental Impact Assessment (EIA) Process for the Proposed Development of a Solar Photovoltaic (PV) Facility (Kudu Solar Facility 3) and associated infrastructure, near De Aar, Northern Cape Province

---

#### 4. Comments received from the South African Heritage Resources Agency (SAHRA)

---

**From:** EMS <ems@csir.co.za>  
**Sent:** Sunday, June 4, 2023 10:28 PM  
**To:** Natasha Higgitt <nhiggitt@sahra.org.za>  
**Cc:** EMS <ems@csir.co.za>  
**Subject:** RE: Availability of Draft EIA Reports for Comment - Kudu Solar PV

Dear Natasha

I hope that you are well, further to the notifications sent out for the release of the Draft EIA Reports for the Kudu Solar project, and based on discussions between you, John Almond and myself earlier in April and May 2023, kindly note that the relevant files have been submitted on SAHRIS and application status changed to "submitted".

I have uploaded the HIA, updated Palaeontology SSV (as discussed with John Almond in April 2023), Visual Impact Assessment, PPP for the EIA Phase (Appendix H), EMPr for PV (Appendix I) and Generic EMPr for Substations (Appendix J) per project and case.

The Draft EIA Report consists of the following chapters and appendices:

- Summary Executive Summary
- Chapter 1 Introduction
- Chapter 2 Project Description
- Chapter 3 Description of the Affected Environment
- Chapter 4 Approach to EIA Process and Public Participation
- Chapter 5 Project Alternatives
- Chapter 6 Agriculture Compliance Statement
- Chapter 7 Terrestrial Biodiversity, Terrestrial Plant Species and Terrestrial Animal Species Assessment
- Chapter 8 Aquatic Biodiversity and Species Assessment
- Chapter 9 Avifauna Assessment
- Chapter 10 Visual Impact Assessment
- Chapter 11 Heritage Impact Assessment (Archaeology and Cultural Heritage)
- Chapter 12 Palaeontology
- Chapter 13 Socio-Economic Assessment
- Chapter 14 Traffic Impact Assessment
- Chapter 15 Battery Energy Storage Systems High Level Risk Assessment
- Chapter 16 Geohydrology Assessment
- Chapter 17 Geotechnical Assessment
- Chapter 18 Civil Aviation Site Sensitivity Verification
- Chapter 19 Defence Site Sensitivity Verification
- Chapter 20 Conclusions and Recommendations
- Appendix A Curriculum Vitae of the Environmental Assessment Practitioners
- Appendix B Declaration of Independence of the Environmental Assessment Practitioner
- Appendix C Maps
- Appendix D Pre-Application Consultation with the Competent Authority
- Appendix E Database of Interested and Affected Parties
- Appendix F Public Participation for the Scoping Phase
- Appendix G DFFE Acceptance of the Final Scoping Report
- Appendix H Public Participation for the EIA Phase
- Appendix I Environmental Management Programme for the PV Facility and Associated Infrastructure
- Appendix J Generic Environmental Management Programme for the On-Site Substation
- Appendix K Additional Information

Please let me know if you need any additional files to be uploaded.

We also understand that the fees for SAHRA comment are not relevant as the cases were created before 1 Jan 2023. Please kindly confirm?

Thanks and kind regards,  
Rohaida

## APPENDICES

ENVIRONMENTAL IMPACT ASSESSMENT REPORT: Scoping and Environmental Impact Assessment (EIA) Process for the Proposed Development of a Solar Photovoltaic (PV) Facility (Kudu Solar Facility 3) and associated infrastructure, near De Aar, Northern Cape Province

---

**From:** Natasha Higgitt <nhiggitt@sahra.org.za>  
**Sent:** Tuesday, 06 June 2023 08:58  
**To:** EMS  
**Subject:** RE: Availability of Draft EIA Reports for Comment - Kudu Solar PV

**Categories:** This message has been archived by Retain on June 18 2023 13:37

[The e-mail server of the sender failed SPF checks and maybe malicious (SPF Record)]  
Good morning,

Thank you for your email. No application fees are required for this case as it was submitted before 1 January 2023. No additional appendices need to be uploaded at this point.

Kind regards,

Please note: Due to high meeting and task load, I may not be able to respond to your email immediately. If you do not receive a response within 5 working days, please resend your query.

**From:** EMS <ems@csir.co.za>  
**Sent:** Tuesday, June 20, 2023 8:34 AM  
**To:** Natasha Higgitt <nhiggitt@sahra.org.za>  
**Cc:** EMS <ems@csir.co.za>  
**Subject:** RE: Availability of Draft EIA Reports for Comment - Kudu Solar PV

Hi Natasha

I hope that you are well.

I was kindly just checking if all is ok with the commenting, and if you needed any other appendices?

Our Palaeontology specialist is out of the country from 3 July 2023. Is there any chance that you could kindly send comments a bit earlier so that I could consult with him on your comments, if needed?

Apologies for the pressure with this, I know there are many cases for review.

Thanks  
Rohaida

## APPENDICES

### ENVIRONMENTAL IMPACT ASSESSMENT REPORT: Scoping and Environmental Impact Assessment (EIA) Process for the Proposed Development of a Solar Photovoltaic (PV) Facility (Kudu Solar Facility 3) and associated infrastructure, near De Aar, Northern Cape Province

---

**From:** Natasha Higgitt <nhiggitt@sahra.org.za>  
**Sent:** Tuesday, 20 June 2023 08:58  
**To:** EMS  
**Subject:** RE: Availability of Draft EIA Reports for Comment - Kudu Solar PV

**Categories:** This message has been archived by Retain on June 28 2023 04:57

[The e-mail server of the sender failed SPF checks and maybe malicious (SPF Record)]  
Good morning,

Please note that the earliest I am able to schedule the review of these cases is the 30<sup>th</sup> June. I am not able to review them earlier than that.

Regards,

Please note: Due to high meeting and task load, I may not be able to respond to your email immediately. If you do not receive a response within 5 working days, please resend your query.

**From:** Natasha Higgitt <nhiggitt@sahra.org.za>  
**Sent:** Friday, 30 June 2023 09:22  
**To:** EMS  
**Subject:** RE: Availability of Draft EIA Reports for Comment - Kudu Solar PV

[The e-mail server of the sender failed SPF checks and maybe malicious (SPF Record)]  
Good morning,

Please note that the main EIA reports has not been uploaded to the Kudu cases on SAHRIS. Please upload these documents as soon as possible to each case.

Kind regards,

Please note: Due to high meeting and task load, I may not be able to respond to your email immediately. If you do not receive a response within 5 working days, please resend your query.

## APPENDICES

ENVIRONMENTAL IMPACT ASSESSMENT REPORT: Scoping and Environmental Impact Assessment (EIA) Process for the Proposed Development of a Solar Photovoltaic (PV) Facility (Kudu Solar Facility 3) and associated infrastructure, near De Aar, Northern Cape Province

---

**From:** EMS <[ems@csir.co.za](mailto:ems@csir.co.za)>  
**Sent:** Friday, June 30, 2023 9:37 AM  
**To:** Natasha Higgitt <[nhiggitt@sahra.org.za](mailto:nhiggitt@sahra.org.za)>  
**Cc:** EMS <[ems@csir.co.za](mailto:ems@csir.co.za)>  
**Subject:** RE: Availability of Draft EIA Reports for Comment - Kudu Solar PV

Hi Natasha

Hope you are well.

At the beginning of the comment period, I noted that we have uploaded the HIA, updated Palaeontology SSV (as discussed with John Almond in April 2023), Visual Impact Assessment, PPP for the EIA Phase (Appendix H), EMPr for PV (Appendix I) and Generic EMPr for Substations (Appendix J) per project and case. We queried if more info was needed, and you noted that no additional info is needed at this point. Please let me know which sections of the EIA Report you require to be uploaded or if this can be viewed via the project website or Google Drive in order to facilitate comment?

Thanks  
Rohaida

**From:** Natasha Higgitt <[nhiggitt@sahra.org.za](mailto:nhiggitt@sahra.org.za)>  
**Sent:** Friday, June 30, 2023 9:43 AM  
**To:** EMS <[ems@csir.co.za](mailto:ems@csir.co.za)>  
**Subject:** RE: Availability of Draft EIA Reports for Comment - Kudu Solar PV

[The e-mail server of the sender failed SPF checks and maybe malicious (SPF Record)]  
Good morning,

Please upload the executive summary and appendix C containing the maps.

Regards,

**From:** EMS <[ems@csir.co.za](mailto:ems@csir.co.za)>  
**Sent:** Friday, June 30, 2023 10:35 AM  
**To:** Natasha Higgitt <[nhiggitt@sahra.org.za](mailto:nhiggitt@sahra.org.za)>  
**Cc:** EMS <[ems@csir.co.za](mailto:ems@csir.co.za)>  
**Subject:** RE: Availability of Draft EIA Reports for Comment - Kudu Solar PV

Hi Natasha

Thanks for your reply – the executive summary and App C have been uploaded for each case.

Please let me know if all is ok?

Thanks  
Rohaida

## APPENDICES

ENVIRONMENTAL IMPACT ASSESSMENT REPORT: Scoping and Environmental Impact Assessment (EIA) Process for the Proposed Development of a Solar Photovoltaic (PV) Facility (Kudu Solar Facility 3) and associated infrastructure, near De Aar, Northern Cape Province

---

**From:** Natasha Higgitt <nhiggitt@sahra.org.za>  
**Sent:** Friday, 30 June 2023 10:42  
**To:** EMS  
**Subject:** RE: Availability of Draft EIA Reports for Comment - Kudu Solar PV

[The e-mail server of the sender failed SPF checks and maybe malicious (SPF Record)]  
Good morning,

Thank you for the update. All appears in order now. I will be issuing the comments by either the end of the day or Monday morning.

Regards,

## APPENDICES

ENVIRONMENTAL IMPACT ASSESSMENT REPORT: Scoping and Environmental Impact Assessment (EIA) Process for the Proposed Development of a Solar Photovoltaic (PV) Facility (Kudu Solar Facility 3) and associated infrastructure, near De Aar, Northern Cape Province

---

**From:** Rohaida Abed  
**Sent:** Friday, 30 June 2023 16:05  
**To:** EMS  
**Subject:** FW: New private message from SAHRIS: SAHRIS Case ID 20336 20337 20338 20339 20340 20341 20342 20343 20344 20345 20346 20347

-----Original Message-----

From: sahrisadmin@sahra.org.za <sahrisadmin@sahra.org.za>  
Sent: Friday, June 30, 2023 3:55 PM  
To: Rohaida Abed <RAbed@csir.co.za>  
Subject: New private message from SAHRIS: SAHRIS Case ID 20336 20337 20338 20339 20340 20341 20342 20343 20344 20345 20346 20347

[The e-mail server of the sender failed SPF checks and maybe malicious (SPF Record)]

Hi rohaida.abed,

This is an automatic reminder from the site SAHRA. You have received a new private message from natasha.higgitt.

To read your message on SAHRIS,  
First LOGIN TO SAHRIS  
then, follow this link:  
<https://sahris.sahra.org.za/messages/view/38272>

Alternatively, login to SAHRIS and navigate to [www.sahris.sahra.org.za/messages](http://www.sahris.sahra.org.za/messages)

The body of your message reads:

\*\*\*\*

Good afternoon,

Please note that Final Comments have been issued on SAHRIS Case ID 20336 20337 20338 20339 20340 20341 20342 20343 20344 20345 20346 20347. Please see links to the cases.

Kind regards,  
Natasha Higgitt  
\*\*\*\*

If you don't want to receive these emails again, change your preferences here:  
<https://sahris.sahra.org.za/user/13256/edit>

Please do not reply to this automated message as it is generated by the system account.

## APPENDICES

### ENVIRONMENTAL IMPACT ASSESSMENT REPORT: Scoping and Environmental Impact Assessment (EIA) Process for the Proposed Development of a Solar Photovoltaic (PV) Facility (Kudu Solar Facility 3) and associated infrastructure, near De Aar, Northern Cape Province

---

From: EMS <ems@csir.co.za>  
Sent: Wednesday, July 5, 2023 6:03 PM  
To: Natasha Higgitt <nhiggitt@sahra.org.za>  
Cc: EMS <ems@csir.co.za>  
Subject: SAHRIS Case ID 20336 - 20347 - Kudu Solar Facilities 1 to 12

Hi Natasha

I hope that you are well. Thank you very much for sending us all the SAHRA comments on the Kudu Solar Facilities on 30 June, we appreciate it.

I wanted to double check the comment on PV12 (attached, case 20347) - please see attached, it refers to PV11, and states "final comment" twice.

Thanks  
Rohaida

From: Natasha Higgitt <nhiggitt@sahra.org.za>  
Sent: Thursday, July 6, 2023 9:10 AM  
To: EMS <ems@csir.co.za>  
Subject: RE: SAHRIS Case ID 20336 - 20347 - Kudu Solar Facilities 1 to 12

[The e-mail server of the sender failed SPF checks and maybe malicious (SPF Record)]

Good morning,

Thank you for bringing this to my attention. I have corrected the comment. My apologies for any inconvenience.

Kind regards,

**From:** EMS <ems@csir.co.za>  
**Sent:** Friday, 07 July 2023 01:16  
**To:** Natasha Higgitt  
**Cc:** EMS  
**Subject:** RE: SAHRIS Case ID 20336 - 20347 - Kudu Solar Facilities 1 to 12

Hi Natasha

Thank you very much for the updated comment for PV12, we appreciate it very much. I have downloaded it.

Kind Regards,  
Rohaida



## APPENDICES

### ENVIRONMENTAL IMPACT ASSESSMENT REPORT: Scoping and Environmental Impact Assessment (EIA) Process for the Proposed Development of a Solar Photovoltaic (PV) Facility (Kudu Solar Facility 3) and associated infrastructure, near De Aar, Northern Cape Province

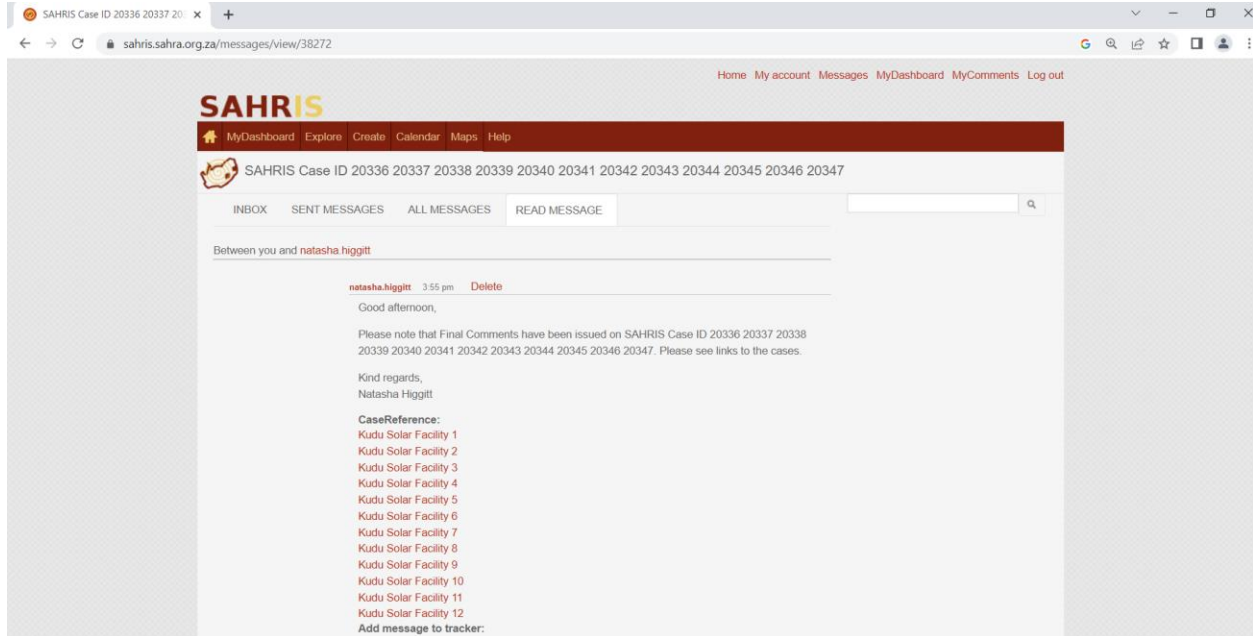

## APPENDICES

### ENVIRONMENTAL IMPACT ASSESSMENT REPORT: Scoping and Environmental Impact Assessment (EIA) Process for the Proposed Development of a Solar Photovoltaic (PV) Facility (Kudu Solar Facility 3) and associated infrastructure, near De Aar, Northern Cape Province

#### Kudu Solar Facility 3

**Kudu Solar Facility 3**

**Our Ref:**



T: +27 21 462 4502 | F: +27 21 462 4509 | E: info@sahra.org.za  
South African Heritage Resources Agency | 111 Harrington Street | Cape Town  
P.O. Box 4637 | Cape Town | 8001  
www.sahra.org.za

an agency of the  
Department of Arts and Culture

Enquiries: Natasha Higgitt  
Tel: 021 202 8660  
Email: nhiggitt@sahra.org.za  
CaseID: 20338

Date: Friday June 30, 2023  
Page No: 1

#### Final Comment

In terms of Section 38(4), 38(8) of the National Heritage Resources Act (Act 25 of 1999)

Attention: Kudu Solar Facility 3 (Pty) Ltd

**Kudu Solar Facility 1 (Pty) Ltd to Kudu Solar Facility 12 (Pty) Ltd is proposing to develop 12 Solar Photovoltaic (PV) power generation facilities and associated Electrical Grid Infrastructure (EGI), north-east of the town of De Aar, in the Renosterberg Local Municipality and Pixley Ka Seme District Municipality, in the Northern Cape Province. Scoping and Environmental Impact Assessment (EIA) Processes are currently being undertaken for the 12 Solar PV facilities. Separate Basic Assessment (BA) and/or EGI Standard Registration processes will be commissioned separately, once finalised, for the EGI projects. This case is for the proposed Kudu Solar Facility 3, and the Applicant is Kudu Solar Facility 3 (Pty) Ltd.**

The Council for Scientific and Industrial Research (CSIR) has been appointed by ABO Wind renewable energies (Pty) Ltd to undertake an Environmental Authorisation Application for the proposed Kudu Solar Facility 3 and associated infrastructure, near De Aar, Northern Cape Province.

A Draft Scoping Report (DSR) has been submitted in terms of the National Environmental Management Act, 1998 (NEMA) and the NEMA Environmental Impact Assessment (EIA) Regulations. The proposed activities will include the construction of solar panels, auxiliary buildings, inverter/transformer stations, on-site substation complex, battery energy storage system (BESS), underground cables, access roads, internal roads, fencing, storm water channels, panel cleaning and maintenance area, laydown areas with an overall application area of 72 ha.

Natura Viva CC and ASHA Consulting (Pty) Ltd were appointed to provide heritage specialist input as part of the EA process as per section 24(4)b(iii) of NEMA and section 38(8) of the National Heritage Resources Act, Act 25 of 1999 (NHRA).

*Almond, J. E. 2022. Site Sensitivity Verification Report: Proposed Development of the Kudu Solar Photovoltaic Facilities and Associated Infrastructure near Philipstown and De Aar, Pixley Ka Seme District, Northern Cape Province.*

A report that combines the assessment of all 12 Kudu Solar Projects has been submitted.

## APPENDICES

### ENVIRONMENTAL IMPACT ASSESSMENT REPORT: Scoping and Environmental Impact Assessment (EIA) Process for the Proposed Development of a Solar Photovoltaic (PV) Facility (Kudu Solar Facility 3) and associated infrastructure, near De Aar, Northern Cape Province

#### Kudu Solar Facility 3

Our Ref:



an agency of the  
Department of Arts and Culture

T: +27 21 462 4502 | F: +27 21 462 4509 | E: info@sahra.org.za  
South African Heritage Resources Agency | 111 Harrington Street | Cape Town  
P.O. Box 4637 | Cape Town | 8001  
www.sahra.org.za

Enquiries: Natasha Higgitt  
Tel: 021 202 8660  
Email: nhiggitt@sahra.org.za  
CaseID: 20338

Date: Friday June 30, 2023  
Page No: 2

The proposed development footprint is underlain by the Waterford Formation, the Tierberg Formation and are overlain by the Late Caenozoic calcrete hardpans, alluvial deposits, surface gravels and soils of low sensitivity. A Chance Finds Procedure is recommended to be implemented.

*Orton, J. 2022. Heritage Specialist Scoping Report Inputs: Scoping and Environmental Impact Assessment (EIA) Process for the Proposed Development of a Solar Photovoltaic Facility (Kudu Solar Facility 3) and associated infrastructure, near De Aar, Northern Cape Province*

No heritage resources were identified within the Kudu Solar Facility 3. Two ephemeral scatters of Stone Age lithics of very low sensitivity were identified on the outskirts of the development boundary. A Chance Finds Procedure is recommended, and the recommendations of the Visual Impact Assessment must be followed.

In an Interim Comment issued on the 25/01/2023, SAHRA requested that the HIA be revised and an addendum to the PIA must be submitted with specific results for the Kudu Solar 3 project. Since the issuing of the Interim Comment, an HIA and PIA have been submitted (04/06/2023).

*Almond, J. E. 2023. Site Sensitivity Verification Report (In Terms of Part A of the Assessment Protocols Published in GN 320 on 20 March 2020). Proposed Development of the Kudu Solar Photovoltaic Facilities and Associated Infrastructure near Philipstown and De Aar, Pixley Ka Seme District, Northern Cape Province*

No fossils were identified within the proposed development area. A Chance Finds Procedure is recommended to be followed.

*Orton, J. 2023. Heritage Specialist Study: Scoping and Environmental Impact Assessment (EIA) Processes for the Proposed Development of a Solar Photovoltaic Facility (Kudu Solar Facility 3) and associated infrastructure, near De Aar, Northern Cape Province*

The report has been revised to include a tracklog of the completed survey.

#### Final Comment

The following comments are made as a requirement in terms of section 38(8) of the NHRA in the format provided in section 38(4) of the NHRA and must be included in the Final EIA and EMP:

- 38(4)a – The SAHRA Development Applications Unit has no objections to the proposed development;

## APPENDICES

### ENVIRONMENTAL IMPACT ASSESSMENT REPORT: Scoping and Environmental Impact Assessment (EIA) Process for the Proposed Development of a Solar Photovoltaic (PV) Facility (Kudu Solar Facility 3) and associated infrastructure, near De Aar, Northern Cape Province

#### Kudu Solar Facility 3

Our Ref:



an agency of the  
Department of Arts and Culture

T: +27 21 462 4502 | F: +27 21 462 4509 | E: [info@sahra.org.za](mailto:info@sahra.org.za)  
South African Heritage Resources Agency | 111 Harrington Street | Cape Town  
P.O. Box 4637 | Cape Town | 8001  
[www.sahra.org.za](http://www.sahra.org.za)

Enquiries: Natasha Higgitt  
Tel: 021 202 8660  
Email: [nhiggitt@sahra.org.za](mailto:nhiggitt@sahra.org.za)  
CaseID: 20338

Date: Friday June 30, 2023  
Page No: 3

- 38(4)b – The recommendations of the specialists are supported and must be adhered to. No further additional specific conditions are provided for the development;
- 38(4)c(i) – If any evidence of archaeological sites or remains (e.g. remnants of stone-made structures, indigenous ceramics, bones, stone artefacts, ostrich eggshell fragments, charcoal and ash concentrations), fossils or other categories of heritage resources are found during the proposed development, SAHRA DAU (Natasha Higgitt 021 202 8660/ [nhiggitt@sahra.org.za](mailto:nhiggitt@sahra.org.za)) must be alerted as per section 35(3) of the NHRA. Non-compliance with this section of the NHRA is an offense in terms of section 51(1)e of the NHRA and item 5 of the Schedule;
- 38(4)c(ii) – If unmarked human burials are uncovered, the SAHRA DAU (Natasha Higgitt 021 202 8660/ [nhiggitt@sahra.org.za](mailto:nhiggitt@sahra.org.za)) must be alerted immediately as per section 36(6) of the NHRA. Non-compliance with section of the NHRA is an offense in terms of section 51(1)e of the NHRA and item 5 of the Schedule;
- 38(4)d – See section 51(1) of the NHRA regarding offences;
- 38(4)e – The following conditions apply with regards to the appointment of specialists:
  - i) If heritage resources are uncovered during the course of the development, a professional archaeologist or palaeontologist, depending on the nature of the finds, must be contracted as soon as possible to inspect the heritage resource. If the newly discovered heritage resources prove to be of archaeological or palaeontological significance, a Phase 2 rescue operation may be required subject to permits issued by SAHRA;
- The Final EIA must be submitted to the SAHRIS application for record purposes;
- The decision regarding the EA application must be submitted to the SAHRIS application for record purposes.

Should you have any further queries, please contact the designated official using the case number quoted above in the case header.

Yours faithfully

Natasha Higgitt  
Manager: Development Applications Unit

## APPENDICES

### ENVIRONMENTAL IMPACT ASSESSMENT REPORT: Scoping and Environmental Impact Assessment (EIA) Process for the Proposed Development of a Solar Photovoltaic (PV) Facility (Kudu Solar Facility 3) and associated infrastructure, near De Aar, Northern Cape Province

---

#### Kudu Solar Facility 3

Our Ref:



an agency of the  
Department of Arts and Culture

T: +27 21 462 4502 | F: +27 21 462 4509 | E: info@sahra.org.za  
South African Heritage Resources Agency | 111 Harrington Street | Cape Town  
P.O. Box 4637 | Cape Town | 8001  
www.sahra.org.za

Enquiries: Natasha Higgitt  
Tel: 021 202 8660  
Email: nhiggitt@sahra.org.za  
CaseID: 20338

Date: Friday June 30, 2023  
Page No: 4

South African Heritage Resources Agency

---

#### ADMIN:

Direct URL to case: <https://sahris.sahra.org.za/node/611026>  
(DFFE, Ref: 14/12/16/3/3/2/2246)

#### Terms & Conditions:

1. This approval does not exonerate the applicant from obtaining local authority approval or any other necessary approval for proposed work.
2. If any heritage resources, including graves or human remains, are encountered they must be reported to SAHRA immediately.
3. SAHRA reserves the right to request additional information as required.

## APPENDICES

ENVIRONMENTAL IMPACT ASSESSMENT REPORT: Scoping and Environmental Impact Assessment (EIA) Process for the Proposed Development of a Solar Photovoltaic (PV) Facility (Kudu Solar Facility 3) and associated infrastructure, near De Aar, Northern Cape Province

---

### 5. Comments received from the Department of Defence (DoD)

---

**From:** [REDACTED]  
**Sent:** Thursday, 08 June 2023 09:58  
**To:** [REDACTED]  
**Cc:** [REDACTED]  
**Subject:** Renewable Energy Applications:Outstanding information to complete  
**Attachments:** Renewable Outstanding.jpg  
**Importance:** High  
**Categories:** This message has been archived by Retain on June 20 2023 13:07

You don't often get email from [REDACTED] [Learn why this is important](#)

Good Morning

Please see attached Screenshot of Folders which require both Application and .KML / .KMZ files.

I did not receive any further info, other than the letter received from Log referring to the Applications (Request for comments Batch 3 of 2023)

Please provide the required info in order to clear this folder from CMIS Response on Telecom  
Regards,

*Lieutenant Colonel* [REDACTED]

*Department of Defence  
Command and Management Information Systems Division  
Directorate CMIS Static Systems (PSM)  
Radio Spectrum & Communication Site Management  
Eco-Park Estate (Street Code 0157,  
Eco Glades 1  
South-West Wing, Block C, Floor 2  
Centurion  
0157  
Pretoria  
South Africa  
(25°53'25.2"S 28°10'09.8"E),*

*E-Mail:* [REDACTED]  
*Tel Office:* [REDACTED]  
*Work Fax:* [REDACTED]  
*Cellular:* [REDACTED]

## APPENDICES

### ENVIRONMENTAL IMPACT ASSESSMENT REPORT: Scoping and Environmental Impact Assessment (EIA) Process for the Proposed Development of a Solar Photovoltaic (PV) Facility (Kudu Solar Facility 3) and associated infrastructure, near De Aar, Northern Cape Province

Name	Date modified	Type
162. Harmony Allanridge_incomplete	2023/02/07 11:01	File folder
163. Crossroads-incomplete	2023/02/07 10:58	File folder
164. Dubula-incomplete	2023/02/07 11:05	File folder
165. Greenbushes_incomplete	2023/02/07 11:07	File folder
170. Mopane Solar_incomplete	2023/03/07 10:26	File folder
178. Kleinsee PV-incomplete	2023/05/04 08:39	File folder
186. Kgololesego_no info	2023/05/26 13:35	File folder
187. Letsatsi_no info	2023/05/26 13:37	File folder
191. Unnamed A90139 KHANG_UMSI Cluster_no obj	2023/05/29 13:51	File folder
196. Forzando_no info	2023/05/26 13:39	File folder
198. WKN Windcurrent_no info	2023/05/26 13:40	File folder
205. Brits ELBA Solar_no info	2023/05/26 13:45	File folder
207. Daggakraal WF_no info	2023/05/26 13:45	File folder
209. Umsinde Emoyeni WF_no info	2023/05/26 13:46	File folder
210. Khangela Emoyeni WF_no info	2023/05/26 13:46	File folder
216. Kudu Solar_no info	2023/06/08 09:49	File folder

## APPENDICES

ENVIRONMENTAL IMPACT ASSESSMENT REPORT: Scoping and Environmental Impact Assessment (EIA) Process for the Proposed Development of a Solar Photovoltaic (PV) Facility (Kudu Solar Facility 3) and associated infrastructure, near De Aar, Northern Cape Province

---

### 6. Comments received from the Department of Water and Sanitation (DWS)

---

**From:** Mokhoantle Lerato (KBY) <MokhoantleL@dws.gov.za>  
**Sent:** Thursday, 22 June 2023 08:30  
**To:** EMS; Jansen Melinda(UPN); Kgaphola Mashudu (UPN); Cloete Shaun; Jansen Melinda(UPN); Kgaphola Mashudu (UPN); Sekwaila Kwena Khutjo (KBY); Franks Lindiwe; Van Dyk Gawie (KBY)  
**Subject:** RE: Reminder - Availability of Draft EIA Reports for Comment - Kudu Solar PV - DWS  
**Categories:** This message has been archived by Retain on June 30 2023 02:41

Good day Sir/Madam

The area in question falls within Lower Orange WMA and the colleagues there has this communication, so they will respond accordingly.

**From:** EMS <ems@csir.co.za>  
**Sent:** Friday, 23 June 2023 10:43  
**To:** Mokhoantle Lerato (KBY) <MokhoantleL@dws.gov.za>; EMS <ems@csir.co.za>; Jansen Melinda(UPN) <JansenMe@dws.gov.za>; Kgaphola Mashudu (UPN) <KgapholaM@dws.gov.za>; Cloete Shaun <CloeteS@dws.gov.za>; Jansen Melinda(UPN) <JansenMe@dws.gov.za>; Kgaphola Mashudu (UPN) <KgapholaM@dws.gov.za>; Sekwaila Kwena Khutjo (KBY) <SekwailaK@dws.gov.za>; Franks Lindiwe <FranksL@dws.gov.za>; Van Dyk Gawie (KBY) <VanDykG@dws.gov.za>  
**Subject:** RE: Reminder - Availability of Draft EIA Reports for Comment - Kudu Solar PV - DWS

Good day Lerato

Thank you very much for your feedback, it is appreciated. We kindly look forward to feedback from the Lower Orange WMA team (the comment period closes on 3 July 2023).

Thank you for your assistance with this.

Kind Regards,  
Rohaida

CSIR Environmental Management Services  
E-mail: [ems@csir.co.za](mailto:ems@csir.co.za)  
Postal Address: Postnet Suite 367, Private Bag x10, Musgrave Road, 4062  
Tel: 031 242 2300



## APPENDICES

### ENVIRONMENTAL IMPACT ASSESSMENT REPORT: Scoping and Environmental Impact Assessment (EIA) Process for the Proposed Development of a Solar Photovoltaic (PV) Facility (Kudu Solar Facility 3) and associated infrastructure, near De Aar, Northern Cape Province

---

**From:** Jansen Melinda(UPN) <JansenMe@dws.gov.za>  
**Sent:** Monday, 26 June 2023 10:28  
**To:** EMS  
**Cc:** Cloete Shaun; Hlengani Alexia (UPN)  
**Subject:** Letters for Comments - Kudu Solar PV - letters 1 - 6  
**Attachments:** Kudu Solar 1- Letter.pdf; Kudu Solar 2- Letter.pdf; Kudu Solar 3- Letter.pdf; Kudu Solar 4- Letter.pdf; Kudu Solar 6- Letter.pdf; Kudu Solar 5- Letter.pdf

**Categories:** This message has been archived by Retain on July 04 2023 07:36

Good morning Rohaida

Please find attached letters 1 to 6 for the Proposed Development of 12 Solar Photovoltaic (PV) Facilities (I.E. Kudu Solar Facilities) and Various Associated Infrastructure, near De Aar, Northern Cape as requested.

The assessor is still busy with Letters 7 to 12. The originals will be sent via registered mail.

With kind regards,

**Melinda Jansen**  
SAC:Water Quality Management  
Lower Orange Water Management Area  
Louisvale Road  
**Upington 8801**  
Department of Water and Sanitation

T: 054 338 5800

F: 054 334 0205

[JansenMe@dwa.gov.za](mailto:JansenMe@dwa.gov.za)

“Water is Life - Sanitation is Dignity”



## APPENDICES

### ENVIRONMENTAL IMPACT ASSESSMENT REPORT: Scoping and Environmental Impact Assessment (EIA) Process for the Proposed Development of a Solar Photovoltaic (PV) Facility (Kudu Solar Facility 3) and associated infrastructure, near De Aar, Northern Cape Province

#### Kudu Solar Facility 3

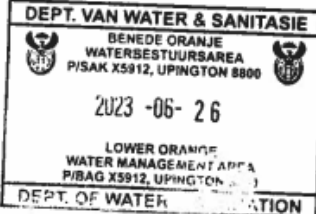
	<b>water &amp; sanitation</b> Department: Water and Sanitation REPUBLIC OF SOUTH AFRICA
Northern Cape Region Lower Orange Water Management Area Private Bag X5912, Upington, 8800 Tel: (054) 338-5800, Fax: (054) 334-0205, <a href="http://www.dwa.gov.za">www.dwa.gov.za</a>	
F ☎ 054 334 0205	✉ A.A Hlengani
E ✉ <a href="mailto:hlangania@dws.gov.za">hlangania@dws.gov.za</a>	☎ 054 338 5800
<p>ABO Wind renewable energies (Pty) Ltd (Facility 3) P. O. Box 320 Stellenbosch 7599</p> <p>Tell: +27 21 852 7333 By E-mail: <a href="mailto:capetown@abo-wind.com">capetown@abo-wind.com</a></p> <p><b>Attention:</b> Du Toit Malherbe</p>	
	

Dear Sir

**SCOPING AND ENVIRONMENTAL IMPACT ASSESSMENT FOR THE PROPOSED DEVELOPMENT OF A SOLAR PHOTOVOLTAIC (PV) FACILITY (KUDU SOLAR FACILITY 3) AND ASSOCIATED INFRASTRUCTURE, NEAR DE AAR, NORTHERN CAPE PROVINCE**

Reference is made to the above-mentioned report with the cover letter dated June 2023, submitted to Department of Water and Sanitation.

This Department has no objection to the proposed amendments of the above-mentioned application and wish to comment as follows:

1. The Report states that the Solid-State Lithium-Ion BESS or Redox Flow BESS with the capacity of Up to 500 MW / 500 MWh. In case of leakages or spillages of hydrocarbons this department must be informed within 24 hours and immediate cleanup procedure must be conducted as stipulated in section 19 of the National Water Act; (Act 36 of 1998), any cleanup of the contaminants must be disposed of in a permitted hazardous landfill site and remediation report for the clean-up measures must be sent to the department for comments before implementation.
2. All tank and pipe installations must be done according to the applicable SABS standards in order to minimize the potential for leakage and contamination of water resources



## APPENDICES

### ENVIRONMENTAL IMPACT ASSESSMENT REPORT: Scoping and Environmental Impact Assessment (EIA) Process for the Proposed Development of a Solar Photovoltaic (PV) Facility (Kudu Solar Facility 3) and associated infrastructure, near De Aar, Northern Cape Province

---

#### **SCOPING AND ENVIRONMENTAL IMPACT ASSESSMENT FOR THE PROPOSED DEVELOPMENT OF A SOLAR PHOTOVOLTAIC (PV) FACILITY (KUDU SOLAR FACILITY 3) AND ASSOCIATED INFRASTRUCTURE, NEAR DE AAR, NORTHERN CAPE PROVINCE**

3. Ground Water Management and monitoring must form part of risk management plan, please ensure that appropriate borehole monitoring points are sited and used for ground water level and quality monitoring only.
4. The report indicates that new internal service roads will need to be established in the vicinity of the project area. The applicant must further indicate to this Department the distance between the project area and the said watercourse. No development is to take place within 100 metres from the edge of a watercourse or the riparian habitat without consent from this Department.
5. The stormwater drainage network system must be kept separate from the wastewater (water containing waste) system. Furthermore, stormwater must be managed in such a manner as to disperse runoff and to prevent the concentration of storm water flow.
6. It is understood that sewage arising from this development will be treating at an onsite conservancy tank. The applicant should submit a written letter to indicate the capacity of the conservancy tanks. There must be a written agreement between the applicant and the Water Services Authority in the area, for the clearing and disposal of sewer sludge accumulated from the conservancy tanks into an authorized WWTW. Civil designs done by the registered professional engineer for the septic tank and the capacity must be provided to check if it will be needed. The designs must be signed by the registered engineer and his or her professional number must be provided.
7. It is note that the source of water is obtained from existing boreholes located on the property, it further highlighted that new borehole's will be drilled to source groundwater. The landowners are reminded to register the boreholes Section 21(a) water uses respectively with this Department and to ensure that the necessary authorisation is obtained.
8. All tank and pipe installations must be done according to the applicable SABS standards to minimize the potential for leakage and contamination of water resources.
9. The applicant shall provide the Department with the disposal method of the waste. the applicant shall note that all domestic waste generated on site and any waste associated with the operation be disposed of at licensed landfill site. A signed copy of service agreement shall be submitted to this Department to demonstrate that indeed provision will be made to render such services.
10. The applicant must note that no activities are allowed within 100m of a water resource or within 1:100-year flood line (whichever is the greatest), if the proposed activity fall within these criteria, the applicant need to apply for water use license to ensure that the riparian ecological status of the water resource will not be negatively impacted.
11. Please note that any development within 500m from the boundary of any wetland requires a water use licence according to National Water Act (NWA) 1998 (Act No.36 of 1998).

## APPENDICES

### ENVIRONMENTAL IMPACT ASSESSMENT REPORT: Scoping and Environmental Impact Assessment (EIA) Process for the Proposed Development of a Solar Photovoltaic (PV) Facility (Kudu Solar Facility 3) and associated infrastructure, near De Aar, Northern Cape Province

---

#### **12. SCOPING AND ENVIRONMENTAL IMPACT ASSESSMENT FOR THE PROPOSED DEVELOPMENT OF A SOLAR PHOTOVOLTAIC (PV) FACILITY (KUDU SOLAR FACILITY 3) AND ASSOCIATED INFRASTRUCTURE, NEAR DE AAR, NORTHERN CAPE PROVINCE**

13. Waste needs to be collected and disposed of at a registered municipal site during and after construction, and written agreement should be provided to this department.

14. Please note that all requirements as stipulated in the national water Act (NWA) 1998 (Act no.36 of 1998) must be adhered to.

Please feel free to contact this department, should there be any enquiries.

Yours sincerely,

PP 

.....  
PROVINCIAL HEAD: NORTHERN CAPE OPERATIONS

DATE:

2023-06-23

## APPENDICES

ENVIRONMENTAL IMPACT ASSESSMENT REPORT: Scoping and Environmental Impact Assessment (EIA) Process for the Proposed Development of a Solar Photovoltaic (PV) Facility (Kudu Solar Facility 3) and associated infrastructure, near De Aar, Northern Cape Province

---

**From:** EMS <ems@csir.co.za>  
**Sent:** Tuesday, 27 June 2023 10:54  
**To:** Jansen Melinda(UPN) <JansenMe@dws.gov.za>  
**Cc:** Cloete Shaun <CloeteS@dws.gov.za>; Hlengani Alexia (UPN) <HlenganiA@dws.gov.za>; EMS <ems@csir.co.za>  
**Subject:** RE: Letters for Comments - Kudu Solar PV - letters 1 - 6

Dear Melinda

Thank you very much for sending through the comments for Kudu Solar Facilities 1 to 6, it is appreciated.

Kindly note that the comment period closes on 3 July 2023 – please kindly send the comments for the Kudu Solar Facilities 7 to 12 by 3 July 2023.

We also have the following query:

The proposed projects are intended to be submitted in next rounds of the REIPPPP, and any applications for WUL or GA will be undertaken post Environmental Authorisation (EA) (should it be granted). Other EAs have been granted positively based on the same understanding and process, and proof of WUL or GA submission during the EIA Process was not a requirement. Therefore, please confirm that since this is a REIPPPP project, any applications for WUL or GA can be undertaken post EA (should it be granted). Kindly confirm that this is acceptable.

Thank you for your assistance with this.

Kind Regards,  
Rohaida

CSIR Environmental Management Services  
E-mail: [ems@csir.co.za](mailto:ems@csir.co.za)  
Postal Address: Postnet Suite 367, Private Bag x10, Musgrave Road, 4062  
Tel: 031 242 2300  
Cell: 072 204 6224

## APPENDICES

### ENVIRONMENTAL IMPACT ASSESSMENT REPORT: Scoping and Environmental Impact Assessment (EIA) Process for the Proposed Development of a Solar Photovoltaic (PV) Facility (Kudu Solar Facility 3) and associated infrastructure, near De Aar, Northern Cape Province

---

**From:** Jansen Melinda(UPN) <JansenMe@dws.gov.za>  
**Sent:** Tuesday, 27 June 2023 10:58  
**To:** Hlengani Alexia (UPN)  
**Cc:** Cloete Shaun; EMS  
**Subject:** RE: Letters for Comments - Kudu Solar PV - letters 1 - 6

**Categories:** This message has been archived by Retain on July 05 2023 04:40

Good morning Ms Hlengani

Please see below response from EMS with regard to the outstanding letters and the due date.

Could you please assist with the query below?

With kind regards,

**Melinda Jansen**  
SAC:Water Quality Management  
Lower Orange Water Management Area  
Louisvale Road  
**Upington 8801**  
Department of Water and Sanitation

T: 054 338 5800

F: 054 334 0205

[JansenMe@dwa.gov.za](mailto:JansenMe@dwa.gov.za)

“Water is Life - Sanitation is Dignity”



## APPENDICES

ENVIRONMENTAL IMPACT ASSESSMENT REPORT: Scoping and Environmental Impact Assessment (EIA) Process for the Proposed Development of a Solar Photovoltaic (PV) Facility (Kudu Solar Facility 3) and associated infrastructure, near De Aar, Northern Cape Province

---

### 7. Comments received from Eskom

---

**From:** John Geeringh [GeerinJH@eskom.co.za](mailto:GeerinJH@eskom.co.za)

**Sent:** Thursday, June 8, 2023 2:38 PM

**To:** EMS [ems@csir.co.za](mailto:ems@csir.co.za)

**Subject:** RE: [CAUTION:EXTERNAL EMAIL] RE: Reminder of the Availability of Draft EIA Reports for Comment - Kudu Solar PV

Please send me the KMZ files of the proposed development areas and grid connection as requested earlier.

Kind regards

John Geeringh (Pr Sci Nat) Reg. EAP (EAPASA)  
Senior Consultant Environmental Management  
Grid Planning: Land and Rights  
Eskom Transmission Division  
Megawatt Park, D1Y42, Maxwell Drive, Sunninghill, Sandton.  
P O Box 1091, Johannesburg, 2000.  
Tel: 011 516 7233  
Cell: 083 632 7663  
Fax: 086 661 4064  
E-mail: [john.geeringh@eskom.co.za](mailto:john.geeringh@eskom.co.za)

**From:** EMS <[ems@csir.co.za](mailto:ems@csir.co.za)>

**Sent:** Thursday, 08 June 2023 14:58

**To:** John Geeringh <[GeerinJH@eskom.co.za](mailto:GeerinJH@eskom.co.za)>

**Cc:** EMS <[ems@csir.co.za](mailto:ems@csir.co.za)>

**Subject:** RE: [CAUTION:EXTERNAL EMAIL] RE: Reminder of the Availability of Draft EIA Reports for Comment - Kudu Solar PV

Hi John

I hope that you are well. Please let me know if you received the attached email earlier in the year?

Please also see attached the updated buildable areas for the project.

Look forward to your feedback.

Kind Regards,  
Rohaida Abed

CSIR Environmental Management Services

E-mail: [ems@csir.co.za](mailto:ems@csir.co.za)

Postal Address: Postnet Suite 367, Private Bag x10, Musgrave Road, 4062

Tel: 031 242 2300

## APPENDICES

ENVIRONMENTAL IMPACT ASSESSMENT REPORT: Scoping and Environmental Impact Assessment (EIA) Process for the Proposed Development of a Solar Photovoltaic (PV) Facility (Kudu Solar Facility 3) and associated infrastructure, near De Aar, Northern Cape Province

---

**From:** John Geeringh <GeerinJH@eskom.co.za>  
**Sent:** Thursday, 08 June 2023 15:01  
**To:** EMS  
**Subject:** RE: [CAUTION:EXTERNAL EMAIL] RE: Reminder of the Availability of Draft EIA Reports for Comment - Kudu Solar PV

**Categories:** This message has been archived by Retain on June 20 2023 13:07

I thought I received it but I could not find it anywhere?? Sorry for the trouble

Regards

John

**From:** Khululwa Gaongalelwe <Stuurmkv@eskom.co.za>  
**Sent:** Thursday, 08 June 2023 16:12  
**To:** EMS  
**Cc:** Christo Badenhorst  
**Subject:** FW: [CAUTION:EXTERNAL EMAIL] RE: Reminder of the Availability of Draft EIA Reports for Comment - Kudu Solar PV  
**Attachments:** Cover Letter to I&APs\_DEIRs\_Kudu Solar 1-12\_June2023.pdf

**Categories:** This message has been archived by Retain on June 20 2023 13:07

You don't often get email from [stuurmkv@eskom.co.za](mailto:stuurmkv@eskom.co.za). [Learn why this is important](#)

Dear Rohaidar

I trust you are good.

Kindly share Kmz files so that we may check if our Eskom powerlines are not affected.

Thank you.

Warm regards

Kh Khululwa Gaongalelwe

Senior Environmental Advisor

Grid Planning & Development: Land Rights

Transmission Division

Megawatt Park D1X37 Maxwell Drive Sunninghill Sandton

Cell +27 72 444 3513

Email [stuurmkv@eskom.co.za](mailto:stuurmkv@eskom.co.za)



## APPENDICES

### ENVIRONMENTAL IMPACT ASSESSMENT REPORT: Scoping and Environmental Impact Assessment (EIA) Process for the Proposed Development of a Solar Photovoltaic (PV) Facility (Kudu Solar Facility 3) and associated infrastructure, near De Aar, Northern Cape Province

---

**From:** Khululwa Gaongalelwe <Stuurmkv@eskom.co.za>  
**Sent:** Thursday, 08 June 2023 16:16  
**To:** EMS  
**Cc:** Christo Badenhorst  
**Subject:** RE: [CAUTION:EXTERNAL EMAIL] RE: Reminder of the Availability of Draft EIA Reports for Comment - Kudu Solar PV

**Categories:** This message has been archived by Retain on June 20 2023 13:07

You don't often get email from stuurmkv@eskom.co.za. [Learn why this is important](#)

Dear Rohaidar

Please ignore my previous email below.

Thank you.

Warm regards

Khululwa

**From:** John Geeringh <GeerinJH@eskom.co.za>  
**Sent:** Wednesday, 21 June 2023 15:00  
**To:** EMS  
**Subject:** RE: Reminder of the Availability of Draft EIA Reports for Comment - Kudu Solar PV - Eskom  
**Attachments:** Eskom requirements for work in or near Eskom servitudes.doc; Renewable Energy Generation Plant Setbacks to Eskom Infrastructure Rev2 - signed.pdf

**Categories:** This message has been archived by Retain on June 29 2023 00:46

Please find attached Eskom requirements for work at or near Eskom servitudes and infrastructure, as well as a setbacks guideline for renewable energy developments if I had not sent it earlier.

Kind regards

John Geeringh (Pr Sci Nat) Reg. EAP (EAPASA)  
Senior Consultant Environmental Management  
Grid Planning: Land and Rights  
Eskom Transmission Division  
Megawatt Park, D1Y42, Maxwell Drive, Sunninghill, Sandton.  
P O Box 1091, Johannesburg, 2000.  
Tel: 011 516 7233  
Cell: 083 632 7663  
Fax: 086 661 4064  
E-mail: [john.geeringh@eskom.co.za](mailto:john.geeringh@eskom.co.za)

## APPENDICES

### ENVIRONMENTAL IMPACT ASSESSMENT REPORT: Scoping and Environmental Impact Assessment (EIA) Process for the Proposed Development of a Solar Photovoltaic (PV) Facility (Kudu Solar Facility 3) and associated infrastructure, near De Aar, Northern Cape Province

---

#### TO WHOM IT MAY CONCERN

##### Eskom requirements for work in or near Eskom servitudes.

1. Eskom's rights and services must be acknowledged and respected at all times.
2. Eskom shall at all times retain unobstructed access to and egress from its servitudes.
3. Eskom's consent does not relieve the developer from obtaining the necessary statutory, land owner or municipal approvals.
4. Any cost incurred by Eskom as a result of non-compliance to any relevant environmental legislation will be charged to the developer.]
5. If Eskom has to incur any expenditure in order to comply with statutory clearances or other regulations as a result of the developer's activities or because of the presence of his equipment or installation within the servitude restriction area, the developer shall pay such costs to Eskom on demand.
6. The use of explosives of any type within 500 metres of Eskom's services shall only occur with Eskom's previous written permission. If such permission is granted the developer must give at least fourteen working days prior notice of the commencement of blasting. This allows time for arrangements to be made for supervision and/or precautionary instructions to be issued in terms of the blasting process. It is advisable to make application separately in this regard.
7. Changes in ground level may not infringe statutory ground to conductor clearances or statutory visibility clearances. After any changes in ground level, the surface shall be rehabilitated and stabilised so as to prevent erosion. The measures taken shall be to Eskom's satisfaction.
8. Eskom shall not be liable for the death of or injury to any person or for the loss of or damage to any property whether as a result of the encroachment or of the use of the servitude area by the developer, his/her agent, contractors, employees, successors in title, and assignees. The developer indemnifies Eskom against loss, claims or damages including claims pertaining to consequential damages by third parties and whether as a result of damage to or interruption of or interference with Eskom's services or apparatus or otherwise. Eskom will not be held responsible for damage to the developer's equipment.
9. No mechanical equipment, including mechanical excavators or high lifting machinery, shall be used in the vicinity of Eskom's apparatus and/or services, without prior written permission having been granted by Eskom. If such permission is granted the developer must give at least seven working days' notice prior to the commencement of work. This allows time for arrangements to be made for supervision and/or precautionary instructions to be issued by the relevant Eskom Manager

## APPENDICES

### ENVIRONMENTAL IMPACT ASSESSMENT REPORT: Scoping and Environmental Impact Assessment (EIA) Process for the Proposed Development of a Solar Photovoltaic (PV) Facility (Kudu Solar Facility 3) and associated infrastructure, near De Aar, Northern Cape Province

---

Note: Where and electrical outage is required, at least fourteen work days are required to arrange it.

10. Eskom's rights and duties in the servitude shall be accepted as having prior right at all times and shall not be obstructed or interfered with.
11. Under no circumstances shall rubble, earth or other material be dumped within the servitude restriction area. The developer shall maintain the area concerned to Eskom's satisfaction. The developer shall be liable to Eskom for the cost of any remedial action which has to be carried out by Eskom.
12. The clearances between Eskom's live electrical equipment and the proposed construction work shall be observed as stipulated by *Regulation 15* of the *Electrical Machinery Regulations of the Occupational Health and Safety Act, 1993 (Act 85 of 1993)*.
13. Equipment shall be regarded electrically live and therefore dangerous at all times.
14. In spite of the restrictions stipulated by Regulation 15 of the Electrical Machinery Regulations of the Occupational Health and Safety Act, 1993 (Act 85 of 1993), as an additional safety precaution, Eskom will not approve the erection of houses, or structures occupied or frequented by human beings, under the power lines or within the servitude restriction area.
15. Eskom may stipulate any additional requirements to highlight any possible exposure to Customers or Public to coming into contact or be exposed to any dangers of Eskom plant.
16. It is required of the developer to familiarise himself with all safety hazards related to Electrical plant.
17. Any third party servitudes encroaching on Eskom servitudes shall be registered against Eskom's title deed at the developer's own cost. If such a servitude is brought into being, its existence should be endorsed on the Eskom servitude deed concerned, while the third party's servitude deed must also include the rights of the affected Eskom servitude.

John Geeringh (Pr Sci Nat)(EAPASA)  
Senior Consultant Environmental Management  
Eskom Transmission Division: Land & Rights  
Megawatt Park, D1Y42, Maxwell Drive, Sunninghill, Sandton.  
P O Box 1091, Johannesburg, 2000.  
Tel: 011 516 7233  
Cell: 083 632 7663  
Fax: 086 661 4064  
E-mail: john.geeringh@eskom.co.za

**APPENDICES**

ENVIRONMENTAL IMPACT ASSESSMENT REPORT: Scoping and Environmental Impact Assessment (EIA) Process for the Proposed Development of a Solar Photovoltaic (PV) Facility (Kudu Solar Facility 3) and associated infrastructure, near De Aar, Northern Cape Province

---

	<b>SCOT</b>	<b>Technology</b>
---	-------------	-------------------

Title: **Renewable Energy Generation Plant Setbacks to Eskom Infrastructure** Unique Identifier: **240-65559775**

Alternative Reference Number: **N/A**

Area of Applicability: **Power Line Engineering**

Documentation Type: **Guideline**

Revision: **2**

Total Pages: **9**

Next Review Date: **N/A**

Disclosure Classification: **CONTROLLED DISCLOSURE**

Compiled by	Approved by	Authorised by
		
<b>J W Chetty</b> Mechanical Engineer	<b>B Ntshunsha</b> Chief Engineer (Lines)	<b>R A Vajeth</b> Snr Manager (Lines) and SCOT/SC/ Chairperson
Date: <u>15 / 09 / 2020</u>	Date: <u>30/10/2020</u>	Date: <u>30/10/2020</u>

PCM Reference: 240-65132732 **LINE ENGINEERING SERVICES**  
 SCOT Study Committee Number/Name : **OVERHEAD LINES**

## APPENDICES

### ENVIRONMENTAL IMPACT ASSESSMENT REPORT: Scoping and Environmental Impact Assessment (EIA) Process for the Proposed Development of a Solar Photovoltaic (PV) Facility (Kudu Solar Facility 3) and associated infrastructure, near De Aar, Northern Cape Province

---

Renewable Energy Generation Plant Setbacks to Eskom  
Infrastructure

Unique Identifier: 240-65559775  
Revision: 2  
Page: 2 of 9

---

## CONTENTS

	Page
EXECUTIVE SUMMARY .....	3
1. INTRODUCTION .....	4
2. SUPPORTING CLAUSES .....	4
2.1 SCOPE .....	4
2.1.1 Purpose .....	5
2.1.2 Applicability .....	5
2.2 NORMATIVE/INFORMATIVE REFERENCES .....	5
2.2.1 Normative .....	5
2.2.2 Informative .....	5
2.3 DEFINITIONS .....	6
2.3.1 Disclosure Classification .....	6
2.4 ABBREVIATIONS .....	6
2.5 ROLES AND RESPONSIBILITIES .....	6
2.6 PROCESS FOR MONITORING .....	6
2.7 RELATED/SUPPORTING DOCUMENTS .....	6
3. DOCUMENT CONTENT .....	6
3.1 INTERNATIONAL SETBACK COMPARISON .....	6
3.2 ESKOM REQUIRED SETBACKS .....	7
4. AUTHORISATION .....	9
5. REVISIONS .....	9
6. DEVELOPMENT TEAM .....	9

## FIGURES

Figure 1: Horizontal Axis Wind Turbine .....	8
--	---

### CONTROLLED DISCLOSURE

When downloaded from the EDMS, this document is uncontrolled and the responsibility rests with the user to ensure it is in line with the authorised version on the system.

## APPENDICES

### ENVIRONMENTAL IMPACT ASSESSMENT REPORT: Scoping and Environmental Impact Assessment (EIA) Process for the Proposed Development of a Solar Photovoltaic (PV) Facility (Kudu Solar Facility 3) and associated infrastructure, near De Aar, Northern Cape Province

---

**Renewable Energy Generation Plant Setbacks to Eskom Infrastructure**

Unique Identifier: 240-65559775  
Revision: 2  
Page: 3 of 9

---

#### EXECUTIVE SUMMARY

In recent decades, the use of wind turbines, concentrated solar plants and photovoltaic plants have been on the increase as it serves as an abundant source of energy. This document specifies proposed setbacks for wind turbines and the reasons for these setbacks from infrastructure as well as setbacks for concentrated solar plants and photovoltaic plants. Setbacks for wind turbines employed in other countries were compared and a general setback to be used by Eskom was suggested for use with wind turbines and other renewable energy generation plants.

#### CONTROLLED DISCLOSURE

When downloaded from the EDMS, this document is uncontrolled and the responsibility rests with the user to ensure it is in line with the authorised version on the system.

## APPENDICES

### ENVIRONMENTAL IMPACT ASSESSMENT REPORT: Scoping and Environmental Impact Assessment (EIA) Process for the Proposed Development of a Solar Photovoltaic (PV) Facility (Kudu Solar Facility 3) and associated infrastructure, near De Aar, Northern Cape Province

---

**Renewable Energy Generation Plant Setbacks to Eskom Infrastructure**

Unique Identifier: 240-65559775

Revision: 2

Page: 4 of 9

---

## 1. INTRODUCTION

During the last few decades, a large amount of wind turbines have been installed in wind farms to accommodate for the large demand of energy and depleting fossil fuels. Wind is one of the most abundant sources of renewable energy. Wind turbines harness the energy of this renewable resource for integration in electricity networks. The extraction of wind energy is its primary function and thus the aerodynamics of the wind turbine is important. There are many different types of wind turbines which will all exhibit different wind flow characteristics. The most common wind turbine used commercially is the Horizontal Axis Wind Turbine. Wind flow characteristics of this turbine are important to analyse as it may have an effect on surrounding infrastructure.

Wind turbines also cause large turbulence downwind that may affect existing infrastructure. Debris or parts of the turbine blade, in the case of a failure, may be tossed behind the turbine and may lead to damage of infrastructure in the wake path.

This document outlines the minimum distances that need to be introduced between a wind turbine and Eskom infrastructure to ensure that debris and / or turbulence would not negatively impact on the infrastructure and future expansion of infrastructure (lines and substation) as per the long term planning scenario.

Safety distances of wind turbines from other structures as implemented by other countries were also considered and the reasons for their selection were noted. All renewable energy developments are approved by The Department of Environmental Affairs, Forestry and Fisheries (DEFF) in terms of NEMA. The DEFF is aware of the setbacks guideline, however they cannot use it in terms of decision making since the setbacks document has no legal standing in SA and it would be outside of their mandate who have been advised to follow the guidelines herein.

Concentrated solar plants and photovoltaic plants setbacks away from substations were also to be considered to prevent restricting possible power line access routes to the substation and possible expansion of substations.

## 2. SUPPORTING CLAUSES

### 2.1 SCOPE

This document provides guidance on the safe distance that a wind turbine should be located from any Eskom power line or substation. Although it is not based on any legislative requirement, it is deemed important that Eskom's infrastructure and future network expansion planning is not impeded. The document specifies proposed setback distances for transmission lines (220 kV to 765 kV), distribution lines

#### CONTROLLED DISCLOSURE

When downloaded from the EDMS, this document is uncontrolled and the responsibility rests with the user to ensure it is in line with the authorised version on the system.

## APPENDICES

### ENVIRONMENTAL IMPACT ASSESSMENT REPORT: Scoping and Environmental Impact Assessment (EIA) Process for the Proposed Development of a Solar Photovoltaic (PV) Facility (Kudu Solar Facility 3) and associated infrastructure, near De Aar, Northern Cape Province

---

#### Renewable Energy Generation Plant Setbacks to Eskom Infrastructure

Unique Identifier: 240-65559775  
Revision: 2  
Page: 5 of 9

---

(66 kV to 132 kV) and all Eskom substations. Proposed setbacks for concentrated solar plants and photovoltaic plants are also specified away from substations.

#### 2.1.1 Purpose

Setbacks for wind turbines and power lines / substations are required for various reasons. These include possible catastrophic failure of the turbine blade that may release fragments and which may be thrown onto nearby power lines that may result in damage with associated unplanned outages. Turbulence behind the turbine may affect helicopter flight during routine Eskom live line maintenance and inspections that may lead to safety risk of the aircraft / personnel. Concentrated solar plants and photovoltaic plants setback away from substations were required to prevent substations from being boxed in by these renewable generation plants limiting line route access to the substations and possible future substation expansion.

#### 2.1.2 Applicability

This document is applicable to the siting of all new and existing wind turbines, concentrated solar plants and photovoltaic plants near power lines and substations and in line of site between Eskom telecommunication infrastructure, including future Eskom renewable energy development.

### 2.2 NORMATIVE/INFORMATIVE REFERENCES

#### 2.2.1 Normative

1. <http://www.envir.ee/orb.aw/class=file/action=preview/id=1170403/Hiumaa+turbulence+impact+EMD.pdf>
2. <http://www.energy.ca.gov/2005publications/CEC-500-2005-184/CEC-500-2005-184.PDF>
3. <http://www.adamscountywind.com/Revised%20Site/Windmills/Adams%20County%20Ordinance/Adams%20County%20Wind%20Ord.htm>
4. [http://www.dsireusa.org/incentives/incentive.cfm?Incentive\\_Code=PA11R&RE=1&EE=1](http://www.dsireusa.org/incentives/incentive.cfm?Incentive_Code=PA11R&RE=1&EE=1)
5. <http://www.wind-watch.org/documents/european-setbacks-minimum-distance-between-wind-turbines-and-habitations/>
6. <http://www.publications.parliament.uk/pa/ld201011/ldbills/017/11017.1-i.html>
7. [http://www.caw.ca/assets/pdf/Turbine\\_Safety\\_Report.pdf](http://www.caw.ca/assets/pdf/Turbine_Safety_Report.pdf)
8. Rogers J, Slegers N, Costello M. (2011) A method for defining wind turbine setback standards. Wind energy 10.1002/we.468

#### 2.2.2 Informative

None

#### CONTROLLED DISCLOSURE

When downloaded from the EDMS, this document is uncontrolled and the responsibility rests with the user to ensure it is in line with the authorised version on the system.



## APPENDICES

### ENVIRONMENTAL IMPACT ASSESSMENT REPORT: Scoping and Environmental Impact Assessment (EIA) Process for the Proposed Development of a Solar Photovoltaic (PV) Facility (Kudu Solar Facility 3) and associated infrastructure, near De Aar, Northern Cape Province

**Renewable Energy Generation Plant Setbacks to Eskom Infrastructure**

Unique Identifier: 240-65559775

Revision: 2

Page: 6 of 9

#### 2.3 DEFINITIONS

Definition	Description
Setback	The minimum distance between a wind turbine and boundary line/dwelling/road/infrastructure/servitude etc.
Flicker	Effect caused when rotating wind turbine blades periodically cast shadows
Tip Height	The total height of the wind turbine ie. Hub height plus half rotor diameter (see Figure1)

##### 2.3.1 Disclosure Classification

**Controlled disclosure:** controlled disclosure to external parties (either enforced by law, or discretionary).

#### 2.4 ABBREVIATIONS

Abbreviation	Description
None	

#### 2.5 ROLES AND RESPONSIBILITIES

All parties involved in the positioning wind turbines, concentrated solar plants and photovoltaic plants near power lines/substations should endeavour to follow the setbacks outlined in this guideline.

#### 2.6 PROCESS FOR MONITORING

Agreement by Eskom in writing on any encroachment of the setbacks distance should be requested via the Grid Access Unit. Eskom should ensure that every application for renewable energy (RE) developments are informed about the existence of the setbacks document early in the RE planning process to ensure maximum effect. This includes Eskom RE development.

#### 2.7 RELATED/SUPPORTING DOCUMENTS

None

### 3. DOCUMENT CONTENT

#### 3.1 INTERNATIONAL SETBACK COMPARISON

Wind Turbine setbacks employed by various countries were considered. It was found that setbacks were determined for various reasons that include noise, flicker, turbine blade failure and wind effects as well as

#### CONTROLLED DISCLOSURE

When downloaded from the EDMS, this document is uncontrolled and the responsibility rests with the user to ensure it is in line with the authorised version on the system.

## APPENDICES

### ENVIRONMENTAL IMPACT ASSESSMENT REPORT: Scoping and Environmental Impact Assessment (EIA) Process for the Proposed Development of a Solar Photovoltaic (PV) Facility (Kudu Solar Facility 3) and associated infrastructure, near De Aar, Northern Cape Province

---

#### Renewable Energy Generation Plant Setbacks to Eskom Infrastructure

Unique Identifier: 240-65559775  
Revision: 2  
Page: 7 of 9

---

future network expansion planning. The distances (setbacks) varied based on these factors and were influenced by the type of infrastructure

Wind turbine setbacks varied for roads, power lines, dwellings, buildings and property and it was noted that the largest setbacks were employed for reasons of noise and flicker related issues [1-7]. Very few countries specified setbacks for power lines.

The literature survey [1-7], yielded information about studies and experiments were conducted to determine the distance that a broken fragment from a wind turbine might be thrown. Even though of low probability of hitting a power line [ $5.0 \times 10^{-5}$ ], the distances recorded were significant [750m<sup>18</sup>]

Wind turbines may also cause changes in wind patterns with turbulent effects behind the hub. These factors influence the wind turbine setbacks specified in this document.

Setbacks were thus introduced to prevent any damage to Eskom infrastructure and impedence to operation and future network expansion planning.

Renewable energy plant can also limit access into substations for power lines of all voltages. A setback distance should therefore be employed to prevent substations from being boxed in by these generation plants and preventing future network expansion. These setback distances are specified in this document.

#### 3.2 ESKOM RECOMMENDED SETBACKS

Any renewable energy applicant should engage with Eskom to determine if their plant layout or positioning of turbines, CSP or PV infrastructure would encroach on the proposed setbacks provided for in this guideline and to ensure that their planning and Eskom's future expansion planning is taken into account. Eskom must inform all renewable energy developers, including Eskom RE, of the existence of the setbacks guideline early in the development process. Should there be an encroachment, a formal request should be sent to and accepted by Eskom in writing if any of the below mentioned setback distances are infringed upon:

- Eskom requests a setback distance of 3 times the tip height of the wind turbine from the edge of the closest Eskom servitude (including vacant servitudes) for transmission lines (220kV to 765kV) and Substations.
- Eskom requests a setback distance of 1 times the tip height of the wind turbine from the edge of the closest Eskom servitude (including vacant servitudes) for distribution lines (66 kV to 132 kV) and Substations.

#### CONTROLLED DISCLOSURE

When downloaded from the EDMS, this document is uncontrolled and the responsibility rests with the user to ensure it is in line with the authorised version on the system.

## APPENDICES

### ENVIRONMENTAL IMPACT ASSESSMENT REPORT: Scoping and Environmental Impact Assessment (EIA) Process for the Proposed Development of a Solar Photovoltaic (PV) Facility (Kudu Solar Facility 3) and associated infrastructure, near De Aar, Northern Cape Province

#### Renewable Energy Generation Plant Setbacks to Eskom Infrastructure

Unique Identifier: 240-65559775  
Revision: 2  
Page: 8 of 9

- A written request should be sent to Eskom via the Grid Access Unit regarding any proposed wind turbine, concentrated solar plants and photovoltaic activity within a 5 km radius of a substation for Eskom to comment on.
- Where concentrated solar plants, photovoltaic structures, battery storage systems (BESS) and other renewable generation plants fall within a 2 km radius of the closest point of a transmission or distribution substation (66kV to 765kV), a written agreement with Eskom is recommended during the planning phase of such plant or structures to ensure Eskom's future planning is not impeded.
- Applicants should not position any wind turbine in the line of site between and two Eskom Radio Telecommunication masts. It should be proven that Eskom radio telecommunication systems (mainly microwave systems) will not be affected in any way by wind turbines due to the criticality of this infrastructure in terms of network operation. Eskom Telecommunications should be engaged on this matter.
- If the position or size of any turbine changes and subsequently infringes on any of the above stated setbacks, a request for relaxation must be sent through to Eskom as per the point mentioned above.

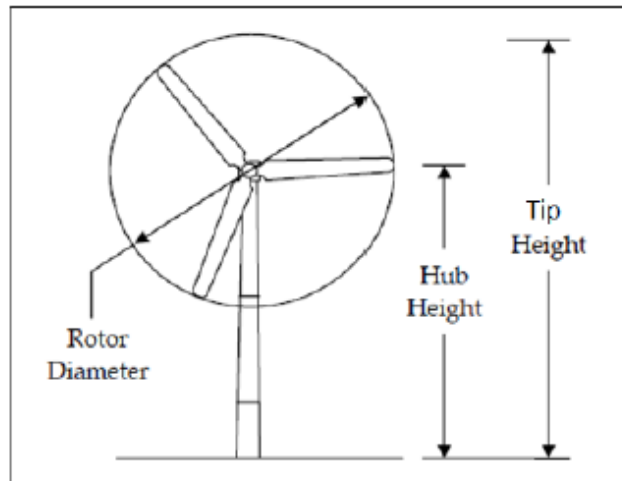

Figure 1: Horizontal Axis Wind Turbine <sup>[2]</sup>

#### CONTROLLED DISCLOSURE

When downloaded from the EDMS, this document is uncontrolled and the responsibility rests with the user to ensure it is in line with the authorised version on the system.

## APPENDICES

### ENVIRONMENTAL IMPACT ASSESSMENT REPORT: Scoping and Environmental Impact Assessment (EIA) Process for the Proposed Development of a Solar Photovoltaic (PV) Facility (Kudu Solar Facility 3) and associated infrastructure, near De Aar, Northern Cape Province

Renewable Energy Generation Plant Setbacks to Eskom Infrastructure

Unique Identifier: 240-65559775

Revision: 2

Page: 9 of 9

#### 4. AUTHORISATION

This document has been seen and accepted by:

Name & Surname	Designation
V Naidoo	Chief Engineer
Dr P Pretorius	Electrical Specialist
J Geeringh	Snr Consultant Environ Mngt
B Haridass	Snr Consultant Engineer
B Ntshunsha	Chief Engineer
R Vajeth	Snr Manager (Lines)
D A Tunncliff	Snr Manager L&R (Acting)
B Branfield	Snr Consultant Engineer

#### 5. REVISIONS

Date	Rev.	Compiler	Remarks
November 2013	0	J W Chetty	First Publication - No renewable energy generation plant setback specification in existence.
October 2018	1	JW Chetty	Modification to sub-section 3.2 to provide more clarity for application procedure.
June 2020	2	JW Chetty	Content within the guideline was re-worded to explain the benefits of mutual agreements between the applicants and ESKOM rather than the application being a legal obligation.

#### 6. DEVELOPMENT TEAM

The following people were involved in the development of this document:

Jonathan Chetty (Mechanical Engineer)

Vivendhra Naidoo (Chief Engineer)

Dr Pieter Pretorius (Electrical Specialist)

John Geeringh (Snr Consultant Environ Mngt)

Bharat Haridass (Snr Consultant Engineer)

Riaz Vajeth (Snr Manager (Lines))

Bruce Ntshunsha (Chief Engineer)

David Tunncliff (Snr Manager L&R Acting)

#### CONTROLLED DISCLOSURE

When downloaded from the EDMS, this document is uncontrolled and the responsibility rests with the user to ensure it is in line with the authorised version on the system.

## APPENDICES

ENVIRONMENTAL IMPACT ASSESSMENT REPORT: Scoping and Environmental Impact Assessment (EIA) Process for the Proposed Development of a Solar Photovoltaic (PV) Facility (Kudu Solar Facility 3) and associated infrastructure, near De Aar, Northern Cape Province

---

### 8. Comments received from the Northern Cape Department of Agriculture, Environmental Affairs, Rural Development and Land Reform (DAEARDLR)

---

**From:** Rohaida Abed  
**Sent:** Wednesday, 05 July 2023 17:47  
**To:** nuys.denc@gmail.com  
**Cc:** Corné Niemandt; Du Toit Malherbe; Petrus Scheepers; EMS  
**Subject:** Kudu Solar Facilities - Query on CBAs vs ESAs in LN3  
**Attachments:** Comments\_Kudu\_DSR\_NU.pdf; Email\_NC\_DAEARDLR\_030223.pdf; Listed Activity\_Discussion\_NC DAEARDLR.pdf

**Importance:** High

Dear Natalie

I trust that you are well.

I am emailing with regards to the proposed Kudu Solar Facilities Scoping and EIA Processes.

The NC Department of Agriculture, Environmental Affairs, Rural Development and Land Reform (DAEARDLR) provided comments on the Draft Scoping Report (attached), and also responded to a query regarding the status of critical biodiversity areas (CBAs) in terms of Listing Notice 3 (attached). The following was confirmed regarding the latter:

- *The Northern Cape CBA map was signed off by the head of the department as an "instrument for informing decisions and priorities on biodiversity". Based on the definition of a systematic biodiversity plan in Listing Notice 3, the CBA map meets both the criteria as important biodiversity areas were identified and targets for both terrestrial and freshwater systems were determined (Holness & Oosthuysen, 2016). Thus, the triggers mentioned for LN3 regarding CBAs and ESAs would still apply.*
- *The Northern Cape does not have any bioregional plans, therefore only listed activities relating to CBAs in terms of systematic biodiversity plans would apply.*

The Kudu Solar Facilities fall within an ESA, and the attached listed activities from Listing Notice 3 were thus included in the Application for EA for the project.

However, the IEA directorate of the National DFFE has submitted the following comment on the Draft EIA Report:

- *It has been noted that activity 4 and 23 of Listing Notice 3 have been applied due the Critical Biodiversity Area been affected by the proposed development. However, figure 4-2 in Chapter 7 indicate that the site falls within an Ecological Support Area. Therefore, you are requested to clarify the applicability of this listed activity considering that listed activity in the EIA Regulation, 2014 as amended only refers to the Critical biodiversity areas as identified in systematic biodiversity plans adopted by the competent authority or in bioregional plans.*

Based on the above comment, could you kindly confirm if the listed activities currently included for the project from Listing Notice 3 (attached) would still apply i.e. as the listed activity only refers to CBAs and not ESAs. For other provinces, like Gauteng, KZN and Free State, the various listed activities in Listing Notice 3 specify CBAs and ESAs but for the Northern Cape, only CBAs are mentioned. Listing Notice 3 does not provide a definition for ESAs and CBAs (only aquatic CBAs are defined), and I cannot determine if the NC CBA Technical Report states if CBAs include ESAs; or if ESAs are separate features.

Please could you kindly provide feedback on the above. We want to ensure that the relevant listed activities are included in the Application from a precautionary perspective, but based on the comment received from the DFFE above

## APPENDICES

### ENVIRONMENTAL IMPACT ASSESSMENT REPORT: Scoping and Environmental Impact Assessment (EIA) Process for the Proposed Development of a Solar Photovoltaic (PV) Facility (Kudu Solar Facility 3) and associated infrastructure, near De Aar, Northern Cape Province

---

(as well as previous comments from DFFE on not following the precautionary approach when identifying listed activities and providing certainty) and the way in which the listed activities in LN3 for the NC are worded, it seems like we might need to remove them from our Application for EA. We would appreciate your feedback in this regard.

We need to submit the Final EIA Reports to the DFFE next week. We would appreciate your feedback on the above by 7 July, if possible?

Thanks and kind regards,  
Rohaida



**From:** Rohaida Abed  
**Sent:** Friday, 07 July 2023 16:42  
**To:** nuys.denc@gmail.com  
**Cc:** Corné Niemandt; Du Toit Malherbe; Petrus Scheepers; EMS  
**Subject:** RE: Kudu Solar Facilities - Query on CBAs vs ESAs in LN3

Dear Natalie

I hope that you are well. Apologies for the pressure, we are kindly following up on the email below as discussed.

Thanks and kind regards,  
Rohaida

**From:** Natalie Uys <nuys.denc@gmail.com>  
**Sent:** Saturday, July 8, 2023 3:22 AM  
**To:** Rohaida Abed <RAbed@csir.co.za>  
**Subject:** Re: Kudu Solar Facilities - Query on CBAs vs ESAs in LN3

Dear Rohida.

Apologies, my meeting took longer than expected. I read through your email and our documents. I understand how you interpreted it as the technical document for our CBA map has no predefined definitions. However, the final map makes distinction between CBA 1, CBA 2, Ecological Support Areas and Other Natural areas. I phoned our conservation planner who developed the map to confirm this with him. As discussed with you over the phone, he indicated that the Ecological Support Areas were not listed under listing notice 3 (as with Gauteng and Western Cape) due to the size of the Northern Cape Province, the size of our corridors and the levels of development.

I hope this clarifies the matter.  
Best regards  
Natalie Uys

## APPENDICES

### ENVIRONMENTAL IMPACT ASSESSMENT REPORT: Scoping and Environmental Impact Assessment (EIA) Process for the Proposed Development of a Solar Photovoltaic (PV) Facility (Kudu Solar Facility 3) and associated infrastructure, near De Aar, Northern Cape Province

---

**From:** Rohaida Abed  
**Sent:** Saturday, 08 July 2023 13:05  
**To:** Natalie Uys  
**Cc:** Corné Niemandt; Du Toit Malherbe; Petrus Scheepers; EMS  
**Subject:** RE: Kudu Solar Facilities - Query on CBAs vs ESAs in LN3

Hi Natalie

Thank you for your feedback and the discussion yesterday, it is appreciated.

Thanks for the explanation below, based on this we will therefore remove the relevant listed activities from Listing Notice 3 for the project, as these refer to Critical Biodiversity Areas and not Ecological Support Areas.

Thanks and kind regards,  
Rohaida

## APPENDICES

ENVIRONMENTAL IMPACT ASSESSMENT REPORT: Scoping and Environmental Impact Assessment (EIA) Process for the Proposed Development of a Solar Photovoltaic (PV) Facility (Kudu Solar Facility 3) and associated infrastructure, near De Aar, Northern Cape Province

---

### 9. Comments received from the Northern Cape Provincial Heritage Resource Authorities

---

**From:** Andrew Timothy <atimothy520@gmail.com>  
**Sent:** Tuesday, 04 July 2023 02:36  
**To:** EMS  
**Subject:** Proposed Development- Kudu Solar Facilities  
**Attachments:** Kudu Solar Project 4.pdf; Kudu Solar Project 3.pdf; Kudu Solar Project 1.pdf; Kudu Solar Project 2.pdf

You don't often get email from atimothy520@gmail.com. [Learn why this is important](#)

Good day

I herewith attach a comment for the above proposed development.

Regards



## APPENDICES

### ENVIRONMENTAL IMPACT ASSESSMENT REPORT: Scoping and Environmental Impact Assessment (EIA) Process for the Proposed Development of a Solar Photovoltaic (PV) Facility (Kudu Solar Facility 3) and associated infrastructure, near De Aar, Northern Cape Province

---



7 Atlas Street,  
Herlear  
KIMBERLEY,  
8330

Moago: 7 Atlas  
Street, Herlear  
KIMBERLEY,  
8330

Atlas Straat 7  
Herlear  
KIMBERLEY,  
8330

Isakhiwo: 7 Atlas  
Street, Herlear &  
Memorial Road  
KIMBERLEY,  
8330

Telephone:  
+27 53 831 3319

Fax:  
+27 53 8313165

E-mail:  
ratha.timothy@gmail.com

Enquiries : Mr. A. Timothy  
Dipatlisiso :  
Imibuzo :  
Navrae :

Date: 03 July 2023  
Letiha:  
Umhla:  
Datum:

---

CSIR Environmental Management Services  
Private Bag X 10  
Musgrave Road  
4062

Tel: 031-242 2300  
Fax: 011- 803 7807  
E-mail: [ems@csir.co.za](mailto:ems@csir.co.za)

#### **COMMENT OF NORTHERN CAPE HERITAGE RESOURCES AUTHORITY ON THE PROPOSED DEVELOPMENT 12 SOLAR PHOTOVOLTAIC (PV) FACILITIES (I.E KUDU SOLAR FACILITIES) AND VARIOUS ASSOCIATED INFRASTRUCTURE, NEAR DE AAR, NORTHERN CAPE**

Thank you for your indication that the above development is to take place in the Northern Cape.

#### **Proposed Development**

The Project Developer, Kudu Solar Facility 1 (Pty) Ltd is proposing to develop a Solar Photovoltaic (PV) power generation facility and associated Electrical Grid Infrastructure (EGI), north-east of the town of De Aar in the Renosterberg Local Municipality and Pixley Ka Seme District Municipality, in the Northern Cape Province. The proposed projects are located approximately 50km from De Aar and 25 km from Petrusville. A total of 12 Solar PV Facilities are being proposed. Each project will have a specific Project Applicant. The proposed projects are referred to as the "Kudu project".

The proposed Solar PV Facilities will make use of PV solar technology to generate electricity from energy derived from the sun. Each solar PV Facility will have a range of associated infrastructure, including, but not limited to, an on-site substation complex, Battery Energy Storage System (BESS), and is proposed to connect to the existing Hydra-Perseus 400 kV overhead power line via dedicated proposed 132 kV power lines, an independent Main Transmission Substation (MTS), and a 400 kV Loop-In-Loop-Out (LILO)

Each of the Solar PV Facilities would be its own project and would require its own, separate EA. The same applies to the EGI projects.

## APPENDICES

### ENVIRONMENTAL IMPACT ASSESSMENT REPORT: Scoping and Environmental Impact Assessment (EIA) Process for the Proposed Development of a Solar Photovoltaic (PV) Facility (Kudu Solar Facility 3) and associated infrastructure, near De Aar, Northern Cape Province

---

The extent of the proposed development falls within the requirements for a Heritage Impact Assessment (HIA) as required by section 38 of the National Heritage Resources Act, no. 25 of 1999.

#### ***Compliance with section 34***

Properties (structures) older than 60 years are generally protected under section 34 of the National Heritage Resources Act. Once identified, each property's heritage significance should be assessed. If the intention is to demolish or alter some of them a heritage permit should be obtained from the Northern Cape Heritage Resources Authority.

#### ***Compliance with section 30***

The Renosterberg Local Municipality Spatial Development Framework does not provide a mechanism for the protection of heritage resources the local authority considers to be conservation worthy in terms of its heritage strategies. Neither does it make provision for the protection of buildings or structures entered on the heritage register maintained by the provincial heritage resources authority. There are no identified, graded and designated heritage resources in the development area.

#### ***Compliance with section 31***

The Gamagara Local Mu Renosterberg Local Municipality does not provide mechanism for the protection of heritage areas/conservation areas. There are no identified, grade and even designated heritage/ conservation areas in the development area.

#### ***Compliance with section 38***

The applicant complied with section 38 of the National Heritage Resources Act. An Heritage Impact Assessment was submitted as part of the Environmental Impact Assessment.

## APPENDICES

### ENVIRONMENTAL IMPACT ASSESSMENT REPORT: Scoping and Environmental Impact Assessment (EIA) Process for the Proposed Development of a Solar Photovoltaic (PV) Facility (Kudu Solar Facility 3) and associated infrastructure, near De Aar, Northern Cape Province

---

#### **Case Decision:**

The applicant should note that all buildings over 60 years of age are generally protected by section 34 of the National Heritage Resources Act no.25 of 1999 to ensure that they have not been accidentally left out of the surveys of heritage resources or in areas where heritage resources surveys have been carried out.

The author states that there are structures older than 60 years identified and protected under the National Heritage Resources Act no.25 of 1999. That being the case, the applicant has to obtain a heritage permit for each and every structure from the Northern Cape Heritage Resources Authority before any attempt to alter or demolish any part of the identified generally protected structures.

As there is indication that the applicant has complied with section 30, 31, 34 and 38 of the National Heritage Resources Act, no.25 of 1999, the Northern Cape Heritage Resources Authority has no objection to the development (in terms of the built environment component of the heritage resources) on condition that, if any new evidence on structures older than 60 years is found during implementation process, the office of Northern Cape Heritage Resources will be alerted immediately.

The applicant has to inform the public (people in the surrounding area) or any other party that has expressed a bona fide interest in any heritage related aspect of this Record of Decision.

The notice of development should be advertised in the local newspapers and with no deviation from the proposed development work.

The issuance of this authority does not stop the applicant from obtaining any other concession from any relevant regulatory body for the work intended.

## APPENDICES

ENVIRONMENTAL IMPACT ASSESSMENT REPORT: Scoping and Environmental Impact Assessment (EIA) Process for the Proposed Development of a Solar Photovoltaic (PV) Facility (Kudu Solar Facility 3) and associated infrastructure, near De Aar, Northern Cape Province

---

Should you have any further queries, please contact the designated official using the case number quoted above in the case header.

Yours faithfully



---

Ratha Timothy  
Manager  
Northern Cape Heritage Resources Authority

## APPENDICES

ENVIRONMENTAL IMPACT ASSESSMENT REPORT: Scoping and Environmental Impact Assessment (EIA) Process for the Proposed Development of a Solar Photovoltaic (PV) Facility (Kudu Solar Facility 3) and associated infrastructure, near De Aar, Northern Cape Province

---

### 10. Comments received from General Stakeholders and I&APS

---

Non-Profit Organisation near De Aar ( [REDACTED] )

**From:** [REDACTED]  
**Sent:** Saturday, June 3, 2023 4:03 PM  
**To:** EMS <ems@csir.co.za>  
**Subject:** Request for a Sponsorship

You don't often get email from [REDACTED]. [Learn why this is important](#)

Good day Sir/Ma

I would like to enquire, we are a registered NPO from DE AAR Northern Cape, we assist needy families and young people using drugs and substance abuse. Also train them for entrepreneurship. Also cook and give food parcels.

Can the company please assist us with funds, we'd be so glad because it will assist a lot of people.

Our contact details are [REDACTED]

Kind Regards  
[REDACTED]

**From:** EMS  
**Sent:** Wednesday, 21 June 2023 14:46  
**To:** [REDACTED]  
**Cc:** EMS  
**Subject:** RE: Request for a Sponsorship

**Categories:** This message has been archived by Retain on June 29 2023 00:49

Dear [REDACTED]

Thank you for your email.

The CSIR Environmental Management Services (EMS) Group is undertaking the EIA process for the proposed Kudu Solar Facilities project.

We have sent your email below to the Project Developer for their consideration.

Wishing you all the best.

Kind Regards,  
Rohaida

CSIR Environmental Management Services  
E-mail: [ems@csir.co.za](mailto:ems@csir.co.za)  
Postal Address: Postnet Suite 367, Private Bag x10, Musgrave Road, 4062  
Tel: 031 242 2300

## APPENDICES

### ENVIRONMENTAL IMPACT ASSESSMENT REPORT: Scoping and Environmental Impact Assessment (EIA) Process for the Proposed Development of a Solar Photovoltaic (PV) Facility (Kudu Solar Facility 3) and associated infrastructure, near De Aar, Northern Cape Province

---

SOLA Group ([REDACTED])

**From:** [REDACTED]  
**Sent:** Monday, 12 June 2023 22:54  
**To:** Kudu Solar PV Projects; EMS  
**Cc:** [REDACTED]  
**Subject:** Re: Availability of Draft EIA Reports for Comment - Kudu Solar PV Facilities near Aar, Northern Cape

Hi CSIR Team,

The notification is hereby acknowledged.

Could you kindly share the KML file of the areas affected by the proposed development?

Your feedback will be highly appreciated.

Best Regards

[REDACTED]  
Project Developer

**Telephone:** [REDACTED]  
**Mobile:** [REDACTED]  
**Email:** [REDACTED]

SOLA



**From:** EMS  
**Sent:** Wednesday, 21 June 2023 14:43  
**To:** [REDACTED]  
**Cc:** [REDACTED]  
**Subject:** RE: Availability of Draft EIA Reports for Comment - Kudu Solar PV Facilities near De Aar, Northern Cape  
**Attachments:** 2021\_11\_03\_Land\_portions.kmz  
**Categories:** This message has been archived by Retain on June 29 2023 00:49

Good day [REDACTED]

Thank you for your email. Please see attached the KMZ file of the study area for the proposed Kudu Solar Facilities.

Thank you and kind regards,  
Rohaida

CSIR Environmental Management Services  
E-mail: [ems@csir.co.za](mailto:ems@csir.co.za)  
Postal Address: Postnet Suite 367, Private Bag x10, Musgrave Road, 4062  
Tel: 031 242 2300

## APPENDICES

ENVIRONMENTAL IMPACT ASSESSMENT REPORT: Scoping and Environmental Impact Assessment (EIA) Process for the Proposed Development of a Solar Photovoltaic (PV) Facility (Kudu Solar Facility 3) and associated infrastructure, near De Aar, Northern Cape Province

---

**From:** [REDACTED]  
**Sent:** Wednesday, 21 June 2023 17:00  
**To:** EMS  
**Cc:** [REDACTED]  
**Subject:** Re: Availability of Draft EIA Reports for Comment - Kudu Solar PV Facilities near De Aar, Northern Cape

**Categories:** This message has been archived by Retain on June 29 2023 00:46

Hi Rohaida,

Thanks for sharing.

Best Regards

[REDACTED]  
Project Developer

**Telephone:** [REDACTED]  
**Mobile:** [REDACTED]  
**Email:** [REDACTED]

SOLA



### BirdLife South Africa

**From:** Sam Ralston <energy@birdlife.org.za>  
**Sent:** Thursday, June 22, 2023 2:54 PM  
**To:** EMS <ems@csir.co.za>  
**Cc:** Info <info@birdlife.org.za>; Advocacy <advocacy@birdlife.org.za>  
**Subject:** Re: Reminder of the Availability of Draft EIA Reports for Comment - Kudu Solar PV

[The e-mail server of the sender failed SPF checks and maybe malicious (SPF Record)]

Dear Helen

Many thanks for following up. BirdLife South Africa does not have the capacity to review and comment on the many EIAs for renewable energy underway. If you have any particular bird-related questions or concerns regarding the project please let us know.

Kind regards

Sam

**Samantha Ralston-Paton**

Birds and Renewable Energy Project Manager

## APPENDICES

### ENVIRONMENTAL IMPACT ASSESSMENT REPORT: Scoping and Environmental Impact Assessment (EIA) Process for the Proposed Development of a Solar Photovoltaic (PV) Facility (Kudu Solar Facility 3) and associated infrastructure, near De Aar, Northern Cape Province

---

**From:** EMS  
**Sent:** Friday, 23 June 2023 10:57  
**To:** Sam Ralston  
**Cc:** Info; Advocacy; EMS  
**Subject:** RE: Reminder of the Availability of Draft EIA Reports for Comment - Kudu Solar PV

**Categories:** This message has been archived by Retain on July 01 2023 06:15

Dear Sam

Thank you for your reply. We do not have any particular bird related questions on our end - the sensitivities identified by the avifauna specialist for avoidance have been avoided by the project layout; and the specialist states that overall, the post-mitigation significance is moderate to low; that no fatal flaws were identified; and that the proposed projects are supported with the understanding that mitigation measures will be implemented. Mitigation measures recommended by the specialist have been included in the EMPs as well.

Kind Regards,  
Rohaida

CSIR Environmental Management Services  
E-mail: [ems@csir.co.za](mailto:ems@csir.co.za)  
Postal Address: Postnet Suite 367, Private Bag x10, Musgrave Road, 4062  
Tel: 031 242 2300

#### Africoast Investments ( [REDACTED] )

**From:** [REDACTED]  
**Sent:** Friday, June 23, 2023 12:48 PM  
**To:** EMS <[ems@csir.co.za](mailto:ems@csir.co.za)>  
**Subject:** Date and Location of Public Participation for ABO KUDU Solar PV Projects

You don't often get email from [REDACTED] [Learn why this is important](#)

To whom it may concern:

I trust all is well.

I am reaching out to request the date and location of the Public Participation for the ABO KUDU Solar PV projects?  
Would you also kindly provide the MS Teams Link to the aforementioned.

Thanks in advance, your assistance is greatly appreciated.

Kind regards,

[REDACTED]  
Project Manager  
Africoast investments (Pty) Ltd





## APPENDICES

### ENVIRONMENTAL IMPACT ASSESSMENT REPORT: Scoping and Environmental Impact Assessment (EIA) Process for the Proposed Development of a Solar Photovoltaic (PV) Facility (Kudu Solar Facility 3) and associated infrastructure, near De Aar, Northern Cape Province

---

**From:** EMS <ems@csir.co.za>  
**Sent:** Friday, 23 June 2023 14:26  
**To:** [REDACTED]  
**Cc:** EMS; Paul Lochner  
**Subject:** RE: Date and Location of Public Participation for ABO KUDU Solar PV Projects  
**Categories:** This message has been archived by Retain on July 01 2023 06:15

Dear [REDACTED]

Thank you for your email. Kindly note that a public meeting has not been included in the Plan of Study for EIA, and is not planned for the Kudu Solar PV Project.

If you need additional information on the project or if you would like to have a discussion, we can give you a call. Alternatively, please kindly send through your comments via email by 3 July 2023.

Kind Regards,  
Rohaida

CSIR Environmental Management Services  
E-mail: ems@csir.co.za  
Postal Address: Postnet Suite 367, Private Bag x10, Musgrave Road, 4062  
Tel: 031 242 2300  
Cell: [REDACTED]

Adjacent, Nearby, or Surrounding Landowner ([REDACTED])

**From:** [REDACTED]  
**Sent:** Monday, 26 June 2023 13:00  
**To:** EMS; [REDACTED]  
**Subject:** Kudu Solar  
**Attachments:** Kudu proposal.pdf

You don't often get email from [REDACTED] [Learn why this is important](#)

Attached my comments as an registered interested and affected party to the proposed Kudu development.

Regards  
[REDACTED]

## APPENDICES

### ENVIRONMENTAL IMPACT ASSESSMENT REPORT: Scoping and Environmental Impact Assessment (EIA) Process for the Proposed Development of a Solar Photovoltaic (PV) Facility (Kudu Solar Facility 3) and associated infrastructure, near De Aar, Northern Cape Province

---



26 June 2023

#### INPUT AND OBJECTION TOWARDS THE KUDU DEVELOPEMET

I registered as an interested and affected party to the proposed Kudu development in the Philipstown ditrict.

Paragraphs 1 to 3 was mentioned in my previous objection.

1. We understand according to documents at our disposal that your development is a massive one proposed on only two farms. As a neighbour who has been farming for my entire life in the Karoo, I want to know what the water use of this project will be. Further , I also request information on measures that you have put in place to test the availability of water resources.
2. According to the layouts of the solar farms, it appears the majority of certain farms will be covered almost entirely under panels . What is your company's viewpoint and understanding of the subdivision of agricultural land act (Act 70 of 1970) ? How would the act impact on your proposed developments ?
3. What benefits would your development have for the farming community of Philipstown district ?
4. **I want to emphasize paragraph 3 as you emphasize the positive socio-economic benefits for the farming community in your environmental reports. Your proposed model will in fact have the exact opposite effect. The alternative model where approximately 20 farms get the benefit from solar development will definitely benefit 20 farmers and their farmworkers , while a model that enrich only 2 farmers will have no positive socio-economic effects on the greater farming community and will not enhance agricultural sustainability.**

Regards



## APPENDICES

ENVIRONMENTAL IMPACT ASSESSMENT REPORT: Scoping and Environmental Impact Assessment (EIA) Process for the Proposed Development of a Solar Photovoltaic (PV) Facility (Kudu Solar Facility 3) and associated infrastructure, near De Aar, Northern Cape Province

---

### Adjacent, Nearby, or Surrounding Landowner ( [REDACTED] )

**From:** [REDACTED]  
**Sent:** Tuesday, 27 June 2023 18:15  
**To:** EMS  
**Cc:** EMS; [REDACTED]  
**Subject:** RE: Reminder of the Availability of Draft EIA Reports for Comment - Kudu Solar PV  
**Attachments:** Kudu SM2a.pdf  
**Categories:** This message has been archived by Retain on July 05 2023 04:40

You don't often get email from [REDACTED]. [Learn why this is important](#)

## APPENDICES

### ENVIRONMENTAL IMPACT ASSESSMENT REPORT: Scoping and Environmental Impact Assessment (EIA) Process for the Proposed Development of a Solar Photovoltaic (PV) Facility (Kudu Solar Facility 3) and associated infrastructure, near De Aar, Northern Cape Province

---



27 June 2023

#### INPUT AND OBJECTION TOWARDS THE KUDU DEVELOPEMET

I registered as an interested and affected party to the proposed Kudu development in the Philipstown ditrict.

Paragraphs 1 to 3 was mentioned in my previous objection.

1. We understand according to documents at our disposal that your development is a massive one proposed on only two farms. As a neighbour who has been farming for my entire life in the Karoo, I want to know what the water use of this project will be. Further , I also request information on measures that you have put in place to test the availability of water resources.
2. According to the layouts of the solar farms, it appears the majority of certain farms will be covered almost entirely under panels . What is your company's viewpoint and understanding of the subdivision of agricultural land act (Act 70 of 1970) ? How would the act impact on your proposed developments ?
3. What benefits would your development have for the farming community of Philipstown district ?
4. **I want to emphasize paragraph 2:**  
In many meetings between government and agriculture, the importance of food security is emphasized. Agricultural unions such as Agri SA, to which most farmers in our area belong, will therefore support the legislation that no more than 10% of agricultural land per farm must be used for other purposes. I feel that this point should be respected by all developers.

Regards



## APPENDICES

ENVIRONMENTAL IMPACT ASSESSMENT REPORT: Scoping and Environmental Impact Assessment (EIA) Process for the Proposed Development of a Solar Photovoltaic (PV) Facility (Kudu Solar Facility 3) and associated infrastructure, near De Aar, Northern Cape Province

---

**From:** [REDACTED]  
**Sent:** Tuesday, 27 June 2023 18:16  
**To:** EMS  
**Cc:** EMS; [REDACTED]  
**Subject:** RE: Reminder of the Availability of Draft EIA Reports for Comment - Kudu Solar PV  
**Attachments:** Kudu SM2a.pdf  
**Categories:** This message has been archived by Retain on July 05 2023 04:40

You don't often get email from [REDACTED]. [Learn why this is important](#)

## APPENDICES

### ENVIRONMENTAL IMPACT ASSESSMENT REPORT: Scoping and Environmental Impact Assessment (EIA) Process for the Proposed Development of a Solar Photovoltaic (PV) Facility (Kudu Solar Facility 3) and associated infrastructure, near De Aar, Northern Cape Province

---



27 June 2023

#### INPUT AND OBJECTION TOWARDS THE KUDU DEVELOPEMET

I registered as an interested and affected party to the proposed Kudu development in the Philipstown ditrict.

Paragraphs 1 to 3 was mentioned in my previous objection.

1. We understand according to documents at our disposal that your development is a massive one proposed on only two farms. As a neighbour who has been farming for my entire life in the Karoo, I want to know what the water use of this project will be. Further , I also request information on measures that you have put in place to test the availability of water resources.
2. According to the layouts of the solar farms, it appears the majority of certain farms will be covered almost entirely under panels . What is your company's viewpoint and understanding of the subdivision of agricultural land act (Act 70 of 1970) ? How would the act impact on your proposed developments ?
3. What benefits would your development have for the farming community of Philipstown district ?
4. **I want to emphasize paragraph 2:**  
In many meetings between government and agriculture, the importance of food security is emphasized. Agricultural unions such as Agri SA, to which most farmers in our area belong, will therefore support the legislation that no more than 10% of agricultural land per farm must be used for other purposes. I feel that this point should be respected by all developers.

Regards



## APPENDICES

ENVIRONMENTAL IMPACT ASSESSMENT REPORT: Scoping and Environmental Impact Assessment (EIA) Process for the Proposed Development of a Solar Photovoltaic (PV) Facility (Kudu Solar Facility 3) and associated infrastructure, near De Aar, Northern Cape Province

---

**Adjacent, Nearby, or Surrounding Landowner ( [REDACTED] )**

**From:** [REDACTED]  
**Sent:** Tuesday, 27 June 2023 20:20  
**To:** EMS  
**Subject:** Kudu development  
**Attachments:** img20230627\_20164837.pdf

**Categories:** This message has been archived by Retain on July 05 2023 04:40

Good day

Attached the requested inputs on Kudu development.

Regards  
[REDACTED]

## APPENDICES

ENVIRONMENTAL IMPACT ASSESSMENT REPORT: Scoping and Environmental Impact Assessment (EIA) Process for the Proposed Development of a Solar Photovoltaic (PV) Facility (Kudu Solar Facility 3) and associated infrastructure, near De Aar, Northern Cape Province

---

27 June 2023

Good day;

### INPUT AND OBJECTION TOWARDS THE KUDU DEVELOPMENT

I registered as an interested and affected party to the proposed Kudu development in the Philipstown district.

1. We understand according to documents at our disposal that your development is a massive one proposed on only two farms. As a neighbour who has been farming for my entire life in the Karoo, I want to know what the water use of this project will be. Further, I also request information on measures that you have put in place to test the availability of water resources.

2. According to the layouts of the solar farms, it appears the majority of certain farms will be covered almost entirely under panels. What is your company's viewpoint and understanding of the subdivision of agricultural land act (Act 70 of 1970)? How would the act impact on your proposed developments?

YOUR LOGO  
HERE



**APPENDICES**

**ENVIRONMENTAL IMPACT ASSESSMENT REPORT: Scoping and Environmental Impact Assessment (EIA) Process for the Proposed Development of a Solar Photovoltaic (PV) Facility (Kudu Solar Facility 3) and associated infrastructure, near De Aar, Northern Cape Province**

---



3. What benefits would your proposed development have for the broader farming community of Philipstown district?

4. You emphasize in paragraph 3 the positive socio-economic benefits for the farming community in your environmental reports. Your model will have the opposite effect and deny 20 farms the benefit of solar development while enriching only two farmers. This hold no positive socio-economic benefits for the greater farming community and will not positively enhance agricultural sustainability.

Kind regards,

  
LANDOWNER/DIRECTOR-   

YOUR LOGO  
HERE

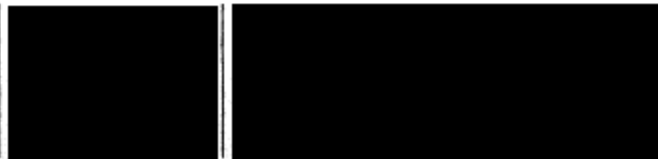

## APPENDICES

ENVIRONMENTAL IMPACT ASSESSMENT REPORT: Scoping and Environmental Impact Assessment (EIA) Process for the Proposed Development of a Solar Photovoltaic (PV) Facility (Kudu Solar Facility 3) and associated infrastructure, near De Aar, Northern Cape Province

---

### Adjacent, Nearby, or Surrounding Landowner ( [REDACTED] )

**From:** [REDACTED]  
**Sent:** Thursday, June 29, 2023 2:25 PM  
**To:** EMS <ems@csir.co.za>  
**Subject:** Kudu Solar Ontwikkeling

You don't often get email from [REDACTED]. [Learn why this is important](#)

Middag

Julle het vir my n e pos gestuur oor die Kudu Solar Ontwikkeling naby De Aar. Ek verstaan dat julle wil krag opwek deur middel van sonpanele en windlaaiers. Ek is in die Philipstown omgewing. As julle by my wil sonpanele op sit kontak my Op my landlyn by [REDACTED] My plaas se naam word nie genoem nie, maar Die plaas Basberg word genoem. So ek neem aan dit is om my in kennis te stel van julle ontwikkeling.

Groete  
[REDACTED]

**From:** EMS  
**Sent:** Thursday, 29 June 2023 15:23  
**To:** EMS  
**Cc:** [REDACTED]  
**Subject:** RE: Kudu Solar Ontwikkeling

**Categories:** This message has been archived by Retain on July 07 2023 05:16

Goeie middag [REDACTED]

Baie dankie vir u e-pos.

Dit is korrek dat u plaasgedeelte nie direk betrokke by die voorgestelde ontwikkeling van die Kudu Sonkragfasiliteite is nie (sien asseblief die onderstaande tabel vir 'n lys van die geaffekteerde plaasgedeeltes). Die WNNR wil graag grondeienaars in die naby geleë omgewing in kennis stel van die ontwikkeling, asook 'n geleentheid bied om kommentaar te lewer op die projekte.

Farm Portion	SG code
Remaining Extent of the Farm Bas Berg No. 88	C0570000000008800000
Remaining Extent of Portion 3 of the Farm Bas Berg No. 88	C0570000000008800003
Portion 4 (Portion of Portion 3) of the Farm Bas Berg No. 88	C0570000000008800004
Remaining Extent of Portion 2 (Middel Plaats) (a Portion of Portion 1) of the Farm Grasspan No. 40	C0570000000004000002
Remaining Extent of the Farm Annex Wolve Kuil No. 41	C0570000000004100000
Portion 1 (Wolve Kuil West) of the Farm Annex Wolve Kuil No. 41	C0570000000004100001
Portion 2 of the Farm Wolve Kuil No. 43	C0570000000004300002
Remaining Extent of the Farm Wolve Kullen No. 42	C0570000000004200000

Ons sal u 'n nota maak vir die projek-ontwikkelaars om u te kontak indien hul toekomstige projekte in die gebied beplan.

Vriendelike groete  
Helen Antonopoulos

## APPENDICES

ENVIRONMENTAL IMPACT ASSESSMENT REPORT: Scoping and Environmental Impact Assessment (EIA) Process for the Proposed Development of a Solar Photovoltaic (PV) Facility (Kudu Solar Facility 3) and associated infrastructure, near De Aar, Northern Cape Province

---

Adjacent, Nearby, or Surrounding Landowner ( [REDACTED] )

From: [REDACTED]

Sent: Thursday, June 29, 2023 5:53 PM

To: Helen Antonopoulos [REDACTED]

Subject: Re: Herinnering van die Beskikbaarheid van die Konsep Omgewingsimpakverslae vir Kommentaar - Kudu Sonkragfasiliteite

You don't often get email from [REDACTED] [Learn why this is important](#)

Beste Helen,

Dankie vir nota betreffende die sluit van die kommentaar periode.

Ek sluit graag my kommentaar as aangeheg in. Indien dit slegs in Engels verkies word, sal ek dit in so 'n formaat kan verskaf.

Ek het al my kommer oor die omgewings inpak van genoemde ontwikkeling tydens 'n vorige deelname proses, aan die einde van Januarie uitgespreek sonder enige terugvoering tot nou ontvang. Ek kan ook nie sien waar in die "draft EIA report" my bekommernisse en vrae hanteer word nie.

Ek hoor graag van u.

Beste wense  
[REDACTED]

## APPENDICES

ENVIRONMENTAL IMPACT ASSESSMENT REPORT: Scoping and Environmental Impact Assessment (EIA) Process for the Proposed Development of a Solar Photovoltaic (PV) Facility (Kudu Solar Facility 3) and associated infrastructure, near De Aar, Northern Cape Province

### Kommetaar rakende die beoogde 12 Kudu Sonkragprojekte: Phillipstown distrik.

29 Junie 2023

#### Aan wie dit mag gaan:

My naam is [REDACTED]. Ek is die eienaar van die plaas [REDACTED] in die Phillipstown distrik. [REDACTED] is aangrensend vir [REDACTED] meter tot die beoogde Kuduprojek en [REDACTED] van hierdie projek. Aangesien ek as 'n belanghebbene formeel by die projek geregistreer is, teken ek weereens die volgende besware aan:

**Eerstens**, die Kudu Sonkragprojek het 'n uiters gebrekkige openbare deelname inisiatief van stapel gestuur. Fokusgroepe soos naasliggende bure tot die projek, asook ander betrokke grondeienaars, is nie gekontak nie. Verder is vorige insette en besware nie hanteer nie.

Die voorlopige EIA verslag spreek nie die verdraaide en negatiewe realiteite van die Kuduprojek tot die maatskaplike en sosio-ekonomiese impak en uitdagings van die Bo- Karoo en sy inwoners aan nie.

- Die verspreiding van die moontlikhede tot die skep van welvaart is uiters beperk, met die Kuduprojek van 12 eenhede wat slegs twee grondeienaars uitermatig bevoordeel. 'n Alternatief sou wees om 'n groter aantal grondeienaars te betrek en sodoende die breek gemeenskap te bevoordeel en die geleentheid tot welvaart baie beter te versprei.
- Die Karoo is 'n semi ariede gebied wat gebuk gaan onder periodieke droogtes. Die welvaart van die gebied is hoofsaaklik afhanklik van die voor of teenspoed wat die landbou en veral die grondeenaar of boer ervaar. Die landbougemeenskap van die distrik is die primere ekonomiese basis van die dorpe Phillipstown, Petrusville en Vanderkloof, waar werkloosheid en armoede aan die orde van die dag is. Tydens droogtes word werkers afgele as gevolg van dalende ekonomiese aktiwiteite en verminderde

## APPENDICES

### ENVIRONMENTAL IMPACT ASSESSMENT REPORT: Scoping and Environmental Impact Assessment (EIA) Process for the Proposed Development of a Solar Photovoltaic (PV) Facility (Kudu Solar Facility 3) and associated infrastructure, near De Aar, Northern Cape Province

boerderyinkomste. Die plaaslike besighede se omset en wins daal drasties gedurende droogtes, omdat daar minder geld beskikbaar en in omloop is.

- 'n Beter en meer eweredige verspreiding van "die geleentheid" sal dus meebring dat droogtes en natuurrampe meer volhoubaar hanteer kan word. Die rimpel effek van 'n meer eweredige verspreiding van die "geleentheid", sal gevolglik die lewensgehalte en kwaliteit van 'n groter aantal bewoners van die distrik en streek positief beïnvloed.

**Tweedens**, die voorlopige EIA spreek **NIE** die hoe risko aan van die oorbenutting van onderaardse waterbronne in die streek aan nie. Grondwater is 'n skaars en kosbare hulpbron in die Karoo. Die EIA is vaag oor die impak van 'n gekonsentreerde massa water onttrekking gedurende die konstruksie fase van die Kudu projek, asook die hoeveelheid benodig vir die onderhoud tydens die 20 jaar opwekkingsperiode.

- Die Kudu ontwikkeling beslaan etlike duisend hektaar, gekonsentreerd in 'n massiewe blok.
- As dieselfde ontwikkeling oor 'n groter geografiese gebied versprei kan word, sal dit die impak van massa onttrekking, van die onderaardse water, beter versprei en die kans op volhoubare onttrekking verhoog.
- Die navorsing wat gedoen is oor die beskikbare hoeveelheid onderaardse water in die gebied van die projek, asook van die naasliggende gebiede en die aanvulling van grondwater, is gebrekkig. Verder, is dit nie gedeel of bespreek met die naasliggende grondeienaars nie. Die rigting van die beweging van onderaardse water, asook die aanvulling daarvan is nie goed nagevors en in die verslag opgeneem nie.
- Die volgende vrae bly onbeantwoord:
  1. Hoeveel grondwater sal in die gekonsentreerde blok van Kudu onttrek moet word om die ontwikkeling deur te voer?
  2. Hoe lank sal die gekonsentreerde onttrekking van onderaardse water in die opwekkings termyn deur te voer, volhoubaar wees?

## APPENDICES

### ENVIRONMENTAL IMPACT ASSESSMENT REPORT: Scoping and Environmental Impact Assessment (EIA) Process for the Proposed Development of a Solar Photovoltaic (PV) Facility (Kudu Solar Facility 3) and associated infrastructure, near De Aar, Northern Cape Province

3. Wat sal die effek wees op my as naasliggende buurman se boorgate, wat krities belangrik is vir die volhoubare kleinvee- en wild boerdery op my plaas?
4. Hoe sal chemiese besoedeling van my weiveld voorkom word, aangesien die projek direk stroomop is van 'n reuse waterbaan is wat deur my plaas strek?

**Ek teken dus beswaar aan ten opsigte van die deeglikheid en deursigtigheid van die konsep EIA vir die Kudu Sonkragprojek van 12 eenhede en die ontwikkeling van die beoogde projek.**

Ek versoek dat my besware en insette met die nodige respek, deursigtigheid en erns hanteer sal word.

Met dank

[Redacted signature]

[Redacted name]

29 Junie 2023.

## APPENDICES

ENVIRONMENTAL IMPACT ASSESSMENT REPORT: Scoping and Environmental Impact Assessment (EIA) Process for the Proposed Development of a Solar Photovoltaic (PV) Facility (Kudu Solar Facility 3) and associated infrastructure, near De Aar, Northern Cape Province

---

**From:** Helen Antonopoulos <[REDACTED]>  
**Sent:** Friday, 30 June 2023 09:27  
**To:** [REDACTED]  
**Cc:** EMS <[ems@csir.co.za](mailto:ems@csir.co.za)>  
**Subject:** RE: Herinnering van die Beskikbaarheid van die Konsep Omgewingsimpakverslae vir Kommentaar - Kudu Sonkragfasiliteite

Beste [REDACTED]

Baie dankie vir u e-pos en deelname in die publieke deelname proses dus ver.

U kommentaar in Afrikaans is nie 'n probleem nie, ek vertaal met graagte u kommentaar - tensy u sou verkies om self te vertaal.

Die projekspan het alle kommentaar ontvang gedurende die kommentaar periode van 9 Desember 2022 tot 30 Januarie 2023 aangespreek in die "Comments and Responses Report". 'n Kopie van elke kommentaar was ingesluit in Bylaag E.10 en E.11 in die Finale Bestekopname Verslae, en was ook ingesluit in Bylaag F Gedeeltes 2 en 3 van die Konsep Omgewingsimpakverslae ("Draft EIA Report") (sien asseblief dokumente [28 App F Kudu Solar 1 DEIAR PPP Scoping CRR Part 2 Final June2023](#) en [29 App F Kudu Solar 1 DEIAR PPP Scoping CRR Part 3 Final June2023](#) op Google Drive: [https://bit.ly/KUDU SOLAR PV](https://bit.ly/KUDU_SOLAR_PV)).

U kommentaar, tesame met die WNNR se terugvoer, tydens die huidige publieke deelname periode sal ingesluit word in die "Comments and Responses Report" van Finale Omgewingsimpakverslae. Die projekspan sal die webskakels met alle Geïnteresseerde en/of Belanghebbende Partye (G&BPs) gedeel word.

U is meer as welkom om my te kontak indien u addisionele vrae het.

Baie dankie  
Helen Antonopoulos

---

**From:** [REDACTED]  
**Sent:** Friday, June 30, 2023 6:56 PM  
**To:** Helen Antonopoulos <[REDACTED]>  
**Subject:** Re: Herinnering van die Beskikbaarheid van die Konsep Omgewingsimpakverslae vir Kommentaar - Kudu Sonkragfasiliteite

You don't often get email from [REDACTED] [Learn why this is important](#)

Middag Helen,

Ek sal dit op prys stel as jy my kommentaar kan vertaal. Baie dankie.  
groete

[REDACTED]

## APPENDICES

ENVIRONMENTAL IMPACT ASSESSMENT REPORT: Scoping and Environmental Impact Assessment (EIA) Process for the Proposed Development of a Solar Photovoltaic (PV) Facility (Kudu Solar Facility 3) and associated infrastructure, near De Aar, Northern Cape Province

---

On Mon, Jul 3, 2023 at 11:30 GMT+02:00, "Helen Antonopoulos" <[REDACTED]> wrote:

Goeie môre [REDACTED]

Sien asseblief die aangehede vertaalde weergawe van u kommentaar. Ek sal dit opreg waardeer as u asseblief daarna kan kyk en na my toe kan terugkeer met enige voorstelle, verbeteringe, of kommentaar voor dat ek u insette insluit in ons Kommentaar en Antwoorde Verslae.

Baie dankie  
Helen Antonopoulos

---

**From:** [REDACTED]  
**Sent:** Monday, 03 July 2023 12:41  
**To:** Helen Antonopoulos  
**Subject:** Re: RE: Herinnering van die Besikbaarheid van die Konsep Omgewingsimpakverslae vir Kommentaar - Kudu Sonkragfasiliteite

Baie dankie Helen, vir jou profesionele aanslag en goeie vertaling. Jy kan die kommentaar asb indien.  
Groete  
[REDACTED]



## APPENDICES

ENVIRONMENTAL IMPACT ASSESSMENT REPORT: Scoping and Environmental Impact Assessment (EIA) Process for the Proposed Development of a Solar Photovoltaic (PV) Facility (Kudu Solar Facility 3) and associated infrastructure, near De Aar, Northern Cape Province

---

**From:** [REDACTED]  
**Sent:** Thursday, 29 June 2023 18:04  
**To:** EMS  
**Subject:** Kommentaar oor die voorlogige EIA verslag t.o.v die voorgestelde Kudu Sonkrag ontwikkeling. Philipstown distrik. De Aar omgewing.  
**Attachments:** Scan\_20230629 (7).png; Scan\_20230629 (8).png; Scan\_20230629 (9).png  
**Categories:** This message has been archived by Retain on July 07 2023 05:16

You don't often get email from [REDACTED] [Learn why this is important](#)

Dear CSIR officer,

Please find my comment on the draft EIA report: Kudu Solar development of 12 facilities, De Aar region, as an attachment herewith.

Regards  
[REDACTED]

## APPENDICES

ENVIRONMENTAL IMPACT ASSESSMENT REPORT: Scoping and Environmental Impact Assessment (EIA) Process for the Proposed Development of a Solar Photovoltaic (PV) Facility (Kudu Solar Facility 3) and associated infrastructure, near De Aar, Northern Cape Province

### Kommetaar rakende die beoogde 12 Kudu

#### Sonkragprojekte: Philipstown distrik.

29 Junie 2023

#### Aan wie dit mag gaan:

My naam is [REDACTED]. Ek is die eienaar van die plaas [REDACTED] in die Philipstown distrik. [REDACTED] is aangrensend vir [REDACTED] meter tot die beoogde Kuduprojek en [REDACTED] van hierdie projek. Aangesien ek as 'n belanghebbene formeel by die projek geregistreer is, teken ek weereens die volgende besware aan:

**Eerstens**, die Kudu Sonkragprojek het 'n uiters gebrekkige openbare deelname inisiatief van stapel gestuur. Fokusgroepe soos naasliggende bure tot die projek, asook ander betrokke grondeienaars, is nie gekontak nie. Verder is vorige insette en besware nie hanteer nie.

Die voorlopige EIA verslag spreek nie die verdraaide en negatiewe realiteite van die Kuduprojek tot die maatskaplike en sosio-ekonomiese impak en uitdagings van die Bo- Karoo en sy inwoners aan nie.

- Die verspreiding van die moontlikhede tot die skep van welvaart is uiters beperk, met die Kuduprojek van 12 eenhede wat slegs twee grondeienaars uitermatig bevoordeel. 'n Alternatief sou wees om 'n groter aantal grondeienaars te betrek en sodoende die breet gemeenskap te bevoordeel en die geleentheid tot welvaart baie beter te versprei.
- Die Karoo is 'n semi ariede gebied wat gebuk gaan onder periodieke droogtes. Die welvaart van die gebied is hoofsaaklik afhanklik van die voor of teenspoed wat die landbou en veral die grondeienaar of boer ervaar. Die landbougemeenskap van die distrik is die primere ekonomiese basis van die dorpe Philipstown, Petrusville en Vanderkloof, waar werkloosheid en armoede aan die orde van die dag is. Tydens droogtes word werkers afgele as gevolg van dalende ekonomiese aktiwiteite en verminderde

## APPENDICES

### ENVIRONMENTAL IMPACT ASSESSMENT REPORT: Scoping and Environmental Impact Assessment (EIA) Process for the Proposed Development of a Solar Photovoltaic (PV) Facility (Kudu Solar Facility 3) and associated infrastructure, near De Aar, Northern Cape Province

boerderyinkomste. Die plaaslike besighede se omset en wins daal drasties gedurende droogtes, omdat daar minder geld beskikbaar en in omloop is.

- 'n Beter en meer eweredige verspreiding van "die geleentheid" sal dus meebring dat droogtes en natuurrampe meer volhoubaar hanteer kan word. Die rimpel effek van 'n meer eweredige verspreiding van die "geleentheid", sal gevolglik die lewensgehalte en kwaliteit van 'n groter aantal bewoners van die distrik en streek positief beïnvloed.

**Tweedens**, die voorlopige EIA spreek **NIE** die hoe risiko aan van die oorbenuiting van onderaardse waterbronne in die streek aan nie. Grondwater is 'n skaars en kosbare hulpbron in die Karoo. Die EIA is vaag oor die impak van 'n gekonsentreerde massa water onttrekking gedurende die konstruksie fase van die Kudu projek, asook die hoeveelheid benodig vir die onderhoud tydens die 20 jaar opwekkingsperiode.

- Die Kudu ontwikkeling beslaan etlike duisend hektaar, gekonsentreerd in 'n massiewe blok.
- As dieselfde ontwikkeling oor 'n groter geografiese gebied versprei kan word, sal dit die impak van massa onttrekking, van die onderaardse water, beter versprei en die kans op volhoubare onttrekking verhoog.
- Die navorsing wat gedoen is oor die beskikbare hoeveelheid onderaardse water in die gebied van die projek, asook van die naasliggende gebiede en die aanvulling van grondwater, is gebrekkig. Verder, is dit nie gedeel of bespreek met die naasliggende grondeienaars nie. Die rigting van die beweging van onderaardse water, asook die aanvulling daarvan is nie goed nagevors en in die verslag opgeneem nie.
- Die volgende vrae bly onbeantwoord:
  1. Hoeveel grondwater sal in die gekonsentreerde blok van Kudu onttrek moet word om die ontwikkeling deur te voer?
  2. Hoe lank sal die gekonsentreerde onttrekking van onderaardse water om die opwekkings termyn deur te voer, volhoubaar wees?

## APPENDICES

ENVIRONMENTAL IMPACT ASSESSMENT REPORT: Scoping and Environmental Impact Assessment (EIA) Process for the Proposed Development of a Solar Photovoltaic (PV) Facility (Kudu Solar Facility 3) and associated infrastructure, near De Aar, Northern Cape Province

---

3. Wat sal die effek wees op my as naasliggende buurman se boorgate, wat krities belangrik is vir die volhoubare kleinvee- en wild boerdery op my plaas?
4. Hoe sal chemiese besoedeling van my weiveld voorkom word, aangesien die projek direk stroomop is van 'n reuse waterbaan is wat deur my plaas strek?

**Ek teken dus beswaar aan ten opsigte van die deeglikheid en deursigtigheid van die konsep EIA vir die Kudu Sonkragprojek van 12 eenhede en die ontwikkeling van die beoogde projek.**

Ek versoek dat my besware en insette met die nodige respek, deursigtigheid en erns hanteer sal word.

Met Dank

29 Junie 2023.

## APPENDICES

ENVIRONMENTAL IMPACT ASSESSMENT REPORT: Scoping and Environmental Impact Assessment (EIA) Process for the Proposed Development of a Solar Photovoltaic (PV) Facility (Kudu Solar Facility 3) and associated infrastructure, near De Aar, Northern Cape Province

---

**Adjacent, Nearby, or Surrounding Landowner ( [REDACTED] )**

**From:** [REDACTED]

**Sent:** Monday, July 3, 2023 9:51 PM

**To:** EMS <ems@csir.co.za>

**Subject:** Kudu Sonkragfasiliteite

Vir aandag: Helen Antonopoulos

Goeienaand

Vind aangeheg die volgende dokumente insake die Kudu sonkragfasiliteite

Groete [REDACTED]

Selnommer [REDACTED]

## APPENDICES

ENVIRONMENTAL IMPACT ASSESSMENT REPORT: Scoping and Environmental Impact Assessment (EIA) Process for the Proposed Development of a Solar Photovoltaic (PV) Facility (Kudu Solar Facility 3) and associated infrastructure, near De Aar, Northern Cape Province

---



Helen Antonopoulos

WNNR

Per epos aan: [ems@csir.co.za](mailto:ems@csir.co.za)

Beste Helen,

INSAKE: KUDU SONKRAGFASILITEITE

Verder tot u Whatsup gerig aan my rakende bovermelde ontwikkeling, maak ek weer kontak. Ek [REDACTED] is die eienaar van eiendomme (plase) wat naby of aangrensend is van die beoogde ontwikkeling in die Phillipstowndistrik. Verder huur ek ook al meer as twintig jaar die plaas Basberg, waar van die ontwikkeling beplan word. Ek het ook ook vroeër kommentaar gelewer soos versoek rakende die projekte, maar dit blyk dat my insette nie oorweeg is in die voorlopige verslag nie.

Die volgende kommentaar word weer en aanvullend tot my vorige insette gelewer.

Ons familie boer reeds geslagte in die distrik, insluitend die plaas Bokkraal. Ek is ook reeds van kindsbeen af betrokke by die boerdery en het, nadat ek afstudeer het aan die Universiteit van die Vrystaat, voltyds begin boer. Die afgelope ongeveer veertig jaar het ek en my familie, in samewerking met die breër boerderygemeenskap en werkers, gepoog om so volhoubaar as moontlik te boer. Ons besef deeglik wat dit is om periodieke droogtes en natuurrampe te voorkom in die ongenaakbare Karoo. Boerderybestuur, insluitend droogtes en beperkte waterbronne, is van kritiese belang om finansiële lewensvatbaarheid in die semi-woestyn gebied te verseker. Ek en my voorsate het nog altyd gestreef om in lyn met regeringsbeleid soos drakrag per hektaar en die grootte van ekonomiese eenhede, te boer. Ons familie was ook nog altyd nou betrokke by die

## APPENDICES

### ENVIRONMENTAL IMPACT ASSESSMENT REPORT: Scoping and Environmental Impact Assessment (EIA) Process for the Proposed Development of a Solar Photovoltaic (PV) Facility (Kudu Solar Facility 3) and associated infrastructure, near De Aar, Northern Cape Province

---

gemeenskappe in die distrik, welwetende wat die positiewe impak van boerdery op die sosio-ekonomiese uitdagings het. Werkloosheid en armoede in die Renosterberg munisipaliteit is van die hoogste in Suid – Afrika. Die boere van die gemeenskap hou nietemin die gemeenskappe in stand, ten spyte van die laer produksiepryse, inflasie en rente stygings, 'n plaaslike owerheid wat inplof en geen regerings ondersteuning nie.

Die bovermelde paragraaf het ten doel om te bevestig hoe moeilik dit is om volhoubaar in die Karoo te boer. As daar dus nuwe ekonomiese geleenthede na vore kom, soos in die geval met die beoogde Kuduprojekte, is dit noodsaaklik dat ontwikkelaars met groot omsigtigheid die saak te benader. Volgens inligting tot my beskikking, word beoog om 14 sonplase op eiendomme van twee grondeienaars te ontwikkel. Dit is my mening dat die beoogde ontwikkeling kontra-produktief is betreffende die volhoubaarheid van landbou in die gebied. In plaas dat die ontwikkelingsgeleentheid kan meedoen om die breër boerderygemeenskap se welvaart en volhoubaarheid verbeter, gebeur die teenoorgestelde. Dit is strydig wat ten doel gestel word met die Onderverdeling van Landbougrondwet (SALA), wat onder andere landbouvolhoubaarheid bevorder.

Die uitkoms van so 'n benadering is dat enkele individue astronomies finansiële bevorder word, terwyl die res van die gemeenskap effektief benadeel word. Die benadering impakteer direk op sosio – ekonomiese realiteite soos werkloosheid, armoede, tiener swangerskappe, ongeletterheid, drank misbruik en vele meer. Die werklike alternatief is om 'n gedesentraliseerde benadering te volg, wat binne die huidige raamwerk van SALA benader word waardeur die ekonomiese trefwydte verbreed word en finansiële voordele meer versprei word. Dit beteken dat daar 'n sinergie tussen landbou volhoubaarheid, energie behoeftes en die sosio – ekonomiese uitdagings van verarmde gemeenskappe soos Phillipstown, Petrusville of Phillipstown en die ontwikkeling moet bestaan. Soos die ontwikkeling tans beplan word, is en sal dit nie die geval wees nie.

Aangesien ek die plaas Basberg vir langer as twintig jaar huur, het ek ook verder 'n direkte belang by die ontwikkeling. Basberg speel 'n belangrike rol in my boerderybeplanning en inkomste. As sonplase buite die raamwerk van SALA op die eiendom ontwikkel word, sal dit nie meer

## APPENDICES

### ENVIRONMENTAL IMPACT ASSESSMENT REPORT: Scoping and Environmental Impact Assessment (EIA) Process for the Proposed Development of a Solar Photovoltaic (PV) Facility (Kudu Solar Facility 3) and associated infrastructure, near De Aar, Northern Cape Province

---

ekonomies produktief wees om daar te boer nie, met natuurlik die gepaardgaande verlies aan inkomste en werksgeleenthede.

Dit is ook noodsaaklik om te noem dat ek uiters afhanklik is van die volhoubare grondwater om te boer, ook op Basberg. Ek is nie bewus of volhoubaarheidstudies rakende die ondergrondse water gedoen is nie, en wat die uitslag daarvan was nie. Die stoffaktor wat voortspring uit die massiewe gesentraliseerde benadering, impakteer ook direk op die produksievermoe van die veld, aangesien die vee nie plante eet wat met 'n stoflaag bedek word nie.

Ek wil verder vermeld dat daar volgens my inligting gebrekkige kommunikasie was met die tersaaklike gemeenskappe en plaaslike owerheid. Dit is krities dat daar saam met georganiseerde landbou en regeringsinstellings gewerk word om stabiliteit ten opsigte van moontlike arbeidsonrus, volhoubaarheid en gemeenskaps betrokkenheid te verseker.

Ek vertrou laastens dat my insette, bekommernisse en bydrae met die nodige sorg en oordeel hanteer sal word.

Die uwe,

[Redacted signature]

[Redacted name]



## APPENDICES

ENVIRONMENTAL IMPACT ASSESSMENT REPORT: Scoping and Environmental Impact Assessment (EIA) Process for the Proposed Development of a Solar Photovoltaic (PV) Facility (Kudu Solar Facility 3) and associated infrastructure, near De Aar, Northern Cape Province

---

**From:** EMS <ems@csir.co.za>  
**Sent:** Tuesday, 04 July 2023 10:35  
**To:** EMS  
**Cc:** [REDACTED]  
**Subject:** RE: Kudu Sonkragfasiliteite  
**Attachments:** Translation\_Comments Received from HCA Venter\_030723.docx

Goeie môre [REDACTED]

Baie dankie vir u insette en deelname in die publieke deelname proses dus ver.

Sien asseblief die aangehede vertaalde weergawe van u kommentaar. Ek sal dit opreg waardeer as u asseblief daarna kan kyk en na my toe kan terugkeer met enige voorstelle, verbeteringe, of kommentaar voor dat ek u insette insluit in die Kommentaar en Antwoorde Verslae.

Baie dankie  
Helen Antonopoulos

---