

Mulilo Springbok Wind Power (Pty) Ltd

ENVIRONMENTAL NOISE IMPACT ASSESSMENT

**for the proposed
Springbok Wind Energy Facility and associated
Infrastructure East of Okiep, Northern Cape Province**



Study done for:

savannah
environmental

Prepared by:

 **EARES**
Enviro Acoustic Research

P.O. Box 2047, Garsfontein East, 0060
Tel: 012 – 004 0362, Fax: 086 – 621 0292, E-mail: info@eares.co.za

EXECUTIVE SUMMARY

INTRODUCTION

Enviro-Acoustic Research cc was requested by Savannah Environmental (Pty) Ltd to provide a specialist opinion about environmental noise at the proposed Mulilo Springbok Wind Energy Facility (“WEF”). This opinion is to be used as part of an amendment to extend the validity of the Environmental Authorization (“EA”) for this proposed wind farm.

The original Noise Specialist study was compiled in October 2010 (Dracoulides, 2010) and it was recommended to redo the noise specialist study for the following reasons:

- the age of the original noise specialist assessment (Dracoulides, 2010), with the original study being older than 10 years;
- changes in legislation since the original noise specialist study was compiled, specifically the requirements of Government Notice Regulation 320 of March 2020; and
- a change in the layout of the wind turbine generators (“WTG”), as well as the availability of WTG that have a higher generating capacity.

PROJECT DESCRIPTION

The Springbok WEF will have a planned generating capacity of up to 55.5 MW and is proposed to accommodate the following infrastructure:

- Up to 13 wind turbines, each with a generating capacity of up to 8 MW with a maximum hub height of up to 200m and rotor diameter of up to 200m;
- Medium-voltage (“MV”) power lines between the WTG and collector substation;
- A switching substation allowing connection of the WEF with private off-taker (via an overhead gridline);
- A main access road as well as an internal road network between project components;
- Gate house and security as well as an operation and maintenance buildings; and
- Temporary site camp and construction laydown areas.

DESCRIPTION OF THE SURROUNDING LAND USE

The proposed WEF will be located just east of the town of Okiep, with a number of residential dwellings located within 2,000 m from the closest wind turbines of the wind farm. There are also a number of structures scattered around the proposed WEF. While the western areas can be considered urban to sub-urban, most of the surrounding areas can be considered wilderness with scattered residential uses. Typical noises associated with denser urban areas might influence ambient sound levels at residences within Okiep.

DESCRIPTION OF THE CLOSEST POTENTIAL NOISE SENSITIVE RECEPTORS

Residential areas and potential noise-sensitive developments/receptors/communities (“NSR”) were identified using aerial images as well as a physical site visit, with a number of potential noise-sensitive receptors identified in the vicinity of the proposed wind farm.

BASELINE SOUND LEVELS

Dracoulides (2010) measured ambient sound levels in May 2010 at locations on the outskirts of Okiep, just west from the proposed Springbok WEF. This included 14 day- and 6 night-time measurements. Dracoulides (2010) defined the average daytime noise level at 47 dBA at MP04¹ and 41.4 dBA for the night-time measurements.

Dracoulides (2010) subsequently assigned the area a rating level (acceptable zone sound level) typical of a suburban noise district. This is expected when considering the developmental character of the measurement location on the edge of Okiep. Other locations, located further than 1,000 m from Okiep will be assumed to be quieter, with ambient sound levels typical of a rural noise district (based on measurements done by the Author of this report at similar locations).

Additional ambient sound level measurements were not collected for this report, as the measurements collected during 2, 3 and 4 May 2010 is considered sufficient for this assessment. Based on aerial images, there has been little urban development in the last decade and it is expected that the ambient sound levels would be similar.

The author also has significant additional ambient sound level data, collected in areas with similar developmental character. This data, as well as the data collected by Dracoulides (2010) will be used to define acceptable rating levels (noise limits).

ACCEPTABLE NOISE LIMITS

Because of the different developmental character in the area, different zone sound levels will be considered for the construction phase, namely:

- A night-time zone sound level of 35 dBA for areas located away from Okiep (with a daytime rating level of 45 dBA), typical of a rural noise district; and
- A night-time zone sound level of 40 dBA for areas located close or within Okiep (with a daytime rating level of 50 dBA), typical of a suburban noise district.

¹ The average level is 44.1 dBA for the day-time measurements at MP02 and MP4

Because the National Noise Control Regulations (NCR) and SANS 10103 does not cater for instances when background noise levels change due to the impact of external forces (such as noises induced by higher wind speeds), this assessment used international guidelines and local regulations to recommend more appropriate noise limits for this project. This is important, as the wind turbines will only operate during periods of higher wind speeds, a period that may coincide with higher ambient sound levels. This assessment therefore recommends a night-time noise limit of 42 dBA (periods with low or no winds – with this limit relevant for the construction phase) and an upper limit of 45 dBA (periods that wind turbines may operate – the operational phase).

FINDINGS

This study considers the potential noise impact on the surrounding environment due to the construction, operational and future decommissioning activities associated with the Project. It makes use of conceptual scenarios to develop noise propagation models to estimate potential noise levels. Considering the ambient sound levels measured onsite, the proposed noise limits as well as the calculated noise levels, it was determined that the significance of the potential noise impacts would be:

- of a **low significance** for the daytime construction activities (hard standing areas, excavation and concreting of foundations and the assembly of the WTG and other infrastructure);
- of a potential **medium significance** for the night-time construction activities (the pouring of concrete, erection of WTG). Mitigation is available and presented in this assessment that would reduce the significance of night-time noise impacts to **low**;
- of a **medium significance** for daytime operational activities (noises from wind turbines) when considering the worst-case SPL. Mitigation is available and presented in this assessment that would reduce the significance of night-time noise impacts to **low**; and
- of a **high significance** for night-time operational activities (noises from wind turbines) when considering the worst-case SPL. Mitigation is available and presented in this assessment that would reduce the significance of night-time noise impacts to **low**.

There is a **low significance** for a cumulative noise impact to occur during the operational phase.

MANAGEMENT & MITIGATION OF NOISE IMPACT

The significance of the noise impact will be of a **low** significance during the daytime period, though there is a potential of a noise impact of **medium** significance for night-time

construction activities. Mitigation measures are recommended to ensure that the potential annoyance due to noise are minimized. Potential measures could include:

- Minimizing night-time activities when working within 2,000 m from NSR. Work should only take place at one WTG location to minimize potential night-time cumulative noises (when working at night within 2,000 m from NSR);
- The applicant must notify the NSR when night-time activities will be taking place within 1,000 m from the NSR;
- If possible, the applicant can plan construction activities at WTG located within 1,000 m from NSR to take place during a period when the structures are not used for residential purposes; and
- The applicant must plan the completion of noisiest activities (such a pile driving, rock breaking and excavation) during the daytime period (even though it is expected that it is highly unlikely that this may take place at night).

The significance of the noise impact during the operation phase would be **medium** for day- and **high** for night-time operational activities. Operating WTG will be clearly audible at the closest NSR and potentially at disturbing noise levels. It is therefore recommended that:

- the applicant design and implement a noise abatement programme, which may include operating certain wind turbines in a reduced noise emission mode (it will be required that the applicant select a WTG that have the capability to operate in a reduced noise emission modes); **or**
- The applicant can select a WTG that have a maximum sound power emission level less than 107.0 dBA (re 1 pW) at locations closer than 2,000 m from any verified NSR; **or**
- The applicant can change to layout to move certain WTG further from verified NSR (the layout should be modelled to ensure that the potential noise levels will be less than 45 at all NSR); **or**
- The applicant can reduce the number of WTG that may be used at this WEF (the layout should be modelled to ensure that the potential noise levels will be less than 45 at all NSR); **or**
- The applicant can relocate certain of the verified NSR.

OPINION – PART 1 AMENDMENT TO EXTEND THE VALIDITY OF THE EA

As the EA validity will be extended beyond 10 years, the Department of Forestry, Fisheries and the Environment (“DFFE”) requires additional information to confirm that the environment has not changed. This is discussed in the following table.

Question	Statements
A site visit to define the status of the environment compared to the status of the environment during the original assessment	A site visit was conducted 2 and 3 March 2023 to define the status of all potential NSR identified for this assessment. Dracoulides (2010) did not identify specific NSR, focusing on the outskirts of Okiep and the boundaries of the proposed project.
Whether the original impact ratings are still applicable	The impact ratings used by Dracoulides (2010) is similar as the impact rating used by the author. Dracoulides, 2010 however have not defined the scores used in his assessment, with the author using the scores as defined in this assessment.
Whether the original mitigation measures are still valid	Dracoulides, 2010 recommended that: <ul style="list-style-type: none"> • Certain WTG be relocated; • That noise monitoring be conducted at certain locations, with a biannual monitoring frequency.
The need for new or additional mitigation measures	Due the significant changes in the WTG technologies and capabilities since the original assessment, various mitigation measures were added as defined in this assessment. These mitigation measures should replace the original recommendations.
New guidelines that must be taken into consideration for this assessment	GNR. 320 was promulgated in March 2020, with a number of requirements, including, amongst others: <ul style="list-style-type: none"> • A site sensitivity verification to confirm or dispute current land uses and sensitivities; • A baseline description of potential receptors as well as ambient noise levels.
Changes to the environment that occurred since the initial EA was issued	Using aerial images it appears that there has been little new developments within the vicinity of the project area in the last 10 years
Similar developments that may cumulatively contribute to noise levels in the area	As per the latest available Renewable Energy EIA Application database (3 rd quarter, 2022), there are two wind projects, approximately 24 km to the east and 32 km to the west. At this distance these projects will not cumulatively contribute to noise levels in the vicinity of the Springbok project.

RECOMMENDATIONS

Subject to the condition that the applicant will select appropriate measures to ensure that the potential medium and high significance noise impact is eliminated, it is recommended that the proposed Springbok WEF (and associated infrastructure) be authorized. The WTG layout is considered acceptable should the applicant select to use a WTG with a SPL less than 107.0 dBA (re 1 pW).

Active noise monitoring is recommended because the projected noise levels are more than 42 dBA (more than 7 dBA of the night-time rating level of a rural noise district) for the layout assessed for any WTG with an SPL exceeding 104.5 dBA (re 1 pW).

It is recommended that the applicant re-evaluate the noise impact:

1. should the layout be revised where:
 - a. any WTG, located within 1,500 m from any NSR, are moved closer to the NSR;
 - b. the number of WTG within 2,000 m from NSR are increased; and
2. should the applicant make use of a wind turbine with a maximum SPL exceeding 107.0 dBA re 1 pW.

To ensure that noise does not become an issue for future residents, landowners or the local communities, it is recommended that the applicant get written agreement from current landowners and/or community leaders that no new residential dwellings will be developed within areas enveloped by the 42 dBA noise level contour.

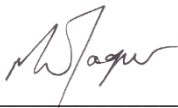

Signature

Morné de Jager

2023 – 03 – 09

Report should be sited as:

De Jager, M (2023). "Environmental Noise Impact Assessment for the Proposed Springbok Wind Energy Facility and Associated Infrastructure East of Okiep, Northern Cape Province", Enviro-Acoustic Research cc, Pretoria

Client:

Savannah Environmental (Pty) Ltd for
Mulilo Springbok Wind Power (Pty) Ltd

PO BOX 148
Sunninghill
Gauteng
2157

Report no:

SE- MSWEF/ENIA/202303-Rev 0

Author:

M. de Jager

(B. Ing (Chem))

Review:

Johan Maré

(MSc. Microbiology, PriSci Nat (400092/91))

Date:

March 2023

COPYRIGHT WARNING

This information is privileged and confidential in nature and unauthorized dissemination or copying is prohibited. This information will be updated as required. Mulilo Springbok Wind Power (Pty) Ltd claims protection of this information in terms of the Promotion of Access to Information Act, (No 2 of 2002) and without limiting this claim, especially the protection afforded by Chapter 4.

The document is the property of Enviro Acoustic Research cc. The content, including format, manner of presentation, ideas, technical procedure, technique and any attached appendices are subject to copyright in terms of the Copyright Act 98 of 1978 (as amended by the respective Copyright Amendment Acts No. 56 of 1980, No. 66 of 1983, No. 52 of 1984, No. 39 of 1986, No. 13 of 1988, No. 61 of 1989, No. 125 of 1992, Intellectual Property Laws Amendment Act, No. 38 of 1997 and, No. 9 of 2002) in terms of section 6 of the aforesaid Act, and may only be reproduced as part of the Environmental Impact Assessment process by Savannah Environmental (Pty) Ltd.

TABLE OF CONTENTS

	page
EXECUTIVE SUMMARY.....	ii
TABLE OF CONTENTS.....	ix
LIST OF TABLES	xii
LIST OF FIGURES	xiv
APPENDICES	xv
1 CHECKLIST: GG43110 MINIMUM REQUIREMENTS	1
2 INTRODUCTION.....	3
2.1 Introduction and Purpose	3
2.2 Brief Project Background	4
2.3 Brief Project Description	6
2.4 Proposed Wind Turbine	6
2.5 Study area	8
2.5.1 Topography.....	8
2.5.2 Surrounding Land Use.....	8
2.5.3 Transportation Networks	8
2.5.4 Other industries and mines.....	8
2.5.5 Ground conditions and vegetation.....	9
2.5.6 Potential Noise-sensitive Receptors.....	9
2.6 Environmental Sensitivity – Noise Theme.....	10
2.7 Comments received during the EIA	10
2.8 Terms of Reference	10
2.8.1 Requirements as per Government Gazette 43110 of March 2020.....	11
2.8.2 Requirements as per South African National Standards (SANS).....	13
3 LEGAL CONTEXT, POLICIES AND GUIDELINES.....	19
3.1 The Republic of South Africa Constitution Act (“the Constitution”) ..	19
3.2 The Environment Conservation Act (Act 73 of 1989).....	19
3.2.1 National Noise Control Regulations (GN R154 of 1992)	19
3.3 The National Environmental Management Act (Act 107 of 1998).....	21
3.4 Noise Standards	22
3.5 International Guidelines	23
3.5.1 Guidelines for Community Noise (WHO, 1999) [141].....	23

3.5.2	<i>Night Noise Guidelines for Europe (WHO, 2009) [142]</i>	24
3.5.3	<i>The Assessment and Rating of Noise from Wind Farms (Energy Technology Support Unit, 1997)</i>	25
3.5.4	<i>Noise Guidelines for Wind Farms (MoE, 2008) [87]</i>	26
3.5.5	<i>Equator Principles</i>	27
3.5.6	<i>IFC: General EHS Guidelines – Environmental Noise Management [63]</i>	27
3.5.7	<i>European Parliament Directive 2000/14/EC [36]</i>	29
3.5.8	<i>Environmental, Health, and Safety Guidelines for Wind Energy [64]</i>	29
3.5.9	<i>Environmental Noise Guidelines for the European Region (2018) [143]</i>	30
3.5.10	<i>Concluding remarks on the use of International Guidelines in this Assessment</i>	31
4	CURRENT ENVIRONMENTAL SOUND CHARACTER	33
4.1	<i>Influence of Season on Ambient Sound Levels</i>	33
4.1.1	<i>Effect of Wind</i>	34
4.1.2	<i>Effect of Humidity and Temperature</i>	34
4.2	<i>Ambient Sound Level Measurements</i>	35
5	INVESTIGATION OF EXISTING AND FUTURE NOISE LEVELS	
	39	
5.1	<i>Potential Noise Sources: Construction Phase</i>	39
5.1.1	<i>Construction equipment</i>	39
5.1.2	<i>Material supply: Concrete batching plants</i>	41
5.1.3	<i>Blasting</i>	42
5.1.4	<i>Construction Traffic</i>	42
5.2	<i>Potential Noise Sources: Operation Phase</i>	46
5.2.1	<i>Wind Turbine Noise: Aerodynamic sources [7, 17, 29, 40, 106]</i>	46
5.2.2	<i>Wind Turbine: Mechanical sources [43, 61, 106, 109]</i>	48
5.2.3	<i>Low Frequency Noise</i>	49
5.2.4	<i>Amplitude modulation</i>	51
5.2.5	<i>Battery Energy Storage Systems</i>	53
5.2.6	<i>Transformer noises (Substations)</i>	54
5.2.7	<i>Transmission Line Noise (Corona noise)</i>	55
6	METHODS: NOISE IMPACT ASSESSMENT	56
6.1	<i>Noise Impact on Animals</i>	56
6.1.1	<i>Domesticated Animals</i>	57
6.1.2	<i>Wildlife</i>	58
6.1.3	<i>Avifauna</i>	58

6.1.4	<i>Concluding Remarks - Noise Impacts on Animals</i>	58
6.2	Why noise concerns communities [3, 14, 19, 24, 29, 50, 74, 91, 106, 120]	60
6.2.1	<i>Noise Annoyance</i>	61
6.3	Impact Assessment Criteria	64
6.3.1	<i>Overview: The Common Characteristics</i>	64
6.3.2	<i>Noise criteria of concern</i>	64
6.4	Setting appropriate Noise Limits	66
6.4.1	<i>Using International Guidelines to set Noise Limits – ETSU-R97</i>	66
6.4.2	<i>Considering the latest WHO (2018) recommendations</i>	67
6.4.3	<i>Using the National NCR to set noise limits</i>	67
6.5	Determining the Significance of the Noise Impact.....	69
6.5.1	<i>Impact Assessment criteria</i>	69
6.6	Identifying the Potential Impacts without Mitigation Measures (WOM)	72
6.6.1	<i>Identifying the Potential Impacts with Mitigation Measures (WM)</i>	72
7	METHODS: CALCULATION OF NOISE LEVELS	74
7.1	Point and Area Noises – Construction and Operational activities	74
7.2	Road Traffic Noise Levels.....	75
8	ASSUMPTIONS AND LIMITATIONS	76
8.1	Limitations - Acoustical Measurements and Assessments.....	76
8.2	Calculating noise emissions – Adequacy of predictive methods.....	77
8.3	Adequacy of Underlying Assumptions	78
8.4	Uncertainties associated with mitigation measures	78
8.5	Uncertainties of Information Provided.....	79
8.6	Conditions to which this study is subject.....	80
9	PROJECTED NOISE RATING LEVELS	81
9.1	Conceptual Scenarios – Noise due to Future Construction Activities	81
9.2	Conceptual Scenarios – Noise due to Future Operational Activities..	84
9.3	Potential Cumulative Noise Impacts	84
9.4	Potential Decommissioning, Closure and Post-closure Noise Levels .	85
10	SIGNIFICANCE OF THE NOISE IMPACT	90
10.1	Noises relating to the Planning and Design Phase.....	90
10.2	Noises associated with construction activities	90

10.3	Noise Impact due to Future Operational Activities	90
10.4	Cumulative noise impact from other WEFs	92
10.5	Evaluation of Alternatives	92
10.5.1	<i>Alternative 1: No-go option</i>	92
10.5.2	<i>Alternative 2: Proposed Renewable Power Generation activities</i>	92
10.6	Noise Impact Assessment Tables	93
11	MITIGATION OPTIONS	97
11.1	Mitigation options available to reduce Noise Impact during the Construction Phase	98
11.2	Mitigation options available to reduce Noise Impact during operation	98
11.3	Mitigation options available to reduce Noise Impact during decommissioning	99
11.4	Mitigation and Management conditions to be included in the EMPr and Environmental Authorization	99
12	ENVIRONMENTAL MONITORING PLAN.....	101
12.1	Measurement Localities and Frequency	101
12.2	Measurement Procedures	102
13	ENVIRONMENTAL MANAGEMENT	103
14	OPINION FOR A PART 1 AMENDMENT.....	105
15	CONCLUSIONS AND RECOMMENDATIONS	106
16	REFERENCES.....	108

LIST OF TABLES

	page
Table 3-1: Summary of Sound Level Limits for Wind Farms (MoE)	26
Table 3-2: IFC Table 7.1-Noise Level Guidelines.....	29
Table 5-1: Equipment list and Sound power emission levels used for modelling	41
Table 5-2: Potential maximum noise levels generated by construction equipment	43
Table 5-3: Potential equivalent noise levels generated by various equipment	45
Table 6-1: Acceptable Zone Sound Levels for noise in districts (SANS 10103:2008)	65
Table 6-2: Proposed ambient sound levels and acceptable rating levels	69
Table 6-3: Impact Assessment Criteria – Magnitude / Intensity.....	70

Table 6-4: Impact Assessment Criteria – Spatial extent	71
Table 6-5: Impact Assessment Criteria - Duration	71
Table 6-6: Impact Assessment Criteria – Probability	71
Table 6-7: Impact Assessment Criteria – Significance without Mitigation	72
Table 6-8: Impact Assessment Criteria – Significance with Mitigation	73
Table 10-1: Impact Assessment: Daytime WTG construction activities	93
Table 10-2: Impact Assessment: Night-time WTG construction activities	94
Table 10-3: Impact Assessment: Daytime operation of WTG considering the worst-case SPL	95
Table 10-4: Impact Assessment: Night-time operation of WTG considering the worst-case SPL	96
Table 13-1: Environmental Management for planning phase	103
Table 13-2: Environmental Management for night-time construction activities.....	104
Table 13-3: Environmental Management for night-time operational period.....	104
Table 14-1: Summary of information required for EA validity	105

LIST OF FIGURES

	page
Figure 2-1: Regional Location of the proposed Springbok WEF	15
Figure 2-2: Study area and potential NSR close to Springbok WEF (aerial image dated October 2021)	16
Figure 2-3: Study area and potential NSR close to Springbok WEF (aerial image dated September 2009)	17
Figure 2-4: Study area and potential noise-sensitive areas identified by the online screening tool	18
Figure 4-1: Effect of Temperature and Humidity on propagation of Sound	35
Figure 4-2: Localities where ambient sound levels were measured by Dracouliles in 2010	36
Figure 4-3: Daytime ambient sound levels measured in vicinity of project	37
Figure 4-4: Night-time ambient sound levels measured in vicinity of project	38
Figure 5-1: Noise Emissions Curve of a number of different wind turbines (figure for illustration purposes only)	47
Figure 5-2: Octave sound power emissions of various wind turbines	48
Figure 5-3: Third octave band sound power levels at various wind speeds at a location where wind induced noises dominate	50
Figure 5-4: Example time-sound series graph illustrating AM as measured by Stigwood (2013) [123]	51
Figure 5-5: Conceptual BESS components	54
Figure 6-1: Logarithmic Chart of the Hearing Ranges of Some Animals	57
Figure 6-2: Percentage of annoyed persons as a function of the day-evening-night noise exposure at the façade of a dwelling	62
Figure 6-3: Criteria to assess the significance of impacts stemming from noise	65
Figure 9-1: WTG locations and associated infrastructure for the proposed Springbok WEF	82
Figure 9-2: Projected conceptual construction noise levels for the proposed Springbok WEF	83
Figure 9-3: Projected future noise rating level contours (worst-case SPL of 112.6 dBA re 1 pW)	86
Figure 9-4: Projected future noise rating level contours (potential SPL of 109.2 dBA re 1 pW)	87
Figure 9-5: Projected future noise rating level contours (best-case SPL of 104.3 dBA re 1 pW)	88
Figure 9-6: Effect of distance between wind turbines – potential cumulative noise	89

Figure 10-1: Projected noise levels for a WTG with an SPL of 112.6 dBA (re 1 pW) at different wind speeds	91
Figure 10-2: Projected noise levels for a WTG with an SPL of 109.2 dBA (re 1 pW) at different wind speeds	91
Figure 10-3: Projected noise levels for a WTG with an SPL of 104.3 dBA (re 1 pW) at different wind speeds	92

APPENDICES

Appendix A	Curriculum Vitae
Appendix B	Glossary of Terms
Appendix C	Declaration of Independence
Appendix D	Site Sensitivity Verification
Appendix E	Photos of Measurement Locations
Appendix F	Noise-sensitive receptors and calculated conceptual noise levels calculated noise levels and significance of noise impact

GLOSSARY OF ABBREVIATIONS

ASTER	Advanced Spaceborne Thermal Emission and Reflection Radiometer
BA	Basic Assessment
BESS	Battery Energy Storage System
DEM	Digital Elevation Model
DFFE	Department of Forestry, Fisheries and the Environment
EAP	Environmental Assessment Practitioner
EARES	Enviro Acoustic Research cc
ECA	Environment Conservation Act
ECO	Environmental Control Officer
EHS	Environmental Health and Safety
EMPr	Environmental Management Programme
ENIA	Environmental Noise Impact Assessment
ENM	Environmental Noise Monitoring
ENPAT	Environmental Potential Atlas for South Africa
ETSU	Energy Technology Support Unit
EPs	Equator Principles
EPFIs	Equator Principles Financial Institutions
FEL	Front-end Loader
GN	Government Notice

GNR	Government Notice Regulation
HNI	House Not Inhabited
I&APs	Interested and Affected Parties
IEC	International Electrotechnical Commission
IFC	International Finance Corporation
ISO	International Organization for Standardization
LAN	Local Authority Notice
METI	Ministry of Economy, Trade, and Industry
MTS	Main Transmission Substation
NA	No Access
NASA	National Aeronautical and Space Administration
NEMA	National Environmental Management Act
NCR	Noise Control Regulations
NSR	Noise-sensitive Receptor
PFA	Project Focus Area
PPP	Public Participation Process
SABS	South African Bureau of Standards
SANS	South African National Standards
SPL	Sound Power Emission Level (or Sound Power Level)
SR	Significance Rating
TLB	Tractor-Loader-Backhoe (also referred to as a backhoe)
UTM	Universal Transverse Mercator
WHO	World Health Organization
WEF	Wind Energy Facility
WF	Wind Farm
WIN	Wind Induced Noises
WTG	Wind Turbine Generator
WTN	Wind Turbine Noise

GLOSSARY OF UNITS

°C	Degrees Celsius (measurement of temperature)
dB	Decibel (expression of the relative loudness of the un-weighted sound level in air)
dBA	Decibel (expression of the relative loudness of the A-weighted sound level in air)
Hz	Hertz (measurement of frequency)
kg/m ²	Surface density (measurement of surface density)

km	Kilometre (measurement of distance)
m	Meter (measurement of distance)
m ²	Square meter (measurement of area)
m ³	Cubic meter (measurement of volume)
mamsl	Meters above mean sea level
m/s	Meter per second (measurement for velocity)
pW	pico Watt (10 ⁻¹²) (measurement of power – sound power in air)
μPa	Micro pascal (measurement of pressure – in air in this document)

1 CHECKLIST: GG43110 MINIMUM REQUIREMENTS

The National Web based Environmental Screening Tool² was used to screen the proposed site for the noise environmental sensitivity as per the requirements of GNR320 (20 March 2020), considering the site location illustrated in **Figure 2-1**.

The site report generated by the Screening Tool highlighted that a Noise Impact Assessment must be completed and appended to the Environmental Authorization (EA) documentation.

The screening report was developed for Utilities Infrastructure => Electricity => Generation => Renewable => Wind category, with the noise sensitive areas illustrated on **Figure 2-4**. The areas defined to have a potential “**very high**” sensitivity to noise were downloaded as a layer from the online screening tool.

In terms of GNR320 (20 March 2020), a Noise Study must contain, as a minimum, the following information:

Clause	Requirement	Comment / Reference
2.3.1	Current ambient sound levels recorded at relevant locations over a minimum of two nights and that provide a representative measurement of the ambient noise climate, with each sample being a minimum of ten minutes and taken at two different times of the night on each night, in order to record typical ambient sound levels at these different times of night	Sections 4.1 and 4.2 as well as Figure 4-3
2.3.2	Records of the approximate wind speed at the time of the measurement	Section 4.2 and Figure 4-3
2.3.3	Mapped distance of the receiver from the proposed development that is the noise source	Section 2.5.6 and 9
2.3.4	Discussion on temporal aspects of baseline ambient conditions	Section 4.1
2.4.1	Characterization and determination of noise emissions from the noise source, where characterization could include types of noise, frequency, content, vibration and temporal aspects	Table 5-2, Table 5-3 and Table 5-1
2.4.2	Projected total noise levels and changes in noise levels as a result of the construction, commissioning and operation of the proposed	Section 9

² <https://screening.environment.gov.za/screeningtool/#/pages/welcome>

	development for the nearest receptors using industry accepted models and forecasts	
2.5.1	Contact details of the environmental assessment practitioner or noise specialist, their relevant qualifications and expertise in preparing the statement, and a curriculum vitae	Appendix A
2.5.2	a signed statement of independence by the environmental assessment practitioner or noise specialist.	Appendix C
2.5.3	The duration and date of the site inspection and the relevance of the season and weather condition to the outcome of the assessment	See section 4
2.5.4	A description of the methodology used to undertake the on-site assessment, inclusive of the equipment and models used, as relevant, together with the results of the noise assessment	See section 4.1
2.5.5	a map showing the proposed development footprint (including supporting infrastructure) overlaid on the noise sensitivity map generated by the screening tool	See Figure 2-1
2.5.6	confirmation that all reasonable measures have been taken through micro- siting to minimize disturbance to receptors	Site development limited to wind resource
2.5.7	a substantiated statement from the specialist on the acceptability, or not, of the proposed development and a recommendation on the approval, or not, of the proposed development	See section 13
2.5.8	any conditions to which this statement is subjected	See section 8.6
2.5.9	the assessment must identify alternative development footprints within the preferred site which would be of a “low” sensitivity as identified by the screening tool and verified through the site sensitivity verification and which were not considered	Site development limited to the location of the wind resource
2.5.10	A motivation must be provided if there were development footprints identified as per paragraph 2.5.9 above that were identified as having a “low” noise sensitivity and that were not considered appropriate	Site development limited to the location of the wind resource
2.5.11	where required, proposed impact management outcomes, mitigation measures for noise emissions during the construction and commissioning phases that may be of relative short duration, or any monitoring requirements for inclusion in the Environmental Management Programme (EMPr), and	See section 0 and 12
2.5.12	a description of the assumptions made and any uncertainties or gaps in knowledge or data as well as a statement of the timing and intensity of site inspection observations	See section 8

2 INTRODUCTION

2.1 INTRODUCTION AND PURPOSE

Enviro-Acoustic Research cc was requested by Savannah Environmental (Pty) Ltd (the Environmental Assessment Practitioner or “EAP”) to provide a specialist opinion about environmental noise at the proposed Mulilo Springbok Wind Energy Facility (“WEF”). This opinion is to be used as part of an amendment to extend the validity of the Environmental Authorization (“EA”) for this proposed WEF.

As the EA validity will be extended beyond 10 years, the Department of Forestry, Fisheries and the Environment (“DFFE”) requires additional information to confirm that the environment has not changed. The following information is required:

- A site visit (if necessary) to confirm the status of the environment compared to that at the time of the original assessment;
- An indication as to whether the impact rating as provided in the initial assessment remains valid, and;
 - whether the mitigation measures provided in the initial assessment are still applicable; or
 - if there are any new mitigation measures which need to be included into the EA, should the request to extend the commencement period be granted by the Department.
- An indication as to whether there are any new assessments/guidelines which are now relevant to the authorised development which were not undertaken as part of the initial assessment, must be taken into consideration and addressed in the report;
- A description and an assessment of any changes to the environment (social and biophysical) that has occurred since the initial EA was issued;
- A description and an assessment of the surrounding environment, in relation to new developments or changes in land use which might impact on the authorised project, the assessment must consider the following:
 - similar developments within a 30km radius; and
 - identified cumulative impacts, and where possible the size of the identified impact must be quantified and indicated, i.e., hectares of cumulatively transformed land.

The original Noise Specialist study was compiled in October 2010 (Dracoulides, 2010 [37]) and it was recommended to redo the noise specialist study for the following reasons:

- the age of the original noise specialist assessment (Dracoulides, 2010 [37]), with the original study being older than 10 years;

- changes in legislation since the original noise specialist study was compiled, specifically the requirements of Government Notice Regulation 320 of March 2020; and
- a change in the layout of the wind turbine generators (“WTG”), as well as the availability of WTG that have a higher generating capacity.

This report briefly discusses ambient sound levels in the area (as reported by Dracoulides, 2010 [37]), potential worst-case noise rating levels and the potential noise impact that the project may have on the surrounding environment, highlighting the methods used, potential issues identified, findings and recommendations.

This study considered local regulations and both local and international guidelines, using the terms of reference (“ToR”) as proposed by SANS 10328:2008 for a comprehensive Environmental Noise Impact Assessment (“ENIA”) and as proposed by the requirements specified in the Assessment Protocol for Noise that were published on 20 March 2020, in Government Gazette 43110, GNR 320. The study also considers the noise limits as proposed by the International Finance Corporation (“IFC”) which is based on studies completed by the World Health Organization (“WHO”).

2.2 BRIEF PROJECT BACKGROUND

Mulilo Renewable Projects Developments (Pty) Ltd (Mulilo) trading as Mulilo Springbok Wind Power (Pty) Ltd is proposing to amend the Environmental Authorisation (“EA”) for the Springbok Wind Energy Facility, by extending the EA validity by an additional five (5) years. Extension of the validity of the EA will ensure that the EA remains valid for the undertaking of the authorised activities.

The EA Amendment will be completed in terms of Regulation 30(1)(a) of the Environmental Impact Assessment (EIA) Regulations, 2014, as amended, including the additional studies and public participation required by the DFFE. Condition 1.7 of the First Issue Environmental Authorisation, Issued on the 27th of July 2011, DEA Reference 12/12/20/1721 states that:

"This activity must commence within a period of three (3) years from the date of issue. If commencement of the activity does not occur within that period, the authorisation lapses and a new application for environmental authorisation must be made in order for the activity to be undertaken."

Consequent amendments to extend the validity of the authorisation have been made as follows:

- 12/12/20/1721 – authorised on the 27 June 2014 extending the validity to the 27th of June 2016;
- 12/12/20/1721/AM3 – authorised on the 18 May 2016 extending the validity to the 27th of July 2018;
- 12/12/20/1721/AM6 – authorised on the 3 August 2018 extending the validity to the 27th of July 2021; and
- The most recent 12/12/20/1721/AM8 – 28 June 2021 extending the validity to the 27th of January 2023 which states the following.

"This activity must commence within a period of eleven (11) years and six (6) months from the date of issue of the authorisation (i.e., the EA lapses on 27 January 2023). If commencement of the activity does not occur within that period, the authorisation lapses and a new application for environmental authorisation must be made in order for the activity to be undertaken."

The applicant, Mulilo Renewable Projects Developments (Pty) Ltd thus requests that the Competent Authority amends Condition 1.7 of the original EA (Page 4) as amended (DFFE Reference: 12/12/20/1721/1/AM8; dated 28 June 2021) as follows:

"This activity must commence within a period of sixteen (16) years and six (6) months from the date of issue of the authorisation (i.e., the EA lapses on 27 January 2028). If commencement of the activity does not occur within that period, the authorisation lapses and a new application for environmental authorisation must be made in order for the activity to be undertaken."

The 55.5 MW Springbok Wind Energy Facility was originally developed to be built and operated under the government's Renewable Energy Independent Power Producer Programme ("REIPPP"). As the REIPPP has experienced numerous and significant delays in moving forward in the last few years, it has in the past required the project developers to renew the EA anticipating that the REIPPP programme would commence again in the near future, which would allow the project to be bid and eventually constructed. In 2021, the project had been assigned to a private off taker, and AM8 was granted to extend the EA beyond 10 years, by an additional 18 months. However, due to recent Eskom grid capacity constraints and the further development and commencement of construction has been suspended to a yet to be determined date.

The extension of the validity period of the EA is therefore to allow the applicant more time to realize certain EA pre-construction conditions (as outlined above), and to keep the project in a construction ready state so that when Eskom capacity is available the project can be

implemented. This will help to ensure the project realizes its potential to deliver clean renewable energy to the South African economy.

2.3 BRIEF PROJECT DESCRIPTION

Mulilo Springbok Wind Power (Pty) Ltd propose to develop the Springbok WEF with the regional location of the project focus area ("PFA") is presented in **Figure 2-1**. The Springbok WEF will have a planned generating capacity of up to 55.5 MW and is proposed to accommodate the following infrastructure:

- Up to 13 wind turbines, each with a generating capacity of up to 8 MW with a maximum hub height of up to 200m and rotor diameter of up to 200m;
- Medium-voltage ("MV") power lines between the WTG and collector substation;
- A switching substation allowing connection of the WEF with private off-taker (via an overhead gridline);
- A main access road as well as an internal road network between project components;
- Gate house and security as well as an operation and maintenance buildings; and
- Temporary site camp and construction laydown areas.

2.4 PROPOSED WIND TURBINE

The wind energy market is fast changing and adapting to new technologies and site-specific constraints. Optimizing the technical specifications can add value through, for example, minimizing environmental impact and maximizing energy yield. As such the Developer has been evaluating several turbine models, however the selection will only be finalized at a later stage once a most optimal wind turbine is identified (factors such as meteorological data, price and financing options, guarantees and maintenance costs, etc. must be considered). The Developer indicated that they are considering a number of different wind turbines, however, due to various reasons, a developer does not want to reveal the actual WTG that they may consider, whether for commercial/economic reasons, possible Non-Disclosure Agreements etc. As the noise propagation modelling requires the details of a wind turbine, it was selected to use three potential operational scenarios to illustrate the potential noise impact, including:

- A WTG with a sound power emission level ("SPL") of 112.6 dBA (re 1 pW), using the SPL characteristics of the Goldwind GW165-6.0MW WTG (Goldwind, 2021 **[51]**; Goldwind, 2022 **[52]**) – the worst-case scenario;
- A WTG with an SPL of 109.2 dBA (re 1 pW), using the SPL characteristics of the Nordex N163 5.X WTG (Nordex, 2021 **[93]**) - typical scenario; and

- A WTG with an SPL of 104.3 dBA (re 1 pW), using the SPL characteristics of the Vestas V162-6.0 MW WTG (Vestas, 2020 [138]) (operating in mode PO6000, with serrated trailing edges on the blades) – best case scenario.

It is important to note that the exact details of the actual WTG are irrelevant to noise analysis, as the major factors that determine the noise levels are:

- The layout of the WEF (which would include the number of WTG as well as the distance from various receptors); and
- The sound power emission levels (“SPL”) of the WTG (or noise source) selected/that the developer is considering.

Minor factors in the noise levels are:

- The spectral characteristics of the WTG;
- Temperature and Humidity;
- Noise abatement technologies implemented by the manufacturer;
- Topography and wind shear effects;
- Ground surface characteristics.

Factors that do influence SPL are:

- The hub height of the WTG (the declared SPL level already include this factor);
- The rotor diameter of the WTG (the declared SPL level already include this factor);
- The manufacture of the WTG, the model name or number (the declared SPL level already include this factor).

The sound power emission levels are provided by the manufacturer either as the apparent SPL, maximum warranted SPL, a calculated SPL (for new WTG where the noise levels were not previously measured) or measured sound power levels as reported in terms of IEC 61400-11 or IEC 61400-14. It is unique for each make and model and the sound power levels already include the effect of the hub height, rotor diameter and abatement technologies.

There are smaller WTG with higher SPL, with larger WTG with a lower SPL. Therefore, the generating capacity, hub height or rotor diameter of the potential WTG should not be used to assume the noise levels.

Therefore, due to these factors, the total generating capacity of the WEF project may be less or more, when considering the individual generating capacity of the WTG (used for this noise specialist study) as well as the number of WTG in the layout. This however will not influence the findings of this noise specialist study.

2.5 STUDY AREA

The proposed WEF is proposed within the Nama Khoi Local Municipality in the Namakwa District Municipality (Northern Cape Province). The PFA is the conceptual study area selected to enclose all potential project infrastructure (excluding the main project access road(s)) approximately to 2,000 m from the noise-generating infrastructure of this WEF. The PFA is further described in terms of environmental components that may contribute to or change the sound character in the area.

2.5.1 Topography

The Environmental Potential Atlas of South Africa (van Riet, 1998) [137] describes the topography as "*Low Mountains*" in the PFA. The proposed WTG will be situated within a mountainous area at approximately 1,130 – 1,265 meters above sea level ("mamsl"). There are little natural features that could act as noise barriers considering practical distances at which sound from a WTG may propagate.

2.5.2 Surrounding Land Use

The proposed WEF will be located just east of the town of Okiep, with a number of residential dwellings located within the western side of the PFA. There are also a number of structures scattered around the proposed WEF. While the western areas can be considered urban to sub-urban, most of the surrounding areas can be considered wilderness with scattered residential uses. Typical noises associated with denser urban areas might influence ambient sound levels at residences within Okiep.

2.5.3 Transportation Networks

The N7 national road pass the PFA to the west, with the N14 national road passing the PFA to the south-east. These roads generally do not carry significant traffic (especially at night) and are of little acoustic significance. There are some small local roads transecting the PFA, with these roads mainly used by the local communities. Road traffic noises may temporarily influence ambient sound levels within 200 to 500 m from the roads, but the impact on ambient sound levels will be insignificant.

2.5.4 Other industries and mines

Based on a desktop assessment as well as information gained during the site visits, there are no industrial and mines located within the PFA that would impact on the ambient sound levels in the area.

2.5.5 Ground conditions and vegetation

The area falls within the Nama Karoo biome, with the vegetation type reported as the Central Lower Karoo (van Riet, 1998) [137]. The vegetation growth is typical of the nama karoo areas, with vegetation mainly consisting of grasses, dwarf shrubs with some weeds and small trees and shrubs closer to farm dwellings. The ground surface was generally well covered with vegetation during the site visit.

Taking into consideration available information it is the opinion of the author that the ground conditions (when considering acoustic propagation on a ground surface) can be classified as medium. A worst-case scenario will be investigated, considering a ground surface factor of 75% hard ground (which implies that it is not very acoustically absorbent) for modelling purposes. It should be noted that this factor is only relevant for air-borne waves being reflected from the ground surface, with certain frequencies slightly absorbed by the vegetation.

2.5.6 Potential Noise-sensitive Receptors

Potential noise-sensitive developments, receptors and communities (“NSR”) were identified using tools such as Google Earth® up to a distance of 2 000 m from WTG locations. A number of potential receptors (that could include a number of people and animals) was identified, highlighted in **Figure 2-2** (NSR identified before the site verification, aerial image dated October 2021), as well as in **Figure 2-3** (aerial image dated September 2009).

A list of the closest NSR (associated with the Springbok WEF) are presented in **Appendix F, Table 1**. Also indicated on this figure are generalized 500, 1 000 and 2 000 m buffer zones. Generally, noises from wind turbines:

- could be significant within 500 m, with receptors³ staying within 500 m from operational WTG subject to noises at a potentially sufficient level to be considered disturbing;
- are normally limited to a distance of approximately 1,000 m from operational wind turbines (subject to WTG layout, as the WTG cumulatively contribute to noise levels with 2,000 m from WTG). Night-time ambient sound levels could be elevated and the potential noise impact measurable; and
- likely to be audible up to a distance of 2,000 m at night. Noises from the WTG are generally of a low concern at distances greater than 2,000 m, although the sound of the WTGs may be audible at greater distances during certain metrological phenomena

³ Depending on the layout as well as the specific SPL characteristics of the selected WTG.

(sound levels are generally very low at distances greater than 2,000 m), though this may change with the introduction of WTG with higher power generating potential (depending on the specific model, see also **Section 2.4**).

2.6 ENVIRONMENTAL SENSITIVITY – NOISE THEME

The project site was assessed in terms of the Noise Sensitivity Theme using the online Environmental Screening Tool⁴.

Potential noise-sensitive areas with a “very high” sensitivity were obtained from the online screening tool using the Utilities Infrastructure => Electricity => Generation => Renewable => Wind category, with the potential noise-sensitive areas illustrated on **Figure 2-4**.

The screening report generated for the category Utilities Infrastructure => Electricity => Generation => Renewable => Wind does stipulate:

- that a Noise Specialist Study should be appended to the BA, and
- that the GNR320 Assessment Protocol be followed when doing the noise impact assessment.

2.7 COMMENTS RECEIVED DURING THE EIA

The author is not aware of any comments raised by the authorities or interested and affected parties at the date this report was compiled.

2.8 TERMS OF REFERENCE

A noise impact assessment must normally be completed for the following reasons:

- It was identified as an environmental theme needing further investigation in terms of (i.t.o.) the National Screening Tool as per the procedures of Government Gazette 43110 of 20 March 2020;
- A change in land use as highlighted in SANS 10328:2008, section 5.3;
- If an industry is to be established within 1,000 m from a potential noise sensitive development (SANS 10328:2008 [5.4 (h)]);
- If a wind farm (wind turbines - SANS 10328:2008 [5.4 (i)]) or a source of low-frequency noise (such as cooling or ventilation fans - SANS 10328:2008 [5.4 (l)]) is

⁴ <https://screening.environment.gov.za/screeningtool/#/pages/welcome>

to be established within 2,000 m from a potential noise sensitive development *or vice versa*;

- It is a controlled activity in terms of the NEMA regulations and an ENIA is required, because it may cause a disturbing noise that is prohibited in terms of section 18(1) of the Government Notice 579 of 2010; and
- It is generally required by the local or district authority as part of the environmental authorization or planning approval in terms of Regulation 2(d) or GN R154 of 1992.

This noise specialist study however is the result of a request from DFFE that requires additional information to confirm that the environment has not changed. The following information is required:

- Confirmation that the status of the environment did not change compared to that at the time of the original assessment);
- An indication as to whether the impact rating as provided in the initial assessment remains valid, and;
 - whether the mitigation measures provided in the initial assessment are still applicable; or
 - if there are any new mitigation measures which need to be included into the EA, should the request to extend the commencement period be granted by the Department;
- An indication as to whether there are any new assessments/guidelines which are now relevant to the authorised development which were not undertaken as part of the initial assessment, must be taken into consideration and addressed in the report;
- A description and an assessment of any changes to the environment (social and biophysical) that has occurred since the initial EA was issued;
- A description and an assessment of the surrounding environment, in relation to new developments or changes in land use which might impact on the authorised project, the assessment must consider the following:
 - similar developments within a 30km radius; and
 - identified cumulative impacts, and where possible the size of the identified impact must be quantified and indicated, i.e., hectares of cumulatively transformed land.

2.8.1 Requirements as per Government Gazette 43110 of March 2020

The Department of Forestry, Fisheries and Environment (“DFFE”) also promulgated Regulation 320, dated 20 March 2020 as published in Government Gazette No. 43110. The Procedures for the Assessment and Minimum Criteria for Reporting on Identified Environmental Themes

in Terms of Sections 24(5)(a) and (h) and 44 of the National Environmental Management Act, 1998, when applying for Environmental Authorisation would be applicable to this project.

This regulation defines the requirements for undertaking a site sensitivity verification, specialist assessment and the minimum report content requirements for environmental impact where a specialist assessment is required but no protocol has been prescribed. It requires that the current land use be considered using the national web based environmental screening tool to confirm the site sensitivity available at: <https://screening.environment.gov.za>.

If an applicant intending to undertake an activity identified in the scope of this protocol for which a specialist assessment has been identified on the screening tool on a site identified as being of:

- "very high" sensitivity for noise, must submit a Noise Specialist Assessment; or
- "low" sensitivity for noise, must submit a Noise Compliance Statement.

On a site where the information gathered from the site sensitivity verification differs from the designation of "very high" sensitivity on the screening tool and it is found to be of a "low" sensitivity, a Noise Compliance Statement must be submitted.

On a site where the information gathered from the initial site sensitivity verification differs from the designation of "low" sensitivity on the screening tool and it is found to be of a "very high" sensitivity, a Noise Specialist Assessment must be submitted.

If any part of the proposed development footprint falls within an area of "very high" sensitivity, the assessment and reporting requirements prescribed for the "very high" sensitivity apply to the entire footprint excluding linear activities for which noise impacts are associated with construction activities only and the noise levels return to the current levels after the completion of construction activities, in which case a compliance statement applies. In the context of this protocol, development footprint means the area on which the proposed development will take place and includes any area that will be disturbed.

The minimum requirements for a Noise Specialist Study (i.t.o. GNR 320 of 2020) are also covered in **Section 1** in the form of a checklist.

This assessment will be comprehensive and a Noise Specialist Assessment will be submitted because there are a number of potential noise-sensitive receptors living within 2 000 m from the proposed Project.

2.8.2 Requirements as per South African National Standards (SANS)

In South Africa the document that addresses the issues specifically concerning environmental noise is SANS 10103:2008. It has been thoroughly revised in 2008 and brought in line with the guidelines of the World Health Organisation (WHO). It provides the maximum average ambient noise levels during the day and night to which different types of developments indoors may be exposed.

In addition, SANS 10328:2008 (Edition 3) [114] specifies the methodology to assess the potential noise impacts on the environment due to a proposed activity that might impact on the environment. This standard also stipulates the minimum requirements to be investigated for EIA purposes. These minimum requirements are:

- a) the purpose of the investigation (see **section 2.1**);
- b) a brief description of the planned development or the changes that are being considered (see **section 2.2**);
- c) a brief description of the existing environment including, where relevant, the topography, surface conditions and meteorological conditions during measurements (see **section 2.5 and 4**);
- d) the identified noise sources together with their respective sound pressure levels or sound power levels (or both) and, where applicable, the operating cycles, the nature of sound emission, the spectral composition and the directional characteristics (see **section 5 and 7**);
- e) the identified noise sources that were not taken into account and the reasons as to why they were not investigated (see **section 5, 7 and 8**);
- f) the identified noise-sensitive developments and the noise impact on them (see **section 2.5.6, 9 and 10**);
- g) where applicable, any assumptions, with references, made with regard to any calculations or determination of source and propagation characteristics (see **section 8**);
- h) an explanation, either by a brief description or by reference, of all measuring and calculation procedures that were followed, as well as any possible adjustments to existing measuring methods that had to be made, together with the results of calculations (see **section 7 and 8**);
- i) an explanation, either by description or by reference, of all measuring or calculation methods (or both) that were used to determine existing and predicted rating levels, as well as other relevant information, including a statement of how the data were obtained and applied to determine the rating level for the area in question (see **section 4, 7 and 9**);

- j) the location of measuring or calculating points in a sketch or on a map (see **Figure 9-3**);
- k) quantification of the noise impact with, where relevant, reference to the literature consulted and the assumptions made (see **section 9**);
- l) alternatives that were considered and the results of those that were investigated (see **section 10.5**);
- m) a list of all the interested or affected parties that offered any comments with respect to the environmental noise impact investigation (see **section 2.7**);
- n) a detailed summary of all the comments received from interested or affected parties as well as the procedures and discussions followed to deal with them (see **section 2.7**);
- o) conclusions that were reached (see **section 13**);
- p) proposed recommendations (see **section 13**);
- q) if remedial measures will provide an acceptable solution which would prevent a significant impact, these remedial measures should be outlined in detail and included in the final record of decision if the approval is obtained from the relevant authority. If the remedial measures deteriorate after time and a follow-up auditing or maintenance programme (or both) is instituted, this programme should be included in the final recommendations and accepted in the record of decision if the approval is obtained from the relevant authority (see **section 11 and 13**); and
- r) any follow-up investigation which should be conducted at completion of the project as well as at regular intervals after the commissioning of the project so as to ensure that the recommendations of this report will be maintained in the future (see **section 13**).

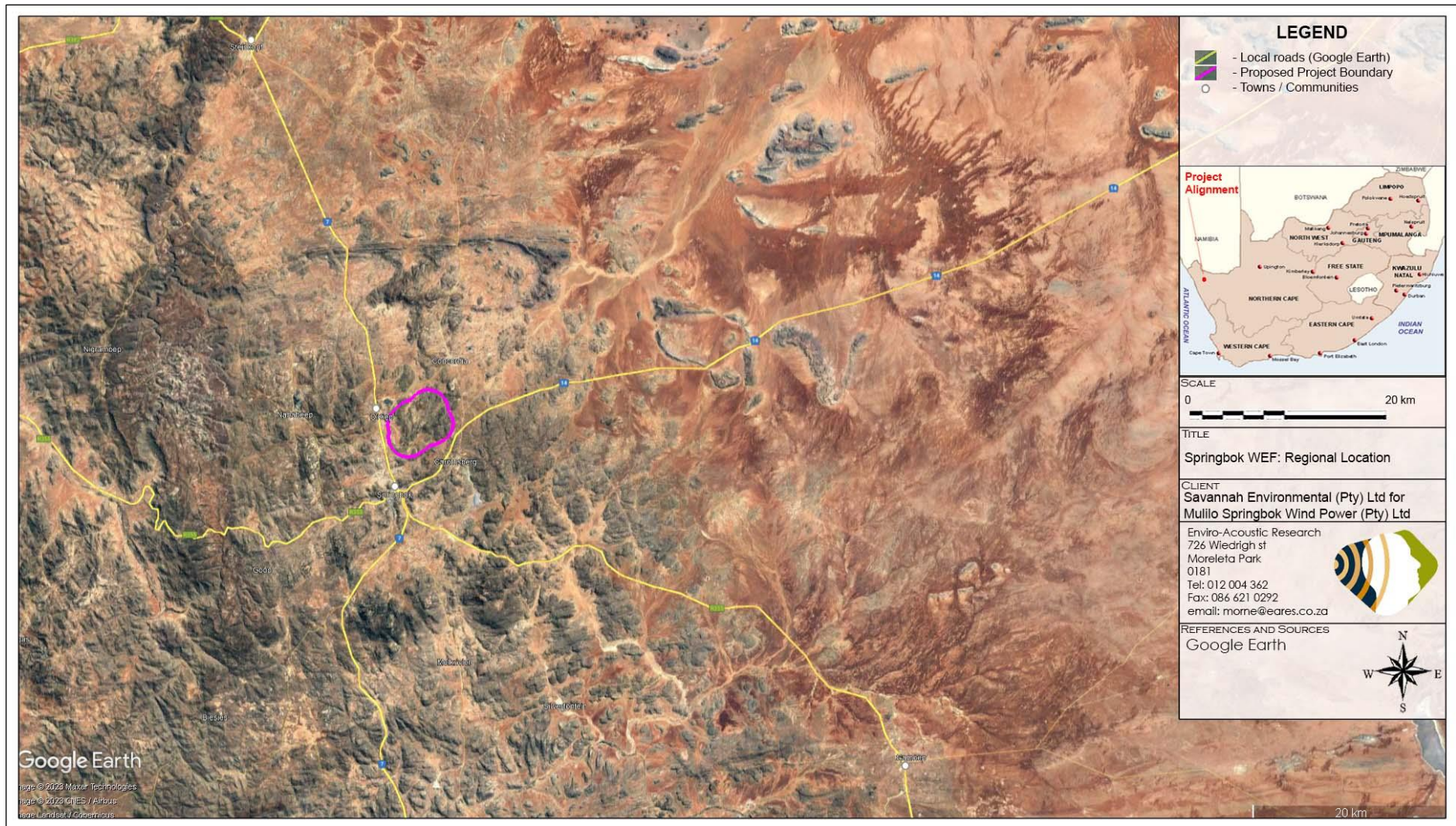

Figure 2-1: Regional Location of the proposed Springbok WEF

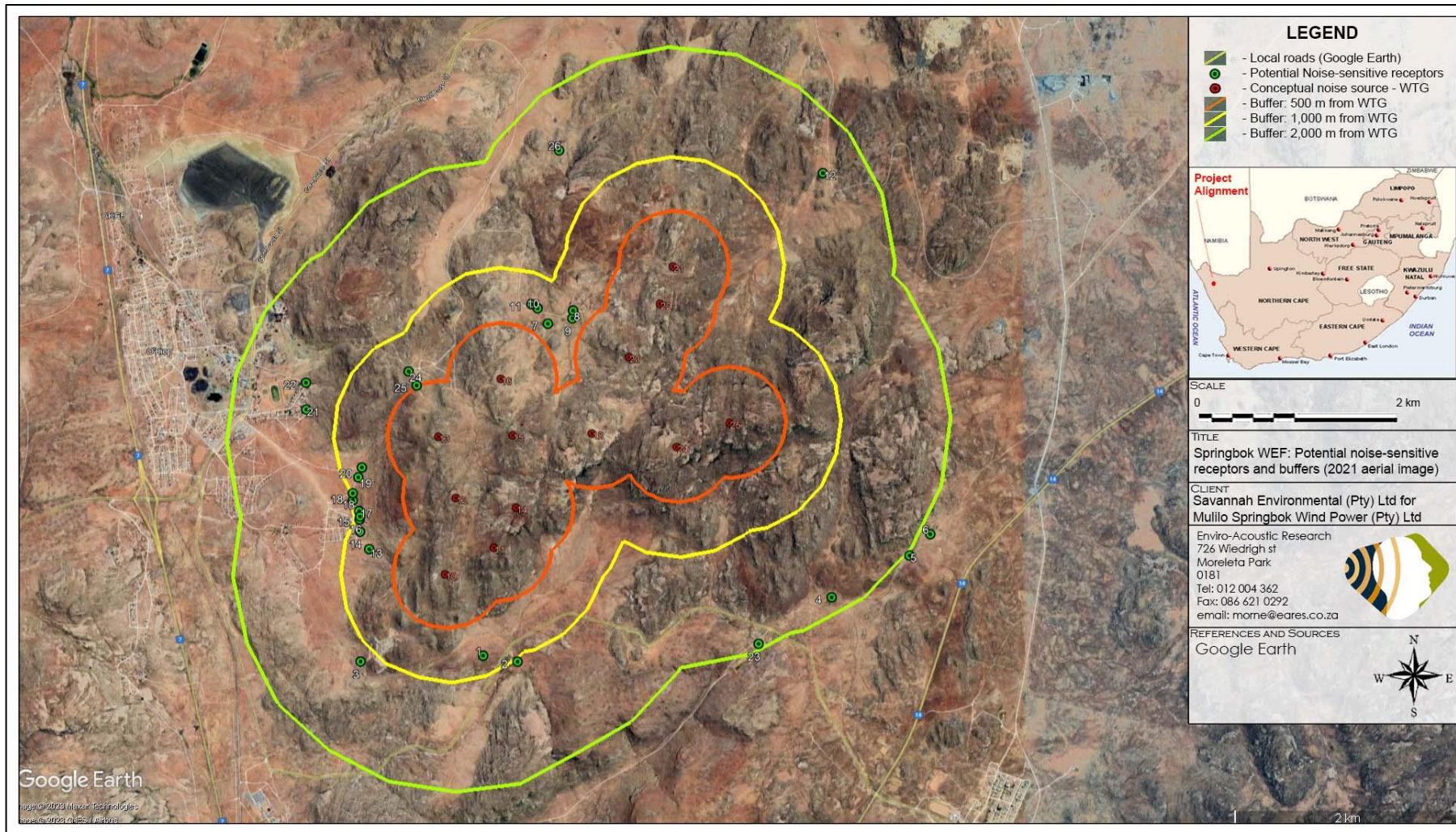

Figure 2-2: Study area and potential NSR close to Springbok WEF (aerial image dated October 2021)

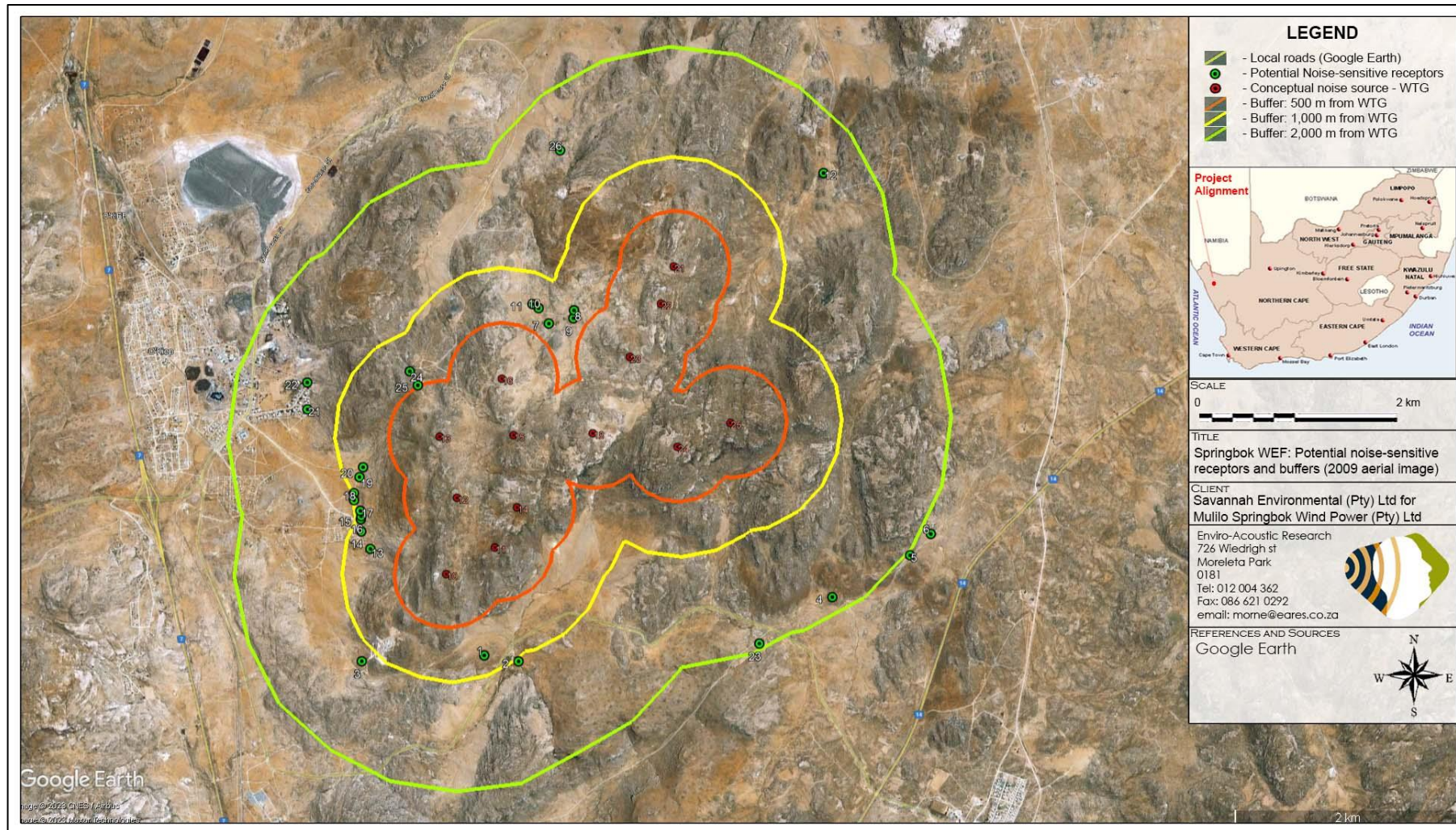

Figure 2-3: Study area and potential NSR close to Springbok WEF (aerial image dated September 2009)

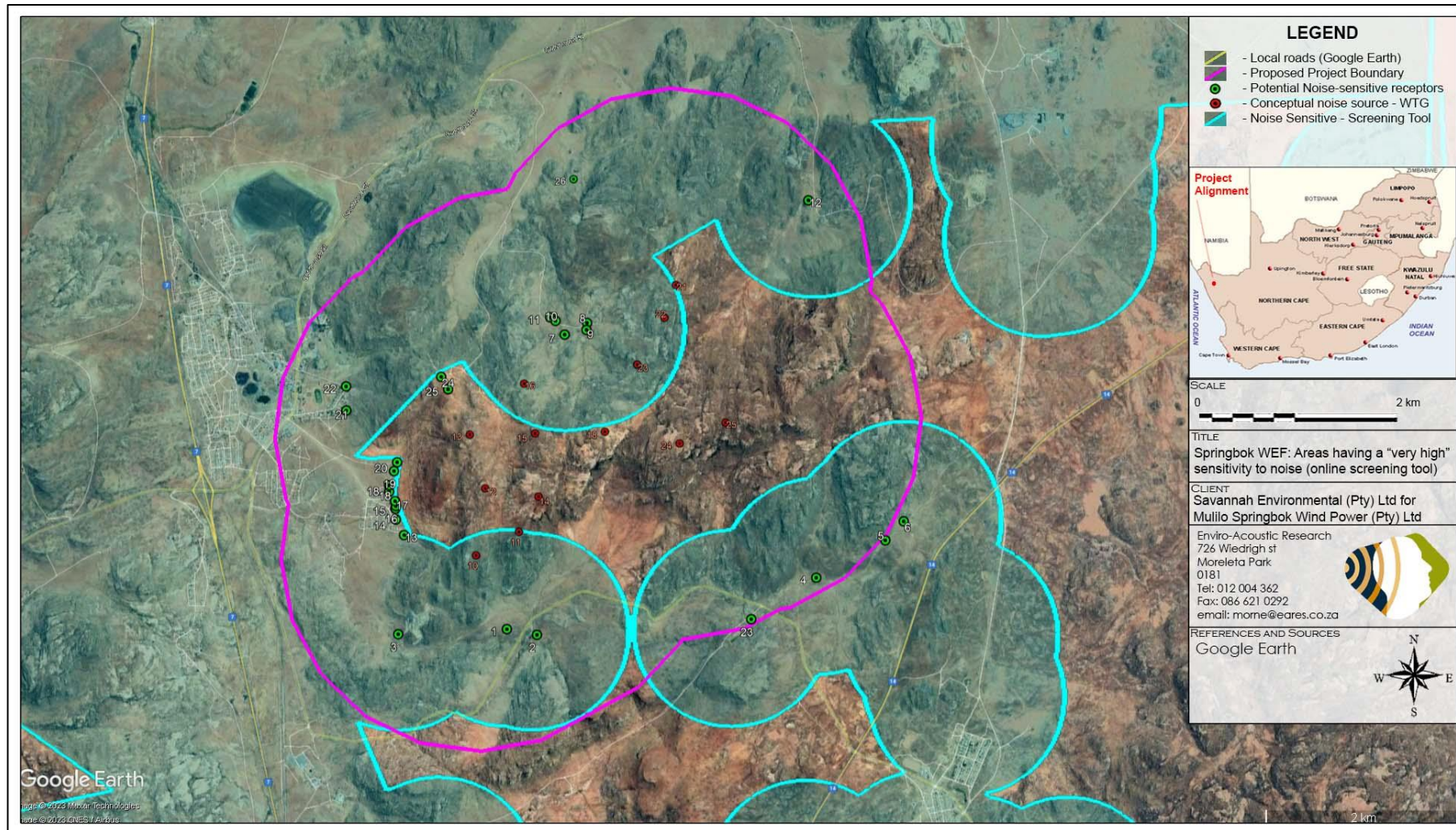

Figure 2-4: Study area and potential noise-sensitive areas identified by the online screening tool

3 LEGAL CONTEXT, POLICIES AND GUIDELINES

3.1 THE REPUBLIC OF SOUTH AFRICA CONSTITUTION ACT (“THE CONSTITUTION”)

The environmental rights contained in section 24 of the Constitution provide that everyone is entitled to an environment that is not harmful to his or her well-being. In the context of noise, this requires a determination of what level of noise is harmful to well-being. The general approach of the common law is to define an acceptable level of noise as that which the reasonable person can be expected to tolerate in the particular circumstances. The subjectivity of this approach can be problematic, which has led to the development of noise standards (see **Section 3.4**).

“Noise pollution” is specifically included in Part B of Schedule 5 of the Constitution, which means that noise pollution control is a local authority competence, provided that the local authority concerned has the capacity to carry out this function.

3.2 THE ENVIRONMENT CONSERVATION ACT (ACT 73 OF 1989)

The Environment Conservation Act (“ECA”) allows the Minister of Environment, Forestry and Fisheries to make regulations regarding noise, among other concerns. See also **section 3.2.1**.

3.2.1 National Noise Control Regulations (GN R154 of 1992)

The Noise Control Regulations (NCR) were promulgated in terms of section 25 of the ECA. The NCRs were revised under Government Notice Number R. 55 of 14 January 1994 to make it obligatory for all authorities to apply the regulations.

Subsequently, in terms of Schedule 5 of the Constitution of South Africa of 1996 legislative responsibility for administering the noise control regulations was devolved to provincial and local authorities. Provincial noise control regulations exist in the Free State, Gauteng and Western Cape provinces, but not in the Northern Cape Province (the National Noise Control Regulations will be in effect).

The National Noise Control Regulations (GN R154 1992) defines:

"controlled area" as:

- a piece of land designated by a local authority where, in the case of—
 - a) road transport noise in the vicinity of a road-

- i. the reading on an integrating impulse sound level meter, taken outdoors at the end of a period extending from 06:00 to 24:00 while such meter is in operation, exceeds 65 dBA; or
 - ii. the equivalent continuous "A"-weighted sound pressure level at a height of at least 1,2 meters, but not more than 1,4 meters, above the ground for a period extending from 06:00 to 24:00 as calculated in accordance with SABS 0210-1986, titled: "Code of Practice for calculating and predicting road traffic noise", published under Government Notice No. 358 of 20 February 1987, and projected for a period of 15 years following the date on which the local authority has made such designation, exceeds 65 dBA;
- c) industrial noise in the vicinity of an industry-
- i. the reading on an integrating impulse sound level meter, taken outdoors at the end of a period of 24 hours while such meter is in operation meter is in operation, exceeds 61 dBA; or
 - ii. the calculated outdoor equivalent continuous "A"-weighted sound pressure level at a height of at least 1,2 meters, but not more than 1,4 meters, above the ground for a period, exceeds 61 dBA.

"disturbing noise" as:

noise level which exceeds the zone sound level or, if no zone sound level has been designated, a noise level which exceeds the ambient sound level at the same measuring point by 7 dBA⁵ or more.

"zone sound level" as:

a derived dBA value determined indirectly by means of a series of measurements, calculations or table readings and designated by a local authority for an area. This is the same as the Rating Level as defined in SANS 10103.

In addition:

In terms of Regulation 2 -

"A local authority may -

(a) establish a new township unless the lay-out plan concerned, if required by a local authority, indicates in accordance with the specifications of the local authority, the existing and future sources of noise, with concomitant dBA values which are foreseen in the township for a period of 15 years following the date on which the erection of the buildings in and around the township commences;

⁵ When comparing the results of a measurement (minimum duration of 10 minutes) without the noise under investigation with a similar measurement with the noise present.

(c): " if a noise emanating from a building, premises, vehicle, recreational vehicle or street is a disturbing noise or noise nuisance, or may in the opinion of the local authority concerned be a disturbing noise or noise nuisance, instruct in writing the person causing such noise or who is responsible therefor, or the owner or occupant of such building or premises from which or from where such noise emanates or may emanate, or all such persons, to discontinue or cause to be discontinued such noise, or to take steps to lower the level of the noise to a level conforming to the requirements of these Regulations within the period stipulated in the instruction: Provided that the provisions of this paragraph shall not apply in respect of a disturbing noise or noise nuisance caused by rail vehicles or aircraft which are not used as recreational vehicles;

(d): before changes are made to existing facilities or existing uses of land or buildings, or before new buildings are erected, in writing require that noise impact assessments or tests are conducted to the satisfaction of that local authority by the owner, developer, tenant or occupant of the facilities, land or buildings or that, for the purposes of regulation 3(b) or (f) designate a controlled area in its area of jurisdiction or amend or cancel an existing controlled area by notice in the Official Gazette concerned.

In terms of Regulation 4 of the Noise Control Regulations:

"No person shall make, produce or cause a disturbing noise, or allow it to be made, produced or caused by any person, machine, device or apparatus or any combination thereof".

General prohibition

3. No person shall -

(c) make changes to existing facilities or existing uses of land or buildings or erect new buildings, if it shall in the opinion of a local authority house or cause activities which shall, after such change or erection, cause a disturbing noise, unless precautionary measures to prevent the disturbing noise have been taken to the satisfaction of the local authority;

Clause 7.(1) however exempts noise of the following activities, namely -

"The provisions of these regulations shall not apply, if -

(a) the emission of sound is for the purposes of warning people of a dangerous situation;

(b) the emission of sound takes place during an emergency."

3.3 THE NATIONAL ENVIRONMENTAL MANAGEMENT ACT (ACT 107 OF 1998)

The National Environmental Management Act ("NEMA") defines "pollution" to include any change in the environment, including noise. A duty therefore arises under section 28 of NEMA to take reasonable measures while establishing and operating any facility to prevent

noise pollution occurring. NEMA sets out measures, which may be regarded as reasonable. They include the following measures:

1. to investigate, assess and evaluate the impact on the environment
2. to inform and educate employees about the environmental risks of their work and the manner in which their tasks must be performed to avoid causing significant pollution or degradation of the environment
3. to cease, modify or control any act, activity or process causing the pollution or degradation
4. to contain or prevent the movement of the pollution or degradation
5. to eliminate any source of the pollution or degradation
6. to remedy the effects of the pollution or degradation

In addition, a number of regulations have been promulgated as Regulation 982 of December 2014 (Government Notice 38282) in terms of this Act. It defines minimum information requirements for specialist reports, with Government Gazette (GG) 43110 (20 March 2020) updating the minimum requirements for reporting, with this protocol referred as GNR320 of 2020.

GNR320 prescribe general requirements for undertaking site sensitivity verification and for protocols for the assessment and minimum report content requirements of environmental impacts for environmental themes for activities requiring environmental authorisation. These protocols were promulgated in terms of sections 24(5)(a), (h) and 44 of the NEMA.

When the requirements of a protocol apply, the requirements of Appendix 6 of the Environmental Impact Assessment Regulations, as amended, (EIA Regulations), promulgated under sections 24(5) and 44 of the NEMA are replaced by these requirements.

3.4 NOISE STANDARDS

There are a few South African scientific standards (SABS) relevant to noise from developments, industry and roads. They are:

- SANS 10103:2008. 'The measurement and rating of environmental noise with respect to annoyance and to speech communication' [**111**].
- SANS 10210:2004. 'Calculating and predicting road traffic noise' [**113**].
- SANS 10328:2008. 'Methods for environmental noise impact assessments' [**114**].
- SANS 10357:2004. 'The calculation of sound propagation by the Concave method' [**115**].

- SANS 10181:2003. 'The Measurement of Noise Emitted by Road Vehicles when Stationary' [112].

The relevant standards use the equivalent continuous rating level (calculated from the sound pressure levels over the reference time, see [Appendix A](#)) as a basis for determining what is acceptable. The levels may take single event noise into account, but single event noise by itself does not determine whether noise levels are acceptable for land use purposes. With regards to SANS 10103:2008, the recommendations are likely to inform decisions by authorities, but non-compliance with the standard will not necessarily render an activity unlawful *per se*.

3.5 INTERNATIONAL GUIDELINES

While a number of international guidelines and standards exists, those selected below are used by numerous countries for environmental noise management.

3.5.1 Guidelines for Community Noise (WHO, 1999) [141]

The World Health Organization's (WHO) document on the *Guidelines for Community Noise* is the outcome of the WHO expert task force meeting held in London, United Kingdom, in April 1999 [141]. It is based on the document entitled "Community Noise" that was prepared for the WHO and published in 1995 by the Stockholm University and Karolinska Institute.

The scope of WHO's effort to derive guidelines for community noise is to consolidate actual scientific knowledge on the health impacts of community noise and to provide guidance to environmental health authorities and professionals trying to protect people from the harmful effects of noise in non-industrial environments. It discusses the specific effects of noise on communities including:

- Interference with communication, noise-induced hearing impairment, sleep disturbance effects, cardiovascular and psychophysiological effects, mental health effects, effects on performance, annoyance responses and effects on social behavior.

It further discusses how noise can affect (and propose guideline noise levels) specific environments such as residential dwellings, schools, preschools, hospitals, ceremonies, festivals and entertainment events, sounds through headphones, impulsive sounds from toys, fireworks and firearms, and parklands and conservation areas.

To protect the majority of people from being affected by noise during the daytime, it proposes that sound levels at outdoor living areas should not exceed 55 dB L_{Aeq} for a steady, continuous noise. To protect the majority of people from being moderately annoyed during the day, the outdoor sound pressure level should not exceed 50 dB L_{Aeq} . At night, equivalent sound levels at the outside façades of the living spaces should not exceed 45 dBA and 60 dBA L_{Amax} so that people may sleep with bedroom windows open. It is critical to note that this guideline requires the sound level measuring instrument to be set on the “fast” detection setting.

3.5.2 Night Noise Guidelines for Europe (WHO, 2009) [142]

Refining previous Community Noise Guidelines issued in 1999, and incorporating more recent research, the WHO has released a comprehensive report on the health effects of night time noise, along with new (non-mandatory) guidelines for use in Europe (WHO, 2009) [142]. Rather than a maximum of 30 dB inside at night (which equals 45-50 dB max outside), the WHO now recommends a maximum year-round outside night-time noise average of 40 db to avoid sleep disturbance and its related health effects. The report notes that only below 30 dB (outside annual average) are “*no significant biological effects observed,*” and that between 30 and 40 dB, several effects are observed, with the chronically ill and children being more susceptible; however, “*even in the worst cases the effects seem modest.*” Elsewhere, the report states more definitively, “*There is no sufficient evidence that the biological effects observed at the level below 40 dB (night, outside) are harmful to health.*” At levels over 40 dB “*Adverse health effects are observed*” and “*many people have to adapt their lives to cope with the noise at night. Vulnerable groups are more severely affected.*”

The 184-page report offers a comprehensive overview of research into the various effects of noise on sleep quality and health (including the health effects of non-waking sleep arousal), and is recommended reading for anyone working with noise issues. The use of an outdoor noise standard is in part designed to acknowledge that people do prefer to leave windows open when sleeping, though the year-long average may be difficult to obtain (it would require longer-term sound monitoring than is usually budgeted for by either industry or neighbourhood groups).

While recommending the use of the average level, the report notes that some instantaneous effects occur in relation to specific maximum noise levels, but that the health effects of these “cannot be easily established.”

3.5.3 The Assessment and Rating of Noise from Wind Farms (Energy Technology Support Unit, 1997)

This report describes the findings of a Working Group on Wind Turbine Noise, facilitated by the United Kingdom Department of Trade and Industry (ETSU, 1997) [43]. It was developed as an Energy Technology Support Unit⁶ (ETSU) project. The aim of the project was to provide information and advice to developers and planners on noise from wind turbines. The report represents the consensus view of a number of experts (experienced in assessing and controlling the environmental impact of noise from wind farms). Their findings can be summarised as follows:

1. Absolute noise limits applied at all wind speeds are not suited to wind farms; limits set relative to the background noise (including wind as seen in **Figure 4-3**) are more appropriate;
2. $L_{A90,10\text{mins}}$ is a much more accurate descriptor when monitoring ambient and turbine noise levels;
3. The effects of other wind turbines in a given area⁷ should be added to the effect of any proposed Wind Farm (WF), to calculate the cumulative effect;
4. Noise from a WF should be restricted to no more than 5 dBA above the current ambient noise level at a Noise Sensitive Receptor(s) (NSR). Ambient noise levels are measured onsite in terms of the $L_{A90,10\text{min}}$ descriptor for a period sufficiently long enough for a set period;
5. Wind farms should be limited within the range of 35 dBA to 40 dBA (day-time) in a low noise environment. A fixed limit of 43 dBA should be implemented during all night time noise environments. This should increase to 45 dBA (day and night) if the NSR has financial investments in the WF; and
6. A penalty system should be implemented for wind turbine/s that operates with a tonal characteristic.

While this guideline may be 25 years old, planning policy in England, Scotland, Wales and Northern Ireland still refer to the ETSU-R97 for guidance on the assessment of wind turbine noise (Cooper, 2020) [22], (EPA, 2011) [42], (IOA, 2013) [65], (The Scottish Government, 2011) [127], (UK Department for Communities and Local Government, 2013) [130]. In Australia and New Zealand, ETSU-R-97 has been adopted as the base assessment method

⁶ ETSU was set up in 1974 as an agency by the United Kingdom Atomic Energy Authority to manage research programmes on renewable energy and energy conservation. The majority of projects managed by ETSU were carried out by external organizations in academia and industry. In 1996, ETSU became part of AEA Technology plc which was separated from the UKAEA by privatisation.

⁷ Though the area has not been defined, it is the opinion of the author that this would be within the potential area of effect, defined as 2,000m in SANS 10328:2008. Considering that WTG from two adjacent WEFs may have a slight influence at 2,000m, this area typically would be a maximum of 4,000m from two or more WEFs

of assessment (Cooper, 2020) [22], (EPA, 2009) [41]. The ETSU-R97 is referenced in NARUC (2011) [89] as well as the recommended method in IFC (2015) [64]. Because of its international importance, the methodologies used in the ETSU R97 document will be considered in this report for implementation should projected noise levels (from the proposed WFs at NSR) exceed the zone sound levels as recommended by SANS 10103:2008.

3.5.4 Noise Guidelines for Wind Farms (MoE, 2008) [87]

This document establishes the sound level limits for land-based wind power generating facilities and describes the information required for noise assessments and submissions under the ECA and the Environmental Protection Act, Canada.

The document defines:

- Sound Level Limits for different areas (similar to rural and urban areas), defining limits for different wind speeds at 10 m height, refer also **Table 3-1**⁸
- The Noise Assessment Report, including:
 - Information that must be part of the report;
 - Full description of noise sources;
 - Adjustments, due to the wind speed profile (wind shear);
 - The identification and defining of potential sensitive receptors;
 - Prediction methods to be used (ISO 9613-2);
 - Cumulative impact assessment requirements;
 - It also defines specific model input parameters;
 - Methods on how the results must be presented; and
 - Assessment of Compliance (defining magnitude of noise levels).

Table 3-1: Summary of Sound Level Limits for Wind Farms (MoE)

Wind speed (m/s) at 10 m height	4	5	6	7	8	9	10
Wind Turbine Sound Level Limits, Class 3 Area, dBA	40	40	40	43	45	49	51
Wind Turbine Sound Level Limits, Class 1 & 2 Areas, dBA	45	45	45	45	45	49	51

The document used the $L_{Aeq,1h}$ noise descriptor to define noise levels.

⁸The measurement of wind induced background sound level is not required to establish the applicable limit. The wind induced background sound level reference curve was determined by correlating the A-weighted ninetieth percentile sound level (L90) with the average wind speed measured at a particularly quiet site. The applicable Leq sound level limits at higher wind speeds are given by adding 7 dB to the wind induced background L90 sound level reference values

It should be noted that these Sound Level Limits are included for the reader to illustrate the criteria used internationally. Due to the lack of local regulations specifically relevant to WFs this criterion will also be considered during the determination of the significance of the noise impact.

3.5.5 Equator Principles

The **Equator Principles** (EPs) are a voluntary set of standards for determining, assessing and managing social and environmental risk in project financing. Equator Principles Financial Institutions (EPFIs) commit to not providing loans to projects where the borrower will not or is unable to comply with their respective social and environmental policies and procedures that implement the EPs.

The Equator Principles were developed by private sector banks and were launched in June 2003. Revision III of the EPs has been in place since June 2013. As of March 2021, 116 financial institutions in 37 countries have officially adopted the Equator Principles, covering the majority of international project finance debt in emerging and developed markets.

The participating banks chose to model the Equator Principles on the environmental standards of the World Bank (1999) and the social policies of the International Finance Corporation (IFC). As of beginning 2022:

- More than 90 banks and financial institutions have voluntarily adopted the Equator Principles, which are based on IFC's Performance Standards⁹.
- 32 export credit agencies of the Organization of Economic Co-operation and Development countries benchmark private sector projects against IFC's Performance Standards.
- The Multilateral Investment Guarantee Agency applies IFC's Performance Standards in its operations.
- The World Bank applies IFC's Performance Standards (known as World Bank Performance Standards) to projects supported by IBRD/IDA (International Bank for Reconstruction and Development/International Development Association) that are owned, constructed and/or operated by the private sector.

3.5.6 IFC: General EHS Guidelines – Environmental Noise Management [63]

These guidelines are applicable to noise created beyond the property boundaries of a development that conforms to the Equator Principles. The environmental standards of the

9

https://www.ifc.org/wps/wcm/connect/topics_ext_content/ifc_external_corporate_site/sustainability-at-ifc/policies-standards/performance-standards/performance-standards

World Bank have been integrated into the social policies of the IFC since April 2007 as the IFC Environmental, Health and Safety (EHS) Guidelines.

Document 1.7¹⁰ of the IFC: General EHS Guidelines states that noise prevention and mitigation measures should be applied where predicted or measured noise impacts from project facilities/operations exceed the applicable noise level guideline at the most sensitive point of reception. The preferred method for controlling noise from stationary sources is to implement noise control measures at source. It goes as far as to proposed methods for the prevention and control of noise emissions, including:

- Selecting equipment with lower sound power levels;
- Installing silencers for fans;
- Installing suitable mufflers on engine exhausts and compressor components;
- Installing acoustic enclosures for equipment casing radiating noise;
- Improving the acoustic performance of constructed buildings, apply sound insulation;
- Installing acoustic barriers without gaps and with a continuous minimum surface density of 10 kg/m² in order to minimize the transmission of sound through the barrier. Barriers should be located as close to the source or to the receptor location to be effective;
- Installing vibration isolation for mechanical equipment;
- Limiting the hours of operation for specific pieces of equipment or operations, especially mobile sources operating through community areas;
- Re-locating noise sources to less-sensitive areas to take advantage of distance and shielding;
- Placement of permanent facilities away from community areas if possible;
- Taking advantage of the natural topography as a noise buffer during facility design;
- Reducing project traffic routing through community areas wherever possible;
- Planning flight routes, timing and altitude for aircraft (airplane and helicopter) flying over community areas; and
- Developing a mechanism to record and respond to complaints.

It sets noise level guidelines (see **Table 3-2**) and highlights certain monitoring requirements pre- and post-development. It adds another criterion in that the existing background ambient noise level should not rise by more than 3 dBA. This criterion will effectively sterilize large areas of any development. Therefore, it is EARE's considered opinion that this criterion was introduced to address cases where the existing ambient noise level is already at, or in excess of the recommended limits.

¹⁰ <https://www.ifc.org/wps/wcm/connect/4a4db1c5-ee97-43ba-99dd-8b120b22ea32/1-7%2BNoise.pdf?MOD=AJPERES&CVID=nPtgwZY>

Table 3-2: IFC Table 7.1-Noise Level Guidelines

Receptor type	One-hour L_{Aeq} (dBA)	
	Daytime 07:00 - 22:00	Night-time 22:00 - 07:00
Residential; institutional; educational	55	45
Industrial; commercial	70	70

The document uses the $L_{Aeq,1hr}$ noise descriptors to define noise levels. It does not determine the detection period, but refers to the IEC standards, which requires the fast detector setting on the Sound Level Meter during measurements in Europe.

3.5.7 European Parliament Directive 2000/14/EC [36]

Directive 2000/14/EC relating to the noise emission in the environment by equipment for use outdoors was adopted by the European Parliament and the Council and first published in May 2000 and applied from 3 January 2002. The directive placed sound power limits on equipment to be used outdoors in a suburban or urban setting. Failure to comply with these regulations may result in products being prohibited from being placed on the EU market. Equipment list is vast and includes machinery such as compaction machineries, dozers, dumpers, excavators, etc. Manufacturers as a result started to consider noise emission levels from their products to ensure that their equipment will continue to have a market in most countries.

3.5.8 Environmental, Health, and Safety Guidelines for Wind Energy [64]

The EHS Guidelines for wind energy include information relevant to environmental, health, and safety aspects of onshore and offshore wind energy facilities. It should be applied to wind energy facilities from the earliest feasibility assessments, as well as from the time of the environmental impact assessment, and continue to be applied throughout the construction and operational phases.

It provides a brief overview of construction and operational noises, potential operational mitigation measures and a number of principles on the assessment of noise impacts, including:

- Receptors should be chosen according to their environmental sensitivity (human, livestock, or wildlife);
- Preliminary modeling should be carried out to determine whether more detailed investigation is warranted. The preliminary modeling can be as simple as assuming hemispherical propagation (i.e., the radiation of sound, in all directions, from a source point). Preliminary modeling should focus on sensitive receptors within 2,000 meters (m) of any of the turbines in a wind energy facility;

- If the preliminary model suggests that turbine noise at all sensitive receptors is likely to be below an L_{A90} of 35 dBA at a wind speed of 10 meters/second (m/s) at 10 m height during day and night times, then this preliminary modeling is likely to be sufficient to assess noise impact; otherwise it is recommended that more detailed modeling be carried out, which may include background ambient noise measurements;
- All modeling should take account of the cumulative noise from all wind energy facilities in the vicinity having the potential to increase noise levels;
- If noise criteria based on ambient noise are to be used, it is necessary to measure the background noise in the absence of any wind turbines. This should be done at one or more noise-sensitive receptors. Often the critical receptors will be those closest to the wind energy facility, but if the nearest receptor is also close to other significant noise sources, an alternative receptor may need to be chosen; and
- The background noise should be measured over a series of 10-minute intervals, using appropriate wind screens. At least five of these 10-minute measurements should be taken for each integer wind speed from cut-in speed to 12 m/s.

3.5.9 Environmental Noise Guidelines for the European Region (2018) [143]

This document identifies levels at which noise has “adverse health effects” and recommends actions to reduce exposure. Compared to previous WHO guidelines on noise, this version contains five significant developments:

- Stronger evidence of the cardiovascular and metabolic effects of environmental noise;
- Inclusion of new noise sources, namely wind turbine noise and leisure noise, in addition to noise from transportation (aircraft, rail, and road traffic);
- Use of a standardized approach to assess the evidence;
- A systematic review of evidence, defining the relationship between noise exposure and risk of adverse health outcomes;
- Use of long-term average noise exposure indicators to better predict adverse health outcomes.

The WHO (2018) considers adverse health effects in **section 2.4.3.2** of the report, dividing these effects into the following health outcomes:

- Cardiovascular disease – Ischaemic heart disease and hypertension;
- Cognitive impairment – Reading and oral comprehension;
- Permanent hearing impairment; and
- Self-reported sleep disturbance and annoyance.

While the WHO (2018) highlights that there is insufficient evidence of adverse health effects at noise levels below 40 dBA L_{night} , adverse health effects were reported at levels starting from 40 dB L_{night} . At 40 dB, about 3–4% of the population still reported being highly sleep-disturbed due to noise, which was considered relevant to health. It recommends that the guideline level should minimise adverse health effects to less than:

- 3% of the population experiencing sleep disturbances; and
- 10% of the population being highly annoyed.

This report recommends, that, for average noise exposure, the WHO Guideline Development Group conditionally recommends reducing noise levels produced by wind turbines below 45 dB L_{den} ¹¹, as wind turbine noise above this level is associated with adverse health effects.

3.5.10 Concluding remarks on the use of International Guidelines in this Assessment

As highlighted in **section 6.4**, South African guidelines (such as SANS 10103) or regulations (such as GNR.154 of 1992), does not cater for instances when background noise levels change due to the impact of external forces (such as the influence of increased winds). As such this report considers both local legislation, regulations and guidelines as well as international guidelines. Of the more than 340,000 WTG operation in the rest of the world (more than 2,000 wind farms), less than 500 WTG are currently operational in South Africa (36 wind farms). The rest of the world have had experience with the effects and impacts of wind farms since 1980, South Africa since 2002.

As such, almost all the scientific articles, papers, publications and presentations available are based on the research and experiences gained from these international wind farms. Therefore, discarding the knowledge and experiences gained by the rest of the world would be irresponsible and unwise. In summary:

- The WHO Guidelines for Community Noise recommends that night-time equivalent sound levels (at the outside façades of the living spaces) not exceed 45 dBA with L_{Amax} less than 60 dBA so that people may sleep with bedroom windows open **(Section 3.5.1)**;
- The Night Noise Guidelines for Europe revised noise levels, recommending a maximum year-round outside night-time noise average of 40 dB to avoid sleep disturbance and its related health effects **(Section 3.5.2)**;

¹¹ Day-evening-night noise level is a European standard to express noise level over an entire day. It imposes a penalty on sound levels during evening and night and it is primarily used for noise assessments of airports, busy main roads, main railway lines and in cities over 100,000 residents. This equates to a night-time equivalent noise level of approximately 38.7 dBA.

- The ETSU-R97 guideline recommends an upper noise limit of 45 dBA for project participants, and a noise limit of 40 dBA for external parties (**Section 3.5.3**);
- The MoE guideline propose a changing noise limit at different wind speeds for wind farm developments, varying from 40 dBA (at a wind speed of 4 m/s) to a maximum of 51 dBA (at a wind speed of 10 m/s or more) (**Section 3.5.4**);
- The environmental standards of the World Bank have been integrated into the social policies of the IFC since April 2007, with the guidelines recommending a night-time noise limit of 45 dBA (**Section 3.5.6**);
- The European Directives does not set noise limits, but it obligate equipment manufacturers to define and indicate the sound power emission levels of their equipment. When presented with a number of equipment options, applicants can use this data to select the quietest piece of equipment, in such to minimize noise levels (**Section 3.5.7**);
- While the IFC EHS Guidelines for Wind Energy does not stipulate specific noise limits, it does recommend the measurement of ambient sound levels at different speeds (referring to the ETSU-R97 guidelines discussed in **Section 3.5.3** should noise criteria based on ambient sound levels be used (**Section 3.5.8**); and
- The Environmental Noise Guidelines for the European Region report recommends that, for average noise exposure, noise levels produced by wind turbines should remain below 45 dBA L_{den} (an L_{Aeq} of ± 38.7 dBA at night) (**Section 3.5.9**).

As WTGs only operate during a period with wind speeds are elevated, a period that generally coincide with increased noise levels (due to wind-induced noises – “WIN”) this report recommends an upper noise limit of 45 dBA (focusing on the night-time period), at the same time considering the international recommended levels (as further motivated in **sections 6.4.1** and **6.4.3**) and summarized in **Table 6-2**.

4 CURRENT ENVIRONMENTAL SOUND CHARACTER

4.1 INFLUENCE OF SEASON ON AMBIENT SOUND LEVELS

Natural sounds are a part of the environmental noise surrounding humans. In rural areas the sounds from insects and birds would dominate the ambient sound character, with noises such as wind flowing through vegetation increasing as wind speed increase. Work by Fégeant (2002) [46] stressed the importance of wind speed and turbulence causing variations in the level of vegetation-generated noise. In addition, factors such as the season (e.g., dry or no leaves versus green leaves), the type of vegetation (e.g., grass, conifers, deciduous), the vegetation density and the total vegetation surface all determine both the sound level as well as spectral characteristics.

Ambient sound levels are significantly affected by the area where the sound measurement location (or a listener) is situated. When the sound measurement location is situated within an urban area, close to industrial plants or areas with a constant sound source (ocean, rivers, etc.), seasons and even increased wind speeds have an insignificant to massive impact on ambient sound levels.

Sound levels in undeveloped rural areas (away from occupied dwellings), however, are impacted by changes in season for a number of complex reasons. The two main reasons are:

- Faunal communication is more significant during the warmer spring and summer months as various species communicate in an effort to find mates. Faunal communication is normally less during the colder months.
- Seasonal changes in weather patterns, mainly due to increased wind speeds (also see **Sub Section 4.1.1** below) and potential gustiness of the wind.

For environmental noise, weather plays an important role, the greater the separation distance, the greater the influence of the weather conditions, so, from day to day, a road 1,000 m away can sound very loud or can be completely inaudible. Other, environmental factors that impact on sound propagation includes wind, temperature and humidity, as discussed in the sub-sections below.

Ambient sound levels are generally less during the colder months (due to less faunal communication) and higher during the warmer months.

4.1.1 Effect of Wind

Wind alters sound propagation by the mechanism of refraction, that is, wind bends sound waves. Wind nearer to the ground moves more slowly than wind at higher altitudes, due to surface characteristics such as hills, trees, and man-made structures that interfere with the wind. This wind gradient, with faster wind at higher elevation and slower wind at lower elevation, causes sound waves to bend downward when they are traveling to a location downwind of the source and to bend upward when traveling toward a location upwind of the source. Waves bending downward means that a listener standing downwind of the source will hear louder noise levels than the listener standing upwind of the source. This phenomenon can significantly impact sound propagation over long distances and when wind speeds are high. Over short distances wind direction has a small impact on sound propagation as long as wind velocities are reasonably slow, i.e., less than 5 m/s.

Wind speed frequently plays a role in increasing sound levels in natural locations. With no wind, there is little vegetation movement that could generate noises and faunal noises (normally birds and insects) dominate, however, as wind speeds increase, the rustling of leaves increases which subsequently can increase sound levels. This directly depends on the type of vegetation in a certain area. The impact of increased wind speed on sound levels depends on the vegetation type (deciduous versus conifers), the density of vegetation in an area, seasonal changes (in winter deciduous trees are bare) as well as the height of this vegetation. This excludes unanticipated consequences, as suitable vegetation may create suitable habitats and food sources attracting birds and insects (and the subsequent increase in faunal communication).

4.1.2 Effect of Humidity and Temperature

On a typical sunny afternoon, the air is the hottest near the ground surface and temperature decreases at higher altitudes. This temperature gradient causes sound waves to refract upward, away from the ground and results in lower noise levels being heard at a measurement location. In the evening, this temperature gradient will reverse, resulting in cooler temperatures near the ground. This condition, often referred to as a temperature inversion will cause sound to bend downward towards the ground and results in louder noise levels at the listener position. Like wind gradients, temperature gradients can influence sound propagation over long distances, complicate sound level measurements as well as propagation modelling.

Generally, sound propagate better at lower temperatures (down to 10°C), and with everything being equal, a decrease in temperature from 32°C to 10°C could increase the sound level at a listener 600 m away by ± 2.5 dB (at 1,000 Hz).

The effect of humidity on sound propagation is quite complex, but effectively relates to how increased humidity changes the density of air. Lower density translates into faster sound wave travel, so sound waves travel faster at high humidity. With everything being equal, an increase in humidity from 20% to 80% would increase the sound level at a listener 600 m away by ± 4 dB (at 1,000 Hz at 20°C).

Together, the impact of temperature and humidity (together with air pressure - to a minor extent) are complex and highly dependent on the frequency composition of the noise. This is illustrated in **Figure 4-1**.

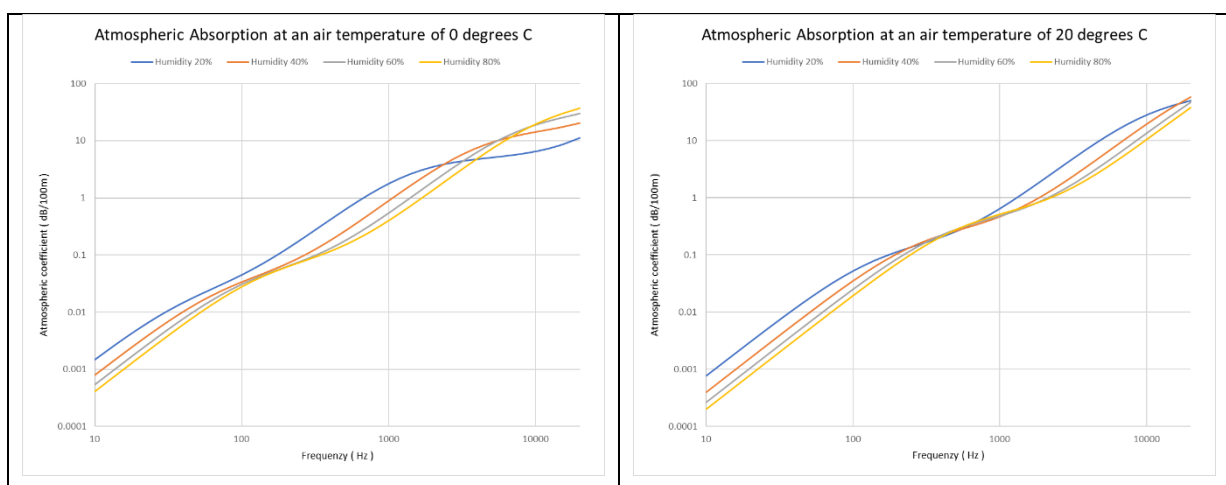

Figure 4-1: Effect of Temperature and Humidity on propagation of Sound

4.2 AMBIENT SOUND LEVEL MEASUREMENTS

Dracoulides (2010 [37]) did collect a number of measurements at location MP04 (see **Figure 4-2**) over two nights, each night taking the measurements at three different times in compliance with the requirements of GNR 320 of 2020. Additional ambient sound level measurements were therefore not collected for this report, as the measurements collected during 2, 3 and 4 May 2010 is considered sufficient for this assessment. Based on aerial images, there has been little urban development in the last decade and it is expected that the ambient sound levels would be similar.

The author also has significant additional ambient sound level data, collected in areas with similar developmental character as illustrated in **Figure 4-3** and **Figure 4-4**. This data, as well as the data collected by Dracoulides (2010 [37]) will be used to define acceptable rating levels (noise limits) as discussed in **section 6.4** (Setting appropriate Noise Limits).

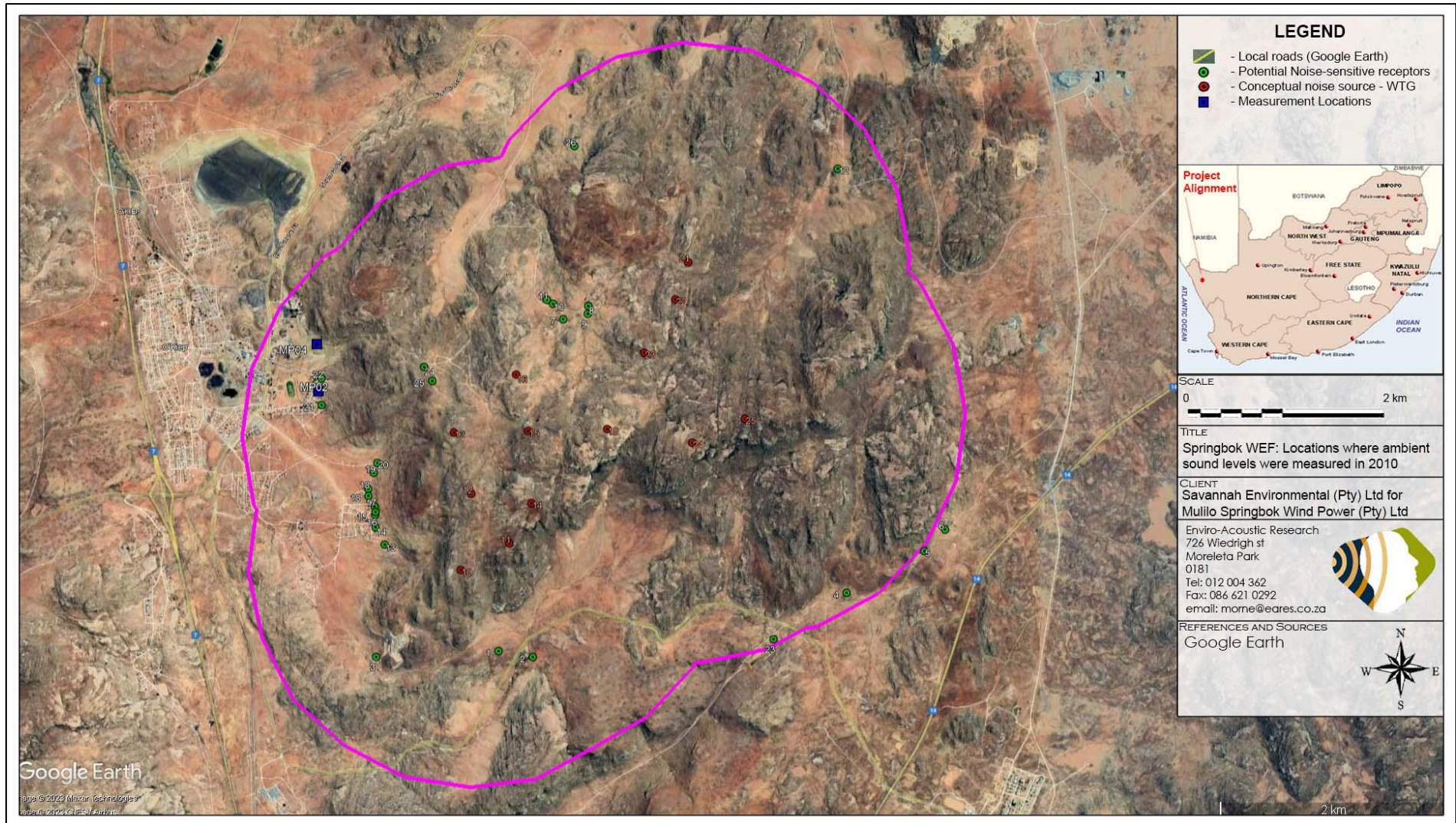

Figure 4-2: Localities where ambient sound levels were measured by Dracouliles in 2010

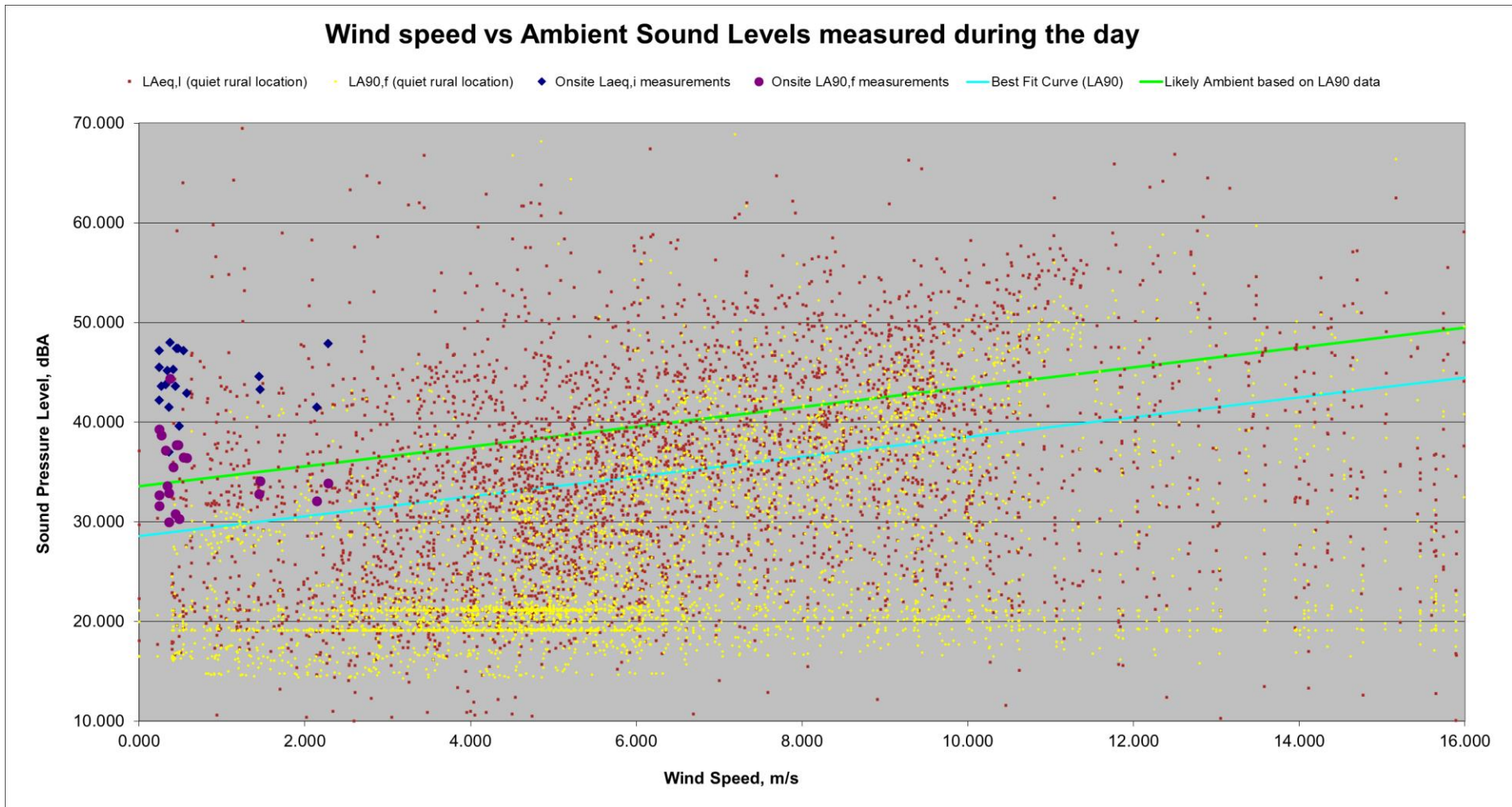

Figure 4-3: Daytime ambient sound levels measured in vicinity of project¹²

¹² Wind speed levels randomized (between 0 and 0.5 m/s) to improve discernability slightly. This will not influence the assessment or findings.

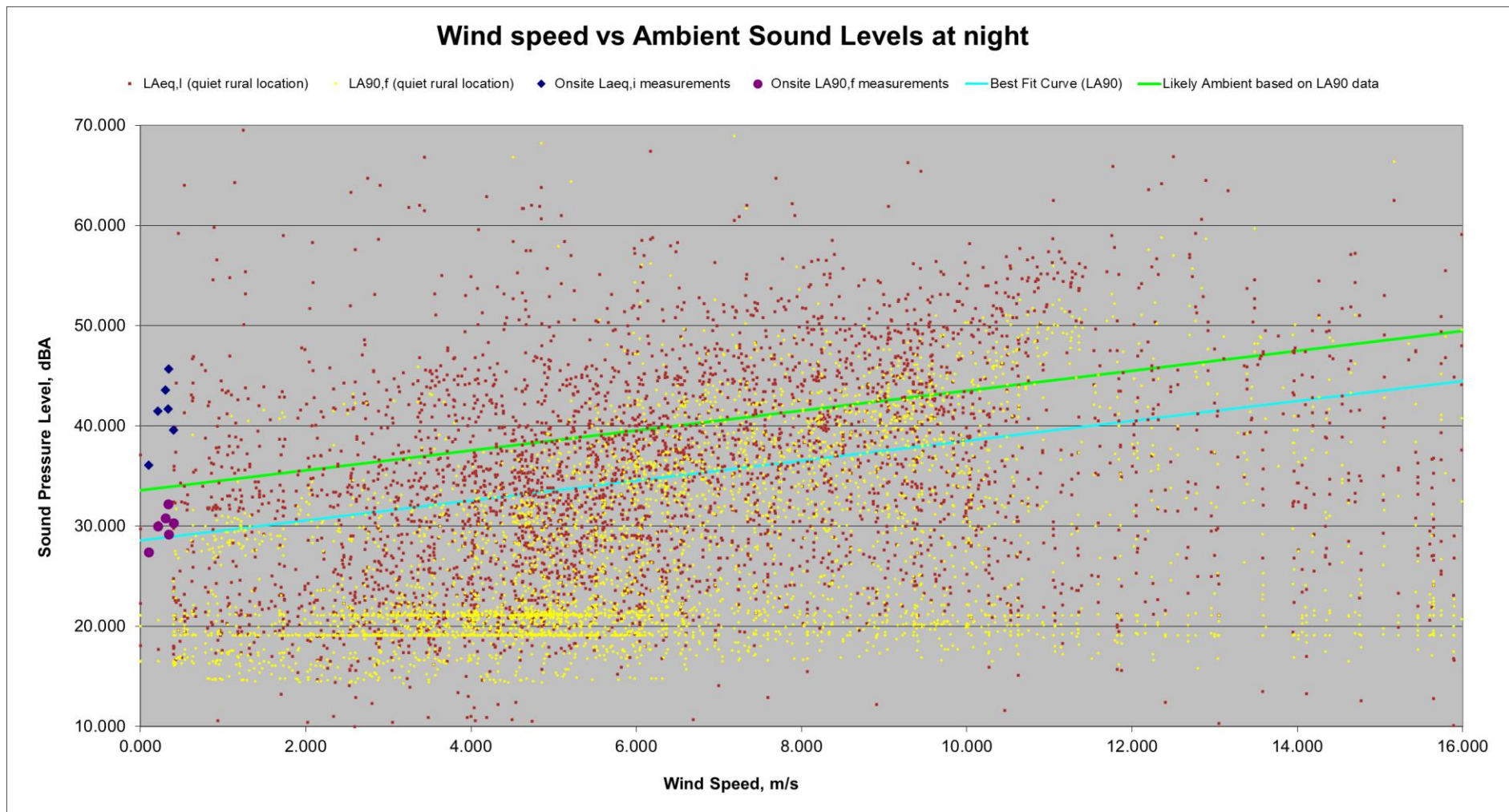

Figure 4-4: Night-time ambient sound levels measured in vicinity of project¹³

¹³ Wind speed levels randomized (between 0 and 0.5 m/s) to improve discernability slightly. This will not influence the assessment or findings.

5 INVESTIGATION OF EXISTING AND FUTURE NOISE LEVELS

Increased noise levels are directly linked with the various activities associated with the construction of the proposed Project and related infrastructure, as well as the operation phase of the activity. The potential noise impacts from the activities associated with these phases are discussed in the following sections.

5.1 POTENTIAL NOISE SOURCES: CONSTRUCTION PHASE

5.1.1 Construction equipment

It is estimated that construction will take approximately 24 - 30 months subject to the final design of the Project, weather and ground conditions, including time for testing and commissioning. The construction process will consist of the following principal activities:

- Site survey and preparation;
- Establishment of site entrance, internal access roads, contractors' compound and passing places;
- Civil works to sections of the public roads to facilitate with WTG component delivery;
- Site preparation activities will include clearance of vegetation at the footprint of each turbine as well as crane hard-standing areas. These activities will require the stripping of topsoil which will need to be stockpiled, backfilled and/or spread on site;
- Construct foundations – due to the volume of concrete that will be required, an on-site batching plant will be required to ensure a continuous concreting operation. The source of aggregate is yet undefined but is expected to be derived from an offsite source or brought in as ready-mix.
- Transport of components & equipment to site – all components will be brought to site in sections by means of flatbed trucks. Additionally, components of various specialized construction and lifting equipment are required on site to erect the wind turbines and will need to be transported to site. The typical civil engineering construction equipment will need to be brought to the site for the civil works (e.g., excavators, trucks, graders, compaction equipment, cement trucks, etc.). The transportation of ready-mix concrete to site or the materials for onsite concrete batching will result in a temporary increase in heavy traffic (one turbine foundation may require up to 100 concrete trucks, and is undertaken as a continuous pour);
- Establishment of laydown & hard standing areas - laydown areas will need to be established at each turbine position for the placement of wind turbine components.

Laydown and storage areas will also be required to be established for the civil engineering construction equipment which will be required on site. Hard standing areas will need to be established for operation of the cranes. Cranes of the size required to erect turbines are sensitive to differential movement during lifting operations and require a hard-standing area;

- Erect turbines - a crane will be used to lift the tower sections into place and then the nacelle will be placed onto the top of the assembled tower. The next step will be to assemble or partially assemble the rotor on the ground; it will then be lifted to the nacelle and bolted in place. A small crane will likely be needed for the assembly of the rotor while the large crane will be needed to put it in place;
- Construct substation - the underground cables carrying the generated power from the individual turbines will connect at the substation. The construction of the substation would require a site survey; site clearing and levelling (including the removal / cutting of rock outcrops) and construction of access road/s (where required); construction of a substation terrace and foundation; assembly, erection and installation of equipment (including transformers); connection of conductors to equipment; and rehabilitation of any disturbed areas and protection of erosion sensitive areas;
- Establishment of ancillary infrastructure - A workshop as well as a contractor's equipment camp may be required. The establishment of these facilities/buildings will require the clearing of vegetation and levelling of the development site and the excavation of foundations prior to construction. A laydown area for building materials and equipment associated with these buildings will also be required; and
- Site rehabilitation - once construction is completed and all construction equipment are removed; the site will be rehabilitated where practical and reasonable.

There are a number of factors that determine the audibility as well as the potential of a noise impact on receptors. Maximum noises generated can be audible over a large distance, however, are generally of very short duration. If maximum noise levels however exceed 65 dBA at a receptor, or if it is clearly audible with a significant number of instances where the noise level exceeds the prevailing ambient sound level with more than 15 dB, the noise can increase annoyance levels and may ultimately result in noise complaints. Potential maximum noise levels generated by various construction equipment as well as the potential extent of these sounds are presented in **Table 5-2**.

Average or equivalent sound levels are another factor that impacts on the ambient sound levels and is the constant sound level that the receptor can experience. Typical sound power levels associated with various activities that may be found at a construction site is presented in **Table 5-3**.

The equipment likely to be required to complete the above tasks will typically include:

- excavator/graders, bulldozer(s), dump trucks(s), vibratory roller, bucket loader, rock breaker(s), drill rig, flatbed truck(s), pile drivers, TLB, concrete truck(s), crane(s), fork lift(s) and various 4WD and service vehicles.

Noise from the contractor’s camp will be minimal and will not influence the ambient sound levels in the surrounding area. The noise levels and the octave sound power emission levels used for modelling for the construction phase are highlighted in **Table 5-1**.

Table 5-1: Equipment list and Sound power emission levels used for modelling

Equipment	Sound power level, dB re1 pW, in octave band, Hz							SPL (dBA)
	Centre frequency	63	125	250	500	1000	2000	
Construction and WTG equipment and activities								
Bulldozer CAT D5	107.4	105.9	104.8	104.5	104.4	97.5	90.2	107.4
Diesel Generator (Large - mobile)	107.2	104.0	102.4	102.7	100.2	99.5	97.4	106.1
Excavator and truck	111.0	112.2	109.3	106.4	105.4	101.6	98.4	112.0
General noise (Construction)	95.0	100.0	103.0	105.0	105.0	100.0	100.0	113.6
Goldwind GW165-6.0 WTG	109.8	108.9	109.5	107.4	101.0	92.3	77.4	112.6
Nordex N163 5.X WTG	115.6	112.0	108.6	106.2	104.5	101.2	92.2	109.2
Road Transport Reversing/Idling	108.2	104.6	101.2	99.7	105.4	100.7	98.7	108.2
Vestas V162 6.0 MW WTG	106.6	105.7	104.3	102.2	99.3	95.5	90.2	104.3
Area noise sources (using the octave sound power characteristics of General Noise)								
General noise (dBA/m ² re 1 pW)	95.0	100.0	103.0	105.0	105.0	100.0	100.0	65.0

5.1.2 Material supply: Concrete batching plants

There exist mainly two options for the supply of the concrete to the development site. These options are:

1. The transport of “ready-mix” concrete from the closest centre to the development.
2. The transport of aggregate and cement from the closest centre to the development, with the establishment of a small concrete batching plant closer to the activities. This would most likely be a movable plant.

This noise study will consider the use of a concrete batching plant, though the infrastructure layout indicate that the batching plants are further than 1,000m from any NSR. Potential noise from this source will be minimal.

5.1.3 Blasting

Though unlikely, blasting may be required as part of the civil works to clear obstacles or to prepare foundations (of either the WEF, power pylons or other infrastructure).

However, blasting will not be considered for the following reasons:

- Blasting is highly regulated, and control of blasting to protect human health, equipment and infrastructure will ensure that any blasts will use minimum explosives and will occur in a controlled manner. The breaking of rocks and obstacles with explosives is also a specialized field, and when correct techniques are used, it causes less noise than using a rock-breaker.
- People are generally more concerned over ground vibration and air blast levels that might cause building damage than the impact of the noise from the blast.
- Blasts are an infrequent occurrence, with a loud but a relative instantaneous character. Potentially affected parties normally receive sufficient notice (siren), and the knowledge that the duration of the siren noise as well as the blast will be over relatively fast, resulting in a higher acceptance of the noise.

5.1.4 Construction Traffic

The last potential significant source of noise during the construction phase is additional traffic to and from the site, as well as traffic on the site.

Construction traffic is expected to be generated throughout the entire construction period, however, the volume and type of traffic generated will be dependent upon the construction activities being conducted, which will vary during the construction period. Noise levels due to traffic were estimated using the methodology stipulated in SANS 10210:2004 (Calculating and predicting road traffic noise). Traffic volumes were estimated using up to 10 trucks and cars each, travelling on a gravel road at 40 km/hr, as well as a surfaced road at 80 km/hr.

Table 5-2: Potential maximum noise levels generated by construction equipment

Equipment Description ¹⁴	Impact Device?	Maximum Sound Power Levels (dBA)	Operational Noise Level at given distance considering potential maximum noise levels (Cumulative as well as the mitigatory effect of potential barriers or other mitigation not included – simple noise propagation modeling only considering distance) (dBA)											
			5 m	10 m	20 m	50 m	100 m	150 m	200 m	300 m	500 m	750 m	1000 m	2000 m
Auger Drill Rig	No	119.7	94.7	88.7	82.6	74.7	68.7	65.1	62.6	59.1	54.7	51.2	48.7	42.6
Backhoe	No	114.7	89.7	83.7	77.6	69.7	63.7	60.1	57.6	54.1	49.7	46.2	43.7	37.6
Chain Saw	No	119.7	94.7	88.7	82.6	74.7	68.7	65.1	62.6	59.1	54.7	51.2	48.7	42.6
Compactor (ground)	No	114.7	89.7	83.7	77.6	69.7	63.7	60.1	57.6	54.1	49.7	46.2	43.7	37.6
Compressor (air)	No	114.7	89.7	83.7	77.6	69.7	63.7	60.1	57.6	54.1	49.7	46.2	43.7	37.6
Concrete Batch Plant	No	117.7	92.7	86.7	80.6	72.7	66.7	63.1	60.6	57.1	52.7	49.2	46.7	40.6
Concrete Mixer Truck	No	119.7	94.7	88.7	82.6	74.7	68.7	65.1	62.6	59.1	54.7	51.2	48.7	42.6
Concrete Pump Truck	No	116.7	91.7	85.7	79.6	71.7	65.7	62.1	59.6	56.1	51.7	48.2	45.7	39.6
Concrete Saw	No	124.7	99.7	93.7	87.6	79.7	73.7	70.1	67.6	64.1	59.7	56.2	53.7	47.6
Crane	No	119.7	94.7	88.7	82.6	74.7	68.7	65.1	62.6	59.1	54.7	51.2	48.7	42.6
Dozer	No	119.7	94.7	88.7	82.6	74.7	68.7	65.1	62.6	59.1	54.7	51.2	48.7	42.6
Drill Rig Truck	No	118.7	93.7	87.7	81.6	73.7	67.7	64.1	61.6	58.1	53.7	50.2	47.7	41.6
Drum Mixer	No	114.7	89.7	83.7	77.6	69.7	63.7	60.1	57.6	54.1	49.7	46.2	43.7	37.6
Dump Truck	No	118.7	93.7	87.7	81.6	73.7	67.7	64.1	61.6	58.1	53.7	50.2	47.7	41.6
Excavator	No	119.7	94.7	88.7	82.6	74.7	68.7	65.1	62.6	59.1	54.7	51.2	48.7	42.6
Flat Bed Truck	No	118.7	93.7	87.7	81.6	73.7	67.7	64.1	61.6	58.1	53.7	50.2	47.7	41.6
Front End Loader	No	114.7	89.7	83.7	77.6	69.7	63.7	60.1	57.6	54.1	49.7	46.2	43.7	37.6
Generator	No	116.7	91.7	85.7	79.6	71.7	65.7	62.1	59.6	56.1	51.7	48.2	45.7	39.6
Generator (<25KVA)	No	104.7	79.7	73.7	67.6	59.7	53.7	50.1	47.6	44.1	39.7	36.2	33.7	27.6
Grader	No	119.7	94.7	88.7	82.6	74.7	68.7	65.1	62.6	59.1	54.7	51.2	48.7	42.6
Impact Pile Driver	Yes	129.7	104.7	98.7	92.6	84.7	78.7	75.1	72.6	69.1	64.7	61.2	58.7	52.6
Jackhammer	Yes	119.7	94.7	88.7	82.6	74.7	68.7	65.1	62.6	59.1	54.7	51.2	48.7	42.6
Man Lift	No	119.7	94.7	88.7	82.6	74.7	68.7	65.1	62.6	59.1	54.7	51.2	48.7	42.6
Mounted Impact Hammer	Yes	124.7	99.7	93.7	87.6	79.7	73.7	70.1	67.6	64.1	59.7	56.2	53.7	47.6

¹⁴ Equipment list and Sound Power Level source: http://www.fhwa.dot.gov/environment/noise/construction_noise/handbook/handbook09.cfm

Paver	No	119.7	94.7	88.7	82.6	74.7	68.7	65.1	62.6	59.1	54.7	51.2	48.7	42.6
Pickup Truck	No	89.7	64.7	58.7	52.6	44.7	38.7	35.1	32.6	29.1	24.7	21.2	18.7	12.6
Pumps	No	111.7	86.7	80.7	74.6	66.7	60.7	57.1	54.6	51.1	46.7	43.2	40.7	34.6
Rivit Buster/Chipping Gun	Yes	119.7	94.7	88.7	82.6	74.7	68.7	65.1	62.6	59.1	54.7	51.2	48.7	42.6
Rock Drill	No	119.7	94.7	88.7	82.6	74.7	68.7	65.1	62.6	59.1	54.7	51.2	48.7	42.6
Roller	No	119.7	94.7	88.7	82.6	74.7	68.7	65.1	62.6	59.1	54.7	51.2	48.7	42.6
Sand Blasting (single nozzle)	No	119.7	94.7	88.7	82.6	74.7	68.7	65.1	62.6	59.1	54.7	51.2	48.7	42.6
Scraper	No	119.7	94.7	88.7	82.6	74.7	68.7	65.1	62.6	59.1	54.7	51.2	48.7	42.6
Sheers (on backhoe)	No	119.7	94.7	88.7	82.6	74.7	68.7	65.1	62.6	59.1	54.7	51.2	48.7	42.6
Slurry Plant	No	112.7	87.7	81.7	75.6	67.7	61.7	58.1	55.6	52.1	47.7	44.2	41.7	35.6
Slurry Trenching Machine	No	116.7	91.7	85.7	79.6	71.7	65.7	62.1	59.6	56.1	51.7	48.2	45.7	39.6
Soil Mix Drill Rig	No	114.7	89.7	83.7	77.6	69.7	63.7	60.1	57.6	54.1	49.7	46.2	43.7	37.6
Tractor	No	118.7	93.7	87.7	81.6	73.7	67.7	64.1	61.6	58.1	53.7	50.2	47.7	41.6
Vacuum Excavator	No	119.7	94.7	88.7	82.6	74.7	68.7	65.1	62.6	59.1	54.7	51.2	48.7	42.6
Vacuum Street Sweeper	No	114.7	89.7	83.7	77.6	69.7	63.7	60.1	57.6	54.1	49.7	46.2	43.7	37.6
Ventilation Fan	No	119.7	94.7	88.7	82.6	74.7	68.7	65.1	62.6	59.1	54.7	51.2	48.7	42.6
Vibrating Hopper	No	119.7	94.7	88.7	82.6	74.7	68.7	65.1	62.6	59.1	54.7	51.2	48.7	42.6
Vibratory Concrete Mixer	No	114.7	89.7	83.7	77.6	69.7	63.7	60.1	57.6	54.1	49.7	46.2	43.7	37.6
Vibratory Pile Driver	No	129.7	104.7	98.7	92.6	84.7	78.7	75.1	72.6	69.1	64.7	61.2	58.7	52.6
Warning Horn	No	119.7	94.7	88.7	82.6	74.7	68.7	65.1	62.6	59.1	54.7	51.2	48.7	42.6
Welder/Torch	No	107.7	82.7	76.7	70.6	62.7	56.7	53.1	50.6	47.1	42.7	39.2	36.7	30.6

Table 5-3: Potential equivalent noise levels generated by various equipment

Equipment Description	Equivalent (average) Sound Levels (dBA)	Operational Noise Level at given distance considering equivalent (average) sound power emission levels (Cumulative as well as the mitigatory effect of potential barriers or other mitigation not included – simple noise propagation modelling only considering distance) (dBA)											
		5 m	10 m	20 m	50 m	100 m	150 m	200 m	300 m	500 m	750 m	1000 m	2000 m
Air compressor	92.6	67.6	61.6	55.5	47.6	41.6	38.0	35.5	32.0	27.6	24.1	21.6	15.5
Bulldozer CAT D10	111.9	86.9	80.9	74.9	66.9	60.9	57.4	54.9	51.3	46.9	43.4	40.9	34.9
Cement truck (with cement)	111.7	86.7	80.7	74.7	66.7	60.7	57.2	54.7	51.2	46.7	43.2	40.7	34.7
Crane	107.5	82.5	76.5	70.5	62.5	56.5	53.0	50.5	46.9	42.5	39.0	36.5	30.5
Diesel Generator (Large - mobile)	106.1	81.2	75.1	69.1	61.2	55.1	51.6	49.1	45.6	41.2	37.6	35.1	29.1
Dumper/Haul truck - Terex 30 ton	112.2	87.2	81.2	75.2	67.2	61.2	57.7	55.2	51.7	47.2	43.7	41.2	35.2
Excavator - Hitachi EX1200	113.1	88.1	82.1	76.1	68.1	62.1	58.6	56.1	52.6	48.1	44.6	42.1	36.1
FEL (988) (FM)	115.6	90.7	84.6	78.6	70.7	64.6	61.1	58.6	55.1	50.7	47.1	44.6	38.6
General noise	108.8	83.8	77.8	71.8	63.8	57.8	54.2	51.8	48.2	43.8	40.3	37.8	31.8
Grader - Operational Hitachi	108.9	83.9	77.9	71.9	63.9	57.9	54.4	51.9	48.4	43.9	40.4	37.9	31.9
Road Truck average	109.6	84.7	78.7	72.6	64.7	58.7	55.1	52.6	49.1	44.7	41.1	38.7	32.6
Rock Breaker, CAT	120.7	95.7	89.7	83.7	75.7	69.7	66.2	63.7	60.2	55.7	52.2	49.7	43.7
Vibrating roller	106.3	81.3	75.3	69.3	61.3	55.3	51.8	49.3	45.8	41.3	37.8	35.3	29.3
Substation (one transformer)	85.2	60.3	54.2	48.2	40.3	34.2	30.7	28.2	24.7	20.3	16.7	14.2	8.2
Water Dozer, CAT	113.8	88.8	82.8	76.8	68.8	62.8	59.3	56.8	53.3	48.8	45.3	42.8	36.8
Wind Turbine: Acciona AW125/3000	108.5	83.5	77.5	71.5	63.5	57.5	54.0	51.5	48.0	43.5	40.0	37.5	31.5
Wind Turbine: Goldwind GW165 6.0	112.6	87.6	81.6	75.6	67.6	61.6	58.1	55.6	52.1	47.6	44.1	41.6	35.6
Wind Turbine: Nordex N163 / 5.X	109.2	84.2	78.2	72.2	64.2	58.2	54.7	52.2	48.7	44.2	40.7	38.2	32.2
Wind Turbine: Vesta V66, ave	110.4	85.4	79.4	73.4	65.4	59.4	55.9	53.4	49.9	45.4	41.9	39.4	33.4
Wind Turbine: Vestas V117 3.3MW	96.3	71.3	65.3	59.3	51.3	45.3	41.8	39.3	35.8	31.3	27.8	25.3	19.3

5.2 POTENTIAL NOISE SOURCES: OPERATION PHASE

The proposed development would be designed to have an operational life of up to 25 years with the possibility to further expand the lifetime of the Project. The only development related activities on-site will be routine servicing (access roads and light traffic) and unscheduled maintenance. The noise impact from maintenance activities is insignificant, with the main noise source being the wind turbine blades and the nacelle (components inside) as highlighted in the following sections.

Noise emitted by wind turbines can be associated with two types of noise sources. These are aerodynamic sources due to the passage of air over the wind turbine blades and mechanical sources which are associated with components of the power train within the turbine, such as the gearbox and generator and control equipment for yaw, blade pitch, etc. These sources normally have different characteristics and can be considered separately. In addition, there are other noise sources of lower levels, such as the substations and traffic (maintenance).

The noise levels and the octave sound power emission levels of the selected WTG used for the operational noise model are highlighted in **Table 5-1**.

5.2.1 Wind Turbine Noise: Aerodynamic sources [7, 17, 29, 40, 106]

Aerodynamic noise is emitted by a wind turbine blade through a number of sources such as:

1. Self-noise due to the interaction of the turbulent boundary layer with the blade trailing edge.
2. Noise due to inflow turbulence (turbulence in the wind interacting with the blades).
3. Discrete frequency noise due to trailing edge thickness.
4. Discrete frequency noise due to laminar boundary layer instabilities (unstable flow close to the surface of the blade).
5. Noise generated by the rotor tips.

Therefore, as the wind speed increases, noises created by the wind turbine also increase. At a low wind speed the noise created by the wind turbine is generally (relatively) low, and increases to a maximum at a certain wind speed when it either remains constant, increase very slightly or even drops as illustrated in **Figure 5-1**.

The Developer is investigating a number of different wind turbine models; not excluding the possibility of larger models that are not yet available in the commercial market. Therefore, for the purpose of this noise assessment the following scenarios will be considered:

- A WTG with a sound power emission level (“SPL”) of 112.6 dBA (re 1 pW), using the SPL characteristics of the Goldwind GW165-6.0MW WTG (Goldwind, 2021 [51]; Goldwind, 2022 [52]) – the worst-case scenario;
- A WTG with an SPL of 109.2 dBA (re 1 pW), using the SPL characteristics of the Nordex N163 5.X WTG (Nordex, 2021 [93]) – potential typical scenario; and
- A WTG with an SPL of 104.3 dBA (re 1 pW), using the SPL characteristics of the Vestas V162-6.0 MW WTG (Vestas, 2020 [138]) (operating in mode PO6000, with serrated trailing edges on the blades) – best case scenario.

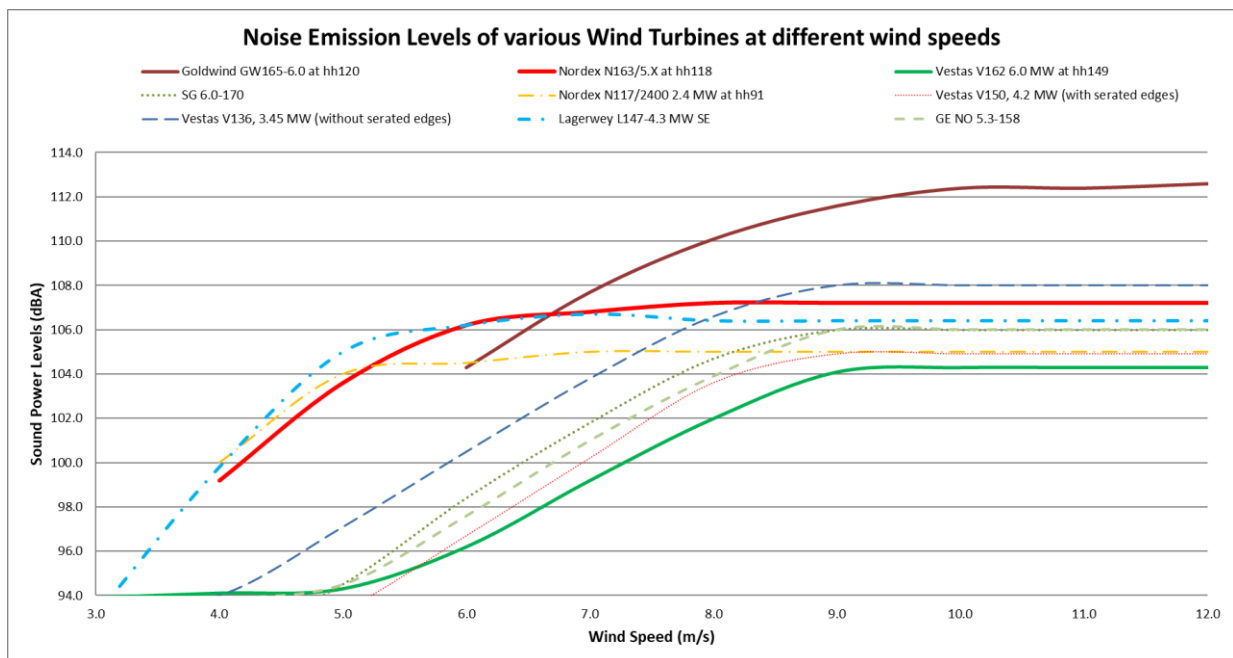

Figure 5-1: Noise Emissions Curve of a number of different wind turbines (figure for illustration purposes only)

The propagation model also makes use of various frequencies, because these frequencies are affected in different ways as it propagates through air, over barriers and over different ground conditions providing a higher accuracy than models that only use the total sound power level. The octave sound power emission levels for various wind turbines are presented on **Figure 5-2**.

5.2.1.1 Control Strategies to manage Noise Emissions during operation

Wind turbine manufacturers also provide their equipment with control mechanisms to allow for a certain noise reduction during operation that can include:

- A reduction of rotational speed;
- The increase of the pitch angle and/or reduction of nominal generator torque to reduce the angle of attack;

- Implementation of blade technologies such as serrated edges, changing the shape of the blade tips or the edge (proprietary technologies); and
- The insulation of the nacelle.

These mechanisms are used in various ways to allow the reduction of noise levels from the wind turbines, although this may also result in a reduction of power generation.

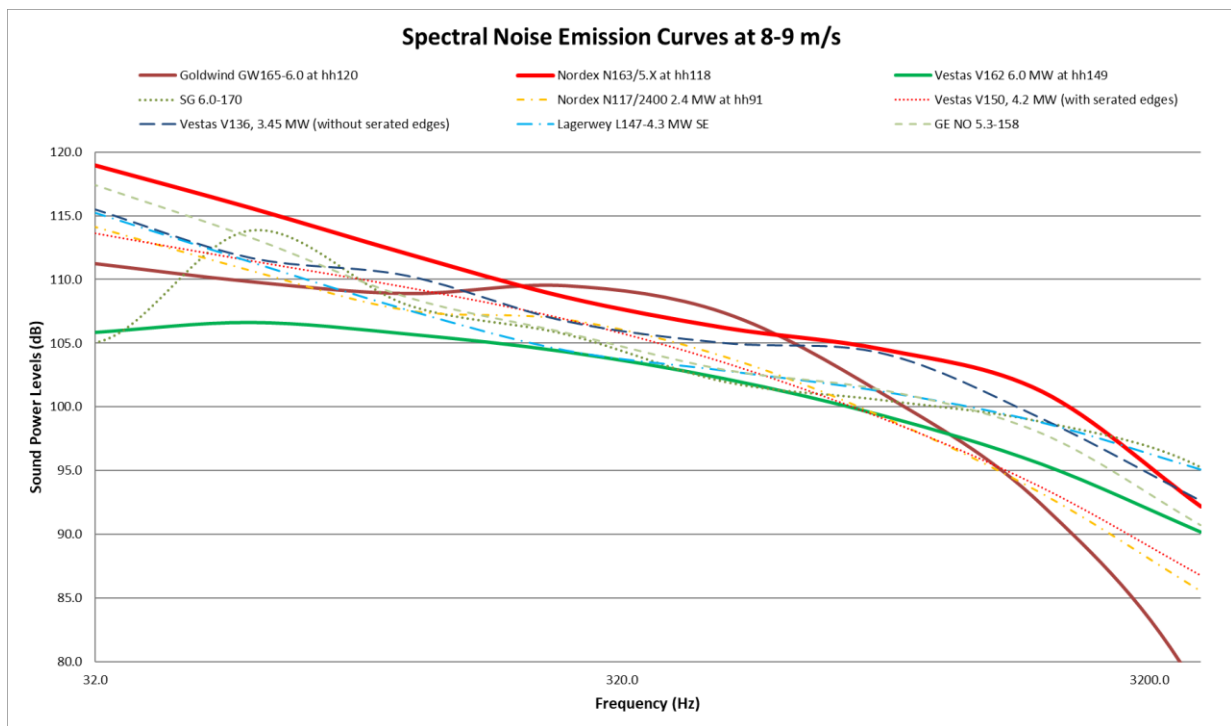

Figure 5-2: Octave sound power emissions of various wind turbines

5.2.2 Wind Turbine: Mechanical sources [43, 61, 106, 109]

Mechanical noise is normally perceived within the emitted noise from wind turbines as an audible tone(s) which is subjectively more intrusive than a broad band noise of the same sound pressure level. Sources for this noise are normally associated with:

- the gearbox and the tooth mesh frequencies of the step-up stages;
- generator noise caused by coil flexure of the generator windings which is associated with power regulation and control;
- generator noise caused by cooling fans; and
- control equipment noise caused by hydraulic compressors for pitch regulation and yaw control.

Tones are noises with a narrow sound frequency composition (e.g., the whine of an electrical motor). Annoying tones can be created in numerous ways: machinery with rotating parts

such as motors, gearboxes, fans and pumps often create tones. An imbalance or repeated impacts may cause vibration that, when transmitted through surfaces into the air, can be heard as tones. Pulsating flows of liquids or gases can also create tones, which may be caused by combustion processes or flow restrictions. The best and most well-known example of a tonal noise is the buzz created by a flying mosquito.

Where complaints have been received due to the operation of wind farms, tonal noise from the installed wind turbines appears to have increased the annoyance perceived by the complainants and has indeed been the primary cause for complaint.

However, tones were normally associated with the older models of turbines. All turbine manufacturers have started to ensure that sufficient forethought is given to the design of quieter gearboxes and the means by which these vibration transmission paths may be broken. Through the use of careful gearbox design and/or the use of anti-vibration techniques, it is possible to minimize the transmission of vibration energy into the turbine supporting structure. The benefits of these design improvements have started to filter through into wind farm developments which are using these modified wind turbines. ***New generation wind turbine generators do not emit any clearly distinguishable tones.***

5.2.3 Low Frequency Noise

Low frequency sound is the term used to describe sound energy in the region below ~200 Hz. The rumble of thunder and the throb of a diesel engine are both examples of sounds with most of their energy in this low frequency range. Infrasound is often used to describe sound energy in the region below 20 Hz (DELTA, 2008) [32], (HGC Engineering, 2006 [60], (O'Neal *et al.*, 2011) [95], (Van den Berg, 2004) [133].

Almost all noise in the environment has components in this region although they are of such a low level that they are not significant (wind, ocean, thunder). See also **Figure 5-3**, which indicates the sound power levels in the different octave bands from measurements taken at different wind speeds with no other audible noise sources. Sound that has most of its energy in the 'infrasound' range is only significant if it is at a very high level, far above normal environmental levels (Bolin *et al.*, 2011) [10], (DELTA, 2008) [32], (Kamperman and James, 2008) [72].

Ambrose (2011) [1] and other authors have confirmed modulations consistent with the frequency that the blade pass the tower. Because of the low rotational rates of the blades of a WTG, the peak acoustic energy radiated by large wind turbines is in the infrasonic range with a peak in the 8-12 Hz range. For smaller machines, this peak can extend into the low-

frequency "audible" (20-20KHz) range because of higher rotational speeds and multiple blades (BWEA, 2005) [16], (Cummings, 2012) [28], (HGC Engineering, 2006) [60].

The British Wind Energy Association (BWEA) [16] highlighted that these sounds are below the threshold of perception, although this should be clarified. Most acousticians would agree that the low frequency sounds are inaudible to most people, yet, there are a number of studies that highlight that it can be more perceptible to people inside their houses as well as people that are more sensitive to low frequency sounds (DEFRA, 2003) [30], (Evans, Cooper and Lenchine, 2012) [45], (HGC Engineering, 2011) [62], (Oud, 2012) [97].

In February 2013, the Environmental Protection Authority of South Australia published the results of a study into low-frequency noise near wind farms (Evans and Cooper, 2012) [44, 45]. This study measured infrasound levels at urban locations, rural locations with wind turbines close by, and rural locations with no wind turbines in the vicinity. It found that infrasound levels near wind farms are comparable to levels away from wind farms in both urban and rural locations. Infrasound levels were also measured during organized shut-downs of the wind farms; the results showed that there was no noticeable difference in infrasound levels whether the turbines were active or inactive.

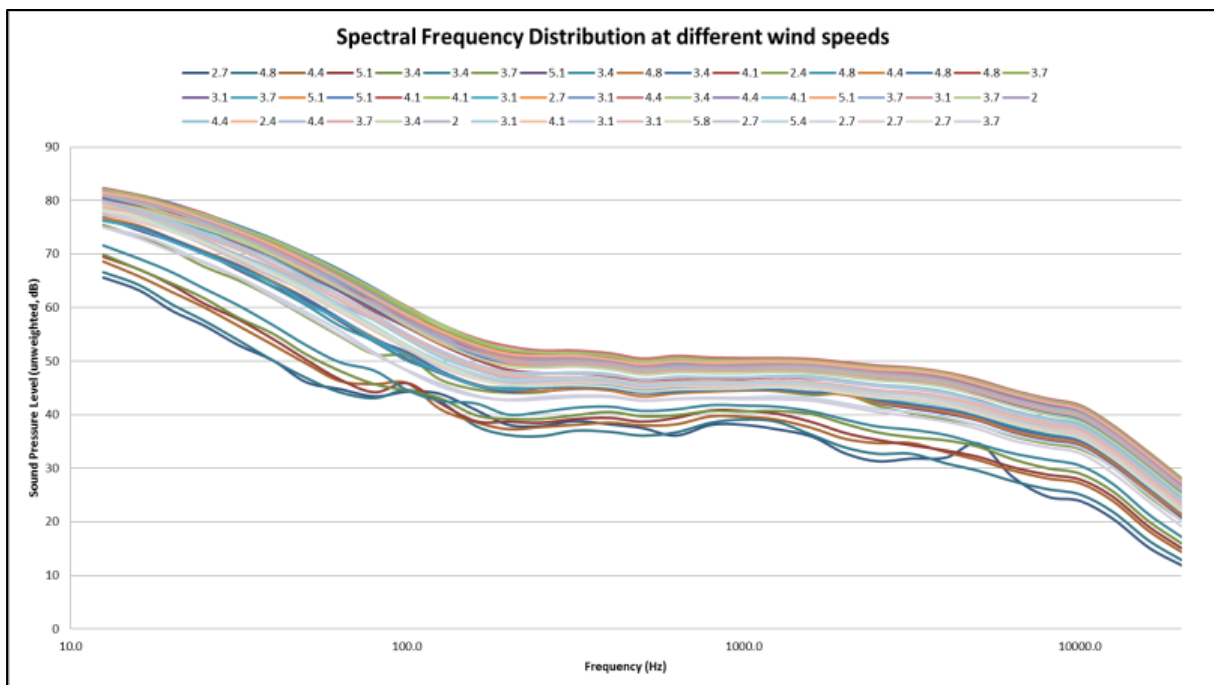

Figure 5-3: Third octave band sound power levels at various wind speeds at a location where wind induced noises dominate

Low Frequency Noise however has been very controversial in the last few years with the anti-wind fraternity claiming measurable impacts, with governments and wind-energy

supporter studies indicating no link between low-frequency sound and any health impacts. This study notes the various claims.

5.2.4 Amplitude modulation

Wind Turbine Noise (WTN) includes a steady component (see also the preceding section 5.2.1 and 5.2.2) as well as, in some circumstances, a periodically fluctuating or Amplitude Modulated (AM) component or character (RenewableUK, 2013) [110]. Although generally considered rare, it is a characteristic of WTN that increases the annoyance with a project above that of other long-term noise sources (Bowdler, 2008) [12], (Conrady et al., 2019) [20], (DEFRA, 2007) [31], (Noise-con, 2008) [91], (Smith *et al.*, 2012) [122].

The amplitude modulation (AM) of the sound emissions from the wind turbines creates a repetitive rise and fall in sound levels synchronized to the blade rotational speed, sometimes referred to as a “swish” or “thump”.

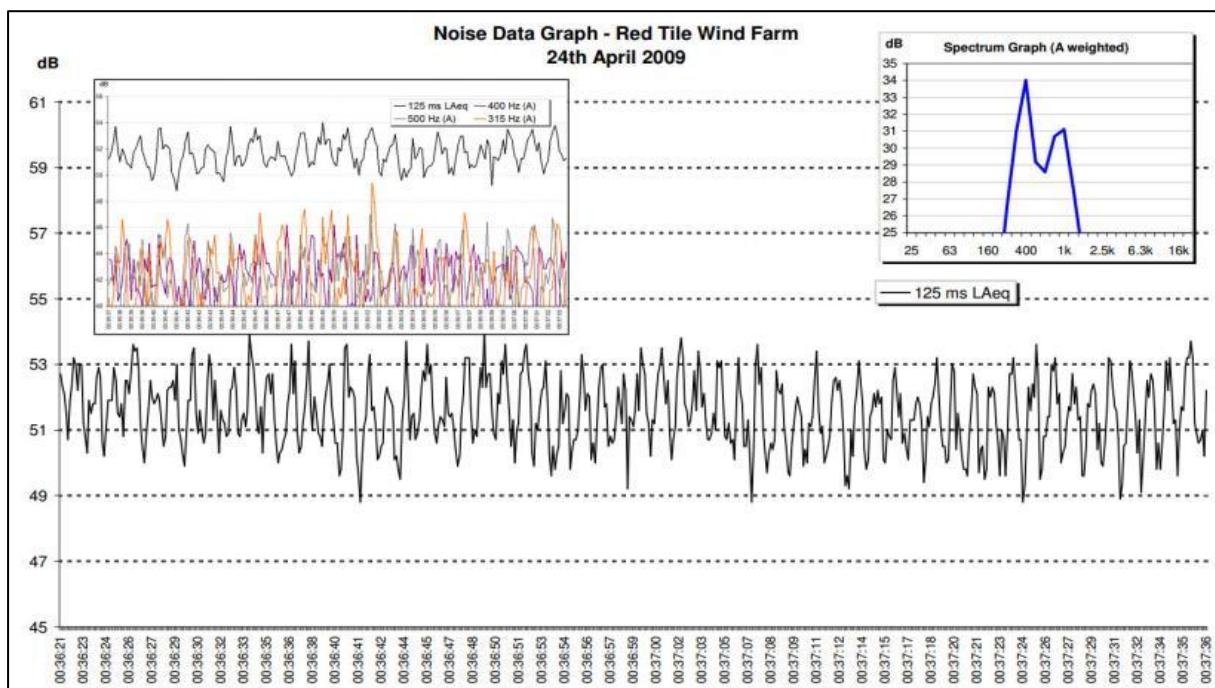

Figure 5-4: Example time-sound series graph illustrating AM as measured by Stigwood (2013) [123]

Pedersen (2003) [102] highlighted a weak correlation between sound pressure level and noise annoyance caused by wind turbines. Residents complaining about wind turbines noise perceived more sound characteristics than noise levels, with people able to distinguish between background ambient sounds and the sounds that the blades made. The noise produced by the blades lead to most complaints. Most of the annoyance was experienced

between 16:00 and midnight. This could be an issue as noise propagation modelling would be reporting an equivalent, or “average” sound pressure level, a parameter that ignores the “character” of the sound.

That AM can be a risk and significantly increase the annoyance with WEFs that cannot be disputed. It has been reported with a number of recent studies confirming this significant noise characteristic (Pedersen, Halmstad and Högskolan, 2003) [102]. However, even though there are thousands of wind turbine generators in the world, amplitude modulation is still one subject receiving the least complaints and due to these very few complaints, less research went into this subject. It is also a complex source of wind turbine noise, with studies highlighting that time of year, atmospheric conditions, wind direction and atmospheric conditions all play a role in the generation of AM (CanWEA, 2007) [17], (Cummings, 2012) [28], (Cummings, 2009) [29], (RenewableUK, 2013) [110].

How people may respond to AM is also complex. WSP (2016) [144], in a study done for the Department of Energy and Climate Change summarized that:

- Within both laboratory and field test environments there is a strong association between increasing overall time-average levels of AM WTN-like sounds with increasing ratings of annoyance.
- Within a laboratory test environment:
 - subjects rated noticeable modulating WTN-like sounds as more annoying than similar noise without significant modulation;
 - the onset of fluctuation sensation for a modulating WTN-like sound appeared to be in the region of around 2 dB modulation depth;
 - increasing modulation depth above the onset of fluctuation sensation showed a broadly increasing trend in mean ratings of annoyance, but changes in mean annoyance rating tended to be relatively small and, in some cases, inconsistent;
 - equivalent annoyance ratings of AM and steady WTN-like sounds derived by level adjustment did not show a strong increasing trend with increasing depth of modulation; and
 - equivalent ‘noisiness perception’ of WTN-like AM sounds compared with a steady sound showed a gradually increasing trend with modulation depth.

WSP (2016) also concluded that the results from both the laboratory and field studies should be approached with caution, since they may not readily translate to how people respond to WTN exposure in their homes (WSP, 2016) [144].

This assessment notes the various findings from these studies, and recommend a more precautionous approach, raising the probability of a noise impact occurring with one point for all night-time operational activities where (whichever is the lowest):

- the projected noise levels exceed the long-term fast-weighted ambient sound levels with more than 3 dB, or
- the projected noise levels exceed the typical rating levels for the area with more than 5 dBA.

5.2.5 Battery Energy Storage Systems

The developer proposes to include a BESS at their WEF to store energy for use at a later time or date using electro-chemical solutions. The typical components of a BESS are:

- The battery system which could consist of:
 - Multiple cells,
 - The battery management system; and,
 - The battery thermal management system.
- Components required for the reliable operation of the overall system, including:
 - Energy management system; and,
 - System thermal management.
- Power electronics that can be grouped into the conversion unit (such as an invertor), which manage the power flow between the grid and battery, including the required control and monitoring components, voltage sensing units and thermal management of power electronic components (fans or climate control system).

There could be numerous such BESS modules running in parallel to increase the total storage capacity of the system up to the desired or needed capacity. The typical components are illustrated in **Figure 5-5**.

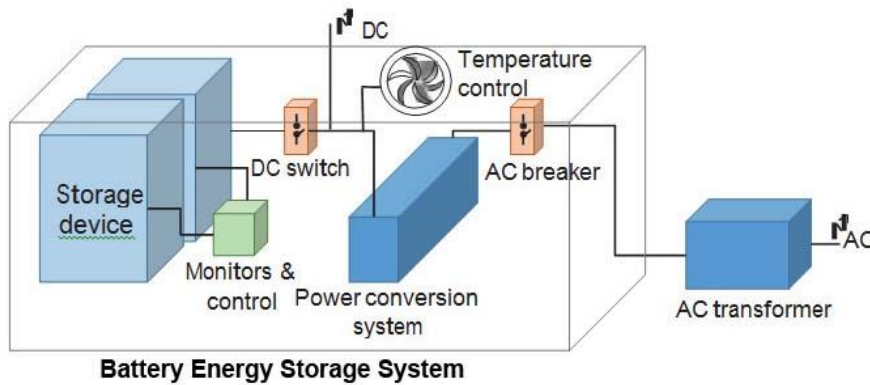

Figure 5-5: Conceptual BESS components¹⁵

While certain components may generate a slight hum under load, the dominant source of noise is from the fans or climate control system used to manage heat in the system and/or to maintain the BESS within its optimal operating temperature range. These BESSs however generate low noise levels, with any potential noise impact generally limited to areas within 200m of the BESS. This is an insignificant noise level and the significance of this noise will be low.

5.2.6 Transformer noises (Substations)

Also known as magnetostriction¹⁶, is when the sheet steel used in the core of the transformer tries to change shape when being magnetised. When the magnetism is taken away, the shape returns, only to try and deform in a different manner when the polarity is changed.

This deformation is not uniform; consequently, it varies all over a sheet. With a transformer core being composed of many sheets of steel, these deformations are taking place erratically all over each sheet, and each sheet is behaving erratically with respect to its neighbour. The resultant is the "hum" frequently associated with transformers. While this may be a soothing sound in small home appliances, various complaints are logged in areas where people stay close to these transformers. At a voltage frequency of 50 Hz, these "vibrations" take place 100 times a second, resulting in a tonal noise at 100Hz.

However, this is a relatively easy noise to mitigate with the use of acoustic shielding and/or placement of the transformer and will not be considered further in this ENIA study. Substations in addition generate low noise levels, with the hum from the transformers inaudible further than 200 m from the transformers.

¹⁵ Source: <http://www.amdcenergy.com/battery-energy-storage-system.html>

¹⁶ <https://en.wikipedia.org/wiki/Magnetostriction>

5.2.7 Transmission Line Noise (Corona noise)

Corona noise¹⁷ is caused by the partial breakdown of the insulation properties of air surrounding the conducting wires. It can generate an audible and radio-frequency noise, but generally only occurs in humid conditions, as provided by fog or rain. A minimum line potential of 70kV or higher is generally required to generate corona noise depending on the electrical design. Corona noise does not occur on domestic distribution lines.

Corona noise has two major components: a low frequency tone associated with the frequency of the AC supply (100 Hz for 50 Hz source) and broadband noise. The tonal component of the noise is related to the point along the electric waveform at which the air begins to conduct. This varies with each cycle and consequently the frequency of the emitted tone is subject to great fluctuations. Corona noise can be characterised as broadband 'crackling' or 'buzzing', but **fortunately it is generally only a feature that occurs during fog or rain.**

It will not be further investigated, as corona discharges results in:

- Power losses,
- Audible noises,
- Electromagnetic interference,
- A purple glow,
- Ozone production; and
- Insulation damage.

As such Electrical Service Providers, such as ESKOM, go to great lengths to design power transmission equipment to minimise the formation of corona discharges. In addition, it is an infrequent occurrence with a relatively short duration compared to other operational noises.

¹⁷ https://en.wikipedia.org/wiki/Corona_discharge

6 METHODS: NOISE IMPACT ASSESSMENT

6.1 NOISE IMPACT ON ANIMALS

A significant amount of research was undertaken during the 1960's and 70's on the effects of aircraft noise on animals (Autumn, 2007) [2], (Noise quest, 2010) [92]. While aircraft noise has a specific characteristic that might not be comparable with industrial noise, the findings should be relevant to most noise sources. A general animal behavioural reaction to aircraft noise is the startle response with the strength and length of the startle response to be dependent on the following:

- which species is exposed;
- whether there is one animal or a group of animals, and
- whether there have been some previous exposures.

Overall, the research suggests that species differ in their response to noise depending on the duration, magnitude, characteristic and source of the noise, as well as how accustomed the animals are to the noise (previous exposure).

Extraneous noises impact on animals as it can increase stress levels and even impact on their hearing. Masking sounds may affect their ability to react to threats, compete and seek mates and reproduce, hunt and forage, communicate and generally to survive.

Unfortunately, there are numerous other factors in the faunal environment that also influence the effects of noise. These include predators, weather, changing prey/food base and ground-based disturbance, especially anthropogenic. This hinders the ability to define the real impact of noise on animals.

The only animal species studied in detail are humans, and studies are still continuing in this regard. These studies also indicate that there is considerable variation between individuals, highlighting the loss of sensitivity to higher frequencies as humans age. Sensitivity also varies with frequency with humans. Considering the variation in the sensitivity to frequencies and between individuals, this is likely similar with all faunal species. Some of these studies are repeated on animals, with behavioural hearing tests being able to define the hearing threshold range for some animals as indicated on **Figure 6-1**.

Only a few faunal (animal) species have been studied in a bit more detail so far, with the potential noise impact on marine animals most likely the most researched subject, with a few studies that discuss behavioural changes in other faunal species due to increased noises. Few studies indicate definitive levels where noises start to impact on animals, with most based on laboratory level research (USEPA, 1971) [131] that subject animals to noise levels

that are significantly higher than the noise levels these animals may experience in their environment (excluding the rare case where bats and avifauna fly extremely close to an anthropogenic noise, such as from a moving car or the blades of a wind turbine).

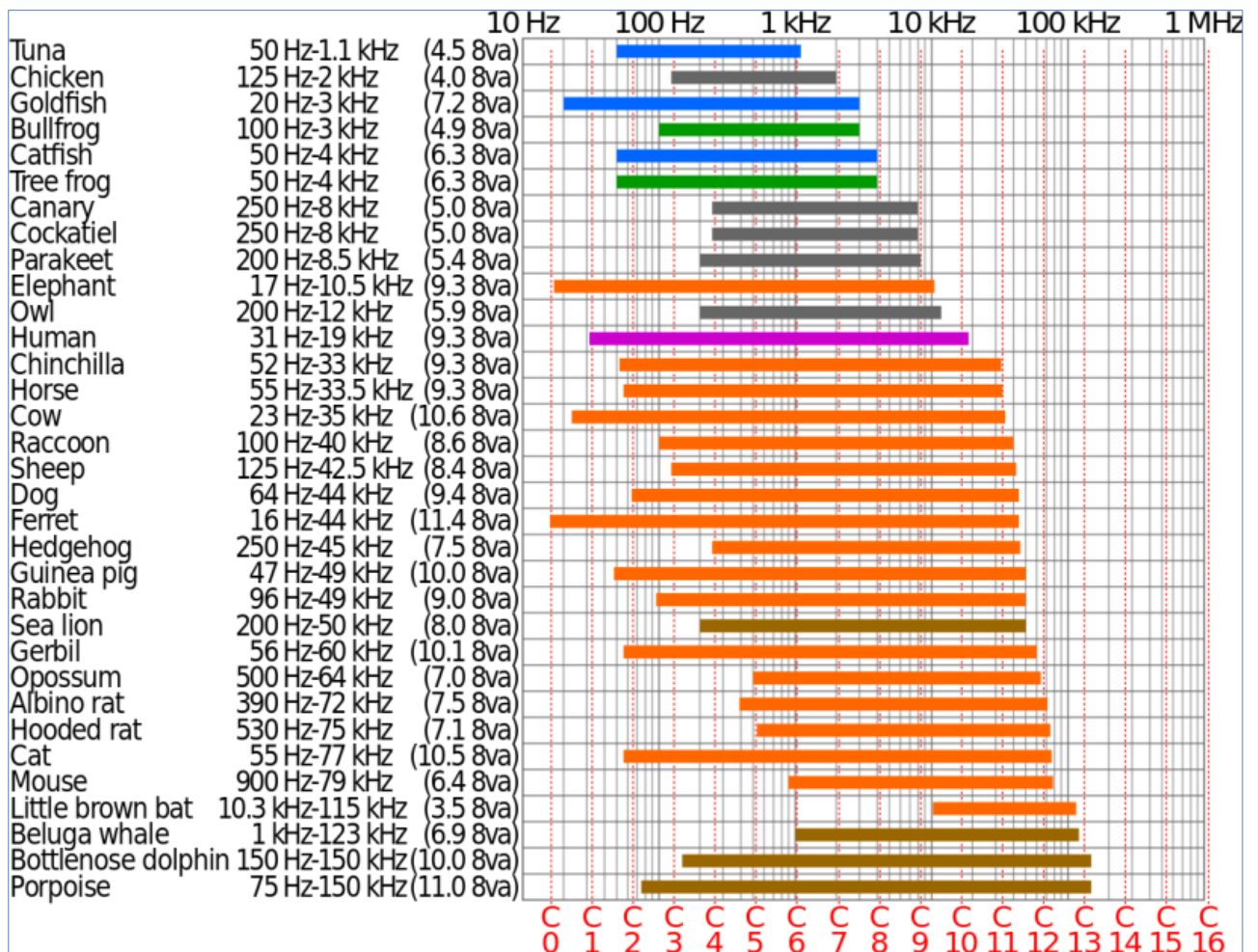

Figure 6-1: Logarithmic Chart of the Hearing Ranges of Some Animals¹⁸

6.1.1 Domesticated Animals

Excluding loud impulsive noises, considering the environmental noise levels (the noise levels were not defined, but levels of up to 100 dB were reported), it has been observed that most domesticated animals are generally not bothered by noise and generally can acclimatize relatively quickly to loud noises (Šottník, 2011) [118]. Considering the expected wind turbine noise (WTN) levels (well less than 60 dBA at all locations), WTN will not impact on domestic animals (Noise quest, 2010) [92].

¹⁸ https://en.wikipedia.org/wiki/Hearing_range

6.1.2 Wildlife

Studies indicated that most animals adapt to noises, and would even return to a site after an initial disturbance, even if the noise is continuous. The more sensitive animals that might be impacted by noise would most likely relocate to a quieter area. Helldin (2012) [58] however highlights that the network of access road could be a significant factor impacting on animals. Noise impacts are therefore very highly species-dependent (Blickley and Patricelli, 2010) [9], (Cummings, 2012) [28], (Cummings, 2009) [29], (Łopucki, Klich and Gielarek, 2017) [78], (Noise quest, 2010) [92], (Rabin, Coss and Owings, 2006) [108], but there are also other factors that could impact on animals (such as visibility and increased movement of people and vehicles).

6.1.3 Avifauna

As with other terrestrial faunal species, noise (character of sound or change in level) will impact on avifauna (birds of a particular region and/or habitat). Anthropogenic noises result in physical damage to ears, increased stress, flight or flushing, changes in foraging and other behavioural reactions. Ortega (2012) [96] summarized that additional responses (with ecological similar controls) include the avoidance of noisy areas, changes in reproductive success and changes in vocal communication. However, as with other faunal species, there are no guidelines to assess at which sound pressure level avifaunal will start to exhibit any response (Autumn, 2007) [2], (Cummings, 2009) [29], (Dooling and Popper, 2007) [35], (Lohr, Wright and Dooling, 2003) [76], (Ortega, 2021) [96], (Schaub, Ostwald and Siemers, 2008) [116], (Zwart *et al.*, 2014) [145].

6.1.4 Concluding Remarks - Noise Impacts on Animals

From these and other studies the following can be concluded:

- To date there are no guidelines or sound limits with regards to noise levels that can be used to estimate the potential significance of noises on animals (Blickley *et al.*, 2010) [9].
- Animals respond to impulsive (sudden) noises (higher than 90 dBA) by running away. If the noises continue, animals would try to relocate (Dooling, 2007) [35].
- Terrestrial wildlife responses begin at noise levels of approximately 40 dBA, with 20% of papers documenting impacts below 50 dBA (Shannon *et al.* 2015) [119].
- Animals start to respond to increased noise levels with elevated stress hormone levels and hypertension. These responses begin to appear at exposure levels of 55 to 60 dBA (Baber, 2010) [5], with Helldin *et al.* (2012) [58] reporting that levels of 60–75 dBA have been shown to cause stress, e.g., increased respiration and heart rate, increased vigilance, and decreased time for grazing in domestic animals such as sheep and horses.

- Animals of most species exhibit adaptation with noise (Broucek, 2014) [15], including impulsive noises, by changing their behaviour.
- There may be a possible impact on the health of animals (Mikolajczak, 2013; Karwowska, 2015) caged very close to an operating WTG (within 500 m) (Karwowska, 2015) [73], (Mikolajczak, 2013) [85];
- Songbirds may change the spectral character of songs and calls used for communication and defence in areas very close to WTGs. This is similar to the effects of other anthropogenic noise sources such as traffic, which can disrupt bird 'chatter' to the point of being detrimental to reproductive success (Szymański, 2017; Zwart, 2014) [125, 145];
- More sensitive species would relocate to a quieter area, especially species that depend on hearing to hunt or evade prey, or species that makes use of sound/hearing to locate a suitable mate (Dooling, 2007; Łopucki, 2017) [35, 78].
- Noises associated with helicopters, motor- and quad bikes significantly impact on animals (startle response). This is due to the sudden and significant increase in noise levels due to these activities [(Autumn, 2007) [2, 131];
- Focusing on small species (rodents and shrews), Łopucki (2016) [77] assessed differences between control sites and locations close to wind turbines (the distances from WTG were not defined), concluding no significant differences between the sites;
- Łopucki (2017) [78] studied tracks from various species (Roe deer, European hare, Common pheasant and Red fox), from as close as 100m from WTG to 700m away. That study determined that
 - Roe deer and European hare visit the areas closer to WTG less frequently than areas further away,
 - Common pheasant appear to visit the areas closer to WTG more frequently, and
 - Red fox showed the most neutral response to WTG; and
- Helldin *et al.* (2012) [58] also report that large terrestrial mammals appear to acclimatise to wind farms during the operational phase, arguing that WF mainly affect large terrestrial mammals through an increase in human activity.

With regard to Low-Frequency Noise (LFN) and Infrasound, it is summarized that:

- There are no scientific papers available in reputable journals highlighting the impact of LFN from WTG on wildlife;
- Animal communication is generally the highest during no and low wind conditions. It has been hypothesised that this is one of the reasons why birds sing so much in the mornings (their voices carry the farthest and there are generally less observable wind);

- Background noise levels (ambient sound levels) in remote areas are not always low in space or time. The site is windy and this generates significant noise itself and also significantly changes the ability of fauna to hear the environmental noises around them;
- Wind is a significant source of natural noise, with a character similar to the noise generated by wind turbines, with a significant portion of the acoustic energy in the low frequency and infrasound range;
- Wind turbines do not emit broad-band sound on a continual basis as the turbines only turn and generate noise when the wind speeds are above the cut-in speed;
- The wind turbines will only operate during periods of higher wind speeds, a period when background noise levels are already elevated due to wind-induced noises; and
- The elevated background noise relating with wind also provide additional masking of the wind turbine noise, with periods of higher winds also correlating with lower faunal activity, particularly with regard to communication.

It should be noted that LFN and Infrasound is present in the environment and is generated by a wide range of natural sources (e.g., wind, waves etc.). In February 2013, the Environmental Protection Authority of South Australia published the results of a study into infrasound levels near wind farms (Evans, 2013). This study measured infrasound levels at urban locations, rural locations with wind turbines close by, and rural locations with no wind turbines in the vicinity. It found that infrasound levels near wind farms are comparable to levels away from wind farms in both urban and rural locations. Infrasound levels were also measured during organized shut-downs of the wind farms; the results showed that there was no noticeable difference in infrasound levels whether the turbines were active or inactive.

6.2 WHY NOISE CONCERNS COMMUNITIES [3, 14, 19, 24, 29, 50, 74, 91, 106, 120]

Noise can be defined as "unwanted sound", and an audible acoustic energy that adversely affects the physiological and/or psychological well-being of people, or which disturbs or impairs the convenience or peace of any person. One can generalise by saying that sound becomes unwanted when it:

- Hinders speech communication;
- Impedes the thinking process;
- Interferes with concentration;
- Obstructs activities (work, leisure and sleeping); and
- Presents a health risk.

However, it is important to remember that whether a given sound is "noise" depends on the listener or hearer. The driver playing loud rock music on their car radio hears only music, but the person in the traffic behind them hears nothing but noise.

Response to noise is unfortunately not an empirical absolute, as it is seen as a multi-faceted psychological concept, including behavioural and evaluative aspects. For instance, in some cases, annoyance is seen as an outcome of disturbances, and in other cases it is seen as an indication of the degree of helplessness with respect to the noise source.

Noise does not need to be loud to be considered "disturbing". One can refer to a dripping tap in the quiet of the night, or the irritating "thump-thump" of the music from a neighbouring house at night when one would prefer to sleep. Noise impacts are also complex to evaluate as numerous issues could cumulatively contribute to the severity of the impact, as discussed in the following subsections.

How a noise may impact (with this assessment using annoyance about the noise) on a receptor is also very complex to assess for the reasons highlighted in **section 6.2.1** below. Only considering the intensity of a sound (or noise) level, some people may become annoyed without hearing any noise (perceived impacts) where others may not even be reporting noise to be a concern, even when subjected to very high levels.

6.2.1 Noise Annoyance

Annoyance is the most widely acknowledged effect of environmental noise exposure, and is considered to be the most widespread. It is estimated that less than a third of the individual noise annoyance is accounted for by acoustic parameters, and that the non-acoustic factors play a major role. Non-acoustic factors that have been identified include age, economic dependence on the noise source, attitude towards the noise source and self-reported noise sensitivity (Bakker *et al.*, 2012) [4], (Council of Canadian Academies, 2015) [23], (Ellenbogen *et al.*, 2012) [39], (Halfwerk *et al.*, 2011) [54], (Hanning, 2010) [55], (Janssen *et al.*, 2011) [67], (Knopper *et al.*, 2014) [74], (Merlin *et al.*, 2013) [82], (Miedema and Vos, 2003) [83], (Minnesota Department of Health, 2009) [86], (Nissenbaum, 2012) [90], (Pedersen, 2007) [100], (Pedersen, 2007) [101], (Pedersen, Halmstad and Högskolan, 2003) [102], (Pedersen, 2011) [103], (Pierpont, 2009) [105], (Schmidt and Klokke, 2014) [117], (Van den Berg *et al.*, 2008) [134], (Van den Berg, Verhagen and Uitenbroek, 2014) [135], (World Health Organization, 2009) [142].

On the basis of a number of studies into noise annoyance, exposure-response relationships were derived for high annoyance from different noise sources. These relationships, illustrated in **Figure 6-2**, are recommended in a European Union position paper published in 2002, stipulating policy regarding the quantification of annoyance. This can be used in environmental health impact assessment and cost-benefit analysis to translate noise maps into overviews of the numbers of persons that may be annoyed, thereby giving insight into the situation expected in the long-term. It is not applicable to local complaint-type situations or to an assessment of the short-term effects of a change in noise levels.

Severity of the annoyance depends on factors such as:

- Background sound levels and the background sound levels the receptor is used to;
- The manner in which the receptor can control the noise (helplessness);
- The time, unpredictability, frequency distribution, duration, and intensity of the noise;
- The physiological and health state of the receptor; and
- The attitude of the receptor about the emitter (noise source).

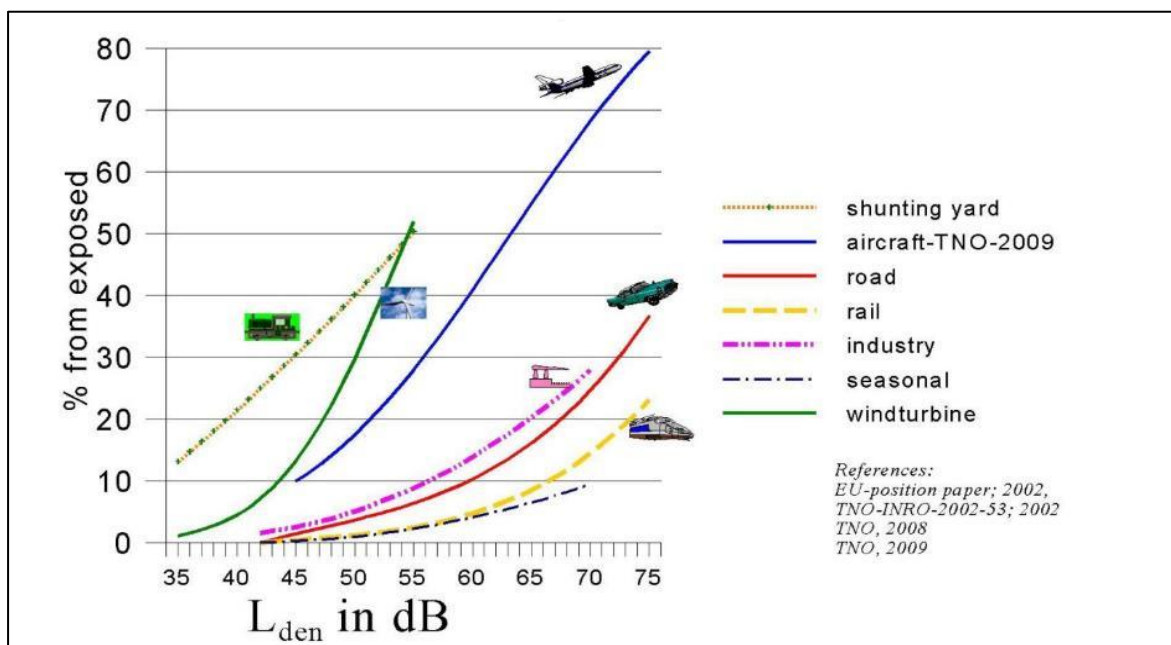

Figure 6-2: Percentage of annoyed persons as a function of the day-evening-night noise exposure at the façade of a dwelling¹⁹

¹⁹ Image from <https://rigolett.home.xs4all.nl/ENGELS/topic.htm>. Wind Turbine Annoyance curve from Pedersen (2007)

6.2.1.1 Disturbance to Sleep

Sleep is essential for mental and physical health, and noise is one of the most reported reasons why people may experience sleep interruptions at night. This may be sudden loud noises, with the WHO (2009) [142] reporting that, when maximum noises exceed 60 dBA, with average noise levels exceeding 40 dBA, it may increase the probability of being awakened. People report that quality of life suffer with increased instances of disturbed sleep that may also increase annoyance with a project (Bakker *et al.*, 2012) [4], (Van den Berg, Verhagen and Uitenbroek, 2014) [135]. It should be noted that Van den Berg (2014) [134, 135] showed an indirect effect between sleep disturbances and annoyance, but not between sleep disturbance and the noise level. It is postulated that this is due to increased annoyance due to the visual impact from WTG.

6.2.1.2 Potential Health Effects from WTN

While there has been a number of complaints about the impact of WTN on the health of people living close to WTG (Halfwerk *et al.*, 2011) [54], (Hanning, 2010) [55], (Janssen *et al.*, 2011) [67], (Nissenbaum, 2012) [90], (Pierpont, 2009) [105], other than annoyance and sleep disturbances, there is no evidence of any direct health effects (Council of Canadian Academies, 2015) [23], (Ellenbogen *et al.*, 2012) 39, (Knopper *et al.*, 2014) [74], (Minnesota Department of Health, 2009) [86], (MDEP) 81, (Merlin *et al.*, 2014) [82], (Pedersen, Halmstad and Högskolan, 2003) [102], (Schmidt and Klokker, 2014) [117].

6.2.1.3 Situational and Personal Factors

There are a few other aspects, collectively referred to as non-acoustical factors that may increase annoyance with a project (Miedema, 2003) [83], (Pedersen, 2007) [101]. These could include:

- Situational factors (visual issues, attractiveness of area) (Merlin *et al.*, 2013) [82], (Michaud *et al.*, 2016) [84], (Van den Berg *et al.*, 2008) [134];
- Socio-economic factors (age, gender, income, level of education) [(Miedema, 2003) 83, (Michaud *et al.*, 2016) [84];
- Social factors (attitude towards the applicant/producer/government, media coverage) [(Pedersen, 2007) 101, 124]; and
- Personal factors (fear or worry in relation to noise source, sensitivity to noise, economic benefit from project, existing health condition) [(Miedema, 2003) 83, 136].

6.3 IMPACT ASSESSMENT CRITERIA

6.3.1 Overview: The Common Characteristics

The word "noise" is generally used to convey a negative response or attitude to the sound received by a listener. There are four common characteristics of sound, any or all of which determine listener response and the subsequent definition of the sound as "noise". These characteristics are:

- Intensity;
- Loudness;
- Annoyance; and
- Offensiveness.

Of the four common characteristics of sound, intensity is the only one that is not subjective and can be quantified. Loudness is a subjective measure of the effect sound has on the human ear. As a quantity it is therefore complicated, but has been defined by experimentation on subjects known to have normal hearing.

The annoyance and offensive characteristics of noise are also subjective. Whether or not a noise causes annoyance mostly depends upon its reception by an individual, the environment in which it is heard, the type of activity and mood of the person and how acclimatised or familiar that person is to the sound.

6.3.2 Noise criteria of concern

The criteria used in this report were drawn from the criteria for the description and assessment of environmental impacts from the EIA Regulations of 2014 in terms of the NEMA, SANS 10103:2008, and guidelines from the WHO.

There are a number of criteria that are of concern for the assessment of noise impacts. These can be summarised in the following manner:

- *Increase in noise levels:* People or communities often react to an increase in the ambient noise level they are used to, caused by a new source of noise. With regards to the NCR, an increase of more than 7 dBA is considered a disturbing noise. See also **Figure 6-3**.
- *Zone Sound Levels:* Previously referred to as the acceptable rating levels, sets acceptable noise levels for various areas. See also **Table 6-1**.
- *Absolute or total noise levels:* Depending on their activities, people generally are tolerant to noise up to a certain absolute level, e.g. 65 dBA. Anything above this level will be considered unacceptable.

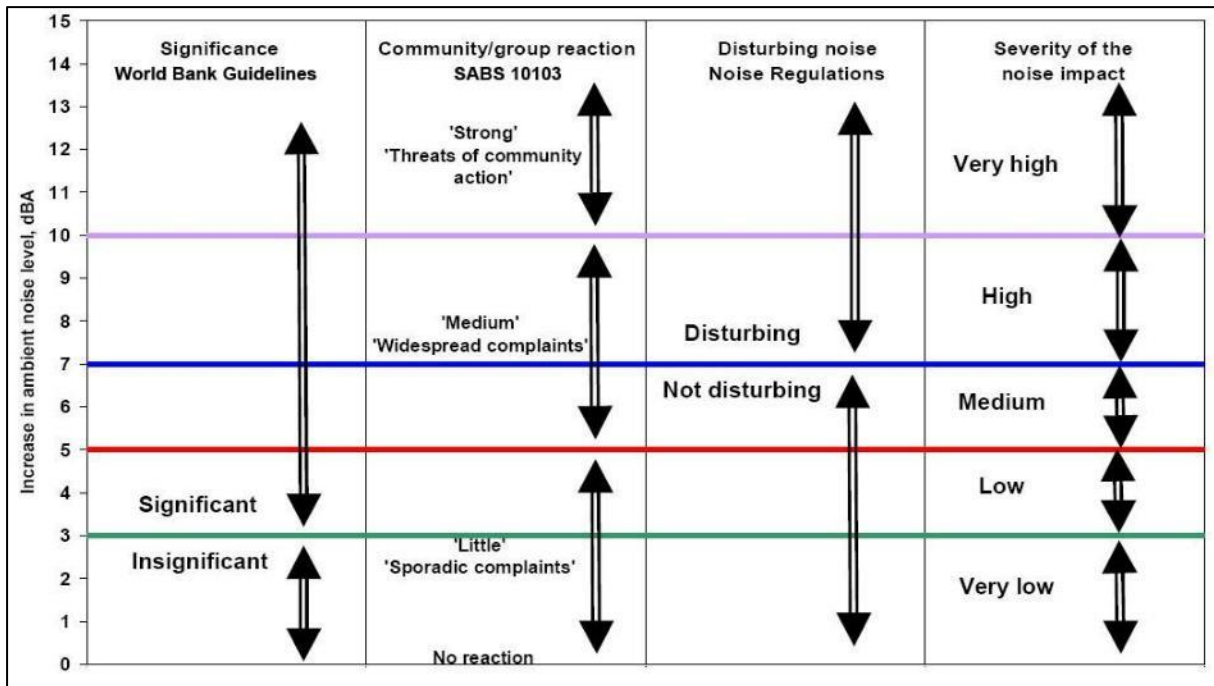

Figure 6-3: Criteria to assess the significance of impacts stemming from noise

In South Africa, the document that addresses the issues concerning environmental noise is SANS 10103:2008 (See also **Table 6-1**). It provides the equivalent ambient noise levels (referred to as Rating Levels), $L_{Req,d}$ and $L_{Req,n}$, during the day and night respectively to which different types of developments may be exposed.

Table 6-1: Acceptable Zone Sound Levels for noise in districts (SANS 10103:2008)

Type of district	Equivalent continuous rating level ($L_{Req,T}$) for noise dBA					
	Outdoors			Indoors, with open windows		
	Day/night $L_{R,dn}^a$	Daytime $L_{Req,d}^b$	Night-time $L_{Req,n}^b$	Day/night $L_{R,dn}^a$	Daytime $L_{Req,d}^b$	Night-time $L_{Req,n}^b$
a) Rural districts	45	45	35	35	35	25
b) Suburban districts with little road traffic	50	50	40	40	40	30
c) Urban districts	55	55	45	45	45	35
d) Urban districts with one or more of the following: workshops; business premises; and main roads	60	60	50	50	50	40
e) Central business districts	65	65	55	55	55	45
f) Industrial districts	70	70	60	60	60	50

6.4 SETTING APPROPRIATE NOISE LIMITS

Onsite ambient sound measurements (**Section** Error! Reference source not found.) indicated an area with a potential to be very quiet, with ambient sound levels typical of a rural noise district.

SANS 10103 unfortunately does not cater for instances when background noise levels change due to the impact of external forces. Locations close to the sea for instance always have a background noise level exceeding 35 dBA, and, in cases where the sea is rather turbulent, it can easily exceed 45 dBA. Similarly, noise induced by high winds is not considered.

Setting noise limits relative to the background noise level is relatively straightforward when the prevailing background noise level and source level are constant. However, wind turbines emit noise that is related to wind speed, and the ambient sound levels in the environment within which they are heard will probably also be dependent on the strength of the wind and the noise associated with its effects. It is therefore necessary to derive a background noise level that is indicative of the noise environment at the receiving property for different wind speeds so that the turbine noise level at any particular wind speed can be compared with the background noise level in the same wind conditions.

6.4.1 Using International Guidelines to set Noise Limits – ETSU-R97

When assessing the overall noise levels emitted by a WEF, it is necessary to consider the full range of operating wind speeds of the wind turbines. This covers the wind speed range from around 3-5 m/s (the turbine cut-in wind speed) up to a wind speed range of 25-35 m/s measured at the hub height of a wind turbine. However, ETSU-R97 (1996) proposes that noise limits only be placed up to a wind speed of 12 m/s for the following reasons:

1. Wind speeds are not often measured at wind speeds greater than 12 m/s at 10 m height;
2. Reliable measurements of background ambient sound levels and turbine noise will be difficult to make in high winds due to the effects of wind noise on the microphone and the fact that one could have to wait several months before such winds were experienced;
3. Turbine manufacturers are unlikely to be able to provide information on sound power levels at such high wind speeds for similar reasons; and
4. If a wind farm meets noise limits at wind speeds lower than 12m/s, it is most unlikely to cause any greater loss of amenity at higher wind speeds. Turbine noise levels increase only slightly as wind speeds increase; however, background ambient sound levels increase significantly with increasing wind speeds due to the force of the wind.

Available data indicates that wind-induced noises start to increase at wind speeds 3 – 4 m/s, becoming a significant (and frequently the dominant noise source in rural areas) at wind speeds higher than 10 – 12 m/s. Most wind turbines reach their maximum noise emission level at a wind speed of 8 – 10 m/s. At these wind speeds increased wind-induced noises (wind howling around building, rustling of leaves in trees, rattling noises, etc) could start to drown other noises, including that being generated by wind turbines²⁰.

Sound level vs. wind speed data is presented in **Figure 4-3**²¹ and **Figure 4-4**. It is based on approximately 38,000 measurements collected at various quiet locations in South Africa (locations further than 10 km from the ocean). Also indicated are around 1,000 and 500 actual day- and night-time measurements collected within, or close to the PFA, of the proposed WEF. There was a lack of very high wind speeds during the site visit, but as with other sites, ambient sound levels are expected to increase as the surrounding wind speed increase. This has been found at all locations where measurements have been done for a sufficiently long enough period of time (more than 30 locations comprising of more than 38,000 measurements) with the data agreeing with a number of international studies on the subject.

Considering this data as well as the international guidelines (MOE, see Table 3-1; IFC, see **Table 3-2**), noise limits starting at 40 dB that increases to more than 45 dB (as wind speeds increase) could be acceptable. Project participants could be exposed to noise levels up to 45 dBA (ETSU-R97 – does not differentiate between day and night-time periods, although this is assumed to be for the night-time period).

6.4.2 Considering the latest WHO (2018) recommendations

The WHO (2018) [**143**] recommends a guideline night-time noise level of 38.7 dBA (based on the 45 dBA L_{DEN} level) to minimize sleep-disturbance and receptors being highly-annoyed (see **section 3.5.9**).

6.4.3 Using the National NCR to set noise limits

Dracoulides (2010 [**37**]) measured ambient sound levels in May 2010 at a location on the outskirts of Okiep, just west from the proposed Springbok WEF. This included 14 day- and 6 night-time measurements. Dracoulides (2010 [**37**]) defined the average daytime noise

²⁰ It should be noted that this does not mean that the wind turbines are inaudible.

²¹ The sound level measuring instruments were located at a quiet location in the garden of the various houses. Data was measured in 10-minute bins and then co-ordinated with the 10 m wind speed derived from the wind mast of the developer. This wind mast was not close to the dwellings, being approximately 3,500m from the measurement locations.

level at 47 dBA at MP04²² and 41.4 dBA for the night-time measurements. Dracoulides (2010 [37]) subsequently assigned the area a rating level (acceptable zone sound level) typical of a suburban noise district. This is expected when considering the developmental character of the measurement location on the edge of Okiep. Other locations, located further than 1,000m from Okiep will be assumed to be quieter, with ambient sound levels typical of a rural noise district.

Noise limits as set by the National NCRs (GN R154 of 1992 – **section 3.2.1**) defines a "**disturbing noise**" as the Noise Level which exceeds the zone sound level or, if no zone sound level has been designated, a noise level which exceeds the ambient sound level at the same measuring point by 7 dBA or more.

Because of the different developmental character in the area, different zone sound levels will be considered for the construction phase, namely:

- A night-time zone sound level of 35 dBA for areas located away from Okiep (with a daytime rating level of 45 dBA), typical of a rural noise district; and
- A night-time zone sound level of 40 dBA for areas located close or within Okiep (with a daytime rating level of 50 dBA), typical of a suburban noise district.

In addition, as can be observed from **Figure 4-3** and **Figure 4-4**, if ambient sound levels were measured at increased wind speeds, ambient sound levels will be higher as wind-induced noises increase. As WTG will only operate during periods with increased wind speeds, these expected sound levels will be considered for the operational phase.

How wind-induced noises increase depends significantly on the measuring location and surrounding environment, but it is expected to be higher than 35 dBA closer to dwellings. The noise limit should increase with increased wind-speeds, but, considering international guidelines, an upper limit of 45 dBA must be honoured. For modelling and assessing the potential noise impact the values as proposed in **Table 6-2** will be recommended.

However, considering the recommendations of the IFC and WHO, an upper night-time noise limit of 45 dBA is recommended, with the rating levels proposed in **Table 6-2** considered for this report.

²² The average level is 44.1 dBA for the day-time measurements at MP02 and MP4

Table 6-2: Proposed ambient sound levels and acceptable rating levels

10 m Height Wind Speed (m/s)	Estimated ambient sound levels (night-time) (dBA)	MoE Sound Level Limits of Class 3 areas (Table 3-1) (dBA)	ETSU-R97 limit for project participants (dBA)	Night-time Zone Sound Level (SANS 10103:2008) (dBA)	Proposed Night Rating Level (dBA)
4	37.6	40	45	35 (at low wind speeds, this will increase as wind speeds increase)	40
5	38.6	40	45		40
6	39.5	40	45		40
7	40.5	43	45		43
8	41.5	45	45		45
9	42.5	49	45		45
10	43.5	49	45		45
11	44.5	49	45		45
12	45.0	49	45		45

6.5 DETERMINING THE SIGNIFICANCE OF THE NOISE IMPACT

6.5.1 Impact Assessment criteria

The level of detail as depicted in the EIA Guidelines (CSIR, 2002) [26] was fine-tuned by assigning specific values to each impact, considering the impact rating methodology developed by the EAP. In order to establish a coherent framework within which all impacts could be objectively assessed, it was necessary to establish a rating system, which was applied consistently to all the criteria.

This scale takes into consideration the following variables:

- **Nature:** Whether the activity have a negative or positive impact on the environment.
- **Type:** A direct, indirect and/or cumulative effect of impact on the environment.
- **Magnitude:** The intensity of the impact on the surrounding receptors.
- **Extent:** the spatial scale defines the physical extent of the impact.
- **Duration:** The temporal scale defines the significance of the impact at various time scales, as an indication of the duration of the impact.
- **Consequence:** The consequence scale is used in order to objectively evaluate how severe a number of negative impacts might be on the issue under consideration, or how beneficial a number of positive impacts might be on the issue under consideration.
- **Probability:** The likelihood of impacts taking place as a result of project actions arising from the various alternatives.

- **Significance:** The criteria in **Table 6-7** and **Table 6-8** are used to determine the overall significance of an activity. The impact effect (which includes duration; extent; consequence and probability) and the reversibility/mitigation of the impact are then read off the significance matrix in order to determine the overall significance of the issue. The overall significance is either negative or positive and will be classified as low, moderate or high.

The impact consequence is determined by summing the scores of Consequence (**Table 6-3**), Duration (**Table 6-5**) and the Spatial Extent (**Table 6-4**) with the Probability score (**Table 6-6**) to obtain the final Impact Significance. It should be noted that while intensity can be calculated to an extent, probability of an impact occurring, or a receptor being annoyed is difficult to determine with this assessment making use an empirical method as defined in **Table 6-6**.

$$\text{Significance Rating} = (\text{Extent} + \text{Intensity} + \text{Duration}) \times \text{Probability}$$

Table 6-3: Impact Assessment Criteria – Magnitude / Intensity

This defines the impact as experienced by any receptor. In this report, the NSR is defined as any resident in the area but excludes faunal species (because guideline levels are not available for animals).		
Rating	Description	Score
<i>Minor</i>	Increase in average sound pressure levels between 0 and 3 dB from the expected ambient sound levels. Ambient sound levels are defined by the lower of the measured LA _{Ieq,8hr} or LA _{Ieq,16hr} during measurement dates. Total projected noise level is less than the Zone Sound Level and/or noise limits defined by the IFC/WHO in wind-still conditions.	2
<i>Low</i>	Increase in average sound pressure levels between 3 and 5 dB from the expected ambient sound levels. Total projected noise levels between 3 and 5 above the Zone Sound Level and/or noise limits defined by the IFC/WHO (wind-less conditions).	4
<i>Medium / Moderate</i>	Increase in average sound pressure levels between 5 and 7 dB from the ambient sound levels. Increase in sound pressure levels between 5 and 7 above the Zone Sound Level and/or noise limits defined by the IFC/WHO (wind-less conditions). Sporadic complaints expected.	6
<i>High</i>	Increase in average sound pressure levels between 7 and 10 from the ambient sound level. Total projected noise levels between 7 and 10 dBA above the Zone Sound Level and/or noise limits defined by the IFC/WHO (wind-less condition). Medium to widespread complaints expected.	8
<i>Very High</i>	Increase in average ambient sound pressure levels higher than 10 dBA. Total projected noise levels higher than 10 dB above the Zone Sound Level and/or noise limits defined by the IFC/WHO (wind less-conditions). Change of 10 dBA is perceived as 'twice as loud', leading to widespread complaints and even threats of community or group action. Any point where instantaneous noise levels exceed 65 dBA at any receptor.	10

Table 6-4: Impact Assessment Criteria – Spatial extent

Classification of the physical and spatial scale of the impact		
Rating	Description	Score
<i>Site</i>	The impacted area extends only as far as the activity, such as footprint occurring within the total site area.	1
<i>Local</i>	The impact could affect the whole, or a significant portion of the site.	2
<i>Regional</i>	The impact could affect the area including the neighbouring farms, the transport routes and the adjoining towns (further than 1,000 m from site).	3
<i>National</i>	The impact could have an effect that expands throughout the country (South Africa).	4
<i>International</i>	Where the impact has international ramifications that extend beyond the boundaries of South Africa.	5

Table 6-5: Impact Assessment Criteria - Duration

The lifetime of the impact that is measured in relation to the lifetime of the proposed development (construction, operational and closure phases). Will the receptors be subjected to increased noise levels for the lifetime duration of the project, or only infrequently.		
Rating	Description	Score
<i>Temporary</i>	The impact will either disappear with mitigation or will be mitigated through a natural process in a period significantly shorter than that of the construction phase (less than 6 months).	1
<i>Short term</i>	The impact will be relevant through to the end of a construction phase (less than 5 years).	2
<i>Medium term</i>	The impact will last up to the end of the development phases, where after it will be entirely negated. The impact could last between 5 and 20 years.	3
<i>Long term</i>	The impact will continue or last for the entire operational lifetime i.e., exceed 20 years of the development.	4
<i>Permanent</i>	This is the only class of impact, which will be non-transitory. Mitigation either by man or natural process will not occur in such a way or in such a time span that the impact can be considered transient.	5

Table 6-6: Impact Assessment Criteria – Probability

This describes the likelihood of a noise impact (receptors being annoyed) actually occurring and whether it will impact on an identified receptor. The impact may occur for any length of time during the life cycle of the activity, and not at any given time. The classes are rated as follows:		
Rating	Description	Score
<i>Improbable</i>	The possibility of the impact occurring is none, due either to the circumstances, design or experience. The chance of this impact occurring is zero (0%).	1
<i>Possible</i>	The possibility of the impact occurring is very low, due either to the circumstances, design or experience. In a rural environment, once noise levels exceed 38.7 dBA (see also section 3.5.9) less than 10% of receptors may be annoyed with WTN.	2
<i>Probable</i>	There is a possibility that the impact will occur to the extent that provisions must be made. At noise levels exceeding 45 dBA up to 50% of people may become annoyed with WTG at night.	3

<i>Highly Likely</i>	It is most likely that the impacts will occur at some stage of the development. At noise levels ranging between 45 and 52 dBA, between 50% and 75% of receptors may become annoyed with WTN.	4
<i>Definite</i>	The impact will take place regardless of any prevention plans and only mitigation actions or contingency plans to contain the effect can be relied on. Any noise levels higher than 52 dBA is expected to annoy most receptors in the vicinity of a WEF.	5

This EIA criteria are similar to the criteria used by Dracoulides (2010 [37]), though the potential values of assigned to each selected criteria were not defined by the author in the October 2010 noise study.

6.6 IDENTIFYING THE POTENTIAL IMPACTS WITHOUT MITIGATION MEASURES (WOM)

Following the assignment of the necessary weights to the respective aspects, criteria are summed and multiplied by their assigned probabilities, resulting in a Significance Rating (SR) value for each impact (prior to the implementation of mitigation measures) as highlighted in **Table 6-7**.

Table 6-7: Impact Assessment Criteria – Significance without Mitigation

SR<30	Low (L)	Impacts with little real effect and which should not have an influence on or require modification of the project design or alternative mitigation. No mitigation is required.
30<SR <60	Medium (M)	Where it could have an influence on the decision unless it is mitigated. An impact or benefit which is sufficiently important to require management. Of moderate significance - could influence the decisions about the project if left unmanaged.
SR>60	High (H)	The impact is significant, mitigation is critical to reduce impact or risk. Resulting impact could influence the decision depending on the possible mitigation. An impact which could influence the decision about whether or not to proceed with the project.

6.6.1 Identifying the Potential Impacts with Mitigation Measures (WM)

All noise impacts can be managed to acceptable levels with sufficient capital and management commitments. Determination of significance refers to the foreseeable significance of the impact after the successful implementation of the necessary mitigation measures. Significance with mitigation is rated on the scale defined in **Table 6-8**.

Table 6-8: Impact Assessment Criteria – Significance with Mitigation

SR<30	Low (L)	The impact is mitigated to the point where it is of limited importance.
30<SR <60	Medium (M)	Notwithstanding the successful implementation of the mitigation measures, to reduce the negative impacts to acceptable levels, the negative impact will remain of significance. However, taken within the overall context of the project, the persistent impact does not constitute a fatal flaw.
SR>60	High (H)	The impact is of major importance. Mitigation of the impact is not possible on a cost-effective basis. The impact is regarded of high importance and taken within the overall context of the project, is regarded as a fatal flaw. An impact regarded as high significance after mitigation could render the entire development option or entire project proposal unacceptable.

7 METHODS: CALCULATION OF NOISE LEVELS

7.1 POINT²³ AND AREA²⁴ NOISES – CONSTRUCTION AND OPERATIONAL ACTIVITIES

The noise emissions from various sources were calculated in detail for the conceptual construction and operational activities by using the sound propagation algorithms described by the ISO 9613-2 model. The following were considered:

- The octave band sound pressure emission levels of processes and equipment;
- The distance of the receivers from the noise sources;
- The impact of atmospheric absorption;
- The operational details of the proposed Project, such as projected areas where activities will be taking place;
- Screening corrections where applicable;
- Topographical layout; and
- Acoustical characteristics of the ground.

Potential operational cycles were not considered and a worst-case scenario was evaluated, assuming that all activities and equipment generate the maximum noise level 100% of the time.

The ISO 9613-2 noise propagation model is used, as it is the noise model most recommended to calculate WTN. The uncertainties and limitations of the ISO 9613 model is well defined; and while there are a number of different noise propagation models that one can use, all of them have uncertainties and limitations.

Therefore, the ISO 9613 noise propagation model is the model most frequently recommended, with this noise propagation model preferred in Australia (EPA, 2009) [41], the United Kingdom (IOA, 2013) [65], Canada (CanWEA, 2007) [17], United States of America (NARUC, 2011) [89] and the European Union (Directive 2002/49/EC)²⁵ [25, 36].

²³ Typically a WTG, or a stationary noise generating activity or piece of equipment.

²⁴ Such as a large surface vibrating, up to a defined area where equipment is moving around. It can include an industrial project where the locations of noise generating activities or equipment cannot be defined. This is used as a worst-case, as the inclusion of a large area source(s) tend to over model noise levels.

²⁵ This directive does not recommend but actually stipulate the use of this noise model for industrial noise sources.

7.2 ROAD TRAFFIC NOISE LEVELS

The noise emission into the environment due to project road traffic (mainly construction traffic) will be estimated using a simplified noise propagation model described in SANS 10210:2004. It mainly considers the distance of receptor from the road as well as average speeds of travel. Factors that are not considered include:

- Topography and barrier effects (noise levels could be over-estimated);
- Road construction material (noise levels could be over-estimated);
- Types of vehicles used (noise levels could be under-estimated);
- Road gradient (noise levels could be over- or under-estimated); and
- Ground acoustical conditions (noise levels could be over-estimated).

8 ASSUMPTIONS AND LIMITATIONS

8.1 LIMITATIONS - ACOUSTICAL MEASUREMENTS AND ASSESSMENTS

Ambient sound levels are the cumulative effects of innumerable sounds generated at various instances both far and near. A high measurement may not necessarily mean that the area is always noisy. Similarly, a low sound level measurement will not necessarily mean that the area is always quiet, as sound levels will vary over seasons, time of day, dependant on faunal characteristics (mating season, dawn chorus⁽²⁶⁾ early hours of the morning, temperature etc.), vegetation in the area and meteorological conditions (especially wind).

Selecting an ideal measurement location could be difficult, with various criteria assessed to identify the viability of a certain location as a point to define ambient sound levels. When selecting a measurement location, the most important criteria would be:

1. Security of the instrument (minimise risk to the technician; prevent theft; sabotage of the equipment);
2. Safety of the equipment (ensure that it does not prevent, interfere or limit typical agricultural or household activities; ensure that the instrument are not in a location where an animal could damage the instrument); and lastly,
3. The suitability of the measurement location to define ambient sound levels (the presence of certain trees or equipment, wetland or other water resources will influence ambient sound level significantly).

As such, after ensuring that the instrument is safe and secure, there are various environmental factors that could influence ambient sound levels measured. These constraints and limitations are discussed below and could include:

- Seasonal changes in the surrounding environment can influence typical ambient sound levels, as many faunal species are more active during warmer periods than the colder periods. As an example, cicada is usually only active during warmer periods. Certain cicada species can generate noise levels up to 120 dB for mating or distress purposes, sometimes singing in synchronisation magnifying noise levels they produce from their tymbals⁽²⁷⁾;
- Defining ambient sound levels using the result of one 10-minute measurement may be very inaccurate (very low confidence level in the results) relating to the reasons mentioned above, and measurements over a longer-term period is critical;

⁽²⁶⁾ Environ. We Int. Sci. Tech. *Ambient noise levels due to dawn chorus at different habitats in Delhi*. 2001. Pg. 134.

⁽²⁷⁾ Clyne, D. "Cicadas: Sound of the Australian Summer, *Australian Geographic*" Oct/Dec Vol 56. 1999.

- Some equipment that could influence measurements may be missed when deploying instruments, or, the equipment may not be audible. This could include equipment such as hidden water pumps and associated pipelines and outflows, Eskom stepdown transformers, hidden compressors, inverters, condensers or other electrical equipment, etc. While not audible during deployment, such equipment may significantly influence ambient sound levels during quiet periods;
- Type, the number and sizes of trees in the vicinity of the instrument, as well as the distances between the microphone and these trees. Certain trees, especially fruiting trees could attract birds and other animals that will significantly impact on ambient sound levels;
- Type and number of animals in the vicinity of the microphone. Dogs, chickens, geese, etc. generate different noises randomly both night and day, and other livestock (sheep, goats, cattle, horses, etc.) kept in enclosures will also raise noise levels, especially if these animals are penned in large numbers;
- Measurements over wind speeds of 3 m/s could provide data influenced by wind-induced noises. However, when determining the ambient sound levels associated with increased wind speeds, it is desired to measure ambient sound levels at higher wind speeds;
- Ambient sound levels recorded near rivers, streams, wetlands, trees and bushy areas can be high due to faunal activity which can dominate the sound levels around the measurement point (specifically during summertime, rainfall event or during dawn chorus of bird songs). This generally is still considered naturally quiet and accepted as features of the natural environment, and in various cases sought after and pleasing. Ambient sound level data measured in such area however should not be used to develop an opinion in the potential prevailing ambient sound levels in the larger area;
- Exact location of a sound level meter in an area in relation to structures, infrastructure, vegetation, wetlands and external noise sources will influence measurements. It may determine whether you are measuring anthropogenic sounds from a receptors dwelling, or environmental ambient baseline contributors of significance (faunal, roads traffic, railway traffic movement etc.); and

As a residential area develops the presence of people will result in increased dwelling related sounds. These are generally a combination of traffic noise, voices, animals and equipment (incl. TV's and Radios). The result is that ambient sound levels will increase as an area matures.

8.2 CALCULATING NOISE EMISSIONS – ADEQUACY OF PREDICTIVE METHODS

Limitations due to the calculations of the noise emissions into the environment include the following:

- Many sound propagation models do not consider sound characteristics as calculations are based on an equivalent level (with the appropriate correction implemented e.g. tone or impulse). These other characteristics include intrusive sounds or amplitude modulation;
- Most sound propagation models do not consider refraction through the various temperature layers (specifically relevant during the night-times);
- Most sound propagation models do not consider the low frequency range (third octave 16 Hz – 31.5 Hz). This would be relevant to facilities with a potentially low frequency issue;
- Many environmental models consider sound to propagate in hemi-spherical way. Certain noise sources (e.g., a speaker, exhausts, fans) emit sound power levels in a directional manner;
- The impact of atmospheric absorption is simplified and very uniform meteorological conditions are considered. This is an over-simplification and the effect of this in terms of sound propagation modelling is difficult to quantify;
- Many environmental models are not highly suited for close proximity calculations; and
- Acoustical characteristics of the ground are over-simplified, with ground conditions accepted as uniform.

8.3 ADEQUACY OF UNDERLYING ASSUMPTIONS

Noise experienced at a certain location is the cumulative result of innumerable sounds emitted and generated both far and close, each in a different time domain, each having a different spectral character at a different sound level. Each of these sounds is also impacted differently by surrounding vegetation, structures and meteorological conditions that result in a total cumulative noise level represented by a few numbers on a sound level meter.

As previously mentioned, it is not the purpose of noise modelling to accurately determine a likely noise level at a certain receptor but to calculate a noise rating level that is used to identify potential issues of concern.

8.4 UNCERTAINTIES ASSOCIATED WITH MITIGATION MEASURES

Any noise impact can be mitigated to have a low significance; however, the cost of mitigating this impact may be prohibitive, or the measure may not be socially acceptable (such as the relocation of an NSR). These mitigation measures may be engineered, technological or due to management commitment.

For the purpose of the determination of the significance of the noise impact mitigation measures were selected that are feasible, mainly focussing on management of noise impacts using rules, policy and require a management commitment. This, however, does not mean that noise levels cannot be reduced further, only that to reduce the noise levels further may require significant additional costs (whether engineered, technological or management).

It was assumed the mitigation measures proposed for the construction phase, if any is included and proposed in this report, will be considered during the planning phase, implemented during the construction phase and continued during the operational phase.

8.5 UNCERTAINTIES OF INFORMATION PROVIDED

While it is difficult to define the character of a measured noise in terms of numbers (third octave sound power levels), it is difficult to accurately model noise levels at a receptor from any operation. The projected noise levels are the output of a numerical model with the accuracy depending on the assumptions made during the setup of the model. The assumptions include the following:

- It is technically difficult and time-consuming to improve the measurement of spectral distribution of large equipment in an industrial setting. This is due to the many correction factors that need to be considered (e.g., other noise sources active in the area, adequacy of average time setting, surrounding field non-uniformity etc.²⁸ as per SANS 9614-3:2005);
- That octave sound power levels selected for processes and equipment accurately represent the sound character and power levels of these processes and equipment. The determination of octave sound power levels in itself is subject to errors, limitations and assumptions with any potential errors carried over to any model making use of these results;
- Sound power emission levels from processes and equipment changes depending on the load the process and equipment are subject to. While the octave sound power level is the average (equivalent) result of a number of measurements, this measurement relates to a period that the process or equipment was subject to a certain load (work required from the engine or motor to perform action). Normally these measurements are collected when the process or equipment is under high load. The result is that measurements generally represent a worst-case scenario;
- As it is unknown which processes and equipment will be operational (when and for how long), modelling considers a scenario where processes and equipment are under

²⁸ SANS 9614-3:2005. "Determination of sound power levels of noise sources using sound intensity – Part 3: Precision method for measurement by scanning".

full load for a set time period. Modelling assumptions comply with the precautionary principle and operational time periods are frequently overestimated. The result is that projected noise levels would likely be over-estimated;

- Modelling cannot capture the potential impulsive character of a noise that can increase the potential nuisance factor, nor the potential effect of the modulation of amplitude of the noise;
- The XYZ topographical information is derived from the Advanced Spaceborne Thermal Emission and Reflection Radiometer (ASTER) Global Digital Elevation Model (DEM) data, a product of Japan's Ministry of Economy, Trade, and Industry (METI) and the National Aeronautical and Space Administration (NASA). There are known inaccuracies and artefacts in the data set, yet this is still one of the most accurate data sets to obtain 3D-topographical information;
- The impact of atmospheric absorption is simplified and very uniform meteorological conditions are considered. This is an over-simplification and the effect of this in terms of sound propagation modelling is difficult to quantify;
- Receiver height will be assumed at a 4m height above surface level as recommended by the Institute of Acoustics (IOA, 2013) [65];
- Atmospheric conditions relating to an air temperature of 10°C and a 70% air humidity will be used to minimize the effect of air absorption (Bass *et al.*, 1996) [6], (IOA, 2013) [65], (Kaliski and Duncan, 2008) [70]; and
- Acoustical characteristics of the ground are over-simplified with ground conditions accepted as uniform. Seventy-five percent (75%) hard ground conditions will be modelled as the area, representing a potential worst-case scenario (Bass *et al.*, 1996) [6], (IOA, 2013) [65], (Kaliski and Duncan, 2008) [70].

Due to the uncertainties highlighted in section **8.2** and **8.5**, modelling generally could be out with as much as +10 dBA (the potential noise level is over-modelled), although realistic values ranging from 3 dBA to less than 5 dBA are more common in practice.

8.6 CONDITIONS TO WHICH THIS STUDY IS SUBJECT

This study is subject to the conditions as defined in **section 13**.

9 PROJECTED NOISE RATING LEVELS

9.1 CONCEPTUAL SCENARIOS – NOISE DUE TO FUTURE CONSTRUCTION ACTIVITIES

A noise model was developed considering the conceptual construction activities as discussed in **Section 5.1**. The proposed layout as provided by the applicant for the Springbok WEF is presented in **Figure 9-1**. As can be seen from this layout, a number of different activities might take place close to potential NSR, each with a specific potential impact.

As it is unknown where the different activities may take place, it was selected to model the impact of the noisiest activity (laying of foundation totalling 113.6 dBA cumulative noise impact – various equipment operating simultaneously – see **Table 5-1**) at all locations where wind turbines may be erected, calculating how this may impact on noise levels at NSR²⁹ (see **Figure 9-2**).

The projected noise levels relating to the various construction activities are defined in:

- **Appendix F, Table 2** for daytime construction activities; and,
- **Appendix F, Table 3** for night-time construction activities (even though night-time activities may be unlikely to occur).

²⁹ The potential cumulative (worst-case) noise level due to construction activities at an NSR are plotted against the distance from the NSR and a potential construction activity. As the expected noise level will be well less than 40 dBA at NSR further than a 1,000m from a construction activity, they were not included in this figure

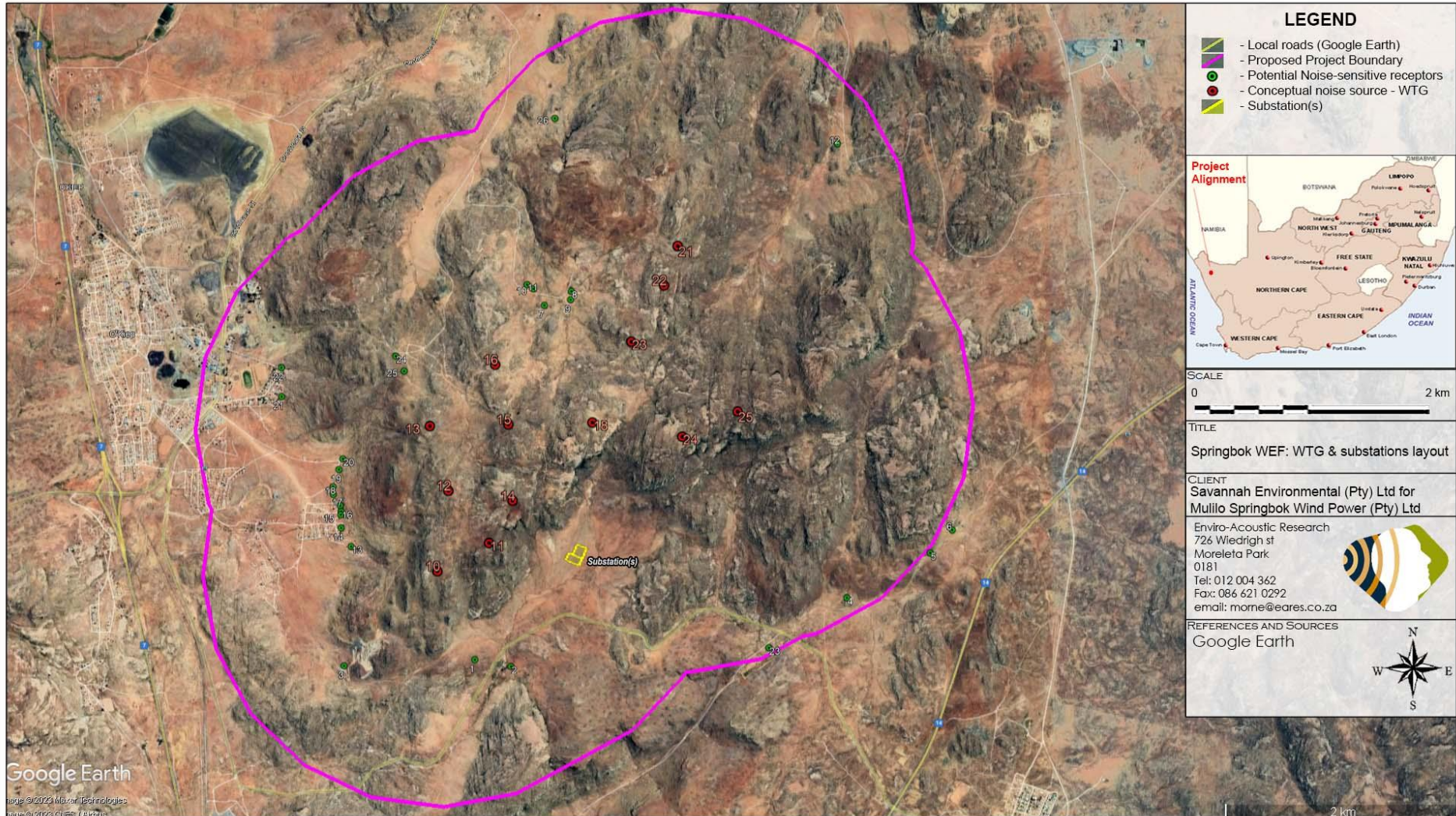

Figure 9-1: WTG locations and associated infrastructure for the proposed Springbok WEF

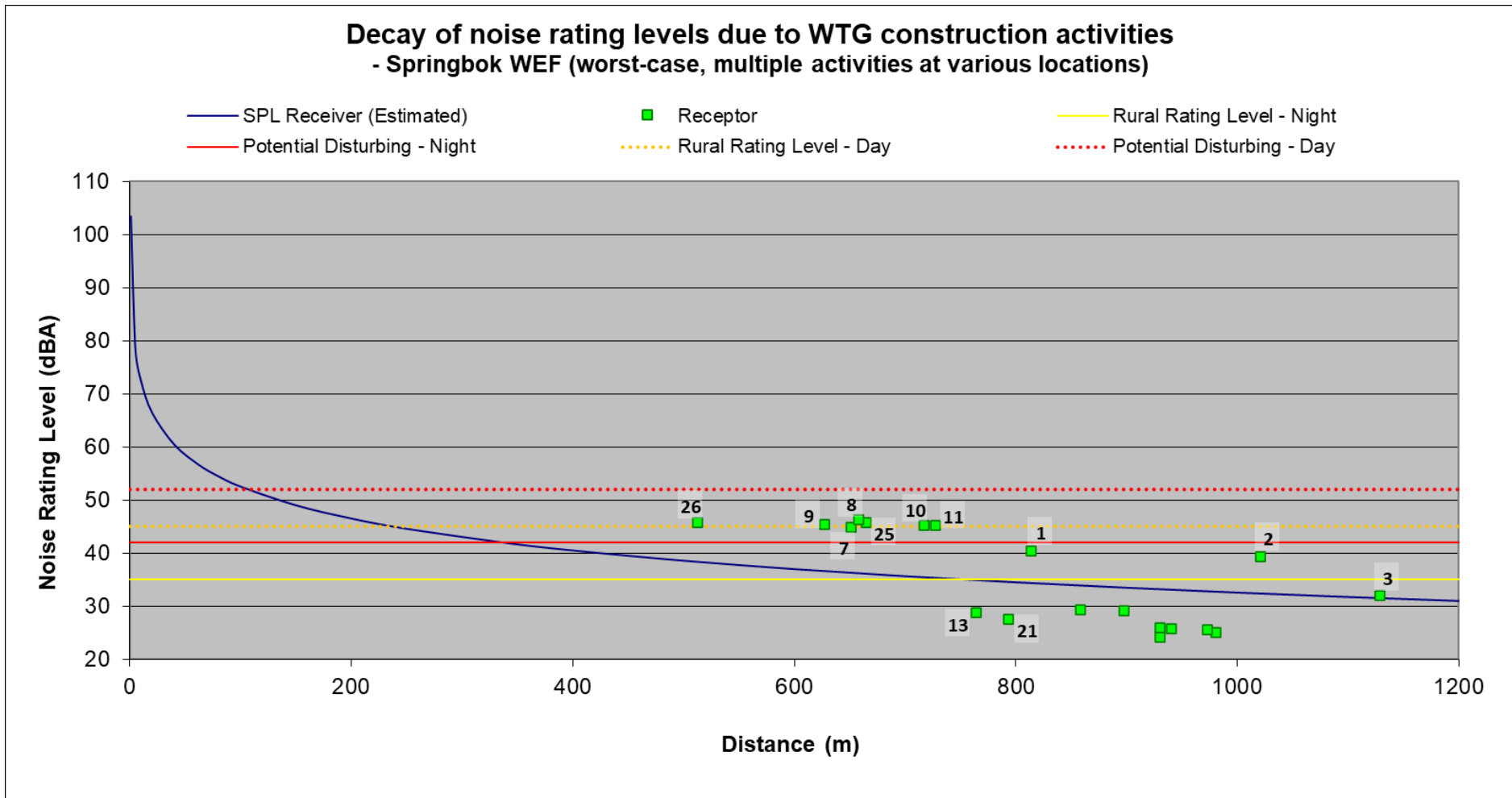

Figure 9-2: Projected conceptual construction noise levels for the proposed Springbok WEF

9.2 CONCEPTUAL SCENARIOS – NOISE DUE TO FUTURE OPERATIONAL ACTIVITIES

While the significance of daytime noise impacts was considered, times when a quiet environment is desired (at night for sleeping, weekends etc.) are more critical. Surrounding receptors would desire and require a quiet environment during the night-time (22:00 – 06:00) timeslot and ambient sound levels during the night-time period is critical. It should be noted that maintenance activities normally take place during the day, but normally involve a few light-delivery vehicles moving around during the course of the day, an insignificant noise source. As such maintenance activities will not be considered.

Noise models were developed considering the conceptual operational activities as discussed in **Section 5.2**, with the potential noise rating level contours associated with the potential operational activities illustrated in:

- **Figure 9-3** when considering the worst-case SPL WTG (such as the Goldwind GW165 6.0 MW turbine operating at a wind speed of 10 m/s - Goldwind, 2021 **[51]**; Goldwind, 2022 **[52]**). Ambient sound level at this wind speed is assumed to be 41.5 dBA as proposed in **Table 6-2**, with the projected worst-case noise levels defined per NSR in **Appendix F, Table 4**;
- **Figure 9-4** when considering a potential typical WTG (such as the Nordex N163-5.X turbine operating at a wind speed of 8 m/s - Nordex, 2021 **[93]**). Ambient sound level at this wind speed is assumed to be 41.5 dBA as proposed in **Table 6-2**, with the projected worst-case noise levels defined per NSR in **Appendix F, Table 5**; and
- **Figure 9-5** when considering a potential best-case WTG (such as the Vestas V162 6.0 MW turbine operating at a wind speed of 10 m/s - Vestas, 2020 **[138]**). Ambient sound level at this wind speed is assumed to be 41.5 dBA as proposed in **Table 6-2**, with the projected worst-case noise levels defined per NSR in **Appendix F, Table 6**.

9.3 POTENTIAL CUMULATIVE NOISE IMPACTS

Cumulative noise impacts generally only occur when noise sources (such as other wind turbines) are closer than 2,000m from each other (around 1,000 m from the conceptual receptor located between them). The cumulative impact also only affects the area between the wind turbines of the various wind farms and normally only relate to the operational phase.

If the wind turbines of one wind farm are further than 2,000 m from the wind turbines of the other wind farm, the magnitude (and subsequently the significance) of the cumulative noise impact is reduced. If the distance between the wind turbines of two wind farms are further than 4,000m, cumulative noise impacts are non-existent. This is illustrated in **Figure 9-6**.

At the time this report was compiled, the author was not aware of any similar wind renewable projects within 30 km (Renewable Energy EIA Application database, third quarter, 2022), and definitely none within the potential area of influence (maximum of 5,000m).

9.4 POTENTIAL DECOMMISSIONING, CLOSURE AND POST-CLOSURE NOISE LEVELS

The potential for a noise impact to occur during the decommissioning and closure phase will be much lower than that of the construction and/or operational phases. This is because:

- Decommissioning activities normally are limited to the daytime period, due to the lower urgency to complete this phase; and
- Decommissioning activities normally use smaller and less equipment, generating less noise than the typical construction or operational phases.

If required, the noise levels for decommissioning can be compared with the daytime construction phase noise level and the noise impact is similar or less.

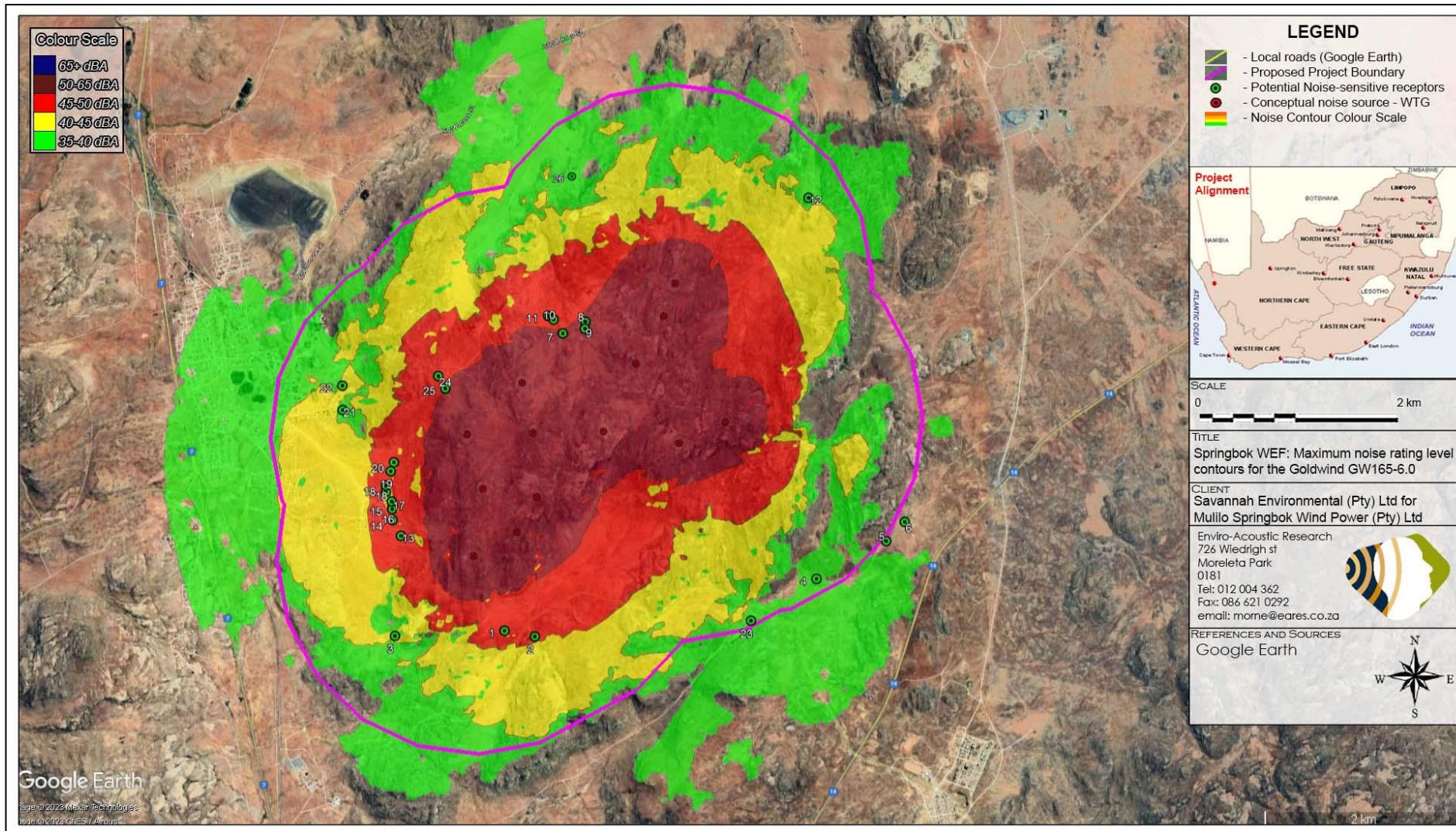

Figure 9-3: Projected future noise rating level contours (worst-case SPL of 112.6 dBA re 1 pW)

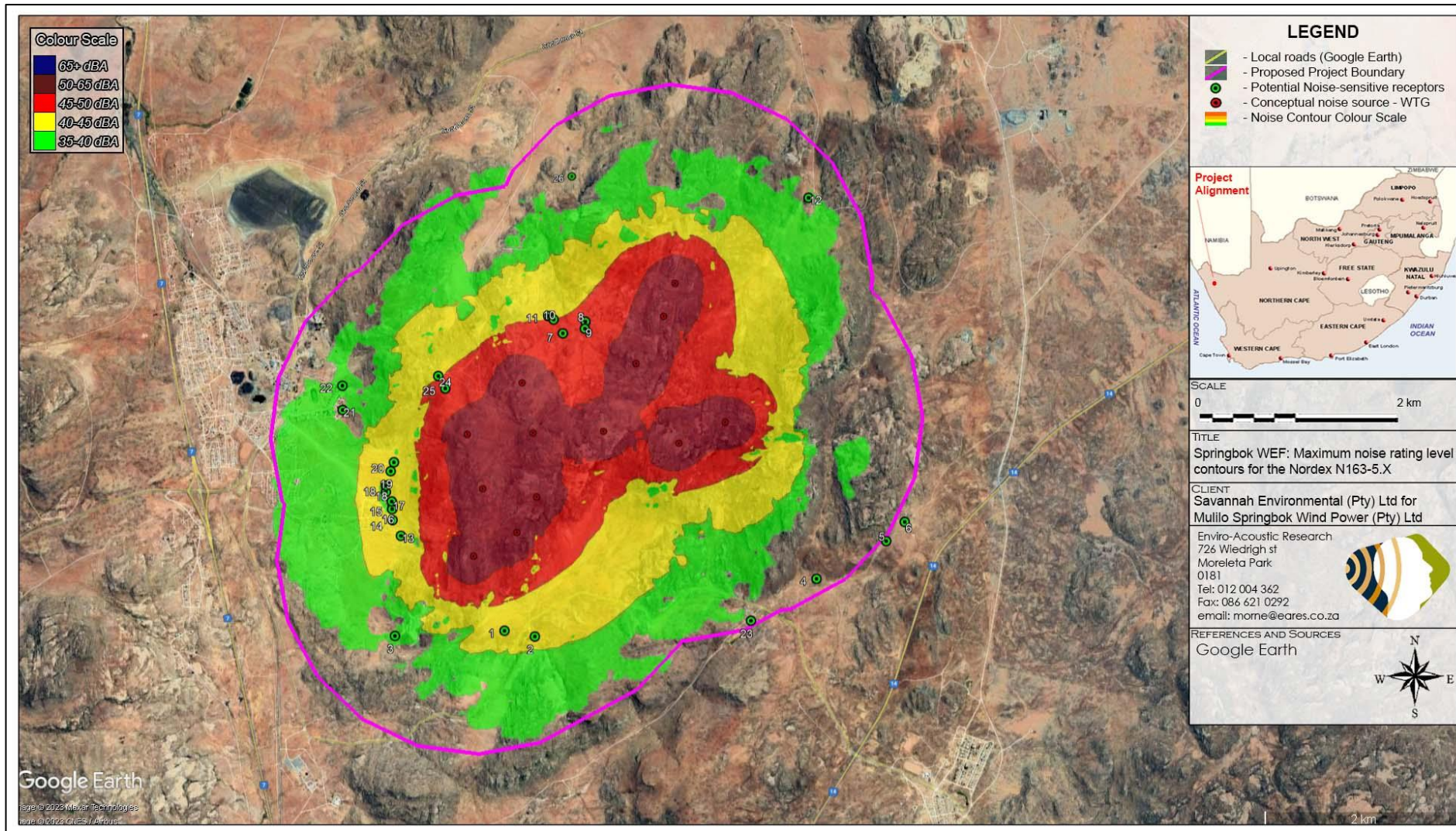

Figure 9-4: Projected future noise rating level contours (potential SPL of 109.2 dBA re 1 pW)

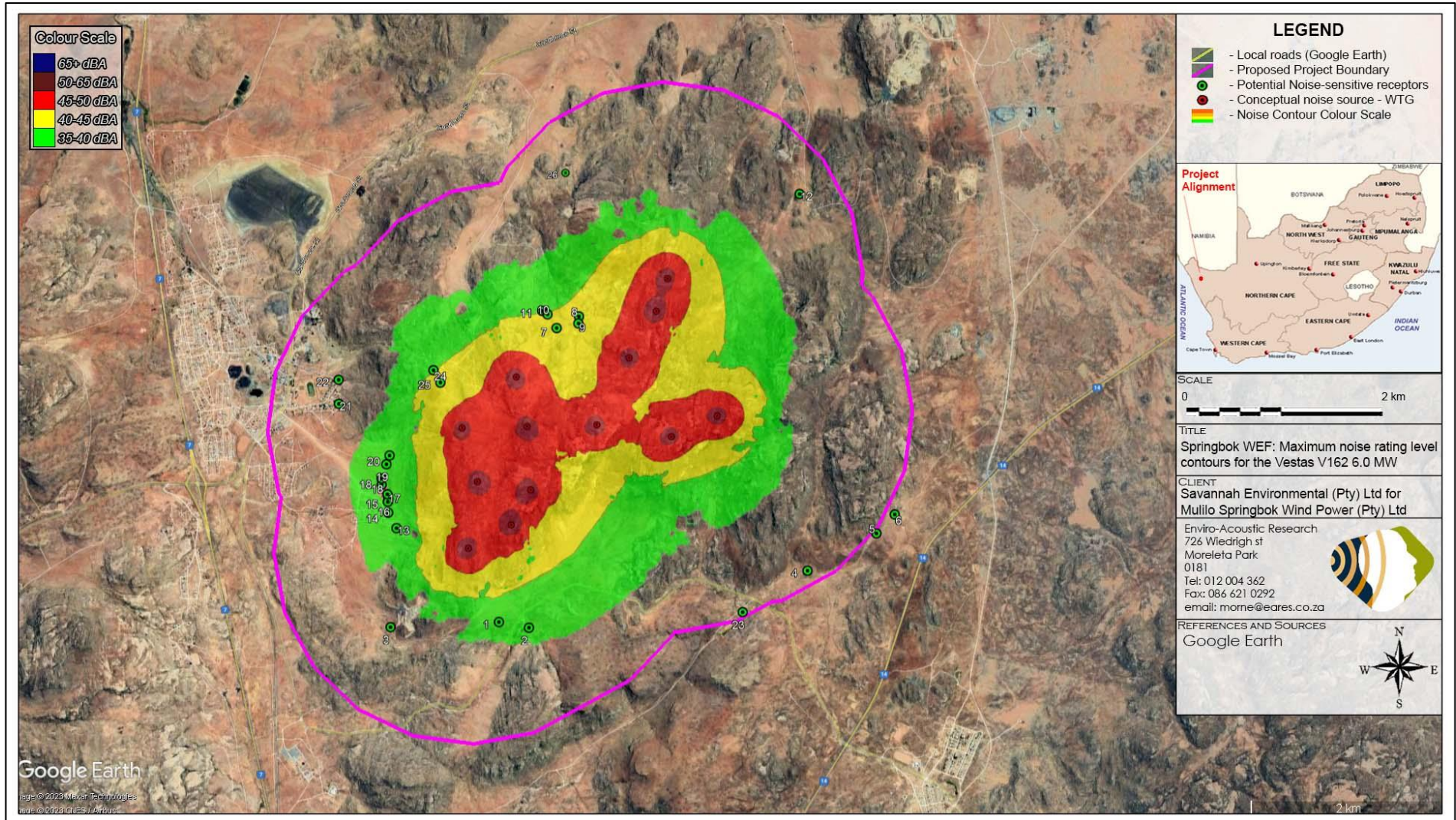

Figure 9-5: Projected future noise rating level contours (best-case SPL of 104.3 dBA re 1 pW)

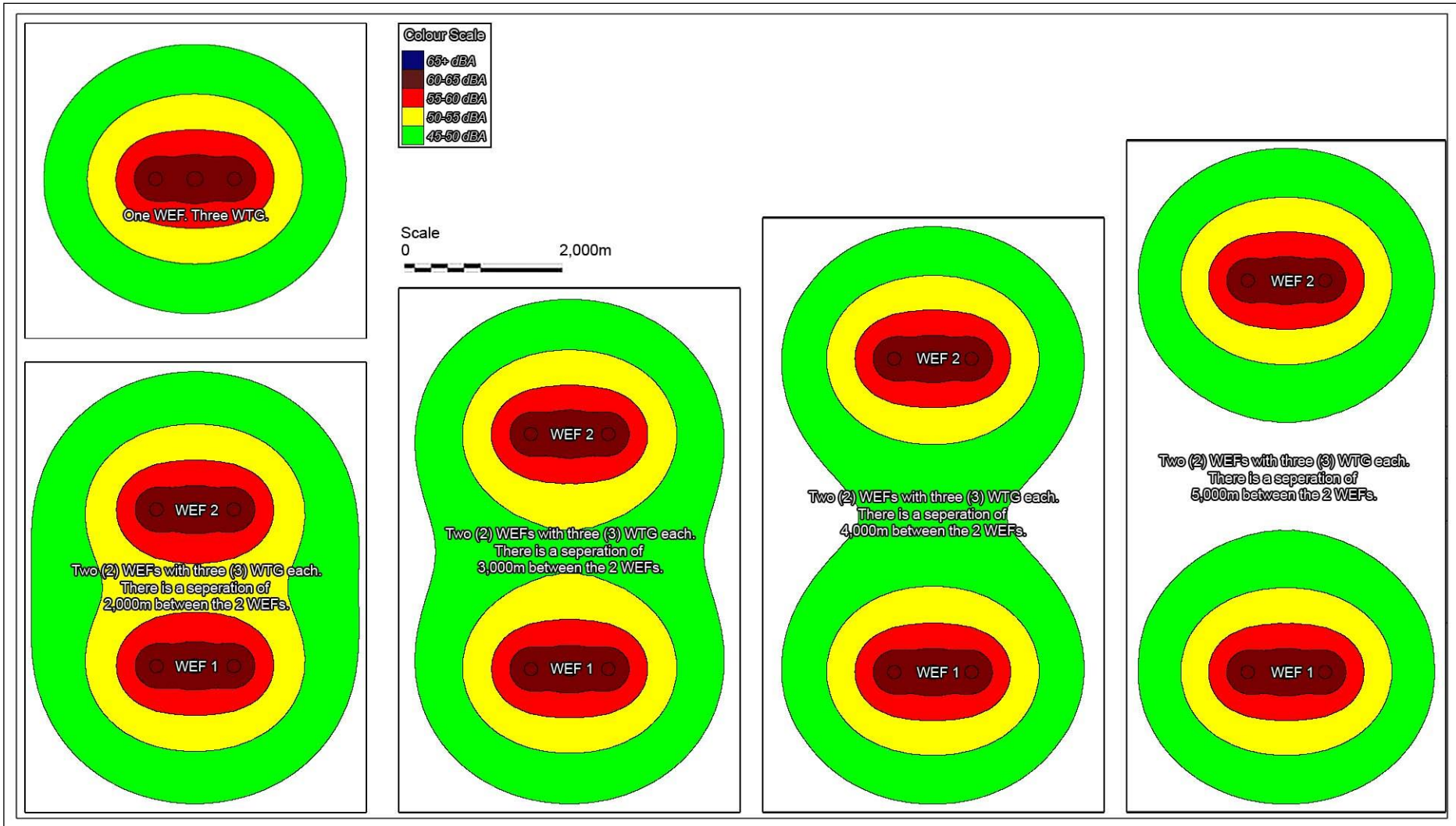

Figure 9-6: Effect of distance between wind turbines – potential cumulative noise

10 SIGNIFICANCE OF THE NOISE IMPACT

10.1 NOISES RELATING TO THE PLANNING AND DESIGN PHASE

Activities that relate to the planning and design phases are normally limited to surveying and site visits. These activities are normally limited to the daytime period, with the activities having temporary noise impacts of a minor consequence. The significance of the noise impact for the planning and design phase will be negative low and will not be considered in this assessment.

However, potential mitigation measures to reduce noise levels at NSR must be considered during the planning and design phase.

10.2 NOISES ASSOCIATED WITH CONSTRUCTION ACTIVITIES

The potential noise levels for the various construction activities (as conceptualised) were calculated in **section 9.1**. The potential significance of the construction noise impacts was:

- estimated per NSR in **Appendix F, Table 2**, with the potential significance of the daytime noise impact summarized in **Table 10-1 (sub-section 10.6)**; and,
- estimated per NSR in **Appendix F, Table 3**, with the potential significance of the night-time noise impacts is summarized in **Table 10-2 (sub-section 10.6)**.

10.3 NOISE IMPACT DUE TO FUTURE OPERATIONAL ACTIVITIES

The noise levels associated with the operating WTG was calculated in **section 9.2**, with the noise levels illustrated in **Figure 10-1** for different wind speeds, and illustrated in **Figure 9-3** for the worst-case WTG (using a SPL of 109.2 dBA re 1 pW). The potential significance of operational noise impacts was summarized in **Table 10-3 (sub-section 10.6)** for the daytime period and in **Table 10-4 (sub-section 10.6)** for the night-time period. The assessment considered:

- the potential worst-case SPL WTG (such as the Goldwind GW165 6.0 MW turbine operating at a wind speed of 10 m/s - Goldwind, 2021 **[51]**; Goldwind, 2022 **[52]**) with the projected worst-case noise levels defined per NSR in **Appendix F, Table 4**. Potential noise levels at different wind speeds are illustrated in **Figure 10-1**;
- a potential typical WTG (such as the Nordex N163-5.X turbine operating at a wind speed of 8 m/s - Nordex, 2021 **[93]**) with the projected worst-case noise levels defined per NSR in **Appendix F, Table 5**. Potential noise levels at different wind speeds are illustrated in **Figure 10-2**; and

- a potential best-case WTG (such as the Vestas V162 6.0 MW turbine operating at a wind speed of 10 m/s - Vestas, 2020 [138]) with the projected worst-case noise levels defined per NSR in **Appendix F, Table 6**. Potential noise levels at different wind speeds are illustrated in **Figure 10-3**.

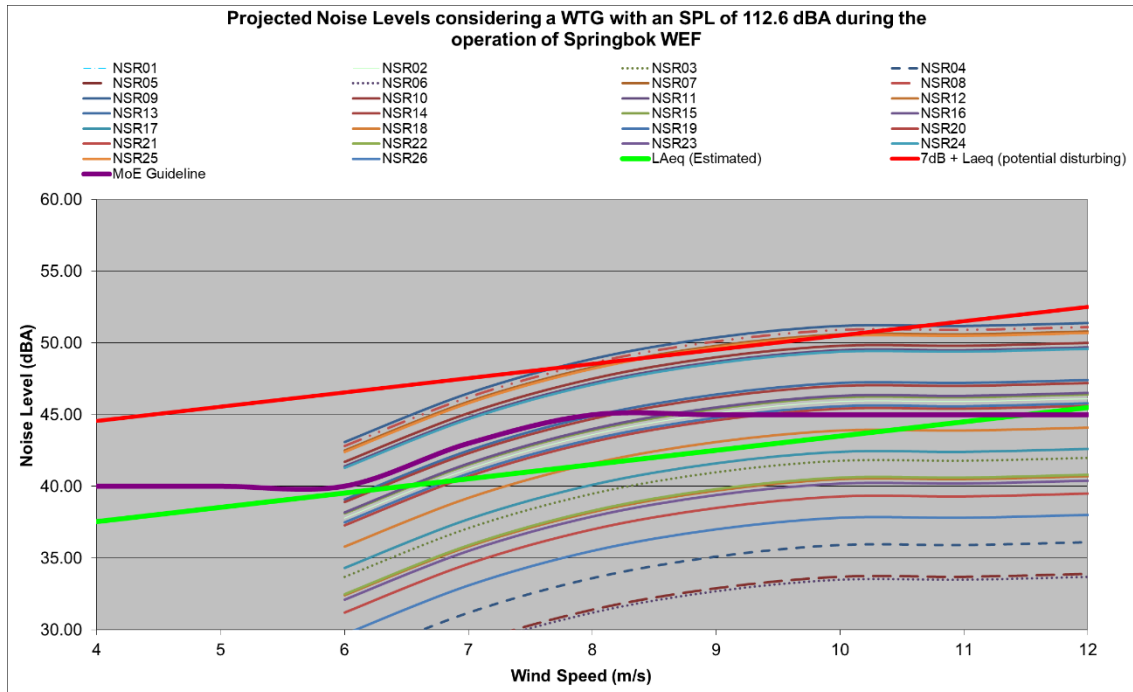

Figure 10-1: Projected noise levels for a WTG with an SPL of 112.6 dBA (re 1 pW) at different wind speeds

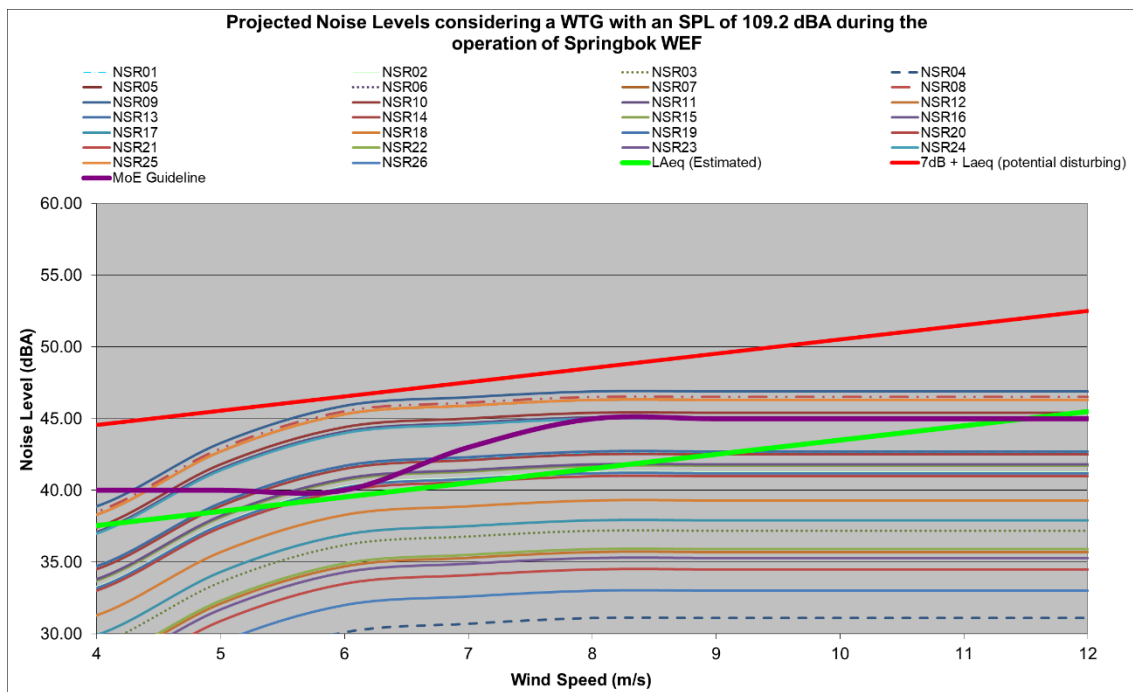

Figure 10-2: Projected noise levels for a WTG with an SPL of 109.2 dBA (re 1 pW) at different wind speeds

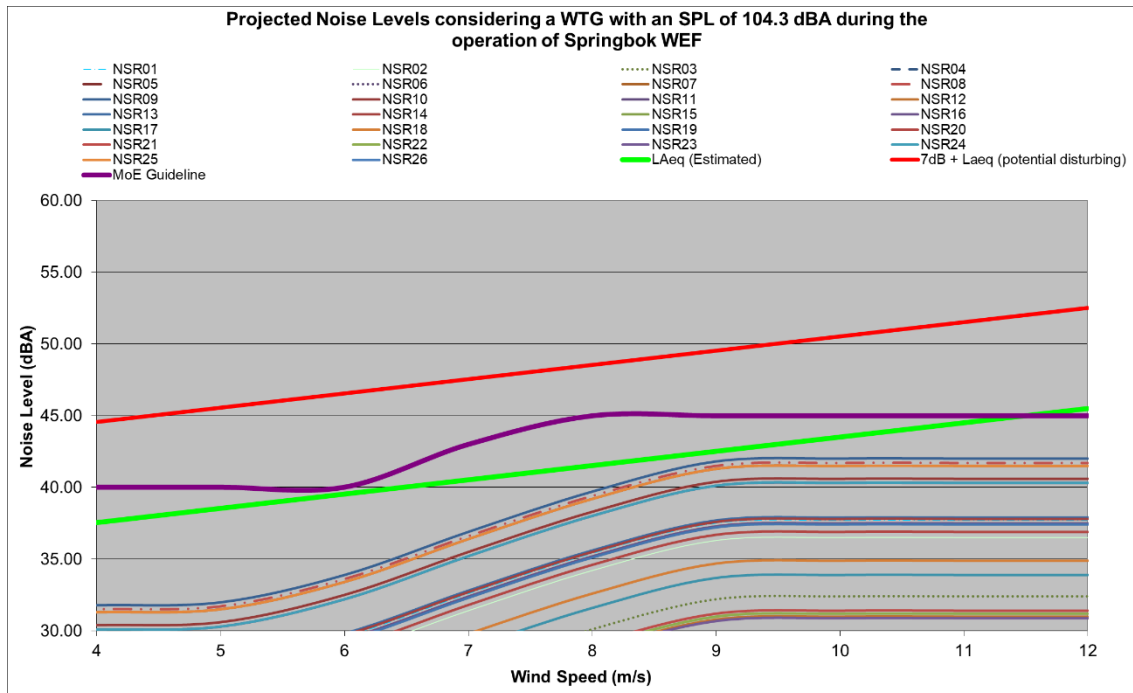

Figure 10-3: Projected noise levels for a WTG with an SPL of 104.3 dBA (re 1 pW) at different wind speeds

10.4 CUMULATIVE NOISE IMPACT FROM OTHER WEFS

There is a very low risk of cumulative noises during the construction phase, because it is unlikely that construction activities will take place simultaneously at other WEFS (though no were identified in the area).

In addition, there are no other WTG of other WEFS located or proposed within 5,000m (the potential area of influence) from the WTG of the proposed springbok WEF, and there will be no potential for a cumulative noise impact.

10.5 EVALUATION OF ALTERNATIVES

10.5.1 Alternative 1: No-go option

The ambient sound levels will remain as is and the area would keep the rural noise character.

10.5.2 Alternative 2: Proposed Renewable Power Generation activities

The proposed renewable energy activities (worst-case evaluated) will slightly raise the noise levels at a number of the closest potential NSR. There is no alternative location where the wind farm can be developed as the presence of a viable wind resource determines the

viability of a commercial WEF. While the location cannot be moved, the wind turbines within the WEF can be moved around, although this layout is the result of numerous evaluations and modelling to identify the most economically feasible and environmentally sustainable layout.

Considering the ambient sound levels measured on-site, the projected noise rating levels will be elevated at the closest NSR, but will have a similar or less than the on-site ambient sound levels at NSR located further than 2,000 m from the WTG. It is slightly possible that the noise rating levels could exceed the ambient sound levels during certain periods although it is unlikely to impact on the quality of living (at night) at receptors living further than 1,000m from WTG. Mitigation is available and included to reduce the potential noise impact on NSR identified closer to proposed WTG.

The project however will greatly assist in the provision of energy, which will allow further economic growth and development in South Africa and locally. The project will generate short and long-term employment and other business opportunities and promote renewable energy in South Africa and locally. People in the area that are not directly affected by increased noises generally have a more positive perception of the renewable projects and understand the need and desirability of the project.

10.6 NOISE IMPACT ASSESSMENT TABLES

Table 10-1: Impact Assessment: Daytime WTG construction activities

Nature:		
Based on ambient sound levels measured at other locations as well as the sound levels measured by Dracoulides (2010 [37]), daytime ambient sound levels could range from 20 dBA to more than 80 dBA, with this assessment using an average of 44.1 dBA (as measured by Dracoulides (2010 [37]) at MP02 and MP04). Daytime ambient sound levels are assumed to be typical of a rural noise district most of the time. Introduced noises will be audible over large distances during quiet periods (especially during low wind conditions).		
Various construction activities (development of laydown areas and the hard standing areas, excavation of foundations, concreting of foundations and the assembly of the wind turbines tower and components, as well as construction of other infrastructure) taking place simultaneously during the day will increase ambient sound levels due to air-borne noise.		
The projected noise levels, the change in ambient sound levels as well as the potential noise impact is defined per NSR in Appendix F, Table 2 and summarized in this table.		
	Without mitigation	With mitigation
Magnitude (Table 6-3)	Low (6)	Low (6)
Extent (Table 6-4)	Local (2)	Local (2)
Duration (Table 6-5)	Short-term (2)	Short-term (2)
Probability (Table 6-6)	Improbable (1)	Improbable (1)
Significance	Low (6)	Low (6)
Status (+ or -)	Negative	Negative
Reversibility	High	High
Loss of resources?	No	No
Can impacts be mitigated?	Yes	Yes

Mitigation:

The significance of the noise impact is low for typical daytime construction activities and no additional mitigation is required or recommended.

Residual Risks:

There is no risk of any residual noises.

Table 10-2: Impact Assessment: Night-time WTG construction activities

Nature:

Based on ambient sound levels measured at other locations as well as the sound levels measured by Dracoulides (2010 [37]), night-time ambient sound levels could range from less than 20 dBA to more than 80 dBA, with this assessment using an average of 41.4 dBA (as measured by Dracoulides (2010 [37]) at MP04) for the areas close to Okiep, and 35 dBA for all areas further than 500 m from Okiep. Introduced noises will be audible over large distances during quiet periods (especially during low wind conditions).

Various construction activities (likely limited to the pouring of concrete as well as erection of WTG components) taking place simultaneously at night will increase ambient sound levels due to air-borne noise. The projected noise levels, the change in ambient sound levels as well as the potential noise impact is defined per NSR in **Appendix F, Table 3** and summarized in this table.

	Without mitigation	With mitigation
Magnitude (Table 6-3)	Very High (10)	Very High (10)
Extent (Table 6-4)	Regional (3)	Regional (3)
Duration (Table 6-5)	Short-term (2)	Short-term (2)
Probability (Table 6-6)	Possible (2)	Improbable (1)
Significance	Medium (30)	Low (15)
Status (+ or -)	Negative	Negative
Reversibility	High	High
Loss of resources?	No	No
Can impacts be mitigated?	Yes	Yes

Mitigation:

The significance of the noise impact is medium and additional mitigation is recommended. Potential mitigation measures would include:

- Minimizing night-time activities when working within 2,000m from NSR. Work should only take place at one WTG location to minimize potential night-time cumulative noises (when working at night within 2,000m from NSR);
- The applicant must notify the NSR when night-time activities will be taking place within 1,000m from the NSR;
- If possible, the applicant can plan construction activities at WTG located within 1,000 m from NSR to take place during a period when the structures are not used for residential purposes; and
- The applicant must plan the completion of noisiest activities (such a pile driving, rock breaking and excavation) during the daytime period (even though it is expected that it is highly unlikely that this may take place at night).

Residual Risks:

There is no risk of any residual noises.

Table 10-3: Impact Assessment: Daytime operation of WTG considering the worst-case SPL

Nature:		
<p>WTG will only operate during periods with increased winds, when ambient sound levels are higher than periods with no or low winds. As discussed and motivated in section 6.4 (as proposed in Table 6-2 and illustrated in Figure 4-3), ambient sound levels will likely be higher, with this assessment assuming an ambient sound level of 41.5 dBA at a wind speed of 8 m/s, and 43.5 dBA at a wind speed of 10 m/s.</p> <p>Numerous WTG of the Springbok WEF operating simultaneously during the day will increase ambient sound levels due to air-borne noise from the WTG. Ambient sound levels are normally higher during the daytime period, with receptors generally more active and distracted which would decrease the probability of an impact occurring. The projected noise levels and the change in ambient sound levels is defined for the identified NSR in Appendix F, Table 4.</p>		
	Without mitigation (using a WTG with an SPL of 112.6 dBA)	With mitigation (using a WTG with an SPL of 112.6 dBA)
Magnitude (Table 6-3)	High (8)	Moderate (6)
Extent (Table 6-4)	Local (2)	Local (2)
Duration (Table 6-5)	Long-term (4)	Long-term (4)
Probability (Table 6-6)	Likely (3)	Possible (2)
Significance	Medium (42)	Low (24)
Status (+ or -)	Negative	Negative
Reversibility	High	High
Loss of resources?	No	No
Can impacts be mitigated?	Yes	Yes
Mitigation:		
<p>The significance of the noise impact is medium and additional mitigation is recommended and required. Mitigation measures are available and it is recommended that:</p> <ul style="list-style-type: none"> - the applicant design and implement a noise abatement programme, which may include operating certain wind turbines in a reduced noise emission mode (it will be required that the applicant select a WTG that have the capability to operate in a reduced noise emission modes); or - The applicant can select a WTG that have a maximum sound power emission level less than 107.0 dBA (re 1 pW) at locations closer than 2,000 m from any verified NSR; or - The applicant can change to layout to move certain WTG further from verified NSR (the layout should be modelled to ensure that the potential noise levels will be less than 45 at all NSR); or - The applicant can reduce the number of WTG that may be used at this WEF (the layout should be modelled to ensure that the potential noise levels will be less than 45 at all NSR); or - The applicant can relocate certain of the verified NSR. 		
Residual Risks:		
There is no risk of any residual noises.		

Table 10-4: Impact Assessment: Night-time operation of WTG considering the worst-case SPL

Nature of impact:		
WTG will only operate during period with increased winds, when ambient sound levels are higher than periods with no or low winds. As discussed and motivated in section 6.4 (as proposed in Table 6-2 and illustrated in Figure 4-4), ambient sound levels will likely be higher, with this assessment assuming an ambient sound level of 41.5 dBA at a wind speed of 8 m/s, and 43.5 dBA at a wind speed of 10 m/s.		
Numerous WTG of the Springbok WEF operating simultaneously at night will increase ambient sound levels due to air-borne noise from the WTG. The projected noise levels, the change in ambient sound levels as well as the potential noise impact is defined per NSR in Appendix F, Table 4 and summarized in this table. The potential noise level (and significance) when using a quieter WTG (such as the Nordex N163 5.X WTG with the reported SPL of 106.4 dBA re 1 pW) is presented in Appendix F, Table 5 .		
	Without mitigation	With mitigation
Magnitude (Table 6-3)	High (8)	Low (4)
Extent (Table 6-4)	Regional (3)	Regional (3)
Duration (Table 6-5)	Long-term (4)	Long-term (4)
Probability (Table 6-6)	Definite (5)	Possible (2)
Significance	High (75)	Low (22)
Status (+ or -)	Negative	Negative
Reversibility	High	High
Loss of resources?	No	No
Can impacts be mitigated?	Yes	Yes
Mitigation:		
The significance of the noise impact is high and additional mitigation is recommended and required. Mitigation measures are available and it is recommended that:		
<ul style="list-style-type: none"> - the applicant design and implement a noise abatement programme, which may include operating certain wind turbines in a reduced noise emission mode (it will be required that the applicant select a WTG that have the capability to operate in a reduced noise emission modes); or - The applicant can select a WTG that have a maximum sound power emission level less than 107.0 dBA (re 1 pW) at locations closer than 2,000 m from any verified NSR; or - The applicant can change to layout to move certain WTG further from verified NSR (the layout should be modelled to ensure that the potential noise levels will be less than 45 at all NSR); or - The applicant can reduce the number of WTG that may be used at this WEF (the layout should be modelled to ensure that the potential noise levels will be less than 45 at all NSR); or - The applicant can relocate certain of the verified NSR. 		
Residual Risks:		
There is no risk of any residual noises.		

11 MITIGATION OPTIONS

This study considers the potential noise impact on the surrounding environment due to the construction, operational and future decommissioning activities associated with the Springbok WEF project. It was determined that the potential noise impacts, without mitigation, would be:

- of a **low significance** for the daytime construction activities (hard standing areas, excavation and concreting of foundations and the assembly of the WTG and other infrastructure);
- of a potential **medium significance** for the night-time construction activities (the pouring of concrete, erection of WTG). Mitigation is available and presented in this assessment that would reduce the significance of night-time noise impacts to **low**;
- of a **medium significance** for daytime operational activities (noises from wind turbines) when considering the worst-case SPL. Mitigation is available and presented in this assessment that would reduce the significance of night-time noise impacts to **low**; and
- of a **high significance** for night-time operational activities (noises from wind turbines) when considering the worst-case SPL. Mitigation is available and presented in this assessment that would reduce the significance of night-time noise impacts to **low**.

There is a **low significance** for a cumulative noise impact to occur during the operational phase.

The project developer must know that community involvement needs to continue throughout the project. Annoyance is a complicated psychological phenomenon, as with many industrial operations, expressed annoyance with sound can reflect an overall annoyance with the project, rather than a rational reaction to the sound itself. At all stages, surrounding receptors should be informed about the project, providing them with factual information without setting unrealistic expectations. It is counterproductive to suggest that the activities will be inaudible due to existing high ambient sound levels. The magnitude of the sound levels will depend on a multitude of variables and will vary from day to day and from place to place with environmental and operational conditions. Audibility is distinct from the sound level, because it depends on the relationship between the sound level from the activities, the spectral character and that of the surrounding soundscape (both level and spectral character).

The developer must implement a line of communication (i.e., a help line where complaints could be lodged). All potential sensitive receptors should be made aware of these contact numbers. The proposed WEFs should maintain a commitment to the local community (people staying within 2,000 m from construction or operational activities) and respond to noise concerns in an expedient fashion. Sporadic and legitimate noise complaints could be raised. For example, sudden and sharp increases in sound levels could result from mechanical malfunctions or perforations or slits in the blades. Problems of this nature can be corrected quickly and it is in the developer's interest to do so.

11.1 MITIGATION OPTIONS AVAILABLE TO REDUCE NOISE IMPACT DURING THE CONSTRUCTION PHASE

The significance of the noise impact will be of a **low** significance during the daytime period, though there is a potential of a noise impact of **medium** significance for night-time construction activities. Mitigation measures are recommended to ensure that the potential annoyance due to noise are minimized. Potential measures could include:

- Minimizing night-time activities when working within 2,000 m from NSR. Work should only take place at one WTG location to minimize potential night-time cumulative noises (when working at night within 2,000 m from NSR);
- The applicant must notify the NSR when night-time activities will be taking place within 1,000 m from the NSR;
- If possible, the applicant can plan construction activities at WTG located within 1,000 m from NSR to take place during a period when the structures are not used for residential purposes; and
- The applicant must plan the completion of noisiest activities (such a pile driving, rock breaking and excavation) during the daytime period (even though it is expected that it is highly unlikely that this may take place at night).

11.2 MITIGATION OPTIONS AVAILABLE TO REDUCE NOISE IMPACT DURING OPERATION

The significance of the noise impact during the operation phase would be **medium** for day-, and **high** for night-time operational activities. Operating WTG will be clearly audible at the closest NSR and potentially at disturbing levels. It is therefore recommended that:

- the applicant design and implement a noise abatement programme, which may include operating certain wind turbines in a reduced noise emission mode (it will be required that the applicant select a WTG that have the capability to operate in a reduced noise emission modes); **or**

- The applicant can select a WTG that have a maximum sound power emission level less than 107.0 dBA (re 1 pW) at locations closer than 2,000 m from any verified NSR; **or**
- The applicant can change to layout to move certain WTG further from verified NSR (the layout should be modelled to ensure that the potential noise levels will be less than 45 at all NSR); **or**
- The applicant can reduce the number of WTG that may be used at this WEF (the layout should be modelled to ensure that the potential noise levels will be less than 45 at all NSR); **or**
- The applicant can relocate certain of the verified NSR.

To ensure that noise does not become an issue for future residents, landowners or the local communities, it is recommended that the applicant get written agreement from current landowners/community leaders that no new residential dwellings will be developed within areas enveloped by the 42 dBA noise level contour.

11.3 MITIGATION OPTIONS AVAILABLE TO REDUCE NOISE IMPACT DURING DECOMMISSIONING

The potential significance of the noise impact would be similar as the construction phase (**low** significance) and no further mitigation is recommended or required for the decommissioning phase.

11.4 MITIGATION AND MANAGEMENT CONDITIONS TO BE INCLUDED IN THE EMPR AND ENVIRONMENTAL AUTHORIZATION

It is recommended that the project applicant:

1. re-evaluate the noise impact should the layout be revised where:
 - a. any WTG, located within 1,500 m from a verified NSR, are moved closer to the NSR;
 - b. the number of WTG within 2,000 m from an NSR are increased;
2. re-evaluate the noise impact once the final make and model of WTG was selected;
3. ensure that equipment is well maintained and fitted with the correct and appropriate noise abatement measures. Engine bay covers over heavy equipment could be pre-fitted with sound absorbing material. Heavy equipment that fully encloses the engine bay should be considered, ensuring that the seam gap between the hood and vehicle body is minimised;
4. include a component covering environmental noise in the Health and Safety Induction to sensitize all employees and contractors about the potential impact from

noise, especially those employees and contractors that have to travel past receptors at night, or might be required to do work close (within 1,500 m) to NSR at night. This should include issues such as minimising the use of vehicle horns;

5. investigates any reasonable and valid noise complaint if registered by a receptor staying within 2,000 m from the location where construction activities are taking place, or where night-time construction activities are required, or where an operational WTG are located. A complaint register, keeping a full record of the complaint, must be kept by the applicant;
6. with regard to unavoidable noisy night-time construction activities in the vicinity of NSR (closer than 1,500 m from any identified NSR), the contractor and Environmental Control Officer (ECO) must liaise with local NSR on how best to minimise impact and the NSR must be kept informed of the nature and duration of intended activities; and
7. where practicable, mobile equipment should be fitted with broadband (white-noise generators/alarms^{30 31}), rather than tonal reverse alarms.

³⁰White Noise Reverse Alarms: <http://www.brigade-electronics.com/products>.

³¹ <https://www.constructionnews.co.uk/home/white-noise-sounds-the-reversing-alarm/885410.article> - White noise sounds the reversing alarm

12 ENVIRONMENTAL MONITORING PLAN

Environmental Noise Monitoring can be divided into two distinct categories, namely:

- Passive monitoring – the registering of any complaints (reasonable and valid) regarding noise; and
- Active monitoring – the measurement of noise levels at identified locations.

Active noise monitoring is recommended because the projected noise levels are more than 42 dBA (more than 7 dBA of the night-time rating level of a rural noise district) for the layout assessed for any WTG with an SPL exceeding 104.5 dBA (re 1 pW).

In addition, should a reasonable and valid noise complaint be registered, the Applicant should investigate the noise complaint as per the guidelines in **sub-section 12.1** and **12.2**. These guidelines should be used as a rough guideline as site-specific conditions may require that the monitoring locations, frequency or procedure be adapted.

12.1 MEASUREMENT LOCALITIES AND FREQUENCY

The applicant must develop and implement an environmental noise monitoring programme before the construction phase start, conducting active night-time noise measurements at selected NSR (at a minimum at NSR08 or 9 and NSR25) before the construction activities start. The applicant must repeat the environmental noise monitoring during the operational phase (once the WEF is fully operational) at the same locations at least once.

Should any of these locations not being used for residential purposes, measurements at these NSR would not be required.

The noise specialist employed to do the noise monitoring must recommend and motivate the need (or not) for continued noise monitoring.

In addition, should there be a valid and reasonable noise complaint, once-off noise measurements must be conducted at the location of the person that registered a valid and reasonable noise complaint. The measurement location should consider the direct surroundings to ensure that other sound sources cannot influence the reading.

12.2 MEASUREMENT PROCEDURES

Ambient sound measurements should be collected as defined in SANS 10103:2008. Due to the variability that naturally occurs in sound levels at most locations, it is recommended that semi-continuous measurements are conducted over a period of at least 48 hours, covering at least a full day- (06:00 – 22:00) and two full night-time (22:00 – 06:00) periods (though longer measurements are highly recommended).

13 ENVIRONMENTAL MANAGEMENT

Environmental Management Objectives are difficult to be defined for noise because ambient sound levels would slowly increase as developmental pressures increase in the area. This is due to increased traffic associated with increased development, human habitation, agriculture and even eco-tourism. While these increases in ambient sound levels may be low (and insignificant) it has the effect of cumulatively increasing the ambient sound levels over time.

The moment the WEF facility stops operation, ambient sound levels will drop to levels similar to the pre-WEF levels, or to new levels (typical of other areas with a similar developmental character) if other developments have occurred in the interim.

For the purpose of this report potential environmental management objectives would be:

- That the development of the WEF project should not result in noise levels exceeding 55 dBA during the day; and
- That the development of the WEF project should not result in noise levels exceeding 45 dBA at night.

As noise levels will not exceed 55 dBA during both the construction and operational phases, Environmental Management is mainly focusing on the night-time period as summarized in:

- **Table 13-1** for the planning phase (to ensure that noise levels are with the acceptable limits during the future operational phase:
- **Table 13-2** for night-time activities during the construction phase; and
- **Table 13-3** for the operational of the WTG.

Table 13-1: Environmental Management for planning phase

Objective: Project activities not to result in noise levels exceeding 45 dBA		
Project Components:	Future operation of WTG	
Potential Impact:	Noise levels impacting on the quality of living of people living at NSR05	
Activity/Risk source	Future operation of WTG	
Mitigation: Target	Night-time noise levels less than 45 dBA at locations used for residential purposes	
Mitigation: Action / Control	Responsibility	Timeframe
Applicant to design a noise abatement programme that will ensure that operational noise levels are less than 45 dBA at all potential NSR;	Applicant	Planning phase, before development of WEF
Applicant to re-evaluate the noise impact should the layout be revised where any WTG, located within 1,500 m from a confirmed NSR, are moved closer to potential NSR.	Applicant	Planning phase, before development of WEF
Applicant to re-evaluate the noise impact should the layout be revised where the number of WTG within 2,000 m from an NSR are increased	Applicant	Planning phase, before development of WEF

re-evaluate the noise impact once the final make and model of WTG was selected	Applicant	Planning phase, before development of WEF
Noise monitoring to define current ambient sound levels at selected NSR before the construction phase start.	ECO	Before the construction phase start
Performance Indicator	Calculated noise levels should be 45 dBA at structures used residential purposes	
Monitoring	No monitoring required during planning phase	

Table 13-2: Environmental Management for night-time construction activities

Objective: Project activities not to result in noise levels exceeding night-time noise levels of 45 dBA		
Project Components:	Construction activities and construction equipment generating disturbing and nuisance noises	
Potential Impact:	Night-time noise levels impacting on the quality of living of people living at NSR05	
Activity/Risk source	Construction activities	
Mitigation: Target	Night-time noise levels less than 45 dBA at locations used for residential purposes	
Mitigation: Action / Control	Responsibility	Timeframe
ECO to ensure that equipment is well maintained and fitted with the correct and appropriate noise abatement measures;	ECO	Ongoing during construction phase
ECO to include a component covering environmental noise in the Health and Safety Induction to sensitize all employees and contractors about the potential impact from noise;	ECO	Ongoing during construction phase
ECO to notify NSR before night-time construction activities are to take place within 1,500 m from this NSR (if the structures are used for residential activities during the proposed construction period).	ECO	Construction activities within 1,500 m from NSR, if NSR is used for residential purposes
Performance Indicator	Night-time noise levels less than 45 dBA	
Monitoring	Noise level monitoring before the construction phase start at NSR such as NSR8 or NSR9, as well as NSR25. Inspection of equipment by ECO.	

Table 13-3: Environmental Management for night-time operational period

Objective: Project activities not to result in noise levels exceeding 45 dBA		
Project Components:	Operation of WTG within 3,000 m from structure used for residential purposes	
Potential Impact:	Noise levels impacting on the quality of living of people living at NSR05	
Activity/Risk source	Operation of WTG	
Mitigation: Target	Night-time noise levels less than 45 dBA at locations used for residential purposes	
Mitigation: Action / Control	Responsibility	Timeframe
ECO to conduct noise monitoring when a reasonable and valid noise complaint are received from an NSR living within 2,000m from a WTG of the project.	ECO	Within 2 months after a noise complaint is registered
Noise monitoring to confirm that noise levels associated with operating WTG are less than 45 dBA at NSR	ECO	During the first year once the project is operational
Performance Indicator	Night-time noise levels less than 45 dBA	

14 OPINION FOR A PART 1 AMENDMENT

As the EA validity will be extended beyond 10 years, the DFFE requires additional information to confirm that the environment has not changed. This is discussed in the following table.

Table 14-1: Summary of information required for EA validity

Question	Statements
A site visit to define the status of the environment compared to the status of the environment during the original assessment	A site visit was conducted 2 and 3 March 2023 to define the status of all potential NSR identified for this assessment. Dracoulides (2010 [37]) did not identify specific NSR, focusing on the outskirts of Okiep and the boundaries of the proposed project.
Whether the original impact ratings are still applicable	The impact ratings used by Dracoulides (2010 [37]) is similar as the impact rating used by the author. Dracoulides, 2010 however have not defined the scores used in his assessment, with the author using the scores as defined in section 6.5 .
Whether the original mitigation measures are still valid	Dracoulides, 2010 [37] recommended that: <ul style="list-style-type: none"> • Certain WTG be relocated; • That noise monitoring be conducted at certain locations, with a biannual monitoring frequency.
The need for new or additional mitigation measures	Due the significant changes in the WTG technologies and capabilities since the original assessment, various mitigation measures were added as defined in section 11 . These mitigation measures should replace the original recommendations.
New guidelines that must be taken into consideration for this assessment	GNR. 320 was promulgated in March 2020, with a number of requirements, including, amongst others: <ul style="list-style-type: none"> • A site sensitivity verification to confirm or dispute current land uses and sensitivities; • A baseline description of potential receptors as well as ambient noise levels.
Changes to the environment that occurred since the initial EA was issued	Using aerial images (see Figure 2-2 [2021] and Figure 2-3 [2009]), it appears that there has been little new developments within the vicinity of the project area in the last 10 years
Similar developments that may cumulatively contribute to noise levels in the area	As per the latest available Renewable Energy EIA Application database (3 rd quarter, 2022), there are two wind projects, approximately 24 km to the east and 32 km to the west. At this distance these projects will not cumulatively contribute to noise levels in the vicinity of the Springbok project.

15 CONCLUSIONS AND RECOMMENDATIONS

This report is an Environmental Noise Impact Assessment of the noise impacts due to the proposed development, operation and decommissioning of the Springbok WEF (and associated infrastructure) east of Okiep in the Northern Cape Province. It is based on a predictive model to estimate potential noise levels due to the various activities and to assist in the identification of potential issues of concern.

It was determined that the potential noise impacts, without mitigation, would be:

- of a **low significance** for the daytime construction activities (hard standing areas, excavation and concreting of foundations and the assembly of the WTG and other infrastructure);
- of a potential **medium significance** for the night-time construction activities (the pouring of concrete, erection of WTG). Mitigation is available and presented in this assessment that would reduce the significance of night-time noise impacts to **low**;
- of a **medium significance** for daytime operational activities (noises from wind turbines) when considering the worst-case SPL. Mitigation is available and presented in this assessment that would reduce the significance of night-time noise impacts to **low**; and
- of a **high significance** for night-time operational activities (noises from wind turbines) when considering the worst-case SPL. Mitigation is available and presented in this assessment that would reduce the significance of night-time noise impacts to **low**.

There is a **low significance** for a cumulative noise impact to occur during the operational phase.

Active noise monitoring is recommended because the projected noise levels are more than 42 dBA (more than 7 dBA of the night-time rating level of a rural noise district) for the layout assessed for any WTG with an SPL exceeding 104.5 dBA (re 1 pW).

Subject to the condition that the applicant will select appropriate measures to ensure that the potential medium and high significance noise impact is eliminated, it is recommended that the proposed Springbok WEF (and associated infrastructure) be authorized. The WTG layout is considered acceptable should the applicant select to use a WTG with a SPL less than 107.0 dBA (re 1 pW).

It is recommended that the applicant re-evaluate the noise impact:

3. should the layout be revised where:
 - a. any WTG, located within 1,500 m from any NSR, are moved closer to the NSR;
 - b. the number of WTG within 2,000 m from NSR are increased; and
4. should the applicant make use of a wind turbine with a maximum SPL exceeding 107.0 dBA re 1 pW.

To ensure that noise does not become an issue for future residents, landowners or the local communities, it is recommended that the applicant get written agreement from current landowners and/or community leaders that no new residential dwellings will be developed within areas enveloped by the 42 dBA noise level contour.

16 REFERENCES

In this report reference was made to the following documentation:

1. Ambrose, SE and Rand, RW, 2011. *The Bruce McPherson Infrasound and Low Frequency Noise Study: Adverse health effects produced by large industrial wind turbines confirmed*. Rand Acoustics, December 14, 2011.
2. Autumn, Lyn Radle, 2007: *The effect of noise on Wildlife: A literature review*
3. Atkinson-Palombo, C and Hoen, B. 2014: *Relationship between Wind Turbines and Residential Property Values in Massachusetts – A Joint Report of University of Connecticut and Lawrence Berkley National Laboratory*. Boston, Massachusetts
4. Bakker, R.H., Pedersen, E., van den Berg, G.P., Stewart, R.E., Lok,W., Bouma, J. 2012: *Impact of wind turbine sound on annoyance, self-reported sleep disturbance and psychological distress*. Sci. Total Environ. 15 (425), 42–51
5. Barber, J.R., K.R. Crooks, and K. Fristrup. 2010. *The costs of chronic noise exposure for terrestrial organisms*. Trends Ecology and Evolution 25(3): 180–189
6. Bass JH *et al*, 1996: *Development of a wind farm noise propagation prediction model*. JH Bass, AJ Bullmore, E Sloth. Contract JOR3-CT95-0051. Renewable Energy Systems Limits, Hoare Lea & Partners Acoustics, Acoustica A/S
7. Bastasch, M; van Dam, J; Søndergaard, B; Rogers, A. 2006: *Wind Turbine Noise - An Overview*. Canadian Acoustics Vol. 34(2). pp. 7-15
8. Bayne EM *et al*, 2008: *Impacts of chronic anthropogenic noise from energy-sector activity on abundance of songbirds in the boreal forest*. Conservation Biology 22(5) 1186-1193.
9. Blickley, J.L. and Patricelli, G.L. 2010. *Impacts of Anthropogenic Noise on Wildlife: Research Priorities for the Development of Standards and Mitigation*. Journal of International Wildlife Law & Policy, 13:274–292.
10. Bolin *et al*, 2011: *Infrasound and low frequency noise from wind turbines: exposure and health effects*. Environ. Res. Lett. 6 (2011) 035103
11. Bowdler, D. 2005: *ETSU-R-97 Why it is Wrong*, Internet White Paper, New Acoustics, Dunbartonshire, Scotland, July 2005
12. Bowdler, Dick, 2008: *Amplitude modulation of wind turbine noise: a review of the evidence*
13. Bowdler, D. Bullmore, A. Davis, B. Hayes, M. Jiggins, M. Leventhall, G. McKenzie, A. 2009: *Prediction and Assessment of Wind Turbine Noise – Agreement about relevant factors for noise assessment from wind energy projects*. Acoustics, Vol 34, No 2. March/April 2009

14. Bray, W and James, R. 2011. *Dynamic measurements of wind turbine acoustic signals, employing sound quality engineering methods considering the time and frequency sensitivities of human perception*. Noise-Con 2011.
15. Broucek, J. 2014. *Effect of Noise on Performance, Stress and Behaviour of Animals*. Slovak J. Anim. Sci., 47, 2014 (2): 111-123
16. BWEA, 2005: *Low Frequency Noise and Wind Turbines – Technical Annex*
17. CanWEA, 2007: *Wind Turbines and Sound: Review and Best Practice Guidelines*. Canadian Wind Energy Association.
18. Chapman *et al.* 2013: *Spatio-temporal differences in the history of health and noise complaints about Australian wind farms: evidence for the psychogenic, "communicated disease" hypothesis*. Sydney School of Public Health, University of Sydney
19. Chief Medical Officer of Health, 2010: *The Potential Health Impact of Wind Turbines, Canada*
20. Conrady, K; Bolin, K; Sjöblom, A; Rutgersson, A. 2019: *Amplitude modulation of wind turbine sound in cold climates*. Applied Acoustics, Vol 158, 15 January 2020.
21. Cooper, 2012: *Are Wind Farms too close to communities*, The Acoustic Group (date posted on Wind-watch.org: Referenced on various anti-wind energy websites)
22. Cooper, S. Chan, C. 2020: *Determination of Acoustic Compliance of Wind Farms*. Acoustics **2020**, 2, 416–450; doi:10.3390/acoustics2020024
23. Council of Canadian Academies, 2015: *Understanding the Evidence: Wind Turbine Noise*. Ottawa (ON): The Expert Panel on Wind Turbine Noise and Human Health. Council of Canadian Academies
24. Crichton *et al.* 2014: *Can expectations produce symptoms from infrasound associated with wind turbines?. Health Psychology, Vol 33(4), Apr 2014, 360-364*
25. CSES, 2016: *Evaluation of Directive 2002/49/EC relating to the assessment and management of environmental noise*. The Centre for Strategy & Evaluation Services, European Commission, Brussels.
26. CSIR, 2002: *Integrated Environmental Management Information Series: Information Series 5: Impact Assessment*. Issued by the Department of Environmental Affairs and Tourism, Pretoria
27. CSIR, 2015: *The Strategic Environmental Assessment for Wind and Solar Photovoltaic Energy in South Africa*. Issued by the Department of Environmental Affairs and Tourism, Pretoria
28. Cummings, J. 2012: *Wind Farm Noise and Health: Lay summary of new research released in 2011*. Acoustic Ecology Institute, April 2012 (online resource:

- http://www.acousticecology.org/wind/winddocs/AEI_WindFarmsHealthResearch2011.pdf)
29. Cummings, J. 2009: *AEI Special Report: Wind Energy Noise Impacts*. Acoustic Ecology Institute, (online resource: <http://acousticecology.org/srwind.html>)
 30. DEFRA, 2003: *A Review of Published Research on Low Frequency Noise and its Effects*, Report for Defra by Dr Geoff Leventhall Assisted by Dr Peter Pelmear and Dr Stephen Benton
 31. DEFRA, 2007: *Research into Aerodynamic Modulation of Wind Turbine Noise: Final Report*
 32. DELTA, 2008: *EFP-06 project: Low Frequency Noise from Large Wind Turbines, a procedure for evaluation of the audibility for low frequency sound and a literature study*. Danish Energy Authority
 33. Derryberry EP *et al*, 2016: *Patterns of song across Natural and Anthropogenic Soundscapes suggest that White-Crowned Sparrows minimize acoustic masking and maximize signal content*. PLOS ONE| DOI: 10.1371/journal.pone.0154456, April 29, 2016
 34. Dooling, R. 2002. *Avian Hearing and the Avoidance of Wind Turbines*. National Renewable Energy Laboratory, NREL/TP-500-30844
 35. Dooling R. J., and A. N. Popper. 2007. *The effects of highway noise on birds*. Report to the California Department of Transportation, contract 43AO139. California Department of Transportation, Division of Environmental Analysis, Sacramento, California, USA
 36. Directive 2002/49/EC of the European Parliament and of the Council relating to the assessment and management of environmental noise
 37. Dracoulides, D.A. 2010: *Springbok Wind Farm Noise Impact Assessment*. Demos Dracoulides and Associates Environmental Engineers, Cape Town.
 38. Duncan, E. and Kaliski, K. 2008: *Propagation Modelling Parameters for Wind Power Projects*
 39. Ellenbogen, J.M., Grace, S., Heiger-Bernays, W.J., Manwell, J.F., Mills, D.A., Sullivan, K.A., Santos, S.L. 2012: *Wind Turbine Health Impact Study. Report of Independent Expert Panel*. Prepared for: Massachusetts Department of Environmental Protection. Massachusetts Department of Health
 40. Enertrag, 2008: *Noise and Vibration*. Hempnall Wind Farm (<http://www.enertraguk.com/technical/noise-and-vibration.html>)
 41. EPA, 2009: *Wind Farms Environmental Noise Guidelines*. Environmental Protection Authority, Adelaide, South Australia (Updated November 2021)

42. EPA, 2011: *Guidance Note on Noise Assessment of Wind Turbine Operations at EPA Licences Sites (NG3)*. Environmental Protection Agency, Office of Environmental Enforcement,
43. ETSU R97: 1996. *'The Assessment and Rating of Noise from Wind Farms: Working Group on Noise from Wind Turbines'*
44. Evans Tom, Cooper Jonathan, 2012: *Comparison of predicted and measured wind farm noise levels and implications for assessments of new wind farms*. Acoustics Australia, Vol. 40, No. 1, April 2012.
45. Evans, T. Cooper, J. Lenchine, V. 2012: *Infrasound Levels near Windfarms and in other Environments. Resonate Acoustics in conjunction with Environment Protection Authority, South Australia*
46. Fégeant, O. 2002: *Masking of Wind Turbine Noise: Influence of Wind Turbulence on Ambient Noise Fluctuations*.
47. Francis, C.D. et al, 2011: Different behavioural responses to anthropogenic noise by two closely related passerine birds. *Biol. Lett.* (2011) 7, 850-852 doi:10.1098 / rsbl.2011.0359
48. Francis, C.D. et al, 2012: Noise pollution alters ecological services: enhanced pollination and disrupted seed dispersal. *Proc. R Soc. B* doi: 10.1098 / rsbl.2012.0230
49. Garrad Hassan, 2013: *Summary of results of the noise emission measurement, in accordance with IEC 61400-11, of a WTGS of the type N117/3000*. Doc. GLGH-4286 12 10220 258-S-0002-A (extract from GLGH-4286 12 10220 258-A-0002-A)
50. Gibbons, S. 2014: *Gone with the Wind: Valuing the Visual Impacts of Wind turbines through House Prices*, Spatial Economics Research Centre
51. Goldwind. 2021: *Goldwind GW165-6.0 V42R01C100 Wind Turbine Noise Manual*. Document No. GW17XW.0145. Goldwind Technology Co., Ltd
52. Goldwind. 2022: *Description of GW165-6.0 Acoustic Performance*. Document No. GSC-17AP.a0006. Beijing Goldwind Science & Creation Wind Power Equipment Co., Ltd
53. Guillaume Dutilleux. *Anthropogenic outdoor sound and wildlife: it's not just bioacoustics!*. Soci'et'e Fran_çaise d'Acoustique. Acoustics 2012, Apr 2012, Nantes, France
54. Halfwerk, W. et al. 2011: *Low-frequency songs lose their potency in noisy urban conditions*. *PNAS*, August 30, 2011, vol. 108, no. 35, 14549-14554.
55. Hanning, 2010: *Wind Turbine Noise, Sleep and Health*. (referenced on a few websites, especially anti-wind energy. No evidence that the study has been published formally.)
56. Hartley, J.C., 1991: *Can Bush Crickets Discriminate Frequency?* University of Nottingham.

57. Havas, M and Colling, D. 2011: *Wind Turbines Make Waves: Why Some Residents Near Wind Turbines Become Ill*. *Bulletin of Science Technology & Society* published online 30 September 2011
58. Helldin, J.O., Jung, J., Neumann, W., Olsson, M., Skarin, A. and Widemo, F. 2012. *The impacts of wind power on terrestrial mammals: a synthesis*. Report 6510. Swedish Environmental Protection Agency.
59. Hessler, D. 2011: *Best Practices Guidelines for Assessing Sound Emissions From Proposed Wind Farms and Measuring the Performance of Completed Projects*. Prepared for the Minnesota Public Utilities Commission, under the auspices of the National Association of Regulatory Utility Commissioners (NARUC)
60. HGC Engineering, 2006: *Wind Turbines and Infrasound*, report to the Canadian Wind Energy Association
61. HGC Engineering, 2007: *Wind Turbines and Sound*, report to the Canadian Wind Energy Association
62. HGC Engineering, 2011: *Low frequency noise and infrasound associated with wind turbine generator systems: A literature review*. Ontario Ministry of the Environment RFP No. OSS-078696.
63. IFC, 2007: '*Environmental, Health, and Safety General Guidelines*'. International Finance Corporation, Washington
64. IFC, 2015: '*Environmental, Health, and Safety Guidelines for Wind Energy*'. International Finance Corporation, Washington
65. IOA, 2013: *A good practice guide to the application of ETSU-R-97 for the Assessment and Rating of Wind Turbine Noise*. Institute of Acoustics.
66. ISO 9613-2: 1996. '*Acoustics – Attenuation of sound during propagation outdoors – Part 2: General method of calculation*'
67. Janssen, S.A., Vos, H., Eisses, A.R., Pedersen, E. 2011: *A comparison between exposure-response relationships for wind turbine annoyance and annoyance due to other noise sources*. *J. Acoust. Soc. Am.* **130**(6), 3746–53 (2011)
68. Jeffery *et al*, 2013: *Adverse health effects of industrial wind turbines*, *Can Fam Physician*, 2013 May. **59**(5): 473-475
69. *Journal of Acoustical Society of America*, 2009: *Response to noise from modern wind farms in the Netherlands*
70. Kaliski K & Duncan E, 2008: *Propagation modelling Parameters for Wind Power Projects*.
71. Kaliski K & Wilson DK. 2011: *Improving predictions of wind turbine noise using PE modelling*. Noise-con 2011.
72. Kamperman GW & James RR, 2008: *The "How to" guide to siting wind turbines to prevent health risks from sound*

73. Karwowska, M. *et al.* 2015: *The effect of varying distances from the wind turbine on meat quality of growing-finishing pigs.* Ann. Anim. Sci., Vol. 15, No. 4 (2015) 1043–1054 DOI: 10.1515/aoas-2015-0051
74. Knopper, L.D., Ollson, C.A., McCallum, L.C., Whitfield Aslund, M.L., Berger, R.G., Souweine, K., McDaniel, M. 2014: *Wind turbines and human health.* Front. Public Health **19**(2), 63
75. Kroesen & Schreckenberg, 2011. *A measurement model for general noise reaction in response to aircraft noise.* J. Acoust. Soc. Am. 129 (1), January 2011, 200-210
76. Lohr, B. Wright, TF. Dooling, RJ. 2003: *Detection and discrimination of natural calls in masking noise by birds: estimating the active space of a signal.* Animal Behavior 65:763-777
77. Łopucki, R. Klich, D. Gielarek, S. 2016: An assessment of non-volant terrestrial vertebrates response to wind farms – a study of small mammals. Environ Monit Assess (2016) 188: 122
78. Łopucki, R. Klich, D. Gielarek, S. 2017: *Do terrestrial animals avoid areas close to turbines in functioning wind farms in agricultural landscapes?* Environ Monit Assess (2016) 188:122
79. McCunney, R.J., Mundt, K.A., Colby, W.D., Dobie, R., Kaliski, K., Blais, M. 2014: *Wind turbines and health: a critical review of the scientific literature.* J. Occup. Environ. Med. **56**(11), e108–30
80. McMurtry RY, 2011: *Toward a Case Definition of Adverse Health Effects in the Environs of Industrial Wind Turbines: Facilitating a Clinical Diagnosis.* Bulletin of Science Technology Society. August 2011 vol. 31 no. 4 316-320
81. MDEP: Massachusetts Department of Environmental Protection and Massachusetts Department of Public Health. Wind Turbine Health Impact Study: Report of Independent Expert Panel
82. Merlin, T., Newton, S., Ellery, B., Milverton, J., Farah, C. 2013: Systematic review of the human health effects of wind farms. National Health & Medical Research Council, Canberra
83. Miedema, H.M., Vos, H. 2003: *Noise sensitivity and reactions to noise and other environmental conditions.* J. Acoust. Soc. Am. **113**(3), 1492–504
84. Michaud, D.S., Keith, S.E., Feder, K., Voicescu, S.A., Marro, L., Than, J., Guay, M., Bower, T., Denning, A., Lavigne, E., Whelan, C. 2016: *Personal and situational variables associated with wind turbine noise annoyance.* J. Acoust. Soc. Am. **139**(3), 1455–66
85. Mikolajczak, J. *et al.* 2013: *Preliminary studies on the reaction of growing geese (Anser anser f. domestica) to the proximity of wind turbines.* Pol J Vet Sci. 2013;16(4):679-86. doi: 10.2478/pjvs-2013-0096.

86. Minnesota Department of Health, 2009: *Public Health Impacts of Wind Farms*
87. Ministry of the Environment, 2008: *Noise Guidelines for Wind Farms, Interpretation for Applying MOE NPC Publications to Wind Power Generation Facilities*
88. Møller H, 2010: *Low-frequency noise from large wind turbines*. J. Acoust. Soc. Am, 129(6), June 2011, 3727 - 3744
89. NARUC, 2011: *Assessing Sound Emissions from Proposed Wind Farms & Measuring the Performance of Completed Projects*. National Association of Regulatory Utility Commissioners. US Department of Energy
90. Nissenbaum A, 2012: *Effects of industrial wind turbine noise on sleep and health*. Noise and Health, Vol. 14, Issue 60, p 237 – 243.
91. Noise-con, 2008: *Simple guidelines for siting wind turbines to prevent health risks*
92. Noise quest, Aviation Noise Information & Resources, 2010: <https://www.noisequest.psu.edu/noiseeffects-animals.html>
93. Nordex. 2022 : *Noise Level, Power curves, Thrust curves – Nordex N163/5.X*. Document ref. F008_276_A12_EN, Revision 07. Nordex Energy SE & Co., Hamburg
94. Norton, M.P. and Karczub, D.G.: *Fundamentals of Noise and Vibration Analysis for Engineers*, Second Edition, 2003
95. O'Neal, et al. 2011: *Low frequency noise and infrasound from wind turbines*. Noise Control Eng. J. 59 (2), March-April 2011
96. Ortega, CP. 2012. *Ornithological Monographs. Chapter 2: Effects of noise pollution on birds: A brief review of our knowledge*. 74(1), pp.6-22.
97. Oud, M. 2012: *Low-frequency noise: a biophysical phenomenon* (http://www.leefmilieu.nl/sites/www3.leefmilieu.nl/files/imported/pdf_s/2012_OudM_Low-frequency%20noise_0.pdf) (unpublished webresource)
98. Parris, M. Schneider, A. 2009: *Impacts of traffic noise and traffic volume on birds of roadside habitats*. Ecology and Society 14(1): 29
99. Parry, G. 2008: *A review of the use of different noise prediction models for wind farms and the effects of meteorology*. The Journal of the Acoustical Society of America **123**, 3535 (2008); <https://doi.org/10.1121/1.2934501>
100. Pedersen, T. H. 2007: *The "Genlyd" Noise Annoyance Model*. DELTA report AV 1102/07
101. Pedersen, E., Hallberg, L.M., Persson, W.K. 2007: *Living in the vicinity of wind turbines—a grounded theory study*. Qual. Res. Psychol. **4**(1–2), 49–63
102. Pedersen, Eja; Halmstad, Högskolan I, 2003: *'Noise annoyance from wind turbines: a review'*. Naturvårdsverket, Swedish Environmental Protection Agency, Stockholm
103. Pedersen, E. 2011: *"Health aspects associated with wind turbine noise—Results from three field studies"*, Noise Control Eng. J. 59 (1), Jan-Feb 2011

104. Phillips, CV, 2011: "*Properly Interpreting the Epidemiologic Evidence About the Health Effects of Industrial Wind Turbines on Nearby Residents*". Bulletin of Science Technology & Society 2011 31: 303 DOI: 10.1177/0270467611412554
105. Pierpont, N. 2009: "*Wind Turbine Syndrome: A Report on a Natural Experiment*", K Select Books, 2009
106. Punch, et al. 2010: *Wind Turbine Noise. What Audiologists should know*. Audiology Today. JulAug2010
107. Quinn, J.L., M.J. Whittingham, S.J. Butler, and W. Cresswell. 2006. *Noise, predation risk compensation and vigilance in the chaffinch *Fringilla coelebs**. Journal of Avian Biology 37: 601-608
108. Rabin, L.A., R.G. Coss, D.H. Owings. 2006. *The effects of wind turbines on antipredator behavior in California ground squirrels (*Spermophilus beecheyi*)*. Biological Conservation 131: 410-420
109. Renewable Energy Research Laboratory, 2006: *Wind Turbine Acoustic Noise*
110. RenewableUK, 2013: *Wind Turbine Amplitude Modulation: Research to Improve Understanding as to its Cause and Effect*.
111. SANS 10103:2008. '*The measurement and rating of environmental noise with respect to annoyance and to speech communication*'.
112. SANS 10181:2003. '*The Measurement of Noise Emitted by Road Vehicles when Stationary*'.
113. SANS 10210:2004. '*Calculating and predicting road traffic noise*'.
114. SANS 10328:2008. '*Methods for environmental noise impact assessments*'.
115. SANS 10357:2004. *The calculation of sound propagation by the Concave method*'.
116. Schaub, A, J. Ostwald and B.M. Siemers. 2008. "*Foraging bats avoid noise*". The Journal of Experimental Biology 211: 3174-3180
117. Schmidt, J.H., Klokker, M. 2014: Health effects related to wind turbine noise exposure: a systematic review. PLoS ONE 9(12), e114183
118. Šottník, J. 2011: Influence of noise and object noisiness on animal breeding.. Šiška, B. – Hauptvogel, M. – Eliašová, M. (eds.). Bioclimate: Source and Limit of Social Development International Scientific Conference, 6th – 9th September 2011, Topoľčianky, Slovakia
119. Shannon, G., McKenna, M.F., Angeloni, L.M., Crooks, K.R., Fristrup, K.M., Brown, E., Warner, K.A., Nelson, M.D., White, C., Briggs, J., McFarland, S. and Wittemyer, G. 2015. *A synthesis of two decades of research documenting the effects of noise on wildlife*. Biological Reviews.
120. Sheperd, D and Billington, R. 2011: *Mitigating the Acoustic Impacts of Modern Technologies: Acoustic, Health, and Psychosocial Factors Informing Wind Farm*

- Placement. Bulletin of Science Technology & Society* published online 22 August 2011, DOI: 10.1177/0270467611417841
121. Shepherd, D *et al.* 2011: *Evaluating the impact of wind turbine noise on health related quality of life*. *Noise & Health*, September-October 2011, 13:54,333-9.
 122. Smith, M (*et al*) (2012): "Mechanisms of amplitude modulation in wind turbine noise"; Proceedings of the Acoustics 2012 Nantes Conference
 123. Stigwood, M. Large, S. Stigwood, D. 2013: "Audible amplitude modulation – results of field measurements and investigations compared to psycho-acoustical assessments and theoretical research"; Paper presented at the 5th International Conference on Wind Turbine Noise, Denver 28 – 30 August 2013
 124. Superior Health Council, 2013: *Public health effects of siting and operating onshore wind turbines*. Publication of the Superior Health Council No. 8738
 125. Szymański, P. *et al.* 2017: *The song of Skylarks Alauda arvensis indicates the deterioration of an acoustic environment resulting from wind farm start-up*. <https://doi.org/10.1111/ibi.12514>
 126. Tachibana, H (*et al*) (2013): "Assessment of wind turbine noise in immission areas"; Paper presented at the 5th International Conference on Wind Turbine Noise, Denver 28 – 30 August 2013
 127. The Scottish Government, 2011. Planning Advice Note PAN 1/2011: Planning and Noise. <https://www.gov.scot/publications/planning-advice-note-1-2011-planning-noise/pages/5/>
 128. Thorne *et al*, 2010: *Noise Impact Assessment Report Waubra Wind Farm Mr & Mrs N Dean Report No 1537 - Rev 1*
 129. Thorne, 2010: *The Problems with "Noise Numbers" for Wind Farm Noise Assessment*. *Bulletin of Science Technology and Society*, 2011 31: 262
 130. UK Department for Communities and Local Government, 2013: Planning practice guidance for renewable and low carbon energy. https://assets.publishing.service.gov.uk/government/uploads/system/uploads/attachment_data/file/225689/Planning_Practice_Guidance_for_Renewable_and_Low_Carbon_Energy.pdf
 131. USEPA, 1971: *Effects of Noise on Wildlife and other animals*.
 132. Van den Berg, G.P., 2003. 'Effects of the wind profile at night on wind turbine sound'. *Journal of Sound and Vibration*
 133. Van den Berg, G.P., 2004. 'Do wind turbines produce significant low frequency sound levels?'. 11th International Meeting on Low Frequency Noise and Vibration and its Control
 134. Van den Berg, F., Pedersen, E., Bouma, J., Bakker, R. 2008: *Visual and acoustic impact of wind turbine farms on residents*. Final Rep.

135. Van den Berg, F., Verhagen, C., Uitenbroek, D. 2014: The relation between scores on noise annoyance and noise disturbed sleep in a public health survey. *Int. J. Environ. Res. Public Health* **11**(2), 2314–27
136. Van Kamp, I., Davies, H. 2013: Noise and health in vulnerable groups: a review. *Noise Health* **15**(64), 153
137. Van Riet, W. Claassen, P. van Rensburg, J. van Viegen & L. du Plessis. 1998. *Environmental potential atlas for South Africa*. J.L. van Schaik, Pretoria
138. Vestas, 2020: *Performance Specification EnVentus™ V162-6.0 MW 50/60 Hz*. Document no.: 0098-0840 V00. Vestas Wind Systems A/S, Denmark
139. Wang, Z. 2011: *Evaluation of Wind Farm Noise Policies in South Australia: A Case Study of Waterloo Wind Farm*. Masters Degree Research Thesis, Adelaide University 2011
140. Whitford, Jacques, 2008: *Model Wind Turbine By-laws and Best Practices for Nova Scotia Municipalities*
141. World Health Organization, 1999: *Protection of the Human Environment; Guidelines for Community Noise*
142. World Health Organization, 2009: *Night Noise Guidelines for Europe*
143. World Health Organization, 2018: *Environmental Noise Guidelines for the European Region*
144. WSP, 2016: *Wind Turbine AM Review – Phase 2 Report*. WSP Parsons Brinckerhoff for the Department of Energy and Climate Change
145. Zwart, M.C et al. 2014: *Wind farm noise suppresses territorial defense behavior in a songbird*. *Behavioral Ecology* arv128(1), July 2014

APPENDIX A

Curriculum Vitae

The Author started his career in the mining industry as a bursar Learner Official (JCI, Randfontein), working in the mining industry, doing various mining related courses (Rock Mechanics, Surveying, Sampling, Safety and Health [Ventilation, noise, illumination etc.] and Metallurgy. He did work in both underground (Coal, Gold and Platinum) as well as opencast (Coal) for 4 years. He changed course from Mining Engineering to Chemical Engineering after his second year of his studies at the University of Pretoria.

After graduation he worked as a Water Pollution Control Officer at the Department of Water Affairs and Forestry for two years (first year seconded from Wates, Meiring and Barnard), where duties included the perusal (evaluation, commenting and recommendation) of various regulatory required documents (such as EMPR's, Water Use License Applications and EIA's), auditing of license conditions as well as the compilation of Technical Documents.

Since leaving the Department of Water Affairs, Morné has been in private consulting for the last 20 years, managing various projects for the mining and industrial sector, private developers, business, other environmental consulting firms as well as the Department of Water Affairs. During that period he has been involved in various projects, either as specialist, consultant, trainer or project manager, successfully completing these projects within budget and timeframe. During that period he gradually moved towards environmental acoustics, focusing on this field exclusively since 2007.

He has been interested in acoustics as from school days, doing projects mainly related to loudspeaker design. Interest in the matter brought him into the field of Environmental Noise Measurement, Prediction and Control as well as blasting impacts. Since 2007 he has completed more than 400 Environmental Noise Impact Assessments and Noise Monitoring Reports as well as various acoustic consulting services, including amongst others:

**Wind Energy
Facilities**

Full Environmental Noise Impact Assessments for - Bannf (Vidigenix), iNca Gouda (Aurecon SA), Isivunguvungu (Aurecon), De Aar (Aurecon), Kokerboom 1 (Aurecon), Kokerboom 2 (Aurecon), Kokerboom 3 (Aurecon), Kangnas (Aurecon), Plateau East and West (Aurecon), Wolf (Aurecon), Outeniqwa (Aurecon), Umsinde Emoyeni (ARCUS), Komsberg (ARCUS), Karee (ARCUS), Kolkies (ARCUS), San Kraal (ARCUS), Phezukomoya (ARCUS), Canyon Springs (Canyon Springs), Perdekraal (ERM), Scarlet Ibis (CESNET), Albany (CESNET), Sutherland (CSIR), Kap Vley (CSIR), Kuruman (CSIR), Rietrug (CSIR), Sutherland 2 (CSIR), Perdekraal (ERM), Teekloof (Mainstream), Eskom Aberdene (SE), Dorper (SE), Spreeukloof (SE), Loperberg (SE), Penhoek Pass (SE), Amakhala Emoyeni (SE), Zen (Savannah Environmental – SE), Goereesoe (SE), Springfontein (SE), Garob (SE), Project Blue (SE), ESKOM Kleinzee (SE), Namas (SE), Zonnequa (SE), Walker Bay (SE), Oyster Bay (SE), Hidden Valley (SE), Deep River (SE), Tsitsikamma (SE), AB (SE), West Coast One (SE), Hopefield II (SE), Namakwa Sands (SE), VentuSA Gouda (SE), Dorper (SE), Klipheuwel (SE), INCA Swellendam (SE), Cookhouse (SE), Iziduli (SE), Msenge (SE), Cookhouse II (SE), Rhebokfontein (SE), Suurplaat (SE), Karoo Renewables (SE), Koningaas (SE), Spitskop (SE), Castle (SE), Khai Ma (SE), Poortjies (SE), Korana (SE), IE Moorreesburg (SE), Gunstfontein (SE), Boulders (SE), Vredenburg (Terramanzi), Loeriesfontein (SiVEST), Rhenosterberg (SiVEST), Noupoot (SiVEST), Prieska (SiVEST), Dwarsrug (SiVEST),

	<p><i>Graskoppies (SiVEST), Philco (SiVEST), Hartebeest Leegete (SiVEST), Ithemba (SiVEST), IXha Boom (SiVEST), Spitskop West (Terramanzi), Haga Haga (Terramanzi), Vredenburg (Terramanzi), Msenge Emoyeni (Windlab), Wobben (IWP), Trakas (SiVest), Beaufort West (SiVest)</i></p>
<p>Mining and Industry</p>	<p><i>Full Environmental Noise Impact Assessments for – Delft Sand (AGES), BECSA – Middelburg (Golder Associates), Kromkrans Colliery (Geovicon Environmental), SASOL Borrow Pits Project (JMA Consulting), Lesego Platinum (AGES), Tweefontein Colliery (Cleanstream Environmental), Evraz Vametco Mine and Plant (JMA), Goedehoop Colliery (Geovicon), Hacra Project (Prescali Environmental), Der Brochen Platinum Project (J9 Environment), Brandbach Sand (AGES), Verkeerdepan Extension (CleanStream Environmental), Dwaalboom Limestone (AGES), Jagdlust Chrome (MENCO), WPB Coal (MENCO), Landau Expansion (CleanStream Environmental), Otjikoto Gold (AurexGold), Klipfontein Colliery (MENCO), Imbabala Coal (MENCO), ATCOM East Expansion (Jones and Wagner), IPP Waterberg Power Station (SE), Kangra Coal (ERM), Schoongesicht (CleanStream Environmental), EastPlats (CleanStream Environmental), Chapudi Coal (Jacana Environmental), Generaal Coal (JE), Mopane Coal (JE), Glencore Boshhoek Chrome (JMA), Langpan Chrome (PE), Vlakpoort Chrome (PE), Sekoko Coal (SE), Frankford Power (REMIG), Strahrae Coal (Ferret Mining), Transalloys Power Station (Savannah), Pan Palladium Smelter, Iron and PGM Complex (Prescali Environmental), Fumani Gold (AGES), Leiden Coal (EIMS), Colenso Coal and Power Station (SiVEST/EcoPartners), Klippoortjie Coal (Gudani), Rietspruit Crushers (MENCO), Assen Iron (Tshikovha), Transalloys (SE), ESKOM Ankerlig (SE), Nooitgedacht Titano Project (EcoPartners), Algoa Oil Well (EIMS), Spitskop Chrome (EMAssistance), Vlakfontein South (Gudani), Leandra Coal (Jacana), Grazvalley and Zoetveld (Prescali), Tjate Chrome (Prescali), Langpan Chromite (Prescali), Vereeniging Recycling (Pro Roof), Meyerton Recycling (Pro Roof), Hammanskraal Billeting Plant 1 and 2 (Unica), Development of Altona Furnace, Limpopo Province (Prescali Environmental), Haakdoordrift Opencast at Amandelbult Platinum (Aurecon), Landau Dragline relocation (Aurecon), Stuart Coal Opencast (CleanStream Environmental), Tetra4 Gas Field Development (EIMS), Kao Diamonds – Tipping Village Relocation (EIMS), Kao Diamonds – West Valley Tailings Deposit (EIMS), Upington Special Economic Zone (EOH), Arcellor Mittal CCGT Project near Saldanha (ERM), Malawi Sugar Mill Project (ERM), Proposed Mooifontein Colliery (Geovicon Environmental), Goedehoop North Residue Deposit Expansion (Geovicon Environmental), Mutsho 600MW Coal-Fired Power Plant (Jacana Environmentals), Tshivhaso Coal-Fired Power Plant (Savannah Environmental), Doornhoek Fluorspar Project (Exigo), Royal Sheba Project (Cabanga Environmental), Rietkol Silica (Jacana), Gruisfontein Colliery (Jacana), Lehlabile Colliery (Jaco-K Consulting), Bloemendal Colliery (Enviro-Insight), Rondevly Colliery (REC), Welgedacht Colliery (REC), Kalabasfontein Extension (EIMS), Waltloo Power Generation Project (EScience), Buffalo Colliery (Marang), Balgarthen Colliery (Rayten), Kusipongo Block C (Rayten), Zandheuvel (Exigo), NamPower Walvis Bay (GPT), Eloff Phase 3 (EIMS), Dunbar (Enviro-Insight), Smokey Hills (Prescali), Bierspruit (Aurecon)</i></p>
<p>Road and Railway</p>	<p><i>K220 Road Extension (Urbansmart), Boskop Road (MTO), Sekoko Mining (AGES), Davel-Swaziland-Richards Bay Rail Link (Aurecon), Moloto Transport Corridor Status Quo Report and Pre-Feasibility (SiVEST), Postmasburg Housing Development (SE), Tshwane Rapid Transport Project, Phase 1 and 2 (NRM Consulting/City of Tshwane), Transnet Apies-river Bridge Upgrade (Transnet), Gautrain Due-diligence (SiVest), N2 Piet Retief (SANRAL), Atterbury Extension, CoT (Bokomoso Environmental), Riverfarm Development (Terramanzi), Conakry to Kindia Toll Road (Rayten)</i></p>
<p>Airport</p>	<p><i>Oudtshoorn Noise Monitoring (AGES), Sandton Heliport (Alpine Aviation), Tete Airport Scoping (Aurecon)</i></p>
<p>Noise monitoring and Audit Reports</p>	<p><i>Peerboom Colliery (EcoPartners), Thabametsi (Digby Wells), Doxa Deo (Doxa Deo), Harties Dredging (Rand Water), Xstrata Coal – Witbank Regional (Xstrata), Sephaku Delmas (AGES), Amakhala Emoyeni WEF (Windlab Developments), Oyster Bay WEF (Renewable Energy Systems), Tsitsikamma WEF Ambient Sound Level study (Cennergi and SE), Hopefield WEF (Umoya), Wesley WEF (Innowind), Ncora WEF (Innowind), Boschmanspoort (Jones and Wagner), Nqamakwe WEF (Innowind), Hopefield WEF Noise Analysis (Umoya), Dassiesfontein WEF Noise Analysis (BioTherm), Transnet Noise Analysis (Aurecon), Jeffries Bay Wind Farm (Globeleq), Sephaku Aganang (Exigo), Sephaku Delmas (Exigo), Beira Audit (BP/GPT), Nacala Audit (BP/GPT), NATREF (Nemai), Rappa Resources (Rayten), Measurement Report for Sephaku Delmas (Ages), Measurement Report for Sephaku Aganang (Ages), Bank of Botswana measurements (Linnspace), Skukuza Noise Measurements (Concor), Development noise measurement protocol for Mamba Cement (Exigo), Measurement Report for Mamba Cement (Exigo), Measurement Report for Nokeng Fluorspar (Exigo), Tsitsikamma Community Wind Farm Pre-operation sound measurements (Cennergi), Waainek WEF Operational Noise Measurements (Innowind), Sedibeng Brewery Noise Measurements (MENCO), Tsitsikamma Community Wind Farm</i></p>

	<p><i>Operational noise measurements (Cennergi), Noupoot Wind Farm Operational noise measurements (Mainstream), Twisdraai Colliery (Lefatshe Minerals), SASOL Prospecting (Lefatshe Minerals), South32 Klipspruit (Rayten), Sibanye Stillwater Kroondal (Rayten), Rooiberg Asphalt (Rooiberg Asphalt), SASOL Shondoni (Lefatshe), SASOL Twisdraai (Lefatshe), Anglo Mototolo (Exigo), Heineken Inyaniga (AECOM), Glencore Izimbiwa (Cleanstream) Glencore Impunzi (Cleanstream), Black Chrome Mine (Prescali) Sibanye Stillwater Ezulwini (Aurecon), Sibanye Stillwater Beatrix (Aurecon), Bank of Botswana (Linspace), Lakeside (Linspace), Skukuza (SiVest), Rietvlei Colliery (Jaco-K Consulting)</i></p>
<p>Small Noise Impact Assessments</p>	<p><i>TCTA AMD Project Baseline (AECOM), NATREF (Nemai Consulting), Christian Life Church (UrbanSmart), Kosmosdale (UrbanSmart), Louwlandia K220 (UrbanSmart), Richards Bay Port Expansion (AECOM), Babalegi Steel Recycling (AGES), Safika Slag Milling Plant (AGES), Arcelor Mittal WEF (Aurecon), RVM Hydroplant (Aurecon), Grootvlei PS Oil Storage (SiVEST), Rhenosterberg WEF, (SiVEST), Concerto Estate (BPTrust), Ekuseni Youth Centre (MENCO), Kranskop Industrial Park (Cape South Developments), Pretoria Central Mosque (Noman Shaikh), Soshanguve Development (Maluleke Investments), Seshego-D Waste Disposal (Enviroexcellence), Zambesi Safari Equipment (Owner), Noise Annoyance Assessment due to the Operation of the Gautrain (Thornhill and Lakeside Residential Estate), Uppington Solar (SE), Ilangaletu Solar (SE), Pofadder Solar (SE), Flagging Trees WEF (SE), Uyekraal WEF (SE), Ruuki Power Station (SE), Richards Bay Port Expansion 2 (AECOM), Babalegi Steel Recycling (AGES), Safika Ladium (AGES), Safika Cement Isando (AGES), RareCo (SE), Struisbaai WEF (SE), Perdekraal WEF (ERM), Kotula Tsatsi Energy (SE), Olievenhoutbosch Township (Nali), , HDMS Project (AECOM), Quarry extensions near Ermelo (Rietspruit Crushers), Proposed uMzimkhulu Landfill in KZN (nZingwe Consultancy), Linksfield Residential Development (Bokomoso Environmental), Rooihuiskraal Ext. Residential Development, CoT (Plandev Town Planners), Floating Power Plant and LNG Import Facility, Richards Bay (ERM), Floating Power Plant project, Saldanha (ERM), Vopak Growth 4 project (ERM), Elandspoort Ext 3 Residential Development (Gibb Engineering), Tiegerpoort Wedding Venue (Henwood Environmental), Monavoni Development (Marindzini), Rezoning of Portion 1 (Primo Properties), Tswaing Mega City (Makole), Mabopane Church (EP Architects), ERGO Soweto Cluster (Kongiwe), Fabio Chains (Marang), GIDZ JMP (Marang), Temple Complex (KWP Create), Germiston Metals (Dorean), Sebenza Metals (Dorean)</i></p>
<p>Project reviews and amendment reports</p>	<p><i>Loperberg (Savannah), Dorper (Savannah), Penhoek Pass (Savannah), Oyster Bay (RES), Tsitsikamma Community Wind Farm Noise Simulation project (Cennergi), Amakhala Emoyeni (Windlab), Spreukloof (Savannah), Spinning Head (SE), Kangra Coal (ERM), West Coast One (Moyeng Energy), Rheboksfontein (Moyeng Energy), De Aar WEF (Holland), Quarterly Measurement Reports – Dangote Delmas (Exigo), Quarterly Measurement Reports – Dangote Lichtenburg (Exigo), Quarterly Measurement Reports – Mamba Cement (Exigo), Quarterly Measurement Reports – Dangote Delmas (Exigo) Quarterly Measurement Reports – Nokeng Fluorspar (Exigo), Proton Energy Limited Nigeria (ERM), Hartebeest WEF Update (Moorreesburg) (Savannah Environmental), Modderfontein WEF Opinion (Terramanzi), IPD Vredenburg WEF (IPD Power Vredenburg), Paul Puts WEF (ARCUS), Juno WEF (ARCUS), etc.</i></p>

Contact details for the Author are:

Author: Morné de Jager
 Company: Enviro-Acoustic Research cc
 Website: <http://www.eares.co.za>
 Email: morne@eares.co.za
 Office number: 012 004 0362
 Mobile number: 082 565 4059

APPENDIX B

Glossary of Terms

GLOSSARY OF ACOUSTIC TERMS, DEFINITIONS AND GENERAL INFORMATION

<i>1/3-Octave Band</i>	A filter with a bandwidth of one-third of an octave representing four semitones, or notes on the musical scale. This relationship is applied to both the width of the band, and the centre frequency of the band. See also definition of octave band.
<i>A – Weighting</i>	An internationally standardised frequency weighting that approximates the frequency response of the human ear and gives an objective reading that therefore agrees with the subjective human response to that sound.
<i>Air Absorption</i>	The phenomena of attenuation of sound waves with distance propagated in air, due to dissipative interaction within the gas molecules.
<i>Alternatives</i>	A possible course of action, in place of another, that would meet the same purpose and need (of proposal). Alternatives can refer to any of the following, but are not limited hereto: alternative sites for development, alternative site layouts, alternative designs, alternative processes and materials. In Integrated Environmental Management the so-called “no go” alternative refers to the option of not allowing the development and may also require investigation in certain circumstances.
<i>Ambient</i>	The conditions surrounding an organism or area.
<i>Ambient Noise</i>	The all-encompassing sound at a point being composed of sounds from many sources both near and far. It includes the noise from the noise source under investigation.
<i>Ambient Sound</i>	The all-encompassing sound at a point being composite of sounds from near and far.
<i>Ambient Sound Level</i>	Means the reading on an integrating impulse sound level meter taken at a measuring point in the absence of any alleged disturbing noise at the end of a total period of at least 10 minutes after such a meter was put into operation. In this report the term Background Ambient Sound Level will be used.
<i>Amplitude Modulated Sound</i>	A sound that noticeably fluctuates in loudness over time.
<i>Applicant</i>	Any person who applies for an authorisation to undertake a listed activity or to cause such activity in terms of the relevant environmental legislation.
<i>Assessment</i>	The process of collecting, organising, analysing, interpreting and communicating data that is relevant to some decision.
<i>Attenuation</i>	Term used to indicate reduction of noise or vibration, by whatever method necessary, usually expressed in decibels.
<i>Audible frequency Range</i>	Generally assumed to be the range from about 20 Hz to 20,000 Hz, the range of frequencies that our ears perceive as sound.
<i>Ambient Sound Level</i>	The level of the ambient sound indicated on a sound level meter in the absence of the sound under investigation (e.g. sound from a particular noise source or sound generated for test purposes). Ambient sound level as per Noise Control Regulations.
<i>Broadband Noise</i>	Spectrum consisting of a large number of frequency components, none of which is individually dominant.
<i>C-Weighting</i>	This is an international standard filter, which can be applied to a pressure signal or to a <i>SPL</i> or <i>PWL</i> spectrum, and which is essentially a pass-band filter in the frequency range of approximately 63 to 4000 Hz. This filter provides a more constant, flatter, frequency response, providing significantly less adjustment than the A-scale filter for frequencies less than 1000 Hz.
<i>Controlled area (as per National Noise Control Regulations)</i>	a piece of land designated by a local authority where, in the case of- (a) road transport noise in the vicinity of a road- (i) the reading on an integrating impulse sound level meter, taken outdoors at the end of a period extending from 06:00 to 24:00 while such meter is in operation, exceeds 65 dBA; or

	<p>(ii) the equivalent continuous "A"-weighted sound pressure level at a height of at least 1,2 metres, but not more than 1,4 metres, above the ground for a period extending from 06:00 to 24:00 as calculated in accordance with SABS 0210-1986, titled: "Code of Practice for calculating and predicting road traffic noise", published under Government Notice No. 358 of 20 February 1987, and projected for a period of 15 years following the date on which the local authority has made such designation, exceeds 65 dBA;</p> <p>(b) aircraft noise in the vicinity of an airfield, the calculated noisiness index, projected for a period of 15 years following the date on which the local authority has made such designation, exceeds 65 dBA; or</p> <p>(c) industrial noise in the vicinity of an industry-</p> <p>(i) the reading on an integrating impulse sound level meter, taken outdoors at the end of a period of 24 hours while such meter is in operation, exceeds 61 dBA; or</p> <p>(ii) the calculated outdoor equivalent continuous "A"-weighted sound pressure level at a height of at least 1,2 metres, but not more than 1,4 metres, above the ground for a period of 24 hours, exceeds 61 dBA;</p>
<i>dB(A)</i>	Sound Pressure Level in decibel that has been A-weighted, or filtered, to match the response of the human ear.
<i>Decibel (db)</i>	A logarithmic scale for sound corresponding to a multiple of 10 of the threshold of hearing. Decibels for sound levels in air are referenced to an atmospheric pressure of 20 μ Pa.
<i>Diffraction</i>	The process whereby an acoustic wave is disturbed and its energy redistributed in space as a result of an obstacle in its path, Reflection and refraction are special cases of diffraction.
<i>Direction of Propagation</i>	The direction of flow of energy associated with a wave.
<i>Disturbing noise</i>	Means a noise level that exceeds the zone sound level or, if no zone sound level has been designated, a noise level that exceeds the ambient sound level at the same measuring point by 7 dBA or more.
<i>Environment</i>	The external circumstances, conditions and objects that affect the existence and development of an individual, organism or group; these circumstances include biophysical, social, economic, historical, cultural and political aspects.
<i>Environmental Control Officer</i>	Independent Officer employed by the applicant to ensure the implementation of the Environmental Management Plan (EMP) and manages any further environmental issues that may arise.
<i>Environmental impact</i>	A change resulting from the effect of an activity on the environment, whether desirable or undesirable. Impacts may be the direct consequence of an organisation's activities or may be indirectly caused by them.
<i>Environmental Impact Assessment</i>	An Environmental Impact Assessment (EIA) refers to the process of identifying, predicting and assessing the potential positive and negative social, economic and biophysical impacts of any proposed project, plan, programme or policy that requires authorisation of permission by law and that may significantly affect the environment. The EIA includes an evaluation of alternatives, as well as recommendations for appropriate mitigation measures for minimising or avoiding negative impacts, measures for enhancing the positive aspects of the proposal, and environmental management and monitoring measures.
<i>Environmental issue</i>	A concern felt by one or more parties about some existing, potential or perceived environmental impact.
<i>Equivalent continuous A-weighted sound exposure level ($L_{Aeq,T}$)</i>	The value of the average A-weighted sound pressure level measured continuously within a reference time interval T , which have the same mean-square sound pressure as a sound under consideration for which the level varies with time.
<i>Equivalent continuous A-weighted rating level ($L_{Req,T}$)</i>	The Equivalent continuous A-weighted sound exposure level ($L_{Aeq,T}$) to which various adjustments has been added. More commonly used as ($L_{Req,d}$) over a time interval 06:00 – 22:00 ($T=16$ hours) and ($L_{Req,n}$) over a time interval of 22:00 – 06:00 ($T=8$ hours). It is a calculated value.

<i>F (fast) time weighting</i>	(1) Averaging detection time used in sound level meters. (2) Fast setting has a time constant of 125 milliseconds and provides a fast reacting display response allowing the user to follow and measure not too rapidly fluctuating sound.
<i>Footprint area</i>	Area to be used for the construction of the proposed development, which does not include the total study area.
<i>Free Field Condition</i>	An environment where there is no reflective surfaces.
<i>Frequency</i>	The rate of oscillation of a sound, measured in units of Hertz (Hz) or kiloHertz (kHz). One hundred Hz is a rate of one hundred times per second. The frequency of a sound is the property perceived as pitch: a low-frequency sound (such as a bass note) oscillates at a relatively slow rate, and a high-frequency sound (such as a treble note) oscillates at a relatively high rate.
<i>Green field</i>	A parcel of land not previously developed beyond that of agriculture or forestry use; virgin land. The opposite of Greenfield is Brownfield, which is a site previously developed and used by an enterprise, especially for a manufacturing or processing operation. The term Brownfield suggests that an investigation should be made to determine if environmental damage exists.
<i>G-Weighting</i>	An International Standard filter used to represent the infrasonic components of a sound spectrum.
<i>Harmonics</i>	Any of a series of musical tones for which the frequencies are integral multiples of the frequency of a fundamental tone.
<i>I (impulse) time weighting</i>	(1) Averaging detection time used in sound level meters as per South African standards and Regulations. (2) Impulse setting has a time constant of 35 milliseconds when the signal is increasing (sound pressure level rising) and a time constant of 1,500 milliseconds while the signal is decreasing.
<i>Impulsive sound</i>	A sound characterized by brief excursions of sound pressure (transient signal) that significantly exceed the ambient sound level.
<i>Infrasound</i>	Sound with a frequency content below the threshold of hearing, generally held to be about 20 Hz. Infrasonic sound with sufficiently large amplitude can be perceived, and is both heard and felt as vibration. Natural sources of infrasound are waves, thunder and wind.
<i>Integrated Development Plan</i>	A participatory planning process aimed at developing a strategic development plan to guide and inform all planning, budgeting, management and decision-making in a Local Authority, in terms of the requirements of Chapter 5 of the Municipal Systems Act, 2000 (Act 32 of 2000).
<i>Integrated Environmental Management</i>	IEM provides an integrated approach for environmental assessment, management, and decision-making and to promote sustainable development and the equitable use of resources. Principles underlying IEM provide for a democratic, participatory, holistic, sustainable, equitable and accountable approach.
<i>Interested and affected parties</i>	Individuals or groups concerned with or affected by an activity and its consequences. These include the authorities, local communities, investors, work force, consumers, environmental interest groups and the general public.
<i>Key issue</i>	An issue raised during the Scoping process that has not received an adequate response and that requires further investigation before it can be resolved.
<i>L_{A90}</i>	the sound level exceeded for the 90% of the time under consideration
<i>Listed activities</i>	Development actions that is likely to result in significant environmental impacts as identified by the delegated authority (formerly the Minister of Environmental Affairs and Tourism) in terms of Section 21 of the Environment Conservation Act.
<i>L_{AMin} and L_{AMax}</i>	Is the RMS (root mean squared) minimum or maximum level of a noise source.
<i>Loudness</i>	The attribute of an auditory sensation that describes the listener's ranking of sound in terms of its audibility.
<i>Magnitude of impact</i>	Magnitude of impact means the combination of the intensity, duration and extent of an impact occurring.
<i>Masking</i>	The raising of a listener's threshold of hearing for a given sound due to the presence of another sound.

<i>Mitigation</i>	To cause to become less harsh or hostile.
<i>Negative impact</i>	A change that reduces the quality of the environment (for example, by reducing species diversity and the reproductive capacity of the ecosystem, by damaging health, or by causing nuisance).
<i>Noise</i>	a. Sound that a listener does not wish to hear (unwanted sounds). b. Sound from sources other than the one emitting the sound it is desired to receive, measure or record. c. A class of sound of an erratic, intermittent or statistically random nature.
<i>Noise Level</i>	The term used in lieu of sound level when the sound concerned is being measured or ranked for its undesirability in the contextual circumstances.
<i>Noise-sensitive development</i>	developments that could be influenced by noise such as: a) districts (see table 2 of SANS 10103:2008) 1. rural districts, 2. suburban districts with little road traffic, 3. urban districts, 4. urban districts with some workshops, with business premises, and with main roads, 5. central business districts, and 6. industrial districts; b) educational, residential, office and health care buildings and their surroundings; c) churches and their surroundings; d) auditoriums and concert halls and their surroundings; e) recreational areas; and f) nature reserves. In this report Noise-sensitive developments is also referred to as a Potential Sensitive Receptor
<i>Octave Band</i>	A filter with a bandwidth of one octave, or twelve semi-tones on the musical scale representing a doubling of frequency.
<i>Positive impact</i>	A change that improves the quality of life of affected people or the quality of the environment.
<i>Property</i>	Any piece of land indicated on a diagram or general plan approved by the Surveyor-General intended for registration as a separate unit in terms of the Deeds Registries Act and includes an erf, a site and a farm portion as well as the buildings erected thereon
<i>Public Participation Process</i>	A process of involving the public in order to identify needs, address concerns, choose options, plan and monitor in terms of a proposed project, programme or development
<i>Reflection</i>	Redirection of sound waves.
<i>Refraction</i>	Change in direction of sound waves caused by changes in the sound wave velocity, typically when sound wave propagates in a medium of different density.
<i>Reverberant Sound</i>	The sound in an enclosure which results from repeated reflections from the boundaries.
<i>Reverberation</i>	The persistence, after emission of a sound has stopped, of a sound field within an enclosure.
<i>Significant Impact</i>	An impact can be deemed significant if consultation with the relevant authorities and other interested and affected parties, on the context and intensity of its effects, provides reasonable grounds for mitigating measures to be included in the environmental management report. The onus will be on the applicant to include the relevant authorities and other interested and affected parties in the consultation process. Present and potential future, cumulative and synergistic effects should all be taken into account.
<i>S (slow) time weighting</i>	(1) Averaging times used in sound level meters. (2) Time constant of one [1] second that gives a slower response which helps average out the display fluctuations.
<i>Sound Level</i>	The level of the frequency and time weighted sound pressure as determined by a sound level meter, i.e., A-weighted sound level.
<i>Sound Power</i>	Of a source, the total sound energy radiated per unit time.

<i>Sound Pressure Level (SPL)</i>	Of a sound, 20 times the logarithm to the base 10 of the ratio of the RMS sound pressure level to the reference sound pressure level. International values for the reference sound pressure level are 20 micro pascals in air and 100 millipascals in water. SPL is reported as L_p in dB (not weighted) or in various other weightings.
<i>Soundscape</i>	Sound or a combination of sounds that forms or arises from an immersive environment. The study of soundscape is the subject of acoustic ecology. The idea of soundscape refers to both the natural acoustic environment, consisting of natural sounds, including animal vocalizations and, for instance, the sounds of weather and other natural elements; and environmental sounds created by humans, through musical composition, sound design, and other ordinary human activities including conversation, work, and sounds of mechanical origin resulting from use of industrial technology. The disruption of these acoustic environments results in noise pollution.
<i>Study area</i>	Refers to the entire study area encompassing all the alternative routes as indicated on the study area map.
<i>Sustainable Development</i>	Development that meets the needs of the present without compromising the ability of future generations to meet their own needs. It contains within it two key concepts: the concept of "needs", in particular the essential needs of the world's poor, to which overriding priority should be given; and the idea of limitations imposed by the state of technology and social organization on the environment's ability to meet present and the future needs (Brundtland Commission, 1987).
<i>Tread braked</i>	The traditional form of wheel brake consisting of a block of friction material (which could be cast iron, wood or nowadays a composition material) hung from a lever and being pressed against the wheel tread by air pressure (in the air brake) or atmospheric pressure in the case of the vacuum brake.
<i>Zone of Potential Influence</i>	The area defined as the radius about an object, or objects beyond which the noise impact will be insignificant.
<i>Zone Sound Level</i>	Means a derived dBA value determined indirectly by means of a series of measurements, calculations or table readings and designated by a local authority for an area. This is similar to the Rating Level as defined in SANS 10103:2008.

APPENDIX C

Declaration of Independence

APPENDIX D

Site Sensitivity Verification

SITE SENSITIVITY VERIFICATION (IN TERMS OF PART A OF THE ASSESSMENT PROTOCOLS PUBLISHED IN GN 320 ON 20 MARCH 2020

Part A of the Assessment Protocols published in GN 320 on 20 March 2020 (i.e., Site sensitivity verification is required where a specialist assessment is required but no specific assessment protocol has been prescribed) is applicable where the Department of Environment, Forestry and Fisheries Screening Tool has the relevant themes to verify.

In accordance with Appendix 6 of the National Environmental Management Act (Act 107 of 1998, as amended) (NEMA) Environmental Impact Assessment (EIA) Regulations of 2014, a site sensitivity verification has been undertaken in order to confirm the current land use and environmental sensitivity of the proposed project area as identified by the National Web-Based Environmental Screening Tool (Screening Tool). The details of the site sensitivity verification are noted below:

Date of Site Visit	2 and 3 March 2023
Specialist Name	Faroll Coetzee
Professional Registration Number (if applicable)	Not applicable, there is no registration body in South Africa that could allow professional registration for acoustic consultants.
Specialist Affiliation / Company	Enviro-Acoustic Research CC

Output from National Environmental Screening Tool

The site was initially assessed using the National Environmental Screening tool, available at, <https://screening.environment.gov.za>. The output from the National Online Screening tool indicates a number of areas within, and up to 2,000 m from the project boundary is considered to be of a “very high” sensitivity to noise. These potentially “very high” sensitive areas (in terms of noise) are indicated on **Figures D.1** together with the potential noise-sensitive receptors as identified after the site visit.

Description on how the site sensitivity verification was undertaken

The site sensitivity was verified using:

- a) *available aerial images (Google Earth®) (See **Figure D.1** for initially identified potential noise-sensitive receptors);*
- b) *the statuses of these structures were defined during the site visit done in 2 and 3 March 2023.*

Outcome of the Site Sensitivity Verification

Potential noise-sensitive activities were identified (verified during the March 2023 site visit) and marked as green dots on **Figure D.1** below. Based on the site sensitivity verification:

- the online screening tool identified a number of areas with a “very high” sensitivity to noise in the vicinity of the proposed development. There are a number of noise-sensitive receptors in the area and the finding of the online screening tool is confirmed; and
- there are structures (NSR25) used on a permanent basis for residential purposes. This was not identified by the online screening tool.

Because of the number of noise-sensitive receptors in the vicinity of the wind farm, the potential impact from noise from the project is assessed in this Noise Specialist Study.



Signature
Morné de Jager
2023 – 03 – 09

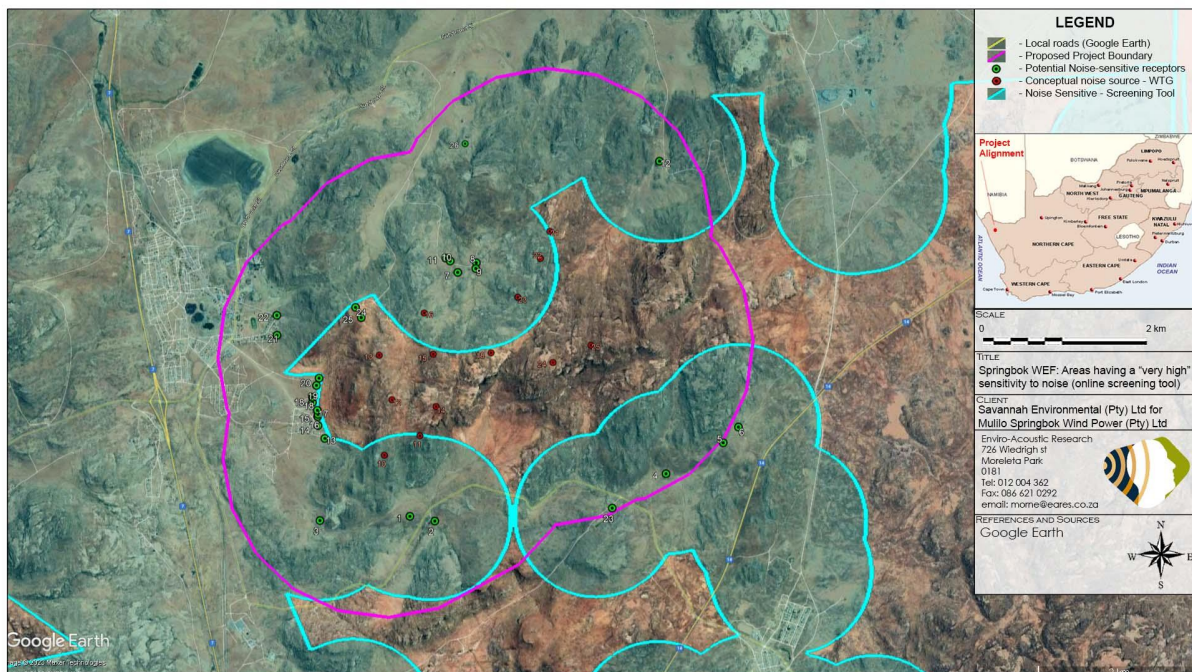

Figure D.1: Areas defined to be of “Very High” sensitivity in terms of noise by the online screening tool

APPENDIX E

Photos of potential noise- sensitive receptors



Photo E.1: NSR1 location (noise sensitive)



Photo E.2: NSR7 location (not noise sensitive)



Photo E.3: NSR8 location (noise sensitive)



Photo E.4: NSR9 location (noise sensitive)



Photo E.5: NSR10 location (noise sensitive)



Photo E.6: NSR11 location (assumed noise sensitive)



Photo E.7: NSR24 location (not noise sensitive)



Photo E.8: NSR25 location (noise sensitive)

APPENDIX F

Identified NSR, calculated noise levels and
significance of noise impact

Appendix F, Table 1: Locations of identified NSR and perceived use of structures

Potential NSR (receptors)	WGS 84 Longitude	WGS 84 Latitude	UTM 33S X	UTM 33S Y	Comment
1	17.90567	-29.6199	781369	6719806	Residential use
2	17.90884	-29.6204	781675	6719740	Residential use
3	17.89419	-29.6203	780256	6719782	Quarry and factory producing gravestones. No residential use reported.
4	17.93833	-29.6152	784546	6720250	Residential use
5	17.94562	-29.6117	785262	6720612	Derelict and abandoned building
6	17.94756	-29.61	785455	6720801	Residential use
7	17.91178	-29.5928	782036	6722789	Derelict and abandoned building
8	17.91414	-29.5918	782268	6722902	Residential use
9	17.91408	-29.5924	782260	6722831	Residential use
10	17.91081	-29.5916	781946	6722931	Residential use
11	17.91024	-29.5913	781892	6722968	Use undefined. Door locked with structure appeared to be used for storage. As use could not be verified location assumed to be potentially noise-sensitive.
12	17.93749	-29.5805	784562	6724093	Gate locked with no-access warning. Assumed noise sensitive
13	17.89482	-29.6112	780342	6720790	Residential use, outskirts of Okiep (various houses)
14	17.89394	-29.6098	780261	6720950	Residential use, outskirts of Okiep (various houses)
15	17.8939	-29.6088	780260	6721061	Residential use, outskirts of Okiep (various houses)
16	17.89395	-29.6086	780265	6721088	Residential use, outskirts of Okiep (various houses)
17	17.89386	-29.6081	780258	6721138	Residential use, outskirts of Okiep (various houses)
18	17.89325	-29.6073	780201	6721235	Residential use, outskirts of Okiep (various houses)
19	17.89323	-29.6067	780201	6721300	Residential use, outskirts of Okiep (various houses)
20	17.89375	-29.6054	780255	6721444	Residential use, outskirts of Okiep (various houses)
21	17.89409	-29.6046	780290	6721533	Residential use, edge of Okiep (houses between NSR21 and 22)
22	17.88872	-29.5998	779783	6722073	Residential use, edge of Okiep (houses between NSR21 and 22)
23	17.8887	-29.5976	779787	6722318	Residential use
24	17.93147	-29.619	783871	6719844	No residential use.
25	17.89874	-29.5967	780762	6722391	Residential use
26	17.89947	-29.5979	780830	6722263	Residential use

Appendix F, Table 2: Projected construction noise levels and daytime significance – Springbok WEF

Potential Noise-sensitive development / Receptor(s)	Recommended Rating Levels (noise limit - daytime rating level, Rural)	Potential Existing Ambient Sound Levels (long-term average - Fast-weighted)	Projected Noise Level	Change in rating level	Magnitude / Intensity	Duration	Extent	Probability of Impact Occurring	Significance
NSR01	45	44.5	40.4	1.4	Minor	Short-term	Local	Improbable	Low
NSR02	45	44.5	39.4	1.2	Minor	Short-term	Local	Improbable	Low
NSR03	45	44.5	32.0	0.2	Minor	Short-term	Local	Improbable	Low
NSR04	45	44.5	30.7	0.2	Minor	Short-term	Local	Improbable	Low
NSR05	45	44.5	26.6	0.1	Minor	Short-term	Local	Improbable	Low
NSR06	45	44.5	25.2	0.1	Minor	Short-term	Local	Improbable	Low
NSR07	45	44.5	44.9	3.2	Low	Short-term	Local	Improbable	Low
NSR08	45	44.5	45.7	3.7	Low	Short-term	Local	Improbable	Low
NSR09	45	44.5	45.5	3.5	Low	Short-term	Local	Improbable	Low
NSR10	45	44.5	45.2	3.4	Low	Short-term	Local	Improbable	Low
NSR11	45	44.5	45.3	3.4	Low	Short-term	Local	Improbable	Low
NSR12	45	44.5	33.7	0.3	Minor	Short-term	Local	Improbable	Low
NSR13	45	44.5	28.8	0.1	Minor	Short-term	Local	Improbable	Low
NSR14	50	44.5	29.2	0.1	Minor	Short-term	Local	Improbable	Low
NSR15	50	44.5	25.8	0.1	Minor	Short-term	Local	Improbable	Low
NSR16	50	44.5	25.9	0.1	Minor	Short-term	Local	Improbable	Low
NSR17	50	44.5	24.2	0.0	Minor	Short-term	Local	Improbable	Low
NSR18	50	44.5	25.1	0.0	Minor	Short-term	Local	Improbable	Low
NSR19	50	44.5	25.5	0.1	Minor	Short-term	Local	Improbable	Low
NSR20	50	44.5	29.3	0.1	Minor	Short-term	Local	Improbable	Low
NSR21	50	44.5	27.5	0.1	Minor	Short-term	Local	Improbable	Low
NSR22	50	44.5	22.7	0.0	Minor	Short-term	Local	Improbable	Low
NSR23	45	44.5	33.4	0.3	Minor	Short-term	Local	Improbable	Low
NSR24	45	44.5	34.8	0.4	Minor	Short-term	Local	Improbable	Low
NSR25	45	44.5	46.3	4.0	Low	Short-term	Local	Improbable	Low
NSR26	45	44.5	45.7	3.7	Low	Short-term	Local	Improbable	Low
NSR27	45	44.5	27.3	0.1	Minor	Short-term	Local	Improbable	Low

Appendix F, Table 3: Projected construction noise levels and night-time significance – Springbok WEF

Potential Noise-sensitive development / Receptor(s)	Recommended Rating Levels (noise limit - daytime rating level, Rural)	Potential Existing Ambient Sound Levels (long-term average - Fast-weighted)	Projected Noise Level	Change in rating level	Magnitude / Intensity	Duration	Extent	Probability of Impact Occurring	Significance
NSR01	35	35.0	40.4	6.5	Moderate	Short-term	Regional	Improbable	Low
NSR02	35	35.0	39.4	5.7	Moderate	Short-term	Regional	Improbable	Low
NSR03	35	35.0	32.0	1.8	Minor	Short-term	Regional	Improbable	Low
NSR04	35	35.0	30.7	1.4	Minor	Short-term	Regional	Improbable	Low
NSR05	35	35.0	26.6	0.6	Minor	Short-term	Regional	Improbable	Low
NSR06	35	35.0	25.2	0.4	Minor	Short-term	Regional	Improbable	Low
NSR07	35	35.0	44.9	10.3	Very High	Short-term	Regional	Improbable	Low
NSR08	35	35.0	45.7	11.1	Very High	Short-term	Regional	Possible	Medium
NSR09	35	35.0	45.5	10.9	Very High	Short-term	Regional	Possible	Medium
NSR10	35	35.0	45.2	10.6	Very High	Short-term	Regional	Possible	Medium
NSR11	35	35.0	45.3	10.7	Very High	Short-term	Regional	Possible	Medium
NSR12	35	35.0	33.7	2.4	Minor	Short-term	Regional	Improbable	Low
NSR13	35	35.0	28.8	0.9	Minor	Short-term	Regional	Improbable	Low
NSR14	40	41.4	29.2	0.3	Minor	Short-term	Regional	Improbable	Low
NSR15	40	41.4	25.8	0.1	Minor	Short-term	Regional	Improbable	Low
NSR16	40	41.4	25.9	0.1	Minor	Short-term	Regional	Improbable	Low
NSR17	40	41.4	24.2	0.1	Minor	Short-term	Regional	Improbable	Low
NSR18	40	41.4	25.1	0.1	Minor	Short-term	Regional	Improbable	Low
NSR19	40	41.4	29.3	0.3	Minor	Short-term	Regional	Improbable	Low
NSR20	40	41.4	27.5	0.2	Minor	Short-term	Regional	Improbable	Low
NSR21	40	41.4	22.7	0.1	Minor	Short-term	Regional	Improbable	Low
NSR22	40	41.4	33.4	0.6	Minor	Short-term	Regional	Improbable	Low
NSR23	35	35.0	34.8	2.9	Minor	Short-term	Regional	Improbable	Low
NSR24	35	35.0	46.3	11.6	Very High	Short-term	Regional	Possible	Medium
NSR25	35	35.0	45.7	11.1	Very High	Short-term	Regional	Possible	Medium
NSR26	35	35.0	27.3	0.7	Minor	Short-term	Regional	Improbable	Low

Appendix F, Table 4: Projected worst-case operational noise levels and night-time significance – Springbok WEF (using SPL of 112.6 dBA re 1 pW)

Potential Noise-sensitive development / Receptor(s)	Recommended Rating Levels (noise limit - night-time rating level, IFC/WHO)	Potential Existing Ambient Sound Levels (Estimated considering an 10 m/s wind speed)	Projected Noise Level	Change in rating level	Magnitude / Intensity	Duration	Extent	Probability of Impact Occurring	Significance
NSR01	45	43.5	47.2	5.2	Moderate	Long-term	Regional	Likely	Medium
NSR02	45	43.5	46.1	4.5	Low	Long-term	Regional	Likely	Medium
NSR03	45	43.5	42.0	2.3	Low	Long-term	Regional	Possible	Low
NSR04	45	43.5	36.1	0.7	Minor	Long-term	Regional	Improbable	Low
NSR05	45	43.5	33.9	0.5	Minor	Long-term	Regional	Improbable	Low
NSR06	45	43.5	33.7	0.4	Minor	Long-term	Regional	Improbable	Low
NSR07	45	43.5	50.8	8.0	High	Long-term	Regional	Definite	High
NSR08	45	43.5	51.1	8.3	High	Long-term	Regional	Definite	High
NSR09	45	43.5	51.4	8.6	High	Long-term	Regional	Definite	High
NSR10	45	43.5	50.0	7.4	High	Long-term	Regional	Definite	High
NSR11	45	43.5	49.7	7.1	High	Long-term	Regional	Highly Likely	High
NSR12	45	43.5	40.7	1.8	Minor	Long-term	Regional	Possible	Low
NSR13	45	43.5	47.4	5.4	Moderate	Long-term	Regional	Likely	Medium
NSR14	45	43.5	47.2	5.2	Moderate	Long-term	Regional	Likely	Medium
NSR15	45	43.5	46.4	4.7	Low	Long-term	Regional	Likely	Medium
NSR16	45	43.5	46.5	4.8	Low	Long-term	Regional	Likely	Medium
NSR17	45	43.5	42.6	2.6	Minor	Long-term	Regional	Possible	Low
NSR18	45	43.5	44.1	3.3	Low	Long-term	Regional	Possible	Low
NSR19	45	43.5	45.8	4.3	Low	Long-term	Regional	Likely	Medium
NSR20	45	43.5	45.6	4.2	Low	Long-term	Regional	Likely	Medium
NSR21	45	43.5	39.5	1.5	Minor	Long-term	Regional	Possible	Low
NSR22	45	43.5	40.8	1.9	Minor	Long-term	Regional	Possible	Low
NSR23	45	43.5	40.4	1.7	Minor	Long-term	Regional	Possible	Low
NSR24	45	43.5	49.6	7.1	High	Long-term	Regional	Highly Likely	High
NSR25	45	43.5	50.7	8.0	High	Long-term	Regional	Definite	High
NSR26	45	43.5	38.0	1.1	Minor	Long-term	Regional	Improbable	Low

Appendix F, Table 5: Projected operational noise levels and night-time significance – Springbok WEF (using SPL of 109.2 dBA re 1 pW)

Potential Noise-sensitive development / Receptor(s)	Recommended Rating Levels (noise limit - night-time rating level, IFC/WHO)	Potential Existing Ambient Sound Levels (Estimated considering an 8m/s wind speed)	Projected Noise Level	Change in rating level	Magnitude / Intensity	Duration	Extent	Probability of Impact Occurring	Significance
NSR01	45	41.5	42.6	3.6	Low	Long-term	Regional	Possible	Low
NSR02	45	41.5	41.3	2.9	Minor	Long-term	Regional	Possible	Low
NSR03	45	41.5	37.2	1.4	Minor	Long-term	Regional	Improbable	Low
NSR04	45	41.5	31.1	0.4	Minor	Long-term	Regional	Improbable	Low
NSR05	45	41.5	28.9	0.2	Minor	Long-term	Regional	Improbable	Low
NSR06	45	41.5	28.7	0.2	Minor	Long-term	Regional	Improbable	Low
NSR07	45	41.5	46.3	6.0	Moderate	Long-term	Regional	Likely	Medium
NSR08	45	41.5	46.5	6.2	Moderate	Long-term	Regional	Likely	Medium
NSR09	45	41.5	46.9	6.5	Moderate	Long-term	Regional	Likely	Medium
NSR10	45	41.5	45.4	5.4	Moderate	Long-term	Regional	Likely	Medium
NSR11	45	41.5	45.1	5.2	Moderate	Long-term	Regional	Likely	Medium
NSR12	45	41.5	35.7	1.0	Minor	Long-term	Regional	Improbable	Low
NSR13	45	41.5	42.7	3.7	Low	Long-term	Regional	Possible	Low
NSR14	45	41.5	42.5	3.5	Low	Long-term	Regional	Possible	Low
NSR15	45	41.5	41.7	3.1	Low	Long-term	Regional	Possible	Low
NSR16	45	41.5	41.8	3.2	Low	Long-term	Regional	Possible	Low
NSR17	45	41.5	37.9	1.6	Minor	Long-term	Regional	Improbable	Low
NSR18	45	41.5	39.3	2.0	Minor	Long-term	Regional	Possible	Low
NSR19	45	41.5	41.2	2.9	Minor	Long-term	Regional	Possible	Low
NSR20	45	41.5	41.0	2.8	Minor	Long-term	Regional	Possible	Low
NSR21	45	41.5	34.5	0.8	Minor	Long-term	Regional	Improbable	Low
NSR22	45	41.5	35.9	1.1	Minor	Long-term	Regional	Improbable	Low
NSR23	45	41.5	35.3	0.9	Minor	Long-term	Regional	Improbable	Low
NSR24	45	41.5	45.0	5.1	Moderate	Long-term	Regional	Likely	Medium
NSR25	45	41.5	46.3	6.0	Moderate	Long-term	Regional	Likely	Medium
NSR26	45	41.5	33.0	0.6	Minor	Long-term	Regional	Improbable	Low

Appendix F, Table 6: Projected best-case operational noise levels and night-time significance – Springbok WEF (using SPL of 104.3 dBA re 1 pW)

Potential Noise-sensitive development / Receptor(s)	Recommended Rating Levels (noise limit - night-time rating level, IFC/WHO)	Potential Existing Ambient Sound Levels (Estimated considering an 10m/s wind speed)	Projected Noise Level	Change in rating level	Magnitude / Intensity	Duration	Extent	Probability of Impact Occurring	Significance
NSR01	45	43.5	37.7	1.0	Minor	Long-term	Regional	Improbable	Low
NSR02	45	43.5	36.5	0.8	Minor	Long-term	Regional	Improbable	Low
<i>NSR03</i>	<i>45</i>	<i>43.5</i>	<i>32.4</i>	<i>0.3</i>	<i>Minor</i>	<i>Long-term</i>	<i>Regional</i>	<i>Improbable</i>	<i>Low</i>
NSR04	45	43.5	27.7	0.1	Minor	Long-term	Regional	Improbable	Low
<i>NSR05</i>	<i>45</i>	<i>43.5</i>	<i>24.3</i>	<i>0.1</i>	<i>Minor</i>	<i>Long-term</i>	<i>Regional</i>	<i>Improbable</i>	<i>Low</i>
NSR06	45	43.5	24.1	0.0	Minor	Long-term	Regional	Improbable	Low
<i>NSR07</i>	<i>45</i>	<i>43.5</i>	<i>41.5</i>	<i>2.1</i>	<i>Minor</i>	<i>Long-term</i>	<i>Regional</i>	<i>Possible</i>	<i>Low</i>
NSR08	45	43.5	41.7	2.2	Minor	Long-term	Regional	Possible	Low
NSR09	45	43.5	42.0	2.3	Minor	Long-term	Regional	Possible	Low
NSR10	45	43.5	40.6	1.8	Minor	Long-term	Regional	Possible	Low
NSR11	45	43.5	40.3	1.7	Minor	Long-term	Regional	Possible	Low
NSR12	45	43.5	31.0	0.2	Minor	Long-term	Regional	Improbable	Low
NSR13	45	43.5	37.9	1.1	Minor	Long-term	Regional	Improbable	Low
NSR14	45	43.5	37.8	1.0	Minor	Long-term	Regional	Improbable	Low
NSR15	45	43.5	37.5	1.0	Minor	Long-term	Regional	Improbable	Low
NSR16	45	43.5	37.5	1.0	Minor	Long-term	Regional	Improbable	Low
NSR17	45	43.5	33.9	0.5	Minor	Long-term	Regional	Improbable	Low
NSR18	45	43.5	34.9	0.6	Minor	Long-term	Regional	Improbable	Low
NSR19	45	43.5	37.4	1.0	Minor	Long-term	Regional	Improbable	Low
NSR20	45	43.5	36.9	0.9	Minor	Long-term	Regional	Improbable	Low
NSR21	45	43.5	31.4	0.3	Minor	Long-term	Regional	Improbable	Low
NSR22	45	43.5	31.2	0.2	Minor	Long-term	Regional	Improbable	Low
NSR23	45	43.5	30.9	0.2	Minor	Long-term	Regional	Improbable	Low
<i>NSR24</i>	<i>45</i>	<i>43.5</i>	<i>40.3</i>	<i>1.7</i>	<i>Minor</i>	<i>Long-term</i>	<i>Regional</i>	<i>Possible</i>	<i>Low</i>
NSR25	45	43.5	41.5	2.1	Minor	Long-term	Regional	Possible	Low
NSR26	45	43.5	28.3	0.1	Minor	Long-term	Regional	Improbable	Low

End of Report