

## **Appendix D3 Heritage**

- Appendix D3a    Archaeological**
- Appendix D3b    Palaeontological**
- Appendix D3c    Visual**

**APPENDIX D3A ARCHAEOLOGICAL**

**ARCHAEOLOGICAL IMPACT ASSESSMENT  
THE PROPOSED ROMA ENERGY SOLAR FARM  
ON ERF 753 DANIELSKUIL  
NORTHERN CAPE PROVINCE**

Prepared for:

**ENVIROAFRICA**  
Att: Mr Bernard de Wit  
PO Box 5367  
Helderberg  
7135

E-mail: [Bernard@enviroafrica.co.za](mailto:Bernard@enviroafrica.co.za)

On behalf of:

**ROMA ENERGY DANIELSKUIL (PTY) LTD**

By



Jonathan Kaplan  
**Agency for Cultural Resource Management**  
5 Stuart Road  
Rondebosch  
7700

Ph/Fax: 021 685 7589  
Mobile: 082 321 0172  
E-mail: [acrm@wcaccess.co.za](mailto:acrm@wcaccess.co.za)

**MARCH  
2012**

## Archaeological study proposed solar energy farm near Danielskuil

### Executive summary

The Agency for Cultural Resource Management was commissioned to conduct an Archaeological Impact Assessment (AIA) for the proposed construction and operation of a 10 Mega Watt (MW) commercial Concentrated Photovoltaic (CPV) Energy Generation Facility on Erf 753 in Danielskuil in the Northern Cape. Danielskuil is located about 150 kms northwest of Kimberley and about 80 kms east of Kuruman on the R31. The site for the proposed solar farm is located south of the town, directly opposite the Idwala Lime mine. The land is privately-owned and is currently zoned for industrial use.

The AIA forms part of the Environmental Basic Assessment process that is being conducted by EnviroAfrica cc.

Due to a misunderstanding, the archaeologist was under the impression that, because of extensive infrastructure covering Erf 753, an alternative site, located south of the Idwala Lime Mine had been identified for a possible solar energy farm, and the proposed site therefore screened out. This is not the case, and the proposed site is now the preferred site, which unfortunately, was not subjected to an AIA.

The proposed site (Erf 753) for the Danielskuil solar energy farm is flat and featureless, comprising a mix of old grazing land, bush, scrub, and grassland vegetation. According to the biophysical assessment, the proposed site is also fairly severely degraded and covered by infrastructure that includes several large powerline servitudes, gravel access roads and associated infrastructure. There is virtually no surface covering the proposed site. There are no streams, pans, or water sources on the property.

A foot survey of the proposed alternative site was undertaken by the archaeologist on 5 March 2012 in which no archaeological remains were documented. The proposed 20 ha footprint area is flat and comprises pasture lands that are heavily grazed. Apart from some flat outcroppings of grey dolomite that occurs on a slightly elevated ridge in the north western portion, there is no surface stone covering the site,

The archaeologist believes that the probability of locating important archaeological heritage (i.e. stone artefacts) on the proposed site (Erf 753) will be low, for the following reasons:

- No archaeological remains were found during the assessment of the proposed alternative site
- The context of the proposed site is similar to the alternative site in that it comprises grasslands and old pastures, is degraded and covered by extensive Eskom infrastructure.
- There are no streams, water courses, pans or drainage channels on or near the proposed site where archaeological remains may be expected to be found.
- There are no, significant landscape or any rocky outcrops on the proposed site.
- There is virtually no surface stone covering the proposed site.

### Archaeological study proposed solar energy farm near Danielskuil

- There are no old buildings, structures or any features on the proposed site, apart from those relating to Eskom infrastructure, which covers a large portion of the site and the surrounding landscape.
- There are no visible graves on the proposed site
- Apart from trenches for underground cabling, limited bedrock excavations are envisaged. The solar panels will be raised above ground and mounted on small footings drilled and set into the ground. The excavations for the footings are about 1.5 m in diameter and so the actual ground disturbance will be therefore quite limited and contained

Indications are that in terms of archaeological heritage, the proposed site (Erf 753) for the Danielskuil solar energy farm is not a sensitive, vulnerable or threatened archaeological landscape

With regard to the proposed development of the Roma Energy Solar Farm in Danielskuil, the following recommendations are therefore made:

1. An AIA of the proposed site (Erf 753) for the solar energy farm is not required and no further archaeological mitigation is required.
2. Should any unmarked human burials/remains or ostrich eggshell water flask caches be uncovered, or exposed during construction activities, these must immediately be reported to the archaeologist (Jonathan Kaplan 082 321 0172), or the South African Heritage Resources Agency (SAHRA) (Att Ms Mariagrazia Galimberti 021 462 4502). Burials, etc must not be removed or disturbed until inspected by the archaeologist.

Archaeological study proposed solar energy farm near Danielskuil

**Table of Contents**

	<b>Page</b>
<b>Executive summary</b>	<b>1</b>
<b>1. INTRODUCTION</b>	
1.1 Background and brief	4
<b>2. HERITAGE LEGISLATION</b>	<b>4</b>
<b>3. DESCRIPTION OF THE RECEIVING ENVIRONMENT</b>	<b>9</b>
<b>4. STUDY APPROACH</b>	<b>11</b>
4.1 Method of survey	11
4.2 Constraints and limitations	11
4.3 Identification of potential risks	11
4.4 Results of the desk top study	11
<b>5. FINDINGS</b>	<b>12</b>
<b>6. CONCLUSIONS</b>	<b>12</b>
<b>7. RECOMMENDATIONS</b>	<b>13</b>
<b>8. REFERENCES</b>	<b>14</b>

## 1. INTRODUCTION

### 1.1 Background and brief

Roma Energy Danielskuil (Pty) Ltd, commissioned the Agency for Cultural Resource Management to conduct an Archaeological Impact Assessment (AIA) for the proposed construction and operation of a 10 MW Concentrated Photovoltaic (CPV) Energy Generation Facility on Erf 753 in Danielskuil in the Northern Cape (Figures 1 & 2). The proposed development is situated within the Kgatelopele Local municipality. The subject property is zoned for Industrial use and is privately owned.

The AIA forms part of the Environmental Basic Assessment process that is being conducted by EnviroAfrica cc.

Roma Energy Danielskuil proposes to construct and operate a commercial solar energy that entails the construction of about 140 CPV solar panels covering a footprint area of about 20 ha (Figures 3-9). The CPV panels will be mounted on pedestals drilled and set into the ground. Extensive bedrock excavations are not envisaged, but some vegetation may need to be cleared from the site. Associated infrastructure includes single track internal access roads, trenches for underground cables, transformer pads, a switching station, a maintenance shed, and a temporary construction camp. The electricity generated from the project will be fed directly into the national grid to the Eskom Danielskuil substation which is situated alongside the proposed facility. Note that due to the extensive infrastructure covering the proposed site, the solar modules have been spread out over the surrounding landscape.

Due to a misunderstanding, the archaeologist was under the impression that, because of extensive infrastructure covering Erf 753, an alternative site, located south of the Idwala Lime Mine, had been identified for a possible solar energy farm, and the proposed site had therefore been screened out. This is not the case, and the proposed site is now the preferred site, which unfortunately, was not subjected to an AIA. For the purposes of this study, only the alternative site was searched for archaeological heritage remains (refer to Figure 10).

## 2. HERITAGE LEGISLATION

The National Heritage Resources Act (Act No. 25 of 1999) makes provision for a compulsory Heritage Impact Assessment (HIA) when an area exceeding 5000 m<sup>2</sup> is being developed. This is to determine if the area contains heritage sites and to take the necessary steps to ensure that they are not damaged or destroyed during development.

The NHRA provides protection for the following categories of heritage resources:

- Landscapes, cultural or natural (Section 3 (3))
- Buildings or structures older than 60 years (Section 34);
- Archaeological sites, palaeontological material and meteorites (Section 35);
- Burial grounds and graves (Section 36);

Archaeological study proposed solar energy farm near Danielskull

- Public monuments and memorials (Section 37);
- Living heritage (defined in the Act as including cultural tradition, oral history, performance, ritual, popular memory, skills and techniques, indigenous knowledge systems and the holistic approach to nature, society and social relationships) (Section 2 (d) (xxi)).

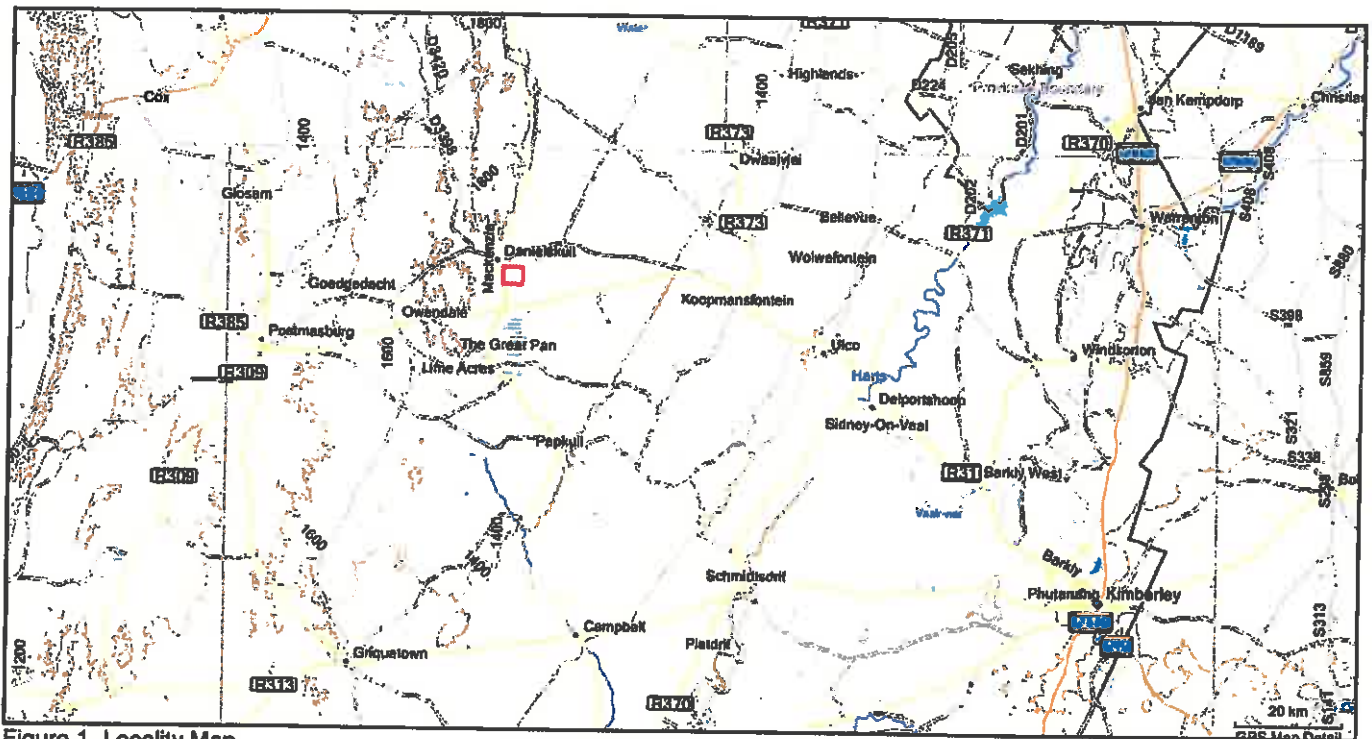

Figure 1. Locality Map

 Study site



Archaeological study proposed solar energy farm near Danielskuil

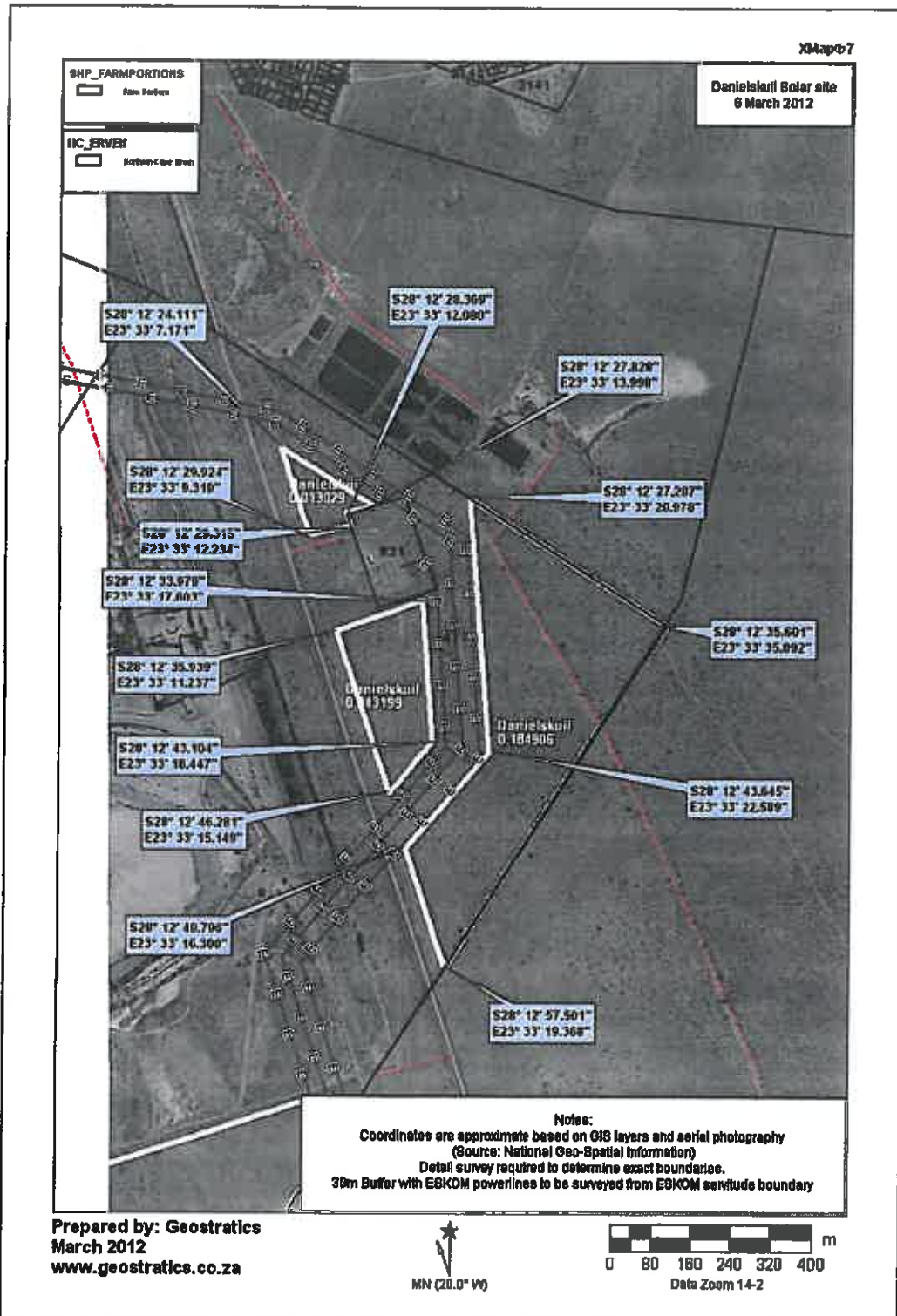

Figure 2. Aerial photograph of the footprint areas for the proposed Danielskuil Solar Energy Farm

Archaeological study proposed solar energy farm near Danielskuil



Figure 3. Proposed layout of the Danielskuil solar modules on Farm 753. Note how the modules are spread out over the landscape

Archaeological study proposed solar energy farm near Danielskuil



Figure 4. The proposed site view facing north east



Figure 7. The proposed site view facing east



Figure 5. The proposed site view facing north



Figure 8. The proposed site view facing north east



Figure 6. The proposed site view facing north



Figure 9. The proposed site view facing south west



### 3. DESCRIPTION OF THE RECEIVING ENVIRONMENT

An aerial photograph indicating the proposed and proposed alternative Roma Energy Solar Farm in Danielskuil is illustrated in Figure 10. Danielskuil is located about 150 kms northwest of Kimberley and about 80 kms east of Kuruman on the R31. The site (Erf 753) for the proposed solar farm is located about 2 km south of the town on the R31, directly opposite (i. e. east of) the Idwala Lime mine.

The proposed alternative site is located adjacent to the Idwala mine and west of the R31. The alternative site is a flat piece of pasture land that has been heavily grazed (Figures 11 & 12). There is no surface stone covering the site. There are no significant landscape features on the property, which is fenced in. An, Eskom servitude defines the western boundary of the site. There is some weathered surface dolomite stone on a slightly elevated ridge line in the north western corner of the property. Surrounding land use is the Idwala mine and agriculture (grazing). There are no old buildings, structures or features, old equipment, public memorials or monuments on the proposed and proposed alternative site. There are no visible graves on the alternative site.

The 20 ha footprint area for the proposed solar energy farm is also flat and featureless, comprising a mix of old grazing land, bush and grassland vegetation (refer to Figures 4-9). According to the biophysical study, the proposed site is also fairly severely degraded and covered by infrastructure that includes large powerline servitudes, gravel access roads and associated infrastructure. There is no surface stone covering the site. There are no streams, pans, or water sources on the proposed site. According to the botanist Mr Peet Botes (pers. com.), there are no visible graves on the proposed site.



Figure 10. Aerial photograph of the proposed and proposed alternative sites for the Roma Danielskuil Solar Energy Farm.

Archaeological study proposed solar energy farm near Danielskuil



Figure 11. View proposed alternative site facing west



Figure 12. View of the proposed alternative site facing north east

#### **4. STUDY APPROACH**

##### **4.1 Method of survey**

A fairly detailed foot survey of the proposed alternative site was undertaken by J Kaplan on 5 March, 2012. A track path of survey was also created (refer to Figure 13).

A desk top study was also done.

##### **4.2 Constraints and limitations**

There were no constraints or limitations associated with the study of the proposed alternative site. The site has been heavily grazed and archaeological visibility was very good.

##### **4.3 Identification of potential risks**

It is argued, based on the results of the study of the alternative site that it is unlikely that any important or significant archaeological heritage (i. e. stone tools) will be impacted by the proposed project given the transformed nature and disturbed context of the receiving environment.

##### **4.4 Results of the desk top study**

Bushman rock engravings occur in the hills south west of Danielskuil and the well known and nationally important Wonderwerk Cave is located about 30 kms west of the town on the R31 to Kuruman (Beaumont and Morris 1990; Morris and Beaumont 2004; Morris 1998). Rock engravings also occur at Lime Acres about 20 kms south of Danielskuil, west of the R385 (Morris 2010). Morris (2010) also documented occasional flaked stone at Owendale, an abandoned mine about 13 kms south west of Danielskuil, on the road to Postmansberg. Lita Webley (2010) recorded small numbers of Early, Middle, and Later Stone Age flakes in banded ironstone and chalcedony on the farm Humansrus, a few kilometres south of Owendale on the R385, indicating the long antiquity of the archaeological heritage in this part of the Northern Province, which stretches back more than 1 million years. Beaumont and Boshier (1974) have excavated a prehistoric pigment (specularite) mine on the farm Doornfontein a few kilometres north of Postmansburg. The Doornfontein site consists of a number of chambers which have been dug into a hillside. Archaeological excavations uncovered a large numbers of stone artefacts as well as pottery, decorated ostrich eggshell pieces, beads and bone implements. Radiocarbon dates place the mining activities to 1200 years ago. Fragmentary human remains from the Blinkklipkop mine north-east of Postmasburg suggest that the early miners were of Khoisan physical type rather than representing Iron Age settlement (Webley 2010). Kaplan (2011) also documented low density scatters of LSA tools during a survey for a treated water pipeline in Postmansberg.

## 5. FINDINGS

No archaeological heritage remains were documented during the study of the proposed alternative site. Apart from the weathered surface dolomites in the north western corner of the property, there is virtually no surface stone on the proposed site, which has been heavily grazed.

## 6. CONCLUSION

It is argued that development of the proposed Roma Energy Solar Energy facility on Erf 753 in Danielskuil will have a very limited impact on important archaeological remains.

The archaeologist believes that the probability of locating important archaeological heritage (i.e. stone artefacts) on the proposed site will be low. The reasons for this are the following:

- No archaeological remains were found during the assessment of the alternative site.
- The context of the proposed site is similar to the alternative site in that it comprises grasslands and old pastures, is degraded and in the case of Erf 753, covered by extensive Eskom infrastructure.
- There are no streams, water courses, pans or drainage channels on or near the proposed site where archaeological remains may be expected to be found.
- There are, no significant landscape or any rocky outcrops on the proposed site.
- There is virtually no surface stone covering the proposed site.
- There are no old buildings, structures or any features on the proposed site, apart from, those relating to Eskom infrastructure (transmission line servitudes, access roads, etc), which covers a large portion of the site and the surrounding landscape.
- There are no visible graves on the proposed site.
- Apart from trenches for underground cabling, limited bedrock excavations are envisaged. The solar panels will be raised above ground and mounted on small footings drilled and set into the ground. The excavations for the footings are about 1.5 m in diameter and so the actual ground disturbance will therefore be quite limited and contained

Indications are that in terms of archaeological heritage, the proposed site (Erf 753) for the Danielskuil solar energy farm is not a sensitive, vulnerable or threatened archaeological landscape

Archaeological study proposed solar energy farm near Danielskuil

**7. RECOMMENDATIONS**

With regard to the proposed development of the Roma Energy Solar Farm on Erf 753 in Danielskuil, the following recommendations are therefore made:

1. An Archaeological Impact Assessment of the proposed site is not required and no further archaeological mitigation is required.
2. Should any unmarked human burials/remains or ostrich eggshell water flask caches be uncovered, or exposed during construction activities, these must immediately be reported to the archaeologist (Jonathan Kaplan 082 321 0172), or the South African Heritage Resources Agency (SAHRA) (Att Ms Mariagrazia Galimberti 021 462 4502). Burials must not be removed or disturbed until inspected by the archaeologist.



## 8. REFERENCES

- Beaumont, P. & Boshier, A. 1974. Report on Test Excavations in a Prehistoric pigment mine near Postmasburg, Northern Cape. *South African Archaeological Bulletin* 29:41-59.
- Beaumont, P. B & Morris, D. 1990. Guide to archaeological sites in the Northern Cape. Kimberly McGregor Museum.
- Kaplan, J. 2011. Archaeological Impact Assessment, proposed new Postmansburg treated effluent outfall pipeline on Erf 1 and Olyn Fontein 475/1 & 475/2 Postmansburg, Northern Cape. Report prepared for EnviroAfrica. ACRM Cape Town
- Morris, D. 2010. Archaeological Impact Assessment Phase 1: Proposed development of PV power station at Welcome Wood, near Owendale, Northern Cape. Report prepared for Irme van Zyl Environmental Consultants.
- Morris, D. 2010. Engraved in place and time: a review of the variability in the rock art of the Northern Cape and Karoo. *South African Archaeological Bulletin* 43:109-121
- Morris, D & Beaumont, P. 2004. Archaeology in the Northern Cape: some key site. Kimberly. McGregor Museum.
- Webley, L. 2010. Heritage Impact Assessment of the proposed Groenwater Solar Array, Northern Cape Province. Report prepared for Environmental Resources Management. Archaeology Contracts Office, University of Cape Town

Archaeological study proposed solar energy farm near Danielskuil

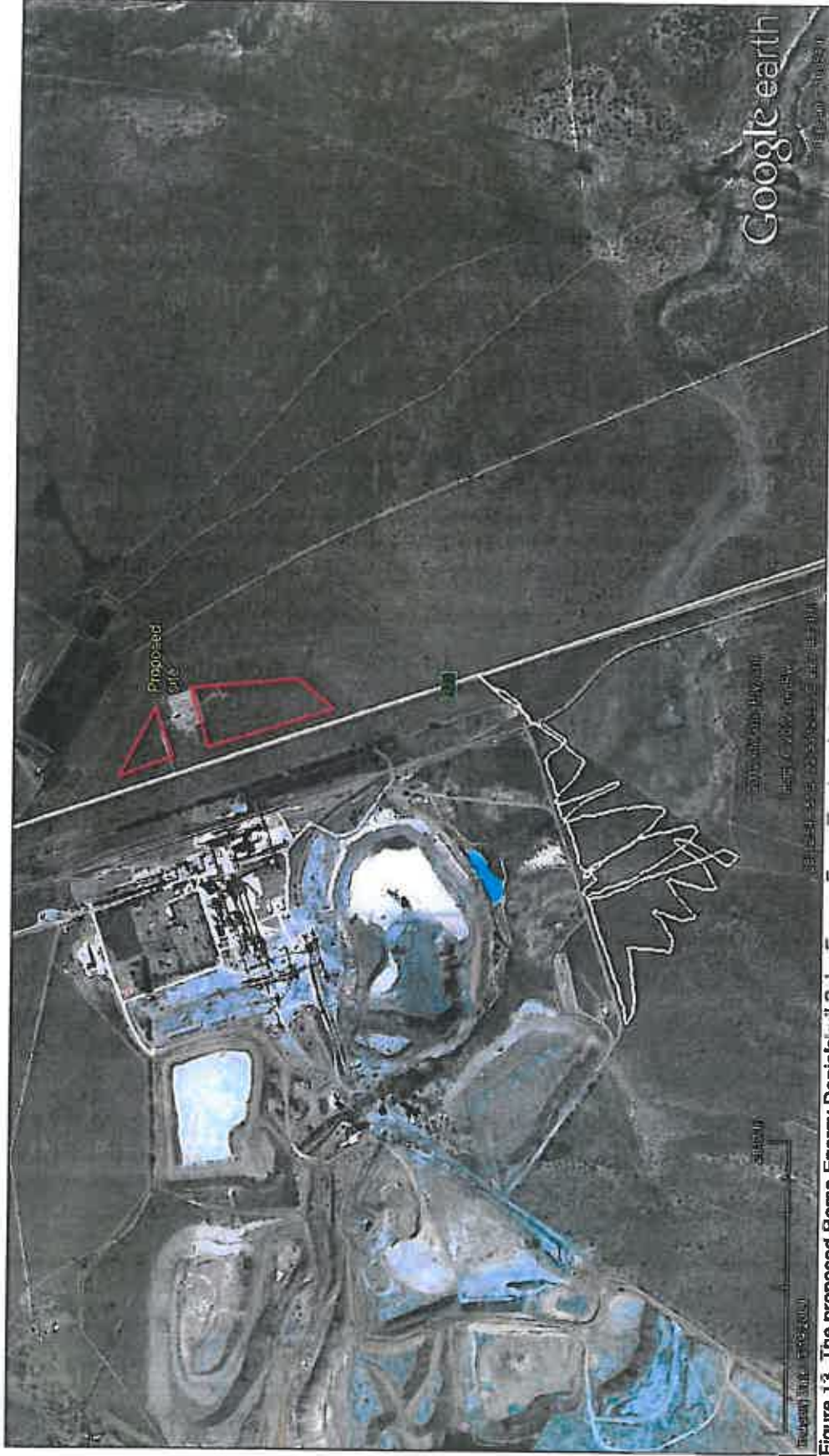

Figure 13. The proposed Roma Energy Danielskuil Solar Energy Farm: Track paths (in white) created for the proposed alternative site

**APPENDIX D3B PALAEOLOGICAL**

**RECOMMENDED EXEMPTION FROM FURTHER  
PALAEOLOGICAL STUDIES & MITIGATION:**

**PROPOSED DANIËLSKUIL ROMA ENERGY SOLAR  
PLANT, KGATELOPELE LOCAL MUNICIPALITY,  
NORTHERN CAPE**

John E. Almond PhD (Cantab.)  
*Natura Viva* cc,  
PO Box 12410 Mill Street,  
Cape Town 8010, RSA  
naturaviva@universe.co.za

March 2012

**1. OUTLINE OF DEVELOPMENT**

Roma Energy Daniëlskuil (Pty) Ltd is proposing to construct a 10 MW Concentrating Photovoltaic (CPV) Energy Generation Facility on Daniëlskuil Erf 753. The study site is situated on the eastern side of the R31 tar road from Daniëlskuil to Douglas and directly east of the existing Idwala limestone mine on the southern outskirts of Daniëlskuil, Kgatelopele Local Municipality, Northern Cape (Fig. 2). The landowner is Idwala Industrial Holdings (Pty) Ltd, Daniëlskuil.

The proposed activity entails the construction of about 140 CPV solar panels with a footprint of about 20 ha. The CPV panels will be mounted on pedestals drilled and set into the ground. Extensive bedrock excavations are not envisaged, but some vegetation will need to be cleared from the site. Associated infrastructure includes a perimeter access road, single track internal access roads, trenches for underground cables, 2 to 4 transformer pads, a switching station, a maintenance shed, and a temporary construction camp. The Ouplaas 132/22kV substation is situated on site.

The present palaeontological heritage comment has been commissioned by EnviroAfrica cc, Somerset West as part of a comprehensive Heritage Impact Assessment of the proposed development (Contact details: Mr Bernard de Witt, EnviroAfrica cc, P. O. Box 5367, Helderberg, 7135; 29 St James St, Somerset West; mobile: +27 82 4489991; tel: +27 21 851 1616; fax: 086203308).

**2. GEOLOGICAL BACKGROUND**

The proposed Daniëlskuil Roma Solar Plant study area (28° 13' S, 23° 33' E) on Daniëlskuil Erf 753 is situated on the southern outskirts of the town of Daniëlskuil, Kgatelopele Local Municipality, Northern Cape. The site lies on the eastern side of the R31 tar road to Douglas and directly east of the Idwala limestone mine on the far side of the road. The area is flat-lying and situated at around 1460m amsl. Shallow water courses run to the southwest and 1.3 km to the east, but outside the area. Satellite images as well as field photographs kindly provided by Jonathan Kaplan of ACRM, Cape Town, indicate that levels of bedrock exposure are low in this region, with occasional exposures of karst-weathered limestone in higher lying areas.

The geology of the study area near Daniëlskuil is shown on the 1: 250 000 geology map 2822 P<sup>O</sup>stmasburg (Council for Geoscience, Pretoria; Fig. 1 herein). A very brief sheet explanation only is printed on the map itself. The proposed solar plant is underlain by Precambrian (Early Proterozoic) carbonate rocks of the **Campbell Rand Subgroup** (Ghaap Subgroup, Transvaal Supergroup) and in particular the **Kogelbeen Formation (Vgl)** which is exploited at the Idwala limestone mine to the west. The Kogelbeen Formation, some 300-440 m thick, consists of a succession of dolomites, limestones and minor secondary (replacement) cherts. Domal and columnar stromatolites (microbial mounds); microbial laminites and oolitic facies are common. The Lime Acres Member at the top of the Kogelbeen succession has been described in some detail by Altermann & Wotherspoon (1995) and is a major target for limestone mining in the region.

The Precambrian sedimentary rocks within the study area are mantled with a spectrum of other coarse to fine-grained **superficial deposits** including **windblown sand (Qs in Fig. 1)** and perhaps also alluvium of intermittently flowing streams. These deposits are generally young (Quaternary to Recent) and largely unfossiliferous (Partridge *et al.* 2006, Almond & Pether 2008).

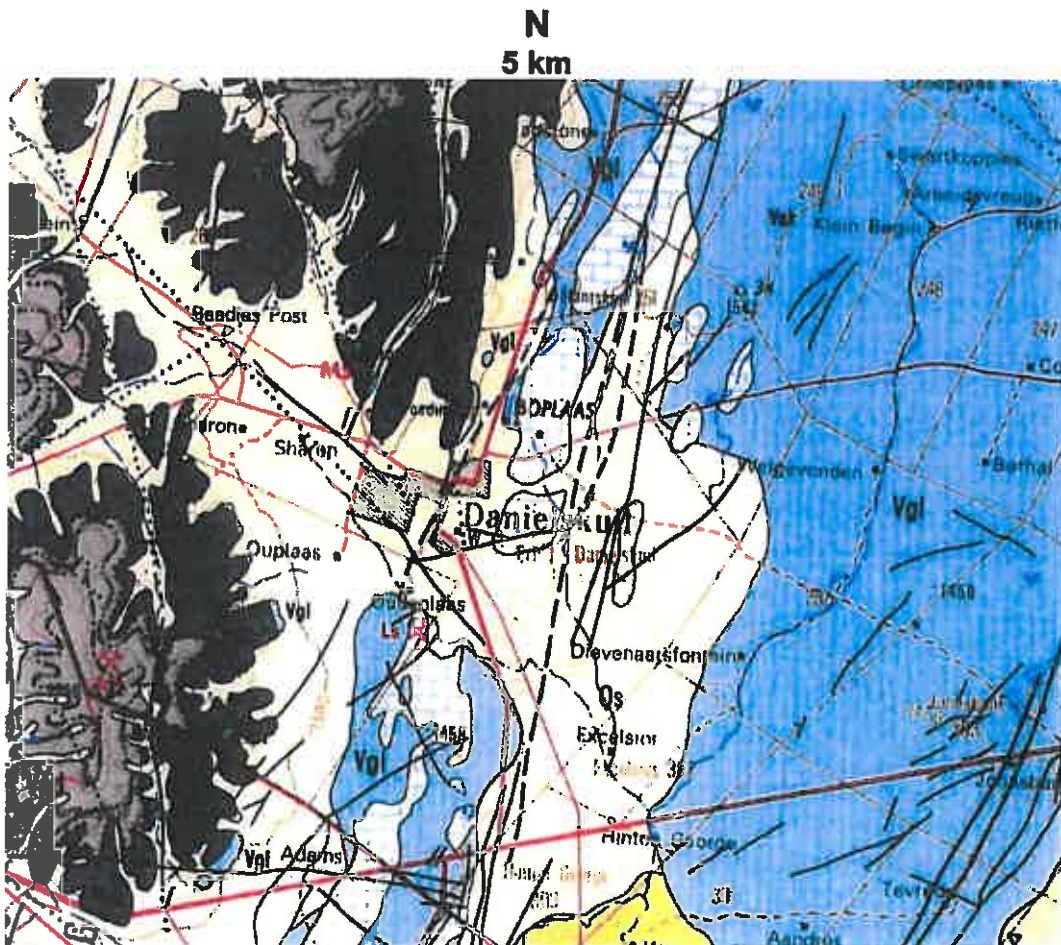

Fig. 1. Extract from 1: 250 000 geological map 2822 Postmasburg (Council for

**Geoscience, Pretoria) showing approximate location of proposed Daniëlskuil Roma Solar Plant study area on the south-eastern outskirts of Daniëlskuil, Northern Cape Province (small yellow rectangle). The study area is underlain by Precambrian (Early Proterozoic) carbonate rocks of the Kogelbeen Formation, Campbell Rand Subgroup (Vgl) that are mantled here by a veneer of wind-blown sands (Qs) and other superficial deposits.**



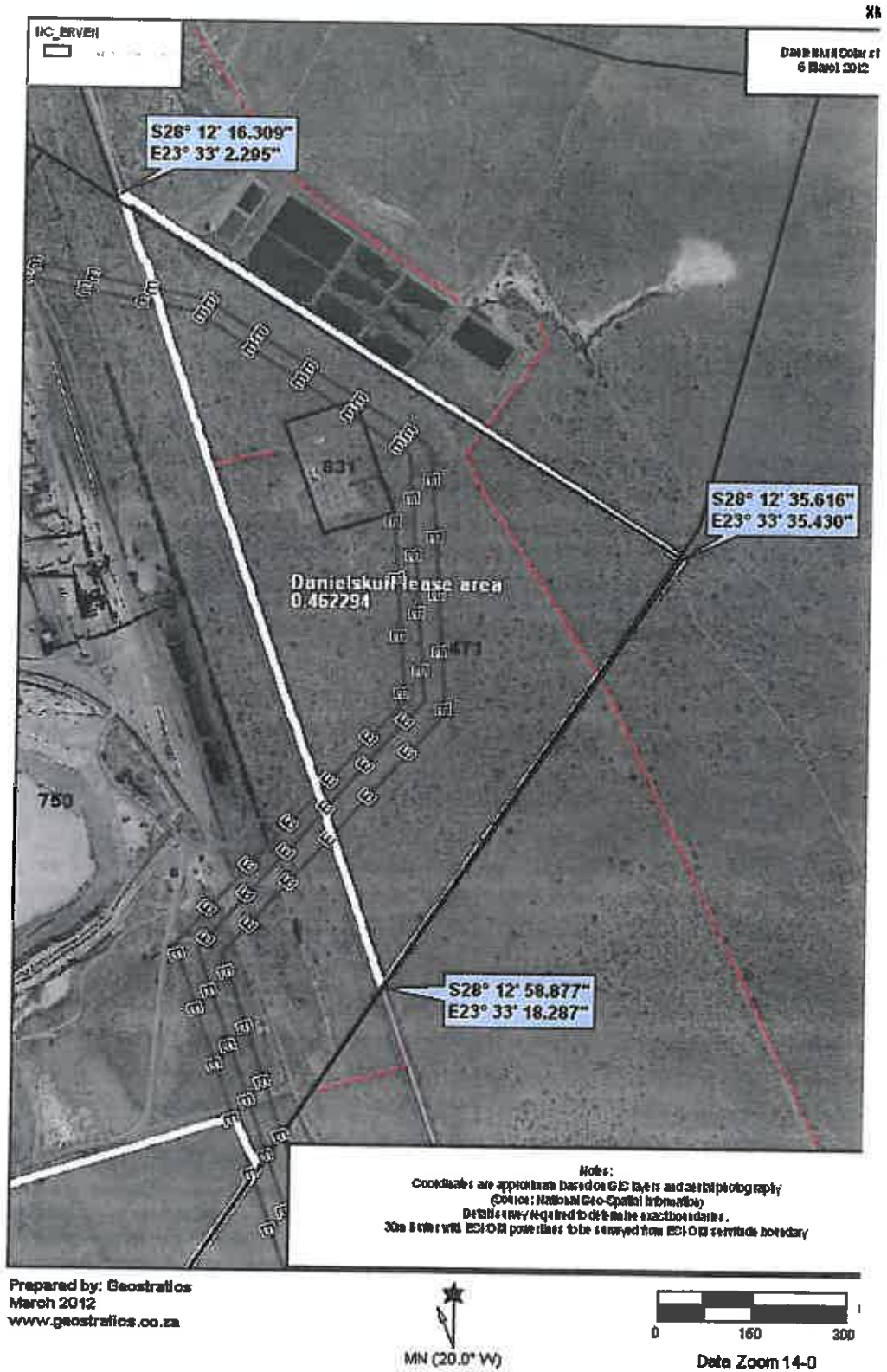

Fig. 2. Satellite image showing the study area for the Daniëlskuil Roma Solar

Plant on the south-eastern outskirts of Daniëlskuil, Northern Cape (Image prepared by Geostratics 2012).

### 3. PALAEOONTOLOGICAL HERITAGE

The fossil record of the Precambrian sediments of the Northern Cape has been briefly reviewed by Almond & Pether (2008). The shallow shelf and intertidal sediments of the carbonate-dominated lower part of the **Ghaap Group**, including the **Campbell Rand Subgroups**, are famous for their rich fossil biota of *stromatolites* or microbially-generated, finely laminated mounds and branching structures. Some stromatolite occurrences on the Ghaap Plateau of the Northern Cape are spectacularly well-preserved (e.g. Boetsap locality figured by McCarthy & Rubidge 2005, Eriksson *et al.* 2006). Detailed studies of these 2.6-2.5Ga (billion year old) carbonate sediments and their stromatolitic biotas have been presented by Young (1932), Beukes (1980, 1983), Eriksson & Truswell (1974), Eriksson & Altermann (1998), Eriksson *et al.* (2006), Altermann and Herbig (1991), Altermann and Wotherspoon (1995). The older Archaean stromatolite occurrences from the Ghaap Group have been reviewed by Schopf (2006, with full references therein).

The **Kogelbeen Formation** features cyclical arrays of domal as well as columnar stromatolites as well as high-energy oolites and flat microbial laminites Eriksson *et al.* 2006). An important fossil stromatolite site in the Lime Acres Member towards the top of the Kogelbeen succession occurs at Lime Acres situated only some 15 km south-southwest of the Daniëlskuil study area (Altermann & Wotherspoon 1995). Some of the oldest known (2.6 Ga) fossil microbial assemblages with filaments and coccoids have been recorded from stromatolitic cherty limestones of the Lime Acres Member, Kogelbeen Formation at Lime Acres (Altermann & Schopf 1995).

The **wind-blown sands** mantling the Precambrian carbonates in the study area are of low palaeontological sensitivity.

The overall palaeontological sensitivity of the Daniëlskuil Roma Solar Plant study area at Daniëlskuil is assessed as LOW (see discussion below).

### 4. CONCLUSIONS & RECOMMENDATIONS

Despite the known occurrence of stromatolites and other microbial fossils in Precambrian rocks underlying the study area, the impact of the proposed Daniëlskuil Roma solar plant development on local fossil heritage is considered to be LOW because:

- The fossiliferous Precambrian bedrocks are mantled here by superficial sediments (e.g. wind-blown sands) of low palaeontological sensitivity. Good surface exposures of stromatolitic limestone are not present here;
- The stromatolites within the Campbell Rand Subgroup are of widespread occurrence, and can be far better studied or sampled in large quarries near Daniëlskuil and at Lime Acres, some 15 km to the SSW;
- Extensive, deep excavations into bedrock are unlikely to be involved in this sort of solar park project.

It is therefore recommended that exemption from further specialist palaeontological studies and mitigation be granted for this solar plant development.



Should any substantial fossil remains (e.g. vertebrate bones and teeth, shells, petrified wood) be encountered during excavation, however, these should be reported to SAHRA for possible mitigation by a professional palaeontologist.

## 5. REFERENCES

- ALMOND, J.E. & PETHER, J. 2008. Palaeontological heritage of the Northern Cape. Interim SAHRA technical report, 124 pp. Natura Viva cc., Cape Town.
- ALTERMANN, J. & HERBIG 1991. Tidal flats deposits of the Lower Proterozoic Campbell Group along the southwestern margin of the Kaapvaal Craton, Northern Cape province, South Africa. *Journal of African Earth Science* 13: 415-435.
- ALTERMANN, W. & SCHOPF, J.W. 1995. Microfossils from the Neoproterozoic Campbell Group, Griqualand West Sequence of the Transvaal Supergroup, and their palaeoenvironmental and evolutionary implications. *Precambrian Research* 75, 65-90.
- ALTERMANN, W. & WOTHERSPOON, J. McD. 1995. The carbonates of the Transvaal and Griqualand West sequences of the Kaapvaal craton, with special reference to the Limje Acres limestone deposit. *Mineralium Deposita* 30, 124-134.
- BEUKES, N.J. 1980. Stratigraphie en litofasies van die Campbellrand-Subgroep van die Proterofitiese Ghaap-Group, Noord-Kaapland. *Transactions of the Geological Society of South Africa* 83, 141-170.
- BEUKES, N.J. 1983. Palaeoenvironmental setting of iron formations in the depositional basin of the Transvaal Supergroup, South Africa. In: Trendall, A.F. & Morris, R.C. (Eds.) *Iron-formation: facts and problems*, 131-210. Elsevier, Amsterdam.
- BEUKES, N.J. 1986. The Transvaal Sequence in Griqualand West. In: Anhaeusser, C.R. & Maske, S. (Eds.) *Mineral deposits of Southern Africa*, Volume 1, pp. 819-828. Geological Society of South Africa.
- ERIKSSON, P.G. & TRUSWELL, J.F. 1974. Tidal flat associations from a Lower Proterozoic carbonate sequence in South Africa. *Sedimentology* 21: 293-309.
- ERIKSSON, P.G. & ALTERMANN, W. 1998. An overview of the geology of the Transvaal Supergroup dolomites (South Africa). *Environmental Geology* 36, 179-188.
- ERIKSSON, P.G., ALTERMANN, W. & HARTZER, F.J. 2006. The Transvaal Supergroup and its precursors. In: Johnson, M.R., Anhaeusser, C.R. & Thomas, R.J. (Eds.) *The geology of South Africa*, pp. 237-260. Geological Society of South Africa, Marshalltown.
- KLEIN, C., BEUKES, N.J. & SCHOPF, J.W. 1987. Filamentous microfossils in the early Proterozoic Transvaal Supergroup: their morphology, significance, and palaeoenvironmental setting. *Precambrian Research* 36, 81-94.

PARTRIDGE, T.C., BOTHA, G.A. & HADDON, I.G. 2006. Cenozoic deposits of the interior. In: Johnson, M.R., Anhaeusser, C.R. & Thomas, R.J. (Eds.) *The geology of South Africa*, pp. 585-604. Geological Society of South Africa, Marshalltown.

SCHOPF, J.W. 2006. Fossil evidence of Archaean life. *Philosophical Transactions of the Royal Society of London B* 361, 869-885.

YOUNG, R.B. 1932. The occurrence of stromatolitic or algal limestones in the Campbell Rand Series, Griqualand West. *Transactions of the Geological Society of South Africa* 53: 29-36.

## 6. QUALIFICATIONS & EXPERIENCE OF THE AUTHOR

Dr John Almond has an Honours Degree in Natural Sciences (Zoology) as well as a PhD in Palaeontology from the University of Cambridge, UK. He has been awarded post-doctoral research fellowships at Cambridge University and in Germany, and has carried out palaeontological research in Europe, North America, the Middle East as well as North and South Africa. For eight years he was a scientific officer (palaeontologist) for the Geological Survey / Council for Geoscience in the RSA. His current palaeontological research focuses on fossil record of the Precambrian - Cambrian boundary and the Cape Supergroup of South Africa. He has recently written palaeontological reviews for several 1: 250 000 geological maps published by the Council for Geoscience and has contributed educational material on fossils and evolution for new school textbooks in the RSA.

Since 2002 Dr Almond has also carried out palaeontological impact assessments for developments and conservation areas in the Western, Eastern and Northern Cape under the aegis of his Cape Town-based company *Natura Viva* cc. He is a long-standing member of the Archaeology, Palaeontology and Meteorites Committee for Heritage Western Cape (HWC) and an advisor on palaeontological conservation and management issues for the Palaeontological Society of South Africa (PSSA), HWC and SAHRA. He is currently compiling technical reports on the provincial palaeontological heritage of Western, Northern and Eastern Cape as well as Limpopo, Free State and Gauteng for SAHRA and HWC. Dr Almond is an accredited member of PSSA and APHP (Association of Professional Heritage Practitioners – Western Cape).

### Declaration of Independence

I, John E. Almond, declare that I am an independent consultant and have no business, financial, personal or other interest in the proposed project, application or appeal in respect of which I was appointed other than fair remuneration for work performed in connection with the activity, application or appeal. There are no circumstances that compromise the objectivity of my performing such work.

*John E. Almond*

**Dr John E. Almond  
Palaeontologist  
*Natura Viva* cc**

***APPENDIX D3C VISUAL***

# DANIELSKUIL, PORTION ERF 753: SOLAR ENERGY FACILITY

## VISUAL ASSESSMENT

For consideration in the Basic Assessment

For

EnviroAfrica

PO Box 5367

Helderberg

7135

info@enviroafrica.co.za

Final Report

11 May 2012

Compiled by:

S.C. Lategan



PO Box 1082

Strand

7139

### Report history:

Version	Date	Amendments
Draft Report: Version 1	26 March 2012	
Final Report	11 May 2012	

## CONTENT

1	BACKGROUND.....	1
2	TERMS OF REFERENCE.....	2
3	Methodology and principles.....	4
3.1	Methodology.....	4
3.1.1	Principles.....	4
3.1.2	Fatal flaw statement.....	4
3.1.3	Gaps, limitations and assumptions.....	5
3.1.4	Assessment explained.....	5
3.2	Legal Framework, Guidelines and policies.....	5
3.2.1	National Environmental Management Act, 107, 1998 and relevant Guidelines:.....	5
3.2.2	Northern Cape PSDF.....	5
3.2.3	Green Kalahari tourism.....	5
3.2.4	Syianda Environmental Management Framework.....	5
4	DEVELOPMENT PROPOSAL.....	7
4.1	General Description.....	7
4.2	Project Elements.....	8
4.2.1	Extent and layout.....	8
4.2.2	Tracking CPV Units.....	9
4.2.3	Project perimeter.....	10
4.2.4	Supportive Infrastructure.....	10
4.2.5	Operational elements.....	11
4.3	Construction elements.....	11
5	RECEIVING VISUAL ENVIRONMENT.....	11
5.1	Description.....	11
5.1.1	Catchment area.....	11
5.1.2	Sense of Place:.....	11
5.2	Findings.....	11
6	VISUAL RECEPTORS.....	15
6.1	Potential Receptors.....	15
6.2	Assessment of Receptors.....	15
7	CONSTRUCTION.....	26
8	FINDINGS.....	26
9	MITIGATION MEASURES.....	26

### Tables:

Table 1:	Requirements for visual assessment.....	3
Table 2:	Nature of intended development.....	3
Table 3:	R31 northbound assessed.....	18
Table 4:	R31 southbound view assessed.....	19
Table 5:	Monument view assessed.....	20
Table 6:	Neighbourhood to the north assessed.....	21
Table 7:	: Residential area to the west view assessed.....	22
Table 8:	Residential south view assessed.....	23
Table 9:	Summary of Visual Receptor assessment.....	24

### Figures:

Figure 1:	Locality.....	1
Figure 2:	Site boundary.....	2
Figure 3:	Typical Solar Farm layout.....	7
Figure 4:	Typical CPV Unit.....	7
Figure 5:	Typical Layout configuration.....	8
Figure 6:	Storm Stow position.....	9
Figure 7:	Typical Operational position.....	9
Figure 8:	Night stow position.....	9

Figure 12: Transformer Pads and typical transformer .....	10
Figure 9: Typical electrical fence .....	10
Figure 10: Typical galvanized palisade fence .....	10
Figure 11: Typical 22KV single Powerline .....	10
Figure 13: View catchment .....	13
Figure 14: Land use continuum.....	14
Figure 15: Immediate land use elements .....	14
Figure 16: Potential visual receptors identified .....	17
Figure 17: R31 northbound as receptor .....	18
Figure 18: R31 southbound as receptor .....	19
Figure 19: Monument as receptor.....	20
Figure 21: Residential north as receptor .....	21
Figure 22: Residential west as receptor.....	22
Figure 23: Residential south as receptor .....	23

**Relevant Qualifications & Experience of the Author**

Ms Sarien Lategan holds a Honours Degree in Geography as well as a Masters Degree in Town and Regional Planning from the University of Stellenbosch. She has 7 years experience as Town planner at a local government, 3 years with South African national Parks as planner and project manager of various GEF and World Bank managed, tourist facilities in the Table Mountain National Park and since 2004 as private practitioner involved in inter alia Site Analysis and Visual Impact assessments for various types of developments ranging from housing, tourism to infrastructure developments.

Ms Lategan is registered as a professional Town and Regional Planner as well as Environmental Assessment Practitioner.

**Declaration of Independence**

I, Sarah C. Lategan, fully authorized by Geostratics CC, declare that I am an independent consultant to EnviroAfrica and neither myself nor Geostratics, has any business, financial, personal or other interest in the proposed project or application in respect of which I was appointed, other than fair remuneration for work performed in connection with the application. There are furthermore no circumstances which compromise my objectivity in executing the task appointed for.



SC Lategan



## EXECUTIVE SUMMARY

Sarien Lategan of Geostratics was appointed to undertake the visual impact assessment of a maximum 10Megawatt solar facility, as input to the Basic Assessment in terms of the national Environmental management Act, 1998 (Act no. 107 of 1998), as amended and the Environmental Impact Assessment Regulations, 2010 by undertaken EnviroAfrica. The development of the solar farm is proposed by Keren Energy (Pty) Ltd. The site on which the facility is planned comprises a portion of Erf 753, Danielskuil opposite the Indwala Lime mine.

The site is situated on the southern outskirts of Danielskuil adjacent the R31, abutting the ESKOM substation.

The aim of the assessment is to identify view receptors and assess the impact of the development on these receptors. In this regard the larger site, i.e. an area of approximately 7km<sup>2</sup> was screened and based on this findings as well as inputs by other specialists, a most suitable area of 20ha was identified on which the final assessment focus.

At the time of assessment a final decision has not yet been taken on the exact technology or mix of technology to be used in the development. In this regard the worst case scenario has been followed by assessing the technology most probably going to have the most visual impact in terms of size of structures. Should a different technology thus been decided on which involve smaller units, the visual impacts will certainly be less than what is assessed in this report. For the purposes of this study thus, tracking CPV units of dimensions 15,64m in height and 17m wide has been assessed.

The assessment established that the receiving environment comprise a mix of land uses often associated with commonages on the edge of towns with little sense of place or urban coherence as well as a mining character. The proximity of the development to industrial related uses and infrastructure e.g. the electrical substation, sewage works, landfill and mining, implies that the use is consistent with the overall land use of the area. From this perspective the proposed solar farm will not have a negative impact on the sense of place or urban context. Although the area appears fairly flat, it does host subtle altitude variations which create an area capable of absorbing a certain level of structures. With the high level of existing infrastructure, these elements will also absorb the solar farm.

The sensitive receptors identified include the R 31 giving access to the town, residential areas and the monument on the hill behind the town. It was however determined that the exact positioning of the facility behind existing infrastructure and taking into account the screening properties of the topographical features, the exposure level and intrusion factor reduce the impact to within the acceptable levels not to have a significant visual impact on the identified sensitive receptors.

The overall conclusion is that the visual impact is within acceptable levels and could thus be recommended. Due to the nature of the type of technology, little mitigation measures can be implemented to further reduces any potential visual impacts.

# 1 BACKGROUND

Sarien Lategan of Geostratics was appointed to undertake the visual impact assessment of a maximum 10Megawatt solar facility, as input to the Basic Assessment in terms of the national Environmental management Act, 1998 (Act no. 107 of 1998), as amended and the Environmental Impact Assessment Regulations, 2010 by undertaken EnviroAfrica. The development of the solar farm is proposed by Keren Energy (Pty) Ltd. The site on which the facility is planned comprises a portion of Erf 753, Danielskuil opposite the Indwala Lime mine.

The site is situated on the southern outskirts of Danielskuil adjacent the R31, abutting the ESKOM substation. The portion utilized by the mine is zoned for mining purposes but the remainder of the erf is undetermined.

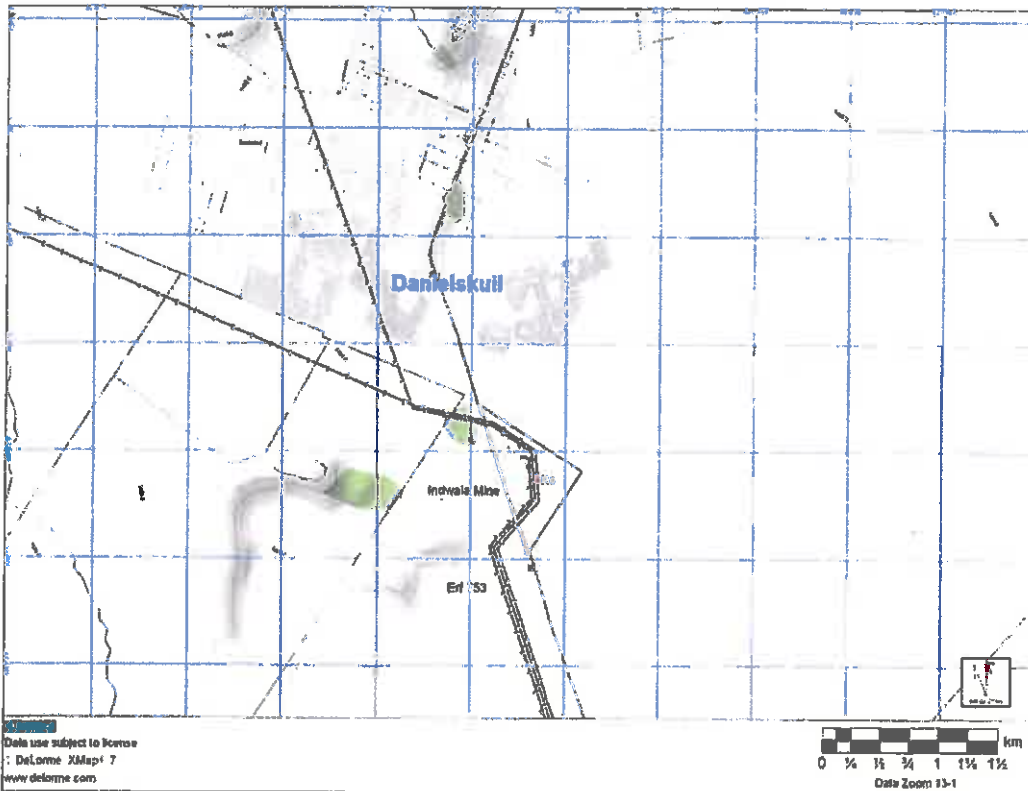

Figure 1: Locality

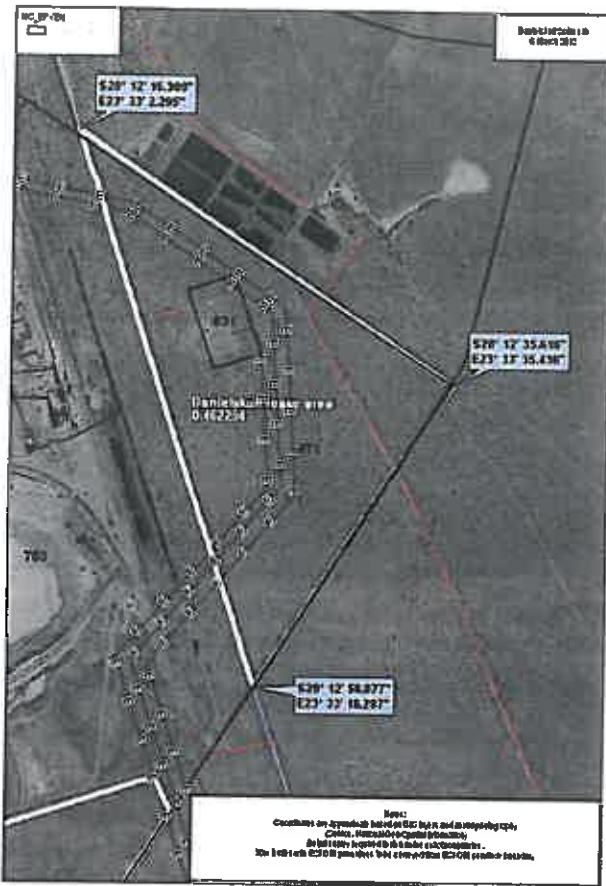

Figure 2: Site boundary

## 2 TERMS OF REFERENCE

The applicant intends the development of a solar farm on a portion of Erf 753, Danielskuil. The site gain access off the R31 just south of the town.

The objective of the Visual Impact assessment is to determine the significance of any visual impact. This assessment will indicate whether from a visual perspective the development constitute and acceptable level of change and if so what potential mitigation measures can reduce any visual impact as to limit

To determine the potential extent of the VIA required the following broad criteria are considered.

Areas with protection status, e.g. nature reserves	None
Areas with proclaimed heritage sites or scenic routes	None.
Areas with intact wilderness qualities, or pristine ecosystems	None.
Areas with intact or outstanding rural or townscape qualities	None
Areas with a recognized special character or sense of place	None

Areas with sites of cultural or religious significance	None
Areas of important tourism or recreation value	The site is in a region where such elements exists and are important in the Green Kalahari tourist route, although the specific route, namely R31 has not been identified as a scenic drive or tourist route.
Areas with important vistas or scenic corridors	To assess.
Areas with visually prominent ridgelines or skylines.	None

**Table 1: Requirements for visual assessment**

High intensity type projects including large-scale infrastructure	yes
A change in land use from the prevailing use	Infill of property currently used for utility/infrastructure
A use that is in conflict with an adopted plan or vision for the area	No
A significant change to the fabric and character of the area	No
A significant change to the townscape or streetscape	Potentially
Possible visual intrusion in the landscape	Potentially
Obstruction of views of others in the area	Potentially

**Table 2: Nature of intended development**

From the above it is clear that the receiving environment holds certain visual elements which may be impacted upon by development of the site.

It is thus clear that the potential exist that development of the site may have a visual impact. In order to assist authorities thus to make an informed decision, the input of a specialist is required to assist in the project design and assess the visual impact of the preferred project proposal.

The term visual and aesthetic is defined to cover the broad range of visual, scenic, cultural, and spiritual aspects of the landscape. The terms of reference for the specialist is to:

- Provide the visual context of the site with regard to the broader landscape context and site specific characteristics.
- Provide input in compiling layout alternatives.
- To describe the affected environment and set the visual baseline for assessment
- Identify the legal, policy and planning context
- Identifying visual receptors
- Predicting and assessing impacts
- Recommending management and monitoring actions

### 3 Methodology and principles

#### 3.1 Methodology

Table 4: Summary of methodology

Task undertaken	Purpose	Resources used
A screening of the site and environment	To obtain an understanding of the site and area characteristics and potential visual elements	Photographs Site visits
Identify visual receptors	To assess visual impact from specific view points	Photographs, profiles
Contextualize the site within the visual resources	To present an easy to understand context of the site within the visual resource baseline	Specialist: S. Lategan Graphic presentation Superimposed photo's Model in case of high significance
Propose possible mitigation measures	To present practical guidelines to reduce any potential negative impacts.	Specialist: S. Lategan

Throughout the evaluation the following fundamental criteria applied:

- Awareness that "visual" implies the full range of visual, aesthetic, cultural and spiritual aspects of the environment that contribute to the area's sense of place.
- Consideration of both the natural and cultural (urban) landscape, and their inter-connectivity.
- The identification of all scenic resources, protected areas and sites of special interest, as well as their relative importance in the region.
- Understanding of the landscape processes, including geological, vegetation and settlements patterns which give the landscape its particular character or scenic attributes.
- The inclusion of both quantitative criteria, such as visibility and qualitative criteria, such as aesthetic value or sense of place.
- The incorporation of visual input as an integral part of the project planning and design process, so that the findings and recommended mitigation measures can inform the final design and quality of the project.
- To test the value of visual/aesthetic resources through public involvement.

##### 3.1.1 Principles

The following principles to apply throughout the project:

- The need to maintain the integrity of the landscape within a changing land use process
- To preserve the special character or 'sense of place' of the area
- To minimize visual intrusion or obstruction of views
- To recognize the regional or local idiom of the landscape.

##### 3.1.2 Fatal flaw statement

A potential fatal flaw is defined as an impact that could have a "no-go" implication for the project.

A "no-go" situation could arise if the proposed project were to lead to (Oberholzer, 2005):

1. Non-compliance with Acts, Ordinance, By-laws and adopted policies relating to visual pollution, scenic routes, special areas or proclaimed heritage sites.
2. Non-compliance with conditions of existing Records of Decision.
3. Impacts that may be evaluated to be of high significance and that are considered by the majority of stakeholders and decision-makers to be unacceptable.

The screening of the site and initial project intentions did not reveal any of the above issues which may result in a fatal flaw.

### 3.1.3 Gaps, limitations and assumptions

The assessment has to be read with the following in mind:

1. No information is available on the alignment of transmission lines linking the solar facility with the Eskom substation, but due to the locality of the substation adjacent the site it is assumed that no off-site transmission lines will be required.
2. Access is obtained via existing roads and no road upgrades or new roads will be constructed.

### 3.1.4 Assessment explained

The assessment of visual impact is done on two levels namely the absorption rate of the receiving environment and the individual view receptors. The absorption rate of the receiving environment is determined by various elements e.g. topography, land use etc and the assessment will focus on the acceptable level of change of the area.

Visual receptors are assessed individually based on the sensitivity of the receptor, exposure to the development and intrusion rate.

The following framework is used in order to assess view receptors:

Criteria	High	Moderate	Low
Exposure	Dominant, clearly visible	Recognizable to the viewer	Not particularly noticeable to the viewer
Sensitivity	Residential, nature reserves, scenic routes	Sporting, recreational, places of work	Industrial, mining, degraded areas
Intrusion/Obstructive	Noticeable change, discordant with surroundings	Partially fits but clearly visible	Minimal change or blends with surroundings

A sensitive receptor with a low exposure and/or low intrusion rate can be regarded as a low significance rating. A receptor of low sensitivity but with high exposure can be of high significance if the intrusion rate is also high but is reduced if the intrusion rate is medium or low.

The overall significance therefore depends not only on the sensitivity of the receptor but also on the exposure and intrusion rate and thus a combination of the criteria.

## 3.2 Legal Framework, Guidelines and policies

### 3.2.1 National Environmental Management Act, 107, 1998 and relevant Guidelines:

An assessment in terms of any activity that required an EIA or Basic Assessment may be subjected to a specialist visual assessment in order to determine the significance of the potential impacts to result from a proposed activity.

The National Dept has subsequently determined that all applications for solar farms are subject to a visual impact assessment.

### 3.2.2 Northern Cape PSDF

The PSDF provides guidance to ensure that

- development is of a quality that promotes environmental integrity.
- based upon the principles of 'critical regionalism' which promotes a return to the development of high-quality settlements.
- remised upon "The Big Five" principles that guide the planning, design and management of development namely sense of place, sense of history, sense of nature, sense of craft and sense of limits.

### 3.2.3 Green Kalahari tourism

The Green Kalahari tourist plan is an initiative to promote tourism in the region. The protection of cultural and heritage resources as well as the active involvement and empowerment of local communities through tourism is a core theme through the tourism plan.

### 3.2.4 Syianda Environmental Management Framework

The EMF indicates that the improvement of energy delivery to communities is important and makes the following statements in paragraph 2.3.6

*"(b) Opportunities: Due to the climate of the area there is huge potential to utilise solar energy more widely, especially in the remote areas of the district.*

*(c) Constraints: The small communities in sparsely populated areas make effective distribution of electricity very difficult in some areas.*

*(d) Desired state. The desired actions relating to energy supply in the area:*

- Electricity provision should be extended to all areas in order to reduce the dependency on candles and wood as the main energy sources (the strong reliance on wood is not sustainable over the long term and can lead to the overexploitation of especially Camel Thorn trees in the area); and*
- the excellent potential for the utilisation of alternative energy sources should be optimised by a sponsored programme to introduce alternative energy on a large scale to remote communities."*

The EMF however only refers to visual impacts related to mining and made a broad statement that mines should be rehabilitated to reduce visual impact on the environment. No further guidelines or principles related to visual environment is provided in the EMF.

## 4 DEVELOPMENT PROPOSAL

### 4.1 General Description

Construction of Solar energy production facility ("Solar Farm") with a maximum capacity of 10Megawatt, consisting of approximately 140 tracking CPV units, on approximately 20ha. The exact technology to be used has not been determined and this assessment is based on the following typical parameters. Units are typically positioned in rows with access roads between every second row. Unit spacing typically varies between 43x37 and 33x30m.

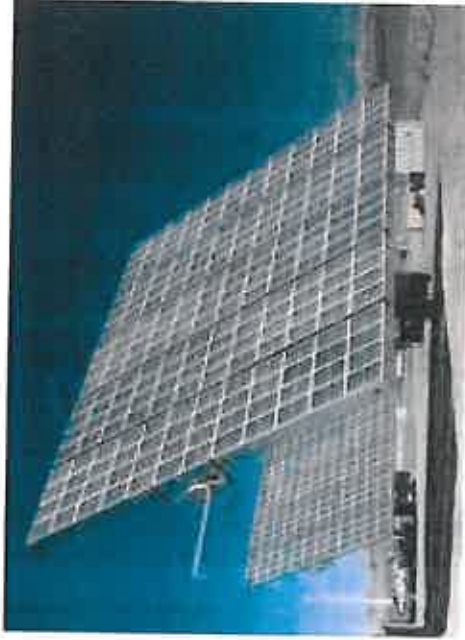

Figure 4: Typical CPV Unit

The Solar Farm includes supportive infrastructure which consists of 2 -4 concrete transformer pads approximately 20x15m respectively, a fenced construction staging area, maintenance shed and a switch panel for connection to the grid and transmission lines from the transformers to the closest ESKOM substation.

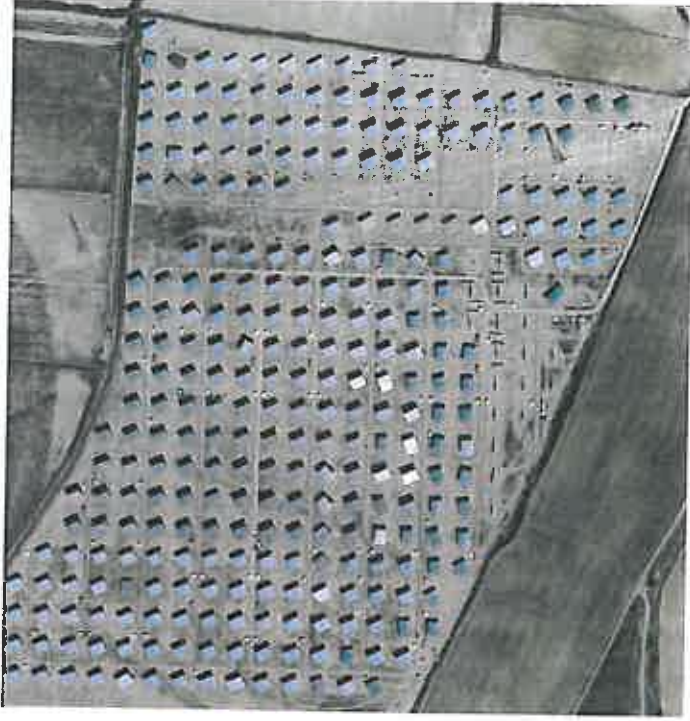

Figure 3: Typical Solar Farm layout



## 4.2 Project Elements

### 4.2.1 Extent and layout

The Solar farm will occupy approximately 20ha. The nature of the tracking CPV units are such that the property has to be leveled to less than 1:5 gradient in order to prevent the units to touch the ground when turning on the pedestal. CPV units are positioned in a grid with the active panel side facing north. The units will rotate from east (morning) to west (afternoon). Back of units facing south. Units are position in rows of two with access roads in between.

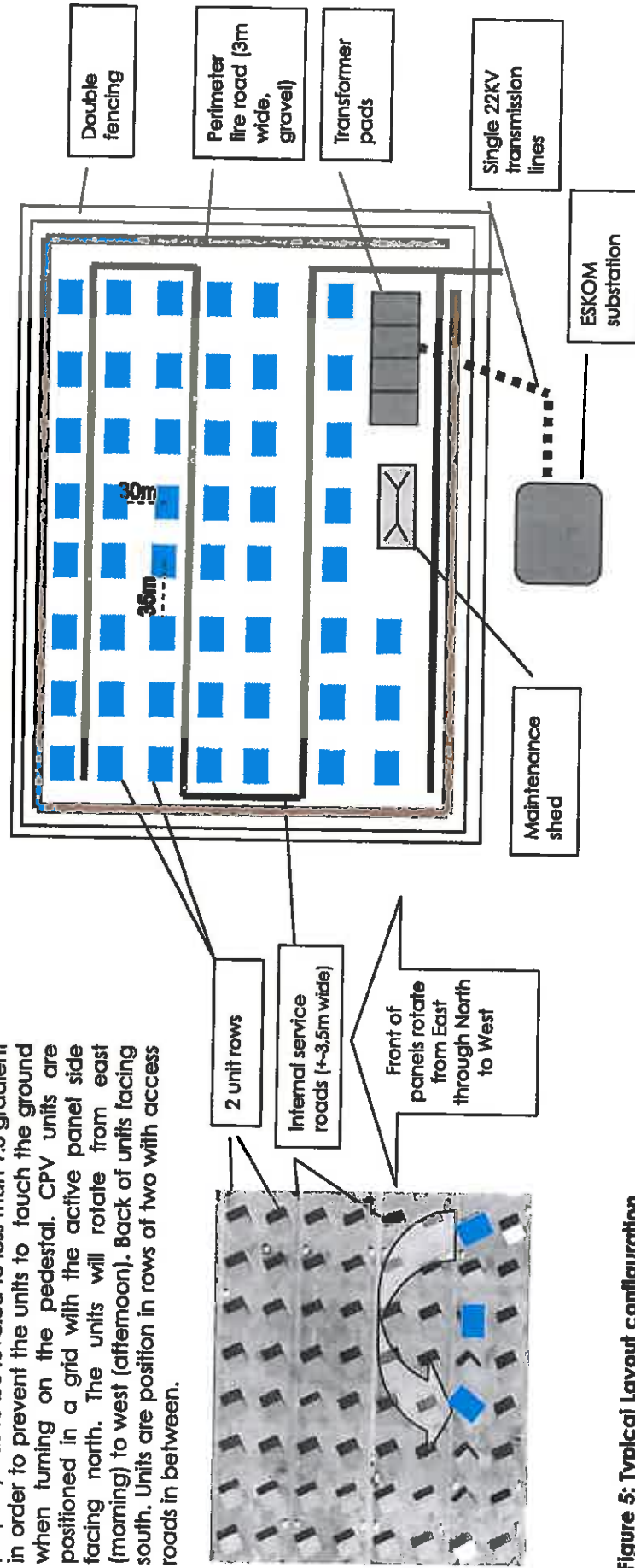

Figure 5: Typical Layout configuration

### 4.2.2 Tracking CPV Units

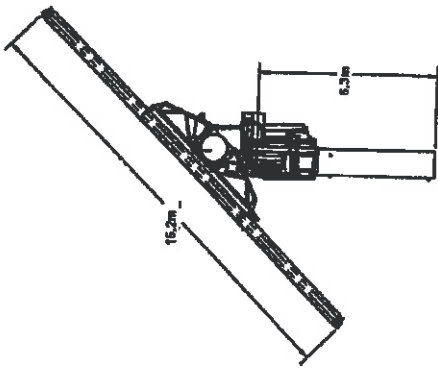
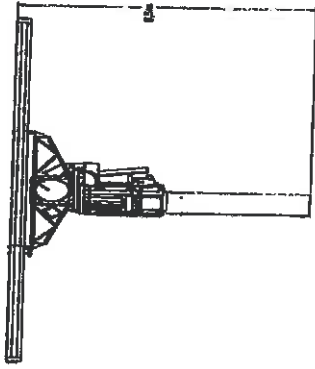

Figure 7: Typical Operational position



In storm: >28 mph. > 10 sec. Out of slow: <26 mph. >300 sec.  
Figure 6: Storm Slow position

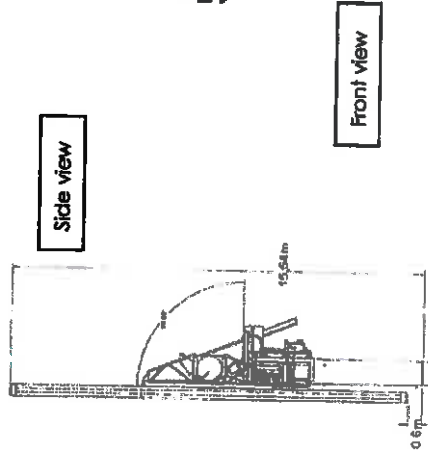
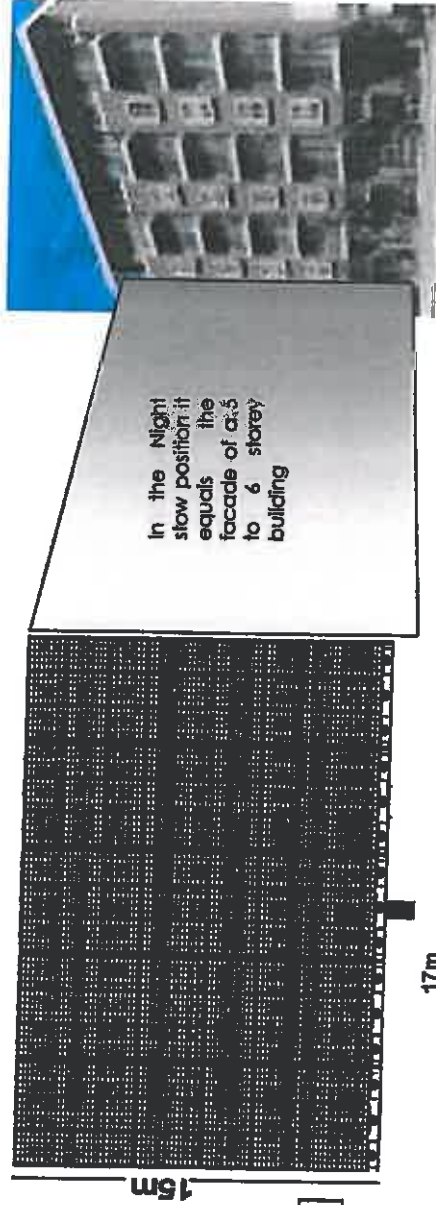

Figure 8: Night slow position



VIA: Dantieskull

### 4.2.3 Project perimeter

Double fencing with inner fence consisting of galvanized palisade fence and outer an electrified fence of 2.4m in height.



Figure 9: Typical electrical fence



Figure 10: Typical galvanized palisade fence

### 4.2.4 Supportive Infrastructure

Typically 20 x 15m respectively.  
Black top surface

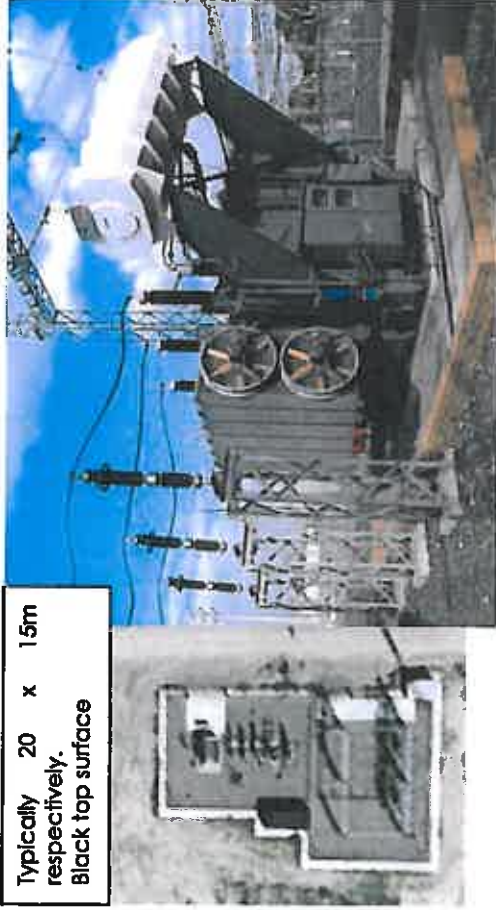

Figure 12: Transformer Pads and typical transformer

Single 22KV Power lines will feed from the transformers to the FSKOM



Figure 11: Typical 22KV single Powerline

#### 4.2.5 Operational elements

Depending on the exact technology the operational activities can vary. For the typical units described above, teams will access the site and physically clean panels. This is done either by rope access or the use of "cherry pickers". In areas of high dust conditions, cleaning can be more regular.

### 4.3 Construction elements

For the construction of the typical units describe above, large earth moving equipment will be used as well as high lift equipment and cranes. Large transport trucks for delivery will enter the site during construction. For technology that uses smaller units or static units the scale of equipment required for construction will be less.

Construction process entails:

- clearing and leveling of the site,
- construction of pedestals which involve concrete bases and
- fitting of panels
- construction of internal and access roads
- Fencing and security infrastructure
- Construction of support facilities such as maintenance sheds, etc
- Construction of transmission lines

## 5 RECEIVING VISUAL ENVIRONMENT

### 5.1 Description

Understanding the potential impact of a proposed development, an understanding of the receiving environment is important. In this regard the main elements of the receiving environment relates to the character of the current surrounding land use and the absorption capacity of the area. The character of the area entails the sense of place created by the current land use and the scale and type of infrastructure or physical elements within the immediate area. The absorption capacity relate to the density of physical elements and topographical variations of the landscape, which will determine the catchment area. The human eye will observe the horizon on a perfectly flat surface at a distance of 30km. This is however significantly reduced by landscape elements which obstruct the view.

#### 5.1.1 Catchment area

The landscape consist a fairly flat plain interspersed with occasional low hills. The town to the north is situated on the lower slopes of a hill and face south towards the site.

The hills to the north and northwest restrict the catchment area to the slopes of these hills which are closer than 5km from the site. Due to the undulating landscape to the south and east, the catchment area is restricted to approximately 5km (Figure 13).

#### 5.1.2 Sense of Place:

The site is situated in the southern outskirts of the town. It is surrounded by infrastructure, which include High voltage power lines, an electrical substation, sewage works lime mine and mine dump (Figure 15). Other land uses in the area include urban development and large vacant land. Residential neighbourhoods are located north and northwest of this area. The immediate area reflects a mining and infrastructure character

### 5.2 Findings

The proposed site is situated within the urban edge zone of Danielskuil in an area characterized by industrial type buildings and large infrastructure. The larger area reflects the characteristics of a rural to urban landscape and the site is situated within this land use continuum.

The area is characterized by a flowing topography of low rises on a large plain. It is interspersed with occasional low hills. The plain area however display such a level of gradient that present a fairly high level of absorption and view is on average restricted to the immediate environment and seldom more than 5km. The human eye can observe the horizon on a perfectly flat surface up to 30km. The Danielskuil area however displays sufficient gradient variations to restrict this view significantly.

**Statement 1:** The property on which the development is proposed, is currently used for a range of utility type of land use as well as large scale mining and therefore the proposed solar farm seem to be in character with these elements.

**Statement 2:** Due to the medium absorption capacity of the landscape, the development will easily be absorbed into the existing visual structure.

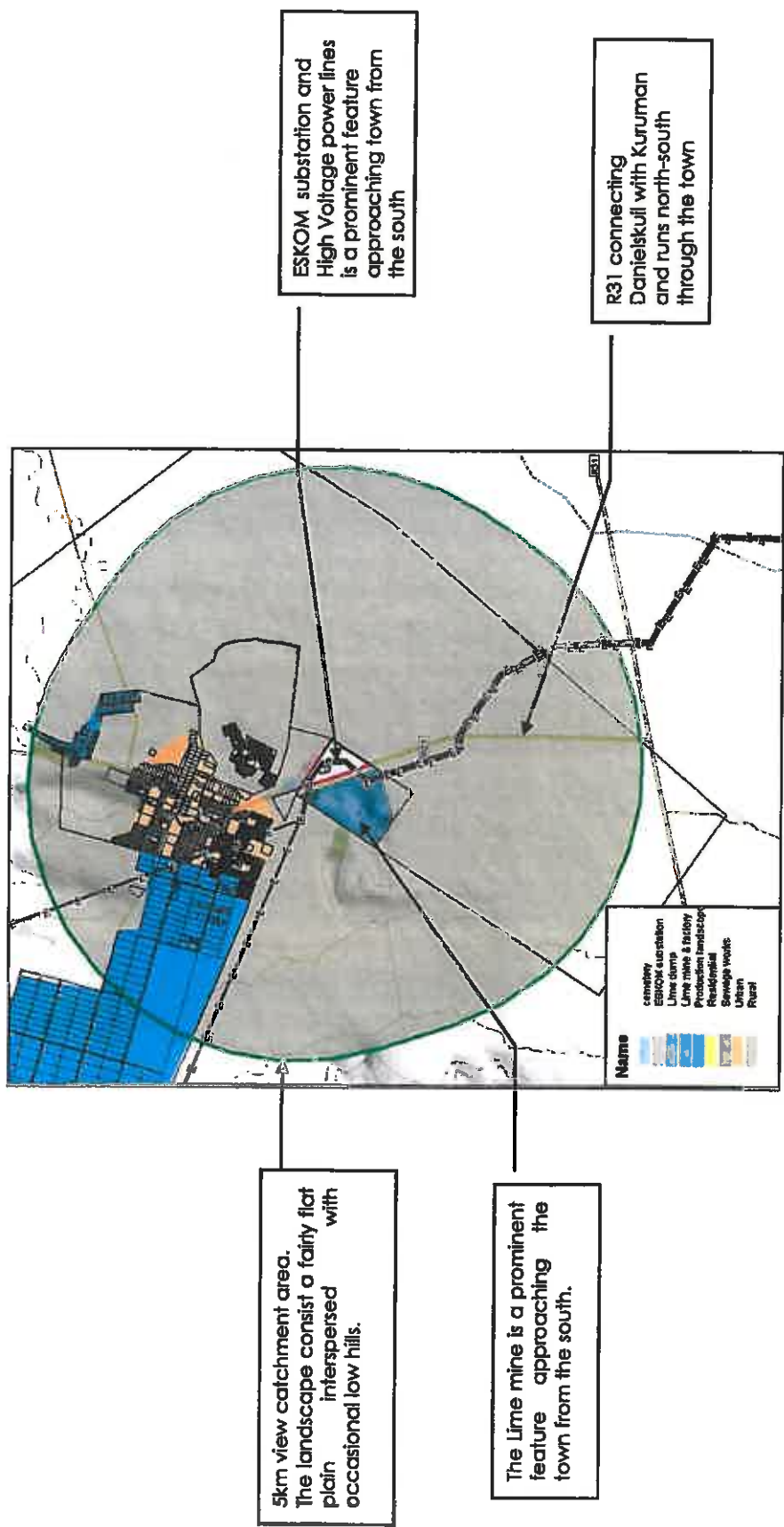

Figure 13: View catchment



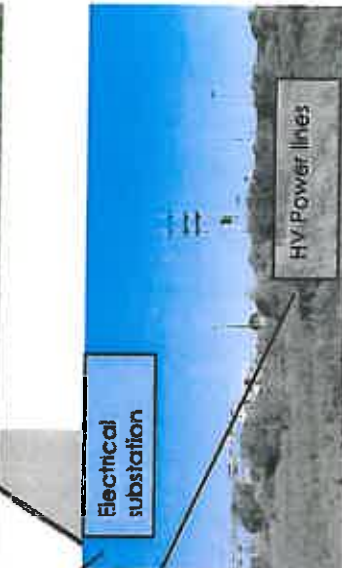
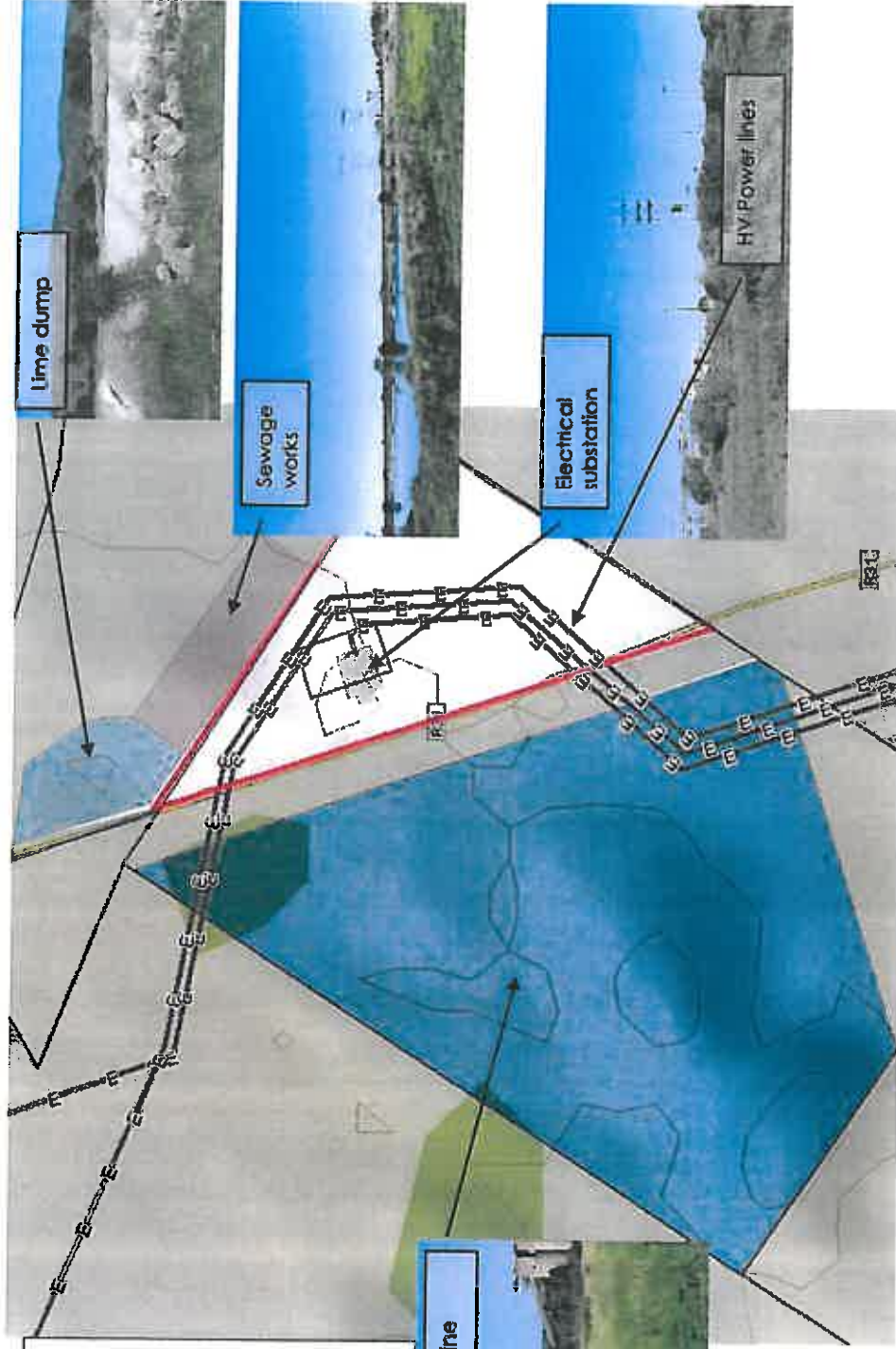

**Figure 14: Land use continuum**

The site is situated in the southern outskirts of the town. It is surrounded by infrastructure which include High voltage power lines, sewage works lime mine and mine dump.

Other use in the area include urban development large vacant land. Residential neighbourhoods are located north and northwest of this area.

The immediate area reflects a mining and infrastructure character.



**Figure 15: Immediate land use elements**

## 6 VISUAL RECEPTORS

Visual receptors are those positions from where the development site is potentially visible. Based on the character of the locality of the receptor its sensitivity can be rated. Generally residential areas and tourism related destinations and routes are sensitive to visual intrusions as they relate to the well-being of residents and the tourism quality of the area.

### 6.1 Potential Receptors

The following potential receptors were identified (Figure 16):

1. R31 north and south bound
2. Monument on hill behind town
3. Residential area on the slopes of the hill
4. Residential area to the west
5. Residential area to the north

### 6.2 Assessment of Receptors

1. R31 north and south bound. Travelling east-west on the R31 before it turns north into Danielskuil, the traveller is slightly lower than the site and more than 6km away from the site. The Lime mine's stacks are visible but the proposed solar site is screened by the low gradient variations in the landscape.

Turning north onto the R31, the traveller becomes aware of the substation only when he is approximately 2km from the site. From this point the traveller will observe the range of infrastructure and the back of the CPV units (Figure 17).

As the traveller leaves town the site is in the distance and partially screened by landscape elements such as the sewage works (Figure 18). However as the traveller moves closer to the site the site becomes more visible and as the site is passed the traveller is within 100m of the units.

The landscape is however dominated by the lime mine as well as existing substation and HV power lines. The infill of the site with CPV units is in character with the existing land use in this area.

The overall visual impact on the road is thus medium to low but with mitigation can be reduced to low.

2. Monument on the hill behind the town (Figure 19). The view from the hill behind the town over the low lying plain on which the town, lime mine and proposed site is situated, diminish with distance. The viewer will observe the lime mine and substation with the numerous HV power lines in the distance. The solar farm will fill areas between the power lines and substation and although visible to the viewer will fit into this existing "industrial" character. Although the receptor, namely a monument is sensitive the overall impact is low due to the distance from the solar farm.

The overall visual impact on the monument is of low significance.

3. Residential area situated in the northern section of the town on the slope of the hill, facing south (Figure 21). The viewer will notice solar farm only on detail scrutiny of the distant landscape. It is however amongst other similar infrastructure and thus fits in the character.

The overall visual impact on the monument is of low significance.

4. Residential area to the north west of the site (Figure 22). The site is barely visible past landscape elements, lime mine, sewage works and substation. At restricted points the top of units may be visible in the distance, but overall the site will have no significant impact on the view from this neighbourhood.

5. Southern residential neighbourhood just north of the site (Figure 23): The residential area is slightly lower than the site. Various infrastructure e.g. the sewage works screen the



neighbourhood from the site. The top of units will be visible but will be in character with the existing infrastructure within the view window of this neighbourhood.

The overall visual impact on this residential area is of low significance.

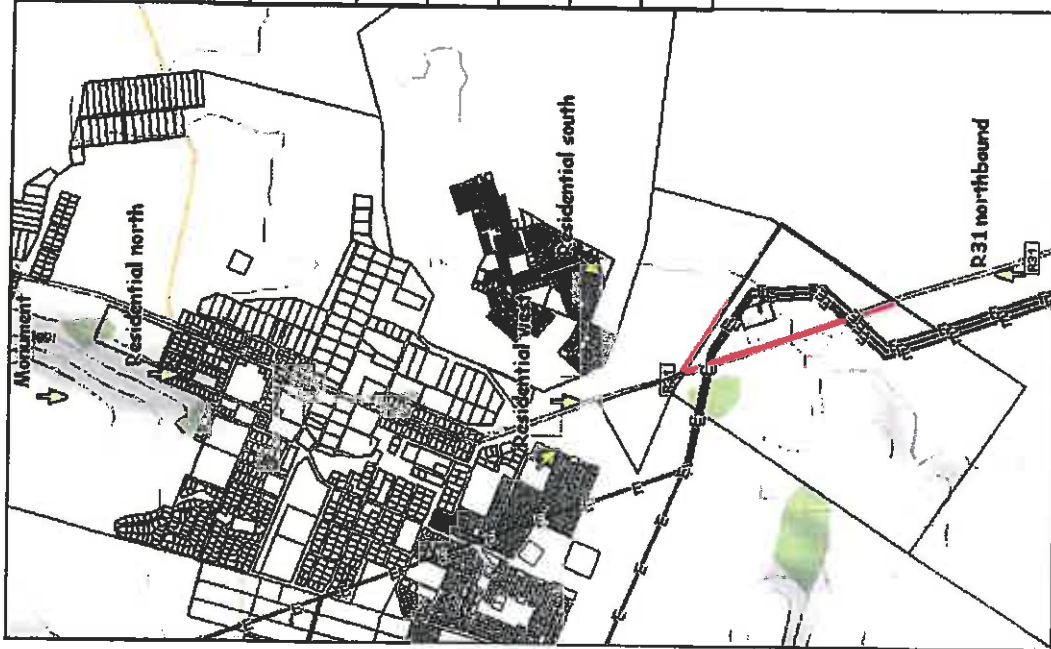

Receptor	Latitude	Longitude	Comment
Monument	28.1709	23.54861	Visible. Reduced by distance and absorbed by substation and power lines.
R31 southbound	-28.199	23.54869	Traveler looks straight into panels just after noon.
R31 northbound	28.2216	23.55699	Traveler will see back of panels. Very visible
Residential west	28.1978	23.54584	Low lying. Site screened by power lines and substation.
Residential south	28.2001	23.55644	Area on same high. Site screened by sewage works
Residential north	28.1769	23.55011	Limited view to site through houses and trees. Distance reduce visibility

Figure 16: Potential visual receptors identified

Prepared by: SC Lategan  
May 2012

VIA: Danielskui

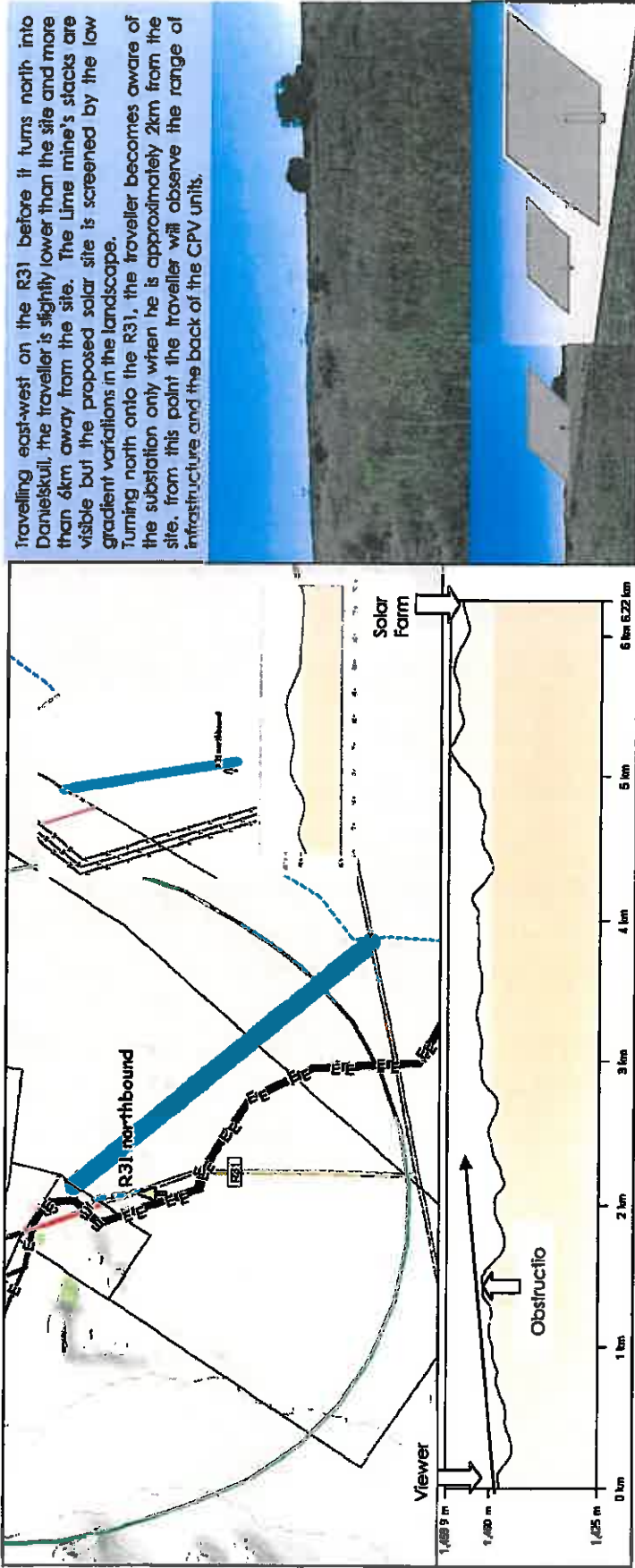

Travelling east-west on the R31 before it turns north into Danielskui, the traveller is slightly lower than the site and more than 6km away from the site. The Lime mine's stacks are visible but the proposed solar site is screened by the low gradient variations in the landscape. Turning north onto the R31, the traveller becomes aware of the substation only when he is approximately 2km from the site, from this point the traveller will observe the range of infrastructure and the back of the CPV units.

Figure 17: R31 northbound as receptor

Criteria	High	Moderate	Low
Exposure		recognizable to the viewer	not particularly noticeable to the viewer
Sensitivity	residential, nature reserves, scenic routes	sporting, recreational, places of work	industrial, mining, degraded areas
Intrusion/Obstructive	noticeable change, discordant with surroundings	Partially fits but clearly visible	minimal change or blends with surroundings

Table 3: R31 northbound assessed

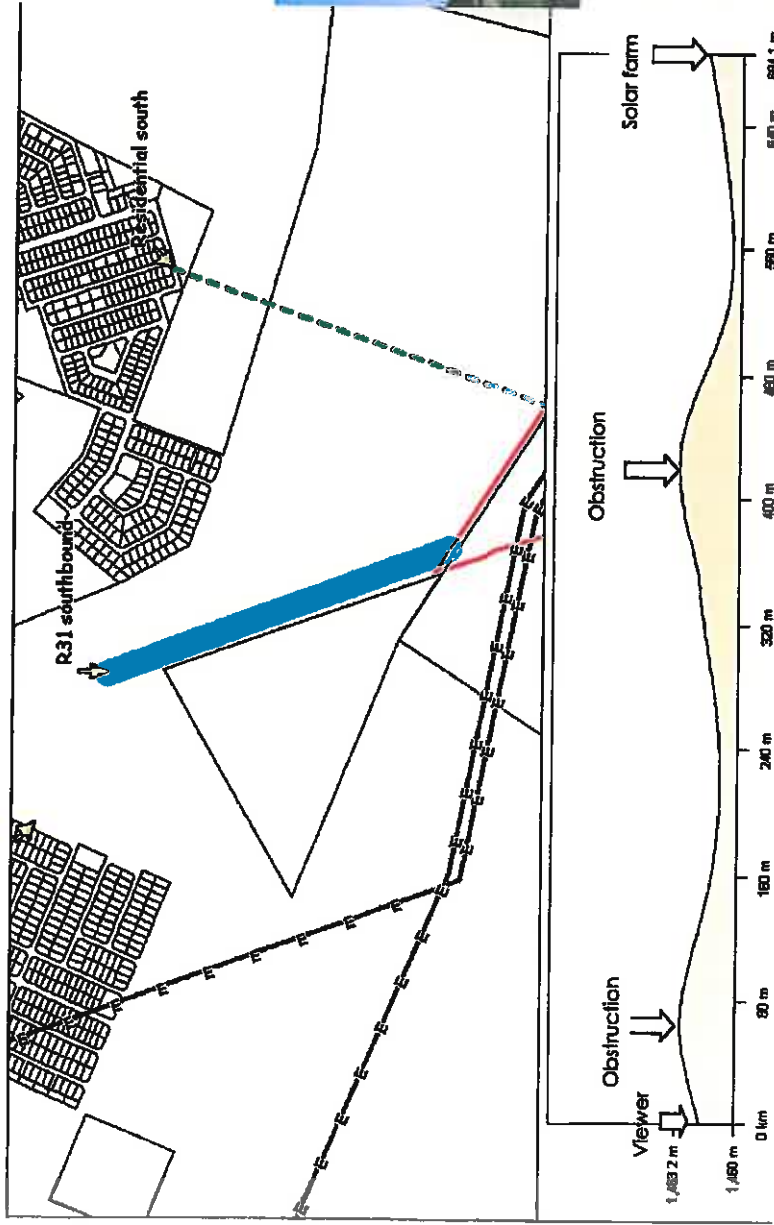

As the traveller leaves town the site is in the distance and partially screened by landscape elements such as the sewage works. However as the traveller move closer to the site the site becomes more visible and as the site is passed the travellers is within 100m of the units. The landscape is however dominated by the lime mine as well as existing substation and HV power lines. The in-fill of the site with CPV units is in character with the existing land use in this area.



When the traveller pass the site directly, the CPV units are dominant and possible glare of the panels in late afternoon may be experienced.

Figure 18: R31 southbound as receptor

Criteria	High	Moderate	Low
Exposure	300-400m CPV, R31	recognizable to the viewer	not particularly noticeable to the viewer
Sensitivity	residential, nature reserves, scenic routes	sporting, recreational, places of work	industrial, mining, degraded areas
Intrusion/Obstructive	noticeable change, discordant with surroundings	Partially fits but clearly visible	minimal change or blends with surroundings

Table 4: R31 southbound view assessed

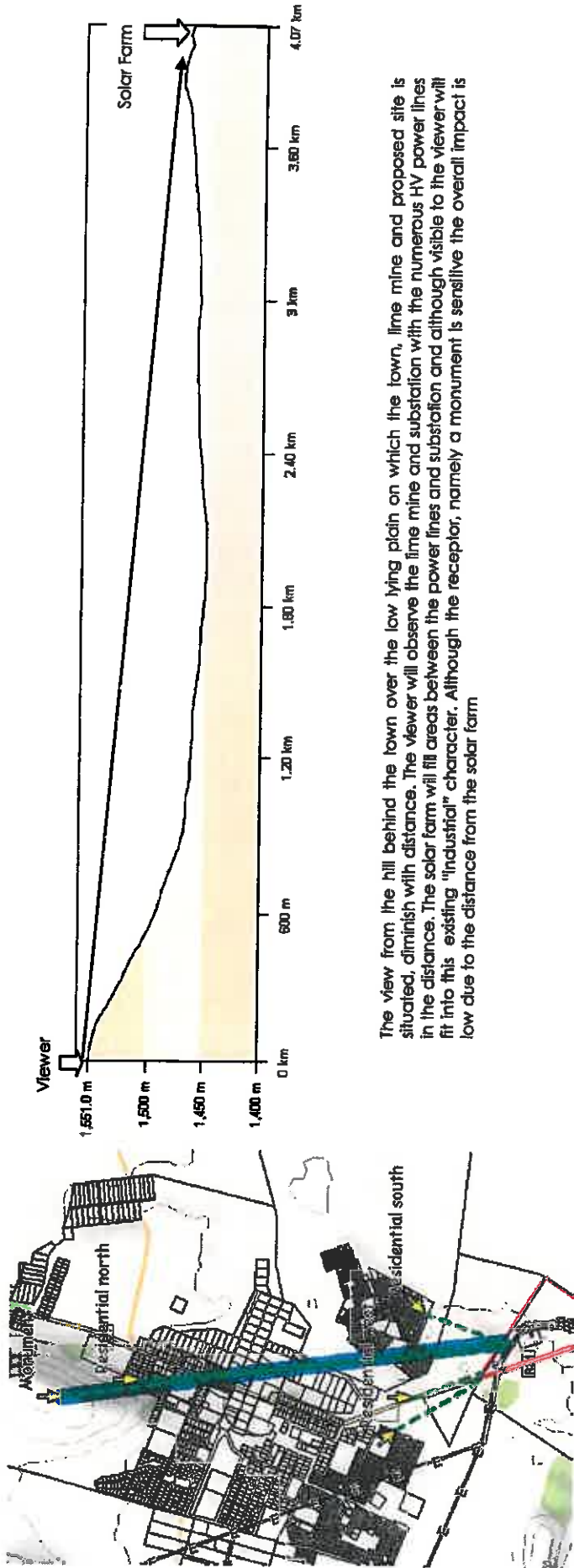

Figure 19: Monument as receptor

The view from the hill behind the town over the low lying plain on which the town, lime mine and proposed site is situated, diminish with distance. The viewer will observe the lime mine and substation with the numerous HV power lines in the distance. The solar farm will fill areas between the power lines and substation and although visible to the viewer will fit into this existing "industrial" character. Although the receptor, namely a monument is sensitive the overall impact is low due to the distance from the solar farm

Criteria	High	Moderate	Low
Exposure	dominant, clearly visible	recognizable to the viewer	not particularly noticeable to the viewer
Sensitivity	noticeable change, discordant with surroundings	sporting, recreational, places of work	industrial, mining, degraded areas
Intrusion/Obstructive	noticeable change, discordant with surroundings	Partially fits but clearly visible	minimal change or blends with surroundings

Table 5: Monument view assessed

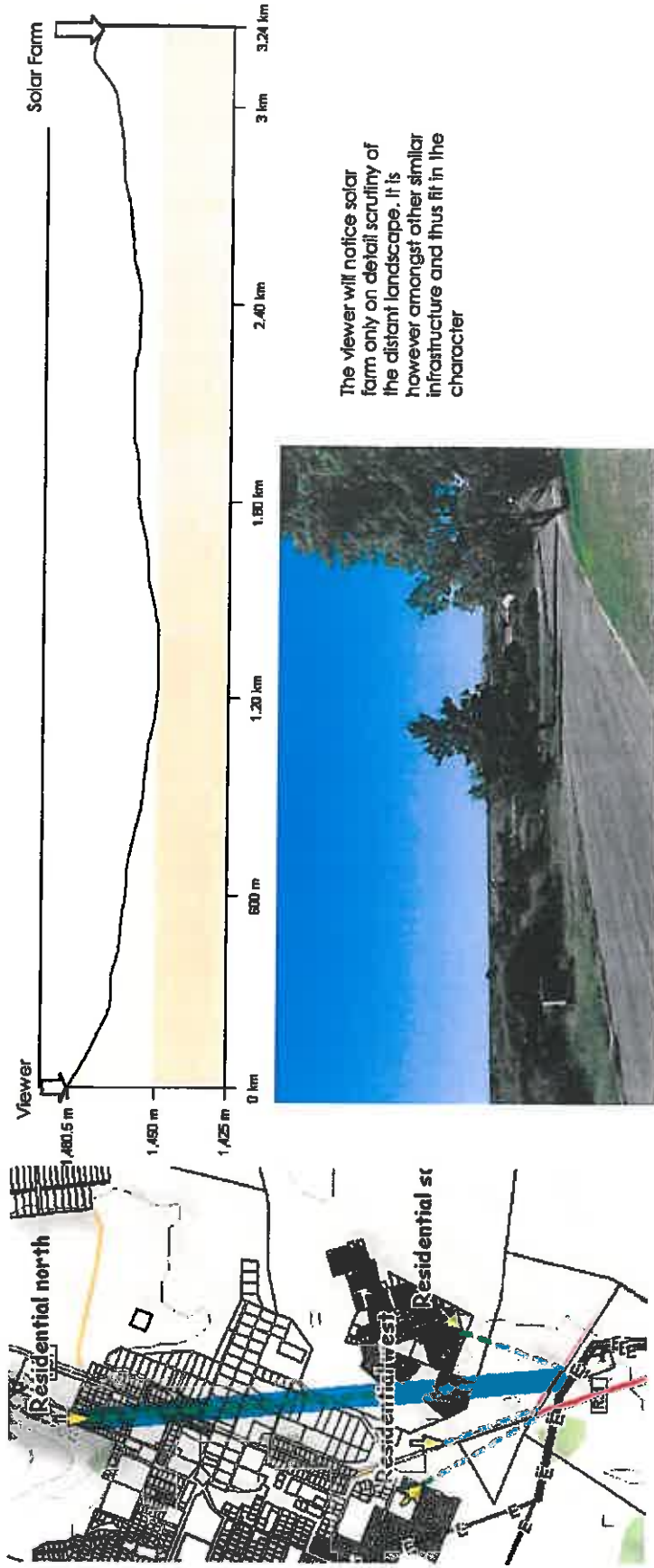

Figure 21: Residential north as receptor

Criteria	High	Moderate	Low
Exposure	dominant, clearly visible	recognizable to the viewer	not particularly noticeable to the viewer
Sensitivity	noticeable change, discordant with surroundings	sporting, recreational, places of work	Industrial, mining, degraded areas
Intrusion/Obstructive	noticeable change, discordant with surroundings	Partially fits but clearly visible	minimal change or blends with surroundings

Table 6: Neighbourhood to the north assessed



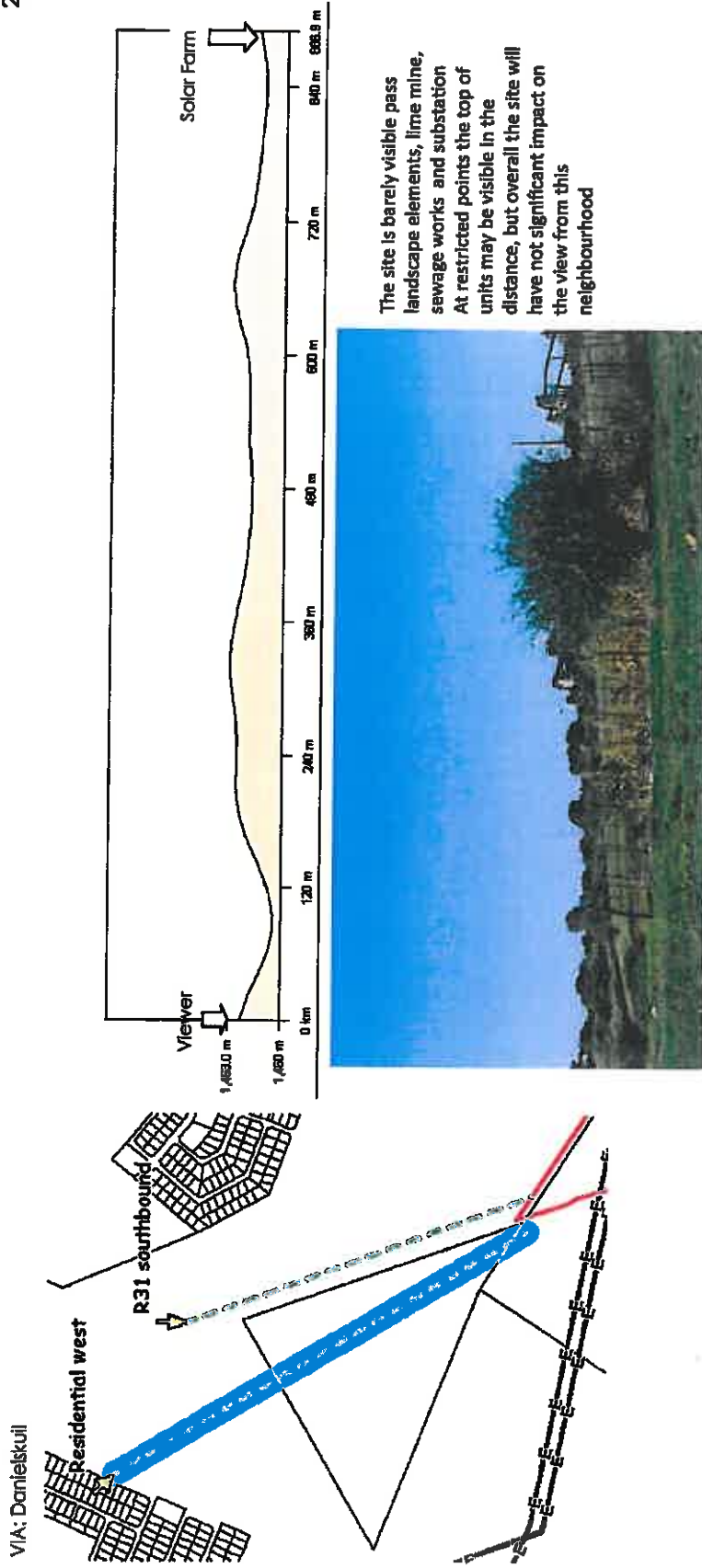

Figure 22: Residential west as receptor

Criteria	High	Moderate	Low
Exposure	dominant, clearly visible	recognizable to the viewer	not particularly noticeable to the viewer
Sensitivity	noticeable change, discordant with surroundings	sporadic, recreational, places of work	industrial, mining, degraded areas
Intrusion/Obstructive	noticeable change, discordant with surroundings	Partially fits but clearly visible	minimal change or blends with surroundings

Table 7: Residential area to the west view assessed

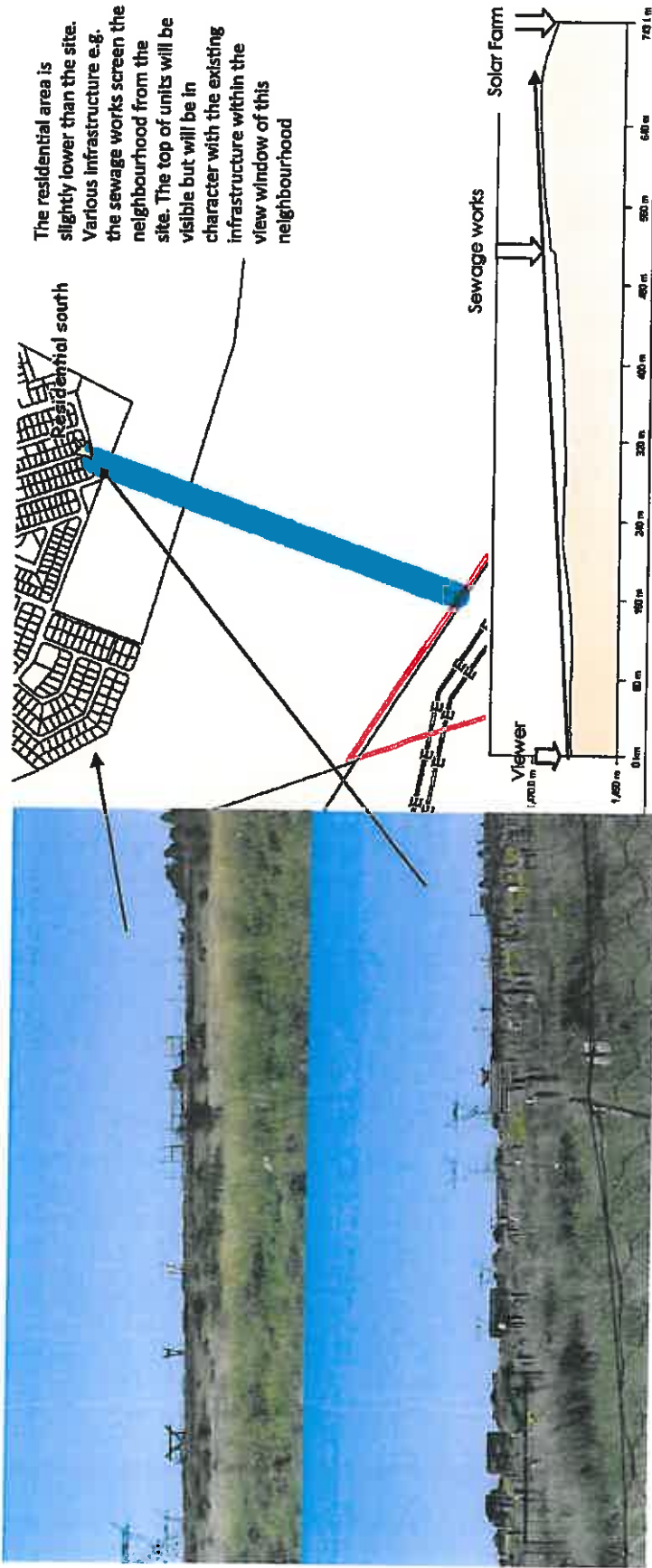

Figure 23: Residential south as receptor

Criteria	High	Moderate	Low
Exposure	dominant, clearly visible	recognizable to the viewer	not particularly noticeable to the viewer
Sensitivity	noticeable change, discordant with surroundings	sporadic, recreational, places of work	industrial, mining, degraded areas
Intrusion/Obstructive	noticeable change, discordant with surroundings	Partially fits but clearly visible	minimal change or blends with surroundings

Table 6: Residential south view assessed



Table 9: Summary of Visual Receptor assessment

Receptor	Latitude	Longitude	Comment	Exposure	Sensitivity	Intrusion/Obstructive	Finding
Monument	-28.1709	23.54861	Visible. Reduced by distance and absorbed by substation and power lines.	Distance to site and other infrastructure reduce exposure Rating: Low	Tourist facility Rating: High.	Surrounding infrastructure such as substation, HV lines, sewage works as well as lime mine with industrial type buildings reduce intrusion in landscape and will absorb the units to an acceptable level Rating: Low	Due to distance reduced intrusion. Infill of existing infrastructure implies acceptable level of change of use No significant impact
R31 southbound	-28.199	23.54869	Traveler looks straight into panels just after noon.	The units will be next to the road and very visible to the traveler. Rating high	Although the entrance to town, the lime mine is a very dominant feature and the area is characterized by this facility Rating: Low	The traveler will notice the units. Potential glare off the panels as the traveler will approach them from north. The speed limit is however 60km and thus the impact of possible flickering effect low. Rating Moderate	Although very visible infill of similar character. Glare impact low due to speed limit. Low significance
R31 northbound	-28.2216	23.55699	Traveler will see back of panels. Very visible	The units will be next to the road and very visible to the traveler. Rating: High	Although the entrance to town, the lime mine is a very dominant feature and the area is characterized by this facility Rating: Low	The traveler will notice the units, but will view from the back and therefore no glare. Rating: Moderate	Although very visible infill of similar character. Low significance
Residential west	-28.1978	23.54584	Low lying. Site screened by power lines and substation.	The site is barely visible pass landscape elements, lime mine, sewage works and substation Rating: Low	Residential always rate high regardless of type of housing. Rating: High	The area is screened to a large extent to the site by other infrastructure Rating: Low	Due to low visibility and intrusion it has an overall low significance
Residential south	-28.2001	23.55644	Area on same high. Site screened by sewage works	Partially visible but screened by other infrastructure and residential area is slightly lower than the site Rating: Moderate	Residential always rate high regardless of type of housing. Rating: High	The area is screened to a large extent to the site by other infrastructure Rating: Low	Due to low visibility and intrusion it has an overall low significance

VIA: Danielskuij

Residential north	-28.1769	23.55011	Limited view to site through houses and trees. Distance reduce visibility	The view is in the distance and fit among other similar infrastructure Rating: Moderate	Residential always rate high regardless of type of housing. Rating: High	Rating: Low	Not significant impact
-------------------	----------	----------	---------------------------------------------------------------------------	--------------------------------------------------------------------------------------------	-----------------------------------------------------------------------------	-------------	------------------------

## **7 CONSTRUCTION**

During construction, various large earth moving equipment and equipment will be transported to the site and work on the site. This will impact on the general experience of viewers. This impact is however temporary and not uncommon during construction of infrastructure. Communities have fairly high tolerance levels for such activities if it contributes to the infrastructure of the area.

Rating: Low

## **8 FINDINGS**

The site is situated in an area characterized by industrial type building, mine and utility land uses. The site has a high absorption capacity due to the presence of existing land use.

The sensitive receptors namely the monument and residential areas are situated such that the exposure to the site and the intrusion level is low, thus creating a low overall visual impact.

The less sensitive receptor namely the R31 will be more exposed to the site, but the impact is in character with the surrounding and thus of less significance.

Due to the locality of the units on the same site as the substation, the transmission lines will have very little additional impact on the current land use and thus visual appearance.

The proposal does not present an unacceptable level of change to the visual environment and therefore the development can be recommended.

## **9 MITIGATION MEASURES**

The level of visual impact is of such level that no mitigation to the proposed on-site development elements necessary, but in order to avoid any potential glare impacts of the R31 southbound, it can be considered to provide a soft screening along the road of height between 1,2 -1,8m.