

APPENDICES

SCOPING REPORT: Scoping and Environmental Impact Assessment (EIA) Process for the Proposed Development of a Solar Photovoltaic (PV) Facility (Kudu Solar Facility 2) and associated infrastructure, near De Aar, Northern Cape Province



CONTENTS

APPENDIX E.7: COPIES OF THE CONTENT OF AND PROOF OF PLACEMENT OF THE NEWSPAPER ADVERTISEMENTS FOR THE RELEASE OF THE DRAFT SCOPING REPORT	3
1. Copy of the content of the newspaper advertisement	4
2. Proof of the newspaper advertisement publishing in the Noord-Kaap Bulletin	5
3. Proof of the newspaper advertisement publishing in the Echo / Midland News	6
4. Proof of the newspaper advertisement publishing in the Bloem Nuus	7
APPENDIX E.8: CORRESPONDENCE AND PROOF OF CORRESPONDENCE SENT TO STAKEHOLDERS FOR THE DRAFT SCOPING REPORT RELEASE	8
1. Letter 2 sent via email to I&APs, Stakeholders and Organs of State: Notification of the Release of the Draft Scoping Report for a 30-day Comment Period	9
2. Email 2 sent to I&APs, Stakeholders and Organs of State on 9 December 2022	11
3. Proof of Delivery of Email 2 sent to all I&APs, Stakeholders and Organs of State on 9 December 2022	13
4. Proof of SMS Text Messages sent to I&APs, Stakeholders and Organs of State (where cellphone numbers are available) on 9 December 2022	19
5. Proof of Upload of the DSR to the CSIR Project Website	25
6. Proof of Upload of the DSR to Google Drive	26
7. Proof of Upload of the DSR to SAHRIS (Kudu Solar Facility 2)	27
8. Proof of Courier of USBs to Libraries	28
9. Follow-Up/ Reminder Email sent to all I&APs, Stakeholders, and Organs of State on 17 January 2023	28
10. Proof of Delivery of Follow Up/ Reminder Email sent to all I&APs, Stakeholders, and Organs of State on 17 January 2023	32
11. Proof of SMS Reminder Text Message sent to all I&APs, Stakeholders, and Organs of State (where cell phone numbers were available) on 17 January 2023	38
12. Personalised Reminder Email sent to key I&APs, Stakeholders and Organs of State (as determined by the DFFE) on 24 and 25 January 2023	45
13. Proof of Delivery of Personalised Reminder Email sent to key I&APs, Stakeholders and Organs of State (as determined by the DFFE) on 24 and 25 January 2023	55

APPENDICES

SCOPING REPORT: Scoping and Environmental Impact Assessment (EIA) Process for the Proposed Development of a Solar Photovoltaic (PV) Facility (Kudu Solar Facility 2) and associated infrastructure, near De Aar, Northern Cape Province

14.	Proof of SMS Communication Sent to a Renosterberg Local Municipality Councilor	58
15.	Proof of Communication Attempts with a Stakeholder Regarding the Visual Impacts of the Kudu Solar Facilities on their Farm Portion and Farmstead	59
16.	Read Receipts of All Email Communication to Stakeholders During the DSR Release Phase	63
APPENDIX E.9: PROOF OF SUBMISSION OF THE DSR AND APPLICATION FORM TO THE DFFE		69
1.	Copy of Email sent to the DFFE for Submission of the DSR and Application Form on 9 December 2022	70
2.	Proof of Upload of the DSR to the DFFE Novell S-Filer on 9 December 2022	71
APPENDIX E.10: COMMENTS RECEIVED FROM STAKEHOLDERS DURING THE 30-DAY REVIEW OF THE DSR		72
1.	Comments Received from the Department of Forestry, Fisheries and the Environment (DFFE)	73
1.1	The DFFE Directorate: Integrated Environmental Authorisation: Kudu Solar Facility 2	73
1.2	The DFFE Directorate: Biodiversity Conservation	82
1.3	The DFFE Directorate: Protected Areas Planning and Management Effectiveness	87
2.	Comments received from the Northern Cape Department of Agriculture, Environmental Affairs, Rural Development and Land Reform	89
3.	Comments received from Eskom	95
4.	Comments received from Telkom: Kudu Solar Facility 2 (Telkom Ref No. CPLT0798-22)	108
4.	Comments received from the South African Heritage Resources Agency (SAHRA)	113
5.	Comments received from General Stakeholders and I&APS	123

APPENDICES

SCOPING REPORT: Scoping and Environmental Impact Assessment (EIA) Process for the Proposed Development of a Solar Photovoltaic (PV) Facility (Kudu Solar Facility 2) and associated infrastructure, near De Aar, Northern Cape Province

APPENDIX E.7: COPIES OF THE CONTENT OF AND PROOF OF PLACEMENT OF THE NEWSPAPER ADVERTISEMENTS FOR THE RELEASE OF THE DRAFT SCOPING REPORT

App. E.7/...

APPENDICES

SCOPING REPORT: Scoping and Environmental Impact Assessment (EIA) Process for the Proposed Development of a Solar Photovoltaic (PV) Facility (Kudu Solar Facility 2) and associated infrastructure, near De Aar, Northern Cape Province

1. Copy of the content of the newspaper advertisement

NOTICE OF SCOPING AND ENVIRONMENTAL IMPACT ASSESSMENT (S&EIA) PROCESSES FOR THE PROPOSED DEVELOPMENT OF TWELVE SOLAR PHOTOVOLTAIC (PV) FACILITIES AND ASSOCIATED INFRASTRUCTURE, NEAR DE AAR IN THE NORTHERN CAPE PROVINCE

Notice is hereby given that the Project Developer, ABO Wind renewable energies (Pty) Ltd, is proposing to develop twelve Solar Photovoltaic (PV) power generation facilities and associated infrastructure, such as, but not limited to, various structures, buildings, and Battery Energy Storage Systems (BESS), near De Aar in the Northern Cape Province. These projects are referred to as Kudu Solar Facility 1 to 12 (Projects 1 to 12). The proposed projects are located within the Renosterberg Local Municipality, which falls within the Pixley Ka Seme District Municipality. The Project Applicants are Kudu Solar Facility 1 (Pty) Ltd to Kudu Solar Facility 12 (Pty) Ltd.

The proposed PV facilities and associated infrastructure (i.e. Projects 1 to 12) will be constructed on a selection of the following farm portions: Portion 0 (RE) of Farm Bas Berg 88; Portion 3 (RE) of Farm Bas Berg 88; Portion 4 of Farm Bas Berg 88; Portion 2 (RE) of Farm Grass Pan 40; Portion 0 (RE) of Farm Annex Wolve Kuil 41; Portion 1 of Farm Annex Wolve Kuil 41; Portion 2 of Farm Wolve Kuil 43; and Portion 0 (RE) of Farm Wolve Kuilen 42.

In terms of the National Environmental Management Act (Act 107 of 1998, as amended) (NEMA) and the 2014 NEMA Environmental Impact Assessment (EIA) Regulations (as amended), the proposed Kudu Solar Facilities (Projects 1 to 12) will be subject to full Scoping and EIA (S&EIA) Processes, with a 107-day decision-making timeframe. Notice of the S&EIA Processes is thus given in terms of Regulation 41 (2) (c) of the 2014 NEMA EIA Regulations (as amended).

Separate Applications for EA will be submitted to the Competent Authority, the Department of Forestry, Fisheries and the Environment (DFFE), with the Draft Scoping Reports for the Kudu Solar Facilities (Projects 1 to 12). The proposed projects trigger various listed activities in the 2014 NEMA EIA Regulations (as amended); with GN R325 Listing Notice 2: Activity 1 serving as the main activity for the Kudu Solar Facilities (Projects 1 to 12). Comment will also be sought from the South African Heritage Resources Agency (SAHRA) in terms of the National Heritage Resources Act (Act 25 of 1999). The S&EIA Processes will also confirm if a Water Use Authorisation is required in accordance with the National Water Act (Act 36 of 1998, as amended). An integrated Public Participation Process will be undertaken for all the proposed projects, as well as all applications necessary in respect of other applicable legislation.

The Council for Scientific and Industrial Research (CSIR) has been appointed as the independent Environmental Assessment Practitioner (EAP) to undertake and manage the Environmental Assessment processes for the proposed projects on behalf of the Project Applicants.

Interested and/or Affected Parties (I&APs) are hereby notified of the release of the Draft Scoping Reports for the Kudu Solar Facilities (Projects 1 to 12) for a 30-day review period, which will extend from **9 December 2022 to 30 January 2023**. This comment period excludes the regulated shutdown period. The Draft Scoping Reports can be downloaded from the following website:

<https://www.csir.co.za/environmental-impact-assessment>

Should you be interested in registering as an I&AP and to provide comments on the Draft Scoping Reports, you are kindly requested to e-mail your name, contact details, with an indication of any direct business, financial, personal or other interest which you may have in the applications, as well as comments, to the EAP at the CSIR: Rohaida Abed; E-mail: ems@csir.co.za; Postal address: P.O. Box 59081, Umbilo, Durban, 4075; Tel: 031 242 2300.

Note that the Electrical Grid Infrastructure (EGI) needed to facilitate connection of the Kudu Solar Facilities to the national grid will include 132 kV power lines, Switching Stations and Collector Stations at each Solar PV Facility (Kudu EGI Projects 13 to 24), an independent 400/132 kV Main Transmission Substation (MTS) (Kudu EGI Project 25), and a 400 kV Loop-In-Loop-Out (LILO) (Kudu EGI Project 26). Projects 13 to 26 are located within the Central Strategic Transmission Corridor that was gazetted in GN 113 in February 2018 and will therefore be subjected to separate Basic Assessment (BA) Processes and/or Registration via the Power Line and Substation Standard (Government Gazette 47095; GN 2313, dated 27 July 2022). Separate notifications will be published, when reports are available for comment (as relevant), for Projects 13 to 26.

KENNISGEWING VAN DIE BESTEKOPNAME- EN OMGEWINGS-IMPAKSTUDIESPROSESSE ("S&EIA") VIR DIE VOORGESTELDE ONTWIKKELING VAN TWAALF SON FOTOVOLTAÏESE (PV) FASILITEITE EN MEEGAANDE INFRASTRUKTUUR GELEË NABY DE AAR IN DIE NOORD-KAAP PROVINSIE

Hiermee word kennis gegee dat die Projek-Ontwikkelaar, ABO Wind renewable energies (Edms) Bpk, die ontwikkeling voorstel van twaalf Son Fotovoltaïese (PV) energie opwekkingsfasiliteite en meegaande infrastruktuur, insluitende verskeie strukture, geboue en Battery Energie Bergingsisteme ("BESS"), naby De Aar in die Noord-Kaap Provinsie. Hierdie projekte staan bekend as Kudu Son Fasiliteit 1 tot 12 (Projekte 1 tot 12). Die voorgestelde projekte is geleë in die Renosterberg Plaaslike Munisipaliteit wat val binne die Pixley Ka Seme Distriksmunisipaliteit. Die Projek-Aansoekers is Kudu Solar Facility 1 (Edms) Bpk tot Kudu Solar Facility 12 (Edms) Bpk.

Die voorgestelde Kudu Son Fasiliteite en meegaande infrastruktuur (Projekte 1 tot 12) sal ontwikkel word op 'n versameling van die volgende plaas gedeeltes: Gedeelte 0 (RES) van Plaas Bas Berg 88, Gedeelte 3 (RES) van Plaas Bas Berg 88, Gedeelte 4 (RES) van Plaas Bas Berg 88, Gedeelte 2 (RES) van Plaas Grass Pan 40, Gedeelte 0 (RES) van Plaas Annex Wolve Kuil 41, Gedeelte 1 (RES) van Plaas Annex Wolve Kuil 41, Gedeelte 2 van Plaas Wolve Kuil 43, en Gedeelte 0 (RES) van Plaas Wolve Kuilen 42.

Die voorgestelde Kudu Son Fasiliteite 1 tot 12 (Projekte 1 tot 12) is onderhewig aan 'n volle Bestekopname- en Omgewingsimpakstudieproses ("Scoping and EIA"), met 'n besluitnemingsperiode van 107 dae, in terme van die Nasionale Omgewingsbestuurswet (Wet No. 107 van 1998, soos gewysig) (NEMA) en die 2014 NEMA Omgewingsimpakstudie Regulasies (soos gewysig). Hiermee word dus kennis gegee van die S&EIA-Prosesse in terme van Regulasie 41 (2) (c) van die 2014 NEMA Omgewingsimpakstudie Regulasies (soos gewysig).

Afsonderlike aansoek vir Omgewingsgoedkeuring sal ingedien word by die beheerende owerheid, n.l. Departement van Bosbou, Visserye en die Omgewing ("DFFE"), tesame met Konsep Bestekopname Verslae vir die Kudu Son Fasiliteite 1 tot 12 (Projekte 1 tot 12). Verskeie gelyste aktiwiteite in die 2014 NEMA Omgewingsimpakstudie Regulasies (soos gewysig) is van toepassing op die voorgestelde projekte met GN R325 LN 2: Aktiwiteit 1 wat dien as die hoof aktiwiteit vir die Kudu Son Fasiliteite (Projekte 1 tot 12). Kommentaar sal ook verkry word vanaf die Suid-Afrikaanse Erfenisulphronagentskap ("SAHRA") in terme van die Wet op Nasionale Erfenisulphronne (Wet 25 van 1999). Die S&EIA Prosesse sal ook bevestig indien 'n Waterverbruikslisensie vereis word ingevolge die Nasionale Water Wet (Wet 36 van 1998, soos gewysig). 'n Geïntegreerde Publieke Deelneme Proses sal onderneem word vir die voorgestelde projekte, asook alle aansoek soos vereis ingevolge ander relevante omgewingswetgewing.

Die Wetenskaplike Nywerheids- en Navorsingsraad (WNNR) is aangestel as die onafhanklike Omgewingskonsultant ("EAP") om hierdie omgewingsimpakstudie-prosesse te behartig en te bestuur namens die Projek-Aansoekers.

Geïnteresseerde en/of Belanghebbende Partye (G&BPs) word hiermee in kennis gestel van die vrylating van die Konsep Bestekopname Verslae vir die Kudu Son Fasiliteite (Projekte 1 tot 12) vir 'n 30-dae kommentaar periode, wat sal strek vanaf **9 Desember 2022 tot 30 Januarie 2023**, uitsluitend die DFFE sluitingsperiode en publieke vakansiedae. Die Konsep Bestekopname Verslae kan afgelaai word by hierdie webtuiste: <https://www.csir.co.za/environmental-impact-assessment>

Sou u belangstel om te registreer as 'n G&BP en om kommentaar te lewer op die Konsep Bestekopname Verslae, word u vriendelik versoek om u naam en kontakbesonderhede te e-pos, asook 'n aanduiding van enige direkte, besigheids, finansiële, persoonlike of ander redes vir u moontlike belangstelling in die aansoek, aan die EAP by die WNNR: Rohaida Abed; E-pos: ems@csir.co.za; Posadres: Posbus 59081, Umbilo, Durban, 4075; Tel: 031 242 2300.

Die meegaande elektriese netwerk infrastruktuur projekte ("EGI") behels 132 kV kraglyne, ontvanger- en skakelstasies by elke Son Fasiliteit (Kudu EGI Projek 13 tot 24), 'n onafhanklike 400/132 kV hoofoordragstasie ("MTS") (Kudu EGI Projek 25), en 'n 400 kV "Loop-In-Loop-Out" ("LILO") (Kudu EGI Projek 26) ter aansluiting by die nasionale elektriese netwerk. Projekte 13 tot 26 is geleë in die Sentrale Strategiese Oordrag Korridor (Staatskennisgewing 113 in Februarie 2018) en is dus onderhewig aan 'n afsonderlike Basiese Evalueeringsproses (BA) en/of Registrasie via die Kraglyne-Substasie Standaard (Staatskoerant 47095; Staatskennisgewing 2313, gedateer 27 Julie 2022). Let daarop dat afsonderlike kennisgewings gepubliseer sal word vir Projekte 13 tot 26, sodra die verslae beskikbaar is vir kommentaar.



APPENDICES

SCOPING REPORT: Scoping and Environmental Impact Assessment (EIA) Process for the Proposed Development of a Solar Photovoltaic (PV) Facility (Kudu Solar Facility 2) and associated infrastructure, near De Aar, Northern Cape Province

2. Proof of the newspaper advertisement publishing in the Noord-Kaap Bulletin

8 NUUS NEWS

NoordkaapBulletin 8 Desember 2022

Vir jare se getrouheid erken: Sewe lede van die Kuruman-tak van die Vrouelandsbouvereniging (VLV) het onlangs herkennings as erkenning vir die jare wat hulle aan die vereniging behoort, ontvang. Met die VLV se jaar wat van 30 September tot 1 Oktober strek, het vyf lede hul mynjaar in 2022 behaal, terwyl twee dit reeds in 2021 behaal het. Diensjaarknopies is op 23 November, op die tak se jaarsluiting- en prysuitdelingsgeleentheid, aan hulle oorhandig. Van links is Tinkie Erasmus (10 jaar in 2022), Janet West (15 jaar in 2022), Marinda Stander (15 jaar in 2022), Marianne Vorster (20 jaar in 2022), Magdaleen de Klerk (35 jaar in 2022), Zeida Lombard (10 jaar in 2021) en Ansie Cilliers (15 jaar in 2021). FOTO: VERBAF



Itireleng Fire Management - doing it right the first time

**NORTHERN CAPE MINING OPERATION VACANCIES
FIRE SYSTEMS TECHNICIAN**

Qualifications and Requirements

- Grade 12
- Proof of training as Fire Technician (Sprinkler 101, Valve training, SANS 10139, SANS 14520)
- Proof of Training as a Fire Technician (In-house training, Valves, Detection & Gas Suppression)
- Medically fit to undergo Mining Operation Medical, Induction and Dover
- Computer literacy (Microsoft Windows, Outlook, Excel)
- Valid drivers licence
- No Criminal Record
- Must be residing in the John Taolo Gaetsewe District or be willing to relocate at own costs.

Experience

- Understand legal requirements and enforcement of it
- Must have on-site Fire Systems Technician experience
- Good problem solving, interpersonal and planning skills
- Experience in mining industry and understand MHSA
- Experience in Quality Management
- Experience in Fixed Fire Detection/Protection
- System Industry
- Understand SANS, ASIB, SABS, NFPA etc. standards

Closing date for applications: 31/01/2023 @ 12:00pm
Applications can be e-mailed to: bernard@itireleng.co.za (Latest Updated CV)
If you have not been contacted by the company within one week after the closing date, please consider your application to be unsuccessful.

ASIB, LAAS FIRE, FDIR, NFA, CIDB

KENNISOEWING VAN DIE BESTEKOPNAME- EN ONGEWINGS-IMPAKTSTUDIEPROSESSE (S&EIA) VIR DIE VOORGESTELDE ONTWIKKELING VAN TWAALF SON FOTVOLTAÏESE (PV) FASILITEITE EN MEEGAANDE INFRASTRUKTUUR GELEË NABY DE AAR IN DIE NOORD-KAAP PROVINSIE

Hiermee word kennis gegee dat die Projek-Ontwikkelaar, ABC Wind renewable energies (Edms) Bpk, die ontwikkeling van twaalf son Fotovoltaïese (PV) energie opwekkingfasiliteite in meegaande infrastruktuur, insluitende verskeie strukture, geboue en Batterij Energie Bergingsstelsels ("BESS"), naby De Aar in die Noord-Kaap Provinsie. Hierdie projekte staan bekend as Kudu Son Fasiliteite 1 tot 12 (Projekte 1 tot 12). Die voorgestelde projekte is geleë in die Koroanabon Plaaslike Munisipaliteit wat tot binne die Policy for Some Qualification-sphale, Die Projek-Aansoekers is Kudu Solar Facility 1 (Edms) Bpk tot Kudu Solar Facility 12 (Edms) Bpk.

Die voorgestelde Kudu Son Fasiliteite en meegaande infrastruktuur (Projekte 1 tot 12) sal ontwikkel word op 'n versameling van die volgende plase geleë: Gedeepte 0 (RES) van Plaas Bas Berg 8B, Gedeepte 3 (RES) van Plaas Bas Berg 8B, Gedeepte 4 (RES) van Plaas Bas Berg 8B, Gedeepte 2 (RES) van Plaas Grass Pan 40, Gedeepte 4 (RES) van Plaas Annex Wolwe Kull 41, Gedeepte 1 (RES) van Plaas Annex Wolwe Kull 41, Gedeepte 2 van Plaas Wolwe Kull 41, en Gedeepte 0 (RES) van Plaas Wolwe Kull 42.

Die voorgestelde Kudu Son Fasiliteite 1 tot 12 (Projekte 1 tot 12) is onderhandel aan 'n volle Bestekopname en Ongewingsimpaktopname ("Scoping and EIA"), met 'n besluitingsperiode van 107 dae, in terme van die Nasionale Ongewingsbestuur (Wet No. 107 van 1998, soos gewysig) (NEMA) en die 2014 NEMA Ongewingsimpakstudie Regulasie (soos gewysig). Hiermee word die kennis gegee van die S&EIA-prosesse in terme van Regulasie 41 (2) (b) van die 2014 NEMA Ongewingsimpakstudie Regulasie (soos gewysig).

Alsonderlike aansoek vir Ongewingsimpaktoetsing sal ingedien word by die behorende owerheid, d.i. Departement van Basiese, Vervoer en die Ontwikkeling (DITP), in terme van Konsep Bestekopname Versoek vir die Kudu Son Fasiliteite 1 tot 12 (Projekte 1 tot 12). Verskeie geleë-aktiwiteite in die 2014 NEMA Ongewingsimpakstudie-Regulasie (soos gewysig) is van toepassing op die voorgestelde projekte met GN 8225 LN 2. Aktiwiteit 1 wat dien as die hoof aktiwiteit vir die Kudu Son Fasiliteite (Projekte 1 tot 12). Kommentaar sal ook verkry word vanaf die Suid-Afrikaanse Erfenis- en Omgewings (SARHA) in terme van die Wet op Nasionale Erfenis- en Omgewings (Wet 25 van 1999). Die S&EIA-prosesse sal ook betrekke tot die Nasionale Waterwet (Wet 36 van 1998, soos gewysig). 'n Geïntegreerde Publieke Debatte-proses sal ondersoek word vir die voorgestelde projekte, asook alle aansoekers soos vermeld ingesluit onder relevante ongewingsimpaktoetsing.

Die Waterskaplike Nywerheids- en Navorsingsraad (WNNR) is aangestel as die onafhanklike Ongewingsimpaktoetsing (EAP) om hierdie ongewingsimpaktoetsing-prosesse te behartig en te bestuur namens die Projek-Aansoekers.

Geïntegreerde en/of Belanghebbende Partye (G&BPA) word hiermee in kennis gestel van die vrylating van die Konsep Bestekopname Versoek vir die Kudu Son Fasiliteite (Projekte 1 tot 12) vir 'n 30-dag kommentaar periode, wat sal strek vanaf 9 Desember 2022 tot 30 Januarie 2023, afsluitend die DIFE sluitingsperiode en publieke konsultasie. Die Konsep Bestekopname Versoek kan ophelpt word by hierdie webtuiste: <https://www.csir.co.za/environmental-impact-assessment>

Sou u belangtig om te registreer as 'n G&BPA en om kommentaar te lewer op die Konsep Bestekopname Versoek, word 'n vriendelike versoek om u naam en kontakbesonderhede te spesifiseer, asook 'n aanduiding van enige direkte, bestelbare, finansiële, persoonlike of ander redes vir u moontlike belangstelling in die aansoek, aan die EAP by die WNNR: holobude@winnr.co.za of enquiries@winnr.co.za; Foon: 0800 50811; Uskele: 0800 4075; tel: 031 242 2300.

Die meegaande elektriese netwerk infrastruktuur projekte (EGT) behels 132 kV lynreëls, onderaan en skakelkassies by alle Son Fasiliteite (Kudu EGI Projek 13 tot 24), 'n onafhanklike 400/132 kV hoofopdragstasie ("MATS") (Kudu EGI Projek 25), 'n 400 kV "topside-loop" ("TLO") (Kudu EGI Projek 26) ter oorkomring by die nasionale elektriese netwerk. Projekte 13 tot 26 is geleë in die Sentrale Strategieë Oordrag Korridor (Stratiese Oordrag 13) in Februarie 2018) en is die onderhandel aan 'n afsonderlike Basiese Evaluering-proses (BA) en/of Registrasie via die Kraglyn- en Substansie Standaard (Standaard 47095; Standaard 2313, gedeepte 27 Julie 2022). Let daarop dat afsonderlike kennisgewings gepubliseer sal word vir Projekte 13 tot 26, sodra die verskeie beskikbaar is vir kommentaar.

CSIR

Exercise holds benefits

Physical inactivity lists amongst the risks contributing to diabetes, heart disease and hypertension. To promote physical activity, a healthy lifestyle and balanced nutrition, the Northern Cape Department of Health recently hosted a campaign in Tsing in the Joe Morolong Local Municipality. At the event, MFC Maruping Lekwane took part in an aerobic session, and urged community members to engage in daily activities that exercise the body in order to stave off medical conditions and ill health. Maruping emphasized that exercise builds stronger bones, lowers blood pressure, lowers cholesterol, burns excess fat, boosts immunity, reduces cancer risk factors, increases self-esteem, improves mental sharpness, lessens depression and anxiety, and eases stress levels.

Petra Diamonds Limited is one of the world's leading suppliers of rough diamonds and one of the largest independent diamond groups by resource. It's a polished diamond we're after for this role - an individual that clearly shines his/her peers:

Draw Control Officer

Finsch Diamond Mine is located in the town of Lime Acres, which is situated 160km north-west of Kimberley and 106km south of Kuruman in the Northern Cape.

Job Reference Nr: FIN525 Job Grade: C2

ROLE DESCRIPTION: Reporting to the Specialist: Geotechnical Engineering, the role will collect and capture information on draw point conditions and draw point loading, and monitor adherence to the Draw Control Plan. Recommend corrective actions as and when required.

MINIMUM REQUIREMENTS:

- Grade 12
- A minimum of 2 years' mining experience in a Trackless Mobile Machinery Environment - PLEASE SPECIFY ON YOUR CV.
- A minimum of 2 years' underground caving experience - PLEASE CLEARLY SPECIFY ON YOUR CV.
- Knowledge of geology and ground conditions - PLEASE CLEARLY SPECIFY ON YOUR CV.
- Computer Literacy and Microsoft Office Suite.
- Valid Drivers' License.

ADVANTAGE:

- Degree in Geology/Engineering Geology/ Mining Engineering.

Finsch Diamond Mine is an equal opportunity employer. Preference will be given to suitable candidates from the designated groups in line with the Company's Employment Equity Policy and Plan and internal candidates. Pre-screening, profile testing and assessments, medical and security clearance form part of the recruitment and selection process. Short listed candidates will be required to attend a panel interview. Employment of the successful candidate is subject to the aforementioned criteria. Preference will be given to candidates who reside within our host labour sourcing area of Kgatelopele (proof of residence may be requested).

please complete an application form (available on <http://www.petradiamonds.com/careers/current-vacancies>) and forward, together with your résumé, qualifications and ID, to E1: recruitment@petradiamonds.com by 13 December 22. Please note, applications must be sent to the correct e-mail as indicated. Incomplete application forms and documentation will not be considered.

Correspondence will be limited to short-listed candidates only. Petra Diamonds reserves the right not to fill this position.

If you have not heard from us within 30 days of the closing date, please regard your application as unsuccessful.

Please note that Petra Diamonds does not at any time require any form of payment for recruitment purposes. If you are approached in this regard, you should report the incident immediately to your local SARS or via one of the following hotlines:

Toll Free: 0800 007 247; Phone Call: +27 31 571 5573; Fax: +27 31 560 7395; Email: tothelocal@tip-offs.com; Post: KZ 136, Umhlanga Rocks, 4320; Website: www.tip-offs.com

<http://www.petradiamonds.com/careers/current-vacancies>

NOTICE OF PUBLIC PARTICIPATION FOR BASIC ENVIRONMENTAL IMPACT ASSESSMENT PROCESS AND PROSPECTING RIGHT APPLICATION

Notice is hereby given in terms of Regulation 41 of the Environmental Impact Assessment Regulations 2014, made under Section 24(5) of the National Environment Management Act (Act No. 107 of 1998) and published in Government Notice No. R 983 of 2014, read together with section 16(4) of the Mineral and Petroleum Resource Development Act (Act No. 28 of 2002) as amended of intent to carry out the following activity: Proposed prospecting activity of Iron ore, Manganese ore and Diamond on the farm Eldon 456 and is assessed approximately 30,1km south west of Kuruman along the N14 route to Khathu within the jurisdiction of Gamagara Local Municipality, John Taolo Gaetsewe District of Northern Cape Province.

DMR Ref No: **NC 30/5/1/2/1319 PR**

Site Co-ordinates
S: 270 34' 14.0" E: 230 09' 33.4"
S: 270 34' 13.4" E: 230 09' 51.2"
S: 270 33' 53.6" E: 230 12' 38.9"
S: 270 36' 20.6" E: 230 12' 51.8"
S: 270 36' 52.0" E: 230 09' 22.4"

The proposed development activity falls within the categories of R 983 Activity 20 and therefore requires Basic Assessment Process. Please be informed that the Consultative Basic Assessment Report and the Environmental management programme is available for comments for 30 days excluding public holidays from the date of publication of this notice (08 December 2022 to 26 January 2023) in order to participate in the process, or to provide comments and to register as an interested and Affected Parties (I&APs) pertaining to the above-proposed development activity. To contact the consultant, TPR Mining Resources (Pty) Ltd and the applicant, Addwatt (Pty) Ltd at the details given below:

PARTICULARS OF ENVIRONMENTAL CONSULTANT	PARTICULARS OF THE APPLICANT
TPR Mining Resources (Pty) Ltd Contact: Mr. Thato Ramoraswi No:29J Wolmerde Street, Witbank 1035 Tel: 087 980 5800 Fax: 086 599 3318 Email: info@tprmining-resources.co.za	Addwatt (Pty) Ltd Contact: Mr. Ntuli Dumisane 14A Borax Street Johnsburg 1549 Cell: 072 188 4792 Tel: 011 907 3554 Email: dumisane.Ntuli@sphandle.co.za

SCOPING REPORT: Scoping and Environmental Impact Assessment (EIA) Process for the Proposed Development of a Solar Photovoltaic (PV) Facility (Kudu Solar Facility 2) and associated infrastructure, near De Aar, Northern Cape Province

3. Proof of the newspaper advertisement publishing in the Echo / Midland News

THE ECHO/MIDLAND NEWS, FRIDAY 9 DECEMBER 2022

Challenging year for wool industry

THE 2022 wool season came to a close last week with the final sale for the season. It's been a challenging but very rewarding year for the Wool industry.

A large volume of 14 837 bales were offered over the two day sale, with a very good overall sales clearance of 94.5%.

More than 60% of the offering consisted of fine micron, long length fleeces wools, with 49% of the merino wools on offer certified as sustainable.

The SA currency strengthened continuously against the major currencies over the two-day period, ultimately closing 1,3% stronger against the US\$.

The large volume offering, the strengthening of the SA currency, combined with difficult market conditions, forced the prices downward on this week's sale.

The non-RWS market indicator closed down by 6,1% on R151,64 p/kg and the RWS indicator eased by 4,4% to close on R157,85 p/kg.

The Australian market also experienced considerable downward pressure this week, closing down 2,5% (AU\$) from the previous sale, held on Wednesday, 23 November.

The major buyers on today's sale were Modano SA (4 229), Tanya SA (2 602), Standard Wool SA (2 174) and BKB Pinnacle Fibres (1 807). The next auction is scheduled for 11 January 2023.



Die papegaai met sy groen bly, goue kop en nek — wat as die heldegroen en goue juweel van die woud bekend staan — is die Kaapse papegaai (*Poicephalus robustus*) deur BirdLife Suid-Afrika as voël van die jaar vir 2023 aangekondig. Die kleurvolle voëlspesie betoer volkryers van oor die wêreld. Ten spyte van sy status as bedreigde spesie, simboliseer die papegaai hoop en veerkragtigheid omdat dit twee dekades van ontbossing steeds in Suid-Afrika oorleef. Die Kaapse papegaai is 'n mediumgrootte voël (sowat 30 cm hoog) en buiten die groen en goud, het volwasse voëls klein oranje kotte op die skouers en vere op hul pote. Die wyfies het 'n rooi kol by hul snawel, wat gewoonlik by mannetjies uitbrei. As voël van die jaar 2023 sal die Kaapse papegaai die broodnodige bewustheid bring oor die belangrikheid van hierdie ekosisteme in die verskaffing van ekologiese dienste aan gemeenskappe en die ondersteuning van 'n magdom ander unieke biosiediversiteit. (Foto: Cassie Carstens, Cape Parrot Project via BirdLife.org)

DE AAR DRUKKERS
 Telephone (053) 631-2851 Posbus 44 De Aar

VIR
SPOEDIGE DRUKWERK VAN HOË GEHALTE

MIDLAND NUUS
 POSBUS 224 CRADOCK Telephone (048) 881-5330

Kennisgewing AAN KREDITEURE

BOEDEL

In die boedel van wyle WINNIE MAGDALENE REZANT (ID Nr. 341001 0011 086) van Kanariestraat 12, Uitbreiding 7, DE AAR 7000, wie op 1 Oktober 1934 gebore is en op 30 Januarie 2021 oorlede is.

Boedel Nr. 1938/2022, Noord-Kaap.

Alle persone met vorderings teen bovermelde boedel moet dit binne 30 dae vanaf datum van publikasie hiervan by die betrokke Eksekuteur inlewer.

VENTER EN VENNEN
 Melvorstraat 24 DE AAR 7000
 Tel: (053) 631-0846
 E-pos: venter@langkloof.net

Kennisgewing AAN KREDITEURE EN DEBITEURE

BOEDEL

In die boedel van wyle PAUL BERTHOLD BIRK (ID Nr. 520807 6064 087), gebore 7 Junie 1952 en oorlede 18 Mei 2021, in lewe woonagtig te Leosingel 56, DE AAR 7000.

Boedel Nr. 2235/2021.

Kennis geskied hiermee dat die Likwidasië- en Distribusierekening in die bovermelde boedel ter insae lê by die Meesterskantoor te KIMBERLEY, asook by die Landroskantoor te DE AAR vir 'n periode van 21 dae bereken vanaf 9 Desember 2022 tot 30 Desember 2022.

DIPPENNAAR ELLIS BK
 Posbus 120 Van Riebeeckstraat 65 SPRINGBOK 8240
 Tel: (027) 718-1077

Kennisgewing

BOEDEL

In die boedel van wyle VERONIQUE LINDSAY (ID Nr. 400311 0008 083) van The Willows, HANOVER 7005. Datum van dood: 3 Junie 2022.

Boedel Nr. 002492/2022.

Skuldeisers en skuldeneers in bogenoemde boedel word hiermee versoek om hulle eise in te dien en hulle skulde te betaal aan de ondergetekende binne ntydperk van 30 (dertig) dae gereken vanaf Vrydag, 9 Desember 2022.

TRUTER & VORSTER (Namens die Eksekuteur)
 Posbus 35 DE AAR 7000

NOTICE LOST OR DESTROYED DEED

Notice is hereby given in terms of Regulation 68 of the Deeds Registries Act, 1937, of the intention to apply for the issue of a certified copy of Deed of Transfer No. T53366/1996 passed by ADRIANA JOHANNA COETZEE (BORN FOUCHE) in favour of (1) SEME HESTER BARROW & STEPHANUS BARROW (2) MARIUS FOUCHE.

In respect of certain: **ONE HALF (1/2) SHARE IN AND TO ERF 102 PETRUSVILLE SITUATED IN THE RENOSTERBERG MUNICIPALITY, DIVISION PHILIPSTOWN, NORTHERN CAPE PROVINCE** which has been lost or destroyed.

All interested persons having objection of issue of such copy are hereby required to lodge the same in writing with the Registrar of Deeds at KIMBERLEY within two weeks from the date of the publication of this notice.

Dated at KIMBERLEY on this 5th day of DECEMBER 2022.

DUNCAN & ROTHMAN
 PO Box 64 KIMBERLEY 8300
 Deeds@duncan-rothman.co.za
 Tel: No. (053) 838-4700
 Reference: STE030025LA/CVE 11203620 05

Kennisgewing GEREGTELIKE VERKOPING VAN ROEKENDE EIENDOM

In die Landros vir die distrik van PIXLEY KA SEME gehou te DE AAR. In die saak tussen SCHALD BAY (Eksekusie-skuldeiser) en MS FELICITY FILLIES (Eksekusie-skuldenaar).

Saak Nr. 322/2022.

Ten uitvoerlegging van 'n vonnis van die Landros DE AAR gedateer 23 September 2022, sal ondervermelde goedere op **19 Januarie 2023 om 15:00** per openbare veiling te **Alldedstraat 21, De Aar**, deur die BALJU, mnr P Mokwena, aan die hoogste bieder vir kontant verkoop word.

- 1 x 3 Sitplek Bruin Hout Bank
- 3 x Enkel Bruin Hout Bank
- 1 x Bruin Kabinet Staander
- 1 x Hisense Plasma TV
- 2 x Bruin Hout Klaviere
- 1 x Enkel Bruin Bank
- 1 x Wit Staal Lisserskabinet
- 1 x Bruin Ronde Tafel
- 1 x Gryns Staal Koe
- 2 x Wit Enkel Banke
- 1 x Gryns Jeep Cherokee met Registrasie Nr: CKC 031 NC

1. Die verkoopvoorwaardes sal beskikbaar wees by die Balju
2. Die voorwaardes van die verkoping sal deur die Balju aangekondig word voor die veiling 'n aanvang neem.
3. Die Koper sal aanspreeklik wees vir BTW (indien van toepassing) en die goedere sal voetstoots verkoop word.
4. Goedere word net vir kontant verkoop aan die hoogste bieder of verkoop onderhewig aan bevestiging volgens die Wet op Verbruikersbeskerming, in opdrag van die voornamskuldeiser of sy/haar prokureur.
5. Registrasie as 'n koper is 'n vereiste in terme van die volgende:
 - a. Die Wet op Verbruikersbeskerming 68 van 2008.
 - b. Fica identifikasie deur middel van identiteitsdokumente en bewys van woonadres.
 - c. Betaling van registrasiegelde;
 - d. Registrasievoorwaardes.
 - e. Registrasiekoste bedoop R500,00 (teruubetaalbaar)

Geteken te DE AAR op die 5e dag van Desember 2022.

JOSEPH EN VAN RENSBURG PROKUREURS (Prokureur vir die Eksekusie-skuldeisers)
 Kerkstraat 41 DE AAR 7000
 E-pos: joren@adsactive.com
 Tel: (053) 631-2164
 Faks: (053) 631-2703
 Verw. Lêernr: HVZ/HL2011/BIB/1207224 08

Kennisgewing BOEDEL

In die boedel van wyle CHARLES OBERHOLSTER SWANE-POEL (ID Nr. 511207 5025 088) van 3 Marsweg, DE AAR 7000. Datum van dood: 5 Junie 2022. Boedel Nr. 002056/2022.

Skuldeisers en skuldeneers in bogenoemde boedel word hiermee versoek om hulle eise in te dien en hulle skulde te betaal aan de ondergetekende binne ntydperk van 30 (dertig) dae gereken vanaf Vrydag, 9 Desember 2022.

TRUTER & VORSTER (Namens die Eksekuteur)
 Posbus 35 DE AAR 7000

WHY IS IT.....

A man wakes up in the morning after sleeping in an advertised bed, washes with an advertised soap, shaves with an advertised razor, sits down and drinks advertised tea or coffee, drives to work in an advertised car, writes with an advertised pen. Then... he refuses to advertise, says advertising doesn't pay, but when his business fails he finally advertises "BUSINESS FOR SALE"

Skenk BLOED en red 'n LEWIE!

DE AAR DRUKKERS
 Telephone (053) 631-2851 Posbus 44 De Aar

VIR
SPOEDIGE DRUKWERK VAN HOË GEHALTE

MIDLAND NUUS
 POSBUS 224 CRADOCK Telephone (048) 881-5330

NOTICE OF SCOPING AND ENVIRONMENTAL IMPACT ASSESSMENT (S&EIA) PROCESSES FOR THE PROPOSED DEVELOPMENT OF TWELVE SOLAR PHOTOVOLTAIC (PV) FACILITIES AND ASSOCIATED INFRASTRUCTURE, NEAR DE AAR IN THE NORTHERN CAPE PROVINCE

Notice is hereby given that the Project Developer, ABC Wind renewable energies (Pty) Ltd is proposing to develop twelve Solar Photovoltaic (PV) power generation facilities and associated infrastructure, such as but not limited to, various structures, buildings, ancillary Energy Storage Systems (ESS), near De Aar in the Northern Cape Province. These projects are referred to as Kudu Solar Facility 1 to 12 (Projects 1 to 12). The proposed projects are located within the Renosterburg Local Municipality, which falls within the Pixley Ka Seme District Municipality. The Project Applicants are Kudu Solar Facility 1 (Pty) Ltd to Kudu Solar Facility 12 (Pty) Ltd.

The proposed PV facilities and associated infrastructure (i.e. Projects 1 to 12) will be commenced on a selection of the following farm portions: Portion 0 (RE) of Farm Bas Berg 88; Portion 3 (RE) of Farm Bas Berg 88; Portion 4 of Farm Bas Berg 88; Portion 2 (RE) of Farm Grass Run 40; Portion 0 (RE) of Farm Annes Wolve Kull 41; Portion 1 of Farm Annes Wolve Kull 41; Portion 2 of Farm Wolve Kull 42; and Portion 0 (RE) of Farm Wolve Kull 42.

In terms of the National Environmental Management Act (Act 107 of 1998, as amended) (NEMA) and the 2014 NEMA Environmental Impact Assessment (EIA) Regulations (as amended), the proposed Kudu Solar Facilities (Projects 1 to 12) will be subject to full Scoping and S&EIA Processes, with a 107-day decision-making timeline. Notices of the S&EIA Processes is thus given in terms of Regulation 41 (2) (e) of the 2014 NEMA EIA Regulations (as amended).

Separate Applications for EA will be submitted to the Competent Authority, the Department of Forestry, Fisheries and the Environment (DFFE), with the Draft Scoping Reports for the Kudu Solar Facilities (Projects 1 to 12). The proposed projects trigger various listed activities in the 2014 NEMA EIA Regulations (as amended), with GN R253 (Listing Notice 2: Activity 1) serving as the main activity for the Kudu Solar Facilities (Projects 1 to 12). Comments will also be sought from the South African Heritage Resources Agency (SAHRA) in terms of the National Heritage Resources Act (Act 25 of 1999). The S&EIA Processes will also confirm if a Water Use Authorisation is required in accordance with the National Water Act (Act 36 of 1998), as amended. An integrated Public Participation Process will be undertaken for all the proposed projects, as well as all applications necessary in respect of other applicable legislation.

The Council for Scientific and Industrial Research (CSIR) has been appointed as the independent Environmental Assessment Practitioner (EAP) to undertake and manage the Environmental Assessment processes for the proposed projects on behalf of the Project Applicants.

Interested and/or Affected Parties (I&AP) are hereby notified of the release of the Draft Scoping Reports for the Kudu Solar Facilities (Projects 1 to 12) for a 30-day review period, which will extend from **9 December 2022 to 30 January 2023**. This comment period excludes the regulated shutdown period. The Draft Scoping Reports can be downloaded from the following website from **10 January 2023**: <https://www.csir.co.za/environmental-impact-assessment>

Should you be interested in registering as an I&AP and to provide comments on the Draft Scoping Reports, you are kindly requested to e-mail your name, contact details, with an indication of any direct business, financial, personal or other interest which you may have in the applications, as well as comments, to the EAP on the CSIR: Rohaida Abid; E-mail: ra@csir.co.za; Postal address: P.O. Box 90901, Unilever, Durban, 4009; Tel: 031 242 2300.

Note that the Electrical Grid Infrastructure (EGI) needed to facilitate connection of the Kudu Solar Facilities to the national grid will include 132 kV power lines, Switching Stations and Collector Stations at each Solar PV Facility. Kudu EGI Projects 1 to 24), an independent 400/132 kV Main Transmission Substation (MTS) (Kudu EGI Project 25), and a 400 kV Loop-Loop-Cut (LLC) (Kudu EGI Project 26). Projects 13 to 26 are located within the Central Strategic Transmission Corridor that was gazetted in GN 113 in February 2018 and will therefore be subjected to separate Basic Assessment (BA) Processes and/or Registration via the Power Line and Substation Standard (Government Gazette 47095, GN 2313, dated 27 July 2021). Separate notifications will be published, when reports are available for comment (as referred to), for Projects 13 to 26.



APPENDICES

SCOPING REPORT: Scoping and Environmental Impact Assessment (EIA) Process for the Proposed Development of a Solar Photovoltaic (PV) Facility (Kudu Solar Facility 2) and associated infrastructure, near De Aar, Northern Cape Province

4. Proof of the newspaper advertisement publishing in the Bloem Nuus

10

Donderdag 8 Desember 2022

Geklassifiseerd

BOEDELSLIKWADISIE EN DISTRIBUSIE

E. de Villiers

BOEDELSLIKWADISIE EN DISTRIBUSIE

IN DIE BOEDEL VAN WYLE: ELSIE DE VILLIERS BOEDEL NR. 5195/2022. MEESTERS-KANTOOR: BLOEMFONTEIN

IN DIE BOEDEL VAN WYLE: ELSIE DE VILLIERS BOEDEL NR. 5195/2022. MEESTERS-KANTOOR: BLOEMFONTEIN

VERN: R.J. STRAUSS/vow/MJCE1076, EDKWA LAW INC. (021) 466 6369, cstrau@edkwalaw.co.za

J.K. MOLEKO

IN THE ESTATE OF THE LATE: JEFFREY KEMOELI MOLEKO

WERNER VERMAAK ATTORNEYS No 7 WALDORF BUILDING LANGENHOVENPARK 9300

EIENDOMME

NIEMANN PROKUREURS & EIENDOMME

WOONSTEL TE HUUR

2 slk, 1 badkamer, WILLOWS, R6 500 pm

Skakel 051 411 5800 tussen kantoorure rentals@niemannattorneys.co.za

KENNISGEWING VAN DIE BESTEKOPNAME EN OMGEWINGS-IMPAKTSTUDIEPROSESSE ("SGBEA") VIR DIE VOORGESTELDE ONTWIKKELING VAN TWAALF SON FOTOVOLTAÏESE (PV) FASILITEITE EN HOOGAANDE INFRASTRUKTUR GELEë NABY DE AAR IN DIE NOORD-KAAP PROVINSIE

W.J. GERMISHUYS LIQUIDATION AND DISTRIBUTION ACCOUNTS IN DECEASED ESTATES LYING FOR INSPECTION

WELKOM YIZANI

KOM KRY JOU GELD

CSIR

Bloem organic COMPOST

ORGANIC COMPOST BARK SEEDLING MIX

LAWN DRESSING SUCCULENT MIX

GARDEN & POTTING SOIL VERMICULITE

AVAILABLE IN BAGS AND IN /M³ BULK

www.kompos.co.za

076 066 9407

VOORMALIGE AANDEELHOUERS VAN WELKOM YIZANI BELEGINGS (RF) EIENDOMS BEPERK (IN LIKWADISIE)

KOM KRY JOU GELD

Sommige voormalige aandeelhouders in Welkom Yizani het nog nie hul dividende opgeëis nie.

Prof. Rachel Jafa, Voorster van Media24 Behoerend (Edms) Bpk

As jy, of iemand wat jy ken, tussen 2006 en 2021 Welkom Yizani-aandele besit het, en nog nie al jou dividende ontvang het nie, kontak ons asseblief by:

welkomyizani@singulartservices.co.za

0860 12 12 24

Alle eise sal deur 'n proses gaan om regmatigheid daarvan te bevestig.

MEDIA24

Bereik jou teikenmark elke week, ten spyte van beurtkrag!

Gee die impak van beurtkrag 'n uitklophou!

Kontak Coleen Cilliers 083 411 1064

APPENDICES

SCOPING REPORT: Scoping and Environmental Impact Assessment (EIA) Process for the Proposed Development of a Solar Photovoltaic (PV) Facility (Kudu Solar Facility 2) and associated infrastructure, near De Aar, Northern Cape Province

APPENDIX E.8: CORRESPONDENCE AND PROOF OF CORRESPONDENCE SENT TO STAKEHOLDERS FOR THE DRAFT SCOPING REPORT RELEASE

App. E.8/...

APPENDICES

SCOPING REPORT: Scoping and Environmental Impact Assessment (EIA) Process for the Proposed Development of a Solar Photovoltaic (PV) Facility (Kudu Solar Facility 2) and associated infrastructure, near De Aar, Northern Cape Province

1. Letter 2 sent via email to I&APs, Stakeholders and Organs of State: Notification of the Release of the Draft Scoping Report for a 30-day Comment Period



CSIR Environmental Management Services

P. O. Box 59081, Umbilo, 4075
Tel: 031 242 2300
Email: ems@csir.co.za

9 December 2022

Dear Interested and Affected Party

RE: NOTIFICATION OF THE RELEASE OF 12 DRAFT SCOPING REPORTS FOR A 30-DAY COMMENT PERIOD FOR THE PROPOSED DEVELOPMENT OF 12 SOLAR PHOTOVOLTAIC (PV) FACILITIES (I.E. KUDU SOLAR FACILITIES 1 TO 12) AND ITS ASSOCIATED INFRASTRUCTURE, NEAR DE AAR, NORTHERN CAPE (DFFE REFERENCE NUMBER: TO BE ASSIGNED)

Notice is hereby given that the Project Developer, ABO Wind renewable energies (Pty) Ltd, is proposing the development of 12 Solar Photovoltaic (PV) Facilities and associated infrastructure to be located north-east of the town of De-Aar in the Northern Cape Province. The proposed projects are located within the Renosterberg Local Municipality and Pixley Ka Seme District Municipality; and they form part of a cluster of the following developments:

- **PROJECTS 1 TO 12:** The proposed development of 12 Solar PV Facilities and associated infrastructure (i.e. Kudu Solar Facility 1 to Kudu Solar Facility 12).
- **PROJECTS 13 TO 24:** The proposed development of switching stations and collector stations at each on-site substation complex at each of the 12 Kudu Solar Facilities, and up to 12 x 132 kV overhead power lines running from each Solar PV Facility to the proposed collector stations or up to the proposed Main Transmission Substation (MTS).
- **PROJECT 25:** The proposed development of an independent 400/132 kV MTS, including associated infrastructure at the MTS.
- **PROJECT 26:** The proposed development of a 400 kV Loop-In-Loop-Out (LILO) from the existing Hydra-Perseus 400 kV overhead power line to the proposed MTS.

A project Background Information Document (BID) was made available for comment in June and July 2022. At the BID stage, up to 30 projects were proposed; however, this has now reduced to a total of 28 projects, as indicated above.

The proposed Kudu Solar Facilities will comprise various infrastructure, such as a solar field, building infrastructure, an on-site substation complex, Lithium-Ion or Redox Flow Battery Energy Storage System (BESS), as well as associated infrastructure (e.g., laydown area; internal roads; fencing; storm water channels; panel maintenance and cleaning area; underground low voltage cables or cable trays; and 22 or 33 kV internal underground power lines).

Projects 1 to 12 are not located within any of the Renewable Energy Development Zones (REDZs) gazetted in Government Notice (GN) 114 on 16 February 2018; and GN 144 on 26 February 2021. Therefore, the proposed projects are subject to full Scoping and Environmental Impact Assessment (EIA) Processes and a decision-making period of 107 days, in terms of the National Environmental Management Act (Act 107 of 1998, as amended) (NEMA) and the 2014 NEMA EIA Regulations (as amended). The Scoping and EIA Processes for Projects 1 to 12 are currently being undertaken, whereas the relevant Environmental Assessment processes for Projects 13 to 28 will be undertaken at a later stage. An integrated Public Participation Process (PPP) is being undertaken for the proposed projects, as well as all applications necessary in respect of other applicable legislation.

Notice of the Scoping and EIA Processes is thus given in terms of Regulation 41 (2) (b) of the 2014 NEMA EIA Regulations (as amended). The proposed projects trigger various listed activities in terms of the 2014 NEMA EIA Regulations (as amended); with Activity 1 of Listing Notice 2 (GN R325) serving as the main activity. Refer to Chapter 4 of the Draft Scoping Reports for the detailed list of listed activities, which require authorisation and thus form part of the Scoping and EIA Processes. An Application for Environmental Authorisation (EA) for each Kudu Solar Facility project has been separately submitted to the National Department of Forestry, Fisheries, and the Environment (DFFE), as the Competent Authority, along with the Draft Scoping Reports for comment.

In line with the above, as a registered stakeholder and Interested and/or Affected Party (I&AP) on the project database, you are hereby notified of the release of the Draft Scoping Reports for the 12 proposed Kudu Solar Facility projects for a 30-day comment period, which extends from **09 December 2022 to 30 January 2023** (excluding the DFFE regulated shutdown period).

Board members: Prof. T. Majozl (Chairperson), Dr A. Childs, Dr R. Masango, Mr S. Masie,
Ms T. Mokhabuki, Dr V. Mithelwa, Mr J. Nelshitenzhe, Dr C. Render, Mr C. Shariff, Dr T. Dlamini (CEO)

www.csir.co.za

APPENDICES

SCOPING REPORT: Scoping and Environmental Impact Assessment (EIA) Process for the Proposed Development of a Solar Photovoltaic (PV) Facility (Kudu Solar Facility 2) and associated infrastructure, near De Aar, Northern Cape Province

The Draft Scoping Reports can be accessed on the project website (<https://www.csir.co.za/environmental-impact-assessment>). As a supplementary mechanism, the Draft Scoping Reports can also be downloaded from the following link on Google Drive: https://bit.ly/KUDU_SOLAR_PV

Should you wish to register as an I&AP and/or to provide comments on the Draft Scoping Reports, you are kindly requested to e-mail, fax or mail your name, contact details and project-related comments to the CSIR at the contact details provided below by **30 January 2023**:

- Attention: Rohaida Abed
- Email: ems@csir.co.za
- Postal address: P.O. Box 59081, Umbilo, Durban, 4075
- Tel: 031 242 2300

Copies of all comments received from I&APs and stakeholders during the review of the Draft Scoping Reports will be collated into the Comments and Response Reports and included as an appendix to the Final Scoping Reports and will include relevant responses to the comments. The Final Scoping Reports will be submitted to the DFFE for decision-making in line with Regulation 21(1) and Regulation 22 of the 2014 NEMA EIA Regulations (as amended).

In accordance with the Protection of Personal Information Act (Act 4 of 2013), CSIR will conduct itself responsibly when collecting, processing, storing and sharing any personal information collected for the purposes of PPP in terms of the 2014 NEMA EIA Regulations (as amended). By registering as an I&AP and/or submitting information and comments, you consent to the collection, collation, processing, and storing of such information and the use and disclosure of such information for the aforementioned purpose (<https://www.csir.co.za/csir-privacy-notice>). If you would like to opt out of communications on this project, please do so by responding to this correspondence via email.

We thank you in advance for your participation in these Scoping and EIA Processes. Should you have any queries or require additional information, please do not hesitate to contact the undersigned using the contact details provided above.

Sincerely,



Paul Lochner *Registered EAP*
EMS Manager and Project Leader
CSIR - Environmental Management Services



Rohaida Abed *Pr. Sci. Nat.*
Project Manager
CSIR - Environmental Management Services

APPENDICES

SCOPING REPORT: Scoping and Environmental Impact Assessment (EIA) Process for the Proposed Development of a Solar Photovoltaic (PV) Facility (Kudu Solar Facility 2) and associated infrastructure, near De Aar, Northern Cape Province

2. Email 2 sent to I&APs, Stakeholders and Organs of State on 9 December 2022

From: EMS
Sent: Friday, 09 December 2022 15:06
To: EMS
Subject: RE: Availability of Draft Scoping Reports for Comment - Kudu Solar PV
Attachments: Kudu Solar_Letter 2_DSR Release_General IAPs_FINAL_091222.pdf

Categories: This message has been archived by Retain on December 16 2022 20:36

Dear Stakeholders and I&APs

RE: NOTIFICATION OF THE RELEASE OF DRAFT SCOPING REPORTS FOR A 30-DAY COMMENT PERIOD FOR THE PROPOSED DEVELOPMENT OF 12 SOLAR PHOTOVOLTAIC (PV) FACILITIES (I.E. KUDU SOLAR FACILITIES) AND VARIOUS ASSOCIATED INFRASTRUCTURE, NEAR DE AAR, NORTHERN CAPE

Notice is hereby given that the Project Developer, ABO Wind renewable energies (Pty) Ltd, is proposing to develop the Kudu Solar Photovoltaic (PV) cluster, consisting of up to 12 Solar PV Facilities, associated infrastructure and Electricity Grid Infrastructure (EGI), north-east of the town of De-Aar, in the Renosterberg Local Municipality and Pixley Ka Seme District Municipality, in the Northern Cape Province. The generation capacity of each PV Facility will range from approximately 50 MWac to up to 350 MWac.

As noted below, a project Background Information Document (BID) was released for comment in June and July 2022, and at that stage a total of up to 30 projects were being proposed (i.e. 14 PV Projects and 16 EGI Projects). The number of projects has now decreased to 28 (i.e. 12 PV Projects and 14 EGI Projects).

The Solar PV Facilities (Projects 1 to 12) require Scoping and Environmental Impact Assessment (EIA) Processes. The EGI (Projects 13 to 28) will require Basic Assessment (BA) Processes or will be subjected to separate registration processes in terms of the EGI Standard (Government Gazette (GG) 47095; Government Notice (GN) 2313, dated 27 July 2022), or may require a hybrid approach depending on the sensitivities found within the EGI corridor.

The Scoping and EIA Processes for the 12 Solar PV Facilities are currently being undertaken, and the EGI projects will be considered at a later stage.

The Council for Scientific and Industrial Research (CSIR) has been appointed as the Environmental Assessment Practitioner (EAP) to undertake the required Environmental Assessments.

Separate Applications for Environmental Authorisation (EA) have been submitted to the DFFE for the proposed Solar PV Facilities. The Draft Scoping Reports for these projects are hereby released for a 30-day public comment period, which extends from **9 December 2022 to 30 January 2023** (excluding the regulated shutdown period). Refer to the attached correspondence for additional information.

The Draft Scoping Reports can be accessed as follows:

- Google Drive: https://bit.ly/KUDU_SOLAR_PV
- Project website: <https://www.csir.co.za/environmental-impact-assessment>

You are kindly requested to register your interest and submit any comments you may have on the Draft Scoping Reports to the CSIR (details are provided below and in the attached).

Please do not hesitate to contact us should you have any queries relating to the above.

APPENDICES

SCOPING REPORT: Scoping and Environmental Impact Assessment (EIA) Process for the Proposed Development of a Solar Photovoltaic (PV) Facility (Kudu Solar Facility 2) and associated infrastructure, near De Aar, Northern Cape Province

In accordance with the Protection of Personal Information Act (Act 4 of 2013), the CSIR will conduct itself responsibly when collecting, processing, storing and sharing any personal information collected for the purposes of Public Participation Processes (PPP) in terms of the 2014 NEMA EIA Regulations (as amended). By registering as an Interested and Affected Party (I&AP) and/or submitting information and comments, you consent to the collection, collation, processing, and storing of such information and the use and disclosure of such information for the aforementioned purpose (<https://www.csir.co.za/csir-privacy-notice>). If you would like to opt out of communications on this project, please do so by responding to this correspondence via email.

Kind Regards,
Rohaida Abed

CSIR Environmental Management Services
E-mail: ems@csir.co.za
Postal Address: P.O. Box 59081, Umbilo, Durban, 4075
Tel: 031 242 2300

APPENDICES

SCOPING REPORT: Scoping and Environmental Impact Assessment (EIA) Process for the Proposed Development of a Solar Photovoltaic (PV) Facility (Kudu Solar Facility 2) and associated infrastructure, near De Aar, Northern Cape Province

3. Proof of Delivery of Email 2 sent to all I&APs, Stakeholders and Organs of State on 9 December 2022									
EMS - Delivery Reports								By Date v ↑	
From	Subject	Received	Size	Categories	Mention				
v Last Month									
	Mail Delivery... Undeliverable: Availability of Draft Scoping Reports for Comment - Kud... Sat 17 Dec 2022... 31 KB This message ...	[You don't often get email from mailer-daemon@pta-smg4.csir.co.za. Learn why this is important at https://aka.ms/LearnAboutSenderIdentification] This is the mail							
	Mail Delivery... Undeliverable: Availability of Draft Scoping Reports for Comment - Kud... Wed 14 Dec 202... 34 KB This message ...	[You don't often get email from mailer-daemon@pta-smg4.csir.co.za. Learn why this is important at https://aka.ms/LearnAboutSenderIdentification] This is the mail							
	Mail Delivery... Undeliverable: Availability of Draft Scoping Reports for Comment - Kud... Wed 14 Dec 202... 41 KB This message ...	[You don't often get email from mailer-daemon@pta-smg4.csir.co.za. Learn why this is important at https://aka.ms/LearnAboutSenderIdentification] This is the mail							
	Mail Delivery... Relayed: Availability of Draft Scoping Reports for Comment - Kudu Sola... Mon 12 Dec 202... 72 KB This message ...	[You don't often get email from mailer-daemon@pta-smg4.csir.co.za. Learn why this is important at https://aka.ms/LearnAboutSenderIdentification] This is the mail							
	Mail Delivery... Undeliverable: Availability of Draft Scoping Reports for Comment - Kud... Mon 12 Dec 202... 37 KB This message ...	[You don't often get email from mailer-daemon@delivery.e-purifier.com. Learn why this is important at https://aka.ms/LearnAboutSenderIdentification]							
	Mail Delivery... Undeliverable: Availability of Draft Scoping Reports for Comment - Kud... Mon 12 Dec 202... 44 KB This message ...	[You don't often get email from mailer-daemon@pta-smg4.csir.co.za. Learn why this is important at https://aka.ms/LearnAboutSenderIdentification] This is the mail							
	Mail Delivery... Relayed: Availability of Draft Scoping Reports for Comment - Kudu Sola... Mon 12 Dec 202... 78 KB This message ...	[You don't often get email from mailer-daemon@pta-smg4.csir.co.za. Learn why this is important at https://aka.ms/LearnAboutSenderIdentification] This is the mail							
	postmaster@... Undeliverable: RE: Availability of Draft Scoping Reports for Comment - ... Mon 12 Dec 202... 246 KB This message ...	[The e-mail server of the sender could not be verified (SPF Record)]							
	Mail Delivery... Relayed: Availability of Draft Scoping Reports for Comment - Kudu Sola... Mon 12 Dec 202... 74 KB This message ...	[You don't often get email from mailer-daemon@pta-smg4.csir.co.za. Learn why this is important at https://aka.ms/LearnAboutSenderIdentification] This is the mail							
	postmaster@... Delivered: RE: Availability of Draft Scoping Reports for Comment - Kud... Mon 12 Dec 202... 129 KB This message ...	You don't often get email from postmaster@netorg6186573.onmicrosoft.com. Learn why this is important < https://aka.ms/LearnAboutSenderIdentification >							
	Microsoft Ou... Delivered: RE: Availability of Draft Scoping Reports for Comment - Kud... Mon 12 Dec 202... 165 KB This message ...	Your message has been delivered to the following recipients:							
	Microsoft Ou... Delivered: RE: Availability of Draft Scoping Reports for Comment - Kud... Mon 12 Dec 202... 164 KB This message ...	Your message has been delivered to the following recipients:							
	Microsoft Ou... Delivered: RE: Availability of Draft Scoping Reports for Comment - Kud... Mon 12 Dec 202... 164 KB This message ...	Your message has been delivered to the following recipients:							

APPENDICES

SCOPING REPORT: Scoping and Environmental Impact Assessment (EIA) Process for the Proposed Development of a Solar Photovoltaic (PV) Facility (Kudu Solar Facility 2) and associated infrastructure, near De Aar, Northern Cape Province

EMS - Delivery Reports										By Date v ↑	
	From	Subject	Received v	Size	Categories	Mention					
	postmaster@...	Delivery delayed:RE: Availability of Draft Scoping Reports for Comment... [The e-mail server of the sender could not be verified (SPF Record)]	Sat 10 Dec 2022...	85 KB			This message ...				
	postmaster@...	Delivered: RE: Availability of Draft Scoping Reports for Comment - Kud... You don't often get email from postmaster@outlook.com. Learn why this is important < https://aka.ms/LearnAboutSenderIdentification >	Sat 10 Dec 2022...	131 KB			This message ...				
	postmaster@...	Delivered: RE: Availability of Draft Scoping Reports for Comment - Kud... You don't often get email from postmaster@outlook.com. Learn why this is important < https://aka.ms/LearnAboutSenderIdentification >	Sat 10 Dec 2022...	126 KB			This message ...				
	Mail Delivery...	Undeliverable: Availability of Draft Scoping Reports for Comment - Kud... [You don't often get email from mailer-daemon@pta-smg4.csir.co.za. Learn why this is important at https://aka.ms/LearnAboutSenderIdentification] This is the mail	Fri 09 Dec 2022 ...	31 KB			This message ...				
	Mail Delivery...	Relayed: Availability of Draft Scoping Reports for Comment - Kudu Sola... [You don't often get email from mailer-daemon@pta-smg4.csir.co.za. Learn why this is important at https://aka.ms/LearnAboutSenderIdentification] This is the mail	Fri 09 Dec 2022 ...	67 KB			This message ...				
	postmaster@...	Delivered: RE: Availability of Draft Scoping Reports for Comment - Kud... Your message has been delivered to the following recipients:	Fri 09 Dec 2022 ...	132 KB			This message ...				
	postmaster@...	Delivered: RE: Availability of Draft Scoping Reports for Comment - Kud... You don't often get email from postmaster@weathersa.co.za. Learn why this is important < https://aka.ms/LearnAboutSenderIdentification >	Fri 09 Dec 2022 ...	130 KB			This message ...				
	postmaster@...	Delivered: RE: Availability of Draft Scoping Reports for Comment - Kud... You don't often get email from postmaster@weathersa.co.za. Learn why this is important < https://aka.ms/LearnAboutSenderIdentification >	Fri 09 Dec 2022 ...	130 KB			This message ...				
	postmaster@...	Delivered: RE: Availability of Draft Scoping Reports for Comment - Kud... You don't often get email from postmaster@weathersa.co.za. Learn why this is important < https://aka.ms/LearnAboutSenderIdentification >	Fri 09 Dec 2022 ...	130 KB			This message ...				
	postmaster@...	Delivered: RE: Availability of Draft Scoping Reports for Comment - Kud... You don't often get email from postmaster@g7energies.com. Learn why this is important < https://aka.ms/LearnAboutSenderIdentification >	Fri 09 Dec 2022 ...	137 KB			This message ...				
	postmaster@...	Delivered: RE: Availability of Draft Scoping Reports for Comment - Kud... You don't often get email from postmaster@dws.gov.za. Learn why this is important < https://aka.ms/LearnAboutSenderIdentification >	Fri 09 Dec 2022 ...	136 KB			This message ...				
	postmaster@...	Delivered: RE: Availability of Draft Scoping Reports for Comment - Kud... You don't often get email from postmaster@dws.gov.za. Learn why this is important < https://aka.ms/LearnAboutSenderIdentification >	Fri 09 Dec 2022 ...	136 KB			This message ...				
	postmaster@...	Delivered: RE: Availability of Draft Scoping Reports for Comment - Kud... You don't often get email from postmaster@dws.gov.za. Learn why this is important < https://aka.ms/LearnAboutSenderIdentification >	Fri 09 Dec 2022 ...	136 KB			This message ...				

APPENDICES

SCOPING REPORT: Scoping and Environmental Impact Assessment (EIA) Process for the Proposed Development of a Solar Photovoltaic (PV) Facility (Kudu Solar Facility 2) and associated infrastructure, near De Aar, Northern Cape Province

EMS - Delivery Reports										By Date v ↑	
📧	!	🔔	📄	🗑️	From	Subject	Received ▼	Size	Categories	Mention	🔍
					postmaster@...	Delivered: RE: Availability of Draft Scoping Reports for Comment - Kud... You don't often get email from postmaster@dws.gov.za. Learn why this is important <https://aka.ms/LearnAboutSenderIdentification>	Fri 09 Dec 2022 ...	136 KB			This message ...
					postmaster@...	Delivered: RE: Availability of Draft Scoping Reports for Comment - Kud... You don't often get email from postmaster@r-n.co.za. Learn why this is important <https://aka.ms/LearnAboutSenderIdentification>	Fri 09 Dec 2022 ...	132 KB			This message ...
					postmaster@...	Delivered: RE: Availability of Draft Scoping Reports for Comment - Kud... You don't often get email from postmaster@dws.gov.za. Learn why this is important <https://aka.ms/LearnAboutSenderIdentification>	Fri 09 Dec 2022 ...	136 KB			This message ...
					postmaster@...	Delivered: RE: Availability of Draft Scoping Reports for Comment - Kud... You don't often get email from postmaster@g7energies.com. Learn why this is important <https://aka.ms/LearnAboutSenderIdentification>	Fri 09 Dec 2022 ...	137 KB			This message ...
					postmaster@...	Delivered: RE: Availability of Draft Scoping Reports for Comment - Kud... You don't often get email from postmaster@g7energies.com. Learn why this is important <https://aka.ms/LearnAboutSenderIdentification>	Fri 09 Dec 2022 ...	137 KB			This message ...
					postmaster@...	Delivered: RE: Availability of Draft Scoping Reports for Comment - Kud... You don't often get email from postmaster@g7energies.com. Learn why this is important <https://aka.ms/LearnAboutSenderIdentification>	Fri 09 Dec 2022 ...	137 KB			This message ...
					postmaster@...	Delivered: RE: Availability of Draft Scoping Reports for Comment - Kud... You don't often get email from postmaster@g7energies.com. Learn why this is important <https://aka.ms/LearnAboutSenderIdentification>	Fri 09 Dec 2022 ...	137 KB			This message ...
					postmaster@...	Delivered: RE: Availability of Draft Scoping Reports for Comment - Kud... You don't often get email from postmaster@g7energies.com. Learn why this is important <https://aka.ms/LearnAboutSenderIdentification>	Fri 09 Dec 2022 ...	137 KB			This message ...
					postmaster@...	Delivered: RE: Availability of Draft Scoping Reports for Comment - Kud... You don't often get email from postmaster@g7energies.com. Learn why this is important <https://aka.ms/LearnAboutSenderIdentification>	Fri 09 Dec 2022 ...	137 KB			This message ...
					postmaster@...	Delivered: RE: Availability of Draft Scoping Reports for Comment - Kud... You don't often get email from postmaster@g7energies.com. Learn why this is important <https://aka.ms/LearnAboutSenderIdentification>	Fri 09 Dec 2022 ...	137 KB			This message ...
					postmaster@...	Delivered: RE: Availability of Draft Scoping Reports for Comment - Kud... You don't often get email from postmaster@g7energies.com. Learn why this is important <https://aka.ms/LearnAboutSenderIdentification>	Fri 09 Dec 2022 ...	137 KB			This message ...
					postmaster@...	Delivered: RE: Availability of Draft Scoping Reports for Comment - Kud... You don't often get email from postmaster@g7energies.com. Learn why this is important <https://aka.ms/LearnAboutSenderIdentification>	Fri 09 Dec 2022 ...	137 KB			This message ...

APPENDICES

SCOPING REPORT: Scoping and Environmental Impact Assessment (EIA) Process for the Proposed Development of a Solar Photovoltaic (PV) Facility (Kudu Solar Facility 2) and associated infrastructure, near De Aar, Northern Cape Province

EMS - Delivery Reports										By Date ▾ ↑	
					From	Subject	Received ▾	Size	Categories	Mention	
					postmaster@...	Delivered: RE: Availability of Draft Scoping Reports for Comment - Kud...	Fri 09 Dec 2022 ...	137 KB			This message ...
You don't often get email from postmaster@g7energies.com. Learn why this is important <https://aka.ms/LearnAboutSenderIdentification>											
					postmaster@...	Delivered: RE: Availability of Draft Scoping Reports for Comment - Kud...	Fri 09 Dec 2022 ...	132 KB			This message ...
You don't often get email from postmaster@corp.akuoenergy.com. Learn why this is important <https://aka.ms/LearnAboutSenderIdentification>											
					postmaster@...	Undeliverable: RE: Availability of Draft Scoping Reports for Comment - ...	Fri 09 Dec 2022 ...	244 KB			This message ...
[The e-mail server of the sender could not be verified (SPF Record)]											
					Mail Delivery...	Undeliverable: Availability of Draft Scoping Reports for Comment - Kud...	Fri 09 Dec 2022 ...	36 KB			This message ...
[You don't often get email from mailer-daemon@obr1.gov.za. Learn why this is important at https://aka.ms/LearnAboutSenderIdentification]											
					Mail Delivery...	Delivered: Availability of Draft Scoping Reports for Comment - Kudu So...	Fri 09 Dec 2022 ...	78 KB			This message ...
[You don't often get email from mailer-daemon@server.itdesign.co.za. Learn why this is important at https://aka.ms/LearnAboutSenderIdentification] This message											
					postmaster@...	Undeliverable: RE: Availability of Draft Scoping Reports for Comment - ...	Fri 09 Dec 2022 ...	246 KB			This message ...
You don't often get email from postmaster@transnet.net. Learn why this is important <https://aka.ms/LearnAboutSenderIdentification>											
					Mail Delivery...	Undeliverable: Availability of Draft Scoping Reports for Comment - Kud...	Fri 09 Dec 2022 ...	44 KB			This message ...
[You don't often get email from mailer-daemon@pta-smg4.csir.co.za. Learn why this is important at https://aka.ms/LearnAboutSenderIdentification] This is the mail											
					Mail Delivery...	Relayed: Availability of Draft Scoping Reports for Comment - Kudu Sola...	Fri 09 Dec 2022 ...	88 KB			This message ...
[You don't often get email from mailer-daemon@pta-smg4.csir.co.za. Learn why this is important at https://aka.ms/LearnAboutSenderIdentification] This is the mail											
					Mail Delivery...	Undeliverable: Availability of Draft Scoping Reports for Comment - Kud...	Fri 09 Dec 2022 ...	38 KB			This message ...
[You don't often get email from mailer-daemon@pta-smg4.csir.co.za. Learn why this is important at https://aka.ms/LearnAboutSenderIdentification] This is the mail											
					Mail Delivery...	Relayed: Availability of Draft Scoping Reports for Comment - Kudu Sola...	Fri 09 Dec 2022 ...	118 KB			This message ...
[You don't often get email from mailer-daemon@pta-smg4.csir.co.za. Learn why this is important at https://aka.ms/LearnAboutSenderIdentification] This is the mail											
					Mail Delivery...	Relayed: Availability of Draft Scoping Reports for Comment - Kudu Sola...	Fri 09 Dec 2022 ...	114 KB			This message ...
[You don't often get email from mailer-daemon@pta-smg4.csir.co.za. Learn why this is important at https://aka.ms/LearnAboutSenderIdentification] This is the mail											
					Mail Delivery...	Undeliverable: Availability of Draft Scoping Reports for Comment - Kud...	Fri 09 Dec 2022 ...	42 KB			This message ...
[You don't often get email from mailer-daemon@pta-smg4.csir.co.za. Learn why this is important at https://aka.ms/LearnAboutSenderIdentification] This is the mail											
					Mail Delivery...	Relayed: Availability of Draft Scoping Reports for Comment - Kudu Sola...	Fri 09 Dec 2022 ...	118 KB			This message ...
[You don't often get email from mailer-daemon@pta-smg4.csir.co.za. Learn why this is important at https://aka.ms/LearnAboutSenderIdentification] This is the mail											

APPENDICES

SCOPING REPORT: Scoping and Environmental Impact Assessment (EIA) Process for the Proposed Development of a Solar Photovoltaic (PV) Facility (Kudu Solar Facility 2) and associated infrastructure, near De Aar, Northern Cape Province

EMS - Delivery Reports										By Date ▾ ↑
					From	Subject	Received ▾	Size	Categories	Mention
						Mail Delivery... Undeliverable: Availability of Draft Scoping Reports for Comment - Kud... Fri 09 Dec 2022 ... 44 KB This message ... [You don't often get email from mailer-daemon@pta-smg4.csir.co.za. Learn why this is important at https://aka.ms/LearnAboutSenderIdentification] This is the mail				
					postmaster@...	Delivered: RE: Availability of Draft Scoping Reports for Comment - Kud... Fri 09 Dec 2022 ... 129 KB This message ... You don't often get email from postmaster@birdlife.org.za. Learn why this is important < https://aka.ms/LearnAboutSenderIdentification >				
						Mail Delivery... Delivered: Availability of Draft Scoping Reports for Comment - Kudu So... Fri 09 Dec 2022 ... 82 KB This message ... [You don't often get email from mailer-daemon@mr28p00im-smtpin021.me.com. Learn why this is important at https://aka.ms/LearnAboutSenderIdentification]				
					postmaster@...	Delivered: RE: Availability of Draft Scoping Reports for Comment - Kud... Fri 09 Dec 2022 ... 127 KB This message ... You don't often get email from postmaster@outlook.com. Learn why this is important < https://aka.ms/LearnAboutSenderIdentification >				
					postmaster@...	Delivered: RE: Availability of Draft Scoping Reports for Comment - Kud... Fri 09 Dec 2022 ... 129 KB This message ... You don't often get email from postmaster@birdlife.org.za. Learn why this is important < https://aka.ms/LearnAboutSenderIdentification >				
					postmaster@...	Delivered: RE: Availability of Draft Scoping Reports for Comment - Kud... Fri 09 Dec 2022 ... 127 KB This message ... You don't often get email from postmaster@outlook.com. Learn why this is important < https://aka.ms/LearnAboutSenderIdentification >				
					postmaster@...	Delivered: RE: Availability of Draft Scoping Reports for Comment - Kud... Fri 09 Dec 2022 ... 129 KB This message ... You don't often get email from postmaster@wessa.co.za. Learn why this is important < https://aka.ms/LearnAboutSenderIdentification >				
					postmaster@...	Delivered: RE: Availability of Draft Scoping Reports for Comment - Kud... Fri 09 Dec 2022 ... 127 KB This message ... You don't often get email from postmaster@netorg7356748.onmicrosoft.com. Learn why this is important < https://aka.ms/LearnAboutSenderIdentification >				
					postmaster@...	Delivered: RE: Availability of Draft Scoping Reports for Comment - Kud... Fri 09 Dec 2022 ... 129 KB This message ... You don't often get email from postmaster@birdlife.org.za. Learn why this is important < https://aka.ms/LearnAboutSenderIdentification >				
					postmaster@...	Delivered: RE: Availability of Draft Scoping Reports for Comment - Kud... Fri 09 Dec 2022 ... 125 KB This message ... You don't often get email from postmaster@nocci.co.za. Learn why this is important < https://aka.ms/LearnAboutSenderIdentification >				
					postmaster@...	Delivered: RE: Availability of Draft Scoping Reports for Comment - Kud... Fri 09 Dec 2022 ... 128 KB This message ... You don't often get email from postmaster@mulilo.com. Learn why this is important < https://aka.ms/LearnAboutSenderIdentification >				
						Mail Delivery... Relayed: Availability of Draft Scoping Reports for Comment - Kudu Sola... Fri 09 Dec 2022 ... 77 KB This message ... [You don't often get email from mailer-daemon@hostserv.co.za. Learn why this is important at https://aka.ms/LearnAboutSenderIdentification]				
						Mail Delivery... Relayed: Availability of Draft Scoping Reports for Comment - Kudu Sola... Fri 09 Dec 2022 ... 75 KB This message ... [You don't often get email from mailer-daemon@hostserv.co.za. Learn why this is important at https://aka.ms/LearnAboutSenderIdentification]				

APPENDICES

SCOPING REPORT: Scoping and Environmental Impact Assessment (EIA) Process for the Proposed Development of a Solar Photovoltaic (PV) Facility (Kudu Solar Facility 2) and associated infrastructure, near De Aar, Northern Cape Province

EMS - Delivery Reports						By Date ▾ ↑					
					From	Subject	Received ▾	Size	Categories	Mention	
					postmaster@...	Delivered: RE: Availability of Draft Scoping Reports for Comment - Kud... You don't often get email from postmaster@birdlife.org.za. Learn why this is important <https://aka.ms/LearnAboutSenderIdentification>	Fri 09 Dec 2022 ...	129 KB			This message ...
					postmaster@...	Delivered: RE: Availability of Draft Scoping Reports for Comment - Kud... You don't often get email from postmaster@nocci.co.za. Learn why this is important <https://aka.ms/LearnAboutSenderIdentification>	Fri 09 Dec 2022 ...	125 KB			This message ...
					postmaster@...	Delivered: RE: Availability of Draft Scoping Reports for Comment - Kud... You don't often get email from postmaster@mulilo.com. Learn why this is important <https://aka.ms/LearnAboutSenderIdentification>	Fri 09 Dec 2022 ...	128 KB			This message ...
					Mail Delivery...	Relayed: Availability of Draft Scoping Reports for Comment - Kudu Sola... [You don't often get email from mailer-daemon@hostserv.co.za. Learn why this is important at https://aka.ms/LearnAboutSenderIdentification]	Fri 09 Dec 2022 ...	77 KB			This message ...
					Mail Delivery...	Relayed: Availability of Draft Scoping Reports for Comment - Kudu Sola... [You don't often get email from mailer-daemon@hostserv.co.za. Learn why this is important at https://aka.ms/LearnAboutSenderIdentification]	Fri 09 Dec 2022 ...	75 KB			This message ...
					Mail Delivery...	Relayed: Availability of Draft Scoping Reports for Comment - Kudu Sola... [You don't often get email from mailer-daemon@mailgate.saa.ac.za. Learn why this is important at https://aka.ms/LearnAboutSenderIdentification]	Fri 09 Dec 2022 ...	75 KB			This message ...
					Mail Delivery...	Relayed: Availability of Draft Scoping Reports for Comment - Kudu Sola... [You don't often get email from mailer-daemon@pta-smg4.csir.co.za. Learn why this is important at https://aka.ms/LearnAboutSenderIdentification] This is the mail	Fri 09 Dec 2022 ...	67 KB			This message ...
					Mail Delivery...	Relayed: Availability of Draft Scoping Reports for Comment - Kudu Sola... [You don't often get email from mailer-daemon@pta-smg4.csir.co.za. Learn why this is important at https://aka.ms/LearnAboutSenderIdentification] This is the mail	Fri 09 Dec 2022 ...	67 KB			This message ...
					Microsoft Ou...	Delivered: RE: Availability of Draft Scoping Reports for Comment - Kud... Your message has been delivered to the following recipients:	Fri 09 Dec 2022 ...	159 KB			This message ...
					Microsoft Ou...	Delivered: RE: Availability of Draft Scoping Reports for Comment - Kud... Your message has been delivered to the following recipients:	Fri 09 Dec 2022 ...	159 KB			This message ...
					Microsoft Ou...	Delivered: RE: Availability of Draft Scoping Reports for Comment - Kud... Your message has been delivered to the following recipients:	Fri 09 Dec 2022 ...	158 KB			This message ...
					Microsoft Ou...	Delivered: RE: Availability of Draft Scoping Reports for Comment - Kud... Your message has been delivered to the following recipients:	Fri 09 Dec 2022 ...	158 KB			This message ...

APPENDICES

SCOPING REPORT: Scoping and Environmental Impact Assessment (EIA) Process for the Proposed Development of a Solar Photovoltaic (PV) Facility (Kudu Solar Facility 2) and associated infrastructure, near De Aar, Northern Cape Province

4. Proof of SMS Text Messages sent to I&APs, Stakeholders and Organs of State (where cellphone numbers are available) on 9 December 2022

Copy of text included in the SMS: Dear Stakeholder, Draft Scoping Reports for the proposed Kudu Solar Facilities 1-12 near De Aar, NC are available for comment until 30 Jan 2023. Visit https://bit.ly/KUDU_SOLAR_PV or https://bit.ly/CSIR_EIA to access the reports. To send comments, queries or to opt out of future communication on these projects, email ems@csir.co.za. Regards, CSIR EMS Team (https://bit.ly/CSIR_privacy)

created_time	msisdn	status	status_text	origin_address	delivered_time	batch_id
2022-12-09 15:11:55.0	[REDACTED]	11	Delivered to phone	[REDACTED]	2022-12-09 15:11:00.0	1608184918
2022-12-09 15:11:55.0	[REDACTED]	11	Delivered to phone	[REDACTED]	2022-12-09 15:11:00.0	1608184918
2022-12-09 15:11:55.0	[REDACTED]	11	Delivered to phone	[REDACTED]	2022-12-09 15:12:00.0	1608184918
2022-12-09 15:11:55.0	[REDACTED]	11	Delivered to phone	[REDACTED]	2022-12-09 15:11:00.0	1608184918
2022-12-09 15:11:55.0	[REDACTED]	11	Delivered to phone	[REDACTED]	2022-12-09 15:12:00.0	1608184918
2022-12-09 15:11:55.0	[REDACTED]	11	Delivered to phone	[REDACTED]	2022-12-09 15:11:00.0	1608184918
2022-12-09 15:11:55.0	[REDACTED]	11	Delivered to phone	[REDACTED]	2022-12-11 14:42:00.0	1608184918
2022-12-09 15:11:55.0	[REDACTED]	50	Failed	[REDACTED]	2022-12-11 15:40:00.0	1608184918
2022-12-09 15:11:55.0	[REDACTED]	50	Failed	[REDACTED]	2022-12-11 15:40:00.0	1608184918
2022-12-09 15:11:55.0	[REDACTED]	50	Failed	[REDACTED]	2022-12-09 15:11:00.0	1608184918
2022-12-09 15:11:55.0	[REDACTED]	50	Failed	[REDACTED]	2022-12-09 15:11:00.0	1608184918
2022-12-09 15:11:55.0	[REDACTED]	50	Failed	[REDACTED]	2022-12-09 15:11:00.0	1608184918
2022-12-09 15:11:55.0	[REDACTED]	11	Delivered to phone	[REDACTED]	2022-12-09 15:11:00.0	1608184918
2022-12-09 15:11:55.0	[REDACTED]	11	Delivered to phone	[REDACTED]	2022-12-09 15:11:00.0	1608184918
2022-12-09 15:11:55.0	[REDACTED]	11	Delivered to phone	[REDACTED]	2022-12-09 15:11:00.0	1608184918
2022-12-09 15:11:55.0	[REDACTED]	11	Delivered to phone	[REDACTED]	2022-12-09 15:11:00.0	1608184918
2022-12-09 15:11:55.0	[REDACTED]	11	Delivered to phone	[REDACTED]	2022-12-09 15:11:00.0	1608184918
2022-12-09 15:11:55.0	[REDACTED]	11	Delivered to phone	[REDACTED]	2022-12-09 15:11:00.0	1608184918
2022-12-09 15:11:55.0	[REDACTED]	11	Delivered to phone	[REDACTED]	2022-12-09 15:12:00.0	1608184918
2022-12-09 15:11:55.0	[REDACTED]	11	Delivered to phone	[REDACTED]	2022-12-09 15:12:00.0	1608184918
2022-12-09 15:11:55.0	[REDACTED]	11	Delivered to phone	[REDACTED]	2022-12-09 15:12:00.0	1608184918
2022-12-09 15:11:55.0	[REDACTED]	11	Delivered to phone	[REDACTED]	2022-12-09 15:12:00.0	1608184918
2022-12-09 15:11:55.0	[REDACTED]	11	Delivered to phone	[REDACTED]	2022-12-09 15:12:00.0	1608184918
2022-12-09 15:11:55.0	[REDACTED]	11	Delivered to phone	[REDACTED]	2022-12-09 15:12:00.0	1608184918

APPENDICES

SCOPING REPORT: Scoping and Environmental Impact Assessment (EIA) Process for the Proposed Development of a Solar Photovoltaic (PV) Facility (Kudu Solar Facility 2) and associated infrastructure, near De Aar, Northern Cape Province

created_time	msisdn	status	status_text	origin_address	delivered_time	batch_id
2022-12-09 15:11:55.0	[REDACTED]	11	Delivered to phone	[REDACTED]	2022-12-09 15:12:00.0	1608184918
2022-12-09 15:11:55.0	[REDACTED]	11	Delivered to phone	[REDACTED]	2022-12-09 15:11:00.0	1608184918
2022-12-09 15:11:55.0	[REDACTED]	11	Delivered to phone	[REDACTED]	2022-12-09 15:13:00.0	1608184918
2022-12-09 15:11:55.0	[REDACTED]	11	Delivered to phone	[REDACTED]	2022-12-09 15:12:00.0	1608184918
2022-12-09 15:11:55.0	[REDACTED]	11	Delivered to phone	[REDACTED]	2022-12-09 19:44:00.0	1608184918
2022-12-09 15:11:55.0	[REDACTED]	11	Delivered to phone	[REDACTED]	2022-12-09 19:41:00.0	1608184918
2022-12-09 15:11:55.0	[REDACTED]	11	Delivered to phone	[REDACTED]	2022-12-09 19:46:00.0	1608184918
2022-12-09 15:11:55.0	[REDACTED]	11	Delivered to phone	[REDACTED]	2022-12-09 15:17:00.0	1608184918
2022-12-09 15:11:55.0	[REDACTED]	11	Delivered to phone	[REDACTED]	2022-12-09 15:17:00.0	1608184918
2022-12-09 15:11:55.0	[REDACTED]	11	Delivered to phone	[REDACTED]	2022-12-09 15:12:00.0	1608184918
2022-12-09 15:11:55.0	[REDACTED]	50	Failed	[REDACTED]	2022-12-09 15:11:00.0	1608184918
2022-12-09 15:11:55.0	[REDACTED]	50	Failed	[REDACTED]	2022-12-09 15:11:00.0	1608184918
2022-12-09 15:11:55.0	[REDACTED]	50	Failed	[REDACTED]	2022-12-09 15:12:00.0	1608184918
2022-12-09 15:11:55.0	[REDACTED]	11	Delivered to phone	[REDACTED]	2022-12-09 15:12:00.0	1608184918
2022-12-09 15:11:55.0	[REDACTED]	11	Delivered to phone	[REDACTED]	2022-12-09 15:12:00.0	1608184918
2022-12-09 15:11:55.0	[REDACTED]	11	Delivered to phone	[REDACTED]	2022-12-09 15:12:00.0	1608184918
2022-12-09 15:11:55.0	[REDACTED]	11	Delivered to phone	[REDACTED]	2022-12-09 15:11:00.0	1608184918
2022-12-09 15:11:55.0	[REDACTED]	11	Delivered to phone	[REDACTED]	2022-12-09 15:11:00.0	1608184918
2022-12-09 15:11:55.0	[REDACTED]	11	Delivered to phone	[REDACTED]	2022-12-09 15:11:00.0	1608184918
2022-12-09 15:11:55.0	[REDACTED]	11	Delivered to phone	[REDACTED]	2022-12-09 15:12:00.0	1608184918
2022-12-09 15:11:55.0	[REDACTED]	11	Delivered to phone	[REDACTED]	2022-12-09 15:12:00.0	1608184918
2022-12-09 15:11:55.0	[REDACTED]	11	Delivered to phone	[REDACTED]	2022-12-09 15:13:00.0	1608184918
2022-12-09 15:11:55.0	[REDACTED]	11	Delivered to phone	[REDACTED]	2022-12-09 15:12:00.0	1608184918
2022-12-09 15:11:55.0	[REDACTED]	11	Delivered to phone	[REDACTED]	2022-12-09 15:11:00.0	1608184918
2022-12-09 15:11:55.0	[REDACTED]	11	Delivered to phone	[REDACTED]	2022-12-09 15:12:00.0	1608184918
2022-12-09 15:11:55.0	[REDACTED]	11	Delivered to phone	[REDACTED]	2022-12-09 15:12:00.0	1608184918
2022-12-09 15:11:55.0	[REDACTED]	11	Delivered to phone	[REDACTED]	2022-12-09 15:12:00.0	1608184918
2022-12-09 15:11:55.0	[REDACTED]	11	Delivered to phone	[REDACTED]	2022-12-09 15:11:00.0	1608184918
2022-12-09 15:11:55.0	[REDACTED]	11	Delivered to phone	[REDACTED]	2022-12-09 15:11:00.0	1608184918

APPENDICES

SCOPING REPORT: Scoping and Environmental Impact Assessment (EIA) Process for the Proposed Development of a Solar Photovoltaic (PV) Facility (Kudu Solar Facility 2) and associated infrastructure, near De Aar, Northern Cape Province

created_time	msisdn	status	status_text	origin_address	delivered_time	batch_id
2022-12-09 15:11:55.0	[REDACTED]	11	Delivered to phone	[REDACTED]	2022-12-09 15:11:00.0	1608184918
2022-12-09 15:11:55.0	[REDACTED]	11	Delivered to phone	[REDACTED]	2022-12-09 15:12:00.0	1608184918
2022-12-09 15:11:55.0	[REDACTED]	11	Delivered to phone	[REDACTED]	2022-12-09 15:12:00.0	1608184918
2022-12-09 15:11:55.0	[REDACTED]	11	Delivered to phone	[REDACTED]	2022-12-09 15:12:00.0	1608184918
2022-12-09 15:11:55.0	[REDACTED]	11	Delivered to phone	[REDACTED]	2022-12-09 15:12:00.0	1608184918
2022-12-09 15:11:55.0	[REDACTED]	11	Delivered to phone	[REDACTED]	2022-12-09 15:12:00.0	1608184918
2022-12-09 15:11:55.0	[REDACTED]	11	Delivered to phone	[REDACTED]	2022-12-09 15:12:00.0	1608184918
2022-12-09 15:11:55.0	[REDACTED]	11	Delivered to phone	[REDACTED]	2022-12-09 15:12:00.0	1608184918
2022-12-09 15:11:55.0	[REDACTED]	11	Delivered to phone	[REDACTED]	2022-12-09 15:13:00.0	1608184918
2022-12-09 15:11:55.0	[REDACTED]	11	Delivered to phone	[REDACTED]	2022-12-09 15:12:00.0	1608184918
2022-12-09 15:11:55.0	[REDACTED]	11	Delivered to phone	[REDACTED]	2022-12-09 15:12:00.0	1608184918
2022-12-09 15:11:55.0	[REDACTED]	11	Delivered to phone	[REDACTED]	2022-12-09 15:12:00.0	1608184918
2022-12-09 15:11:55.0	[REDACTED]	11	Delivered to phone	[REDACTED]	2022-12-09 15:12:00.0	1608184918
2022-12-09 15:11:55.0	[REDACTED]	11	Delivered to phone	[REDACTED]	2022-12-09 15:13:00.0	1608184918
2022-12-09 15:11:55.0	[REDACTED]	11	Delivered to phone	[REDACTED]	2022-12-09 15:11:00.0	1608184918
2022-12-09 15:11:55.0	[REDACTED]	11	Delivered to phone	[REDACTED]	2022-12-09 15:12:00.0	1608184918
2022-12-09 15:11:55.0	[REDACTED]	11	Delivered to phone	[REDACTED]	2022-12-09 15:11:00.0	1608184918
2022-12-09 15:11:55.0	[REDACTED]	11	Delivered to phone	[REDACTED]	2022-12-09 15:12:00.0	1608184918
2022-12-09 15:11:55.0	[REDACTED]	11	Delivered to phone	[REDACTED]	2022-12-09 15:12:00.0	1608184918
2022-12-09 15:11:55.0	[REDACTED]	11	Delivered to phone	[REDACTED]	2022-12-09 15:12:00.0	1608184918
2022-12-09 15:11:55.0	[REDACTED]	11	Delivered to phone	[REDACTED]	2022-12-09 15:12:00.0	1608184918
2022-12-09 15:11:55.0	[REDACTED]	11	Delivered to phone	[REDACTED]	2022-12-09 15:12:00.0	1608184918
2022-12-09 15:11:55.0	[REDACTED]	11	Delivered to phone	[REDACTED]	2022-12-09 15:12:00.0	1608184918
2022-12-09 15:11:55.0	[REDACTED]	11	Delivered to phone	[REDACTED]	2022-12-09 15:12:00.0	1608184918
2022-12-09 15:11:55.0	[REDACTED]	11	Delivered to phone	[REDACTED]	2022-12-09 15:12:00.0	1608184918
2022-12-09 15:11:55.0	[REDACTED]	50	Failed	[REDACTED]	2022-12-10 15:11:00.0	1608184918
2022-12-09 15:11:55.0	[REDACTED]	50	Failed	[REDACTED]	2022-12-10 15:11:00.0	1608184918
2022-12-09 15:11:55.0	[REDACTED]	50	Failed	[REDACTED]	2022-12-10 15:12:00.0	1608184918
2022-12-09 15:11:55.0	[REDACTED]	11	Delivered to phone	[REDACTED]	2022-12-09 15:12:00.0	1608184918
2022-12-09 15:11:55.0	[REDACTED]	11	Delivered to phone	[REDACTED]	2022-12-09 15:12:00.0	1608184918
2022-12-09 15:11:55.0	[REDACTED]	11	Delivered to phone	[REDACTED]	2022-12-09 15:12:00.0	1608184918
2022-12-09 15:11:55.0	[REDACTED]	11	Delivered to phone	[REDACTED]	2022-12-11 08:51:00.0	1608184918
2022-12-09 15:11:55.0	[REDACTED]	11	Delivered to phone	[REDACTED]	2022-12-11 08:55:00.0	1608184918

APPENDICES

SCOPING REPORT: Scoping and Environmental Impact Assessment (EIA) Process for the Proposed Development of a Solar Photovoltaic (PV) Facility (Kudu Solar Facility 2) and associated infrastructure, near De Aar, Northern Cape Province

created_time	msisdn	status	status_text	origin_address	delivered_time	batch_id
2022-12-09 15:11:55.0	[REDACTED]	11	Delivered to phone	[REDACTED]	2022-12-11 08:57:00.0	1608184918
2022-12-09 15:11:55.0	[REDACTED]	52	Failed: delivery to network failed	[REDACTED]		1608184918
2022-12-09 15:11:55.0	[REDACTED]	52	Failed: delivery to network failed	[REDACTED]		1608184918
2022-12-09 15:11:55.0	[REDACTED]	52	Failed: delivery to network failed	[REDACTED]		1608184918
2022-12-09 15:11:55.0	[REDACTED]	11	Delivered to phone	[REDACTED]	2022-12-09 15:12:00.0	1608184918
2022-12-09 15:11:55.0	[REDACTED]	11	Delivered to phone	[REDACTED]	2022-12-09 15:12:00.0	1608184918
2022-12-09 15:11:55.0	[REDACTED]	11	Delivered to phone	[REDACTED]	2022-12-09 15:12:00.0	1608184918
2022-12-09 15:11:55.0	[REDACTED]	11	Delivered to phone	[REDACTED]	2022-12-09 15:11:00.0	1608184918
2022-12-09 15:11:55.0	[REDACTED]	11	Delivered to phone	[REDACTED]	2022-12-09 15:12:00.0	1608184918
2022-12-09 15:11:55.0	[REDACTED]	11	Delivered to phone	[REDACTED]	2022-12-09 15:12:00.0	1608184918
2022-12-09 15:11:55.0	[REDACTED]	11	Delivered to phone	[REDACTED]	2022-12-09 15:12:00.0	1608184918
2022-12-09 15:11:55.0	[REDACTED]	11	Delivered to phone	[REDACTED]	2022-12-09 15:12:00.0	1608184918
2022-12-09 15:11:55.0	[REDACTED]	52	Failed: delivery to network failed	[REDACTED]		1608184918
2022-12-09 15:11:55.0	[REDACTED]	52	Failed: delivery to network failed	[REDACTED]		1608184918
2022-12-09 15:11:55.0	[REDACTED]	52	Failed: delivery to network failed	[REDACTED]		1608184918
2022-12-09 15:11:55.0	[REDACTED]	11	Delivered to phone	[REDACTED]	2022-12-09 15:11:00.0	1608184918
2022-12-09 15:11:55.0	[REDACTED]	11	Delivered to phone	[REDACTED]	2022-12-09 15:11:00.0	1608184918
2022-12-09 15:11:55.0	[REDACTED]	11	Delivered to phone	[REDACTED]	2022-12-09 15:12:00.0	1608184918
2022-12-09 15:11:55.0	[REDACTED]	11	Delivered to phone	[REDACTED]	2022-12-09 15:11:00.0	1608184918
2022-12-09 15:11:55.0	[REDACTED]	11	Delivered to phone	[REDACTED]	2022-12-09 15:11:00.0	1608184918
2022-12-09 15:11:55.0	[REDACTED]	11	Delivered to phone	[REDACTED]	2022-12-09 15:12:00.0	1608184918
2022-12-09 15:11:55.0	[REDACTED]	11	Delivered to phone	[REDACTED]	2022-12-09 15:11:00.0	1608184918
2022-12-09 15:11:55.0	[REDACTED]	11	Delivered to phone	[REDACTED]	2022-12-09 15:11:00.0	1608184918
2022-12-09 15:11:55.0	[REDACTED]	11	Delivered to phone	[REDACTED]	2022-12-09 15:11:00.0	1608184918
2022-12-09 15:11:55.0	[REDACTED]	11	Delivered to phone	[REDACTED]	2022-12-09 15:11:00.0	1608184918

APPENDICES

SCOPING REPORT: Scoping and Environmental Impact Assessment (EIA) Process for the Proposed Development of a Solar Photovoltaic (PV) Facility (Kudu Solar Facility 2) and associated infrastructure, near De Aar, Northern Cape Province

5. Proof of Upload of the DSR to the CSIR Project Website

The screenshot displays a web browser window with the URL csir.co.za/environmental-impact-assessment. The page features the CSIR logo and a navigation menu. The main content area is a table with the following structure:

Project Name	Company Name	Province
Scoping and Environmental Impact Assessment (EIA) Processes for the Proposed Development of the Kudu Solar Photovoltaic (PV) Facilities and associated Infrastructure, near De Aar, Northern Cape Province:		
Scoping Report for Kudu Solar Facility 1		
• Draft scoping report		
• Executive summary		
Scoping Report for Kudu Solar Facility 2		
• Draft scoping report		
• Executive summary		
Scoping Report for Kudu Solar Facility 3		
• Draft scoping report		
• Executive summary		
Scoping Report for Kudu Solar Facility 4		
• Draft scoping report		
• Executive summary		
Scoping Report for Kudu Solar Facility 5		
• Draft scoping report		
• Executive summary		
Scoping Report for Kudu Solar Facility 6		
• Draft scoping report		
• Executive summary		
Scoping Report for Kudu Solar Facility 7		
• Draft scoping report		
• Executive summary		
Scoping Report for Kudu Solar Facility 8		
• Draft scoping report		
• Executive summary		
Scoping Report for Kudu Solar Facility 9		
• Draft scoping report		
• Executive summary		
Scoping Report for Kudu Solar Facility 10		
• Draft scoping report		
• Executive summary		
Scoping Report for Kudu Solar Facility 11		
• Draft scoping report		
• Executive summary		
Scoping Report for Kudu Solar Facility 12		
• Draft scoping report		
• Executive summary		
I&AP Notification Letter for Draft Scoping Report Availability		
Report and Appendices also available at https://bit.ly/KUDU_PV		
For enquiries and to request report appendices send an email to ems@csir.co.za		

The table also includes the following information:

- Company Name: ABO Wind renewable energies (Pty) Ltd
- Province: Northern Cape

The Windows taskbar at the bottom shows the search bar, taskbar icons, and system tray with the date 30 Jan 2023 and time 03:56.

APPENDICES

SCOPING REPORT: Scoping and Environmental Impact Assessment (EIA) Process for the Proposed Development of a Solar Photovoltaic (PV) Facility (Kudu Solar Facility 2) and associated infrastructure, near De Aar, Northern Cape Province

6. Proof of Upload of the DSR to Google Drive

The screenshot displays a Google Drive web interface. The address bar shows the URL: drive.google.com/drive/folders/1OI2c0ZXSXa_5EC_SXPJk6QSM2DXhypzc. The page title is "KUDU SOLAR FACILITIES 1-12". The left sidebar shows navigation options: "New", "My Drive", "Computers", "Shared with me", "Recent", "Starred", "Trash", and "Storage" (23.82 GB of 100 GB used). The main content area shows a table of files shared with the user.

Name	Owner	Last modified	File size
Kudu Solar Facility 12 - Draft Scoping Report	Lizandé Kellerman	Nov 30, 2022	Lizandé Kellerman
Kudu Solar Facility 11 - Draft Scoping Report	Lizandé Kellerman	Nov 30, 2022	Lizandé Kellerman
Kudu Solar Facility 10 - Draft Scoping Report	Lizandé Kellerman	Nov 30, 2022	Lizandé Kellerman
Kudu Solar Facility 9 - Draft Scoping Report	Lizandé Kellerman	Nov 30, 2022	Lizandé Kellerman
Kudu Solar Facility 8 - Draft Scoping Report	Lizandé Kellerman	Nov 30, 2022	Lizandé Kellerman
Kudu Solar Facility 7 - Draft Scoping Report	Lizandé Kellerman	Nov 30, 2022	Lizandé Kellerman
Kudu Solar Facility 6 - Draft Scoping Report	Lizandé Kellerman	Nov 30, 2022	Lizandé Kellerman
Kudu Solar Facility 5 - Draft Scoping Report	Lizandé Kellerman	Nov 30, 2022	Lizandé Kellerman
Kudu Solar Facility 4 - Draft Scoping Report	Lizandé Kellerman	Nov 30, 2022	Lizandé Kellerman
Kudu Solar Facility 3 - Draft Scoping Report	Lizandé Kellerman	Nov 30, 2022	Lizandé Kellerman
Kudu Solar Facility 2 - Draft Scoping Report	Lizandé Kellerman	Nov 30, 2022	Lizandé Kellerman
Kudu Solar Facility 1 - Draft Scoping Report	Lizandé Kellerman	Nov 30, 2022	Lizandé Kellerman

The Windows taskbar at the bottom shows the search bar, task view, and several open applications. The system tray displays the date and time as 04:02 on 30 Jan 2023, and the weather as 17°C Mostly cloudy.

APPENDICES

SCOPING REPORT: Scoping and Environmental Impact Assessment (EIA) Process for the Proposed Development of a Solar Photovoltaic (PV) Facility (Kudu Solar Facility 2) and associated infrastructure, near De Aar, Northern Cape Province

7. Proof of Upload of the DSR to SAHRIS (Kudu Solar Facility 2)

SAHRIS
MyDashboard | Explore | Create | Calendar | Maps | Help

Heritage Cases

Special Notice
Following comments received on the proposed Revised Schedule of Fees for applications made to the South African Heritage Resources Agency (SAHRA), made in terms of Section 25(2)(l) of the National Heritage Resources Act No. 25 of 1999 (NHRA) and published in the Government Gazette of 22 July 2022, SAHRA hereby publishes the final Revised Schedule of Fees for Applications made to SAHRA. Applications for provision of services submitted to the South African Heritage Resources Authority (SAHRA), in terms of the National Heritage Resources Act, No. 25 of 1999 (NHRA) must be accompanied by a payment of the appropriate fee, taking effect from 1 January 2023

[Revised Schedule of Fees for Applications made to the South African Heritage Resources Agency \(SAHRA\)](#)

Kudu Solar Facility 2
Add new comment | Subscribe to: This post | 22 reads

CaseHeader | LocationInfo | Admin

Status: Studies Pending
HeritageAuthority(s): SAHRA
NBKB
Case Type: Section 38 (8) - Statutory Comment Required
Development Type: Renewable Energy

ProposalDescription:
ABO Wind renewable energies (Pty) Ltd is proposing to develop 12 Solar Photovoltaic (PV) power generation facilities and associated Electrical Grid Infrastructure (EGI), north-east of the town of De Aar, in the Renosterberg Local Municipality and Pixley Ka Seme District Municipality, in the Northern Cape Province. Scoping and Environmental Impact Assessment (EIA) Processes are currently being undertaken for the 12 Solar PV facilities. Separate Basic Assessment (BA) and/or EGI Standard Registration processes will be commissioned separately, once finalised, for the EGI projects. This case is for the proposed Kudu Solar Facility 2.

ApplicationDate: Sunday, December 11, 2022 - 20:26
CaseID: 20337
Applicants: Kudu Solar Facility 2 (Pty) Ltd
Consultants/Experts: Jayson Orton
John Almond

OtherReferences:

Dept	CaseReference	DueDate	FinalDecision
DFFE		30/01/2023	

Heritage Reports: Kudu Solar Facility 2 Heritage Scoping Report
Kudu Solar Facility and EGI Palaeontology SSV

ReferenceList:

AdditionalDocuments

1. Draft Scoping Report Kudu Solar Facility 2
2. Appendix C Maps Kudu Solar Facility 2
3. Appendix E PPP Kudu Solar Facility 2
4. Appendix F Pre-App Consultation Kudu Solar Facility 2
5. Appendix G.5 VIA Scoping Level Kudu Solar Facility 2

South African Heritage Resources Agency (SAHRA)
111 Harrington Street
Cape Town
8001

PO Box 4637
Cape Town, 8000
Tel 021 462 4502/Fax 021 462 4509
Email info@sahra.org.za
Web www.sahra.org.za

An agency of the Department of Arts & Culture

Powered by Drupal | Site best viewed using Google Chrome | Disclaimer

APPENDICES

SCOPING REPORT: Scoping and Environmental Impact Assessment (EIA) Process for the Proposed Development of a Solar Photovoltaic (PV) Facility (Kudu Solar Facility 2) and associated infrastructure, near De Aar, Northern Cape Province

8. Proof of Courier of USBs to Libraries



Shipment Receipt

Shipment From

CSR
Debbie Cloete / Rohaida Abed
11 Jan Cilliers Street

7600 STELLENBOSCH
South Africa
+27218882400

Shipment To

Philipstown Library
Station Street
Church Street

8795 PHILIPSTOWN
South Africa

Shipment Details

Shipment Date: 2023-01-03
Waybill Number: 4561994021
Service Type: EXPRESS DOMESTIC
Packaging Type: Flyer
Number of Pieces: 1
Total Weight: 1.00kg
Dimensional: 0.36kg
Chargeable: 1.00kg
Insured Amount:
Terms of Trade:

International Information

Declared Value:
Duties&taxes acct:
Dutiable Status: Non-Dutiable
Estimated Del date: Monday, 09 Jan, 2023
Promo Code:

Billing Information

Payment Type: DHL Account Number
Billing Account: 305048439
Duties&taxes acct:
Charge Breakdown: 444.25 ZAR

Special Services: Fuel Surcharge/Remote Area Delivery

Charge is estimated until DHL reweigh

Reference Information

Reference: PO 1000811537
Pickup reference nr:

Description of Contents

USB Memory sticks

2019 © Deutsche Post AG - All rights reserved

9.

APPENDICES

SCOPING REPORT: Scoping and Environmental Impact Assessment (EIA) Process for the Proposed Development of a Solar Photovoltaic (PV) Facility (Kudu Solar Facility 2) and associated infrastructure, near De Aar, Northern Cape Province

DHL **Shipment Receipt**

Shipment From **Shipment To**

CS&K
Debbie Cloete / Rohaida Abed
11 Jan Cilliers Street

PHILIPSTOWN LIBRARY
Station Street ✖
Church Street

7800 STELLENBOEGH
South Africa
+27218882400

8795 PHILIPSTOWN
South Africa

Shipment Details **International Information**

Shipment Date: 2023-01-04
Waybill Number: 5796768471
Service Type: EXPRESS DOMESTIC
Packaging Type: Flyer
Number of Pieces: 1
Total Weight: 1.00kg
Dimensional: 0.36kg
Chargeable: 1.00kg
Insured Amount:
Terms of Trade:

Declared Value:
Duties&taxes acct:
Dutiable Status: Non-Dutiable
Estimated Del date: Monday, 09 Jan, 2023
Promo Code:

*North
4/01*

Billing Information

Payment Type: DHL Account Number
Billing Account: 305048439
Duties&taxes acct:
Charge Breakdown: 444.25 ZAR

Special Services: Fuel Surcharge/Remote Area Delivery

Charge is estimated until DHL reweigh

Reference Information

Reference: PO 1000811537
Pickup reference nr:

Description of Contents

USB Memory sticks

2019 © Deutsche Post AG - All rights reserved

10.

APPENDICES

SCOPING REPORT: Scoping and Environmental Impact Assessment (EIA) Process for the Proposed Development of a Solar Photovoltaic (PV) Facility (Kudu Solar Facility 2) and associated infrastructure, near De Aar, Northern Cape Province



Shipment Receipt

Shipment From

CSIR
Debbie Cloete / Rohaida Abed
11 Jan Cilliers Street

7600 STELLENBOSCH
South Africa
+27218882400

Shipment To

Hennie Liebenberg Junior Library
[REDACTED] (Librarian)*
Station Street

7000 DE AAR
South Africa
[REDACTED]

Shipment Details

Shipment Date: 2023-01-03
Waybill Number: 5898928033
Service Type: EXPRESS DOMESTIC
Packaging Type: Flyer
Number of Pieces: 1
Total Weight: 1.00kg
Dimensional: 0.36kg
Chargeable: 1.00kg
Insured Amount:
Terms of Trade:

International Information

Declared Value:
Duties&taxes acct:
Dutiable Status: Non-Dutiable
Estimated Del date: Monday, 09 Jan, 2023
Promo Code:

Billing Information

Payment Type: DHL Account Number
Billing Account: 305048439
Duties&taxes acct:
Charge Breakdown: 409.30 ZAR

Special Services: Fuel Surcharge/Remote Area Delivery

Charge is estimated until DHL reweigh

Reference Information

Reference: PO 1000811537
Pickup reference nr:

Description of Contents

USB Memory sticks

APPENDICES

SCOPING REPORT: Scoping and Environmental Impact Assessment (EIA) Process for the Proposed Development of a Solar Photovoltaic (PV) Facility (Kudu Solar Facility 2) and associated infrastructure, near De Aar, Northern Cape Province

9. Follow-Up/ Reminder Email sent to all I&APs, Stakeholders, and Organs of State on 17 January 2023

From: EMS
Sent: Tuesday, 17 January 2023 12:06
To: EMS
Subject: Reminder - Availability of Draft Scoping Reports for Comment - Kudu Solar PV
Attachments: Kudu Solar_Letter 2_DSR Release_General IAPs_FINAL_091222.pdf

Categories: This message has been archived by Retain on January 24 2023 18:56

Dear Stakeholders and I&APs

RE: REMINDER OF THE RELEASE OF THE DRAFT SCOPING REPORTS FOR A 30-DAY COMMENT PERIOD FOR THE PROPOSED DEVELOPMENT OF 12 SOLAR PHOTOVOLTAIC (PV) FACILITIES (I.E. KUDU SOLAR FACILITIES) AND VARIOUS ASSOCIATED INFRASTRUCTURE, NEAR DE AAR, NORTHERN CAPE

Further to the email notification below, this serves as a reminder that the 30-day public comment period on the Draft Scoping Reports for the proposed 12 Solar Photovoltaic (PV) facilities (i.e. Kudu Solar Facilities) and various associated infrastructure, near De Aar, Northern Cape, as detailed below, closes on 30 January 2023.

As indicated below, the Draft Scoping Reports can be accessed as follows:

- Google Drive: https://bit.ly/KUDU_SOLAR_PV
- Project website: <https://www.csir.co.za/environmental-impact-assessment>

You are kindly requested to register your interest and submit any comments you may have on the Draft Scoping Reports to the CSIR by 30 January 2023 (details are provided below and in the attached).

Thank you to those of you that have already provided comment.

Please do not hesitate to contact us should you have any queries relating to the above.

In accordance with the Protection of Personal Information Act (Act 4 of 2013), the CSIR will conduct itself responsibly when collecting, processing, storing and sharing any personal information collected for the purposes of Public Participation Processes (PPP) in terms of the 2014 NEMA EIA Regulations (as amended). By registering as an Interested and Affected Party (I&AP) and/or submitting information and comments, you consent to the collection, collation, processing, and storing of such information and the use and disclosure of such information for the aforementioned purpose (<https://www.csir.co.za/csir-privacy-notice>). If you would like to opt out of communications on this project, please do so by responding to this correspondence via email.

Kind Regards,
Rohaida Abed

CSIR Environmental Management Services
E-mail: ems@csir.co.za
Postal Address: P.O. Box 59081, Umbilo, Durban, 4075
Tel: 031 242 2300

APPENDICES



















SCOPING REPORT: Scoping and Environmental Impact Assessment (EIA) Process for the Proposed Development of a Solar Photovoltaic (PV) Facility (Kudu Solar Facility 2) and associated infrastructure, near De Aar, Northern Cape Province

10. Proof of Delivery of Follow Up/ Reminder Email sent to all I&APs, Stakeholders, and Organs of State on 17 January 2023

EMS - Delivery Reports							By Date v ↑
From	Subject	Received	Size	Categories	Mention	v	
Mail Delivery... Undeliverable: Reminder - Availability of Draft Scoping Reports for Co...	Mon 23 Jan 2023... 37 KB						[You don't often get email from mailer-daemon@mailgate1.inextweb.co.za. Learn why this is important at https://aka.ms/LearnAboutSenderIdentification]
Mail Delivery... Undeliverable: Reminder - Availability of Draft Scoping Reports for Co...	Sun 22 Jan 2023... 37 KB				This message ...		[You don't often get email from mailer-daemon@pta-smg2.csir.co.za. Learn why this is important at https://aka.ms/LearnAboutSenderIdentification] This is the mail
Mail Delivery... Undeliverable: Reminder - Availability of Draft Scoping Reports for Co...	Sun 22 Jan 2023... 36 KB				This message ...		[You don't often get email from mailer-daemon@pta-smg2.csir.co.za. Learn why this is important at https://aka.ms/LearnAboutSenderIdentification] This is the mail
Mail Delivery... Undeliverable: Reminder - Availability of Draft Scoping Reports for Co...	Sun 22 Jan 2023... 38 KB				This message ...		[You don't often get email from mailer-daemon@pta-smg2.csir.co.za. Learn why this is important at https://aka.ms/LearnAboutSenderIdentification] This is the mail
Two Weeks Ago							
postmaster@... Delivered: Reminder - Availability of Draft Scoping Reports for Comme...	Tue 17 Jan 2023... 133 KB				This message ...		You don't often get email from postmaster@outlook.com. Learn why this is important < https://aka.ms/LearnAboutSenderIdentification >
Mail Delivery... Relayed: Reminder - Availability of Draft Scoping Reports for Comment...	Tue 17 Jan 2023... 72 KB				This message ...		[You don't often get email from mailer-daemon@pta-smg2.csir.co.za. Learn why this is important at https://aka.ms/LearnAboutSenderIdentification] This is the mail
Mail Delivery... Relayed: Reminder - Availability of Draft Scoping Reports for Comment...	Tue 17 Jan 2023... 66 KB				This message ...		[You don't often get email from mailer-daemon@pta-smg2.csir.co.za. Learn why this is important at https://aka.ms/LearnAboutSenderIdentification] This is the mail
Mail Delivery... Undeliverable: Reminder - Availability of Draft Scoping Reports for Co...	Tue 17 Jan 2023... 31 KB				This message ...		[You don't often get email from mailer-daemon@pta-smg2.csir.co.za. Learn why this is important at https://aka.ms/LearnAboutSenderIdentification] This is the mail
Mail Delivery... Relayed: Reminder - Availability of Draft Scoping Reports for Comment...	Tue 17 Jan 2023... 73 KB				This message ...		[You don't often get email from mailer-daemon@pta-smg2.csir.co.za. Learn why this is important at https://aka.ms/LearnAboutSenderIdentification] This is the mail
postmaster@... Undeliverable: Reminder - Availability of Draft Scoping Reports for Co...	Tue 17 Jan 2023... 262 KB				This message ...		You don't often get email from postmaster@transnet.net. Learn why this is important < https://aka.ms/LearnAboutSenderIdentification >
Mail Delivery... Undeliverable: This email might be SPAM This email might be SPAM Re...	Tue 17 Jan 2023... 36 KB				This message ...		[You don't often get email from mailer-daemon@delivery.e-purifier.com. Learn why this is important at https://aka.ms/LearnAboutSenderIdentification]
postmaster@... Delivered: Reminder - Availability of Draft Scoping Reports for Comme...	Tue 17 Jan 2023... 139 KB				This message ...		You don't often get email from postmaster@dws.gov.za. Learn why this is important < https://aka.ms/LearnAboutSenderIdentification >
postmaster@... Delivered: Reminder - Availability of Draft Scoping Reports for Comme...	Tue 17 Jan 2023... 139 KB				This message ...		You don't often get email from postmaster@dws.gov.za. Learn why this is important < https://aka.ms/LearnAboutSenderIdentification >

APPENDICES

SCOPING REPORT: Scoping and Environmental Impact Assessment (EIA) Process for the Proposed Development of a Solar Photovoltaic (PV) Facility (Kudu Solar Facility 2) and associated infrastructure, near De Aar, Northern Cape Province

EMS - Delivery Reports						By Date ▾ ↑
    	From	Subject	Received ▾	Size	Categories	Mention 
	postmaster@...	Delivered: Reminder - Availability of Draft Scoping Reports for Comme... Your message has been delivered to the following recipients:	Tue 17 Jan 2023...	133 KB		This message ...
	postmaster@...	Delivered: Reminder - Availability of Draft Scoping Reports for Comme... You don't often get email from postmaster@dws.gov.za. Learn why this is important < https://aka.ms/LearnAboutSenderIdentification >	Tue 17 Jan 2023...	139 KB		This message ...
	postmaster@...	Delivered: Reminder - Availability of Draft Scoping Reports for Comme... You don't often get email from postmaster@dws.gov.za. Learn why this is important < https://aka.ms/LearnAboutSenderIdentification >	Tue 17 Jan 2023...	139 KB		This message ...
	postmaster@...	Delivered: Reminder - Availability of Draft Scoping Reports for Comme... You don't often get email from postmaster@dws.gov.za. Learn why this is important < https://aka.ms/LearnAboutSenderIdentification >	Tue 17 Jan 2023...	132 KB		This message ...
	postmaster@...	Delivered: Reminder - Availability of Draft Scoping Reports for Comme... You don't often get email from postmaster@corp.akuoenergy.com. Learn why this is important < https://aka.ms/LearnAboutSenderIdentification >	Tue 17 Jan 2023...	136 KB		This message ...
	postmaster@...	Delivered: Reminder - Availability of Draft Scoping Reports for Comme... You don't often get email from postmaster@r-n.co.za. Learn why this is important < https://aka.ms/LearnAboutSenderIdentification >	Tue 17 Jan 2023...	135 KB		This message ...
	postmaster@...	Undeliverable: Reminder - Availability of Draft Scoping Reports for Co... [The e-mail server of the sender could not be verified (SPF Record)]	Tue 17 Jan 2023...	260 KB		This message ...
	postmaster@...	Delivered: Reminder - Availability of Draft Scoping Reports for Comme... You don't often get email from postmaster@g7energies.com. Learn why this is important < https://aka.ms/LearnAboutSenderIdentification >	Tue 17 Jan 2023...	137 KB		This message ...
	postmaster@...	Delivered: Reminder - Availability of Draft Scoping Reports for Comme... You don't often get email from postmaster@g7energies.com. Learn why this is important < https://aka.ms/LearnAboutSenderIdentification >	Tue 17 Jan 2023...	137 KB		This message ...
	postmaster@...	Delivered: Reminder - Availability of Draft Scoping Reports for Comme... You don't often get email from postmaster@g7energies.com. Learn why this is important < https://aka.ms/LearnAboutSenderIdentification >	Tue 17 Jan 2023...	137 KB		This message ...
	postmaster@...	Delivered: Reminder - Availability of Draft Scoping Reports for Comme... You don't often get email from postmaster@g7energies.com. Learn why this is important < https://aka.ms/LearnAboutSenderIdentification >	Tue 17 Jan 2023...	137 KB		This message ...
	postmaster@...	Delivered: Reminder - Availability of Draft Scoping Reports for Comme... You don't often get email from postmaster@g7energies.com. Learn why this is important < https://aka.ms/LearnAboutSenderIdentification >	Tue 17 Jan 2023...	137 KB		This message ...

APPENDICES

SCOPING REPORT: Scoping and Environmental Impact Assessment (EIA) Process for the Proposed Development of a Solar Photovoltaic (PV) Facility (Kudu Solar Facility 2) and associated infrastructure, near De Aar, Northern Cape Province

EMS - Delivery Reports										By Date ▾ ↑	
					From	Subject	Received ▾	Size	Categories	Mention	
					postmaster@...	Delivered: Reminder - Availability of Draft Scoping Reports for Comme... Tue 17 Jan 2023... 137 KB This message ... You don't often get email from postmaster@g7energies.com. Learn why this is important <https://aka.ms/LearnAboutSenderIdentification>					
					postmaster@...	Delivered: Reminder - Availability of Draft Scoping Reports for Comme... Tue 17 Jan 2023... 137 KB This message ... You don't often get email from postmaster@g7energies.com. Learn why this is important <https://aka.ms/LearnAboutSenderIdentification>					
					postmaster@...	Delivered: Reminder - Availability of Draft Scoping Reports for Comme... Tue 17 Jan 2023... 137 KB This message ... You don't often get email from postmaster@g7energies.com. Learn why this is important <https://aka.ms/LearnAboutSenderIdentification>					
					postmaster@...	Delivered: Reminder - Availability of Draft Scoping Reports for Comme... Tue 17 Jan 2023... 137 KB This message ... You don't often get email from postmaster@g7energies.com. Learn why this is important <https://aka.ms/LearnAboutSenderIdentification>					
					postmaster@...	Delivered: Reminder - Availability of Draft Scoping Reports for Comme... Tue 17 Jan 2023... 137 KB This message ... You don't often get email from postmaster@g7energies.com. Learn why this is important <https://aka.ms/LearnAboutSenderIdentification>					
					postmaster@...	Delivered: Reminder - Availability of Draft Scoping Reports for Comme... Tue 17 Jan 2023... 137 KB This message ... You don't often get email from postmaster@g7energies.com. Learn why this is important <https://aka.ms/LearnAboutSenderIdentification>					
					postmaster@...	Delivered: Reminder - Availability of Draft Scoping Reports for Comme... Tue 17 Jan 2023... 126 KB This message ... You don't often get email from postmaster@weathersa.co.za. Learn why this is important <https://aka.ms/LearnAboutSenderIdentification>					
					postmaster@...	Delivered: Reminder - Availability of Draft Scoping Reports for Comme... Tue 17 Jan 2023... 126 KB This message ... You don't often get email from postmaster@weathersa.co.za. Learn why this is important <https://aka.ms/LearnAboutSenderIdentification>					
					postmaster@...	Delivered: Reminder - Availability of Draft Scoping Reports for Comme... Tue 17 Jan 2023... 126 KB This message ... You don't often get email from postmaster@weathersa.co.za. Learn why this is important <https://aka.ms/LearnAboutSenderIdentification>					
					Mail Delivery...	Undeliverable: Reminder - Availability of Draft Scoping Reports for Co... Tue 17 Jan 2023... 30 KB This message ... [You don't often get email from mailer-daemon@pta-smg2.csir.co.za. Learn why this is important at https://aka.ms/LearnAboutSenderIdentification] This is the mail					
					Mail Delivery...	Relayed: Reminder - Availability of Draft Scoping Reports for Comment... Tue 17 Jan 2023... 110 KB This message ... [You don't often get email from mailer-daemon@pta-smg2.csir.co.za. Learn why this is important at https://aka.ms/LearnAboutSenderIdentification] This is the mail					
					postmaster@...	Undeliverable: Reminder - Availability of Draft Scoping Reports for Co... Tue 17 Jan 2023... 259 KB This message ... [The e-mail server of the sender could not be verified (SPF Record)]					
					Mail Delivery...	Delivered: Reminder - Availability of Draft Scoping Reports for Comme... Tue 17 Jan 2023... 78 KB This message ... [You don't often get email from mailer-daemon@server.itdesign.co.za. Learn why this is important at https://aka.ms/LearnAboutSenderIdentification] This message					

APPENDICES

SCOPING REPORT: Scoping and Environmental Impact Assessment (EIA) Process for the Proposed Development of a Solar Photovoltaic (PV) Facility (Kudu Solar Facility 2) and associated infrastructure, near De Aar, Northern Cape Province

EMS - Delivery Reports										By Date ▾ ↑	
					From	Subject	Received ▾	Size	Categories	Mention	
						Mail Delivery... Relayed: Reminder - Availability of Draft Scoping Reports for Comment...	Tue 17 Jan 2023...	98 KB		This message ...	
[You don't often get email from mailer-daemon@pta-smg2.csir.co.za. Learn why this is important at https://aka.ms/LearnAboutSenderIdentification] This is the mail											
						Mail Delivery... Undeliverable: Reminder - Availability of Draft Scoping Reports for Co...	Tue 17 Jan 2023...	36 KB		This message ...	
[You don't often get email from mailer-daemon@pta-smg2.csir.co.za. Learn why this is important at https://aka.ms/LearnAboutSenderIdentification] This is the mail											
						Mail Delivery... Relayed: Reminder - Availability of Draft Scoping Reports for Comment...	Tue 17 Jan 2023...	113 KB		This message ...	
[You don't often get email from mailer-daemon@pta-smg2.csir.co.za. Learn why this is important at https://aka.ms/LearnAboutSenderIdentification] This is the mail											
						Mail Delivery... Undeliverable: Reminder - Availability of Draft Scoping Reports for Co...	Tue 17 Jan 2023...	34 KB		This message ...	
[You don't often get email from mailer-daemon@pta-smg2.csir.co.za. Learn why this is important at https://aka.ms/LearnAboutSenderIdentification] This is the mail											
						Mail Delivery... Relayed: Reminder - Availability of Draft Scoping Reports for Comment...	Tue 17 Jan 2023...	109 KB		This message ...	
[You don't often get email from mailer-daemon@pta-smg2.csir.co.za. Learn why this is important at https://aka.ms/LearnAboutSenderIdentification] This is the mail											
						Mail Delivery... Relayed: Reminder - Availability of Draft Scoping Reports for Comment...	Tue 17 Jan 2023...	83 KB		This message ...	
[You don't often get email from mailer-daemon@hostserv.co.za. Learn why this is important at https://aka.ms/LearnAboutSenderIdentification]											
					postmaster@...	Delivered: Reminder - Availability of Draft Scoping Reports for Comme...	Tue 17 Jan 2023...	131 KB		This message ...	
You don't often get email from postmaster@birdlife.org.za. Learn why this is important < https://aka.ms/LearnAboutSenderIdentification >											
					postmaster@...	Delivered: Reminder - Availability of Draft Scoping Reports for Comme...	Tue 17 Jan 2023...	132 KB		This message ...	
You don't often get email from postmaster@wessa.co.za. Learn why this is important < https://aka.ms/LearnAboutSenderIdentification >											
					postmaster@...	Delivered: Reminder - Availability of Draft Scoping Reports for Comme...	Tue 17 Jan 2023...	131 KB		This message ...	
You don't often get email from postmaster@outlook.com. Learn why this is important < https://aka.ms/LearnAboutSenderIdentification >											
					postmaster@...	Delivered: Reminder - Availability of Draft Scoping Reports for Comme...	Tue 17 Jan 2023...	131 KB		This message ...	
You don't often get email from postmaster@birdlife.org.za. Learn why this is important < https://aka.ms/LearnAboutSenderIdentification >											
					postmaster@...	Delivered: Reminder - Availability of Draft Scoping Reports for Comme...	Tue 17 Jan 2023...	133 KB		This message ...	
You don't often get email from postmaster@outlook.com. Learn why this is important < https://aka.ms/LearnAboutSenderIdentification >											
					MAILER-DAE...	Failure Notice	Tue 17 Jan 2023...	120 KB		This message ...	
[You don't often get email from mailer-daemon@yahoo.com. Learn why this is important at https://aka.ms/LearnAboutSenderIdentification]											
						Mail Delivery... Delivered: Reminder - Availability of Draft Scoping Reports for Comme...	Tue 17 Jan 2023...	83 KB		This message ...	
[You don't often get email from mailer-daemon@ci74p00im-qukt09072702.me.com. Learn why this is important at https://aka.ms/LearnAboutSenderIdentification]											

APPENDICES

SCOPING REPORT: Scoping and Environmental Impact Assessment (EIA) Process for the Proposed Development of a Solar Photovoltaic (PV) Facility (Kudu Solar Facility 2) and associated infrastructure, near De Aar, Northern Cape Province

EMS - Delivery Reports										By Date v ↑
From	Subject	Received v	Size	Categories	Mention					
Mail Delivery... Undeliverable: Reminder - Availability of Draft Scoping Reports for Co...		Tue 17 Jan 2023...	36 KB		This message ...	[You don't often get email from mailer-daemon@mailcape.saa.ac.za. Learn why this is important at https://aka.ms/LearnAboutSenderIdentification]				
postmaster@... Delivered: Reminder - Availability of Draft Scoping Reports for Comme...		Tue 17 Jan 2023...	131 KB		This message ...	You don't often get email from postmaster@birdlife.org.za. Learn why this is important < https://aka.ms/LearnAboutSenderIdentification >				
postmaster@... Delivered: Reminder - Availability of Draft Scoping Reports for Comme...		Tue 17 Jan 2023...	130 KB		This message ...	You don't often get email from postmaster@outlook.com. Learn why this is important < https://aka.ms/LearnAboutSenderIdentification >				
postmaster@... Delivered: Reminder - Availability of Draft Scoping Reports for Comme...		Tue 17 Jan 2023...	131 KB		This message ...	You don't often get email from postmaster@netorg6186573.onmicrosoft.com. Learn why this is important < https://aka.ms/LearnAboutSenderIdentification >				
postmaster@... Delivered: Reminder - Availability of Draft Scoping Reports for Comme...		Tue 17 Jan 2023...	129 KB		This message ...	You don't often get email from postmaster@netorg7356748.onmicrosoft.com. Learn why this is important < https://aka.ms/LearnAboutSenderIdentification >				
postmaster@... Delivered: Reminder - Availability of Draft Scoping Reports for Comme...		Tue 17 Jan 2023...	131 KB		This message ...	You don't often get email from postmaster@agrink.co.za. Learn why this is important < https://aka.ms/LearnAboutSenderIdentification >				
postmaster@... Delivered: Reminder - Availability of Draft Scoping Reports for Comme...		Tue 17 Jan 2023...	131 KB		This message ...	You don't often get email from postmaster@agrink.co.za. Learn why this is important < https://aka.ms/LearnAboutSenderIdentification >				
postmaster@... Delivered: Reminder - Availability of Draft Scoping Reports for Comme...		Tue 17 Jan 2023...	131 KB		This message ...	You don't often get email from postmaster@mulilo.com. Learn why this is important < https://aka.ms/LearnAboutSenderIdentification >				
postmaster@... Delivered: Reminder - Availability of Draft Scoping Reports for Comme...		Tue 17 Jan 2023...	127 KB		This message ...	You don't often get email from postmaster@nocci.co.za. Learn why this is important < https://aka.ms/LearnAboutSenderIdentification >				
Mail Delivery... Relayed: Reminder - Availability of Draft Scoping Reports for Comment...		Tue 17 Jan 2023...	66 KB		This message ...	[You don't often get email from mailer-daemon@pta-smg2.csir.co.za. Learn why this is important at https://aka.ms/LearnAboutSenderIdentification] This is the mail				
Mail Delivery... Relayed: Reminder - Availability of Draft Scoping Reports for Comment...		Tue 17 Jan 2023...	78 KB		This message ...	[You don't often get email from mailer-daemon@hostserv.co.za. Learn why this is important at https://aka.ms/LearnAboutSenderIdentification]				
Mail Delivery... Relayed: Reminder - Availability of Draft Scoping Reports for Comment...		Tue 17 Jan 2023...	72 KB		This message ...	[You don't often get email from mailer-daemon@pta-smg2.csir.co.za. Learn why this is important at https://aka.ms/LearnAboutSenderIdentification] This is the mail				
Microsoft Ou... Delivered: Reminder - Availability of Draft Scoping Reports for Comme...		Tue 17 Jan 2023...	172 KB		This message ...	Your message has been delivered to the following recipients:				

APPENDICES

SCOPING REPORT: Scoping and Environmental Impact Assessment (EIA) Process for the Proposed Development of a Solar Photovoltaic (PV) Facility (Kudu Solar Facility 2) and associated infrastructure, near De Aar, Northern Cape Province

- | | |
|---|---|
|  | Microsoft Outlook Delivered: Reminder - Availability of Draft Scoping Reports for Comm... Tue 17 Jan 2023... 172 KB This message ...
Your message has been delivered to the following recipients: |
|  | Microsoft Outlook Delivered: Reminder - Availability of Draft Scoping Reports for Comm... Tue 17 Jan 2023... 172 KB This message ...
Your message has been delivered to the following recipients: |
|  | Microsoft Outlook Delivered: Reminder - Availability of Draft Scoping Reports for Comm... Tue 17 Jan 2023... 180 KB This message ...
Your message has been delivered to the following recipients: |

APPENDICES

SCOPING REPORT: Scoping and Environmental Impact Assessment (EIA) Process for the Proposed Development of a Solar Photovoltaic (PV) Facility (Kudu Solar Facility 2) and associated infrastructure, near De Aar, Northern Cape Province

11. Proof of SMS Reminder Text Message sent to all I&APs, Stakeholders, and Organs of State (where cell phone numbers were available) on 17 January 2023

Copy of text included in the SMS: Dear Stakeholder, Reminder that the comment period on the Draft Scoping Reports for the proposed Kudu Solar Facilities 1-12 near De Aar, NC closes 30 Jan 2023. Visit https://bit.ly/KUDU_SOLAR_PV or https://bit.ly/CSIR_EIA to access the reports. To send comments, queries or to opt out of future communication on these projects, email ems@csir.co.za. Regards, CSIR EMS Team (https://bit.ly/CSIR_privacy)

created_time	msisdn	status	status_text	origin_address	delivered_time	batch_id
2023-01-17 12:51:08.0	[REDACTED]	11	Delivered to phone	[REDACTED]	2023-01-17 12:51:00.0	1625809243
2023-01-17 12:51:08.0	[REDACTED]	11	Delivered to phone	[REDACTED]	2023-01-17 12:51:00.0	1625809243
2023-01-17 12:51:08.0	[REDACTED]	11	Delivered to phone	[REDACTED]	2023-01-17 12:51:00.0	1625809243
2023-01-17 12:51:08.0	[REDACTED]	11	Delivered to phone	[REDACTED]	2023-01-17 12:51:00.0	1625809243
2023-01-17 12:51:08.0	[REDACTED]	11	Delivered to phone	[REDACTED]	2023-01-17 12:51:00.0	1625809243
2023-01-17 12:51:08.0	[REDACTED]	11	Delivered to phone	[REDACTED]	2023-01-17 12:51:00.0	1625809243
2023-01-17 12:51:08.0	[REDACTED]	11	Delivered to phone	[REDACTED]	2023-01-17 12:51:00.0	1625809243
2023-01-17 12:51:08.0	[REDACTED]	11	Delivered to phone	[REDACTED]	2023-01-17 12:51:00.0	1625809243
2023-01-17 12:51:08.0	[REDACTED]	11	Delivered to phone	[REDACTED]	2023-01-17 12:51:00.0	1625809243
2023-01-17 12:51:08.0	[REDACTED]	50	Failed	[REDACTED]	2023-01-17 13:06:00.0	1625809243
2023-01-17 12:51:08.0	[REDACTED]	50	Failed	[REDACTED]	2023-01-17 13:06:00.0	1625809243
2023-01-17 12:51:08.0	[REDACTED]	50	Failed	[REDACTED]	2023-01-17 13:06:00.0	1625809243
2023-01-17 12:51:08.0	[REDACTED]	11	Delivered to phone	[REDACTED]	2023-01-17 12:51:00.0	1625809243
2023-01-17 12:51:08.0	[REDACTED]	11	Delivered to phone	[REDACTED]	2023-01-17 12:51:00.0	1625809243
2023-01-17 12:51:08.0	[REDACTED]	11	Delivered to phone	[REDACTED]	2023-01-17 12:51:00.0	1625809243
2023-01-17 12:51:08.0	[REDACTED]	11	Delivered to phone	[REDACTED]	2023-01-17 12:51:00.0	1625809243
2023-01-17 12:51:08.0	[REDACTED]	11	Delivered to phone	[REDACTED]	2023-01-17 12:51:00.0	1625809243
2023-01-17 12:51:08.0	[REDACTED]	11	Delivered to phone	[REDACTED]	2023-01-17 12:51:00.0	1625809243
2023-01-17 12:51:08.0	[REDACTED]	11	Delivered to phone	[REDACTED]	2023-01-17 12:51:00.0	1625809243
2023-01-17 12:51:08.0	[REDACTED]	11	Delivered to phone	[REDACTED]	2023-01-17 12:51:00.0	1625809243
2023-01-17 12:51:08.0	[REDACTED]	11	Delivered to phone	[REDACTED]	2023-01-17 12:51:00.0	1625809243
2023-01-17 12:51:08.0	[REDACTED]	11	Delivered to phone	[REDACTED]	2023-01-17 12:51:00.0	1625809243
2023-01-17 12:51:08.0	[REDACTED]	11	Delivered to phone	[REDACTED]	2023-01-17 12:51:00.0	1625809243

APPENDICES

SCOPING REPORT: Scoping and Environmental Impact Assessment (EIA) Process for the Proposed Development of a Solar Photovoltaic (PV) Facility (Kudu Solar Facility 2) and associated infrastructure, near De Aar, Northern Cape Province

created_time	msisdn	status	status_text	origin_address	delivered_time	batch_id
2023-01-17 12:51:08.0	[REDACTED]	11	Delivered to phone	[REDACTED]	2023-01-17 12:51:00.0	1625809243
2023-01-17 12:51:08.0	[REDACTED]	11	Delivered to phone	[REDACTED]	2023-01-17 12:51:00.0	1625809243
2023-01-17 12:51:08.0	[REDACTED]	11	Delivered to phone	[REDACTED]	2023-01-17 12:51:00.0	1625809243
2023-01-17 12:51:08.0	[REDACTED]	11	Delivered to phone	[REDACTED]	2023-01-17 12:51:00.0	1625809243
2023-01-17 12:51:08.0	[REDACTED]	11	Delivered to phone	[REDACTED]	2023-01-17 12:51:00.0	1625809243
2023-01-17 12:51:08.0	[REDACTED]	11	Delivered to phone	[REDACTED]	2023-01-17 12:51:00.0	1625809243
2023-01-17 12:51:08.0	[REDACTED]	11	Delivered to phone	[REDACTED]	2023-01-17 12:51:00.0	1625809243
2023-01-17 12:51:08.0	[REDACTED]	11	Delivered to phone	[REDACTED]	2023-01-17 12:51:00.0	1625809243
2023-01-17 12:51:08.0	[REDACTED]	11	Delivered to phone	[REDACTED]	2023-01-17 12:52:00.0	1625809243
2023-01-17 12:51:08.0	[REDACTED]	11	Delivered to phone	[REDACTED]	2023-01-17 12:51:00.0	1625809243
2023-01-17 12:51:08.0	[REDACTED]	11	Delivered to phone	[REDACTED]	2023-01-17 12:51:00.0	1625809243
2023-01-17 12:51:08.0	[REDACTED]	11	Delivered to phone	[REDACTED]	2023-01-17 12:51:00.0	1625809243
2023-01-17 12:51:08.0	[REDACTED]	50	Failed	[REDACTED]	2023-01-17 12:51:00.0	1625809243
2023-01-17 12:51:08.0	[REDACTED]	50	Failed	[REDACTED]	2023-01-17 12:51:00.0	1625809243
2023-01-17 12:51:08.0	[REDACTED]	50	Failed	[REDACTED]	2023-01-17 12:51:00.0	1625809243
2023-01-17 12:51:08.0	[REDACTED]	11	Delivered to phone	[REDACTED]	2023-01-17 12:51:00.0	1625809243
2023-01-17 12:51:08.0	[REDACTED]	11	Delivered to phone	[REDACTED]	2023-01-17 12:51:00.0	1625809243
2023-01-17 12:51:08.0	[REDACTED]	11	Delivered to phone	[REDACTED]	2023-01-17 12:52:00.0	1625809243
2023-01-17 12:51:08.0	[REDACTED]	11	Delivered to phone	[REDACTED]	2023-01-17 12:51:00.0	1625809243
2023-01-17 12:51:08.0	[REDACTED]	11	Delivered to phone	[REDACTED]	2023-01-17 12:51:00.0	1625809243
2023-01-17 12:51:08.0	[REDACTED]	11	Delivered to phone	[REDACTED]	2023-01-17 12:51:00.0	1625809243
2023-01-17 12:51:08.0	[REDACTED]	11	Delivered to phone	[REDACTED]	2023-01-17 12:51:00.0	1625809243
2023-01-17 12:51:08.0	[REDACTED]	11	Delivered to phone	[REDACTED]	2023-01-17 12:51:00.0	1625809243
2023-01-17 12:51:08.0	[REDACTED]	11	Delivered to phone	[REDACTED]	2023-01-17 12:51:00.0	1625809243
2023-01-17 12:51:08.0	[REDACTED]	11	Delivered to phone	[REDACTED]	2023-01-17 14:12:00.0	1625809243
2023-01-17 12:51:08.0	[REDACTED]	11	Delivered to phone	[REDACTED]	2023-01-17 14:25:00.0	1625809243
2023-01-17 12:51:08.0	[REDACTED]	11	Delivered to phone	[REDACTED]	2023-01-17 14:26:00.0	1625809243
2023-01-17 12:51:08.0	[REDACTED]	11	Delivered to phone	[REDACTED]	2023-01-17 12:51:00.0	1625809243
2023-01-17 12:51:08.0	[REDACTED]	11	Delivered to phone	[REDACTED]	2023-01-17 12:51:00.0	1625809243
2023-01-17 12:51:08.0	[REDACTED]	11	Delivered to phone	[REDACTED]	2023-01-17 12:51:00.0	1625809243

APPENDICES

SCOPING REPORT: Scoping and Environmental Impact Assessment (EIA) Process for the Proposed Development of a Solar Photovoltaic (PV) Facility (Kudu Solar Facility 2) and associated infrastructure, near De Aar, Northern Cape Province

created_time	msisdn	status	status_text	origin_address	delivered_time	batch_id
2023-01-17 12:51:08.0	[REDACTED]	11	Delivered to phone	[REDACTED]	2023-01-17 12:51:00.0	1625809243
2023-01-17 12:51:08.0	[REDACTED]	11	Delivered to phone	[REDACTED]	2023-01-17 12:51:00.0	1625809243
2023-01-17 12:51:08.0	[REDACTED]	11	Delivered to phone	[REDACTED]	2023-01-17 12:51:00.0	1625809243
2023-01-17 12:51:08.0	[REDACTED]	11	Delivered to phone	[REDACTED]	2023-01-17 12:51:00.0	1625809243
2023-01-17 12:51:08.0	[REDACTED]	11	Delivered to phone	[REDACTED]	2023-01-17 12:51:00.0	1625809243
2023-01-17 12:51:08.0	[REDACTED]	11	Delivered to phone	[REDACTED]	2023-01-17 12:51:00.0	1625809243
2023-01-17 12:51:08.0	[REDACTED]	11	Delivered to phone	[REDACTED]	2023-01-17 12:51:00.0	1625809243
2023-01-17 12:51:08.0	[REDACTED]	11	Delivered to phone	[REDACTED]	2023-01-17 12:51:00.0	1625809243
2023-01-17 12:51:08.0	[REDACTED]	11	Delivered to phone	[REDACTED]	2023-01-17 12:51:00.0	1625809243
2023-01-17 12:51:08.0	[REDACTED]	11	Delivered to phone	[REDACTED]	2023-01-17 12:52:00.0	1625809243
2023-01-17 12:51:08.0	[REDACTED]	11	Delivered to phone	[REDACTED]	2023-01-17 12:51:00.0	1625809243
2023-01-17 12:51:08.0	[REDACTED]	11	Delivered to phone	[REDACTED]	2023-01-17 12:51:00.0	1625809243
2023-01-17 12:51:08.0	[REDACTED]	11	Delivered to phone	[REDACTED]	2023-01-17 12:51:00.0	1625809243
2023-01-17 12:51:08.0	[REDACTED]	11	Delivered to phone	[REDACTED]	2023-01-17 12:51:00.0	1625809243
2023-01-17 12:51:08.0	[REDACTED]	11	Delivered to phone	[REDACTED]	2023-01-17 12:51:00.0	1625809243
2023-01-17 12:51:08.0	[REDACTED]	11	Delivered to phone	[REDACTED]	2023-01-17 12:51:00.0	1625809243
2023-01-17 12:51:08.0	[REDACTED]	11	Delivered to phone	[REDACTED]	2023-01-17 12:51:00.0	1625809243
2023-01-17 12:51:08.0	[REDACTED]	11	Delivered to phone	[REDACTED]	2023-01-17 12:51:00.0	1625809243
2023-01-17 12:51:08.0	[REDACTED]	11	Delivered to phone	[REDACTED]	2023-01-17 12:51:00.0	1625809243
2023-01-17 12:51:08.0	[REDACTED]	11	Delivered to phone	[REDACTED]	2023-01-17 12:51:00.0	1625809243
2023-01-17 12:51:08.0	[REDACTED]	11	Delivered to phone	[REDACTED]	2023-01-17 12:51:00.0	1625809243
2023-01-17 12:51:08.0	[REDACTED]	11	Delivered to phone	[REDACTED]	2023-01-17 12:51:00.0	1625809243
2023-01-17 12:51:08.0	[REDACTED]	11	Delivered to phone	[REDACTED]	2023-01-17 12:51:00.0	1625809243
2023-01-17 12:51:08.0	[REDACTED]	11	Delivered to phone	[REDACTED]	2023-01-17 12:51:00.0	1625809243
2023-01-17 12:51:08.0	[REDACTED]	50	Failed	[REDACTED]	2023-01-18 12:51:00.0	1625809243
2023-01-17 12:51:08.0	[REDACTED]	50	Failed	[REDACTED]	2023-01-18 12:51:00.0	1625809243
2023-01-17 12:51:08.0	[REDACTED]	50	Failed	[REDACTED]	2023-01-18 12:51:00.0	1625809243
2023-01-17 12:51:08.0	[REDACTED]	11	Delivered to phone	[REDACTED]	2023-01-17 12:51:00.0	1625809243
2023-01-17 12:51:08.0	[REDACTED]	11	Delivered to phone	[REDACTED]	2023-01-17 12:51:00.0	1625809243
2023-01-17 12:51:08.0	[REDACTED]	11	Delivered to phone	[REDACTED]	2023-01-17 12:51:00.0	1625809243

APPENDICES

SCOPING REPORT: Scoping and Environmental Impact Assessment (EIA) Process for the Proposed Development of a Solar Photovoltaic (PV) Facility (Kudu Solar Facility 2) and associated infrastructure, near De Aar, Northern Cape Province

created_time	msisdn	status	status_text	origin_address	delivered_time	batch_id
2023-01-17 12:51:08.0	[REDACTED]	11	Delivered to phone	[REDACTED]	2023-01-17 12:51:00.0	1625809243
2023-01-17 12:51:08.0	[REDACTED]	11	Delivered to phone	[REDACTED]	2023-01-17 12:51:00.0	1625809243
2023-01-17 12:51:08.0	[REDACTED]	11	Delivered to phone	[REDACTED]	2023-01-17 12:52:00.0	1625809243
2023-01-17 12:51:08.0	[REDACTED]	52	Failed: delivery to network failed	[REDACTED]		1625809243
2023-01-17 12:51:08.0	[REDACTED]	52	Failed: delivery to network failed	[REDACTED]		1625809243
2023-01-17 12:51:08.0	[REDACTED]	52	Failed: delivery to network failed	[REDACTED]		1625809243
2023-01-17 12:51:08.0	[REDACTED]	11	Delivered to phone	[REDACTED]	2023-01-17 12:51:00.0	1625809243
2023-01-17 12:51:08.0	[REDACTED]	11	Delivered to phone	[REDACTED]	2023-01-17 12:51:00.0	1625809243
2023-01-17 12:51:08.0	[REDACTED]	11	Delivered to phone	[REDACTED]	2023-01-17 12:51:00.0	1625809243
2023-01-17 12:51:08.0	[REDACTED]	11	Delivered to phone	[REDACTED]	2023-01-17 12:51:00.0	1625809243
2023-01-17 12:51:08.0	[REDACTED]	11	Delivered to phone	[REDACTED]	2023-01-17 12:51:00.0	1625809243
2023-01-17 12:51:08.0	[REDACTED]	11	Delivered to phone	[REDACTED]	2023-01-17 12:51:00.0	1625809243
2023-01-17 12:51:08.0	[REDACTED]	11	Delivered to phone	[REDACTED]	2023-01-17 14:14:00.0	1625809243
2023-01-17 12:51:08.0	[REDACTED]	11	Delivered to phone	[REDACTED]	2023-01-17 14:14:00.0	1625809243
2023-01-17 12:51:08.0	[REDACTED]	11	Delivered to phone	[REDACTED]	2023-01-17 14:14:00.0	1625809243
2023-01-17 12:51:08.0	[REDACTED]	52	Failed: delivery to network failed	[REDACTED]		1625809243
2023-01-17 12:51:08.0	[REDACTED]	52	Failed: delivery to network failed	[REDACTED]		1625809243
2023-01-17 12:51:08.0	[REDACTED]	52	Failed: delivery to network failed	[REDACTED]		1625809243
2023-01-17 12:51:08.0	[REDACTED]	11	Delivered to phone	[REDACTED]	2023-01-17 12:51:00.0	1625809243
2023-01-17 12:51:08.0	[REDACTED]	11	Delivered to phone	[REDACTED]	2023-01-17 12:51:00.0	1625809243
2023-01-17 12:51:08.0	[REDACTED]	11	Delivered to phone	[REDACTED]	2023-01-17 12:51:00.0	1625809243
2023-01-17 12:51:08.0	[REDACTED]	11	Delivered to phone	[REDACTED]	2023-01-17 12:51:00.0	1625809243
2023-01-17 12:51:08.0	[REDACTED]	11	Delivered to phone	[REDACTED]	2023-01-17 12:51:00.0	1625809243
2023-01-17 12:51:08.0	[REDACTED]	11	Delivered to phone	[REDACTED]	2023-01-17 12:51:00.0	1625809243
2023-01-17 12:51:08.0	[REDACTED]	11	Delivered to phone	[REDACTED]	2023-01-17 12:51:00.0	1625809243
2023-01-17 12:51:08.0	[REDACTED]	11	Delivered to phone	[REDACTED]	2023-01-17 12:51:00.0	1625809243
2023-01-17 12:51:08.0	[REDACTED]	11	Delivered to phone	[REDACTED]	2023-01-17 12:51:00.0	1625809243

APPENDICES

SCOPING REPORT: Scoping and Environmental Impact Assessment (EIA) Process for the Proposed Development of a Solar Photovoltaic (PV) Facility (Kudu Solar Facility 2) and associated infrastructure, near De Aar, Northern Cape Province

created_time	msisdn	status	status_text	origin_address	delivered_time	batch_id
2023-01-17 12:51:08.0	[REDACTED]	11	Delivered to phone	[REDACTED]	2023-01-17 12:51:00.0	1625809243
2023-01-17 12:51:08.0	[REDACTED]	11	Delivered to phone	[REDACTED]	2023-01-17 12:51:00.0	1625809243
2023-01-17 12:51:08.0	[REDACTED]	11	Delivered to phone	[REDACTED]	2023-01-17 12:51:00.0	1625809243
2023-01-17 12:51:08.0	[REDACTED]	11	Delivered to phone	[REDACTED]	2023-01-17 12:51:00.0	1625809243
2023-01-17 12:51:08.0	[REDACTED]	11	Delivered to phone	[REDACTED]	2023-01-17 12:51:00.0	1625809243
2023-01-17 12:51:08.0	[REDACTED]	11	Delivered to phone	[REDACTED]	2023-01-17 12:51:00.0	1625809243
2023-01-17 12:51:08.0	[REDACTED]	11	Delivered to phone	[REDACTED]	2023-01-17 12:51:00.0	1625809243
2023-01-17 12:51:08.0	[REDACTED]	11	Delivered to phone	[REDACTED]	2023-01-17 12:51:00.0	1625809243
2023-01-17 12:51:08.0	[REDACTED]	11	Delivered to phone	[REDACTED]	2023-01-17 12:51:00.0	1625809243
2023-01-17 12:51:08.0	[REDACTED]	11	Delivered to phone	[REDACTED]	2023-01-17 12:51:00.0	1625809243
2023-01-17 12:51:08.0	[REDACTED]	11	Delivered to phone	[REDACTED]	2023-01-17 12:51:00.0	1625809243
2023-01-17 12:51:08.0	[REDACTED]	11	Delivered to phone	[REDACTED]	2023-01-17 12:51:00.0	1625809243
2023-01-17 12:51:08.0	[REDACTED]	50	Failed	[REDACTED]	2023-01-19 04:51:00.0	1625809243
2023-01-17 12:51:08.0	[REDACTED]	50	Failed	[REDACTED]	2023-01-18 08:51:00.0	1625809243
2023-01-17 12:51:08.0	[REDACTED]	50	Failed	[REDACTED]	2023-01-18 18:51:00.0	1625809243
2023-01-17 12:51:08.0	[REDACTED]	11	Delivered to phone	[REDACTED]	2023-01-17 12:51:00.0	1625809243
2023-01-17 12:51:08.0	[REDACTED]	11	Delivered to phone	[REDACTED]	2023-01-17 12:51:00.0	1625809243
2023-01-17 12:51:08.0	[REDACTED]	11	Delivered to phone	[REDACTED]	2023-01-17 12:51:00.0	1625809243
2023-01-17 12:51:08.0	[REDACTED]	11	Delivered to phone	[REDACTED]	2023-01-17 12:51:00.0	1625809243
2023-01-17 12:51:08.0	[REDACTED]	11	Delivered to phone	[REDACTED]	2023-01-17 12:51:00.0	1625809243
2023-01-17 12:51:08.0	[REDACTED]	11	Delivered to phone	[REDACTED]	2023-01-17 12:51:00.0	1625809243
2023-01-17 12:51:08.0	[REDACTED]	50	Failed	[REDACTED]	2023-01-18 04:03:00.0	1625809243
2023-01-17 12:51:08.0	[REDACTED]	50	Failed	[REDACTED]	2023-01-17 21:24:00.0	1625809243
2023-01-17 12:51:08.0	[REDACTED]	50	Failed	[REDACTED]	2023-01-17 21:28:00.0	1625809243
2023-01-17 12:51:08.0	[REDACTED]	11	Delivered to phone	[REDACTED]	2023-01-17 12:51:00.0	1625809243
2023-01-17 12:51:08.0	[REDACTED]	11	Delivered to phone	[REDACTED]	2023-01-17 12:51:00.0	1625809243
2023-01-17 12:51:08.0	[REDACTED]	11	Delivered to phone	[REDACTED]	2023-01-17 12:51:00.0	1625809243
2023-01-17 12:51:08.0	[REDACTED]	11	Delivered to phone	[REDACTED]	2023-01-17 12:52:00.0	1625809243
2023-01-17 12:51:08.0	[REDACTED]	11	Delivered to phone	[REDACTED]	2023-01-17 12:51:00.0	1625809243

APPENDICES

SCOPING REPORT: Scoping and Environmental Impact Assessment (EIA) Process for the Proposed Development of a Solar Photovoltaic (PV) Facility (Kudu Solar Facility 2) and associated infrastructure, near De Aar, Northern Cape Province

created_time	msisdn	status	status_text	origin_address	delivered_time	batch_id
2023-01-17 12:51:08.0	[REDACTED]	11	Delivered to phone	[REDACTED]	2023-01-17 12:51:00.0	1625809243
2023-01-17 12:51:08.0	[REDACTED]	10	Delivered upstream	[REDACTED]		1625809243
2023-01-17 12:51:08.0	[REDACTED]	50	Failed	[REDACTED]	2023-01-18 06:56:00.0	1625809243
2023-01-17 12:51:08.0	[REDACTED]	50	Failed	[REDACTED]	2023-01-18 06:56:00.0	1625809243
2023-01-17 12:51:08.0	[REDACTED]	50	Failed	[REDACTED]	2023-01-17 12:51:00.0	1625809243
2023-01-17 12:51:08.0	[REDACTED]	50	Failed	[REDACTED]	2023-01-17 12:51:00.0	1625809243
2023-01-17 12:51:08.0	[REDACTED]	50	Failed	[REDACTED]	2023-01-17 12:51:00.0	1625809243
2023-01-17 12:51:08.0	[REDACTED]	11	Delivered to phone	[REDACTED]	2023-01-17 12:51:00.0	1625809243
2023-01-17 12:51:08.0	[REDACTED]	11	Delivered to phone	[REDACTED]	2023-01-17 12:51:00.0	1625809243
2023-01-17 12:51:08.0	[REDACTED]	11	Delivered to phone	[REDACTED]	2023-01-17 12:51:00.0	1625809243
2023-01-17 12:51:08.0	[REDACTED]	11	Delivered to phone	[REDACTED]	2023-01-17 12:52:00.0	1625809243
2023-01-17 12:51:08.0	[REDACTED]	11	Delivered to phone	[REDACTED]	2023-01-17 12:51:00.0	1625809243
2023-01-17 12:51:08.0	[REDACTED]	11	Delivered to phone	[REDACTED]	2023-01-17 12:51:00.0	1625809243
2023-01-17 12:51:08.0	[REDACTED]	11	Delivered to phone	[REDACTED]	2023-01-17 12:51:00.0	1625809243
2023-01-17 12:51:08.0	[REDACTED]	11	Delivered to phone	[REDACTED]	2023-01-17 12:51:00.0	1625809243
2023-01-17 12:51:08.0	[REDACTED]	11	Delivered to phone	[REDACTED]	2023-01-17 12:51:00.0	1625809243
2023-01-17 12:51:08.0	[REDACTED]	50	Failed	[REDACTED]	2023-01-17 13:06:00.0	1625809243
2023-01-17 12:51:08.0	[REDACTED]	50	Failed	[REDACTED]	2023-01-17 13:06:00.0	1625809243
2023-01-17 12:51:08.0	[REDACTED]	50	Failed	[REDACTED]	2023-01-17 13:06:00.0	1625809243

APPENDICES

SCOPING REPORT: Scoping and Environmental Impact Assessment (EIA) Process for the Proposed Development of a Solar Photovoltaic (PV) Facility (Kudu Solar Facility 2) and associated infrastructure, near De Aar, Northern Cape Province

12. Personalised Reminder Email sent to key I&APs, Stakeholders and Organs of State (as determined by the DFFE) on 24 and 25 January 2023

Personalised Reminder Email Sent to Landowners

From: Helen Antonopoulos
Sent: Tuesday, 24 January 2023 10:13
To: lydiajnel@gmail.com
Cc: Helen Antonopoulos
Subject: Kudu Sonfasiliteite Konsepverslae

Categories: This message has been archived by Retain on January 31 2023 21:17

Goeie môre Mev. Nel

Baie dankie vir vanoggend se vriendelike gesprek!

Soos genoem, die konsepverslae en opsommings kan soos volg verkry word:

- Google Drive: https://bit.ly/KUDU_SOLAR_PV
- Projekwebtuiste: <https://www.csir.co.za/environmental-impact-assessment>

Laat weet asseblief as julle enige vrae of kommentaar het oor die verslae – ons waardeer enige insette. Die kommentaarperiode eindig op 30 Januarie.

Groete
Helen

From: Helen Antonopoulos
Sent: Tuesday, 24 January 2023 11:02
To: charlenejager@yahoo.com
Cc: EMS
Subject: Kudu Sonfasiliteite Konsepverslae Kommentaarperiode

Categories: This message has been archived by Retain on January 31 2023 21:17

Goeie môre

Ek het vroeër vanoggend probeer geskakel i.v.m. die openbare kommentaarperiode vir die Kudu Sonfasiliteite se konsepverslae.

Die WNNR is aangestel as die onafhanklike omgewingskonsultant vir die projekte en ons wil graag vir u herinner dat die kommentaarperiode 30 Januarie 2023 sluit.

Die verslae en opsommings kan soos volg verkry word:

- Google Drive: https://bit.ly/KUDU_SOLAR_PV
- Projekwebtuiste: <https://www.csir.co.za/environmental-impact-assessment>

Laat weet asseblief as u enige vrae of kommentaar het oor die verslae – ons waardeer alle insette. U is meer as welkom on ons telefonies (060 829 0202) of per e-pos te kontak.

Vriendelike groete
Helen

APPENDICES

SCOPING REPORT: Scoping and Environmental Impact Assessment (EIA) Process for the Proposed Development of a Solar Photovoltaic (PV) Facility (Kudu Solar Facility 2) and associated infrastructure, near De Aar, Northern Cape Province

Personalised Reminder Email Sent to the South African Heritage Resource Agency (SAHRA)

From: EMS <ems@csir.co.za>
Sent: Wednesday, 25 January 2023 08:57
To: Natasha Higgitt
Cc: EMS
Subject: RE: Reminder - Availability of Draft Scoping Reports for Comment - Kudu Solar PV - SAHRA
Attachments: RE: Kudu Solar PV Draft Scoping Reports
Categories: This message has been archived by Retain on February 01 2023 19:00

Dear Natasha

I hope that you are well. All the best for 2023. I hope that you had a good break.

I am kindly following up on the Kudu PV Projects, as per our communications last year (copied here).

Please let me know if SAHRA is able to send us comments on the Draft Scoping Reports by 30 Jan 2023?

Thanks for your inputs throughout this process.

Thank you and kind regards,
Rohaida Abed

CSIR Environmental Management Services
E-mail: ems@csir.co.za
Postal Address: P.O. Box 59081, Umbilo, Durban, 4075
Tel: 031 242 2300

APPENDICES

SCOPING REPORT: Scoping and Environmental Impact Assessment (EIA) Process for the Proposed Development of a Solar Photovoltaic (PV) Facility (Kudu Solar Facility 2) and associated infrastructure, near De Aar, Northern Cape Province

Personalised Reminder Email Sent to the Northern Cape Department of Agriculture, Environmental Affairs, Rural Development and Land Reform (NCDAEARDLR)

From: EMS <ems@csir.co.za>
Sent: Wednesday, 25 January 2023 10:07
To: Samantha De la Fontaine; elsabe.dtec; nuys.denc@gmail.com
Cc: EMS
Subject: RE: Reminder - Availability of Draft Scoping Reports for Comment - Kudu Solar PV - NCDAEARDLR Comment

Categories: This message has been archived by Retain on February 01 2023 19:00

Good day Elsabe, Samantha and Natalie

I trust that you are well. The emails below regarding the Draft Scoping Reports for the Kudu Solar Facility 1 to 12 have reference.

Please kindly let us know if the Northern Cape Department of Agriculture, Environmental Affairs, Rural Development and Land Reform has any comments on the projects? If so, are you able to kindly submit these comments by 30 Jan 2023?

In addition, the National Department of Forestry, Fisheries and the Environment (DFFE) is the Competent Authority for the projects, and provided the following comment on the Draft Scoping Reports:

It has been noted that activities 4, 12, 14, 18 and 23 of LN 3 have been applied for, as the "entire study area or a site fall within an Ecological Support Area (ESA) according to the Northern Cape Critical Biodiversity Area (CBA) Map (2016)". Therefore, the CA request the following to be addressed in the final report: You are advised to obtain a written confirmation from the relevant CA that there is an adopted bioregional plan to determine the applicability of the aforesaid activities.

The above listed activities have been included based on the study area and sites falling within an ESA as per the 2016 Northern Cape CBA Map, and therefore potentially triggering the following:

- Critical biodiversity areas as identified in systematic biodiversity plans adopted by the competent authority or in bioregional plans
- Within critical biodiversity areas identified in bioregional plans
- Critical biodiversity areas or ecosystem service areas as identified in systematic biodiversity plans adopted by the competent authority or in bioregional plans
- Critical biodiversity areas as identified in systematic biodiversity plans adopted by the competent authority or in bioregional plans
- Critical biodiversity areas as identified in systematic biodiversity plans adopted by the competent authority or in bioregional plans

Please could you kindly confirm via email if the 2016 Northern Cape CBA maps used would trigger the above listed activities, i.e. would serve as CBAs in 1) systematic biodiversity plans adopted by the competent authority or 2) in bioregional plans?

Please kind provide feedback on the above and if your Department has any comments on the Draft Scoping Reports.

We look forward to your feedback and thank you for your inputs thus far.

Kind Regards,
Rohaida Abed

CSIR Environmental Management Services
E-mail: ems@csir.co.za
Postal Address: P.O. Box 59081, Umbilo, Durban, 4075
Tel: 031 242 2300

APPENDICES

SCOPING REPORT: Scoping and Environmental Impact Assessment (EIA) Process for the Proposed Development of a Solar Photovoltaic (PV) Facility (Kudu Solar Facility 2) and associated infrastructure, near De Aar, Northern Cape Province

Personalised Reminder Email Sent to the Air Traffic and Navigation Services (ATNS)

From: EMS <ems@csir.co.za>
Sent: Wednesday, 25 January 2023 12:32
To: Obstacles@atns.co.za
Cc: EMS
Subject: RE: Reminder - Availability of Draft Scoping Reports for Comment - Kudu Solar PV

Categories: This message has been archived by Retain on February 01 2023 19:00

Good day

I hope this email finds you well.

I am kindly following up on the Kudu PV Projects, as per our communications last year (copied here).

Please let me know if ATNS is able to send us comments on the Draft Scoping Reports by 30 Jan 2023?

Thank you in advance.

Kind regards
Helen Antonopoulos

Personalised Reminder Email Sent to the Civil Aviation Authorities (CAA)

From: EMS <ems@csir.co.za>
Sent: Wednesday, 25 January 2023 12:37
To: BestbierG@caa.co.za; strohl@caa.co.za; MazheteseC@caa.co.za; Masilelas@caa.co.za
Cc: EMS
Subject: RE: Reminder - Availability of Draft Scoping Reports for Comment - Kudu Solar PV

Categories: This message has been archived by Retain on February 01 2023 19:00

Dear All

I hope this email finds you well.

I am kindly following up on the Kudu PV Projects, as per our communications last year (copied here).

Please let me know if the CAA is able to send us comments on the Draft Scoping Reports by 30 Jan 2023?

Thank you in advance.

Kind regards
Helen Antonopoulos

APPENDICES

SCOPING REPORT: Scoping and Environmental Impact Assessment (EIA) Process for the Proposed Development of a Solar Photovoltaic (PV) Facility (Kudu Solar Facility 2) and associated infrastructure, near De Aar, Northern Cape Province

Personalised Reminder Email Sent to AgriSA

From: EMS <ems@csir.co.za>
Sent: Wednesday, 25 January 2023 13:27
To: janse@agrisa.co.za
Cc: EMS
Subject: RE: Reminder - Availability of Draft Scoping Reports for Comment - Kudu Solar PV

Categories: This message has been archived by Retain on February 01 2023 19:00

Good day

I hope this email finds you well.

I am kindly following up on the Kudu PV Projects, as per our communications last year (copied here).

Please let me know if AgriSA is able to send us comments on the Draft Scoping Reports by 30 Jan 2023?

Thank you in advance.

Kind regards
Helen Antonopoulos

Personalised Reminder Email Sent to Agri NC

From: EMS <ems@csir.co.za>
Sent: Wednesday, 25 January 2023 13:26
To: ontvangs@agrink.co.za; bestuurder@agrink.co.za
Cc: EMS
Subject: RE: Reminder - Availability of Draft Scoping Reports for Comment - Kudu Solar PV

Categories: This message has been archived by Retain on February 01 2023 19:00

Good day

I hope this email finds you well.

I am kindly following up on the Kudu PV Projects, as per our communications last year (copied here).

Please let me know if Agri NC is able to send us comments on the Draft Scoping Reports by 30 Jan 2023?

Thank you in advance.

Kind regards
Helen Antonopoulos

APPENDICES

SCOPING REPORT: Scoping and Environmental Impact Assessment (EIA) Process for the Proposed Development of a Solar Photovoltaic (PV) Facility (Kudu Solar Facility 2) and associated infrastructure, near De Aar, Northern Cape Province

Personalised Reminder Email Sent to the Endangered Wildlife Trust (EWT)

From: EMS <ems@csir.co.za>
Sent: Wednesday, 25 January 2023 12:41
To: eia@ewt.org.za
Cc: EMS
Subject: RE: Reminder - Availability of Draft Scoping Reports for Comment - Kudu Solar PV

Categories: This message has been archived by Retain on February 01 2023 19:00

Good day

I hope this email finds you well.

I am kindly following up on the Kudu PV Projects, as per our communications last year (copied here).

Please let me know if EWT is able to send us comments on the Draft Scoping Reports by 30 Jan 2023?

Thank you in advance.

Kind regards
Helen Antonopoulos

Personalised Reminder Email Sent to Birdlife SA

From: EMS <ems@csir.co.za>
Sent: Wednesday, 25 January 2023 12:45
To: info@birdlife.org.za; spothil@gmail.com; advocacy@birdlife.org.za; energy@birdlife.org.za
Cc: EMS
Subject: RE: Reminder - Availability of Draft Scoping Reports for Comment - Kudu Solar PV

Categories: This message has been archived by Retain on February 01 2023 19:00

Good day

I hope this email finds you well.

I am kindly following up on the Kudu PV Projects, as per our communications last year (copied here).

Please let me know if Birdlife SA is able to send us comments on the Draft Scoping Reports by 30 Jan 2023?

Thank you in advance.

Kind regards
Helen Antonopoulos

APPENDICES

SCOPING REPORT: Scoping and Environmental Impact Assessment (EIA) Process for the Proposed Development of a Solar Photovoltaic (PV) Facility (Kudu Solar Facility 2) and associated infrastructure, near De Aar, Northern Cape Province

Personalised Reminder Email Sent to Earthlife Africa

From: EMS <ems@csir.co.za>
Sent: Wednesday, 25 January 2023 12:48
To: seccp@earthlife.org.za; mabule@ghouse.org.za
Cc: EMS
Subject: RE: Reminder - Availability of Draft Scoping Reports for Comment - Kudu Solar PV

Categories: This message has been archived by Retain on February 01 2023 19:00

Good day

I hope this email finds you well.

I am kindly following up on the Kudu PV Projects, as per our communications last year (copied here).

Please let me know if Earthlife Africa is able to send us comments on the Draft Scoping Reports by 30 Jan 2023?

Thank you in advance.

Kind regards
Helen Antonopoulos

Personalised Reminder Email Sent to the Wildlife and Environment Society of South Africa Northern Cape

From: EMS <ems@csir.co.za>
Sent: Wednesday, 25 January 2023 12:51
To: wessanc@yahoo.com
Cc: EMS
Subject: RE: Reminder - Availability of Draft Scoping Reports for Comment - Kudu Solar PV

Categories: This message has been archived by Retain on February 01 2023 19:00

Dear Suzanne

I hope this email finds you well.

I am kindly following up on the Kudu PV Projects, as per our communications last year (copied here).

Please let me know if WESSA NC is able to send us comments on the Draft Scoping Reports by 30 Jan 2023?

Thank you in advance.

Kind regards
Helen Antonopoulos

APPENDICES

SCOPING REPORT: Scoping and Environmental Impact Assessment (EIA) Process for the Proposed Development of a Solar Photovoltaic (PV) Facility (Kudu Solar Facility 2) and associated infrastructure, near De Aar, Northern Cape Province

Personalised Reminder Email Sent to the Department of Human Settlement, Water and Sanitation

From: EMS <ems@csir.co.za>
Sent: Wednesday, 25 January 2023 13:09
To: kgapholam@dws.gov.za; MeiM@dwa.gov.za; SchwartzC@dws.gov.za; ranwedzim@dwa.gov.za; CloeteS@dws.gov.za; JansenMe@dws.gov.za
Cc: EMS
Subject: RE: Reminder - Availability of Draft Scoping Reports for Comment - Kudu Solar PV
Categories: This message has been archived by Retain on February 01 2023 19:00

Dear All

I hope this email finds you well.

I am kindly following up on the Kudu PV Projects, as per our communications last year (copied here).

Please let me know if the Department of Human Settlement, Water and Sanitation is able to send us comments on the Draft Scoping Reports by 30 Jan 2023?

Thank you in advance.

Kind regards
Helen Antonopoulos

Personalised Reminder Email Sent to the South African National Defence Force

From: EMS <ems@csir.co.za>
Sent: Wednesday, 25 January 2023 13:22
To: kebasenosi@yahoo.com; zukile.mali@yahoo.com; loydejager@hotmail.com
Cc: EMS
Subject: RE: Availability of Draft Scoping Reports for Comment - Kudu Solar PV
Categories: This message has been archived by Retain on February 01 2023 19:00

Dear All

I hope this email finds you well.

I am kindly following up on the Kudu PV Projects, as per our communications last year (copied here).

Please let me know if the SANDF is able to send us comments on the Draft Scoping Reports by 30 Jan 2023?

Thank you in advance.

Kind regards
Helen Antonopoulos

APPENDICES

SCOPING REPORT: Scoping and Environmental Impact Assessment (EIA) Process for the Proposed Development of a Solar Photovoltaic (PV) Facility (Kudu Solar Facility 2) and associated infrastructure, near De Aar, Northern Cape Province

Personalised Reminder Email Sent to the Pixley Ka Seme District Municipality (PKSDM)

From: EMS <ems@csir.co.za>
Sent: Wednesday, 25 January 2023 14:23
To: dmotaung@pkisd.gov.za; pixley@telkomsa.net; mm@pkisd.gov.za; emoffice@pkisd.gov.za; snkondeshe@pkisd.gov.za; asibeko@pkisd.gov.za; otshékela@pkisd.gov.za; fqumba@pkisd.gov.za; idh@pkisd.gov.za
Cc: EMS
Subject: RE: Reminder - Availability of Draft Scoping Reports for Comment - Kudu Solar PV
Categories: This message has been archived by Retain on February 01 2023 19:00

Dear All

I hope this email finds you well.

I am kindly following up on the Kudu PV Projects, as per our communications last year (copied here).

Please let me know if the Pixley ka Seme District Municipality is able to send us comments on the Draft Scoping Reports by 30 Jan 2023?

Thank you in advance.

Kind regards
Helen Antonopoulos

Personalised Reminder Email Sent to the Renosterberg Local Municipality (RLM)

From: EMS <ems@csir.co.za>
Sent: Wednesday, 25 January 2023 13:48
To: renosterbergmun@xsinet.co.za; veligoodman@gmail.com; xolisam@renosterberg.gov.za; themba@crfund.co.za; garidaseptember120@gmail.com; xolisamathiso95@gmail.com
Cc: EMS
Subject: RE: Reminder - Availability of Draft Scoping Reports for Comment - Kudu Solar PV
Categories: This message has been archived by Retain on February 01 2023 19:00

Dear All

I hope this email finds you well.

I am kindly following up on the Kudu PV Projects, as per our communications last year (copied here).

Please let me know if the Renosterberg Local Municipality is able to send us comments on the Draft Scoping Reports by 30 Jan 2023? We would also greatly appreciate it if you could please provide us with the contact information (name, email address, and cell no.) of the ward councilors, as well as the details of the Rate Payers Association (should such an association be in operation).

Thank you in advance.

Kind regards
Helen Antonopoulos

APPENDICES

SCOPING REPORT: Scoping and Environmental Impact Assessment (EIA) Process for the Proposed Development of a Solar Photovoltaic (PV) Facility (Kudu Solar Facility 2) and associated infrastructure, near De Aar, Northern Cape Province

Personalised Reminder Email Sent to a Renosterberg Local Municipality Councilor

From: EMS
Sent: Wednesday, 25 January 2023 13:42
To: asandrewsamson@gmail.com
Cc: EMS
Subject: RE: Reminder - Availability of Draft Scoping Reports for Comment - Kudu Solar PV

Categories: This message has been archived by Retain on February 01 2023 19:00

Dear Cllr Samson

I hope this email finds you well.

I am kindly following up on the Kudu PV Projects, as per our communications last year (copied here).

Please let me know if you are able to send us comments on the Draft Scoping Reports by 30 Jan 2023? We would also greatly appreciate it if you could please send us the contact information of other ward councilors, as well as the details of the Rate Payers Association (should such an association be in operation).

Thank you in advance.

Kind regards
Helen Antonopoulos

APPENDICES

SCOPING REPORT: Scoping and Environmental Impact Assessment (EIA) Process for the Proposed Development of a Solar Photovoltaic (PV) Facility (Kudu Solar Facility 2) and associated infrastructure, near De Aar, Northern Cape Province

13. Proof of Delivery of Personalised Reminder Email sent to key I&APs, Stakeholders and Organs of State (as determined by the DFFE) on 24 and 25 January 2023

EMS - Delivery Reports						By Date ▾ ↑
From	Subject	Received ▾	Size	Categories	Mention	
postmaster@outlo...	Delivered: RE: Reminder - Availability of Draft Scoping Reports for Comment - Kudu Solar PV <small>You don't often get email from postmaster@outlook.com. Learn why this is important <https://aka.ms/LearnAboutSenderIdentification></small>	Wed 25 Jan 2023 23:12	137 KB	This message has bee...		
	Mail Delivery System Relayed: Reminder - Availability of Draft Scoping Reports for Comment - Kudu Solar PV <small>[You don't often get email from mailer-daemon@pta-smg4.csir.co.za. Learn why this is important at https://aka.ms/LearnAboutSenderIdentification] This is the mail system at host pta-smg4.csir.co.za. Your message was successfully</small>	Wed 25 Jan 2023 14:24	83 KB	This message has bee...		
postmaster@outlo...	Delivered: RE: Reminder - Availability of Draft Scoping Reports for Comment - Kudu Solar PV <small>You don't often get email from postmaster@outlook.com. Learn why this is important <https://aka.ms/LearnAboutSenderIdentification></small>	Wed 25 Jan 2023 14:23	141 KB	This message has bee...		
	Mail Delivery System Relayed: Reminder - Availability of Draft Scoping Reports for Comment - Kudu Solar PV <small>[You don't often get email from mailer-daemon@pta-smg4.csir.co.za. Learn why this is important at https://aka.ms/LearnAboutSenderIdentification] This is the mail system at host pta-smg4.csir.co.za. Your message was successfully</small>	Wed 25 Jan 2023 14:23	83 KB	This message has bee...		
	Mail Delivery System Undeliverable: Reminder - Availability of Draft Scoping Reports for Comment - Kudu Solar PV <small>[You don't often get email from mailer-daemon@pta-smg4.csir.co.za. Learn why this is important at https://aka.ms/LearnAboutSenderIdentification] This is the mail system at host pta-smg4.csir.co.za. I'm sorry to have to inform you</small>	Wed 25 Jan 2023 14:23	36 KB	This message has bee...		
	Mail Delivery System Relayed: Reminder - Availability of Draft Scoping Reports for Comment - Kudu Solar PV - NCDAEAR... <small>This is the mail system at host pta-smg1.csir.co.za. Your message was successfully delivered to the destination(s) listed below. If the message was delivered to mailbox you will receive no further notifications. Otherwise you may still</small>	Wed 25 Jan 2023 14:06	66 KB	This message has bee...		
Microsoft Outlook	Delivered: RE: Reminder - Availability of Draft Scoping Reports for Comment - Kudu Solar PV - NC... <small>Your message has been delivered to the following recipients:</small>	Wed 25 Jan 2023 14:06	101 KB	This message has bee...		
	Mail Delivery System Relayed: Reminder - Availability of Draft Scoping Reports for Comment - Kudu Solar PV <small>[You don't often get email from mailer-daemon@pta-smg4.csir.co.za. Learn why this is important at https://aka.ms/LearnAboutSenderIdentification] This is the mail system at host pta-smg4.csir.co.za. Your message was successfully</small>	Wed 25 Jan 2023 13:48	74 KB	This message has bee...		
	Mail Delivery System Undeliverable: Reminder - Availability of Draft Scoping Reports for Comment - Kudu Solar PV <small>[You don't often get email from mailer-daemon@pta-smg4.csir.co.za. Learn why this is important at https://aka.ms/LearnAboutSenderIdentification] This is the mail system at host pta-smg4.csir.co.za. I'm sorry to have to inform you</small>	Wed 25 Jan 2023 13:48	30 KB	This message has bee...		
Microsoft Outlook	Delivered: RE: Reminder - Availability of Draft Scoping Reports for Comment - Kudu Solar PV <small>Your message has been delivered to the following recipients:</small>	Wed 25 Jan 2023 13:48	89 KB	This message has bee...		
	Mail Delivery System Relayed: Reminder - Availability of Draft Scoping Reports for Comment - Kudu Solar PV <small>This is the mail system at host pta-smg1.csir.co.za. Your message was successfully delivered to the destination(s) listed below. If the message was delivered to mailbox you will receive no further notifications. Otherwise you may still</small>	Wed 25 Jan 2023 13:45	65 KB	This message has bee...		
Microsoft Outlook	Delivered: RE: Reminder - Availability of Draft Scoping Reports for Comment - Kudu Solar PV <small>Your message has been delivered to the following recipients:</small>	Wed 25 Jan 2023 13:42	84 KB	This message has bee...		
postmaster@agrisa...	Delivered: RE: Reminder - Availability of Draft Scoping Reports for Comment - Kudu Solar PV <small>Your message has been delivered to the following recipients:</small>	Wed 25 Jan 2023 13:27	129 KB	This message has bee...		

APPENDICES

SCOPING REPORT: Scoping and Environmental Impact Assessment (EIA) Process for the Proposed Development of a Solar Photovoltaic (PV) Facility (Kudu Solar Facility 2) and associated infrastructure, near De Aar, Northern Cape Province

EMS - Delivery Reports							By Date v ↑
From	Subject	Received	Size	Categories	Mention		
Microsoft Outlook Delivered: RE: Reminder - Availability of Draft Scoping Reports for Comment - Kudu Solar PV <small>Your message has been delivered to the following recipients:</small>		Wed 25 Jan 2023 13:27	83 KB		This message has bee...		
postmaster@agrink... Delivered: RE: Reminder - Availability of Draft Scoping Reports for Comment - Kudu Solar PV <small>You don't often get email from postmaster@agrink.co.za. Learn why this is important <https://aka.ms/LearnAboutSenderIdentification></small>		Wed 25 Jan 2023 13:26	133 KB		This message has bee...		
postmaster@agrink... Delivered: RE: Reminder - Availability of Draft Scoping Reports for Comment - Kudu Solar PV <small>You don't often get email from postmaster@agrink.co.za. Learn why this is important <https://aka.ms/LearnAboutSenderIdentification></small>		Wed 25 Jan 2023 13:26	133 KB		This message has bee...		
Microsoft Outlook Delivered: RE: Reminder - Availability of Draft Scoping Reports for Comment - Kudu Solar PV <small>Your message has been delivered to the following recipients:</small>		Wed 25 Jan 2023 13:26	85 KB		This message has bee...		
postmaster@dws.g... Delivered: RE: Reminder - Availability of Draft Scoping Reports for Comment - Kudu Solar PV <small>You don't often get email from postmaster@dws.gov.za. Learn why this is important <https://aka.ms/LearnAboutSenderIdentification></small>		Wed 25 Jan 2023 13:11	138 KB		This message has bee...		
postmaster@dws.g... Delivered: RE: Reminder - Availability of Draft Scoping Reports for Comment - Kudu Solar PV <small>You don't often get email from postmaster@dws.gov.za. Learn why this is important <https://aka.ms/LearnAboutSenderIdentification></small>		Wed 25 Jan 2023 13:11	138 KB		This message has bee...		
postmaster@dws.g... Delivered: RE: Reminder - Availability of Draft Scoping Reports for Comment - Kudu Solar PV <small>You don't often get email from postmaster@dws.gov.za. Learn why this is important <https://aka.ms/LearnAboutSenderIdentification></small>		Wed 25 Jan 2023 13:11	139 KB		This message has bee...		
postmaster@dws.g... Delivered: RE: Reminder - Availability of Draft Scoping Reports for Comment - Kudu Solar PV <small>You don't often get email from postmaster@dws.gov.za. Learn why this is important <https://aka.ms/LearnAboutSenderIdentification></small>		Wed 25 Jan 2023 13:11	137 KB		This message has bee...		
Microsoft Outlook Delivered: RE: Reminder - Availability of Draft Scoping Reports for Comment - Kudu Solar PV <small>Your message has been delivered to the following recipients:</small>		Wed 25 Jan 2023 13:09	88 KB		This message has bee...		
Mail Delivery System Undeliverable: Reminder - Availability of Draft Scoping Reports for Comment - Kudu Solar PV <small>[You don't often get email from mailer-daemon@pta-smg3.csir.co.za. Learn why this is important at https://aka.ms/LearnAboutSenderIdentification] This is the mail system at host pta-smg3.csir.co.za. I'm sorry to have to inform you</small>		Wed 25 Jan 2023 12:52	30 KB		This message has bee...		
Microsoft Outlook Delivered: RE: Reminder - Availability of Draft Scoping Reports for Comment - Kudu Solar PV <small>Your message has been delivered to the following recipients:</small>		Wed 25 Jan 2023 12:51	83 KB		This message has bee...		
Mail Delivery System Relayed: Reminder - Availability of Draft Scoping Reports for Comment - Kudu Solar PV <small>[You don't often get email from mailer-daemon@pta-smg2.csir.co.za. Learn why this is important at https://aka.ms/LearnAboutSenderIdentification] This is the mail system at host pta-smg2.csir.co.za. Your message was successfully</small>		Wed 25 Jan 2023 12:49	65 KB		This message has bee...		
Mail Delivery System Relayed: Reminder - Availability of Draft Scoping Reports for Comment - Kudu Solar PV <small>[You don't often get email from mailer-daemon@hostserv.co.za. Learn why this is important at https://aka.ms/LearnAboutSenderIdentification]</small>		Wed 25 Jan 2023 12:49	76 KB		This message has bee...		

APPENDICES

SCOPING REPORT: Scoping and Environmental Impact Assessment (EIA) Process for the Proposed Development of a Solar Photovoltaic (PV) Facility (Kudu Solar Facility 2) and associated infrastructure, near De Aar, Northern Cape Province

EMS - Delivery Reports							By Date v ↑			
					From	Subject	Received	Size	Categories	Mention
					Microsoft Outlook	Delivered: RE: Reminder - Availability of Draft Scoping Reports for Comment - Kudu Solar PV Your message has been delivered to the following recipients:	Wed 25 Jan 2023 12:48	84 KB		This message has bee...
					postmaster@birdlif...	Delivered: RE: Reminder - Availability of Draft Scoping Reports for Comment - Kudu Solar PV You don't often get email from postmaster@birdlife.org.za. Learn why this is important <https://aka.ms/LearnAboutSenderIdentification>	Wed 25 Jan 2023 12:46	134 KB		This message has bee...
					postmaster@birdlif...	Delivered: RE: Reminder - Availability of Draft Scoping Reports for Comment - Kudu Solar PV You don't often get email from postmaster@birdlife.org.za. Learn why this is important <https://aka.ms/LearnAboutSenderIdentification>	Wed 25 Jan 2023 12:46	134 KB		This message has bee...
					postmaster@birdlif...	Delivered: RE: Reminder - Availability of Draft Scoping Reports for Comment - Kudu Solar PV You don't often get email from postmaster@birdlife.org.za. Learn why this is important <https://aka.ms/LearnAboutSenderIdentification>	Wed 25 Jan 2023 12:46	134 KB		This message has bee...
					Mail Delivery System Relayed: Reminder - Availability of Draft Scoping Reports for Comment - Kudu Solar PV	[You don't often get email from mailer-daemon@pta-smg4.csir.co.za. Learn why this is important at https://aka.ms/LearnAboutSenderIdentification] This is the mail system at host pta-smg4.csir.co.za. Your message was successfully	Wed 25 Jan 2023 12:46	67 KB		This message has bee...
					Microsoft Outlook	Delivered: RE: Reminder - Availability of Draft Scoping Reports for Comment - Kudu Solar PV Your message has been delivered to the following recipients:	Wed 25 Jan 2023 12:45	86 KB		This message has bee...
					Mail Delivery System Relayed: Reminder - Availability of Draft Scoping Reports for Comment - Kudu Solar PV	This is the mail system at host pta-smg1.csir.co.za. Your message was successfully delivered to the destination(s) listed below. If the message was delivered to mailbox you will receive no further notifications. Otherwise you may still	Wed 25 Jan 2023 12:41	64 KB		This message has bee...
					Microsoft Outlook	Delivered: RE: Reminder - Availability of Draft Scoping Reports for Comment - Kudu Solar PV Your message has been delivered to the following recipients:	Wed 25 Jan 2023 12:41	83 KB		This message has bee...
					Mail Delivery System Relayed: Reminder - Availability of Draft Scoping Reports for Comment - Kudu Solar PV	This is the mail system at host pta-smg1.csir.co.za. Your message was successfully delivered to the destination(s) listed below. If the message was delivered to mailbox you will receive no further notifications. Otherwise you may still	Wed 25 Jan 2023 12:37	71 KB		This message has bee...
					Microsoft Outlook	Delivered: RE: Reminder - Availability of Draft Scoping Reports for Comment - Kudu Solar PV Your message has been delivered to the following recipients:	Wed 25 Jan 2023 12:37	86 KB		This message has bee...
					Microsoft Outlook	Delivered: RE: Reminder - Availability of Draft Scoping Reports for Comment - Kudu Solar PV Your message has been delivered to the following recipients:	Wed 25 Jan 2023 12:32	83 KB		This message has bee...
					Mail Delivery System Relayed: [CAUTION:EXTERNAL EMAIL] - Reminder - Availability of Draft Scoping Reports for Comm...	[You don't often get email from mailer-daemon@pta-smg3.csir.co.za. Learn why this is important at https://aka.ms/LearnAboutSenderIdentification] This is the mail system at host pta-smg3.csir.co.za. Your message was successfully	Wed 25 Jan 2023 11:29	72 KB		This message has bee...
					Microsoft Outlook	Delivered: RE: [CAUTION:EXTERNAL EMAIL] - Reminder - Availability of Draft Scoping Reports for C... Your message has been delivered to the following recipients:	Wed 25 Jan 2023 11:29	271 KB		This message has bee...
					Mail Delivery System Relayed: Reminder - Availability of Draft Scoping Reports for Comment - Kudu Solar PV - NCDAEAR...	[You don't often get email from mailer-daemon@pta-smg2.csir.co.za. Learn why this is important at https://aka.ms/LearnAboutSenderIdentification] This is the mail system at host pta-smg2.csir.co.za. Your message was successfully	Wed 25 Jan 2023 10:31	77 KB		This message has bee...
					Mail Delivery System Relayed: Reminder - Availability of Draft Scoping Reports for Comment - Kudu Solar PV - NCDAEAR...	[You don't often get email from mailer-daemon@pta-smg2.csir.co.za. Learn why this is important at https://aka.ms/LearnAboutSenderIdentification] This is the mail system at host pta-smg2.csir.co.za. Your message was successfully	Wed 25 Jan 2023 10:31	76 KB		This message has bee...
					Microsoft Outlook	Delivered: RE: Reminder - Availability of Draft Scoping Reports for Comment - Kudu Solar PV - NC... Your message has been delivered to the following recipients:	Wed 25 Jan 2023 10:24	95 KB		This message has bee...

APPENDICES

SCOPING REPORT: Scoping and Environmental Impact Assessment (EIA) Process for the Proposed Development of a Solar Photovoltaic (PV) Facility (Kudu Solar Facility 2) and associated infrastructure, near De Aar, Northern Cape Province

14. Proof of SMS Communication Sent to a Renosterberg Local Municipality Councilor



APPENDICES

SCOPING REPORT: Scoping and Environmental Impact Assessment (EIA) Process for the Proposed Development of a Solar Photovoltaic (PV) Facility (Kudu Solar Facility 2) and associated infrastructure, near De Aar, Northern Cape Province

15. Proof of Communication Attempts with a Stakeholder Regarding the Visual Impacts of the Kudu Solar Facilities on their Farm Portion and Farmstead

Proof of Email Communication Sent on 1 February 2023

From: Helen Antonopoulos
Sent: Wednesday, 01 February 2023 12:37
To: clouw900@gmail.com
Cc: EMS
Subject: Bevestiging van plaasgedeelte i.v.m. die voorgestelde Kudu Sonfasiliteite naby Philipstown en Petrusville

Goeie middag Meneer Louw

Ek het vroeër vandag probeer skakel i.v.m. die voorgestelde Kudu sonplase naby Philipstown en Petrusville.

Die visuele spesialiste het bevestig dat hulle terugvoer gaan lewer op u kommentaar. Ons wil dus graag bevestig of die volgende inligting rakende u grond korrek is op ons databasis, sodat ons die visuele spesialiste kan inlig waar u grond geleë is in verhouding tot die voorgestelde projekte:

- Gedeelte 0 (RES) van Plaas Farm 197 (ook bekend as Vanwyngaardspan)
- SG kode: C0570000000019700000

Ons wil ook graag bevestig of daar 'n plaasopstal op Vanwyngaardspan is?

U is meer as welkom om my te kontak as u enige vrae het. Sien asseblief kontakbesonderhede hieronder.

Baie dankie
Helen Antonopoulos

(Sel: 060 829 0202; E-pos hantonopoulos@csir.co.za)
Get [Outlook for Android](#)

APPENDICES

SCOPING REPORT: Scoping and Environmental Impact Assessment (EIA) Process for the Proposed Development of a Solar Photovoltaic (PV) Facility (Kudu Solar Facility 2) and associated infrastructure, near De Aar, Northern Cape Province

From: EMS <ems@csir.co.za>
Sent: Wednesday, 01 February 2023 12:38
To: Charlie Louw
Cc: EMS
Subject: RE: Comment on the Kudu Solar Facilities

Good day Mr Louw

Thank you for your comments on the Kudu Solar Facilities, it is appreciated.

We will add your comments to the Comments and Responses Report in the Final Scoping Report, and provide responses therein.

Please kindly send us a map or location file of the Vanwyngaardspan, as well as the homestead, if possible?

Thank you and kind regards,
Rohaida Abed

CSIR Environmental Management Services
E-mail: ems@csir.co.za
Postal Address: P.O. Box 59081, Umbilo, Durban, 4075
Tel: 031 242 2300

APPENDICES

SCOPING REPORT: Scoping and Environmental Impact Assessment (EIA) Process for the Proposed Development of a Solar Photovoltaic (PV) Facility (Kudu Solar Facility 2) and associated infrastructure, near De Aar, Northern Cape Province

Proof of Cellular Communication Sent on 2 February 2023



APPENDICES

SCOPING REPORT: Scoping and Environmental Impact Assessment (EIA) Process for the Proposed Development of a Solar Photovoltaic (PV) Facility (Kudu Solar Facility 2) and associated infrastructure, near De Aar, Northern Cape Province

Proof of Telephonic Communication on 3 February 2023

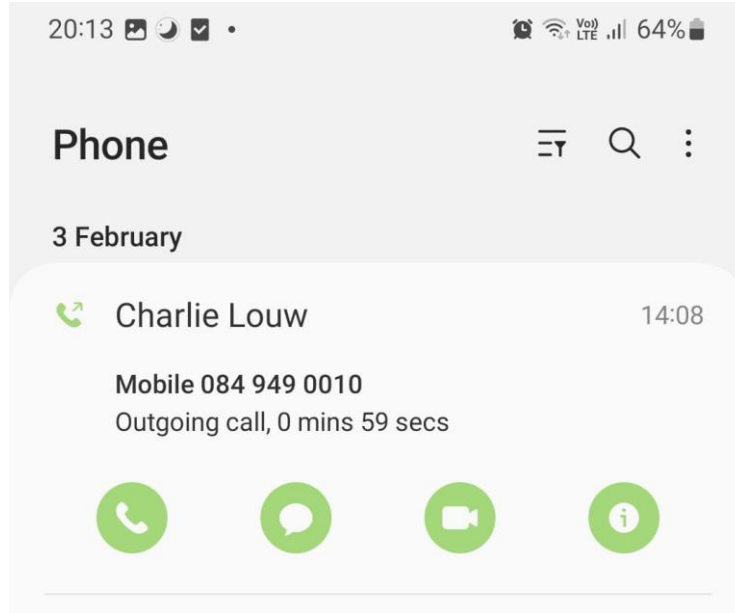

Proof of Cellular Communication Sent on 4 February 2023



APPENDICES

SCOPING REPORT: Scoping and Environmental Impact Assessment (EIA) Process for the Proposed Development of a Solar Photovoltaic (PV) Facility (Kudu Solar Facility 2) and associated infrastructure, near De Aar, Northern Cape Province

16. Read Receipts of All Email Communication to Stakeholders During the DSR Release Phase

EMS - Read Receipts						By Date ▼ ↑
📧	🔔	📄	📧	📧	📧	📧
From	Subject	Received	Size	Categories	Mention	🔍
▼ Two Weeks Ago						
Sharon Steyn <small>Your message</small>	Not read: Reminder - Availability of Draft Scoping Reports for Comment - Kudu Solar PV	Fri 27 Jan 2023 20:13	56 KB		This message has bee...	
Jansen Melinda(UP... <small>Your message</small>	Read: Reminder - Availability of Draft Scoping Reports for Comment - Kudu Solar PV	Fri 27 Jan 2023 09:53	50 KB		This message has bee...	
Jansen Melinda(UP... <small>Your message</small>	Read: Reminder - Availability of Draft Scoping Reports for Comment - Kudu Solar PV	Fri 27 Jan 2023 09:48	50 KB		This message has bee...	
dmotaung@pksgdm... <small>[The e-mail server of the sender could not be verified (SPF Record)] <end></small>	Read: Reminder - Availability of Draft Scoping Reports for Comment - Kudu Solar PV	Fri 27 Jan 2023 09:02	41 KB		This message has bee...	
Sam Ralston <small>[The e-mail server of the sender failed SPF checks and maybe malicious (SPF Record)] Your message</small>	Read: RE: Reminder - Availability of Draft Scoping Reports for Comment - Kudu Solar PV	Thu 26 Jan 2023 15:12	48 KB		This message has bee...	
idh@pksgdm.gov.za <small>[The e-mail server of the sender could not be verified (SPF Record)] <end></small>	Read: Reminder - Availability of Draft Scoping Reports for Comment - Kudu Solar PV	Thu 26 Jan 2023 10:04	41 KB		This message has bee...	
asibeko@pksgdm.g... <small>[You don't often get email from asibeko@pksgdm.gov.za. Learn why this is important at https://aka.ms/LearnAboutSenderIdentification]</small>	Read: Reminder - Availability of Draft Scoping Reports for Comment - Kudu Solar PV	Thu 26 Jan 2023 08:38	42 KB		This message has bee...	
otshekela@pksgdm.... <small>[You don't often get email from otshekela@pksgdm.gov.za. Learn why this is important at https://aka.ms/LearnAboutSenderIdentification]</small>	Read: Reminder - Availability of Draft Scoping Reports for Comment - Kudu Solar PV	Thu 26 Jan 2023 08:17	47 KB		This message has bee...	
emoffice@pksgdm.g... <small>[The e-mail server of the sender could not be verified (SPF Record)] <end></small>	Read: Reminder - Availability of Draft Scoping Reports for Comment - Kudu Solar PV	Thu 26 Jan 2023 07:54	42 KB		This message has bee...	
Sonwabile Nkonde...	Read: Reminder - Availability of Draft Scoping Reports for Comment - Kudu Solar PV	Thu 26 Jan 2023 07:32	36 KB		This message has bee...	
Earthlife Africa JHB <small>[The e-mail server of the sender could not be verified (SPF Record)] Your message</small>	Read: Reminder - Availability of Draft Scoping Reports for Comment - Kudu Solar PV	Wed 25 Jan 2023 14:19	51 KB		This message has bee...	
Bestuurder <small>Your message</small>	Read: Reminder - Availability of Draft Scoping Reports for Comment - Kudu Solar PV	Wed 25 Jan 2023 13:29	49 KB		This message has bee...	
Cloete Shaun <small>You don't often get email from cloetes@dws.gov.za. Learn why this is important <https://aka.ms/LearnAboutSenderIdentification> Your message</small>	Read: Reminder - Availability of Draft Scoping Reports for Comment - Kudu Solar PV	Wed 25 Jan 2023 13:14	51 KB		This message has bee...	

APPENDICES

SCOPING REPORT: Scoping and Environmental Impact Assessment (EIA) Process for the Proposed Development of a Solar Photovoltaic (PV) Facility (Kudu Solar Facility 2) and associated infrastructure, near De Aar, Northern Cape Province

EMS - Read Receipts							By Date v ↑
From	Subject	Received	Size	Categories	Mention		
John Geeringh Your message	Read: [CAUTION:EXTERNAL EMAIL] - Reminder - Availability of Draft Scoping Reports for Comment...	Wed 25 Jan 2023 13:12	52 KB		This message has bee...		
Mmoni Suza [The e-mail server of the sender failed SPF checks and maybe malicious (SPF Record)] Your message	Not read: Availability of Draft Scoping Reports for Comment - Kudu Solar PV	Mon 23 Jan 2023 08:28	39 KB		This message has bee...		
Mmoni Suza Your message	Not read: Reminder - Availability of Draft Scoping Reports for Comment - Kudu Solar PV	Mon 23 Jan 2023 08:28	45 KB		This message has bee...		
Three Weeks Ago							
Nokukhanya Khum... [The e-mail server of the sender failed SPF checks and maybe malicious (SPF Record)] Nokukhanya Khumalo	Read: Reminder - Availability of Draft Scoping Reports for Comment - Kudu Solar PV	Fri 20 Jan 2023 16:28	71 KB		This message has bee...		
Mahlatse Shubane Your message	Not read: Reminder - Availability of Draft Scoping Reports for Comment - Kudu Solar PV	Thu 19 Jan 2023 09:56	47 KB		This message has bee...		
Thivhulawi Nethon... Your message	Read: Reminder - Availability of Draft Scoping Reports for Comment - Kudu Solar PV	Wed 18 Jan 2023 12:07	42 KB		This message has bee...		
Karl Naude Your message	Read: Reminder - Availability of Draft Scoping Reports for Comment - Kudu Solar PV	Wed 18 Jan 2023 11:58	41 KB		This message has bee...		
Mashudu Mudau Your message	Read: Reminder - Availability of Draft Scoping Reports for Comment - Kudu Solar PV	Wed 18 Jan 2023 10:57	41 KB		This message has bee...		
Sonwabile Nkonde... Your message	Read: Reminder - Availability of Draft Scoping Reports for Comment - Kudu Solar PV	Wed 18 Jan 2023 10:48	39 KB		This message has bee...		
dmotaung@pksdm... You don't often get email from dmotaung@pksdm.gov.za. Learn why this is important <https://aka.ms/LearnAboutSenderIdentification>	Read: Reminder - Availability of Draft Scoping Reports for Comment - Kudu Solar PV	Wed 18 Jan 2023 09:40	41 KB		This message has bee...		
Sydney Nkosi You don't often get email from shnkosi@dfe.gov.za. Learn why this is important <https://aka.ms/LearnAboutSenderIdentification>	Read: Reminder - Availability of Draft Scoping Reports for Comment - Kudu Solar PV	Wed 18 Jan 2023 09:17	43 KB		This message has bee...		
Eddie You don't often get email from mhaumann@mweb.co.za. Learn why this is important <https://aka.ms/LearnAboutSenderIdentification>	Read: Reminder - Availability of Draft Scoping Reports for Comment - Kudu Solar PV	Tue 17 Jan 2023 16:03	46 KB		This message has bee...		
rysselboerdery@g... [The e-mail server of the sender could not be verified (SPF Record)] Your message	Read: Reminder - Availability of Draft Scoping Reports for Comment - Kudu Solar PV	Tue 17 Jan 2023 15:45	40 KB		This message has bee...		

APPENDICES

SCOPING REPORT: Scoping and Environmental Impact Assessment (EIA) Process for the Proposed Development of a Solar Photovoltaic (PV) Facility (Kudu Solar Facility 2) and associated infrastructure, near De Aar, Northern Cape Province

EMS - Read Receipts							By Date ▾ ↑			
					From	Subject	Received ▾	Size	Categories	Mention
<input checked="" type="checkbox"/>					Howard Hendricks	Read: Reminder - Availability of Draft Scoping Reports for Comment - Kudu Solar PV <small>[The e-mail server of the sender could not be verified (SPF Record)]</small>	Tue 17 Jan 2023 14:45	43 KB		This message has bee...
<input checked="" type="checkbox"/>					emoffice@pkisd.gov.za	Read: Reminder - Availability of Draft Scoping Reports for Comment - Kudu Solar PV <small>You don't often get email from emoffice@pkisd.gov.za. Learn why this is important <https://aka.ms/LearnAboutSenderIdentification></small>	Tue 17 Jan 2023 14:40	45 KB		This message has bee...
<input checked="" type="checkbox"/>					Flora Mokgohloa	Read: Reminder - Availability of Draft Scoping Reports for Comment - Kudu Solar PV <small>You don't often get email from fmokgohloa@dfe.gov.za. Learn why this is important <https://aka.ms/LearnAboutSenderIdentification></small> Your message	Tue 17 Jan 2023 14:33	43 KB		This message has bee...
<input checked="" type="checkbox"/>					Morgan Griffiths	Read: Reminder - Availability of Draft Scoping Reports for Comment - Kudu Solar PV Your message	Tue 17 Jan 2023 13:17	49 KB		This message has bee...
<input type="checkbox"/>					Henk Kruger (SESSA)	Not read: Reminder - Availability of Draft Scoping Reports for Comment - Kudu Solar PV <small>You don't often get email from treasurer@sessa.org.za. Learn why this is important <https://aka.ms/LearnAboutSenderIdentification></small> Your message	Tue 17 Jan 2023 13:06	42 KB		This message has bee...
<input checked="" type="checkbox"/>					Helen Antonopoulos	Read: Reminder - Availability of Draft Scoping Reports for Comment - Kudu Solar PV Your message	Tue 17 Jan 2023 13:00	21 KB		This message has bee...
<input checked="" type="checkbox"/>					Rofhiwa Magodi	Read: Reminder - Availability of Draft Scoping Reports for Comment - Kudu Solar PV Your message	Tue 17 Jan 2023 12:58	41 KB		This message has bee...
<input type="checkbox"/>					Mitchell Hodgson	Read: Reminder - Availability of Draft Scoping Reports for Comment - Kudu Solar PV <small>You don't often get email from mitchell.hodgson@scatec.com. Learn why this is important <https://aka.ms/LearnAboutSenderIdentification></small> Your message	Tue 17 Jan 2023 12:29	76 KB		This message has bee...
<input type="checkbox"/>					Mitchell Hodgson	Read: Reminder - Availability of Draft Scoping Reports for Comment - Kudu Solar PV <small>You don't often get email from mitchell.hodgson@scatec.com. Learn why this is important <https://aka.ms/LearnAboutSenderIdentification></small> Your message	Tue 17 Jan 2023 12:28	77 KB		This message has bee...
<input checked="" type="checkbox"/>					pixley@albiewireless.co.za	Read: Reminder - Availability of Draft Scoping Reports for Comment - Kudu Solar PV <small>You don't often get email from pixley@albiewireless.co.za. Learn why this is important <https://aka.ms/LearnAboutSenderIdentification></small>	Tue 17 Jan 2023 12:25	45 KB		This message has bee...
<input checked="" type="checkbox"/>					Earthlife Africa JHB	Read: Reminder - Availability of Draft Scoping Reports for Comment - Kudu Solar PV <small>You don't often get email from seccp@earthlife.org.za. Learn why this is important <https://aka.ms/LearnAboutSenderIdentification></small>	Tue 17 Jan 2023 12:21	44 KB		This message has bee...
<input checked="" type="checkbox"/>					otshekela@pkisd.gov.za	Read: Reminder - Availability of Draft Scoping Reports for Comment - Kudu Solar PV <small>You don't often get email from otshekela@pkisd.gov.za. Learn why this is important <https://aka.ms/LearnAboutSenderIdentification></small>	Tue 17 Jan 2023 12:21	41 KB		This message has bee...
<input checked="" type="checkbox"/>					Julliet Mahlangu	Read: Reminder - Availability of Draft Scoping Reports for Comment - Kudu Solar PV Your message	Tue 17 Jan 2023 12:21	41 KB		This message has bee...

APPENDICES

SCOPING REPORT: Scoping and Environmental Impact Assessment (EIA) Process for the Proposed Development of a Solar Photovoltaic (PV) Facility (Kudu Solar Facility 2) and associated infrastructure, near De Aar, Northern Cape Province

EMS - Read Receipts By Date ▼ ↑

		From	Subject	Received	Size	Categories	Mention
		Chris Schutte (CE) Your message	Read: Reminder - Availability of Draft Scoping Reports for Comment - Kudu Solar PV	Tue 17 Jan 2023 12:17	54 KB	This message has bee...	
		Zama Langa You don't often get email from zlanga@dffe.gov.za. Learn why this is important < https://aka.ms/LearnAboutSenderIdentification > Your message	Read: Reminder - Availability of Draft Scoping Reports for Comment - Kudu Solar PV	Tue 17 Jan 2023 12:11	42 KB	This message has bee...	
▼ Last Month							
		asibeko@pksgdm.g... You don't often get email from asibeko@pksgdm.gov.za. Learn why this is important < https://aka.ms/LearnAboutSenderIdentification >	Read: Availability of Draft Scoping Reports for Comment - Kudu Solar PV	Tue 10 Jan 2023 13:30	49 KB	This message has bee...	
		Mahlatshe Shubane Your message	Read: Availability of Draft Scoping Reports for Comment - Kudu Solar PV	Fri 06 Jan 2023 12:54	46 KB	This message has bee...	
		Sydney Nkosi You don't often get email from shnkosi@dffe.gov.za. Learn why this is important < https://aka.ms/LearnAboutSenderIdentification > Your message	Read: Availability of Draft Scoping Reports for Comment - Kudu Solar PV	Tue 03 Jan 2023 10:44	43 KB	This message has bee...	
▼ Older							
		rysselboerdery@g... [The e-mail server of the sender could not be verified (SPF Record)] Your message	Read: Availability of Draft Scoping Reports for Comment - Kudu Solar PV	Wed 14 Dec 2022 15:16	40 KB	This message has bee...	
		Ludwig & Eileen M... This is a receipt for the email message you sent to	Read: Availability of Draft Scoping Reports for Comment - Kudu Solar PV	Wed 14 Dec 2022 08:26	36 KB	This message has bee...	
		Helen Antonopoulos Your message	Read: Availability of Draft Scoping Reports for Comment - Kudu Solar PV	Tue 13 Dec 2022 08:25	30 KB	This message has bee...	
		Savannah Public Pr... Your message	Read: Availability of Draft Scoping Reports for Comment - Kudu Solar PV	Mon 12 Dec 2022 20:14	41 KB	This message has bee...	
		Rohaida Abed Your message	Read: Availability of Draft Scoping Reports for Comment - Kudu Solar PV	Mon 12 Dec 2022 17:29	21 KB	This message has bee...	
		dmotaung@pksgdm... [The e-mail server of the sender could not be verified (SPF Record)] Your message	Read: Availability of Draft Scoping Reports for Comment - Kudu Solar PV	Mon 12 Dec 2022 16:04	39 KB	This message has bee...	
		Karl Naude Your message	Read: Availability of Draft Scoping Reports for Comment - Kudu Solar PV	Mon 12 Dec 2022 14:47	41 KB	This message has bee...	

APPENDICES

SCOPING REPORT: Scoping and Environmental Impact Assessment (EIA) Process for the Proposed Development of a Solar Photovoltaic (PV) Facility (Kudu Solar Facility 2) and associated infrastructure, near De Aar, Northern Cape Province

EMS - Read Receipts By Date v ↑

		From	Subject	Received v	Size	Categories	Mention
<input checked="" type="checkbox"/>		Thivhulawi Nethon... Your message	Read: Availability of Draft Scoping Reports for Comment - Kudu Solar PV	Mon 12 Dec 2022 14:11	42 KB	This message has bee...	
<input checked="" type="checkbox"/>		Julliet Mahlangu Your message	Read: Availability of Draft Scoping Reports for Comment - Kudu Solar PV	Mon 12 Dec 2022 11:45	41 KB	This message has bee...	
<input checked="" type="checkbox"/>		emoffice@pksgdm.g... You don't often get email from emoffice@pksgdm.gov.za. Learn why this is important <https://aka.ms/LearnAboutSenderIdentification>	Read: Availability of Draft Scoping Reports for Comment - Kudu Solar PV	Mon 12 Dec 2022 11:27	44 KB	This message has bee...	
<input checked="" type="checkbox"/>		Zama Langa You don't often get email from zlanga@dfef.gov.za. Learn why this is important <https://aka.ms/LearnAboutSenderIdentification>	Read: Availability of Draft Scoping Reports for Comment - Kudu Solar PV Your message	Mon 12 Dec 2022 10:12	43 KB	This message has bee...	
<input checked="" type="checkbox"/>		Morgan Griffiths Your message	Read: Availability of Draft Scoping Reports for Comment - Kudu Solar PV	Mon 12 Dec 2022 10:04	49 KB	This message has bee...	
<input checked="" type="checkbox"/>		idh@pksgdm.gov.za You don't often get email from idh@pksgdm.gov.za. Learn why this is important <https://aka.ms/LearnAboutSenderIdentification>	Read: Availability of Draft Scoping Reports for Comment - Kudu Solar PV	Mon 12 Dec 2022 09:22	44 KB	This message has bee...	
<input checked="" type="checkbox"/>		Jansen Melinda(UP... Your message	Read: Availability of Draft Scoping Reports for Comment - Kudu Solar PV	Mon 12 Dec 2022 09:20	50 KB	This message has bee...	
<input checked="" type="checkbox"/>		otshekela@pksgdm.... You don't often get email from otshekela@pksgdm.gov.za. Learn why this is important <https://aka.ms/LearnAboutSenderIdentification>	Read: Availability of Draft Scoping Reports for Comment - Kudu Solar PV	Mon 12 Dec 2022 08:09	41 KB	This message has bee...	
<input checked="" type="checkbox"/>		pixley@albieswirel... You don't often get email from pixley@albieswireless.co.za. Learn why this is important <https://aka.ms/LearnAboutSenderIdentification>	Read: Availability of Draft Scoping Reports for Comment - Kudu Solar PV	Mon 12 Dec 2022 07:12	45 KB	This message has bee...	
<input checked="" type="checkbox"/>		Hannes van Zyl You don't often get email from joren6@adsactive.com. Learn why this is important <https://aka.ms/LearnAboutSenderIdentification>	Read: Availability of Draft Scoping Reports for Comment - Kudu Solar PV Your message	Mon 12 Dec 2022 06:52	41 KB	This message has bee...	
<input type="checkbox"/>		Sharon Steyn Your message	Not read: Availability of Draft Scoping Reports for Comment - Kudu Solar PV	Sun 11 Dec 2022 19:11	56 KB	This message has bee...	
<input type="checkbox"/>		Henk Kruger (SESSA) You don't often get email from treasurer@sessa.org.za. Learn why this is important <https://aka.ms/LearnAboutSenderIdentification>	Not read: Availability of Draft Scoping Reports for Comment - Kudu Solar PV Your message	Sun 11 Dec 2022 18:42	55 KB	This message has bee...	
<input checked="" type="checkbox"/>		Rofhiwa Magodi Your message	Read: Availability of Draft Scoping Reports for Comment - Kudu Solar PV	Sun 11 Dec 2022 17:39	41 KB	This message has bee...	

APPENDICES

SCOPING REPORT: Scoping and Environmental Impact Assessment (EIA) Process for the Proposed Development of a Solar Photovoltaic (PV) Facility (Kudu Solar Facility 2) and associated infrastructure, near De Aar, Northern Cape Province

EMS - Read Receipts						By Date v ↑
From	Subject	Received	Size	Categories	Mention	
Howard Hendricks <small>[The e-mail server of the sender could not be verified (SPF Record)]</small>	Read: Availability of Draft Scoping Reports for Comment - Kudu Solar PV	Sun 11 Dec 2022 12:44	42 KB		This message has bee...	
doornkloofnr@gm... <small>You don't often get email from doornkloofnr@gmail.com. Learn why this is important <https://aka.ms/LearnAboutSenderIdentification></small>	Read: Availability of Draft Scoping Reports for Comment - Kudu Solar PV	Sat 10 Dec 2022 08:10	44 KB		This message has bee...	
quarantine@csir.co... <small>Quarantined spam and bulk messages since Dec 09 15:00 Sophos quarantined the following messages because they appear to be either spam or bulk messages. These messages can contain malicious content. To request a message to be released from quarantine and delivered to you,</small>		Sat 10 Dec 2022 08:01	26 KB		This message has bee...	
Portia Makitla <small>Your message</small>	Read: RE: Availability of Draft Scoping Reports for Comment - Kudu Solar PV	Fri 09 Dec 2022 23:56	40 KB		This message has bee...	
Lucius Moolman <small>You don't often get email from lucius.moolman@sanparks.org. Learn why this is important <https://aka.ms/LearnAboutSenderIdentification></small>	Read: RE: Availability of Draft Scoping Reports for Comment - Kudu Solar PV	Fri 09 Dec 2022 18:12	43 KB		This message has bee...	
Azrah Essop <small>You don't often get email from aessop@dffe.gov.za. Learn why this is important <https://aka.ms/LearnAboutSenderIdentification> Your message</small>	Read: RE: Availability of Draft Scoping Reports for Comment - Kudu Solar PV	Fri 09 Dec 2022 15:57	42 KB		This message has bee...	
Eddie <small>You don't often get email from mhaumann@mweb.co.za. Learn why this is important <https://aka.ms/LearnAboutSenderIdentification> Your message</small>	Read: Availability of Draft Scoping Reports for Comment - Kudu Solar PV	Fri 09 Dec 2022 15:40	46 KB		This message has bee...	
Nokukhanya Khum... <small>[The e-mail server of the sender failed SPF checks and maybe malicious (SPF Record)] Nokukhanya Khumalo</small>	Read: Availability of Draft Scoping Reports for Comment - Kudu Solar PV	Fri 09 Dec 2022 15:32	71 KB		This message has bee...	
Adam Treki <small>You don't often get email from adam.treki@scatec.com. Learn why this is important <https://aka.ms/LearnAboutSenderIdentification> Your message</small>	Read: Availability of Draft Scoping Reports for Comment - Kudu Solar PV	Fri 09 Dec 2022 15:11	79 KB		This message has bee...	
Earthlife Africa JHB <small>You don't often get email from seccp@earthlife.org.za. Learn why this is important <https://aka.ms/LearnAboutSenderIdentification></small>	Read: Availability of Draft Scoping Reports for Comment - Kudu Solar PV	Fri 09 Dec 2022 15:10	47 KB		This message has bee...	
Helen Antonopoulos <small>Your message</small>	Read: Availability of Draft Scoping Reports for Comment - Kudu Solar PV	Fri 09 Dec 2022 15:08	21 KB		This message has bee...	
Natasha Higgitt <small>[The e-mail server of the sender failed SPF checks and maybe malicious (SPF Record)] Natasha Higgitt</small>	Read: Availability of Draft Scoping Reports for Comment - Kudu Solar PV	Fri 09 Dec 2022 15:08	70 KB		This message has bee...	
Rohaida Abed <small>Your message</small>	Read: Availability of Draft Scoping Reports for Comment - Kudu Solar PV	Fri 09 Dec 2022 15:07	21 KB		This message has bee...	

APPENDICES

SCOPING REPORT: Scoping and Environmental Impact Assessment (EIA) Process for the Proposed Development of a Solar Photovoltaic (PV) Facility (Kudu Solar Facility 2) and associated infrastructure, near De Aar, Northern Cape Province

APPENDIX E.9: PROOF OF SUBMISSION OF THE DSR AND APPLICATION FORM TO THE DFFE

App. E.9/...

APPENDICES

SCOPING REPORT: Scoping and Environmental Impact Assessment (EIA) Process for the Proposed Development of a Solar Photovoltaic (PV) Facility (Kudu Solar Facility 2) and associated infrastructure, near De Aar, Northern Cape Province

1. Copy of Email sent to the DFFE for Submission of the DSR and Application Form on 9 December 2022

Rohaida Abed

From: Rohaida Abed
Sent: Friday, 09 December 2022 10:53
To: EIA Applications
Cc: Du Toit Malherbe; Petrus Scheepers; Rob Invernizzi; Paul Lochner; Helen Antonopoulos; Constance Musemburi; Makhosi Yeni; Mahlatse Shubane; Olivia Letlalo; Lerato Mokoena; Wayne Hector; Jay-Jay Mpelane; Zama Langa; Nyiko Nkosi; Thembisile Hlatshwayo; Azrah Essop; Julliet Mahlangu
Subject: Submission of EA Application Form and DSR for Comment: Kudu Solar Facility 2
Attachments: 01_Cover Letter_Kudu Solar Facility 2_FINAL.pdf; Document Control Form_Kudu Solar Facility 2.pdf; Proof of Submission_Kudu Solar Facility 2_DSR_App Form.PNG
Categories: This message has been archived by Retain on December 16 2022 20:47

Good day,

SCOPING AND ENVIRONMENTAL IMPACT ASSESSMENT (EIA) PROCESS FOR THE PROPOSED DEVELOPMENT OF A SOLAR PHOTOVOLTAIC (PV) FACILITY (KUDU SOLAR FACILITY 2) AND ASSOCIATED INFRASTRUCTURE, NEAR DE AAR, NORTHERN CAPE PROVINCE

Kindly note that an Application for Environmental Authorisation (EA) and the Draft Scoping Report, inclusive of all supporting appendices, as well as a Cover Letter for the above proposed Kudu Solar Facility 2 project has been uploaded to the Novell S-Filer system.

The Draft Scoping Report for the proposed Kudu Solar Facility 2 project is also being made available to stakeholders and registered Interested and/or Affected Parties (I&APs) for a 30-day comment period extending from **9 December 2022 to 30 January 2023** (excluding the regulated shutdown period).

Please note that a pre-application meeting took place with the Competent Authority, the National Department of Forestry, Fisheries and the Environment (DFFE) on 26 April 2022 (Reference Number: 2022-04-0005), in order to discuss and agree on various aspects with the DFFE prior to release of the Draft Scoping Report. Refer to Appendix 1 of the Application for EA for the proof of such correspondence, as well as Appendix F of the Draft Scoping Report.

The proposed project forms part of a cluster of twelve (12) Solar Facilities (i.e. Kudu Solar Facility 1 to Kudu Solar Facility 12) and are located on adjoining farm portions.

Separate Applications for EA and Draft Scoping Reports for each project have been compiled and are being uploaded to the system in parallel (separate emails are being sent for these).

The relevant DFFE officials have been copied on this email.

This submission is in line with the "Process for Submitting files to the CD IEA_082022" document. To this end, please find attached to this email:

- Cover Letter to DFFE regarding submission of the Draft Scoping Report for the abovementioned project;
- Proof of upload of the Application for EA, Draft Scoping Report and Appendices (i.e. Screenshot of the upload); and
- Document Control Form.

Kindly note that the Cover Letter is also included as part of the zipped folder uploaded.

We trust that you find this submission in order, and we look forward to your feedback.

Please do not hesitate to contact us should you have any queries relating to the above.

Thank you and kind regards,
Rohaida



APPENDICES

SCOPING REPORT: Scoping and Environmental Impact Assessment (EIA) Process for the Proposed Development of a Solar Photovoltaic (PV) Facility (Kudu Solar Facility 2) and associated infrastructure, near De Aar, Northern Cape Province

2. Proof of Upload of the DSR to the DFFE Novell S-File on 9 December 2022

The screenshot displays a web-based file management interface for a Novell S-File. The browser address bar shows the URL: `stiler.environment.gov.za:8443/sssf/a/c/p_name/ss_forum/p_action/1/action/view_permalink/showCollection/-1/entityType/user/entryId/ss_user_id_place_holder/novl_url/1/novl_root/1#16705...`. The interface includes a navigation bar with options like 'My Files', 'Shared with Me', and 'Net Folders'. Below this, a 'My Files' section contains a table of files. The file 'Kudu Solar 2_EA App_Draft Scoping Report.zip' is highlighted with a blue selection bar. The table columns are 'Name', 'Size', and 'Modified'.

Name	Size	Modified
Application for an EA for the Vaal Lodge Development		Nov 30, 2022 8:02 PM
01 Unallocated - PLEASE DO NOT UPLOAD INTO OR DELETE THIS FOLDER		Dec 9, 2022 10:57 AM
00 Allocated - PLEASE DO NOT UPLOAD INTO OR DELETE THIS FOLDER		Dec 9, 2022 10:57 AM
Kudu Solar 1_EA App_Draft Scoping Report.zip	139,340 KB	Dec 9, 2022 9:04 AM
Kudu Solar 2_EA App_Draft Scoping Report.zip	139,731 KB	Dec 9, 2022 10:14 AM
Kudu Solar 3_EA App_Draft Scoping Report.zip	139,879 KB	Dec 9, 2022 10:16 AM

At the bottom of the screenshot, the Windows taskbar is visible, showing the system clock at 10:45 on 09 Dec 2022.

APPENDICES

SCOPING REPORT: Scoping and Environmental Impact Assessment (EIA) Process for the Proposed Development of a Solar Photovoltaic (PV) Facility (Kudu Solar Facility 2) and associated infrastructure, near De Aar, Northern Cape Province

APPENDIX E.10: COMMENTS RECEIVED FROM STAKEHOLDERS DURING THE 30-DAY REVIEW OF THE DSR

App. E.10/...

APPENDICES

SCOPING REPORT: Scoping and Environmental Impact Assessment (EIA) Process for the Proposed Development of a Solar Photovoltaic (PV) Facility (Kudu Solar Facility 2) and associated infrastructure, near De Aar, Northern Cape Province

1. Comments Received from the Department of Forestry, Fisheries and the Environment (DFFE)

1.1 The DFFE Directorate: Integrated Environmental Authorisation: Kudu Solar Facility 2

From: Ephron Maradwa <EMaradwa@dffe.gov.za>
Sent: Friday, 09 December 2022 14:38
To: Rohaida Abed
Cc: Makhosi Yeni; EIAAdmin; Salome Mambane
Subject: 14/12/16/3/3/2/2245

Categories: This message has been archived by Retain on December 16 2022 20:46

Dear Rohaida

14/12/16/3/3/2/2245

ACKNOWLEDGEMENT OF RECEIPT OF THE NEW APPLICATION AND DRAFT SCOPING REPORT FOR ENVIRONMENTAL AUTHORISATION FOLLOWING A SCOPING ASSESSMENT PROCESS FOR THE PROPOSED DEVELOPMENT OF A SOLAR PHOTOVOLTAIC (PV) FACILITY (KUDU SOLAR FACILITY 2) AND ASSOCIATED INFRASTRUCTURE, NEAR DE AAR, NORTHERN CAPE PROVINCE.

The Department confirms having received the Application form and Draft Scoping Report for Environmental Authorisation for the abovementioned project on 09 December 2022. You have submitted these documents to comply with the Environmental Impact Assessment (EIA) Regulations, 2014, as amended.

Kindly note that your application for Environmental Authorisation falls within the ambit of an application applied for in terms of Part 3 of Chapter 4 of the EIA Regulations, 2014, as amended. You are therefore referred to Regulation 21 of the EIA Regulations, 2014 as amended.

Please take note of Regulation 40(3) of the EIA Regulations, 2014, as amended, which states that potential Interested & Affected Parties, including the Competent Authority, may be provided with an opportunity to comment on reports and plans contemplated in Regulation 40(1) of the EIA Regulations, 2014, as amended, prior to the submission of an application but must be provided an opportunity to comment on such reports once an application has been submitted to the Competent Authority.

Note that in terms of Regulation 45 of the EIA Regulations, 2014, as amended, this application will lapse if the applicant fails to meet any of the time-frames prescribed in terms of these Regulations, unless an extension has been granted by the Department in terms of Regulation 3(7) of the EIA Regulations, 2014, as amended.

You are hereby reminded of Section 24F of the National Environmental Management Act, Act No. 107 of 1998, as amended, that no activity may commence prior to an Environmental Authorisation being granted by the Department.

Kindly quote the abovementioned reference number in any future correspondence in respect of the application.

EIA Applications
Integrated Environmental Authorisations
Department of Forestry, Fisheries and the Environment

Please note that this email is for the receipt and processing of online applications only, and is not monitored for responses. All queries must be directed to EIAAdmin@dffe.gov.za.

[You are advised that this mailbox has a 48 hour response time.](#)

Please note that this mailbox has a 5mb mail limit. No zip files are to be attached in any email.

APPENDICES

SCOPING REPORT: Scoping and Environmental Impact Assessment (EIA) Process for the Proposed Development of a Solar Photovoltaic (PV) Facility (Kudu Solar Facility 2) and associated infrastructure, near De Aar, Northern Cape Province

From: Lydia Kutu <LKutu@dffe.gov.za>

Sent: Friday, 20 January 2023 11:29

To: Paul Lochner <PLochner@csir.co.za>; Rohaida Abed <RABed@csir.co.za>; Du Toit Malherbe <du-toit.malherbe@abo-wind.com>; Petrus.Scheepers@abo-wind.com; nuys.denc@gmail.com; elsabe.dtec <elsabe.dtec@gmail.com>; Samantha De la Fontaine <sdelafontaine@gmail.com>

Cc: Makhosi Yeni <MYeni@dffe.gov.za>; EIAAdmin <EIAAdmin@dffe.gov.za>

Subject: 14/12/16/3/3/2/2244 & 2245

You don't often get email from lkutu@dffe.gov.za. [Learn why this is important](#)

Good day.

Please find herein the attached letters for the above mentioned.

Please do not respond to this mailbox with any queries related to the decision been issued. All queries on the attached decision must be directed to official whose contact details is listed as enquiries.

I hope you find all in order.

Thank you.

Kind Regards,
Lydia Kutu
Integrated Environmental Authorisations:
Priority Infrastructure Developments
Tel: (012) 399 9370
Email: LKutu@dffe.gov.za

To God be the Glory!!!

APPENDICES

SCOPING REPORT: Scoping and Environmental Impact Assessment (EIA) Process for the Proposed Development of a Solar Photovoltaic (PV) Facility (Kudu Solar Facility 2) and associated infrastructure, near De Aar, Northern Cape Province



forestry, fisheries & the environment

Department:
Forestry, Fisheries and the Environment
REPUBLIC OF SOUTH AFRICA

Private Bag X 447- PRETORIA 0001- Environment House 473 Steve Biko Road, Arcadia, - PRETORIA

DFFE Reference: 14/12/16/3/3/2/2245

Enquiries: Ms Olivia Letlalo

Telephone: (012) 399 8815 E-mail: oletlalo@dff.gov.za

Mr Paul Lochner
Council for Scientific and Industrial Research (CSIR)
PO Box 320
STELLENBOSCH
7599

Telephone Number: [REDACTED]
Cell phone Number: [REDACTED]
Email Address: PLochner@csir.co.za / RAbed@csir.co.za

PER MAIL / E-MAIL

Dear Mr Paul Lochner

COMMENTS ON THE DRAFT SCOPING REPORT FOR THE PROPOSED KUDU 2 SOLAR FACILITY AND ASSOCIATED INFRASTRUCTURE ON THE REMAINING EXTENT OF THE FARM BAS BERG NO. 88 AND REMAINING EXTENT OF PORTION 3 OF THE FARM BAS BERG NO. 88, NORTH-EAST OF DE AAR IN THE RENOSTERBERG LOCAL MUNICIPALITY AND PIXLEY KA SEME DISTRICT MUNICIPALITY IN THE NORTHERN CAPE PROVINCE

The application for Environmental Authorisation (EA) and draft Scoping Report (SR) dated December 2022 and received by the Competent Authority (CA) on 09 December 2022, refer.

This letter serves to inform you that the following information must be included to the Final SR:

Draft Scoping Report

- It has been noted on the footer of the draft SR that this project is named as "Final Environmental Impact Assessment Report for the proposed construction of Gemsbok Solar PV2 75 MW Solar PV facility on the Remaining Extent of Portion 3 of the Farm Gemsbok Bult 120, Kenhardt, Northern Cape. CSIR Report Number: CSIR/CAS/EMS/ER/2014/0010/B". You are advised to correct this in the final SR.

Listed Activities

- It has been noted that in the description of activity 11, there is a remark that "the applicability of this listed activity will be discussed with the CA during the 30-day comment period, to clarify if the Independent Power Producer (IPP) substation can be included in this EIA application or whether a separate process is required under the EGI Standard". Kindly note that it is the decision of the Applicant when it comes to the infrastructure to be included in this application and ensure applicable listed activity is applied for and Gazette Notice is complied with.
- It has been noted that the words "may and could" have been used in the description of activities 12, 19 and 56 of Listing Notice (LN) 1, activity 15 of LN 2 and activities 12, 14, 18 and 23 of LN 3. Please refrain from using such word/s, since it creates an uncertainty regarding the applicability of the listed activity applied for, for the proposed development.

M

APPENDICES

SCOPING REPORT: Scoping and Environmental Impact Assessment (EIA) Process for the Proposed Development of a Solar Photovoltaic (PV) Facility (Kudu Solar Facility 2) and associated infrastructure, near De Aar, Northern Cape Province

Chief Directorate: Integrated Environmental Authorisations

- Under activity 56 of LN 1, the CA acknowledged that the access roads to be widened or upgraded have been provided, however, it is noted that the length of the aforesaid access roads have not been included in the application form and draft SR to determine the applicability of the abovementioned activity. You are advised to include the relevant details to determine if the said activity is triggered by the proposed development or not.
- It has been noted that activities 4, 12, 18 and 23 of LN 3 have been applied for, as the “**entire study area or the site falls within an Ecological Support Area (ESA) according to the Northern Cape Critical Biodiversity Area (CBA) Map (2016)**”. Therefore, the CA request the following to be addressed in the final report:
 - Please ensure the abovementioned environmental sensitive area i.e., ESA, affect only the site for the proposed development and not the entire study area to determine the applicability of the abovementioned listed activities.
 - You are advised to obtain a written confirmation from the relevant CA that there is an adopted bioregional plan to determine the applicability of the aforesaid activities.
- Please ensure that all relevant listed activities are applied for, are specific and can be linked to the development activity or infrastructure as described in the project description. In addition, the onus is on the applicant and the Environmental Assessment Practitioner (EAP) to ensure that all the applicable listed activities are included in the application and the final SR. Failure to do so may result in unnecessary delays in the processing of the application.
- If the activities applied for in the application form differ from those mentioned in the draft SR, an amended application form must be submitted with the final SR. Please note that the Department’s application form template has been amended and can be downloaded from the following link <https://www.environment.gov.za/documents/forms>.

Screening report

- It has been noted that the screening report for the abovementioned application has been included in the draft SR, however, there is no compiler signature on the aforesaid report. Therefore, you are advised to sign the abovementioned report to be submitted with the final SR.
- In addition, it has been noted that the screening tool report submitted is for the proposed solar facilities 1 to 12 and not specifically for the proposed Kudu 2 solar facility even though the CA refused the request to combine the applications. Therefore, you are advised to only submit the screening tool report for the abovementioned proposed development indicating the relevant environmental sensitivities to be affected by the proposed development.

Alternatives

- The CA acknowledged that alternatives to be considered for the Battery Energy Storage System (BESS) has been provided in the draft SR i.e., Lithium Ion or Redox Flow, which some of the electrolytes i.e., Hydrochloric and Sulphuric Acid for Redox flow could potentially be stored separately in above ground storage tanks on site. You are required to provide details of the all the alternatives considered for this development and indicate the preferred alternatives as per Appendix 2 (2) (1) (g) (i) (v) (vi) of the NEMA EIA Regulations, 2014, as amended in the final report.
- Alternatively, you should submit written proof of an investigation and motivation if no reasonable or feasible alternatives exist in terms of Appendix 2.
- It has been noted on figure 7.2 in the draft SR that there are other similar projects or renewable projects within a 30km radius of the proposed development site, therefore, the cumulative impact assessment for all identified and assessed impacts must be refined to indicate the following:
 - Assess the cumulative impacts of the proposed (not yet authorised), authorised (not yet constructed) and existing solar energy facilities.
 - Detailed process flow and proof must be provided, to indicate how the specialist’s recommendations, mitigation measures and conclusions from the various similar developments in the area were taken into

APPENDICES

SCOPING REPORT: Scoping and Environmental Impact Assessment (EIA) Process for the Proposed Development of a Solar Photovoltaic (PV) Facility (Kudu Solar Facility 2) and associated infrastructure, near De Aar, Northern Cape Province

Chief Directorate: Integrated Environmental Authorisations

consideration in the assessment of cumulative impacts and when the conclusion and mitigation measures were drafted for this project.

- The cumulative impacts significance rating must also inform the need and desirability of the proposed development.
- A cumulative impact environmental statement on whether the proposed development must proceed.

Specialist Assessments

- It has been noted that specialist studies are included in the draft SR as Appendix G, therefore, you are requested to separate the specialist studies as different Appendices for easy review (without missing other studies).
- According to the terrestrial report on page 32, no development should take place within high sensitivity areas or buffer zones i.e., the koppies and watercourse habitats should be avoided. Therefore, you are advised to indicate all sensitive areas on the final development layout plan and its buffers as no-go area in relation to the proposed development.
- It has been mentioned on page 54 of the Animal Compliance Statement that the *Hippotragus niger* (Sable Antelope), which is Provincially Protected and vulnerable has been noted on site. You are advised to indicate the location or habitat area on the final layout plan in which it was located and ensure the buffer zone is provided. In addition, ensure the Provincial CA is informed of this species and comments are provided on how to mitigate impacts on the species and its habitat. Furthermore, it has been indicated that “it is not necessary to include the presence of this species as part of the impact analysis and SEI evaluation, and accordingly a full animal assessment is not required”. Please explain the abovementioned considering that it has been indicated in the report that this species is vulnerable and should be protected.
- The waterbodies i.e., ephemeral streams, wetlands and floodplains considered as no-go areas and provide aquatic habitat to a diverse of faunal species must be mapped and its buffer zones i.e., 50m and 35m be indicated on the layout plan in relation to the proposed development.
- It has been noted that the nearest surrounding farmstead, Vrede, is about 3km away and the “developer has considered such sensitivities and would formulate the revised scoping buildable areas, which will be further assessed during the EIA Phase”. Please ensure this impact is assessed and addressed adequately in the final report.
- In addition to the above, you are hereby drawn to the following:
 - Specialist Declaration of interest forms must be attached for all specialist studies to be conducted in the final SR. The forms are available on Department’s website (please use the Department’s template).
 - Specialist studies to be conducted must provide a detailed description of their methodology, as well as indicate the locations and descriptions of proposed rehabilitation, and all other proposed structures that they have assessed and are recommending for authorisations.
 - The specialist studies must also provide a detailed description of all limitations to their studies. All specialist studies must be conducted in the right season and providing that as a limitation, will not be accepted.
 - Should the appointed specialists specify contradicting recommendations, the EAP must clearly indicate the most reasonable recommendation and substantiate this with defensible reasons; and where necessary, include further expertise advice.
 - Ensure that specialist studies as identified in the screening tool, comply with the requirements of GN 320 of 20 March 2020 and GN 1150 of 30 October 2020, unless proof is provided that indicates that the specialist study was commissioned within 50 days after the date of gazetting of the notice i.e., 20 March 2020 and was commissioned prior to 30 October 2020 respectively. Failure to comply with the abovementioned notices presents a risk to this application.
 - Please note further that the protocols require certain specialists’ to be registered with SACNASP. Refer to the relevant protocols in this regard.
 - Please include a table in the final SR summarising the specialist studies required by the Screening Tool, a column indicating whether these studies will be conducted or not, and a column with motivation for any studies that will not be undertaken. Please note that if any of the specialists’ studies and requirements

DFFE Reference: 14/12/16/3/3/2/2245

3

Comments on the draft Scoping Report for the proposed Kudu 2 solar facility and associated infrastructure on the Remaining Extent of the Farm Bas Berg No. 88 and Remaining Extent of Portion 3 of the Farm Bas Berg No. 88, north-east of the Town of De Aar in the Renosterberg Local Municipality and Pixley ka Seme District Municipality in the Northern Cape Province

M

APPENDICES

SCOPING REPORT: Scoping and Environmental Impact Assessment (EIA) Process for the Proposed Development of a Solar Photovoltaic (PV) Facility (Kudu Solar Facility 2) and associated infrastructure, near De Aar, Northern Cape Province

Chief Directorate: Integrated Environmental Authorisations

recommended in the Department's Screening Tool are not commissioned, motivation for such must be provided in the report, as per the requirements of the Protocols.

- Please also ensure that the final SR includes the **Site Verification Report** as required by the relevant environmental themes and assessments.
- Should it be determined that there is a need for additional specialist studies to be undertaken based on the outcome of public participation, these must be commissioned and be included in the draft EIA reports for public comment.

Layout & Sensitivity Maps

- It has been noted that the draft SR refers to the "original scoping buildable areas" which has been revised, refer to figure 2.1 on page 2-4, however, the maps by the specialist i.e., figure 3.24: habitat and terrestrial species and figure 8 on page 20 of the aquatic and biodiversity study still shows the original buildable area. In addition, the maps included in the draft SR shows the original buildable area while referring to sensitive environment to be affected by the proposed development i.e., figure 3.21: vegetation units and figure 3.29: avifaunal sensitivity zone, **indicate that the revised area is not assessed by the specialist. Therefore, you are advised not to refer to the original buildable area, however, the area considered for the proposed development which will be assessed by all the specialists.**
- Please ensure that the above map has a clear legend that communicate with details of the map.

Generic EMPr

- On page 7-6 of the draft SR, it has been mentioned that "it is understood that the Generic EMPr for the development and expansion of (a) overhead electricity transmission and distribution infrastructure will not apply to any of the proposed projects, as the medium-voltage power lines within the footprint of the Solar PV Facility are planned to be underground and have a capacity of 22 or 33kV". Therefore, the CA would like to advise on the following:
 - Considering that this application is still at an early stage, the Applicant must decide on whether to consider the underground or aboveground powerline and ensure the relevant listed activity with applicable description is applied for or included in the final report.
 - In addition, the on-site substation has been mentioned as part of the infrastructure to form part of the proposed development in activity 11 of LN 1. Therefore, ensure that the generic EMPr that complies with the GN 435 of March 2022 is submitted in the final report.

Public Participation Process

- Please ensure that comments from all relevant stakeholders are submitted to the Department with the final SR. This includes but not limited to the Department of Forestry, Fisheries, and the Environment (DFFE): Protected Areas Planning and Management Effectiveness Directorate, **Biodiversity Planning and Conservation** (BCAdmin@environment.gov.za); Northern Cape Department of Agriculture, Environmental Affairs, Rural Development and Land Reform: Environmental Research and Development (ERD, Telkom, South African Heritage Resources Agency (SAHRA), South African Civil Aviation Authority, Endangered Wildlife Trust, Birdlife South Africa, Department of Human Settlement, Water and Sanitation, South African National Defense Force, Local interest groups, for example: Councillors and Rate Payers associations; Surrounding landowners, Farmer Organisations, Environmental Groups and NGOs; and Grassroots communities and structures as well as the affected district and local municipalities.
- Proof of correspondence with the various stakeholders must be included in the Final SR. Should you be unable to obtain comments, proof must be submitted to the Department of the attempts that were made to obtain comments.
- The Public Participation Process must be conducted in terms of Regulations 39, 40, 41, 42, 43 & 44 of the EIA Regulations 2014, as amended and the approved Public Participation Plan.

APPENDICES

SCOPING REPORT: Scoping and Environmental Impact Assessment (EIA) Process for the Proposed Development of a Solar Photovoltaic (PV) Facility (Kudu Solar Facility 2) and associated infrastructure, near De Aar, Northern Cape Province

Chief Directorate: Integrated Environmental Authorisations

- The comments and response trail report (C&R) must be submitted with the Final SR. The C&R report must incorporate all comments for this development. The C&R report must be a separate document from the main report and the format must be in the table format as indicated in Annexure 1 of this comments letter.
- Please ensure that all issues raised, and comments received during the circulation of the SR from registered I&APs and organs of state which have jurisdiction (including this Department's comments) in respect of the proposed activity are adequately addressed. Comments made by I&APs must be comprehensively captured (copy verbatim if required) and responded to clearly and fully. Please note that a response such as "Noted" is not regarded as an adequate response to I&AP's comments.

Specific comments

- **It has been noted that the reports for Kudu 1, 2 and 3 solar PV facilities as well as specialist studies to be undertaken are the same, therefore, you are advised to ensure each report adequately address relevant issues of concern considering the environmental sensitivity on each site, the activities that will take place and provide relevant mitigation measures in the EIA. In addition, ensure the assessment for the issues of concern comply with the relevant Gazette published by the Minister.**

General

You are further reminded to comply with Regulation 21(1) of the NEMA EIA Regulations 2014, as amended, which states that:

"If S&EIR must be applied to an application, the applicant must, within 44 days of receipt of the application by the competent authority, submit to the competent authority a scoping report which has been subjected to a public participation process of at least 30 days and which reflects the incorporation of comments received, including any comments of the competent authority"

You are further reminded that the final SR to be submitted to this Department must comply with all the requirements in terms of the scope of assessment and content of Scoping reports in accordance with Appendix 2 and Regulation 21(1) of the EIA Regulations 2014, as amended.

Further note that in terms of Regulation 45 of the EIA Regulations 2014, as amended, this application will lapse if the applicant fails to meet any of the timeframes prescribed in terms of these Regulations, unless an extension has been granted in terms of Regulation 3(7).

You are hereby reminded of Section 24F of the National Environmental Management Act, Act No. 107 of 1998, as amended, that no activity may commence prior to an Environmental Authorisation being granted by the Department.

APPENDICES

SCOPING REPORT: Scoping and Environmental Impact Assessment (EIA) Process for the Proposed Development of a Solar Photovoltaic (PV) Facility (Kudu Solar Facility 2) and associated infrastructure, near De Aar, Northern Cape Province

Chief Directorate: Integrated Environmental Authorisations

Yours sincerely



Mr Vusi Skosana

**Acting Chief Director: Integrated Environmental Authorisations
Department of Forestry, Fisheries, and the Environment**

Letter signed by: Mahlatse Shubane

Designation: Acting Deputy Director: Priority Infrastructure Projects

Date: 20 January 2023

cc	Du Toit Malherbe	Kudu Solar Facility 2 (Pty) Ltd	Tel: 021 2763620	Email: Du-Toit.Malherbe@abo-wind.com/ Petrus.Scheepers@abo-wind.com
	Natalie Uys Elsabè Swart Samantha De la Fontaine	Department of Agriculture, Environmental Affairs, Rural Development and Land Reform	Tel: 053 8077300/ 053 807 7474	Email: nuy.s.denc@gmail.com elsabe.dtec@gmail.com sdelafontaine@gmail.com
	Mr Kgabaganyo Matolong (Acting MM), Mr. Fortuin (Municipal Manager), Cllr Andrew Samson; and Mr Mathiso	Renosterberg Local Municipality	Tel: 053 6630041	Email: nuy.s.denc@gmail.com/ elsabe.dtec@gmail.com sdelafontaine@gmail.com

APPENDICES

SCOPING REPORT: Scoping and Environmental Impact Assessment (EIA) Process for the Proposed Development of a Solar Photovoltaic (PV) Facility (Kudu Solar Facility 2) and associated infrastructure, near De Aar, Northern Cape Province

Chief Directorate: Integrated Environmental Authorisations

Annexure 1

Format for Comments and Response Report:

Date of comment, format of comment name of organisation/I&AP,	Comment	Response from EAP/Applicant/Specialist
27/03/2021 Email Department of Forestry, Fisheries and the Environment: Priority Infrastructure Projects (Joe Soap)	Please record C&R trail report in this format. Please update the contact details of the provincial environmental authority.	EAP: (Noted)The C&R trail report has been updated into the desired format, see Appendix K. EAP: Details of provincial authority have been updated, see page 16 of the Application form.

APPENDICES

SCOPING REPORT: Scoping and Environmental Impact Assessment (EIA) Process for the Proposed Development of a Solar Photovoltaic (PV) Facility (Kudu Solar Facility 2) and associated infrastructure, near De Aar, Northern Cape Province

1.2 The DFFE Directorate: Biodiversity Conservation

From: Kamogelo Mathetja <KMathetja@dfffe.gov.za>
Sent: Monday, 12 December 2022 17:05
To: EMS
Cc: Portia Makitla; Mashudu Mudau
Subject: RE: Availability of Draft Scoping Reports for Comment - Kudu Solar PV

Categories: This message has been archived by Retain on December 19 2022 18:52

Dear Sir/Madam

DFFE Directorate: Biodiversity Conservation hereby acknowledge receipt of the invitation to review and comment on the project mentioned on the subject line. Kindly note that the project has been allocated to Mrs P Makitla and Ms M Mudau (Both copied on this email).

Please note: All Public Participation Process documents related to Biodiversity EIA review and any other Biodiversity EIA queries will be submitted to the Directorate: Biodiversity Conservation at Email: BCAdmin@environment.gov.za for attention of Mr Seoka Lekota

Regards,
Kamogelo

APPENDICES

SCOPING REPORT: Scoping and Environmental Impact Assessment (EIA) Process for the Proposed Development of a Solar Photovoltaic (PV) Facility (Kudu Solar Facility 2) and associated infrastructure, near De Aar, Northern Cape Province

From: BC Admin <bcadmin@dfre.gov.za>
Sent: Tuesday, 17 January 2023 15:42
To: EMS
Cc: Kamogelo Mathetja
Subject: RE: Reminder - Availability of Draft Scoping Reports for Comment - Kudu Solar PV

Categories: This message has been archived by Retain on January 24 2023 18:51

Good day Rohaida.

Thank you for the reminder, kindly note the aforementioned project is still under review and we will be providing comments within the legislative timeframe (latest by 30/01/2023).

Thanks & Regards,

Mashudu Mudau

Biodiversity Mainstreaming & EIA
Department of Forestry, Fisheries and the Environment
Environment House
473 Steve Biko and Soutpansberg Streets
PRETORIA
Tel: (012) 399 9945
Cell: [REDACTED]
E-mail: mamudau@dfre.gov.za



APPENDICES

SCOPING REPORT: Scoping and Environmental Impact Assessment (EIA) Process for the Proposed Development of a Solar Photovoltaic (PV) Facility (Kudu Solar Facility 2) and associated infrastructure, near De Aar, Northern Cape Province

From: Portia Makitla <PMakitla@dffe.gov.za>
Sent: Tuesday, 31 January 2023 15:15
To: EMS
Cc: Mashudu Mudau
Subject: Draft Scoping Reports for Comment - Kudu Solar PV
Attachments: Kudu PV 1 DSR Comments_.pdf

Good day

Please find the attached comments for your consideration.

Thanks & Regards 

Ms. Mashienyane Portia Makitla
CBO: Biodiversity Mainstreaming & EIA
Department of Forestry, Fisheries and the Environment
Environment House
473 Steve Biko and Soutpansberg Streets
PRETORIA
Tel: (012) 399 9411
Cell: [REDACTED]
E-mail: pmakitla@dffe.gov.za
Call Centre: 086 111 2468



APPENDICES

SCOPING REPORT: Scoping and Environmental Impact Assessment (EIA) Process for the Proposed Development of a Solar Photovoltaic (PV) Facility (Kudu Solar Facility 2) and associated infrastructure, near De Aar, Northern Cape Province



forestry, fisheries & the environment

Department:
Forestry, Fisheries and the Environment
REPUBLIC OF SOUTH AFRICA

Private Bag X 447, Pretoria, 0001, Environment House, 473 Steve Biko Road, Pretoria, Tel: +27 12 399 9000, Fax: +27 86 625 1042

Reference: Kudu Solar Facilities

Enquiries: Ms. Mashudu Mudau

Telephone: 012 399 9411 E-mail: pmakita@dfpe.gov.za

Rohaida Abed
Exigent Engineering Consultants CC
P.O. Box 59081
Umbilo
DURBAN
4075

Telephone Number: +27 31 242 2300
Email Address: ems@csir.co.za

PER E-MAIL

Dear Sir/Madam

COMMENTS ON THE DRAFT SCOPING REPORT PROPOSED DEVELOPMENT OF THE PROPOSED DEVELOPMENT OF 12 SOLAR PHOTOVOLTAIC (PV) FACILITIES (I.E. KUDU SOLAR FACILITIES) AND VARIOUS ASSOCIATED INFRASTRUCTURE, NEAR DE AAR, NORTHERN CAPE

The Directorate: Biodiversity Conservation has reviewed and evaluated the reports and does not have any objection to the Scoping Report and the Plan of Study, however, must comply with the procedures for the assessment and minimum criteria for reporting on identified environmental themes in terms of sections 24(5)(A) and (H) and 44 of the National Environmental Management Act, 1998.

The final report must comply with all the requirements as outlined in the Environmental Impact Assessment (EIA) guideline for renewable energy projects and the Best Practice Guideline for Birds & Solar Energy for assessing and monitoring the impact of solar energy facilities on birds in Southern Africa.

In conclusion, the Public Participation Process documents related to Biodiversity EIA for review and queries should be submitted to the Directorate: Biodiversity Conservation at Email; BCAdmin@dfpe.gov.za for the attention of Mr. Seoka Lekota.

Yours faithfully

Mr. Seoka Lekota
Control Biodiversity Officer Grade B: Biodiversity Conservation



Batho pele- putting people first.

APPENDICES

SCOPING REPORT: Scoping and Environmental Impact Assessment (EIA) Process for the Proposed Development of a Solar Photovoltaic (PV) Facility (Kudu Solar Facility 2) and associated infrastructure, near De Aar, Northern Cape Province

The Proposed Development Of 12 Solar Photovoltaic (Pv) Facilities (I.E. Kudu Solar Facilities) And Various Associated Infrastructure, Near De Aar, Northern Cape

Department of Forestry, Fisheries & the Environment
Letter signed by: Portia Makitla
Date: 30/01/2023



Batho pele- putting people first.

APPENDICES

SCOPING REPORT: Scoping and Environmental Impact Assessment (EIA) Process for the Proposed Development of a Solar Photovoltaic (PV) Facility (Kudu Solar Facility 2) and associated infrastructure, near De Aar, Northern Cape Province

1.3 The DFFE Directorate: Protected Areas Planning and Management Effectiveness

From: Thivhulawi Nethononda <TNETHONONDA@dffe.gov.za>
Sent: Tuesday, 24 January 2023 09:05
To: EMS
Cc: Karl Naude; Lindokuhle Vilakati
Subject: Comments on the Draft Scoping Reports for Comment - Kudu Solar PV
Attachments: Protected Areas and NPAES.PNG

Categories: This message has been archived by Retain on January 31 2023 21:17

Dear CSIR Team,

The Directorate: Protected Areas Planning and Management Effectiveness, would like to thank you for the opportunity to review the Scoping Report and supporting documents for the proposed development of 12 solar photovoltaic (PV) facilities (i.e., Kudu solar facilities) and various associated infrastructure, near De Aar, Northern Cape.

After conducting the review of the submitted documents, we have noted that the proposed developments will not take place within any kind of protected areas in terms of Section 9 of the National Environmental Management: Protected Areas Act (NEMPAA), Act No. 57 of 2003. Subsequently, this directorate provides comments or input on the projects which are affecting the protected areas.

However, the EAP must consult and get comments (if not yet consulted) from the Biodiversity and Conservation Directorate of the Department of Forestry, Fisheries and the Environment (DFFE) which can be contacted at BCAdmin@environment.gov.za for the attention of Mr. Seoka Lekota. Further, also notify the provincial departments, local municipality, and other associated entities for comments.

Kind Regards,

Thivhulawi

APPENDICES

SCOPING REPORT: Scoping and Environmental Impact Assessment (EIA) Process for the Proposed Development of a Solar Photovoltaic (PV) Facility (Kudu Solar Facility 2) and associated infrastructure, near De Aar, Northern Cape Province

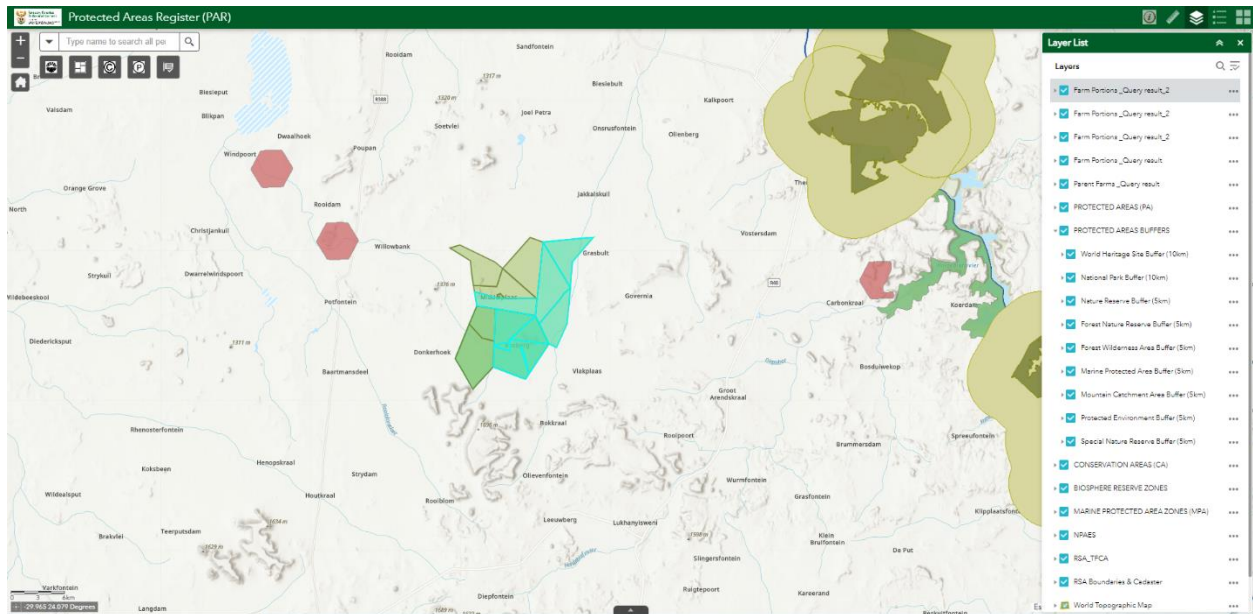

From: Thivhulawi Nethononda <TNETHONONDA@dffe.gov.za>

Sent: Wednesday, 18 January 2023 12:07

To: Lindokuhle Vilakati <LVilakati@dffe.gov.za>

Subject: FW: Reminder - Availability of Draft Scoping Reports for Comment - Kudu Solar PV

Please review the attached documents

APPENDICES

SCOPING REPORT: Scoping and Environmental Impact Assessment (EIA) Process for the Proposed Development of a Solar Photovoltaic (PV) Facility (Kudu Solar Facility 2) and associated infrastructure, near De Aar, Northern Cape Province

2. Comments received from the Northern Cape Department of Agriculture, Environmental Affairs, Rural Development and Land Reform

From: Natalie Uys <nuys.denc@gmail.com>
Sent: Wednesday, 25 January 2023 13:31
To: EMS
Subject: Re: Reminder - Availability of Draft Scoping Reports for Comment - Kudu Solar PV - NCDAEARDLR Comment

Categories: This message has been archived by Retain on February 01 2023 18:59

Good afternoon Rohaida

Thank you for your email. We will reply to your question.
Ito the developments, could you please provide me with the spatial kml/ gis file of the site

From: EMS <ems@csir.co.za>
Date: Wed, 25 Jan 2023 at 14:05
Subject: RE: Reminder - Availability of Draft Scoping Reports for Comment - Kudu Solar PV - NCDAEARDLR Comment
To: Natalie Uys <nuys.denc@gmail.com>
Cc: EMS <ems@csir.co.za>

Dear Natalie

Thanks very much for your reply, it is appreciated.

Please see attached a KMZ of the study area for the 12 Kudu Solar Facilities.

We look forward to your feedback on the query below and whether the Department has any comments.

Thanks and kind regards,

Rohaida

APPENDICES

SCOPING REPORT: Scoping and Environmental Impact Assessment (EIA) Process for the Proposed Development of a Solar Photovoltaic (PV) Facility (Kudu Solar Facility 2) and associated infrastructure, near De Aar, Northern Cape Province

From: Natalie Uys <nuys.denc@gmail.com>
Sent: Thursday, 02 February 2023 08:33
To: EMS
Cc: elsabe.dtec
Subject: Re: Reminder - Availability of Draft Scoping Reports for Comment - Kudu Solar PV - NCDAEARDLR Comment
Attachments: Comments_Kudu_DSR_NU.pdf

Dear Rohida

My sincere apologies for the delay in my reply. I am still catching up on all the work and emails since being back from maternity leave.

Our EO who deals with the Pixley comments has left the department and it is currently just me giving comments on all the developments.

Please find attached general comments for your consideration on the proposed developments

I.t.o. your question regarding the CBA map, the CBA map has been adopted by our department as an environmental tool.

Best regards
Natalie

APPENDICES

SCOPING REPORT: Scoping and Environmental Impact Assessment (EIA) Process for the Proposed Development of a Solar Photovoltaic (PV) Facility (Kudu Solar Facility 2) and associated infrastructure, near De Aar, Northern Cape Province



agriculture, environmental affairs,
rural development and land reform

Department:
agriculture, environmental affairs,
rural development and land reform,
NORTHERN CAPE PROVINCE
REPUBLIC OF SOUTH AFRICA

Environmental Research and Development (ERD)

90 Long Street, Kimberley, Northern Cape, South Africa, 8300, Tel: (053) 807 7300

E-mail: nuys.denc@gmail.com, web: www.agrinc.gov.za

Date:	2 February 2023	File:	
To:	ems@csir.co.za	From:	N Uys
Subject:	Availability of Draft Scoping Reports for Comment - Kudu Solar PV		

Rohaida Abed

CSIR Environmental Management Services

ems@csir.co.za

P.O. Box 59081, Umbilo, Durban, 4075

Tel: 031 242 2300

Fax: 031 261 8172

RE: Availability of Draft Scoping Reports for Comment - Kudu Solar PV

1. Please take note that these are general comments relating to the development footprint. Our capacity is severely limited at this stage to work through all the 12 x Kudu PV draft scoping reports and their appendices. In light of the before mentioned, would it be possible for you to please provide an overview document / presentation from the next phase of the project from results from the EIA studies showing environmental sensitivities and new layouts.
2. Please include Birdlife South Africa and Endangered Wildlife Trust (EWT) in your stakeholder list.
3. I.t.o. the question asked regarding the CBA, the Northern Cape Critical Biodiversity Areas Map has been accepted by the department as an environmental tool. The province currently does not have any bioregional plans.
4. Fauna and flora permits will be needed from the department for handling/ removing/ relocating/ destroying all specially protected and protected flora and fauna. Estimated numbers for species that need to be removed must be provided for permit approval.
5. *Boscia albitrunca* is protected under both the National Forest Act and under the Northern Cape Nature Conservation Act. Estimated densities must be calculated or the actual number of trees to be removed must be provided for permit purposes. Contact person for DFFE Forestry in the Northern Cape is Jacoline Mans, jmans@dffe.gov.za.
6. Please take note that *Olea europaea subsp. africana* is a protected tree under the Northern Cape Nature Conservation Act.
7. Alien and invasive species management must be done throughout the lifetime of the projects. Please take note that cacti species such as *Opuntia* spp cannot dumped at general waste sites without prior treatment (drying/ chemical). Please liaise with Dr Thabiso Mokotjomela, 073 324 6118, mokotjomela@sanbi.org.za, on the management and disposal of cacti .
8. The availability of foundational and baseline data for the Northern Cape is limited and as a result the Screening Tool has limitations and shortcomings when assessing impacts for this area. Proper site surveys are for that reason critically important and always recommended.



APPENDICES

SCOPING REPORT: Scoping and Environmental Impact Assessment (EIA) Process for the Proposed Development of a Solar Photovoltaic (PV) Facility (Kudu Solar Facility 2) and associated infrastructure, near De Aar, Northern Cape Province

9. The initial vegetation map generated for the site reflects the limitations as mentioned before reflecting the gaps in the National Vegetation Map.
10. The 1km around the Verreux eagle nests are questioned in light of the associated power lines that will be constructed for the each of these PV developments. It is recommended that habitat fragmentation must be looked at during the assessment for this species. Verreux eagle habit mapping is also recommended. Please liaise with Birdlife South Africa in this regard, contact person Samantha Ralston-Paton, energy@birdlife.org.za.
11. I.t.o. the terrestrial biodiversity please assess, mitigate and make provision for in the EMPR the following:
 - a. Please take note that tortoise populations are affected by the following:
 - i. electrocutions with electric fences.
 - ii. predations by crows – (relates to waste management).
 - b. Giant bull frogs were found in De Aar area in pans after the recent rains. Most of the injuries and mortalities to this species occurs from collision with vehicles when moving between their breeding sites (pans) and their burrows. Their burrows can range from 200m to 1km from the pans and they are capable of estivating underground for 7 years. Herbicide and pesticide use should also be restricted near the sites (Yetman, undated). Please liaise with EWT in this regard.
 - c. The following are concerns i.t.o. of the cumulative footprint of the 12 x PV's and should be assessed:
 - i. The heat island effect (local warming, impacts on reptiles etc.).
 - ii. Lake effect on birds (mortalities and injuries on birds) as the site is located in an Important Bird Area.
 - iii. Lake effect on insects (e.g. insects have been laying eggs on panels instead of pans).
 - iv. Insect mortalities (security lights at these sites at night attract insects).
 - v. Bat impacts (bats are attracted to by the security lights). Various bat species have been recorded around Vanderkloof and in De Aar.
12. In the EMPR, please make provision for the correct disposal and possible recycling of PV panels during construction, operation and closure phases. There have been cases in the past were broken panels arrived at the construction sites that were illegally disposed at a site in a burrow pit.

Yours sincerely



N UYS

PRODUCTION SCIENTIST GRADE A: BOTANIST

ACTING SCIENTIFIC MANAGER GR B: RESEARCH AND DEVELOPMENT SUPPORT

APPENDICES

SCOPING REPORT: Scoping and Environmental Impact Assessment (EIA) Process for the Proposed Development of a Solar Photovoltaic (PV) Facility (Kudu Solar Facility 2) and associated infrastructure, near De Aar, Northern Cape Province

From: EMS
Sent: Thursday, 02 February 2023 09:06
To: Natalie Uys
Cc: elsabe.dtec; EMS
Subject: RE: Reminder - Availability of Draft Scoping Reports for Comment - Kudu Solar PV - NCDAEARDLR Comment

Hi Natalie

I hope that you are well.

I appreciate your time and inputs into the Kudu DSR considering your work load. Thank you very much.

We will add your comments into the Comments and Responses Report and respond accordingly.

Thanks for your feedback on the legal status of the CBA Map and its implications for Listing Notice 3.

Your comment notes "I.t.o. the question asked regarding the CBA, the Northern Cape Critical Biodiversity Areas Map has been accepted by the department as an environmental tool. The province currently does not have any bioregional plans".

The majority of the activities that we included in the application relate to "systematic biodiversity plans adopted by the competent authority or in bioregional plans".

So now based on your comment, the bioregional plan does not apply. But since the CBA Map has been accepted by the Department, then it would meet the definition below in LN3 regarding systematic biodiversity plans? Is this correct? Therefore, the relevant triggers we have included in LN3 regarding CBAs and ESAs would still apply?

"systematic biodiversity plan" is a plan that identifies important areas for biodiversity conservation, taking into account biodiversity patterns (i.e. the principle of representation) and the ecological and evolutionary processes that sustain them (i.e. the principle of persistence). A systematic biodiversity plan must set quantitative targets/thresholds for aquatic and terrestrial biodiversity features in order to conserve a representative sample of biodiversity pattern and ecological processes;

Apologies for this last query.

We look forward to your feedback.

Kind Regards,
Rohaida

APPENDICES

SCOPING REPORT: Scoping and Environmental Impact Assessment (EIA) Process for the Proposed Development of a Solar Photovoltaic (PV) Facility (Kudu Solar Facility 2) and associated infrastructure, near De Aar, Northern Cape Province

From: Natalie Uys <nuys.denc@gmail.com>
Sent: Friday, 03 February 2023 16:34
To: EMS
Cc: elsabe.dtec
Subject: Feedback: NC CBA map - Systematic biodiversity plan L3

Dear Rohieda

Thank you for the consideration of our comments.

I had to double check our documents and liaise with our biodiversity planner regarding your question, therefore delay in my reply.

You provided the following definition from L3:

"systematic biodiversity plan" is a plan that identifies important areas for biodiversity conservation, taking into account biodiversity patterns (i.e. the principle of representation) and the ecological and evolutionary processes that sustain them (i.e. the principle of persistence). A systematic biodiversity plan must set quantitative targets/thresholds for aquatic and terrestrial biodiversity features in order to conserve a representative sample of biodiversity pattern and ecological processes;"

Our CBA map was signed off by the head of the department as an *"instrument for informing decisions and priorities on biodiversity"*. Based on the above definition of a systematic biodiversity plan, our CBA map meets both the criterias as important biodiversity areas were identified and targets for both terrestrial and freshwater systems were determined (Holness & Oosthuysen, 2016). Thus, the triggers we mentioned for LN3 regarding CBAs and ESAs would still apply.

Best regards
Natalie

Reference:

Holness, S., & Oosthuysen, E. (2016). Critical Biodiversity Areas of the Northern Cape : Technical Report.

APPENDICES

SCOPING REPORT: Scoping and Environmental Impact Assessment (EIA) Process for the Proposed Development of a Solar Photovoltaic (PV) Facility (Kudu Solar Facility 2) and associated infrastructure, near De Aar, Northern Cape Province

3. Comments received from Eskom

From: John Geeringh <GeerinJH@eskom.co.za>

Sent: Tuesday, 17 January 2023 12:45

To: EMS <ems@csir.co.za>

Subject: RE: [CAUTION:EXTERNAL EMAIL] - Reminder - Availability of Draft Scoping Reports for Comment - Kudu Solar PV

Please send me KMZ files of the affected properties, proposed layouts and proposed grid connection. Please find attached Eskom requirements for work at or near Eskom infrastructure and servitudes, as well as a renewable energy setbacks guideline.

Kind regards

John Geeringh (Pr Sci Nat) Reg. EAP (EAPASA)
Senior Consultant Environmental Management
Grid Planning: Land and Rights
Eskom Transmission Division
Megawatt Park, D1Y42, Maxwell Drive, Sunninghill, Sandton.
P O Box 1091, Johannesburg, 2000.
Tel: [REDACTED]
Cell: [REDACTED]
Fax: 086 661 4064
E-mail: john.geeringh@eskom.co.za

APPENDICES

SCOPING REPORT: Scoping and Environmental Impact Assessment (EIA) Process for the Proposed Development of a Solar Photovoltaic (PV) Facility (Kudu Solar Facility 2) and associated infrastructure, near De Aar, Northern Cape Province

TO WHOM IT MAY CONCERN

Eskom requirements for work in or near Eskom servitudes.

1. Eskom's rights and services must be acknowledged and respected at all times.
2. Eskom shall at all times retain unobstructed access to and egress from its servitudes.
3. Eskom's consent does not relieve the developer from obtaining the necessary statutory, land owner or municipal approvals.
4. Any cost incurred by Eskom as a result of non-compliance to any relevant environmental legislation will be charged to the developer.
5. If Eskom has to incur any expenditure in order to comply with statutory clearances or other regulations as a result of the developer's activities or because of the presence of his equipment or installation within the servitude restriction area, the developer shall pay such costs to Eskom on demand.
6. The use of explosives of any type within 500 metres of Eskom's services shall only occur with Eskom's previous written permission. If such permission is granted the developer must give at least fourteen working days prior notice of the commencement of blasting. This allows time for arrangements to be made for supervision and/or precautionary instructions to be issued in terms of the blasting process. It is advisable to make application separately in this regard.
7. Changes in ground level may not infringe statutory ground to conductor clearances or statutory visibility clearances. After any changes in ground level, the surface shall be rehabilitated and stabilised so as to prevent erosion. The measures taken shall be to Eskom's satisfaction.
8. Eskom shall not be liable for the death of or injury to any person or for the loss of or damage to any property whether as a result of the encroachment or of the use of the servitude area by the developer, his/her agent, contractors, employees, successors in title, and assignees. The developer indemnifies Eskom against loss, claims or damages including claims pertaining to consequential damages by third parties and whether as a result of damage to or interruption of or interference with Eskom's services or apparatus or otherwise. Eskom will not be held responsible for damage to the developer's equipment.
9. No mechanical equipment, including mechanical excavators or high lifting machinery, shall be used in the vicinity of Eskom's apparatus and/or services, without prior written permission having been granted by Eskom. If such permission is granted the developer must give at least seven working days' notice prior to the commencement of work. This allows time for arrangements to be made for supervision and/or precautionary instructions to be issued by the relevant Eskom Manager Note: Where and electrical outage is required, at least fourteen work days are required to arrange it.
10. Eskom's rights and duties in the servitude shall be accepted as having prior right at all times and shall not be obstructed or interfered with.

APPENDICES

SCOPING REPORT: Scoping and Environmental Impact Assessment (EIA) Process for the Proposed Development of a Solar Photovoltaic (PV) Facility (Kudu Solar Facility 2) and associated infrastructure, near De Aar, Northern Cape Province

11. Under no circumstances shall rubble, earth or other material be dumped within the servitude restriction area. The developer shall maintain the area concerned to Eskom's satisfaction. The developer shall be liable to Eskom for the cost of any remedial action which has to be carried out by Eskom.
12. The clearances between Eskom's live electrical equipment and the proposed construction work shall be observed as stipulated by *Regulation 15 of the Electrical Machinery Regulations of the Occupational Health and Safety Act, 1993 (Act 85 of 1993)*.
13. Equipment shall be regarded electrically live and therefore dangerous at all times.
14. In spite of the restrictions stipulated by Regulation 15 of the Electrical Machinery Regulations of the Occupational Health and Safety Act, 1993 (Act 85 of 1993), as an additional safety precaution, Eskom will not approve the erection of houses, or structures occupied or frequented by human beings, under the power lines or within the servitude restriction area.
15. Eskom may stipulate any additional requirements to highlight any possible exposure to Customers or Public to coming into contact or be exposed to any dangers of Eskom plant.
16. It is required of the developer to familiarise himself with all safety hazards related to Electrical plant.
17. Any third party servitudes encroaching on Eskom servitudes shall be registered against Eskom's title deed at the developer's own cost. If such a servitude is brought into being, its existence should be endorsed on the Eskom servitude deed concerned, while the third party's servitude deed must also include the rights of the affected Eskom servitude.

John Geeringh (Pr Sci Nat)(EAPASA)
Senior Consultant Environmental Management
Eskom Transmission Division: Land & Rights
Megawatt Park, D1Y42, Maxwell Drive, Sunninghill, Sandton.
P O Box 1091, Johannesburg, 2000.
Tel: [REDACTED]
Cell: [REDACTED]
Fax: 086 661 4064
E-mail: john.geeringh@eskom.co.za

APPENDICES

SCOPING REPORT: Scoping and Environmental Impact Assessment (EIA) Process for the Proposed Development of a Solar Photovoltaic (PV) Facility (Kudu Solar Facility 2) and associated infrastructure, near De Aar, Northern Cape Province

	SCOT	Technology
---	-------------	-------------------

Title: **Renewable Energy Generation Plant Setbacks to Eskom Infrastructure** Unique Identifier: **240-65559775**

Alternative Reference Number: **N/A**

Area of Applicability: **Power Line Engineering**

Documentation Type: **Guideline**

Revision: **2**

Total Pages: **9**

Next Review Date: **N/A**

Disclosure Classification: **CONTROLLED DISCLOSURE**

Compiled by	Approved by	Authorised by
		
J W Chetty Mechanical Engineer	B Ntshuntsha Chief Engineer (Lines)	R A Vajeth Snr Manager (Lines) and SCOT/SC/ Chairperson
Date: 15/09/2020	Date: 30/10/2020	Date: 30/10/2020

APPENDICES

SCOPING REPORT: Scoping and Environmental Impact Assessment (EIA) Process for the Proposed Development of a Solar Photovoltaic (PV) Facility (Kudu Solar Facility 2) and associated infrastructure, near De Aar, Northern Cape Province

Renewable Energy Generation Plant Setbacks to Eskom Infrastructure

Unique Identifier: 240-65559775
Revision: 2
Page: 2 of 9

CONTENTS

	Page
EXECUTIVE SUMMARY	3
1. INTRODUCTION	4
2. SUPPORTING CLAUSES	4
2.1 SCOPE	4
2.1.1 Purpose	5
2.1.2 Applicability	5
2.2 NORMATIVE/INFORMATIVE REFERENCES	5
2.2.1 Normative	5
2.2.2 Informative	5
2.3 DEFINITIONS	6
2.3.1 Disclosure Classification	6
2.4 ABBREVIATIONS	6
2.5 ROLES AND RESPONSIBILITIES	6
2.6 PROCESS FOR MONITORING	6
2.7 RELATED/SUPPORTING DOCUMENTS	6
3. DOCUMENT CONTENT	6
3.1 INTERNATIONAL SETBACK COMPARISON	6
3.2 ESKOM REQUIRED SETBACKS	7
4. AUTHORISATION	9
5. REVISIONS	9
6. DEVELOPMENT TEAM	9

FIGURES

Figure 1: Horizontal Axis Wind Turbine	8
--	---

CONTROLLED DISCLOSURE

When downloaded from the EDMS, this document is uncontrolled and the responsibility rests with the user to ensure it is in line with the authorised version on the system.

APPENDICES

SCOPING REPORT: Scoping and Environmental Impact Assessment (EIA) Process for the Proposed Development of a Solar Photovoltaic (PV) Facility (Kudu Solar Facility 2) and associated infrastructure, near De Aar, Northern Cape Province

Renewable Energy Generation Plant Setbacks to Eskom Infrastructure

Unique Identifier: **240-65559775**
Revision: **2**
Page: **3 of 9**

EXECUTIVE SUMMARY

In recent decades, the use of wind turbines, concentrated solar plants and photovoltaic plants have been on the increase as it serves as an abundant source of energy. This document specifies proposed setbacks for wind turbines and the reasons for these setbacks from infrastructure as well as setbacks for concentrated solar plants and photovoltaic plants. Setbacks for wind turbines employed in other countries were compared and a general setback to be used by Eskom was suggested for use with wind turbines and other renewable energy generation plants.

CONTROLLED DISCLOSURE

When downloaded from the EDMS, this document is uncontrolled and the responsibility rests with the user to ensure it is in line with the authorised version on the system.

APPENDICES

SCOPING REPORT: Scoping and Environmental Impact Assessment (EIA) Process for the Proposed Development of a Solar Photovoltaic (PV) Facility (Kudu Solar Facility 2) and associated infrastructure, near De Aar, Northern Cape Province

Renewable Energy Generation Plant Setbacks to Eskom Infrastructure

Unique Identifier: 240-65559775
Revision: 2
Page: 4 of 9

1. INTRODUCTION

During the last few decades, a large amount of wind turbines have been installed in wind farms to accommodate for the large demand of energy and depleting fossil fuels. Wind is one of the most abundant sources of renewable energy. Wind turbines harness the energy of this renewable resource for integration in electricity networks. The extraction of wind energy is its primary function and thus the aerodynamics of the wind turbine is important. There are many different types of wind turbines which will all exhibit different wind flow characteristics. The most common wind turbine used commercially is the Horizontal Axis Wind Turbine. Wind flow characteristics of this turbine are important to analyse as it may have an effect on surrounding infrastructure.

Wind turbines also cause large turbulence downwind that may affect existing infrastructure. Debris or parts of the turbine blade, in the case of a failure, may be tossed behind the turbine and may lead to damage of infrastructure in the wake path.

This document outlines the minimum distances that need to be introduced between a wind turbine and Eskom infrastructure to ensure that debris and / or turbulence would not negatively impact on the infrastructure and future expansion of infrastructure (lines and substation) as per the long term planning scenario.

Safety distances of wind turbines from other structures as implemented by other countries were also considered and the reasons for their selection were noted. All renewable energy developments are approved by The Department of Environmental Affairs, Forestry and Fisheries (DEFF) in terms of NEMA. The DEFF is aware of the setbacks guideline, however they cannot use it in terms of decision making since the setbacks document has no legal standing in SA and it would be outside of their mandate who have been advised to follow the guidelines herein.

Concentrated solar plants and photovoltaic plants setbacks away from substations were also to be considered to prevent restricting possible power line access routes to the substation and possible expansion of substations.

2. SUPPORTING CLAUSES

2.1 SCOPE

This document provides guidance on the safe distance that a wind turbine should be located from any Eskom power line or substation. Although it is not based on any legislative requirement, it is deemed important that Eskom's infrastructure and future network expansion planning is not impeded. The document specifies proposed setback distances for transmission lines (220 kV to 765 kV), distribution lines

CONTROLLED DISCLOSURE

When downloaded from the EDMS, this document is uncontrolled and the responsibility rests with the user to ensure it is in line with the authorised version on the system.

APPENDICES

SCOPING REPORT: Scoping and Environmental Impact Assessment (EIA) Process for the Proposed Development of a Solar Photovoltaic (PV) Facility (Kudu Solar Facility 2) and associated infrastructure, near De Aar, Northern Cape Province

Renewable Energy Generation Plant Setbacks to Eskom Infrastructure

Unique Identifier: 240-65559775
Revision: 2
Page: 5 of 9

(66 kV to 132 kV) and all Eskom substations. Proposed setbacks for concentrated solar plants and photovoltaic plants are also specified away from substations.

2.1.1 Purpose

Setbacks for wind turbines and power lines / substations are required for various reasons. These include possible catastrophic failure of the turbine blade that may release fragments and which may be thrown onto nearby power lines that may result in damage with associated unplanned outages. Turbulence behind the turbine may affect helicopter flight during routine Eskom live line maintenance and inspections that may lead to safety risk of the aircraft / personnel. Concentrated solar plants and photovoltaic plants setback away from substations were required to prevent substations from being boxed in by these renewable generation plants limiting line route access to the substations and possible future substation expansion.

2.1.2 Applicability

This document is applicable to the siting of all new and existing wind turbines, concentrated solar plants and photovoltaic plants near power lines and substations and in line of site between Eskom telecommunication infrastructure, including future Eskom renewable energy development.

2.2 NORMATIVE/INFORMATIVE REFERENCES

2.2.1 Normative

1. <http://www.envir.ee/orb.aw/class=file/action=preview/id=1170403/Hiumaa+turbulence+impact+EMD.pdf>
2. <http://www.energy.ca.gov/2005publications/CEC-500-2005-184/CEC-500-2005-184.PDF>
3. <http://www.adamscountywind.com/Revised%20Site/Windmills/Adams%20County%20Ordinance/Adams%20County%20Wind%20Ord.htm>
4. http://www.dsireusa.org/incentives/incentive.cfm?Incentive_Code=PA11R&RE=1&EE=1
5. <http://www.wind-watch.org/documents/european-setbacks-minimum-distance-between-wind-turbines-and-habitations/>
6. <http://www.publications.parliament.uk/pa/ld201011/ldbills/017/11017.1-i.html>
7. http://www.caw.ca/assets/pdf/Turbine_Safety_Report.pdf
8. Rogers J, Slegers N, Costello M. (2011) A method for defining wind turbine setback standards. Wind energy 10.1002/we.468

2.2.2 Informative

None

CONTROLLED DISCLOSURE

When downloaded from the EDMS, this document is uncontrolled and the responsibility rests with the user to ensure it is in line with the authorised version on the system.

APPENDICES

SCOPING REPORT: Scoping and Environmental Impact Assessment (EIA) Process for the Proposed Development of a Solar Photovoltaic (PV) Facility (Kudu Solar Facility 2) and associated infrastructure, near De Aar, Northern Cape Province

Renewable Energy Generation Plant Setbacks to Eskom Infrastructure

Unique Identifier: 240-65559775
Revision: 2
Page: 6 of 9

2.3 DEFINITIONS

Definition	Description
Setback	The minimum distance between a wind turbine and boundary line/dwelling/road/infrastructure/servitude etc.
Flicker	Effect caused when rotating wind turbine blades periodically cast shadows
Tip Height	The total height of the wind turbine ie. Hub height plus half rotor diameter (see Figure1)

2.3.1 Disclosure Classification

Controlled disclosure: controlled disclosure to external parties (either enforced by law, or discretionary).

2.4 ABBREVIATIONS

Abbreviation	Description
None	

2.5 ROLES AND RESPONSIBILITIES

All parties involved in the positioning wind turbines, concentrated solar plants and photovoltaic plants near power lines/substations should endeavour to follow the setbacks outlined in this guideline.

2.6 PROCESS FOR MONITORING

Agreement by Eskom in writing on any encroachment of the setbacks distance should be requested via the Grid Access Unit. Eskom should ensure that every application for renewable energy (RE) developments are informed about the existence of the setbacks document early in the RE planning process to ensure maximum effect. This includes Eskom RE development.

2.7 RELATED/SUPPORTING DOCUMENTS

None

3. DOCUMENT CONTENT

3.1 INTERNATIONAL SETBACK COMPARISON

Wind Turbine setbacks employed by various countries were considered. It was found that setbacks were determined for various reasons that include noise, flicker, turbine blade failure and wind effects as well as

CONTROLLED DISCLOSURE

When downloaded from the EDMS, this document is uncontrolled and the responsibility rests with the user to ensure it is in line with the authorised version on the system.

APPENDICES

SCOPING REPORT: Scoping and Environmental Impact Assessment (EIA) Process for the Proposed Development of a Solar Photovoltaic (PV) Facility (Kudu Solar Facility 2) and associated infrastructure, near De Aar, Northern Cape Province

Renewable Energy Generation Plant Setbacks to Eskom Infrastructure

Unique Identifier: 240-65559775
Revision: 2
Page: 7 of 9

future network expansion planning. The distances (setbacks) varied based on these factors and were influenced by the type of infrastructure

Wind turbine setbacks varied for roads, power lines, dwellings, buildings and property and it was noted that the largest setbacks were employed for reasons of noise and flicker related issues [1-7]. Very few countries specified setbacks for power lines.

The literature survey [1-7], yielded information about studies and experiments were conducted to determine the distance that a broken fragment from a wind turbine might be thrown. Even though of low probability of hitting a power line [5.0×10^{-5}]^[8], the distances recorded were significant [750m]^[8]

Wind turbines may also cause changes in wind patterns with turbulent effects behind the hub. These factors influence the wind turbine setbacks specified in this document.

Setbacks were thus introduced to prevent any damage to Eskom infrastructure and impedance to operation and future network expansion planning.

Renewable energy plant can also limit access into substations for power lines of all voltages. A setback distance should therefore be employed to prevent substations from being boxed in by these generation plants and preventing future network expansion. These setback distances are specified in this document.

3.2 ESKOM RECOMMENDED SETBACKS

Any renewable energy applicant should engage with Eskom to determine if their plant layout or positioning of turbines, CSP or PV infrastructure would encroach on the proposed setbacks provided for in this guideline and to ensure that their planning and Eskom's future expansion planning is taken into account. Eskom must inform all renewable energy developers, including Eskom RE, of the existence of the setbacks guideline early in the development process. Should there be an encroachment, a formal request should be sent to and accepted by Eskom in writing if any of the below mentioned setback distances are infringed upon:

- Eskom requests a setback distance of 3 times the tip height of the wind turbine from the edge of the closest Eskom servitude (including vacant servitudes) for transmission lines (220kV to 765kV) and Substations.
- Eskom requests a setback distance of 1 times the tip height of the wind turbine from the edge of the closest Eskom servitude (including vacant servitudes) for distribution lines (66 kV to 132 kV) and Substations.

CONTROLLED DISCLOSURE

When downloaded from the EDMS, this document is uncontrolled and the responsibility rests with the user to ensure it is in line with the authorised version on the system.

APPENDICES

SCOPING REPORT: Scoping and Environmental Impact Assessment (EIA) Process for the Proposed Development of a Solar Photovoltaic (PV) Facility (Kudu Solar Facility 2) and associated infrastructure, near De Aar, Northern Cape Province

Renewable Energy Generation Plant Setbacks to Eskom Infrastructure

Unique Identifier: 240-65559775
Revision: 2
Page: 8 of 9

- A written request should be sent to Eskom via the Grid Access Unit regarding any proposed wind turbine, concentrated solar plants and photovoltaic activity within a 5 km radius of a substation for Eskom to comment on.
- Where concentrated solar plants, photovoltaic structures, battery storage systems (BESS) and other renewable generation plants fall within a 2 km radius of the closest point of a transmission or distribution substation (66kV to 765kV), a written agreement with Eskom is recommended during the planning phase of such plant or structures to ensure Eskom's future planning is not impeded.
- Applicants should not position any wind turbine in the line of site between and two Eskom Radio Telecommunication masts. It should be proven that Eskom radio telecommunication systems (mainly microwave systems) will not be affected in any way by wind turbines due to the criticality of this infrastructure in terms of network operation. Eskom Telecommunications should be engaged on this matter.
- If the position or size of any turbine changes and subsequently infringes on any of the above stated setbacks, a request for relaxation must be sent through to Eskom as per the point mentioned above.

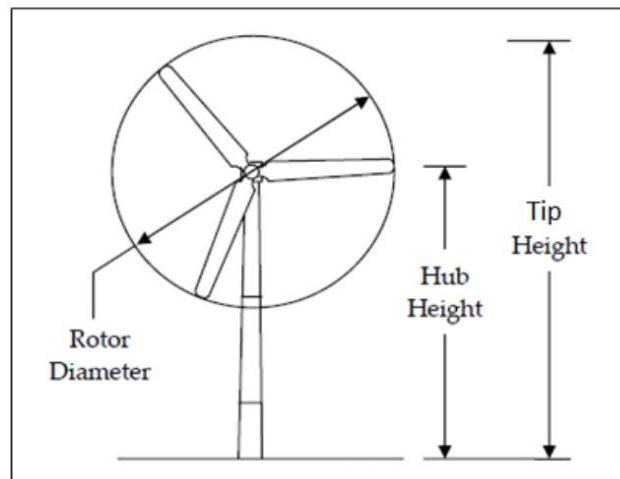

Figure 1: Horizontal Axis Wind Turbine ^[2]

CONTROLLED DISCLOSURE

When downloaded from the EDMS, this document is uncontrolled and the responsibility rests with the user to ensure it is in line with the authorised version on the system.

APPENDICES

SCOPING REPORT: Scoping and Environmental Impact Assessment (EIA) Process for the Proposed Development of a Solar Photovoltaic (PV) Facility (Kudu Solar Facility 2) and associated infrastructure, near De Aar, Northern Cape Province

Renewable Energy Generation Plant Setbacks to Eskom Infrastructure

Unique Identifier: **240-65559775**
Revision: **2**
Page: **9 of 9**

4. AUTHORISATION

This document has been seen and accepted by:

Name & Surname	Designation
V Naidoo	Chief Engineer
Dr P Pretorius	Electrical Specialist
J Geeringh	Snr Consultant Environ Mngt
B Haridass	Snr Consultant Engineer
B Ntshuntsha	Chief Engineer
R Vajeth	Snr Manager (Lines)
D A Tunncliff	Snr Manager L&R (Acting)
B Branfield	Snr Consultant Engineer

5. REVISIONS

Date	Rev.	Compiler	Remarks
November 2013	0	J W Chetty	First Publication - No renewable energy generation plant setback specification in existence.
October 2018	1	JW Chetty	Modification to sub-section 3.2 to provide more clarity for application procedure.
June 2020	2	JW Chetty	Content within the guideline was re-worded to explain the benefits of mutual agreements between the applicants and ESKOM rather than the application being a legal obligation.

6. DEVELOPMENT TEAM

The following people were involved in the development of this document:

Jonathan Chetty (Mechanical Engineer)
Vivendhra Naidoo (Chief Engineer)
Dr Pieter Pretorius (Electrical Specialist)
John Geeringh (Snr Consultant Environ Mngt)
Bharat Haridass (Snr Consultant Engineer)
Riaz Vajeth (Snr Manager (Lines))
Bruce Ntshuntsha (Chief Engineer)
David Tunncliff (Snr Manager L&R Acting)

CONTROLLED DISCLOSURE

When downloaded from the EDMS, this document is uncontrolled and the responsibility rests with the user to ensure it is in line with the authorised version on the system.

APPENDICES

SCOPING REPORT: Scoping and Environmental Impact Assessment (EIA) Process for the Proposed Development of a Solar Photovoltaic (PV) Facility (Kudu Solar Facility 2) and associated infrastructure, near De Aar, Northern Cape Province

From: EMS
Sent: Wednesday, 25 January 2023 11:28
To: John Geeringh
Cc: EMS
Subject: RE: [CAUTION:EXTERNAL EMAIL] - Reminder - Availability of Draft Scoping Reports for Comment - Kudu Solar PV
Attachments: RE: Proposed Kudu PV and EGI Project - Eskom Hydra B Substation; 2022-10-27_Kudu PV1-12.kmz; 2021_11_03_Land_portions.kmz; 2022-11-30_Proposed_EGI Corridor.kml
Categories: This message has been archived by Retain on February 01 2023 19:00

Dear John

I hope that you are well. All the best for 2023.

The Eskom requirements for work at or near Eskom infrastructure and servitudes, as well as a renewable energy setbacks guideline has been forwarded to the Developer for consideration.

Please see attached previous communication we had regarding this project.

Please also see attached the following KMZs:

1. Proposed layouts (revised scoping buildable areas) to be taken into the EIA Phase.
2. Affected properties.
3. Proposed EGI corridors. The EGI corridor will be subjected to separate BA / Standard Registration processes. The Kudu Solar Facilities 1 to 12 are currently being undertaken for now.

Please let us know if you have any feedback on the proposed Hydra B Substation location?

Thanks and kind regards,
Rohaida Abed

CSIR Environmental Management Services
E-mail: ems@csir.co.za
Postal Address: P.O. Box 59081, Umbilo, Durban, 4075
Tel: 031 242 2300

APPENDICES

SCOPING REPORT: Scoping and Environmental Impact Assessment (EIA) Process for the Proposed Development of a Solar Photovoltaic (PV) Facility (Kudu Solar Facility 2) and associated infrastructure, near De Aar, Northern Cape Province

4. Comments received from Telkom: Kudu Solar Facility 2 (Telkom Ref No. CPLT0798-22)

From: Chris Schutte (CE) <SchutCE5@telkom.co.za>
Sent: Monday, 19 December 2022 16:21
To: EMS
Subject: FW: CPLT0798-22 Kudu Solar Facility 2

Categories: This message has been archived by Retain on December 26 2022 19:24

Good day

Hereby do we acknowledge your proposed project.

For future reference please quote CPLT0798-22.

Kind regards

Chris Schutte
Mvelaphande Trading
SchutCE5@telkom.co.za
078 741 5862

==== This e-mail and its contents are subject to the Telkom SA SOC Ltd. E-mail legal notice
<http://www.telkom.co.za/TelkomEMailLegalNotice.PDF> ====

APPENDICES

SCOPING REPORT: Scoping and Environmental Impact Assessment (EIA) Process for the Proposed Development of a Solar Photovoltaic (PV) Facility (Kudu Solar Facility 2) and associated infrastructure, near De Aar, Northern Cape Province

From: Chris Schutte (CE) <SchutCE5@telkom.co.za>
Sent: Monday, 16 January 2023 16:53
To: EMS
Cc: Vivian Groenewald (VR)
Subject: CPLT0798-22 Kudu Solar Facility 2
Attachments: CPLT0798-22 COVER LETTER TO AUTH.pdf; CPLT0798-22 UPDATED SKETCH.pdf

Categories: This message has been archived by Retain on January 23 2023 21:25

Good day

With reference to your above- mentioned application, I hereby confirm that the proposed work installation is approved in terms of Section 29 of the Electronic Communications Act No. 36 of 2005 as amended.

No infrastructure of our Client (Openserve) will be affected by this proposal. **We did our utmost to ensure that we indicate our route as accurate as possible and should you discover any of our cables that is not on the sketch please stop and contact us immediately to arrange a site meeting. In the event that our cables are exposed and damaged/stolen by a third party the damages will be repaired at the customer's account. Please make use of pilot holes in order not too damage our infrastructure.** Therefore any damages occurred during construction of work will be repaired at the customer's account.

Although we are not affected by this proposal, Mr Vivian Groenewald must be contacted at telephone number [REDACTED] from our Network Field Services. Two (2) weeks prior to commencement of proposed work.

Approval of the proposed route is valid for six months. If construction has not yet commenced within this period, then the file must be resubmitted for approval.

Kind regards

Chris Schutte
Mvelaphande Trading
SchutCE5@telkom.co.za
078 741 5862

==== This e-mail and its contents are subject to the Telkom SA SOC Ltd. E-mail legal notice
<http://www.telkom.co.za/TelkomEMailLegalNotice.PDF> =====

APPENDICES

SCOPING REPORT: Scoping and Environmental Impact Assessment (EIA) Process for the Proposed Development of a Solar Photovoltaic (PV) Facility (Kudu Solar Facility 2) and associated infrastructure, near De Aar, Northern Cape Province



Mvelaphande Trading
P/A C Schutte
3 La Motte Street
Bayswater
Bloemfontein
9301

Enquiries: Chris Schutte
Telephone: 078 741 5862
E-mail: Schutce5@telkom.co.za

Our Ref no: CPLT0798-22

Your Ref: **Kudu Solar Facility 2**

16 January 2023

CSIR Environmental Management Services
PO Box 395
Pretoria
0001

FOR ATTENTION: Rohaida Abed

RE: NOTIFICATION OF THE RELEASE OF DRAFT SCOPING REPORTS FOR A 30-DAY COMMENT PERIOD FOR THE PROPOSED DEVELOPMENT OF 12 SOLAR PHOTOVOLTAIC (PV) FACILITIES (I.E. KUDU SOLAR FACILITIES) AND VARIOUS ASSOCIATED INFRASTRUCTURE, NEAR DE AAR, NORTHERN CAPE

With reference to your above- mentioned application, I hereby confirm that the proposed work installation is approved in terms of Section 29 of the Electronic Communications Act No. 36 of 2005 as amended.

No infrastructure of our Client (Openserve) will be affected by this proposal. **We did our utmost to ensure that we indicate our route as accurate as possible and should you discover any of our cables that is not on the sketch please stop and contact us immediately to arrange a site meeting. In the event that our cables are exposed and damaged/stolen by a third party the damages will be repaired at the customer's account. Please make use of pilot holes in order not too damage our infrastructure.** Therefore any damages occurred during construction of work will be repaired at the customer's account.

Although we are not affected by this proposal, Mr Vivian Groenewald must be contacted at telephone number [REDACTED] from our Network Field Services. Two (2) weeks prior to commencement of proposed work.

Approval of the proposed route is valid for six months. If construction has not yet commenced within this period, then the file must be resubmitted for approval.

Any changes/deviations from the original planning during or prior to construction must immediately be communicated to this office.

Mvelaphande Trading Reg No: 2002-029553-23
Members: Bopape P. M ; Makgakge M.G

APPENDICES

SCOPING REPORT: Scoping and Environmental Impact Assessment (EIA) Process for the Proposed Development of a Solar Photovoltaic (PV) Facility (Kudu Solar Facility 2) and associated infrastructure, near De Aar, Northern Cape Province

On completion of this project, please certify that all requirements as stipulated in this letter have been met. Please note that should any of our Client (Openserve) infrastructure has to be relocated or altered as a result of your activities the cost for such alteration or relocation will be for your account in terms of section 25 of the Electronic Communication Act.

Mr Vivian Groenewald must be contacted at telephone number [REDACTED]. Two (2) weeks prior to commencement of proposed work. It's important that all services are shown on site before construction starts.

Approval of the proposed route is valid for six months. If construction has not yet commenced within this period, then the file must be resubmitted for approval. Any changes / deviations from the original planning during or prior to construction must immediately be communicated to this office.

Please notify this office and forward an as built plan, within 30 days of completion of construction.

Mr Vivian Groenewald must be contacted at telephone number 081 362 6738. Two (2) weeks prior to commencement of proposed work. It's important that all services are shown on site before construction starts.

Yours sincerely



CHRIS SCHUTTE

APPENDICES

SCOPING REPORT: Scoping and Environmental Impact Assessment (EIA) Process for the Proposed Development of a Solar Photovoltaic (PV) Facility (Kudu Solar Facility 2) and associated infrastructure, near De Aar, Northern Cape Province

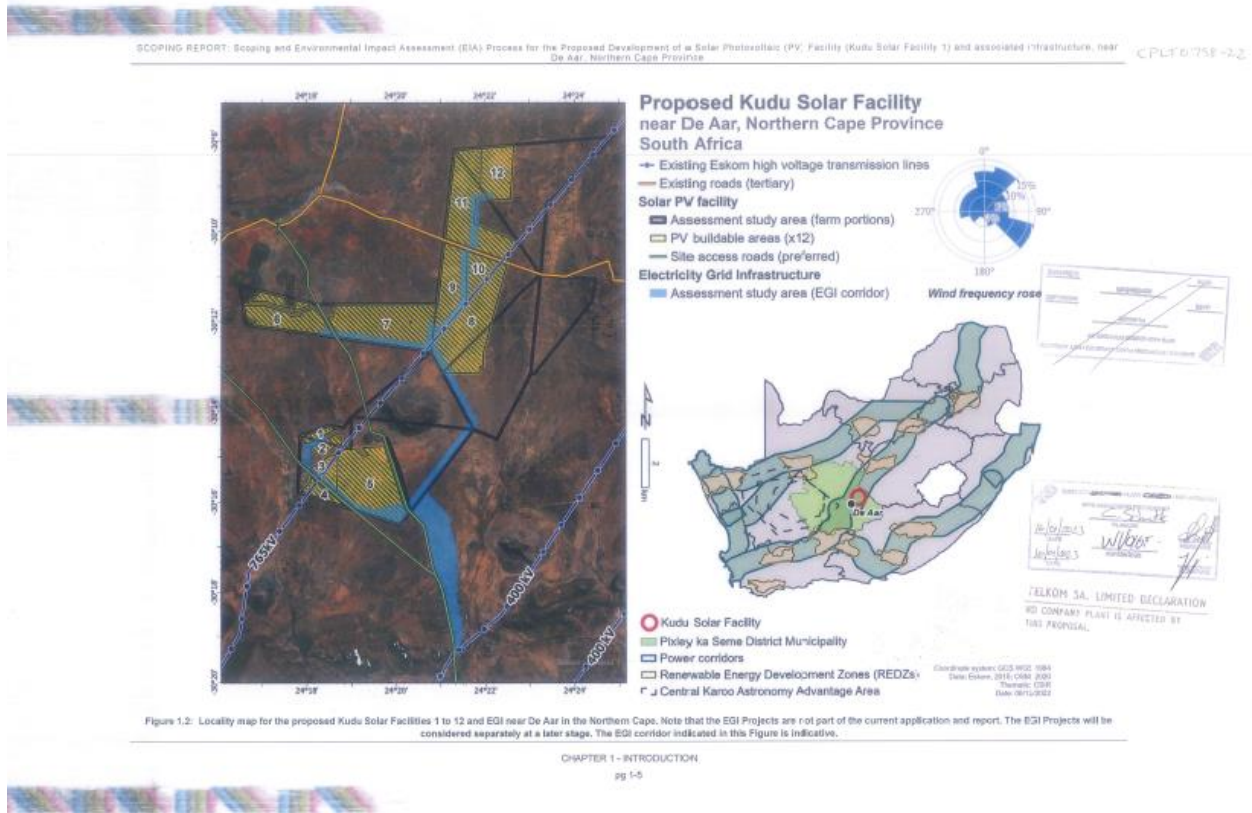

APPENDICES

SCOPING REPORT: Scoping and Environmental Impact Assessment (EIA) Process for the Proposed Development of a Solar Photovoltaic (PV) Facility (Kudu Solar Facility 2) and associated infrastructure, near De Aar, Northern Cape Province

5. Comments received from the South African Heritage Resources Agency (SAHRA)

From: Rohaida Abed <RAbed@csir.co.za>
Sent: 09 December 2022 15:21
To: Natasha Higgitt <nhiggitt@sahra.org.za>
Subject: Kudu Solar PV Draft Scoping Reports

Hi Natasha

Hope you are well.

Just wanted to check in about the separate cases for our Kudu project (interim comments attached).

Please let me know if we can only upload the main report and the Scoping Level Heritage Inputs, and the Scoping Level Palaeo Inputs?

Or do we need to upload all appendices as well? There are quite a lot of files though, so just checking if we can streamline the upload to SAHRIS in anyway?

Thanks
Rohaida

From: Natasha Higgitt <nhiggitt@sahra.org.za>
Sent: Friday, 09 December 2022 15:30
To: Rohaida Abed <RAbed@csir.co.za>
Subject: RE: Kudu Solar PV Draft Scoping Reports

[The e-mail server of the sender failed SPF checks and maybe malicious (SPF Record)]
Hi there,

Upload the DSR and I will have a look at what appendices you have. I will let you know what we need after that.

Reports that we will definitely need are Social, Visual, Consultation reports, appendices with maps and layouts and any draft EMP type documents.

I might only be able to look at the cases on Monday, but will let you know what we need.

Kind regards,

Please note that I will be on leave from the 19th December 2022 and I will return on the 9th January 2023.

APPENDICES

SCOPING REPORT: Scoping and Environmental Impact Assessment (EIA) Process for the Proposed Development of a Solar Photovoltaic (PV) Facility (Kudu Solar Facility 2) and associated infrastructure, near De Aar, Northern Cape Province

From: Rohaida Abed <RAbed@csir.co.za>
Sent: 11 December 2022 23:27
To: Natasha Higgitt <nhiggitt@sahra.org.za>
Subject: RE: Kudu Solar PV Draft Scoping Reports

Hi Natasha

Hope you are well. Thanks for your email. The following cases have been created on SAHRIS.

20336 Kudu Solar Facility 1
20337 Kudu Solar Facility 2
20338 Kudu Solar Facility 3
20339 Kudu Solar Facility 4
20340 Kudu Solar Facility 5
20341 Kudu Solar Facility 6
20342 Kudu Solar Facility 7
20343 Kudu Solar Facility 8
20344 Kudu Solar Facility 9
20345 Kudu Solar Facility 10
20346 Kudu Solar Facility 11
20347 Kudu Solar Facility 12

I have uploaded the DSR, Maps and the HIA Scoping Level Assessment, and PIA SSV (under Heritage Reports).

As previously discussed, the PIA is one single report for the entire study area, which has been determined by the specialist to be low sensitivity. So I have only created one PIA report number. However in an error I created a separate one for PV2 but it is the same attachment – is it possible for me to delete this?

Is it also possible to allow an additional person from our group to have editing and upload rights to the cases?

Thanks
Rohaida

APPENDICES

SCOPING REPORT: Scoping and Environmental Impact Assessment (EIA) Process for the Proposed Development of a Solar Photovoltaic (PV) Facility (Kudu Solar Facility 2) and associated infrastructure, near De Aar, Northern Cape Province

From: Natasha Higgitt <nhiggitt@sahra.org.za>
Sent: Monday, 12 December 2022 11:01
To: Rohaida Abed <RAbed@csir.co.za>
Subject: RE: Kudu Solar PV Draft Scoping Reports

[The e-mail server of the sender failed SPF checks and maybe malicious (SPF Record)]
Good morning,

Thank you for the email. I have assigned myself to the cases and added them to my schedule.

I will ask the SAHRIS Admin team to delete that report file. You must just link to the other PIA report file (which is linked to all the others cases) to PV 2 case.

We are not able to provide editing rights to more than one profile. I would recommend creating a company profile, that everyone in your company will have access to. This way more than one person may use the profile. This will also help when people leave companies and we don't need to transfer authorship to someone else.

Kind regards,

Please note that I will be on leave from the 19th December 2022 and I will return on the 9th January 2023.

From: Rohaida Abed
Sent: Monday, 12 December 2022 11:17
To: Natasha Higgitt <nhiggitt@sahra.org.za>
Subject: RE: Kudu Solar PV Draft Scoping Reports

Hi Natasha

Thanks so much for your feedback, I appreciate it.

Please let me know if you need any more appendices to be uploaded.

Thanks
Rohaida

APPENDICES

SCOPING REPORT: Scoping and Environmental Impact Assessment (EIA) Process for the Proposed Development of a Solar Photovoltaic (PV) Facility (Kudu Solar Facility 2) and associated infrastructure, near De Aar, Northern Cape Province

From: Rohaida Abed <RAbed@csir.co.za>
Sent: 14 December 2022 17:47
To: Natasha Higgitt <nhiggitt@sahra.org.za>
Subject: RE: Kudu Solar PV Draft Scoping Reports

Hi Natasha

Hope you are well. Just checking if you need any more appendices to be uploaded? I will do them before the break.

Hope you have a wonderful holiday.

Thanks
Rohaida

From: Natasha Higgitt <nhiggitt@sahra.org.za>
Sent: Thursday, 15 December 2022 09:39
To: Rohaida Abed <RAbed@csir.co.za>
Subject: RE: Kudu Solar PV Draft Scoping Reports

[The e-mail server of the sender failed SPF checks and maybe malicious (SPF Record)]
Good morning,

Please upload the Visual Scoping Reports and Appendix F for each development application. I assume that Appendix E Public Participation has no information at this stage in the Scoping Phase. If there is any public comments at this stage and they form part of that Appendix, please upload them to each case.

Kind regards,

Please note that I will be on leave from the 19th December 2022 and I will return on the 9th January 2023.

APPENDICES

SCOPING REPORT: Scoping and Environmental Impact Assessment (EIA) Process for the Proposed Development of a Solar Photovoltaic (PV) Facility (Kudu Solar Facility 2) and associated infrastructure, near De Aar, Northern Cape Province

From: Rohaida Abed
Sent: Wednesday, 21 December 2022 20:37
To: Natasha Higgitt
Cc: Helen Antonopoulos
Subject: RE: Kudu Solar PV Draft Scoping Reports

Hi Natasha

I hope that you are well.

We have saved the Visual Scoping Reports, Appendix E (PPP) and Appendix F (DFFE Pre-Consultation) onto SAHRIS earlier in the week.

Thanks again for your assistance.

Kind Regards,
Rohaida

From: EMS <ems@csir.co.za>
Sent: 25 January 2023 08:57
To: Natasha Higgitt <nhiggitt@sahra.org.za>
Cc: EMS <ems@csir.co.za>
Subject: RE: Reminder - Availability of Draft Scoping Reports for Comment - Kudu Solar PV - SAHRA

Dear Natasha

I hope that you are well. All the best for 2023. I hope that you had a good break.

I am kindly following up on the Kudu PV Projects, as per our communications last year (copied here).

Please let me know if SAHRA is able to send us comments on the Draft Scoping Reports by 30 Jan 2023?

Thanks for your inputs throughout this process.

Thank you and kind regards,
Rohaida Abed

CSIR Environmental Management Services
E-mail: ems@csir.co.za
Postal Address: P.O. Box 59081, Umbilo, Durban, 4075
Tel: 031 242 2300

APPENDICES

SCOPING REPORT: Scoping and Environmental Impact Assessment (EIA) Process for the Proposed Development of a Solar Photovoltaic (PV) Facility (Kudu Solar Facility 2) and associated infrastructure, near De Aar, Northern Cape Province

From: Natasha Higgitt <nhiggitt@sahra.org.za>
Sent: Wednesday, 25 January 2023 09:16
To: EMS
Subject: RE: Reminder - Availability of Draft Scoping Reports for Comment - Kudu Solar PV - SAHRA

Categories: This message has been archived by Retain on February 01 2023 18:59

[The e-mail server of the sender failed SPF checks and maybe malicious (SPF Record)]
Good morning,

I am currently drafting comments on the cases which I hope to issue by Friday.

Kind regards,

APPENDICES

SCOPING REPORT: Scoping and Environmental Impact Assessment (EIA) Process for the Proposed Development of a Solar Photovoltaic (PV) Facility (Kudu Solar Facility 2) and associated infrastructure, near De Aar, Northern Cape Province

SAHRIS

[MyDashboard](#) [Explore](#) [Create](#) [Calendar](#) [Maps](#) [Help](#)

SAHRIS Case ID 20336 - 20347

Between you and [natasha.higgitt](#)

[natasha.higgitt](#) Jan 25 New

Good afternoon,

Please note that Interim Comments have been issued on SAHRIS Case ID 20336 - 20347. Please see links to the cases.

Kind regards,
Natasha Higgitt

CaseReference:

- [Kudu Solar Facility 1](#)
- [Kudu Solar Facility 2](#)
- [Kudu Solar Facility 3](#)
- [Kudu Solar Facility 4](#)
- [Kudu Solar Facility 5](#)
- [Kudu Solar Facility 6](#)
- [Kudu Solar Facility 7](#)
- [Kudu Solar Facility 8](#)
- [Kudu Solar Facility 9](#)
- [Kudu Solar Facility 10](#)
- [Kudu Solar Facility 11](#)
- [Kudu Solar Facility 12](#)

Add message to tracker:

Reply

CaseReference

Message

Add message to tracker

After the message is send, automatically create Case Tracking with message content.

[Clear](#)

Messages

[Back to Top](#)

South African Heritage Resources Agency
(SAHRA)
111 Harrington Street
Cape Town
8001

PO Box 4637
Cape Town, 8000
Tel 021 462 4502/Fax 021 462 4509
Email info@sahra.org.za
Web www.sahra.org.za
(<http://www.sahra.org.za>)



An agency of the Department of Arts & Culture

Powered by [Drupal](#)

[Site best viewed using Google Chrome](#)
[Disclaimers](#)

Chat (12)

APPENDICES

SCOPING REPORT: Scoping and Environmental Impact Assessment (EIA) Process for the Proposed Development of a Solar Photovoltaic (PV) Facility (Kudu Solar Facility 2) and associated infrastructure, near De Aar, Northern Cape Province

Interim Comment: Kudu Solar Facility 2

Kudu Solar Facility 2

Our Ref:



an agency of the
Department of Arts and Culture

T: +27 21 462 4502 | F: +27 21 462 4509 | E: info@sahra.org.za
South African Heritage Resources Agency | 111 Harrington Street | Cape Town
P.O. Box 4637 | Cape Town | 8001
www.sahra.org.za

Enquiries: Natasha Higgitt
Tel: 021 462 4502
Email: nhiggitt@sahra.org.za
CaseID: 20337

Date: Wednesday January 25, 2023
Page No: 1

Interim Comment

In terms of Section 38(3), 38(8) of the National Heritage Resources Act (Act 25 of 1999)

Attention: Kudu Solar Facility 2 (Pty) Ltd

ABO Wind renewable energies (Pty) Ltd is proposing to develop 12 Solar Photovoltaic (PV) power generation facilities and associated Electrical Grid Infrastructure (EGI), north-east of the town of De Aar, in the Renosterberg Local Municipality and Pixley Ka Seme District Municipality, in the Northern Cape Province. Scoping and Environmental Impact Assessment (EIA) Processes are currently being undertaken for the 12 Solar PV facilities. Separate Basic Assessment (BA) and/or EGI Standard Registration processes will be commissioned separately, once finalised, for the EGI projects. This case is for the proposed Kudu Solar Facility 2.

The Council for Scientific and Industrial Research (CSIR) has been appointed by ABO Wind renewable energies (Pty) Ltd to undertake an Environmental Authorisation Application for the proposed Kudu Solar Facility 2 and associated infrastructure, near De Aar, Northern Cape Province.

A Draft Scoping Report (DSR) has been submitted in terms of the National Environmental Management Act, 1998 (NEMA) and the NEMA Environmental Impact Assessment (EIA) Regulations. The proposed activities will include the construction of solar panels, auxiliary buildings, inverter/transformer stations, on-site substation complex, battery energy storage system (BESS), underground cables, access roads, internal roads, fencing, storm water channels, panel cleaning and maintenance area, laydown areas with an overall application area of 48 ha.

Natura Viva CC and ASHA Consulting (Pty) Ltd were appointed to provide heritage specialist input as part of the EA process as per section 24(4)b(iii) of NEMA and section 38(8) of the National Heritage Resources Act, Act 25 of 1999 (NHRA).

Almond, J. E. 2022. Site Sensitivity Verification Report: Proposed Development of the Kudu Solar Photovoltaic Facilities and Associated Infrastructure near Philipstown and De Aar, Pixley Ka Seme District, Northern Cape Province.

A report that combines the assessment of all 12 Kudu Solar Projects has been submitted.

APPENDICES

SCOPING REPORT: Scoping and Environmental Impact Assessment (EIA) Process for the Proposed Development of a Solar Photovoltaic (PV) Facility (Kudu Solar Facility 2) and associated infrastructure, near De Aar, Northern Cape Province

Kudu Solar Facility 2

Our Ref:



an agency of the
Department of Arts and Culture

T: +27 21 462 4502 | F: +27 21 462 4509 | E: info@sahra.org.za
South African Heritage Resources Agency | 111 Harrington Street | Cape Town
P.O. Box 4637 | Cape Town | 8001
www.sahra.org.za

Enquiries: Natasha Higgitt
Tel: 021 462 4502
Email: nhiggitt@sahra.org.za
CaseID: 20337

Date: Wednesday January 25, 2023
Page No: 2

The proposed development footprint is underlain by the Waterford Formation, the Tierberg Formation and are overlain by the Late Caenozoic calcrete hardpans, alluvial deposits, surface gravels and soils of low sensitivity. A Chance Finds Procedure is recommended to be implemented.

Orton, J. 2022. Heritage Specialist Scoping Report Inputs: Scoping and Environmental Impact Assessment (EIA) Process for the Proposed Development of a Solar Photovoltaic Facility (Kudu Solar Facility 2) and associated infrastructure, near De Aar, Northern Cape Province

No heritage resources were identified within the Kudu Solar Facility 2. A Chance Finds Procedure is recommended and the recommendations of the Visual Impact Assessment must be followed.

Interim Comment

The SAHRA Archaeology, Palaeontology and Meteorites (APM) Unit requests that the HIA must be revised to include a map of the track logs and must be revised to show all project components such as the access roads etc. The table of identified heritage resources i.e. Table 2, must be revised to indicate in which Kudu project each heritage resources is located within and any specific mitigation and/or management measures required. An addendum to the PIA must be provided with specific results for the Kudu Solar 2 project.

Further comments will be issued upon receipt of the above revised reports and draft EIA inclusive of appendices.

Should you have any further queries, please contact the designated official using the case number quoted above in the case header.

Yours faithfully

Natasha Higgitt
Heritage Officer
South African Heritage Resources Agency

APPENDICES

SCOPING REPORT: Scoping and Environmental Impact Assessment (EIA) Process for the Proposed Development of a Solar Photovoltaic (PV) Facility (Kudu Solar Facility 2) and associated infrastructure, near De Aar, Northern Cape Province

Kudu Solar Facility 2

Our Ref:



an agency of the
Department of Arts and Culture

T: +27 21 462 4502 | F: +27 21 462 4509 | E: info@sahra.org.za
South African Heritage Resources Agency | 111 Harrington Street | Cape Town
P.O. Box 4637 | Cape Town | 8001
www.sahra.org.za

Enquiries: Natasha Higgitt
Tel: 021 462 4502
Email: nhiggitt@sahra.org.za
CaseID: 20337

Date: Wednesday January 25, 2023
Page No: 3

Phillip Hine
Manager: Archaeology, Palaeontology and Meteorites Unit
South African Heritage Resources Agency

ADMIN:
Direct URL to case: <https://sahris.sahra.org.za/node/611023>
(DFFE, Ref:)

APPENDICES

SCOPING REPORT: Scoping and Environmental Impact Assessment (EIA) Process for the Proposed Development of a Solar Photovoltaic (PV) Facility (Kudu Solar Facility 2) and associated infrastructure, near De Aar, Northern Cape Province

6. Comments received from General Stakeholders and I&APS

From: [REDACTED] <[REDACTED]>
Sent: Monday, 12 December 2022 09:29
To: EMS
Subject: Re: Availability of Draft Scoping Reports for Comment - Kudu Solar PV
Categories: This message has been archived by Retain on December 19, 2022, 18:52

You don't often get email from [REDACTED]. [Learn why this is important](#)

Hi Rahida

has received the documents and place on the Notice Board

Regards
[REDACTED]

From: Helen Antonopoulos
Sent: Tuesday, 24 January 2023 11:02
To: [REDACTED]
Cc: EMS
Subject: Kudu Sonfasiliteite Konsepverslae Kommentaarperiode
Categories: This message has been archived by Retain on January 31 2023 21:17

Goeie môre

Ek het vroeër vanoggend probeer geskakel i.v.m. die openbare kommentaarperiode vir die Kudu Sonfasiliteite se konsepverslae.

Die WNNR is aangestel as die onafhanklike omgewingskonsultant vir die projekte en ons wil graag vir u herinner dat die kommentaarperiode 30 Januarie 2023 sluit.

Die verslae en opsommings kan soos volg verkry word:

- Google Drive: https://bit.ly/KUDU_SOLAR_PV
- Projekwebuiste: <https://www.csir.co.za/environmental-impact-assessment>

Laat weet asseblief as u enige vrae of kommentaar het oor die verslae – ons waardeer alle insette. U is meer as welkom on ons telefonies (060 829 0202) of per e-pos te kontak.

Vriendelike groete
Helen

APPENDICES

SCOPING REPORT: Scoping and Environmental Impact Assessment (EIA) Process for the Proposed Development of a Solar Photovoltaic (PV) Facility (Kudu Solar Facility 2) and associated infrastructure, near De Aar, Northern Cape Province

From: [REDACTED] <[REDACTED]>
Sent: Tuesday, 24 January 2023 11:43
To: Helen Antonopoulos
Subject: Re: Kudu Sonfasiliteite Konsepverslae Kommentaarperiode

Goeie dag Helen

Ons het probleme met kommunikasie netwerke.

In 'n neutedop: waarom gaan die verslae waarop kommentaar gelewer moet word? (Voor ek nou alles download en in elk geval nie gaan verstaan nie) 😊

Groete

From: Helen Antonopoulos
Sent: Tuesday, 24 January 2023 15:15
To: [REDACTED]
Subject: RE: Kudu Sonfasiliteite Konsepverslae Kommentaarperiode

Categories: This message has been archived by Retain on January 31 2023 21:17

Goeie middag [REDACTED]

ABO Wind renewable energies (Edms) Bpk het die WNNR aangestel om die omgewingsimpakproses te bahartig vir die voorgestelde Kudu sonplase wat op u grond (Gedeelte 0 (RES) van Plaas Bas Berg 88; Gedeelte 3 (RES) van Plaas Bas Berg 88; Gedeelte 4 van Plaas Bas Berg 88) naby Petrusville/ Philipstown in die Noord-Kaap gebou sal word indien die projekte omgewingsgoedkeuring sou ontvang van die Departement van Bosbou, Visserye en die Omgewing.

Die verslae bevat opsommings van die die spesialiste se bevindinge rakende die voorgestelde Kudu sonplase. Elke verslag is baie lank, maar daar is 'n opsomming ("Executive Summary") beskikbaar van elke verslag op die webtuiste en Google Drive.

Laat weet asseblief as u enige vrae het. Ek is enige tyd beskikbaar, alhoewel die netwerk soms sukkel tydens loadshedding. Ons waardeer alle insette opreg.

Baie dankie
Helen

APPENDICES

SCOPING REPORT: Scoping and Environmental Impact Assessment (EIA) Process for the Proposed Development of a Solar Photovoltaic (PV) Facility (Kudu Solar Facility 2) and associated infrastructure, near De Aar, Northern Cape Province

From: [REDACTED] <[REDACTED]>
Sent: Tuesday, 24 January 2023 16:08
To: Helen Antonopoulos
Subject: Re: Kudu Sonfasiliteite Konsepverslae Kommentaarperiode

Baie dankie vir jou spoedige terugvoer.

From: [REDACTED] <[REDACTED]>
Sent: Monday, 30 January 2023 08:52
To: EMS; [REDACTED]
Subject: Comments on Kudu Development
Attachments: Kudu.pdf

You don't often get email from [REDACTED]. [Learn why this is important](#)

Dear Rohaida Abed
Attached my comments on the Kudu Development as an I&AP.
Also note that my email changed from [REDACTED] to [REDACTED]

Regards

[REDACTED]

APPENDICES

SCOPING REPORT: Scoping and Environmental Impact Assessment (EIA) Process for the Proposed Development of a Solar Photovoltaic (PV) Facility (Kudu Solar Facility 2) and associated infrastructure, near De Aar, Northern Cape Province

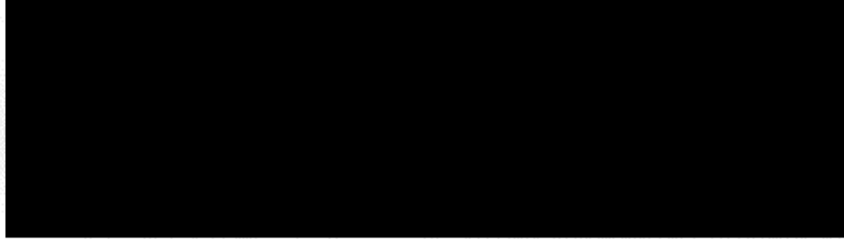

[Redacted]
[Redacted]

29 January 2023

Good day,

INPUT AND OBJECTION TOWARDS THE KUDU DEVELOPMENT

I registered as an interested and affected party to the proposed Kudu development in the Philipstown district.

1. We understand according to documents at our disposal that your development is a massive one proposed on only two farms. As a neighbour who has been farming for my entire life in the Karoo, I want to know what the water use of this project will be. Further, I also request information on measures that you have put in place to test the availability of water resources.
2. According to the layouts of the solar farms, it appears the majority of certain farms will be covered almost entirely under panels. What is your company's viewpoint and understanding of the subdivision of agricultural land act (Act 70 of 1970)? How would the act impact on your proposed developments?
3. What benefits would your proposed development have for the farming community of Philipstown district?

I also register my objection against the development as it does not enhance agricultural sustainability.

Kind regards,

[Redacted]
[Redacted]

(Note my email changed from [Redacted] to [Redacted])

APPENDICES

SCOPING REPORT: Scoping and Environmental Impact Assessment (EIA) Process for the Proposed Development of a Solar Photovoltaic (PV) Facility (Kudu Solar Facility 2) and associated infrastructure, near De Aar, Northern Cape Province

From: [REDACTED]
Sent: Monday, 30 January 2023 12:44
To: EMS; [REDACTED]
Subject: Objections
Attachments: Kudu.pdf

You don't often get email from [REDACTED]. [Learn why this is important](#)

APPENDICES

SCOPING REPORT: Scoping and Environmental Impact Assessment (EIA) Process for the Proposed Development of a Solar Photovoltaic (PV) Facility (Kudu Solar Facility 2) and associated infrastructure, near De Aar, Northern Cape Province

[REDACTED]
[REDACTED]
[REDACTED]
[REDACTED]

30 January 2023

Good day,

INPUT AND OBJECTION TOWARDS THE KUDU DEVELOPMENT

I registered as an interested and affected party to the proposed Kudu development in the Philipstown district.

1. We understand according to documents at our disposal that your development is a massive one proposed on only two farms. As a neighbor who has been farming for my entire life in the Karoo, I want to know what the water use of this project will be. Further, I also request information on measures that you have put in place to test the availability of water resources.

2. According to the layouts of the solar farms, it appears the majority of certain farms will be covered almost entirely under panels. What is your company's viewpoint and understanding of the subdivision of agricultural land act (Act 70 of 1970)? How would the act impact on your proposed developments?

3. What benefits would your proposed development have for the farming community of Philipstown district?

I also register my objection against the development as it does not enhance agricultural sustainability.

Kind regards,

[REDACTED]
[REDACTED]
[REDACTED]

[REDACTED]

APPENDICES

SCOPING REPORT: Scoping and Environmental Impact Assessment (EIA) Process for the Proposed Development of a Solar Photovoltaic (PV) Facility (Kudu Solar Facility 2) and associated infrastructure, near De Aar, Northern Cape Province

From: [REDACTED]
Sent: Monday, 30 January 2023 12:45
To: EMS; [REDACTED]
Subject: Objections
Attachments: Kudu.pdf

You don't often get email from [REDACTED]. [Learn why this is important](#)

APPENDICES

SCOPING REPORT: Scoping and Environmental Impact Assessment (EIA) Process for the Proposed Development of a Solar Photovoltaic (PV) Facility (Kudu Solar Facility 2) and associated infrastructure, near De Aar, Northern Cape Province

[REDACTED]
[REDACTED]
[REDACTED]
[REDACTED]

30 January 2023

Good day,

INPUT AND OBJECTION TOWARDS THE KUDU DEVELOPMENT

I registered as an interested and affected party to the proposed Kudu development in the Philipstown district.

1. We understand according to documents at our disposal that your development is a massive one proposed on only two farms. As a neighbor who has been farming for my entire life in the Karoo, I want to know what the water use of this project will be. Further, I also request information on measures that you have put in place to test the availability of water resources.

2. According to the layouts of the solar farms, it appears the majority of certain farms will be covered almost entirely under panels. What is your company's viewpoint and understanding of the subdivision of agricultural land act (Act 70 of 1970)? How would the act impact on your proposed developments?

3. What benefits would your proposed development have for the farming community of Philipstown district?

I also register my objection against the development as it does not enhance agricultural sustainability.

Kind regards,

[REDACTED]
[REDACTED]
[REDACTED]

[REDACTED]

APPENDICES

SCOPING REPORT: Scoping and Environmental Impact Assessment (EIA) Process for the Proposed Development of a Solar Photovoltaic (PV) Facility (Kudu Solar Facility 2) and associated infrastructure, near De Aar, Northern Cape Province

From: [REDACTED] <[REDACTED]>
Sent: Monday, 30 January 2023 17:52
To: EMS
Subject: Attention: Rohaid Abd
Attachments: Kudu Development.pdf

Sent from [Mail](#) for Windows



Virus-free www.avast.com

APPENDICES

SCOPING REPORT: Scoping and Environmental Impact Assessment (EIA) Process for the Proposed Development of a Solar Photovoltaic (PV) Facility (Kudu Solar Facility 2) and associated infrastructure, near De Aar, Northern Cape Province

[REDACTED]
[REDACTED]
[REDACTED]
[REDACTED]
[REDACTED]

29 January 2023

Good day

INPUT AND OBJECTION TO THE PROPOSED KUDU DEVELOPMENT – PHILIPSTOWN DISTRICT

I/we submit the following questions regarding the Kudu Development:

I/We understand that projects of this nature need to have an approved water license for each borehole. What measures have you put in place to adhere to this requirement?

According to your documents and proposed layout received, it seems your development will only benefit to two landowners. Do you believe it's fair and equitable to the surrounding farmers and landowners?

How do you intend to maintain the infrastructure, such as road and water courses, during construction? Can you provide a plan on how you will manage the dust pollution that will be created by the heavy trucks and increased traffic?

I/We also object to the entire project given the fact that we believe that the approach followed by the developer is against the letter and spirit of current legislation and regulatory frameworks that ensure agricultural sustainability especially in the Karoo.

Yours sincerely,

[REDACTED]

LANDOWNERS

APPENDICES

SCOPING REPORT: Scoping and Environmental Impact Assessment (EIA) Process for the Proposed Development of a Solar Photovoltaic (PV) Facility (Kudu Solar Facility 2) and associated infrastructure, near De Aar, Northern Cape Province

From: [REDACTED]
Sent: Monday, 30 January 2023 19:14
To: EMS
Subject: Objection towards KUDU
Attachments: img20230130_19045071.pdf

Good day Rohaida

Please find attached my objections towards the planned KUDU development.

Kind regards

[REDACTED]

APPENDICES

SCOPING REPORT: Scoping and Environmental Impact Assessment (EIA) Process for the Proposed Development of a Solar Photovoltaic (PV) Facility (Kudu Solar Facility 2) and associated infrastructure, near De Aar, Northern Cape Province



29 January 2023

Good day;

INPUT AND OBJECTION TOWARDS THE KUDU DEVELOPMENT

I registered as an interested and affected party to the proposed Kudu development in the Philipstown district.

1. We understand according to documents at our disposal that your development is a massive one proposed on only two farms. As a neighbour who has been farming for my entire life in the Karoo, I want to know what the water use of this project will be. Further, I also request information on measures that you have put in place to test the availability of water resources.

2. According to the layouts of the solar farms, it appears the majority of certain farms will be covered almost entirely under panels. What is your company's viewpoint and understanding of the subdivision of agricultural land act (Act 70 of 1970)? How would the act impact on your proposed developments?

YOUR LOGO
HERE

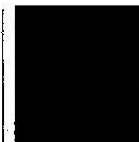

APPENDICES

SCOPING REPORT: Scoping and Environmental Impact Assessment (EIA) Process for the Proposed Development of a Solar Photovoltaic (PV) Facility (Kudu Solar Facility 2) and associated infrastructure, near De Aar, Northern Cape Province

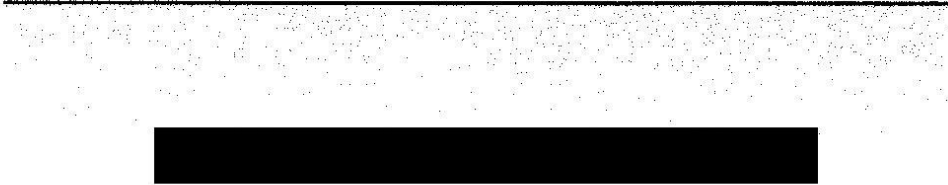

- 3. What benefits would your proposed development have for the broader farming community of Philipstown district?
- 4. What benefits would your proposed development have for the socio-economical upliftment of farmers and their employees (including their families/dependents) of the greater area rather than the proposed two farms and the owner/beneficiary there-of ?

I also register my objection against the development as it does not enhance agricultural sustainability.

Kind regards,



LANDOWNER/DIRECTOR – 

**YOUR LOGO
HERE**

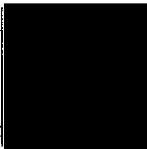

APPENDICES

SCOPING REPORT: Scoping and Environmental Impact Assessment (EIA) Process for the Proposed Development of a Solar Photovoltaic (PV) Facility (Kudu Solar Facility 2) and associated infrastructure, near De Aar, Northern Cape Province

From: [REDACTED] <[REDACTED]>

Sent: Monday, 30 January 2023 23:44

To: EMS <ems@csir.co.za>

Subject:

You don't often get email from [REDACTED]. [Learn why this is important](#)

APPENDICES

SCOPING REPORT: Scoping and Environmental Impact Assessment (EIA) Process for the Proposed Development of a Solar Photovoltaic (PV) Facility (Kudu Solar Facility 2) and associated infrastructure, near De Aar, Northern Cape Province

Objection to the Kudu in its current format and layout development

To whom it may concern:

My name is [REDACTED] I am the owner of the farm [REDACTED]. My farm is next to the Kudu Development.

Please consider and respond to the following issues of serious concern to me.

1. The Kudu development appears to be an enormous concentrated development of several thousands of hectares, laying in one massive block.

*Please indicate what impact this development will have to the underground water resources of the area.

APPENDICES

SCOPING REPORT: Scoping and Environmental Impact Assessment (EIA) Process for the Proposed Development of a Solar Photovoltaic (PV) Facility (Kudu Solar Facility 2) and associated infrastructure, near De Aar, Northern Cape Province

* How much water will be withdrawn from the underground resources to service the development ?

How long will the withdrawing of such an amount of water, to serve the maintenance of the development, be sustainable ?

What will the effect be to the windmills/ boreholes on my farm that I use to supply drinking water to my sheep and cattle.

I am living for more than 47 years in this area. A part of my daily life and daily bread is an ongoing effort to serve the area with drinking water for the sheep and cattle. My way crossed a lot with hydrologists, discussing the underground water of this specific huge plains of the Upper Karoo. The most of the farmers around me. Does the same by just supply enough drinking water to sheep and cattle.

APPENDICES

SCOPING REPORT: Scoping and Environmental Impact Assessment (EIA) Process for the Proposed Development of a Solar Photovoltaic (PV) Facility (Kudu Solar Facility 2) and associated infrastructure, near De Aar, Northern Cape Province

I want to make the following remarks that I would like your specialists to respond on.

- The most of the windmills and boreholes on the farm is just enough for the sheep. Some off the boreholes even dried up in the drought season.
- The point I am making is that the underground water is slow running.
- The underground water is moving in this area from south to north.
- That the depth of the water surface in this area differs from 10 to 40 meters and is slowly sinking deeper as the time go by and the drought Seasons get closer.
- Almost all the boreholes feeding windmills to provide drinking water stops on the dolorite bank (differs from 50-80meter from the surface) and were made by the old bore machines of the previous century.

APPENDICES

SCOPING REPORT: Scoping and Environmental Impact Assessment (EIA) Process for the Proposed Development of a Solar Photovoltaic (PV) Facility (Kudu Solar Facility 2) and associated infrastructure, near De Aar, Northern Cape Province

2. This farm belongs to my family since 1893. We as children were always told to work responsible with the under ground water and overgrazing fields because of the low underground water levels. Given the huge area that will be covered by the panels in a block of several thousands of hectares, how will this proposed development contribute to, and ensure long term agriculture sustainability in this semi- arid Upper Karoo ?

APPENDICES

SCOPING REPORT: Scoping and Environmental Impact Assessment (EIA) Process for the Proposed Development of a Solar Photovoltaic (PV) Facility (Kudu Solar Facility 2) and associated infrastructure, near De Aar, Northern Cape Province

3. Visual impact. Please provide me with information and sketches about the visual impact that this development will have on my farm and farming.

I hereby want to register an objection in the Kudu development in its current format and layout.

[REDACTED]

[REDACTED]

APPENDICES

SCOPING REPORT: Scoping and Environmental Impact Assessment (EIA) Process for the Proposed Development of a Solar Photovoltaic (PV) Facility (Kudu Solar Facility 2) and associated infrastructure, near De Aar, Northern Cape Province

From: [REDACTED] <[REDACTED]>
Sent: Monday, 30 January 2023 15:17
To: EMS
Subject: Objection to the Kudu Solar Facilities development in its current format and layout. Renosterberg local Municipality
Attachments: IMG-20230130-WA0016.jpg; IMG-20230130-WA0018.jpg; IMG-20230130-WA0017.jpg

You don't often get email from [REDACTED]. [Learn why this is important](#)

Attention: Rohaida Abed

Good day,

please find the letter consist out of three pages that are attached.

Sincerely

[REDACTED]

APPENDICES

SCOPING REPORT: Scoping and Environmental Impact Assessment (EIA) Process for the Proposed Development of a Solar Photovoltaic (PV) Facility (Kudu Solar Facility 2) and associated infrastructure, near De Aar, Northern Cape Province

[REDACTED]

[REDACTED]

Kontak persoon: [REDACTED]

Cell: [REDACTED]

Email: [REDACTED]

[REDACTED]

Objection to the Kudu development in its current format and layout.

To whom it may concern:

My name is [REDACTED] I am the owner of the farm [REDACTED]. My farm is a neighbor farm of the Kudu Development, bordering it for [REDACTED] meters to the [REDACTED]

Please consider and respond to the following issues of serious concern to me.

1. The Kudu development appears to be an enormous concentrated development of several thousands of hectares, laying in one massive block.

*Please indicate what impact this development will have to the underground water resources of the area.

APPENDICES

SCOPING REPORT: Scoping and Environmental Impact Assessment (EIA) Process for the Proposed Development of a Solar Photovoltaic (PV) Facility (Kudu Solar Facility 2) and associated infrastructure, near De Aar, Northern Cape Province

* How much water will be withdrawn from the underground resources to service the development ?

* How long will the withdrawing of such an amount of water, to serve the maintenance of the development, be sustainable ?

* What will the effect be to the current windmills/boreholes that I use to serve my extensive sheep and game farm activities with drinking water.

I am no hydrologist but I am living for more than 50 years in this area. A part of my daily life and daily bread is an ongoing effort to serve the area with drinking water for the sheep and game. My way crossed a lot with hydrologists, discussing the underground water of this specific huge plains of the Upper Karoo.

I want to make the following remarks that I would like your specialists to respond on.

- The most of the underground water in this area is fossil water. Stored for many years underground.
- The little supplement of underground water is slow and occur only once every few years.
- The underground water is moving in this area from south to north.
- That the depth of the water surface in this area differs from 10 to 30 meters and is slowly sinking deeper as the time go by.
- Almost all the boreholes feeding windmills to provide drinking water stops on the dolorite bank (differs from 30 -50 meter from the surface) and were made by the old bore machines of the previous century.

2. This farm belongs to my family since 1867. We always stove to practice responsible farming activities to enhance agricultural sustainability in the Karoo. Given the huge area that will be covered by the panels in a block of several thousands of hectares, how will this proposed development contribute to, and ensure long term agriculture sustainability in this semi-arid Upper Karoo ?

APPENDICES

SCOPING REPORT: Scoping and Environmental Impact Assessment (EIA) Process for the Proposed Development of a Solar Photovoltaic (PV) Facility (Kudu Solar Facility 2) and associated infrastructure, near De Aar, Northern Cape Province

3. Visual impact. Please provide me with information and sketches about the visual impact that this development will have on my farm and farming activities like the offering of hunting- and photographic safaris to clients from all over the world ?

I hereby want to register an objection in the Kudu development in its current format and layout.

[REDACTED]

Yours sincerely

[REDACTED]

Footnote: In the Karoo is the overuse of underground water the same sin to nature as the overgrazing of the natural pasture.

APPENDICES

SCOPING REPORT: Scoping and Environmental Impact Assessment (EIA) Process for the Proposed Development of a Solar Photovoltaic (PV) Facility (Kudu Solar Facility 2) and associated infrastructure, near De Aar, Northern Cape Province

From: [REDACTED] <[REDACTED]>
Sent: Monday, 30 January 2023 15:20
To: EMS
Subject: Fw: Objection to the Kudu Solar Facilities development in its current format and layout. Renosterberg local Municipality
Attachments: IMG-20230130-WA0016.jpg; IMG-20230130-WA0018.jpg; IMG-20230130-WA0017.jpg

You don't often get email from [REDACTED]. [Learn why this is important](#)

Attention: Rohaida Abed

Good day,

please find the letter consist out of three pages that are attached.

Sincerely

[REDACTED]

APPENDICES

SCOPING REPORT: Scoping and Environmental Impact Assessment (EIA) Process for the Proposed Development of a Solar Photovoltaic (PV) Facility (Kudu Solar Facility 2) and associated infrastructure, near De Aar, Northern Cape Province

[REDACTED]

[REDACTED]

Kontak persoon: [REDACTED]

Cell: [REDACTED]

Email: [REDACTED]

[REDACTED]

Objection to the Kudu development in its current format and layout.

To whom it may concern:

My name is [REDACTED] I am the owner of the farm [REDACTED]. My farm is a neighbor farm of the Kudu Development, bordering it for [REDACTED] meters to the [REDACTED]

Please consider and respond to the following issues of serious concern to me.

1. The Kudu development appears to be an enormous concentrated development of several thousands of hectares, laying in one massive block.

*Please indicate what impact this development will have to the underground water resources of the area.

APPENDICES

SCOPING REPORT: Scoping and Environmental Impact Assessment (EIA) Process for the Proposed Development of a Solar Photovoltaic (PV) Facility (Kudu Solar Facility 2) and associated infrastructure, near De Aar, Northern Cape Province

- * How much water will be withdrawn from the underground resources to service the development ?
- * How long will the withdrawing of such an amount of water, to serve the maintenance of the development, be sustainable ?
- * What will the effect be to the current windmills/boreholes that I use to serve my extensive sheep and game farm activities with drinking water.

I am no hydrologist but I am living for more than 50 years in this area. A part of my daily life and daily bread is an ongoing effort to serve the area with drinking water for the sheep and game. My way crossed a lot with hydrologists, discussing the underground water of this specific huge plains of the Upper Karoo.

I want to make the following remarks that I would like your specialists to respond on.

- The most of the underground water in this area is fossil water. Stored for many years underground.
 - The little supplement of underground water is slow and occur only once every few years.
 - The underground water is moving in this area from south to north.
 - That the depth of the water surface in this area differs from 10 to 30 meters and is slowly sinking deeper as the time go by.
 - Almost all the boreholes feeding windmills to provide drinking water stops on the dolorite bank (differs from 30 -50 meter from the surface) and were made by the old bore machines of the previous century.
2. This farm belongs to my family since 1867. We always stoved to practice responsible farming activities to enhance agricultural sustainability in the Karoo. Given the huge area that will be covered by the panels in a block of several thousands of hectares, how will this proposed development contribute to, and ensure long term agriculture sustainability in this semi-arid Upper Karoo ?

APPENDICES

SCOPING REPORT: Scoping and Environmental Impact Assessment (EIA) Process for the Proposed Development of a Solar Photovoltaic (PV) Facility (Kudu Solar Facility 2) and associated infrastructure, near De Aar, Northern Cape Province

3. Visual impact. Please provide me with information and sketches about the visual impact that this development will have on my farm and farming activities like the offering of hunting- and photographic safaris to clients from all over the world ?

I hereby want to register an objection in the Kudu development in its current format and layout.

[REDACTED]

Yours sincerely

[REDACTED]

Footnote: In the Karoo is the overuse of underground water the same sin to nature as the overgrazing of the natural pasture.

APPENDICES

SCOPING REPORT: Scoping and Environmental Impact Assessment (EIA) Process for the Proposed Development of a Solar Photovoltaic (PV) Facility (Kudu Solar Facility 2) and associated infrastructure, near De Aar, Northern Cape Province

From: [REDACTED] <[REDACTED]>
Sent: Tuesday, 31 January 2023 20:28
To: EMS
Subject: KUDU
Attachments: KUDU DEVELOPMENT LO'S [REDACTED].[REDACTED].[REDACTED].[REDACTED].[REDACTED].(2).docx

You don't often get email from [REDACTED]. [Learn why this is important](#)

ATTENTION: ROHAIDA ABED,

Good day, i tried to submit this letter [yesterday](#), 30 January 2023 but had no wifi signal and internet.

I hope you still accept this letter of interest as it is one day late. sorry for the delay but it was out of my hands.

PLEASE FIND ATTACHED THE LETTER OF CONCERN.

Yours sincerely

[REDACTED]

APPENDICES

SCOPING REPORT: Scoping and Environmental Impact Assessment (EIA) Process for the Proposed Development of a Solar Photovoltaic (PV) Facility (Kudu Solar Facility 2) and associated infrastructure, near De Aar, Northern Cape Province



29 January 2023

Good day

INPUT AND OBJECTION TO THE PROPOSED KUDU DEVELOPMENT – PHILIPSTOWN DISTRICT

I/we submit the following questions regarding the Kudu Development:

I/We understand that projects of this nature need to have an approved water license for each borehole. What measures have you put in place to adhere to this requirement?

According to your documents and proposed layout received, it seems your development will only benefit to two landowners. Do you believe it's fair and equitable to the surrounding farmers and landowners?

How do you intend to maintain the infrastructure, such as road and water courses, during construction? Can you provide a plan on how you will manage the dust pollution that will be created by the heavy trucks and increased traffic?

I/We also object to the entire project given the fact that we believe that the approach followed by the developer is against the letter and spirit of current legislation and regulatory frameworks that ensure agricultural sustainability especially in the Karoo.

As the direct neighbour I am concerned about the dust pollution over the long term in years to come due to the very large area that wont have any vegetation. All the roads goes past and threw

APPENDICES

SCOPING REPORT: Scoping and Environmental Impact Assessment (EIA) Process for the Proposed Development of a Solar Photovoltaic (PV) Facility (Kudu Solar Facility 2) and associated infrastructure, near De Aar, Northern Cape Province

my farm and dust piles on to my vegetation and the animals eats the dust with the vegetation wich piles up into their stomachs and causes illness and leads to death.

Yours sincerely,

■

LANDOWNERS |

APPENDICES

SCOPING REPORT: Scoping and Environmental Impact Assessment (EIA) Process for the Proposed Development of a Solar Photovoltaic (PV) Facility (Kudu Solar Facility 2) and associated infrastructure, near De Aar, Northern Cape Province

From: [REDACTED] <[REDACTED]>
Sent: Tuesday, 31 January 2023 15:47
To: EMS
Subject: OBJECTION - KUDU DEVELOPMENT
Attachments: Letter - CSIR.pdf

You don't often get email from [REDACTED]. [Learn why this is important](#)

Good day

Kindly find herewith a letter for your urgent attention and feedback.

Kind Regards

[REDACTED]
Attorney and Conveyancer

[REDACTED] [REDACTED] [REDACTED]
Prokureurs / Attorneys / Igqwetha

The information contained in this communication from the sender is confidential. It is intended solely for use by the recipient and others authorized to receive it. If you are not the recipient, you are hereby notified that any disclosure, copying, distribution or taking action in relation of the contents of this information is strictly prohibited and may be unlawful.

APPENDICES

SCOPING REPORT: Scoping and Environmental Impact Assessment (EIA) Process for the Proposed Development of a Solar Photovoltaic (PV) Facility (Kudu Solar Facility 2) and associated infrastructure, near De Aar, Northern Cape Province



Prokureurs / Attorneys / Igqwetha

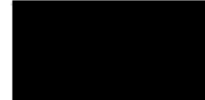

Datum/Date:
31 January 2023

Ons verw/Our ref:

u Verw/Your ref:

CSIR
UMBILO

Attention: Rohaida Abed
Per E-mail: ems@csir.co.za

Re: INPUT AND OBJECTION TOWARDS THE KUDU DEVELOPMENT

We refer to the abovementioned matter and confirm that we are acting on behalf of [REDACTED] and [REDACTED] who are both an interested and affected party to the proposed Kudu development in the Philipstown district.

1. We understand according to documents at our disposal that your development is a massive one proposed on only two farms. As neighbours our clients have been farming for their entire life in the Karoo, and we want to know what the water use of this project will be. Further, we also request information on measures that you have put in place to test the availability of water resources.
2. According to the layouts of the solar farms, it appears the majority of certain farms will be covered almost entirely under panels. What is your company's

[REDACTED] - B.A. LLB (US)

APPENDICES

SCOPING REPORT: Scoping and Environmental Impact Assessment (EIA) Process for the Proposed Development of a Solar Photovoltaic (PV) Facility (Kudu Solar Facility 2) and associated infrastructure, near De Aar, Northern Cape Province

viewpoint and understanding of the subdivision of agricultural land act (Act 70 of 1970)? How would the act impact on your proposed developments?

3. What benefits would your proposed development have for the farming community of Philipstown district?
4. We also register our objection on behalf of my clients against the development as it does not enhance agricultural sustainability.
5. I take note that this objection had to be filed on/before 30 January 2023. I kindly request that you condone the late filing of this objection as we are of the opinion the there will be no prejudice of filing this objection 1 day late.
6. If you fail to condone the late filing of this objection and respond in detail to our objections we hold instruction to bring a court application in order to stop the development.

We trust you find the above in order.

Yours Faithfully

[REDACTED]

.....
[REDACTED]

(electronically send therefore unsigned)

[REDACTED] - B.A. LLB (US)

APPENDICES

SCOPING REPORT: Scoping and Environmental Impact Assessment (EIA) Process for the Proposed Development of a Solar Photovoltaic (PV) Facility (Kudu Solar Facility 2) and associated infrastructure, near De Aar, Northern Cape Province

From: [REDACTED] <[REDACTED]>
Sent: Monday, 30 January 2023 21:25
To: EMS
Attachments: 20230130212420_001.jpg

You don't often get email from [REDACTED]. [Learn why this is important](#)

Sent from my Galaxy

APPENDICES

SCOPING REPORT: Scoping and Environmental Impact Assessment (EIA) Process for the Proposed Development of a Solar Photovoltaic (PV) Facility (Kudu Solar Facility 2) and associated infrastructure, near De Aar, Northern Cape Province

PLEASE ADD ADDRESS OR LETTERHEAD

29 January 2023

Good day

INPUT AND OBJECTION TO THE PROPOSED KUDU DEVELOPMENT – PHILIPSTOWN DISTRICT

I/we submit the following questions regarding the Kudu Development:

I/We understand that projects of this nature need to have an approved water license for each borehole. What measures have you put in place to adhere to this requirement?

According to your documents and proposed layout received, it seems your development will only benefit to two landowners. Do you believe it's fair and equitable to the surrounding farmers and landowners?

How do you intend to maintain the infrastructure, such as road and water courses, during construction? Can you provide a plan on how you will manage the dust pollution that will be created by the heavy trucks and increased traffic?

I/We also object to the entire project given the fact that we believe that the approach followed by the developer is against the letter and spirit of current legislation and regulatory frameworks that ensure agricultural sustainability especially in the Karoo.

Yours sincerely,

LANDOWNERS

