

## APPENDICES

SCOPING REPORT: Scoping and Environmental Impact Assessment (EIA) Process for the Proposed Development of a Solar Photovoltaic (PV) Facility (Kudu Solar Facility 8) and associated infrastructure, near De Aar, Northern Cape Province

---

# CONTENTS

<b>APPENDIX E.7: COPIES OF THE CONTENT OF AND PROOF OF PLACEMENT OF THE NEWSPAPER ADVERTISEMENTS FOR THE RELEASE OF THE DRAFT SCOPING REPORT</b>	<b>3</b>
1. Copy of the content of the newspaper advertisement	4
2. Proof of the newspaper advertisement publishing in the Noord-Kaap Bulletin	5
3. Proof of the newspaper advertisement publishing in the Echo / Midland News	6
4. Proof of the newspaper advertisement publishing in the Bloem Nuus	7
<b>APPENDIX E.8: CORRESPONDENCE AND PROOF OF CORRESPONDENCE SENT TO STAKEHOLDERS FOR THE DRAFT SCOPING REPORT RELEASE</b>	<b>8</b>
1. Letter 2 sent via email to I&APs, Stakeholders and Organs of State: Notification of the Release of the Draft Scoping Report for a 30-day Comment Period	9
2. Email 2 sent to I&APs, Stakeholders and Organs of State on 9 December 2022	11
3. Proof of Delivery of Email 2 sent to all I&APs, Stakeholders and Organs of State on 9 December 2022	13
4. Proof of SMS Text Messages sent to I&APs, Stakeholders and Organs of State (where cellphone numbers are available) on 9 December 2022	19
5. Proof of Upload of the DSR to the CSIR Project Website	25
6. Proof of Upload of the DSR to Google Drive	26
7. Proof of Upload of the DSR to SAHRIS (Kudu Solar Facility 8)	27
8. Proof of Courier of USBs to Libraries	28
9. Follow-Up/ Reminder Email sent to all I&APs, Stakeholders, and Organs of State on 17 January 2023	28
10. Proof of Delivery of Follow Up/ Reminder Email sent to all I&APs, Stakeholders, and Organs of State on 17 January 2023	32
11. Proof of SMS Reminder Text Message sent to all I&APs, Stakeholders, and Organs of State (where cell phone numbers were available) on 17 January 2023	38

## APPENDICES

SCOPING REPORT: Scoping and Environmental Impact Assessment (EIA) Process for the Proposed Development of a Solar Photovoltaic (PV) Facility (Kudu Solar Facility 8) and associated infrastructure, near De Aar, Northern Cape Province

---

12. Personalised Reminder Email sent to key I&APs, Stakeholders and Organs of State (as determined by the DFFE) on 24 and 25 January 2023 **Error! Bookmark not defined.**
13. Proof of Delivery of Personalised Reminder Email sent to key I&APs, Stakeholders and Organs of State (as determined by the DFFE) on 24 and 25 January 2023 **Error! Bookmark not defined.**
14. Proof of SMS Communication Sent to a Renosterberg Local Municipality Councilor **Error! Bookmark not defined.**
15. Proof of Communication Attempts with a Stakeholder Regarding the Visual Impacts of the Kudu Solar Facilities on their Farm Portion and Farmstead **Error! Bookmark not defined.**
16. Read Receipts of All Email Communication to Stakeholders During the DSR Release Phase **Error! Bookmark not defined.**

### **APPENDIX E.9: PROOF OF SUBMISSION OF THE DSR AND APPLICATION FORM TO THE DFFE** **69**

1. Copy of Email sent to the DFFE for Submission of the DSR and Application Form on 9 December 2022 70
2. Proof of Upload of the DSR to the DFFE Novell S-Filer on 9 December 2022 71

### **APPENDIX E.10: COMMENTS RECEIVED FROM STAKEHOLDERS DURING THE 30-DAY REVIEW OF THE DSR** **72**

1. Comments Received from the Department of Forestry, Fisheries and the Environment (DFFE) 73
  - 1.1 The DFFE Directorate: Integrated Environmental Authorisation: Kudu Solar Facility 873
  - 1.2 The DFFE Directorate: Biodiversity Conservation 80
  - 1.3 The DFFE Directorate: Protected Areas Planning and Management Effectiveness 85
2. Comments received from the Northern Cape Department of Agriculture, Environmental Affairs, Rural Development and Land Reform 87
3. Comments received from Eskom 93
4. Comments received from Telkom: Kudu Solar Facility 8 (Telkom Ref No. CPLT0804-22) 106
4. Comments received from the South African Heritage Resources Agency (SAHRA) 111
5. Comments received from General Stakeholders and I&APS 121

## APPENDICES

SCOPING REPORT: Scoping and Environmental Impact Assessment (EIA) Process for the Proposed Development of a Solar Photovoltaic (PV) Facility (Kudu Solar Facility 8) and associated infrastructure, near De Aar, Northern Cape Province

---

### **APPENDIX E.7: COPIES OF THE CONTENT OF AND PROOF OF PLACEMENT OF THE NEWSPAPER ADVERTISEMENTS FOR THE RELEASE OF THE DRAFT SCOPING REPORT**

## APPENDICES

SCOPING REPORT: Scoping and Environmental Impact Assessment (EIA) Process for the Proposed Development of a Solar Photovoltaic (PV) Facility (Kudu Solar Facility 8) and associated infrastructure, near De Aar, Northern Cape Province

---

# App. E.7/...

---

### 1. Copy of the content of the newspaper advertisement

---

## APPENDICES

### SCOPING REPORT: Scoping and Environmental Impact Assessment (EIA) Process for the Proposed Development of a Solar Photovoltaic (PV) Facility (Kudu Solar Facility 8) and associated infrastructure, near De Aar, Northern Cape Province

#### NOTICE OF SCOPING AND ENVIRONMENTAL IMPACT ASSESSMENT (S&EIA) PROCESSES FOR THE PROPOSED DEVELOPMENT OF TWELVE SOLAR PHOTOVOLTAIC (PV) FACILITIES AND ASSOCIATED INFRASTRUCTURE, NEAR DE AAR IN THE NORTHERN CAPE PROVINCE

Notice is hereby given that the Project Developer, ABO Wind renewable energies (Pty) Ltd, is proposing to develop twelve Solar Photovoltaic (PV) power generation facilities and associated infrastructure, such as, but not limited to, various structures, buildings, and Battery Energy Storage Systems (BESS), near De Aar in the Northern Cape Province. These projects are referred to as Kudu Solar Facility 1 to 12 (Projects 1 to 12). The proposed projects are located within the Renosterberg Local Municipality, which falls within the Pixley Ka Seme District Municipality. The Project Applicants are Kudu Solar Facility 1 (Pty) Ltd to Kudu Solar Facility 12 (Pty) Ltd.

The proposed PV facilities and associated infrastructure (i.e. Projects 1 to 12) will be constructed on a selection of the following farm portions: Portion 0 (RE) of Farm Bas Berg 88; Portion 3 (RE) of Farm Bas Berg 88; Portion 4 of Farm Bas Berg 88; Portion 2 (RE) of Farm Grass Pan 40; Portion 0 (RE) of Farm Annex Wolve Kuil 41; Portion 1 of Farm Annex Wolve Kuil 41; Portion 2 of Farm Wolve Kuil 43; and Portion 0 (RE) of Farm Wolve Kuilen 42.

In terms of the National Environmental Management Act (Act 107 of 1998, as amended) (NEMA) and the 2014 NEMA Environmental Impact Assessment (EIA) Regulations (as amended), the proposed Kudu Solar Facilities (Projects 1 to 12) will be subject to full Scoping and EIA (S&EIA) Processes, with a 107-day decision-making timeframe. Notice of the S&EIA Processes is thus given in terms of Regulation 41 (2) (c) of the 2014 NEMA EIA Regulations (as amended).

Separate Applications for EA will be submitted to the Competent Authority, the Department of Forestry, Fisheries and the Environment (DFFE), with the Draft Scoping Reports for the Kudu Solar Facilities (Projects 1 to 12). The proposed projects trigger various listed activities in the 2014 NEMA EIA Regulations (as amended); with GN R325 Listing Notice 2: Activity 1 serving as the main activity for the Kudu Solar Facilities (Projects 1 to 12). Comment will also be sought from the South African Heritage Resources Agency (SAHRA) in terms of the National Heritage Resources Act (Act 25 of 1999). The S&EIA Processes will also confirm if a Water Use Authorisation is required in accordance with the National Water Act (Act 36 of 1998, as amended). An integrated Public Participation Process will be undertaken for all the proposed projects, as well as all applications necessary in respect of other applicable legislation.

The Council for Scientific and Industrial Research (CSIR) has been appointed as the independent Environmental Assessment Practitioner (EAP) to undertake and manage the Environmental Assessment processes for the proposed projects on behalf of the Project Applicants.

Interested and/or Affected Parties (I&APs) are hereby notified of the release of the Draft Scoping Reports for the Kudu Solar Facilities (Projects 1 to 12) for a 30-day review period, which will extend from **9 December 2022 to 30 January 2023**. This comment period excludes the regulated shutdown period. The Draft Scoping Reports can be downloaded from the following website:

<https://www.csir.co.za/environmental-impact-assessment>

**Should you be interested in registering as an I&AP and to provide comments on the Draft Scoping Reports, you are kindly requested to e-mail your name, contact details, with an indication of any direct business, financial, personal or other interest which you may have in the applications, as well as comments, to the EAP at the CSIR: Rohaida Abed; E-mail: [ems@csir.co.za](mailto:ems@csir.co.za); Postal address: P.O. Box 59081, Umbilo, Durban, 4075; Tel: 031 242 2300.**

Note that the Electrical Grid Infrastructure (EGI) needed to facilitate connection of the Kudu Solar Facilities to the national grid will include 132 kV power lines, Switching Stations and Collector Stations at each Solar PV Facility (Kudu EGI Projects 13 to 24), an independent 400/132 kV Main Transmission Substation (MTS) (Kudu EGI Project 25), and a 400 kV Loop-In-Loop-Out (LIL) (Kudu EGI Project 26). Projects 13 to 26 are located within the Central Strategic Transmission Corridor that was gazetted in GN 113 in February 2018 and will therefore be subjected to separate Basic Assessment (BA) Processes and/or Registration via the Power Line and Substation Standard (Government Gazette 47095; GN 2313, dated 27 July 2022). Separate notifications will be published, when reports are available for comment (as relevant), for Projects 13 to 26.

#### KENNISGEWING VAN DIE BESTEKOPNAME- EN OMGEWINGS-IMPAKSTUDIESPROSESSE ("S&EIA") VIR DIE VOORGESTELDE ONTWIKKELING VAN TWAALF SON FOTOVOLTAÏESE (PV) FASILITEITE EN MEEGAANDE INFRASTRUKTUUR GELEË NABY DE AAR IN DIE NOORD-KAAP PROVINSIE

Hiermee word kennis gegee dat die Projek-ontwikkelaar, ABO Wind renewable energies (Edms) Bpk, die ontwikkeling voorstel van twaalf Son Fotovoltaïese (PV) energie opwekkingsfasiliteite en meegaande infrastruktuur, insluitende verskeie strukture, geboue en Battery Energie Bergingsisteme ("BESS"), naby De Aar in die Noord-Kaap Provinsie. Hierdie projekte staan bekend as Kudu Son Fasiliteit 1 tot 12 (Projekte 1 tot 12). Die voorgestelde projekte is geleë in die Renosterberg Plaaslike Munisipaliteit wat val binne die Pixley Ka Seme Distriksmunisipaliteit. Die Projek-Aansoekers is Kudu Solar Facility 1 (Edms) Bpk tot Kudu Solar Facility 12 (Edms) Bpk.

Die voorgestelde Kudu Son Fasiliteite en meegaande infrastruktuur (Projekte 1 tot 12) sal ontwikkel word op 'n versameling van die volgende plaas gedeeltes: Gedeelte 0 (RES) van Plaas Bas Berg 88, Gedeelte 3 (RES) van Plaas Bas Berg 88, Gedeelte 4 (RES) van Plaas Bas Berg 88, Gedeelte 2 (RES) van Plaas Grass Pan 40, Gedeelte 0 (RES) van Plaas Annex Wolve Kuil 41, Gedeelte 1 (RES) van Plaas Annex Wolve Kuil 41, Gedeelte 2 van Plaas Wolve Kuil 43, en Gedeelte 0 (RES) van Plaas Wolve Kuilen 42.

Die voorgestelde Kudu Son Fasiliteite 1 tot 12 (Projekte 1 tot 12) is onderhewig aan 'n volle Bestekopname- en Omgewingsimpakstudieproses ("Scoping and EIA"), met 'n besluitnemingsperiode van 107 dae, in terme van die Nasionale Omgewingsbestuurswet (Wet No. 107 van 1998, soos gewysig) (NEMA) en die 2014 NEMA Omgewingsimpakstudie Regulasies (soos gewysig). Hiermee word dus kennis gegee van die S&EIA-Prosesse in terme van Regulasie 41 (2) (c) van die 2014 NEMA Omgewingsimpakstudie Regulasies (soos gewysig).

Afsonderlike aansoek vir Omgewingsgoedkeuring sal ingedien word by die beherende owerheid, nl. Departement van Bosbou, Visserye en die Omgewing ("DFFE"), tesame met Konsep Bestekopname Verslae vir die Kudu Son Fasiliteite 1 tot 12 (Projekte 1 tot 12). Verskeie gelyste aktiwiteite in die 2014 NEMA Omgewingsimpakstudie Regulasies (soos gewysig) is van toepassing op die voorgestelde projekte met GN R325 LN 2: Aktiwiteit 1 wat dien as die hoof aktiwiteit vir die Kudu Son Fasiliteite (Projekte 1 tot 12). Kommentaar sal ook verky word vanaf die Suid-Afrikaanse Erfenisulphronagentskap ("SAHRA") in terme van die Wet op Nasionale Erfenisulphronbronne [Wet 25 van 1999]. Die S&EIA Prosesse sal ook bevestig indien 'n Waterverbruikslisensie vereis word ingevolge die Nasionale Water Wet (Wet 36 van 1998, soos gewysig). 'n Geïntegreerde Publieke Deelneme Proses sal onderneem word vir die voorgestelde projekte, asook alle aansoekes soos vereis ingevolge ander relevante omgewingswetgewing.

Die Wetenskaplike Nywerheids- en Navorsingsraad (WNNR) is aangestel as die onafhanklike Omgewingskonsultant ("EAP") om hierdie omgewingsimpakstudie-prosesse te behartig en te bestuur namens die Projek-Aansoekers.

Geïnteresseerde en/of Belanghebbende Partye (G&BPs) word hiermee in kennis gestel van die vrylating van die Konsep Bestekopname Verslae vir die Kudu Son Fasiliteite (Projekte 1 tot 12) vir 'n 30-dae kommentaar periode, wat sal strek vanaf **9 Desember 2022 tot 30 Januarie 2023**, uitsluitend die DFFE sluitingsperiode en publieke vakansiedae. Die Konsep Bestekopname Verslae kan afgelaai word by hierdie webtuiste: <https://www.csir.co.za/environmental-impact-assessment>

**Sou u belangstel om te registreer as 'n G&BP en om kommentaar te lewer op die Konsep Bestekopname Verslae, word u vriendelik versoek om u naam en kontakbesonderhede te e-pos, asook 'n aanduiding van enige direkte, besigheids, finansiële, persoonlike of ander redes vir u moontlike belangstelling in die aansoek, aan die EAP by die WNNR: Rohaida Abed; E-pos: [ems@csir.co.za](mailto:ems@csir.co.za); Posadres: Posbus 59081, Umbilo, Durban, 4075; Tel: 031 242 2300.**

Die meegaande elektriese netwerk infrastruktuur projekte ("EGI") behels 132 kV kraglyne, ontvanger- en skakelstasies by elke Son Fasiliteit (Kudu EGI Projek 13 tot 24), 'n onafhanklike 400/132 kV hoofoordragstasie ("MTS") (Kudu EGI Projek 25), en 'n 400 kV "Loop-In-Loop-Out" ("LIL") (Kudu EGI Projek 26) ter aansluiting by die nasionale elektriese netwerk. Projekte 13 tot 26 is geleë in die Sentrale Strategiese Oordrag Korridor (Staatskennisgewing 113 in Februarie 2018) en is dus onderhewig aan 'n afsonderlike Basiese Evalueeringsproses (BA) en/of Registrasie via die Kraglynen Substasie Standaard (Staatskoerant 47095; Staatskennisgewing 2313, gedateer 27 Julie 2022). Let daarop dat afsonderlike kennisgewings gepubliseer sal word vir Projekte 13 tot 26, sodra die verslae beskikbaar is vir kommentaar.



## 2. Proof of the newspaper advertisement publishing in the Noord-Kaap Bulletin

SCOPING REPORT: Scoping and Environmental Impact Assessment (EIA) Process for the Proposed Development of a Solar Photovoltaic (PV) Facility (Kudu Solar Facility 8) and associated infrastructure, near De Aar, Northern Cape Province

8 NUUS NEWS

NoordkaapBulletin 8 Desember 2022

Vir jare se getrouheid erken: Sewe lede van die Kuruman-tak van die Vrouelandsbouvereniging (VLV) het onlangs hertekens as erkenning vir die jare wat hulle aan die vereniging behoort, ontvang. Met die VLV se jaar wat van 30 September tot 1 Oktober strek, het vyf lede hul mylpaal in 2022 behaal, terwyl twee dit reeds in 2021 behaal het. Diensjaarkopieles is op 23 November, op die tak se jaarsluiting- en prysuitdelingsgeleentheid, aan hulle oorhandig. Van links is Tinkie Erasmus (10 jaar in 2022), Janet West (15 jaar in 2022), Marinda Stander (15 jaar in 2022), Marianne Vorster (20 jaar in 2022), Magdalen de Klerk (35 jaar in 2022), Zaida Lombaard (10 jaar in 2021) en Ansie Cilliers (15 jaar in 2021). FOT: VRS&P



ITIRELENG FIRE MANAGEMENT - Using it right are just time. NORTHERN CAPE MINING OPERATION VACANCIES FIRE SYSTEMS TECHNICIAN. Qualifications and Requirements: Grade 12, Proof of training as Fire Technician (Sprinkler 101, Valve training, SANS 10139, SANS 14520), Proof of Training as a Fire Technician (In-house training, Valves, Detection & Gas Suppression), Medically fit to undergo Mining Operation Medical, Induction and Dover, Computer literacy (Microsoft Windows, Outlook, Excel), Valid drivers licence, No Criminal Record, Must be residing in the John Taolo Gaetsewe District or be willing to relocate at own costs. Experience: Understand legal requirements and enforcement of it, Must have on-site Fire Systems Technician experience, Good problem solving, inter-personal and planning skills, Experience in mining industry and understand MHSA, Experience in Quality Management, Experience in Fixed Fire Detection/Protection, System Industry, Understand SANS, ASIB, SABS, NFPA etc. standards. Closing date for applications: 31/01/2023 @ 12:00pm. Applications can be e-mailed to: bernard@itireleng.co.za (Latest Updated CV). If you have not been contacted by the company within one week after the closing date, please consider your application to be unsuccessful.

KENNISGEWING VAN DIE BESTEKOPNAME- EN ONGEWINGS-IMPAKTSTUDIEPROSESSE ("SIEBIA") VIR DIE VOORGESTELDE ONTWIKKELING VAN TWAALF SON FOTVOLTAÏESE (PV) FASILITEITE EN HEEGAANDE INFRASTRUKTUUR GELEË NABY DE AAR IN DIE NOORD-KAAP PROVINSIE. Hiermee word kennis gegee oor die Projek-Beoordelings, ABC Wind renewsable energies (Edm) Bpk, die ontwikkeling van twaalf son fotovoltaïese (PV) energie opwekkingfasiliteite en meegaande infrastruktuur, insluitende verskeie strukture, geboue en Battery Energy Storage Units ("BESU"), naby De Aar in die Noord-Kaap Provinsie. Hierdie projekte staan bekend as Kudu Son Fasiliteit 1 tot 12 (Projekte 1 tot 12). Die voorgestelde projekte is geleë in die Montserrat Plaaslike Munisipaliteit wat tot binne die Frelay Ka Seine Doelkennisgebied, Die Projek-Areomakers is Kudu Solar Facility 1 (Edm) Bpk tot Kudu Solar Facility 12 (Edm) Bpk. Die voorgestelde Kudu Son Fasiliteite en meegaande infrastruktuur (Projekte 1 tot 12) sal ontwikkel word op 'n versameling van die volgende plaas gedeeltes: Gedeelte O (RES) van Plaas Bas Berg 88, Gedeelte 3 (RES) van Plaas Bas Berg 88, Gedeelte 4 (RES) van Plaas Bas Berg 88, Gedeelte 2 (RES) van Plaas Grass Pan 40, Gedeelte O (RES) van Plaas Annex Wolve Kull 41, Gedeelte 1 (RES) van Plaas Annex Wolve Kull 41, Gedeelte 2 van Plaas Wolve Kull 42, en Gedeelte O (RES) van Plaas Wolve Kull 42. Die voorgestelde Kudu Son Fasiliteit 1 tot 12 (Projekte 1 tot 12) is onderhevig aan 'n volle Bestekopname- en Omgewingsimpaktdieproses ("Scoping and EIA"), met 'n besluitnemingstermyn van 107 dae, in terme van die Nasionale Omgewingsbestuur (Wet No. 107 van 1998, soos gewysig) (NEMA) en die 2014 NEMA Omgewingsimpaktdie Regulasies (soos gewysig). Hiermee word die kennis gegee van die S&BIA-Prosesse in terme van Regulasie 41 (2) (b) van die 2014 NEMA Omgewingsimpaktdie Regulasies (soos gewysig). Alsonderlike aansele vir Omgewingsbeoordeling sal ingedien word by die beherrende owerheid, d. Department van Bosbou, Visserie en die Omgewing ("DOP"), hierna met Konsep Bestekopname Verloof vir die Kudu Son Fasiliteit 1 tot 12 (Projekte 1 tot 12). Verskeie geleë owerheid- en die 2014 NEMA Omgewingsimpaktdie Regulasies (soos gewysig) is van toepassing op die voorgestelde projekte met GN 8225 IN 2. Akkwies 1 wat dien as die hoof owerheid vir die Kudu Son Fasiliteite (Projekte 1 tot 12). Konsultasie sal ook verkry word voor die Suid-Afrikaanse Erfenisgehoording ("SAHERG") in terme van die Wet op Nasionale Erfenisbeskerming (Wet 25 van 1999). Die S&BIA-Prosesse sal ook betrekke insluit 'n Watervervalkeienskap- en verskeie ander relevante omgewingsbeoordelings. Die Nasionale Water Wet (Wet 36 van 1998, soos gewysig), 'n Geïntegreerde Publieke Doelkennis Proses sal onderaan word vir die voorgestelde projekte, asook alle aansele soos verskeie ander relevante omgewingsbeoordelings. Die Waterskaplike Nywerheids- en Navorsingsraad (WNNR) is aangestel as die onafhanklike Omgewingskonsultant ("EAP") om hierdie omgewingsimpaktdie-prosesse te behartig en te bestuur namens die Projek-Areomakers. Geïntegreerde en/of Belanghebbende Partye (G&BP) word hiermee in kennis gestel van die vrylating van die Konsep Bestekopname Verloof vir die Kudu Son Fasiliteit (Projekte 1 tot 12) vir 'n 30-dag kommentaar periode, wat sal strek vanaf 8 Desember 2022 tot 30 Januarie 2023, sluitend die DIFE sluitingsperiode en publieke konsultasie. Die Konsep Bestekopname Verloof kan oplaai word by hierdie webtuiste: https://www.csir.co.za/environmental-impact-assessment. Sou u belangstel om te registreer as 'n G&BP en om kommentaar te lewer op die Konsep Bestekopname Verloof, is 'n vriedelike versoek om u naam en kontakbesonderhede te stuur, asook 'n aanduiding van enige direkte, bestaande, finansiële, persoonlike of ander belanghebbende verhoudings in die aansele, om die EAP by die WNNR: Rhoeliso Abadi; E-pos: ems@csir.co.za; Posadres: Posbus 59081, Unibulo, Durban, 4075; Tel: 031 242 2300. Die meegaande elektriese netwerk infrastruktuur projekte ("EGT") behels 132 kV lynlyne, owerstroom en skakelstasies by alle Son Fasiliteit Kudu EGI Projek 13 tot 24), 'n onafhanklike 400/132 kV hoofopdragstasie ("MITS") (Kudu EGI Projek 25), en 'n 400 kV "top-to-top" ("TTO") (Kudu EGI Projek 26) ter ontwikkeling by die nasionale elektriese netwerk. Projekte 13 tot 26 is geleë in die Setrole Strategieë Ooring Kudu (Stoekopneming 113 in Februarie 2018) en is die onderwerp van 'n afsonderlike Basiese Evallingsproses (BA) en/of Registrasie via die Kraglyn- en Substansie Standaard (Stoekopneming 47095; Stoekopneming 2313, gedeelte 27 Julie 2022). Let daarop dat afsonderlike kennisgewings gepubliseer sal word vir Projekte 13 tot 26, sodra die verskeie beskikbaar is vir kommentaar.

Exercise holds benefits

Physical inactivity lists amongst the risks contributing to diabetes, heart disease and hypertension. To promote physical activity, a healthy lifestyle and balanced nutrition, the Northern Cape Department of Health recently hosted a campaign in Tsing in the Joe Morolong Local Municipality. At the event, MEC Maruping Lekwene took part in an aerobic session, and urged community members to engage in daily activities that exercise the body in order to stave off medical conditions and ill health. Maruping emphasised that exercise builds stronger bones, lowers blood pressure, lowers cholesterol, burns excess fat, boosts immunity, reduces cancer risk factors, increases self-esteem, improves mental sharpness, lessens depression and anxiety, and eases stress levels.

Petra Diamonds Limited is one of the world's leading suppliers of rough diamonds and one of the largest independent diamond groups by resource. It's a polished diamond we're after for this role - an individual that clearly outshines his/her peers. Petra Diamonds FINSCH DIAMOND MINE (PTY) LTD. Draw Control Officer. Finsch Diamond Mine is located in the town of Lime Acres, which is situated 160km north-west of Kimberley and 166km south of Kuruman in the Northern Cape. Job Reference Nr: FINS25 Job Grade: C2. ROLE DESCRIPTION: Reporting to the Specialist: Geotechnical Engineering, the role will collect and capture information on draw point conditions and draw point loading, and monitor adherence to the Draw Control Plan. Recommend corrective actions as and when required. MINIMUM REQUIREMENTS: Grade 12, A minimum of 2 years' mining experience in a Trackless Mobile Machinery Environment - PLEASE CLEARLY SPECIFY ON YOUR CV, A minimum of 2 years' underground caving experience - PLEASE CLEARLY SPECIFY ON YOUR CV, Knowledge of geology and ground conditions - PLEASE CLEARLY SPECIFY ON YOUR CV, Computer Literacy and Microsoft Office Suite, Valid Drivers' Licenses. ADVANTAGE: Degree in Geology/Engineering Geology/ Mining Engineering. Finsch Diamond Mine is an equal opportunity employer. Preference will be given to suitable candidates from the designated groups in line with the Company's Employment Equity Policy and Plan and internal candidates. Pre-screening, profile testing, assessments, medical and security clearance form part of the recruitment and selection process. Short listed candidates will be required to attend a panel interview. Employment of the successful candidate is subject to the aforementioned criteria. Preference will be given to candidates who reside within our host labour sending area of Kgatelopele (proof of residence may be requested). please complete an application form (available on http://www.petradiamonds.com/careers/current-vacancies) and forward, together with your résumé, qualifications and ID, to E1: recruitment@petradiamonds.com by 13 December 22. Please note, applications must be sent to the correct e-mail as indicated. Incomplete application forms and documentation will not be considered. Correspondence will be limited to short-listed candidates only, Petra Diamonds reserves the right not to fill this position. If you have not heard from us within 30 days of the closing date, please regard your application as unsuccessful. Please note that Petra Diamonds does not at any time require any form of payment for recruitment purposes and if you are approached in this regard, you should report the incident immediately to your local SARS or via one of the following hotlines: Toll Free: 0800 007 247; Phone Call: +27 31 571 5573; Fax: +27 31 560 7395; Email: tothelmine@tip-offs.com; Post: KZ 136, Umhlanga Rocks, 4320; Website: www.tip-offs.com http://www.petradiamonds.com/careers/current-vacancies

CSIR Southern Cross Research Institute. Die meegaande elektriese netwerk infrastruktuur projekte ("EGT") behels 132 kV lynlyne, owerstroom en skakelstasies by alle Son Fasiliteit Kudu EGI Projek 13 tot 24), 'n onafhanklike 400/132 kV hoofopdragstasie ("MITS") (Kudu EGI Projek 25), en 'n 400 kV "top-to-top" ("TTO") (Kudu EGI Projek 26) ter ontwikkeling by die nasionale elektriese netwerk. Projekte 13 tot 26 is geleë in die Setrole Strategieë Ooring Kudu (Stoekopneming 113 in Februarie 2018) en is die onderwerp van 'n afsonderlike Basiese Evallingsproses (BA) en/of Registrasie via die Kraglyn- en Substansie Standaard (Stoekopneming 47095; Stoekopneming 2313, gedeelte 27 Julie 2022). Let daarop dat afsonderlike kennisgewings gepubliseer sal word vir Projekte 13 tot 26, sodra die verskeie beskikbaar is vir kommentaar.

NOTICE OF PUBLIC PARTICIPATION FOR BASIC ENVIRONMENTAL IMPACT ASSESSMENT PROCESS AND PROSPECTING RIGHT APPLICATION. Notice is hereby given in terms of Regulation 41 of the Environmental Impact Assessment Regulations 2014, made under Section 24(5) of the National Environment Management Act (Act No. 107 of 1998) and published in Government Gazette with section 16(4) of 2014 read together with section 16(4) of the Mineral and Petroleum Resource Development Act (Act No: 28 of 2002) as amended of intent to carry out the following activity: Proposed prospecting activity of Iron ore, Manganese ore and Diamond on the farm Eldon 456 and is accessed approximately 30.1km south west of Kuruman along the N14 route to Khathu within the jurisdiction of Gamagara Local Municipality, John Taolo Gaetsewe District of Northern Cape Province. DMR Ref No: NC 30/5/1/1/2/1319 PR. Site Co-ordinates: S: 270 34' 14.0" E: 230 09' 33.4", S: 270 34' 13.4" E: 230 09' 51.2", S: 270 33' 53.6" E: 230 12' 38.9", S: 270 36' 20.6" E: 230 12' 51.8", S: 270 36' 52.0" E: 230 09' 22.4". The proposed development activity falls within the categories of R 983 Activity 20 and therefore requires Basic Assessment Process. Please be informed that the Consultative Basic Assessment Report and the Environmental management programme is available for comments for 30 days excluding public holidays from date of publication of this notice (08 December 2022 to 26 January 2023). In order to participate in the process, or to provide comments and/or to register as an interested and Affected Parties (I&APs) pertaining to the above-proposed development, you are invited to contact the consulting, TPR Mining Resources (Pty) Ltd and the applicant, Addwatt (Pty) Ltd at the details given below: PARTICULARS OF ENVIRONMENTAL CONSULTANT: TPR Mining Resources (Pty) Ltd, Contact: Mr. Thato Ramoraswi, No:29 Woltemde Street, Witbaars 1035, Tel: 087 980 5800, Fax: 086 590 3318, Email: info@tprmining-resources.co.za. PARTICULARS OF THE APPLICANT: Addwatt (Pty) Ltd, Contact: Mr. Ntuli Dumisane, 14A Borax Street, Johannesburg 1549, Cell: 072 188 4792, Tel: 011 907 3554, Email: dumisane.Ntuli@sphandile.co.za

3. Proof of the newspaper advertisement publishing in the Echo / Midland News



SCOPING REPORT: Scoping and Environmental Impact Assessment (EIA) Process for the Proposed Development of a Solar Photovoltaic (PV) Facility (Kudu Solar Facility 8) and associated infrastructure, near De Aar, Northern Cape Province

**KLEINGELD ATTORNEYS**  
**J.H. SMITH**

All persons having claims against the under-mentioned estate must lodge it with the Executor concerned within 30 days (or as indicated) from date of publication hereof.  
 Late estate: JORAN HENDRIK SMITH, ID-no. 531201, 5097 08, date of birth 1959-12-01, date of death 2014-12-04 of 13 Lavena Meers, Pellaier, Bloemfontein, Province of the Master's Office Free State and Master's Office Free State. Estate-no. 4938/2020.  
 KLEINGELD ATTORNEYS, Albertus Jacobus Kleingeld, Escocheur of Gemontolde Apenl, 42 Totius Street, Langenhovenpark, Bloemfontein, 9301. Tel. 051 492 5353. Epos: jah@kleingeld.co.za

**BOEDELS LIKWIDASIE EN DISTRIBUSIE**

**E. de Villiers**  
 ROEDELKONINGSWEGING

IN DIE BOEDEL VAN WYLE: ELSIE DE VILLIERS BOEHRER NR. 5195/2022. MEESTERS-KANTOOR: BLOEMFONTEIN ID NR. 44125-026-080 STERDADATUM: 21/01/2022 GEBOORTEDATUM: 25/11/1964  
 LAASTE ADRES: KOMMANDANT ERWEE STRAAT 23, WILGENHOF, BLOEMFONTEIN Die Erster en Finale Likwidasie en Distribusierekening in hoedanige boedel sal ter issue lê in die kantoor van die Meester van die Hoogeregshof, BLOEMFONTEIN vir 'n periode van 21 (EEN EN TWINTIG) dae vanaf publikasie hiervan. Indien binne gemelde tydperk geen bewyse daarteen by die betrokke Meester ingedien word nie, gaan die Ekskuteur oor tot die uitbetalings, ingevolge die rekening.

VERBODEN STRAAT 106/WALDELL 1076, ERKKA LAW INC. (Pty) Ltd 6369, chanel@erkkalaw.co.za

**J.K. MOLEKO**  
 IN THE ESTATE OF THE LATE: JEFFREY KEMOELI MOLEKO IDENTITY NUMBER: 720822 5056 088 Date of death: 17 AUGUST 2018 ADDRESS: 35 TIBBE VISSEER AVENUE BLOEMFONTEIN ESTATE NUMBER: 000972/2020  
 Notice is hereby given that the First and Final Liquidation and Distribution Account will lie for inspection at the Master of the Free State High Court, Bloemfontein for a period of twenty-one (21) days from FRIDAY the 9th OF DECEMBER 2022.

WERNER VERMAAK ATTORNEYS No 7 WALDORF BUILDING MERRIAM MAKEBA STREET BLOEMFONTEIN PO BOX 26827 LANGENHOVENPARK 9300 TEL: 051 447 1517 FAX: 056 7472 531

**10**  
**Geklassifiseerd**  
**ROEDELKONINGSWEGING**  
**BOEDELS LIKWIDASIE EN DISTRIBUSIE**  
**Standard**  
 This estate is being administered by a Master of the High Court.  
**M.A. Makatsa**

In the estate of the late MALESHOANE ALICE MAKATSA, ID-no. 4700295929/2022, date of birth 29 August 1947, date of death 24 November 2017, of Section 2206, Botshabelo Riv. 9028/2018. The First and Final Liquidation and Distribution Account in the above estate will lie for inspection at the office of the Master of the High Court, Bloemfontein, for a period of three weeks from the date of publication hereof.

**W.J. GERMISHUYS LIQUIDATION AND DISTRIBUTION ACCOUNTS IN DECEASED ESTATES LYING FOR INSPECTION**

In terms of section 35 (5) of the Administration of Estates Act, No. 66 of 1965, notice is hereby given that copies of the liquidation and distribution accounts (First and final, unless otherwise stated) in the estates specified below will be open for the inspection of all persons with an interest therein for a period of 21 days (or shorter or longer if specially stated) from the date of publication hereof, whichever may be the later, and at the offices of the Masters of the High Court and Magistrates on stated. Should no objection thereto be lodged with the Masters concerned during the specified period, the executors will proceed to make payments in accordance with the accounts.  
 Late estate WILLEM JACOBUS GERMISHUYS, ID-no. 641101, 9923 06 7 of 102 Thom Street, Aandrus, Willoors, Bloemfontein, 9301. Province of the Master's Office Free State and Master's Office Bloemfontein. Estate-no. 008299/2021.  
 ADV. S.J. VERVEULEN & ASSOCIATES, PO Box 2887, Bellville, 7530. Epos: sj@verveulen-consult.co.za, Tel. 021 948 2365.

**EIENDOMME**

**NIEMANN**  
 PROKUREURS & EIENDOMME  
**WOONSTEL TE HUUR**  
**2 slk, 1 badkamer, WILLOWS, R6 500 pm**  
 Skakel 051 411 5800 tussen kantoorure rentals@niemannattorneys.co.za

**Bloem NEWS**  
 Donderdag 8 Desember 2022  
**bloem organic COMPOST**  
 ORGANIC COMPOST BARK SEEDLING MIX  
 LAWN DRESSING SUCCULENT MIX  
 GARDEN & POTTING SOIL VERMICULITE  
 AVAILABLE IN BAGS AND IN M<sup>3</sup> BULK  
**www.kompos.co.za**  
**076 066 9407**

**KENNISGEWING VAN DIE BESTEKOPNAME EN OHGEWINGS-IMPAKSTUDIEPROSESSE ("SOEIA") VIR DIE VOORGESTELDE ONTWIKKELING VAN TWAALF SON FOTOVOLTAÏESE (PV) FASILITEITE EN HEGGAANDE INFRASTRUKTUUR GELIEK NABY DE AAR IN DIE NOORD-KAAP PROVINIE**  
 Hiermee word kennis gegee dat die Projek-Ornwelkelaar, ABC Wind-renewable energie (Edms) Bpk, die ontwikkeling voorleer van twaalf (12) son-fotovoltaïese (PV) energie-opwekkingfasiliteite om meegangende infrastruktuur, insluitende verkeerstrukture, geboue en Battery Energy Bergingsstasie ("BESS"), naby De Aar in die Noord-Kaap Provinsie. Hierdie projekte staan bekend as Kudu, Son Fasiliteit 1 tot 12. Projek 1 tot 12). Die voorgestelde projekte is geleë in die Konsering Plaaslike Munisipaliteit wat wil binnedie Pletky Ka Some (Edms) Konsorsium. Die Projek-Aansoekers is Kudu Solar Facility 1 (Edms) Bpk tot Kudu Solar Facility 12 (Edms) Bpk.

Die voorgestelde Kudu, Son Fasiliteite en meegangende infrastruktuur (Projekte 1 tot 12) sal ontwikkel word op 'n versameling van die volgende alreeds geïdentifiseerde: Gedeelte 0 (RES) van Plaas Bas Berg 88, Gedeelte 3 (RES) van Plaas Bas Berg 88, Gedeelte 4 (RES) van Plaas Bas Berg 88, Gedeelte 2 (RES) van Plaas Oos Fan 40, Gedeelte 0 (RES) van Plaas Annes Wolwe Kull 41, Gedeelte 1 (RES) van Plaas Annes Wolwe Kull 41, Gedeelte 2 van Plaas Molke Kull 42, 'n Gedeelte 0 (RES) van Plaas Molke Kull 42.  
 Die voorgestelde Kudu, Son Fasiliteite 1 tot 12, Projek 1 tot 12) is onderhevig aan 'n volle Bestekopname en Omgewingsimpakstudieprosesse ("Scoping and EIA"), met 'n bestekopnamperiodes van 107 dae, in terme van die Nasionale Omgewingsbeoordelingswet (Wet No. 107 van 1998, soos gewysig) (NEMA) en die 2014 NEMA Omgewingsimpakstudie Regulasie (soos gewysig). Hiermee word kennis gegee van die SOEIA-Prosesse in terme van Regulasie 41 (2) (b) van die 2014 NEMA Omgewingsimpakstudie Regulasie (soos gewysig).

Afsonderlike oorsake vir Omgewingsbeoordelings sal ingedien word by die beharende owerheid, d. Departement van Bosbou, Visserye en die Omgewing ("DFFE"), saam met Konsep Bestekopname Verleer vir die Kudu, Son Fasiliteite 1 tot 12, Projek 1 tot 12). Verreke politiese oorsake in die 2014 NEMA Omgewingsbeoordelings Regulasie (soos gewysig) is van toepassing op die voorgestelde projekte met GN R325 (N 2) Akkwies 1 wat dies is die hoed omtrent vir die Kudu, Son Fasiliteite (Projekte 1 tot 12). Kommentaar sal ook verkry word vanaf die Suid-Afrikaanse Erfenisbehoudingsagentskap ("SABHA") in terme van die Wet op Nasionale Erfenisbehouding (Wet 25 van 1999). Die SAGSA-Fraanse sal ook beregt indien 'n Waterverbruiksensensie verens word ingedien vir die Nasionale Water Wet (Wet 26 van 1998, soos gewysig). 'n Deiningende Fabelle Deelhore Proses sal onderneem word vir die voorgestelde projekte, soos alle oorsake soos verens ingevolge ander relevante omgewingswetgewing.  
 Die Waterreëlings Nyevalasie en Nyevalasie (NENE) is ingestel as die onafhanklike Omgewingsbeoordelings ("EAP") om hierdie omgewingsimpakstudieprosesse te behoring en bestuur namens die Projek-Aansoekers.  
 Gedeeltesende eriel belanghebbende Partye (SABPA) word hiermee in kennis gestel van die vrylating van die Konsep Bestekopname Verleer vir die Kudu, Son Fasiliteite (Projekte 1 tot 12) vir 'n 30-dae kommentaar periodes, wat sal anek vanaf **9 Desember 2022 tot 30 Januarie 2023**, insluitend die DPE sluitingsperiodes en publieke rakonsies. Die Konsep Bestekopname Verleer kan afgebol word by hierdie webuiste: <https://www.ca.gov.za/en/monetized-impact-assessment>.  
**Sou u belangstel om te registreer as 'n G&EP en om kommentaar te lever op die Konsep Bestekopname Verleer, word u vriendelik versoek om u naam en kontakbesonderdele te epos, asook 'n aanduiding van enige direkte, bestaande, bestaende, persoonlike of ander redes vir u moontlike belangstelling in die oomsake, om die EAP by die WNNR: Bokside Alreel E-pos: em@ca.gov.za; Posadres: Postbus 99081, Unibell, Durban, 4075; tel 031 242 2300.**  
 Die meegangende elektriese netwerk infrastruktuur projekte ("EGP") behels 132 kV lynreëls; omvatter en distriboelinge van elke Son Fasiliteit (Kudu EGP Projek 13 tot 24), 'n onafhanklike 400/132 kV hoofontspannings ("MST") (Kudu EGP Projek 25), en 'n 400 kV "hoofspannings" ("LTO") (Kudu EGP Projek 26) ter omdringing by die nasionale elektriese netwerk. Projekte 13 tot 26 is geleë in die Sentrale Strategiese Oordrag Korridor (Staatseingewing 113 in Februarie 2018) en is die onderhevig aan 'n afsonderlike Sosiale Evalueringsproses (SA) en/of Regulasie via die Kragreëls en Substansie Standaard (Stoorningsaan 47095; Stoorningsingewing 23.3, gedeelte 27 Julie 2022). Let daarop dat afsonderlike kennisgewings gepubliseer sal word vir Projekte 13 tot 26, sodra die veralre beskikbaar is vir kommentaar.

**WELKOM YIZANI**

**VOORMALIGE AANDEELHOUDERS VAN WELKOM YIZANI BELEGINGS (RF) EIENDOMS BEPERK (IN LIKWIDASIE)**

**KOM KRY JOU GELD**  
 Sommige voormalige aandeelhouers in Welkom Yizani het nog nie hul dividende opegnis nie. Media24 Beherend (Edms) Bpk, in samewerking met die likwidateur van Welkom Yizani, sien om na die belange van hierdie voormalige aandeelhouers en hou die onopgevrage dividende namens hulle in veilige bewaring.

"Die geld behoort aan die voormalige aandeelhouers van Welkom Yizani. Ons doen 'n beroep op hulle om ons te kontak sodat hulle hul geld kan kry. Ons wil in hierdie moeilike ekonomiese tyd alles in ons vermoë doen om te verseker hulle kry die geld wat hul wetlik toekom."

Prof. Rachel Jafa, Voorster van Media24 Beherend (Edms) Bpk  
 As jy, of iemand wat jy ken, tussen 2006 en 2021 Welkom Yizani-aandele besit het, en nog nie al jou dividende ontvang het nie, kontak ons asseblief by:  
  
**welkomyizani@singularservices.co.za**

**0860 12 12 24**  
 Alle else sal deur 'n proses gaan om regmatigheid daarvan te bevestig.  
**MEDIA24**

**Bereik jou teikenmark elke week, ten spyte van beurtkrag!**  
**Gee die impak van beurtkrag 'n uitklophou!**  
**Kontak Coleen Cilliers 083 411 1064**  
**Bloem NEWS** **Vrystaat KROON** **Vista** **BULLETIN** **Express**



## APPENDICES

SCOPING REPORT: Scoping and Environmental Impact Assessment (EIA) Process for the Proposed Development of a Solar Photovoltaic (PV) Facility (Kudu Solar Facility 8) and associated infrastructure, near De Aar, Northern Cape Province

---

### **APPENDIX E.8: CORRESPONDENCE AND PROOF OF CORRESPONDENCE SENT TO STAKEHOLDERS FOR THE DRAFT SCOPING REPORT RELEASE**

*App. E.8/...*

1. Letter 2 sent via email to I&APs, Stakeholders and Organs of State: Notification of the

## APPENDICES

### SCOPING REPORT: Scoping and Environmental Impact Assessment (EIA) Process for the Proposed Development of a Solar Photovoltaic (PV) Facility (Kudu Solar Facility 8) and associated infrastructure, near De Aar, Northern Cape Province

#### Release of the Draft Scoping Report for a 30-day Comment Period



#### CSIR Environmental Management Services

P. O. Box 59081, Umbilo, 4075  
Tel: 031 242 2300  
Email: ems@csir.co.za

9 December 2022

Dear Interested and Affected Party

**RE: NOTIFICATION OF THE RELEASE OF 12 DRAFT SCOPING REPORTS FOR A 30-DAY COMMENT PERIOD FOR THE PROPOSED DEVELOPMENT OF 12 SOLAR PHOTOVOLTAIC (PV) FACILITIES (I.E. KUDU SOLAR FACILITIES 1 TO 12) AND ITS ASSOCIATED INFRASTRUCTURE, NEAR DE AAR, NORTHERN CAPE (DFFE REFERENCE NUMBER: TO BE ASSIGNED)**

Notice is hereby given that the Project Developer, ABO Wind renewable energies (Pty) Ltd, is proposing the development of 12 Solar Photovoltaic (PV) Facilities and associated infrastructure to be located north-east of the town of De-Aar in the Northern Cape Province. The proposed projects are located within the Renosterberg Local Municipality and Pixley Ka Seme District Municipality; and they form part of a cluster of the following developments:

- **PROJECTS 1 TO 12:** The proposed development of 12 Solar PV Facilities and associated infrastructure (i.e. Kudu Solar Facility 1 to Kudu Solar Facility 12).
- **PROJECTS 13 TO 24:** The proposed development of switching stations and collector stations at each on-site substation complex at each of the 12 Kudu Solar Facilities, and up to 12 x 132 kV overhead power lines running from each Solar PV Facility to the proposed collector stations or up to the proposed Main Transmission Substation (MTS).
- **PROJECT 25:** The proposed development of an independent 400/132 kV MTS, including associated infrastructure at the MTS.
- **PROJECT 26:** The proposed development of a 400 kV Loop-In-Loop-Out (LILO) from the existing Hydra-Perseus 400 kV overhead power line to the proposed MTS.

A project Background Information Document (BID) was made available for comment in June and July 2022. At the BID stage, up to 30 projects were proposed; however, this has now reduced to a total of 26 projects, as indicated above.

The proposed Kudu Solar Facilities will comprise various infrastructure, such as a solar field, building infrastructure, an on-site substation complex, Lithium-Ion or Redox Flow Battery Energy Storage System (BESS), as well as associated infrastructure (e.g., laydown area; internal roads; fencing; storm water channels; panel maintenance and cleaning area; underground low voltage cables or cable trays; and 22 or 33 kV internal underground power lines).

Projects 1 to 12 are not located within any of the Renewable Energy Development Zones (REDZs) gazetted in Government Notice (GN) 114 on 16 February 2018; and GN 144 on 26 February 2021. Therefore, the proposed projects are subject to full Scoping and Environmental Impact Assessment (EIA) Processes and a decision-making period of 107 days, in terms of the National Environmental Management Act (Act 107 of 1998, as amended) (NEMA) and the 2014 NEMA EIA Regulations (as amended). The Scoping and EIA Processes for Projects 1 to 12 are currently being undertaken, whereas the relevant Environmental Assessment processes for Projects 13 to 26 will be undertaken at a later stage. An integrated Public Participation Process (PPP) is being undertaken for the proposed projects, as well as all applications necessary in respect of other applicable legislation.

Notice of the Scoping and EIA Processes is thus given in terms of Regulation 41 (2) (b) of the 2014 NEMA EIA Regulations (as amended). The proposed projects trigger various listed activities in terms of the 2014 NEMA EIA Regulations (as amended); with Activity 1 of Listing Notice 2 (GN R325) serving as the main activity. Refer to Chapter 4 of the Draft Scoping Reports for the detailed list of listed activities, which require authorisation and thus form part of the Scoping and EIA Processes. An Application for Environmental Authorisation (EA) for each Kudu Solar Facility project has been separately submitted to the National Department of Forestry, Fisheries, and the Environment (DFFE), as the Competent Authority, along with the Draft Scoping Reports for comment.

In line with the above, as a registered stakeholder and Interested and/or Affected Party (I&AP) on the project database, you are hereby notified of the release of the Draft Scoping Reports for the 12 proposed Kudu Solar Facility projects for a 30-day comment period, which extends from **09 December 2022 to 30 January 2023** (excluding the DFFE regulated shutdown period).

Board members: Prof. T. Majozl (Chairperson), Dr A. Childs, Dr R. Masango, Mr S. Masie,  
Ms T. Mokhabuki, Dr V. Mithelwa, Mr J. Nelshitenzhe, Dr C. Render, Mr C. Shariff, Dr T. Dlamini (CEO)

[www.csir.co.za](http://www.csir.co.za)

## APPENDICES

### SCOPING REPORT: Scoping and Environmental Impact Assessment (EIA) Process for the Proposed Development of a Solar Photovoltaic (PV) Facility (Kudu Solar Facility 8) and associated infrastructure, near De Aar, Northern Cape Province

---

The Draft Scoping Reports can be accessed on the project website (<https://www.csir.co.za/environmental-impact-assessment>). As a supplementary mechanism, the Draft Scoping Reports can also be downloaded from the following link on Google Drive: [https://bit.ly/KUDU\\_SOLAR\\_PV](https://bit.ly/KUDU_SOLAR_PV)

Should you wish to register as an I&AP and/or to provide comments on the Draft Scoping Reports, you are kindly requested to e-mail, fax or mail your name, contact details and project-related comments to the CSIR at the contact details provided below by **30 January 2023**:

- Attention: Rohaida Abed
- Email: [ems@csir.co.za](mailto:ems@csir.co.za)
- Postal address: P.O. Box 59081, Umbilo, Durban, 4075
- Tel: 031 242 2300

Copies of all comments received from I&APs and stakeholders during the review of the Draft Scoping Reports will be collated into the Comments and Response Reports and included as an appendix to the Final Scoping Reports and will include relevant responses to the comments. The Final Scoping Reports will be submitted to the DFFE for decision-making in line with Regulation 21(1) and Regulation 22 of the 2014 NEMA EIA Regulations (as amended).

In accordance with the Protection of Personal Information Act (Act 4 of 2013), CSIR will conduct itself responsibly when collecting, processing, storing and sharing any personal information collected for the purposes of PPP in terms of the 2014 NEMA EIA Regulations (as amended). By registering as an I&AP and/or submitting information and comments, you consent to the collection, collation, processing, and storing of such information and the use and disclosure of such information for the aforementioned purpose (<https://www.csir.co.za/csir-privacy-notice>). If you would like to opt out of communications on this project, please do so by responding to this correspondence via email.

We thank you in advance for your participation in these Scoping and EIA Processes. Should you have any queries or require additional information, please do not hesitate to contact the undersigned using the contact details provided above.

Sincerely,



Paul Lochner *Registered EAP*  
EMS Manager and Project Leader  
CSIR - Environmental Management Services



Rohaida Abed *Pr. Sci. Nat.*  
Project Manager  
CSIR - Environmental Management Services

## APPENDICES

SCOPING REPORT: Scoping and Environmental Impact Assessment (EIA) Process for the Proposed Development of a Solar Photovoltaic (PV) Facility (Kudu Solar Facility 8) and associated infrastructure, near De Aar, Northern Cape Province

---

### 2. Email 2 sent to I&APs, Stakeholders and Organs of State on 9 December 2022

---

**From:** EMS  
**Sent:** Friday, 09 December 2022 15:06  
**To:** EMS  
**Subject:** RE: Availability of Draft Scoping Reports for Comment - Kudu Solar PV  
**Attachments:** Kudu Solar\_Letter 2\_DSR Release\_General IAPs\_FINAL\_091222.pdf

**Categories:** This message has been archived by Retain on December 16 2022 20:36

Dear Stakeholders and I&APs

**RE: NOTIFICATION OF THE RELEASE OF DRAFT SCOPING REPORTS FOR A 30-DAY COMMENT PERIOD FOR THE PROPOSED DEVELOPMENT OF 12 SOLAR PHOTOVOLTAIC (PV) FACILITIES (I.E. KUDU SOLAR FACILITIES) AND VARIOUS ASSOCIATED INFRASTRUCTURE, NEAR DE AAR, NORTHERN CAPE**

Notice is hereby given that the Project Developer, ABO Wind renewable energies (Pty) Ltd, is proposing to develop the Kudu Solar Photovoltaic (PV) cluster, consisting of up to 12 Solar PV Facilities, associated infrastructure and Electricity Grid Infrastructure (EGI), north-east of the town of De-Aar, in the Renosterberg Local Municipality and Pixley Ka Seme District Municipality, in the Northern Cape Province. The generation capacity of each PV Facility will range from approximately 50 MWac to up to 350 MWac.

As noted below, a project Background Information Document (BID) was released for comment in June and July 2022, and at that stage a total of up to 30 projects were being proposed (i.e. 14 PV Projects and 16 EGI Projects). The number of projects has now decreased to 28 (i.e. 12 PV Projects and 14 EGI Projects).

The Solar PV Facilities (Projects 1 to 12) require Scoping and Environmental Impact Assessment (EIA) Processes. The EGI (Projects 13 to 28) will require Basic Assessment (BA) Processes or will be subjected to separate registration processes in terms of the EGI Standard (Government Gazette (GG) 47095; Government Notice (GN) 2313, dated 27 July 2022), or may require a hybrid approach depending on the sensitivities found within the EGI corridor.

The Scoping and EIA Processes for the 12 Solar PV Facilities are currently being undertaken, and the EGI projects will be considered at a later stage.

The Council for Scientific and Industrial Research (CSIR) has been appointed as the Environmental Assessment Practitioner (EAP) to undertake the required Environmental Assessments.

Separate Applications for Environmental Authorisation (EA) have been submitted to the DFFE for the proposed Solar PV Facilities. The Draft Scoping Reports for these projects are hereby released for a 30-day public comment period, which extends from **9 December 2022** to **30 January 2023** (excluding the regulated shutdown period). Refer to the attached correspondence for additional information.

The Draft Scoping Reports can be accessed as follows:

- Google Drive: [https://bit.ly/KUDU\\_SOLAR\\_PV](https://bit.ly/KUDU_SOLAR_PV)
- Project website: <https://www.csir.co.za/environmental-impact-assessment>

You are kindly requested to register your interest and submit any comments you may have on the Draft Scoping Reports to the CSIR (details are provided below and in the attached).

Please do not hesitate to contact us should you have any queries relating to the above.

## APPENDICES

### SCOPING REPORT: Scoping and Environmental Impact Assessment (EIA) Process for the Proposed Development of a Solar Photovoltaic (PV) Facility (Kudu Solar Facility 8) and associated infrastructure, near De Aar, Northern Cape Province

---

In accordance with the Protection of Personal Information Act (Act 4 of 2013), the CSIR will conduct itself responsibly when collecting, processing, storing and sharing any personal information collected for the purposes of Public Participation Processes (PPP) in terms of the 2014 NEMA EIA Regulations (as amended). By registering as an Interested and Affected Party (I&AP) and/or submitting information and comments, you consent to the collection, collation, processing, and storing of such information and the use and disclosure of such information for the aforementioned purpose (<https://www.csir.co.za/csir-privacy-notice>). If you would like to opt out of communications on this project, please do so by responding to this correspondence via email.

Kind Regards,  
Rohaida Abed

CSIR Environmental Management Services  
E-mail: [ems@csir.co.za](mailto:ems@csir.co.za)  
Postal Address: P.O. Box 59081, Umbilo, Durban, 4075  
Tel: 031 242 2300

---

## APPENDICES



















### SCOPING REPORT: Scoping and Environmental Impact Assessment (EIA) Process for the Proposed Development of a Solar Photovoltaic (PV) Facility (Kudu Solar Facility 8) and associated infrastructure, near De Aar, Northern Cape Province

#### 3. Proof of Delivery of Email 2 sent to all I&APs, Stakeholders and Organs of State on 9 December 2022

EMS - Delivery Reports						By Date ▾ ↑
	From	Subject	Received ▾	Size	Categories	Mention
▼ Last Month						
		<b>Mail Delivery... Undeliverable: Availability of Draft Scoping Reports for Comment - Kud...</b> Sat 17 Dec 2022... 31 KB <b>This message ...</b> <small>[You don't often get email from mailer-daemon@pta-smg4.csir.co.za. Learn why this is important at <a href="https://aka.ms/LearnAboutSenderIdentification">https://aka.ms/LearnAboutSenderIdentification</a> ] This is the mail</small>				
		<b>Mail Delivery... Undeliverable: Availability of Draft Scoping Reports for Comment - Kud...</b> Wed 14 Dec 202... 34 KB <b>This message ...</b> <small>[You don't often get email from mailer-daemon@pta-smg4.csir.co.za. Learn why this is important at <a href="https://aka.ms/LearnAboutSenderIdentification">https://aka.ms/LearnAboutSenderIdentification</a> ] This is the mail</small>				
		<b>Mail Delivery... Undeliverable: Availability of Draft Scoping Reports for Comment - Kud...</b> Wed 14 Dec 202... 41 KB <b>This message ...</b> <small>[You don't often get email from mailer-daemon@pta-smg4.csir.co.za. Learn why this is important at <a href="https://aka.ms/LearnAboutSenderIdentification">https://aka.ms/LearnAboutSenderIdentification</a> ] This is the mail</small>				
		<b>Mail Delivery... Relayed: Availability of Draft Scoping Reports for Comment - Kudu Sola...</b> Mon 12 Dec 202... 72 KB <b>This message ...</b> <small>[You don't often get email from mailer-daemon@pta-smg4.csir.co.za. Learn why this is important at <a href="https://aka.ms/LearnAboutSenderIdentification">https://aka.ms/LearnAboutSenderIdentification</a> ] This is the mail</small>				
		<b>Mail Delivery... Undeliverable: Availability of Draft Scoping Reports for Comment - Kud...</b> Mon 12 Dec 202... 37 KB <b>This message ...</b> <small>[You don't often get email from mailer-daemon@delivery.e-purifier.com. Learn why this is important at <a href="https://aka.ms/LearnAboutSenderIdentification">https://aka.ms/LearnAboutSenderIdentification</a> ]</small>				
		<b>Mail Delivery... Undeliverable: Availability of Draft Scoping Reports for Comment - Kud...</b> Mon 12 Dec 202... 44 KB <b>This message ...</b> <small>[You don't often get email from mailer-daemon@pta-smg4.csir.co.za. Learn why this is important at <a href="https://aka.ms/LearnAboutSenderIdentification">https://aka.ms/LearnAboutSenderIdentification</a> ] This is the mail</small>				
		<b>Mail Delivery... Relayed: Availability of Draft Scoping Reports for Comment - Kudu Sola...</b> Mon 12 Dec 202... 78 KB <b>This message ...</b> <small>[You don't often get email from mailer-daemon@pta-smg4.csir.co.za. Learn why this is important at <a href="https://aka.ms/LearnAboutSenderIdentification">https://aka.ms/LearnAboutSenderIdentification</a> ] This is the mail</small>				
		<b>postmaster@... Undeliverable: RE: Availability of Draft Scoping Reports for Comment - ...</b> Mon 12 Dec 202... 246 KB <b>This message ...</b> <small>[The e-mail server of the sender could not be verified (SPF Record)]</small>				
		<b>Mail Delivery... Relayed: Availability of Draft Scoping Reports for Comment - Kudu Sola...</b> Mon 12 Dec 202... 74 KB <b>This message ...</b> <small>[You don't often get email from mailer-daemon@pta-smg4.csir.co.za. Learn why this is important at <a href="https://aka.ms/LearnAboutSenderIdentification">https://aka.ms/LearnAboutSenderIdentification</a> ] This is the mail</small>				
		<b>postmaster@... Delivered: RE: Availability of Draft Scoping Reports for Comment - Kud...</b> Mon 12 Dec 202... 129 KB <b>This message ...</b> <small>You don't often get email from postmaster@netorg6186573.onmicrosoft.com. Learn why this is important &lt;<a href="https://aka.ms/LearnAboutSenderIdentification">https://aka.ms/LearnAboutSenderIdentification</a>&gt;</small>				
		<b>Microsoft Ou... Delivered: RE: Availability of Draft Scoping Reports for Comment - Kud...</b> Mon 12 Dec 202... 165 KB <b>This message ...</b> <small>Your message has been delivered to the following recipients:</small>				
		<b>Microsoft Ou... Delivered: RE: Availability of Draft Scoping Reports for Comment - Kud...</b> Mon 12 Dec 202... 164 KB <b>This message ...</b> <small>Your message has been delivered to the following recipients:</small>				
		<b>Microsoft Ou... Delivered: RE: Availability of Draft Scoping Reports for Comment - Kud...</b> Mon 12 Dec 202... 164 KB <b>This message ...</b> <small>Your message has been delivered to the following recipients:</small>				

## APPENDICES

### SCOPING REPORT: Scoping and Environmental Impact Assessment (EIA) Process for the Proposed Development of a Solar Photovoltaic (PV) Facility (Kudu Solar Facility 8) and associated infrastructure, near De Aar, Northern Cape Province

EMS - Delivery Reports						By Date <span style="font-size: small;">▼</span> <span style="font-size: small;">↑</span>
    	From	Subject	Received <span style="font-size: small;">▼</span>	Size	Categories	Mention <span style="font-size: small;">▼</span>
	postmaster@...	<b>Delivery delayed:RE: Availability of Draft Scoping Reports for Comment...</b> [The e-mail server of the sender could not be verified (SPF Record)]	Sat 10 Dec 2022...	85 KB		<a href="#">This message ...</a>
	postmaster@...	<b>Delivered: RE: Availability of Draft Scoping Reports for Comment - Kud...</b> You don't often get email from postmaster@outlook.com. Learn why this is important < <a href="https://aka.ms/LearnAboutSenderIdentification">https://aka.ms/LearnAboutSenderIdentification</a> >	Sat 10 Dec 2022...	131 KB		<a href="#">This message ...</a>
	postmaster@...	<b>Delivered: RE: Availability of Draft Scoping Reports for Comment - Kud...</b> You don't often get email from postmaster@outlook.com. Learn why this is important < <a href="https://aka.ms/LearnAboutSenderIdentification">https://aka.ms/LearnAboutSenderIdentification</a> >	Sat 10 Dec 2022...	126 KB		<a href="#">This message ...</a>
	Mail Delivery...	<b>Undeliverable: Availability of Draft Scoping Reports for Comment - Kud...</b> [You don't often get email from mailer-daemon@pta-smg4.csir.co.za. Learn why this is important at <a href="https://aka.ms/LearnAboutSenderIdentification">https://aka.ms/LearnAboutSenderIdentification</a> ] This is the mail	Fri 09 Dec 2022 ...	31 KB		<a href="#">This message ...</a>
	Mail Delivery...	<b>Relayed: Availability of Draft Scoping Reports for Comment - Kudu Sola...</b> [You don't often get email from mailer-daemon@pta-smg4.csir.co.za. Learn why this is important at <a href="https://aka.ms/LearnAboutSenderIdentification">https://aka.ms/LearnAboutSenderIdentification</a> ] This is the mail	Fri 09 Dec 2022 ...	67 KB		<a href="#">This message ...</a>
	postmaster@...	<b>Delivered: RE: Availability of Draft Scoping Reports for Comment - Kud...</b> Your message has been delivered to the following recipients:	Fri 09 Dec 2022 ...	132 KB		<a href="#">This message ...</a>
	postmaster@...	<b>Delivered: RE: Availability of Draft Scoping Reports for Comment - Kud...</b> You don't often get email from postmaster@weathersa.co.za. Learn why this is important < <a href="https://aka.ms/LearnAboutSenderIdentification">https://aka.ms/LearnAboutSenderIdentification</a> >	Fri 09 Dec 2022 ...	130 KB		<a href="#">This message ...</a>
	postmaster@...	<b>Delivered: RE: Availability of Draft Scoping Reports for Comment - Kud...</b> You don't often get email from postmaster@weathersa.co.za. Learn why this is important < <a href="https://aka.ms/LearnAboutSenderIdentification">https://aka.ms/LearnAboutSenderIdentification</a> >	Fri 09 Dec 2022 ...	130 KB		<a href="#">This message ...</a>
	postmaster@...	<b>Delivered: RE: Availability of Draft Scoping Reports for Comment - Kud...</b> You don't often get email from postmaster@weathersa.co.za. Learn why this is important < <a href="https://aka.ms/LearnAboutSenderIdentification">https://aka.ms/LearnAboutSenderIdentification</a> >	Fri 09 Dec 2022 ...	130 KB		<a href="#">This message ...</a>
	postmaster@...	<b>Delivered: RE: Availability of Draft Scoping Reports for Comment - Kud...</b> You don't often get email from postmaster@g7energies.com. Learn why this is important < <a href="https://aka.ms/LearnAboutSenderIdentification">https://aka.ms/LearnAboutSenderIdentification</a> >	Fri 09 Dec 2022 ...	137 KB		<a href="#">This message ...</a>
	postmaster@...	<b>Delivered: RE: Availability of Draft Scoping Reports for Comment - Kud...</b> You don't often get email from postmaster@dws.gov.za. Learn why this is important < <a href="https://aka.ms/LearnAboutSenderIdentification">https://aka.ms/LearnAboutSenderIdentification</a> >	Fri 09 Dec 2022 ...	136 KB		<a href="#">This message ...</a>
	postmaster@...	<b>Delivered: RE: Availability of Draft Scoping Reports for Comment - Kud...</b> You don't often get email from postmaster@dws.gov.za. Learn why this is important < <a href="https://aka.ms/LearnAboutSenderIdentification">https://aka.ms/LearnAboutSenderIdentification</a> >	Fri 09 Dec 2022 ...	136 KB		<a href="#">This message ...</a>
	postmaster@...	<b>Delivered: RE: Availability of Draft Scoping Reports for Comment - Kud...</b> You don't often get email from postmaster@dws.gov.za. Learn why this is important < <a href="https://aka.ms/LearnAboutSenderIdentification">https://aka.ms/LearnAboutSenderIdentification</a> >	Fri 09 Dec 2022 ...	136 KB		<a href="#">This message ...</a>

## APPENDICES

### SCOPING REPORT: Scoping and Environmental Impact Assessment (EIA) Process for the Proposed Development of a Solar Photovoltaic (PV) Facility (Kudu Solar Facility 8) and associated infrastructure, near De Aar, Northern Cape Province

EMS - Delivery Reports										By Date <span style="font-size: small;">v</span> <span style="font-size: small;">↑</span>	
📧	!	🔔	📄	🗑️	From	Subject	Received <span style="font-size: x-small;">v</span>	Size	Categories	Mention	🔍
					postmaster@...	<b>Delivered: RE: Availability of Draft Scoping Reports for Comment - Kud...</b> <small>You don't often get email from postmaster@dws.gov.za. Learn why this is important &lt;https://aka.ms/LearnAboutSenderIdentification&gt;</small>	Fri 09 Dec 2022 ...	136 KB			<a href="#">This message ...</a>
					postmaster@...	<b>Delivered: RE: Availability of Draft Scoping Reports for Comment - Kud...</b> <small>You don't often get email from postmaster@r-n.co.za. Learn why this is important &lt;https://aka.ms/LearnAboutSenderIdentification&gt;</small>	Fri 09 Dec 2022 ...	132 KB			<a href="#">This message ...</a>
					postmaster@...	<b>Delivered: RE: Availability of Draft Scoping Reports for Comment - Kud...</b> <small>You don't often get email from postmaster@dws.gov.za. Learn why this is important &lt;https://aka.ms/LearnAboutSenderIdentification&gt;</small>	Fri 09 Dec 2022 ...	136 KB			<a href="#">This message ...</a>
					postmaster@...	<b>Delivered: RE: Availability of Draft Scoping Reports for Comment - Kud...</b> <small>You don't often get email from postmaster@g7energies.com. Learn why this is important &lt;https://aka.ms/LearnAboutSenderIdentification&gt;</small>	Fri 09 Dec 2022 ...	137 KB			<a href="#">This message ...</a>
					postmaster@...	<b>Delivered: RE: Availability of Draft Scoping Reports for Comment - Kud...</b> <small>You don't often get email from postmaster@g7energies.com. Learn why this is important &lt;https://aka.ms/LearnAboutSenderIdentification&gt;</small>	Fri 09 Dec 2022 ...	137 KB			<a href="#">This message ...</a>
					postmaster@...	<b>Delivered: RE: Availability of Draft Scoping Reports for Comment - Kud...</b> <small>You don't often get email from postmaster@g7energies.com. Learn why this is important &lt;https://aka.ms/LearnAboutSenderIdentification&gt;</small>	Fri 09 Dec 2022 ...	137 KB			<a href="#">This message ...</a>
					postmaster@...	<b>Delivered: RE: Availability of Draft Scoping Reports for Comment - Kud...</b> <small>You don't often get email from postmaster@g7energies.com. Learn why this is important &lt;https://aka.ms/LearnAboutSenderIdentification&gt;</small>	Fri 09 Dec 2022 ...	137 KB			<a href="#">This message ...</a>
					postmaster@...	<b>Delivered: RE: Availability of Draft Scoping Reports for Comment - Kud...</b> <small>You don't often get email from postmaster@g7energies.com. Learn why this is important &lt;https://aka.ms/LearnAboutSenderIdentification&gt;</small>	Fri 09 Dec 2022 ...	137 KB			<a href="#">This message ...</a>
					postmaster@...	<b>Delivered: RE: Availability of Draft Scoping Reports for Comment - Kud...</b> <small>You don't often get email from postmaster@g7energies.com. Learn why this is important &lt;https://aka.ms/LearnAboutSenderIdentification&gt;</small>	Fri 09 Dec 2022 ...	137 KB			<a href="#">This message ...</a>
					postmaster@...	<b>Delivered: RE: Availability of Draft Scoping Reports for Comment - Kud...</b> <small>You don't often get email from postmaster@g7energies.com. Learn why this is important &lt;https://aka.ms/LearnAboutSenderIdentification&gt;</small>	Fri 09 Dec 2022 ...	137 KB			<a href="#">This message ...</a>
					postmaster@...	<b>Delivered: RE: Availability of Draft Scoping Reports for Comment - Kud...</b> <small>You don't often get email from postmaster@g7energies.com. Learn why this is important &lt;https://aka.ms/LearnAboutSenderIdentification&gt;</small>	Fri 09 Dec 2022 ...	137 KB			<a href="#">This message ...</a>
					postmaster@...	<b>Delivered: RE: Availability of Draft Scoping Reports for Comment - Kud...</b> <small>You don't often get email from postmaster@g7energies.com. Learn why this is important &lt;https://aka.ms/LearnAboutSenderIdentification&gt;</small>	Fri 09 Dec 2022 ...	137 KB			<a href="#">This message ...</a>



## APPENDICES

### SCOPING REPORT: Scoping and Environmental Impact Assessment (EIA) Process for the Proposed Development of a Solar Photovoltaic (PV) Facility (Kudu Solar Facility 8) and associated infrastructure, near De Aar, Northern Cape Province

EMS - Delivery Reports										By Date ▾ ↑	
					From	Subject	Received ▾	Size	Categories	Mention	
					postmaster@...	<b>Delivered: RE: Availability of Draft Scoping Reports for Comment - Kud...</b>	Fri 09 Dec 2022 ...	137 KB			<a href="#">This message ...</a>
You don't often get email from postmaster@g7energies.com. Learn why this is important <https://aka.ms/LearnAboutSenderIdentification>											
					postmaster@...	<b>Delivered: RE: Availability of Draft Scoping Reports for Comment - Kud...</b>	Fri 09 Dec 2022 ...	132 KB			<a href="#">This message ...</a>
You don't often get email from postmaster@corp.akuoenergy.com. Learn why this is important <https://aka.ms/LearnAboutSenderIdentification>											
					postmaster@...	<b>Undeliverable: RE: Availability of Draft Scoping Reports for Comment - ...</b>	Fri 09 Dec 2022 ...	244 KB			<a href="#">This message ...</a>
[The e-mail server of the sender could not be verified (SPF Record)]											
					Mail Delivery...	<b>Undeliverable: Availability of Draft Scoping Reports for Comment - Kud...</b>	Fri 09 Dec 2022 ...	36 KB			<a href="#">This message ...</a>
[You don't often get email from mailer-daemon@obr1.gov.za. Learn why this is important at https://aka.ms/LearnAboutSenderIdentification ]											
					Mail Delivery...	<b>Delivered: Availability of Draft Scoping Reports for Comment - Kudu So...</b>	Fri 09 Dec 2022 ...	78 KB			<a href="#">This message ...</a>
[You don't often get email from mailer-daemon@server.itdesign.co.za. Learn why this is important at https://aka.ms/LearnAboutSenderIdentification ] This message											
					postmaster@...	<b>Undeliverable: RE: Availability of Draft Scoping Reports for Comment - ...</b>	Fri 09 Dec 2022 ...	246 KB			<a href="#">This message ...</a>
You don't often get email from postmaster@transnet.net. Learn why this is important <https://aka.ms/LearnAboutSenderIdentification>											
					Mail Delivery...	<b>Undeliverable: Availability of Draft Scoping Reports for Comment - Kud...</b>	Fri 09 Dec 2022 ...	44 KB			<a href="#">This message ...</a>
[You don't often get email from mailer-daemon@pta-smg4.csir.co.za. Learn why this is important at https://aka.ms/LearnAboutSenderIdentification ] This is the mail											
					Mail Delivery...	<b>Relayed: Availability of Draft Scoping Reports for Comment - Kudu Sola...</b>	Fri 09 Dec 2022 ...	88 KB			<a href="#">This message ...</a>
[You don't often get email from mailer-daemon@pta-smg4.csir.co.za. Learn why this is important at https://aka.ms/LearnAboutSenderIdentification ] This is the mail											
					Mail Delivery...	<b>Undeliverable: Availability of Draft Scoping Reports for Comment - Kud...</b>	Fri 09 Dec 2022 ...	38 KB			<a href="#">This message ...</a>
[You don't often get email from mailer-daemon@pta-smg4.csir.co.za. Learn why this is important at https://aka.ms/LearnAboutSenderIdentification ] This is the mail											
					Mail Delivery...	<b>Relayed: Availability of Draft Scoping Reports for Comment - Kudu Sola...</b>	Fri 09 Dec 2022 ...	118 KB			<a href="#">This message ...</a>
[You don't often get email from mailer-daemon@pta-smg4.csir.co.za. Learn why this is important at https://aka.ms/LearnAboutSenderIdentification ] This is the mail											
					Mail Delivery...	<b>Relayed: Availability of Draft Scoping Reports for Comment - Kudu Sola...</b>	Fri 09 Dec 2022 ...	114 KB			<a href="#">This message ...</a>
[You don't often get email from mailer-daemon@pta-smg4.csir.co.za. Learn why this is important at https://aka.ms/LearnAboutSenderIdentification ] This is the mail											
					Mail Delivery...	<b>Undeliverable: Availability of Draft Scoping Reports for Comment - Kud...</b>	Fri 09 Dec 2022 ...	42 KB			<a href="#">This message ...</a>
[You don't often get email from mailer-daemon@pta-smg4.csir.co.za. Learn why this is important at https://aka.ms/LearnAboutSenderIdentification ] This is the mail											
					Mail Delivery...	<b>Relayed: Availability of Draft Scoping Reports for Comment - Kudu Sola...</b>	Fri 09 Dec 2022 ...	118 KB			<a href="#">This message ...</a>
[You don't often get email from mailer-daemon@pta-smg4.csir.co.za. Learn why this is important at https://aka.ms/LearnAboutSenderIdentification ] This is the mail											

## APPENDICES

### SCOPING REPORT: Scoping and Environmental Impact Assessment (EIA) Process for the Proposed Development of a Solar Photovoltaic (PV) Facility (Kudu Solar Facility 8) and associated infrastructure, near De Aar, Northern Cape Province

EMS - Delivery Reports										By Date ▾ ↑
					From	Subject	Received ▾	Size	Categories	Mention
						<b>Mail Delivery... Undeliverable: Availability of Draft Scoping Reports for Comment - Kud...</b> <b>Fri 09 Dec 2022 ... 44 KB</b> <b>This message ...</b> [You don't often get email from mailer-daemon@pta-smg4.csir.co.za. Learn why this is important at <a href="https://aka.ms/LearnAboutSenderIdentification">https://aka.ms/LearnAboutSenderIdentification</a> ] This is the mail				
					postmaster@...	<b>Delivered: RE: Availability of Draft Scoping Reports for Comment - Kud...</b> <b>Fri 09 Dec 2022 ... 129 KB</b> <b>This message ...</b> You don't often get email from postmaster@birdlife.org.za. Learn why this is important < <a href="https://aka.ms/LearnAboutSenderIdentification">https://aka.ms/LearnAboutSenderIdentification</a> >				
						<b>Mail Delivery... Delivered: Availability of Draft Scoping Reports for Comment - Kudu So...</b> <b>Fri 09 Dec 2022 ... 82 KB</b> <b>This message ...</b> [You don't often get email from mailer-daemon@mr28p00im-smtpin021.me.com. Learn why this is important at <a href="https://aka.ms/LearnAboutSenderIdentification">https://aka.ms/LearnAboutSenderIdentification</a> ]				
					postmaster@...	<b>Delivered: RE: Availability of Draft Scoping Reports for Comment - Kud...</b> <b>Fri 09 Dec 2022 ... 127 KB</b> <b>This message ...</b> You don't often get email from postmaster@outlook.com. Learn why this is important < <a href="https://aka.ms/LearnAboutSenderIdentification">https://aka.ms/LearnAboutSenderIdentification</a> >				
					postmaster@...	<b>Delivered: RE: Availability of Draft Scoping Reports for Comment - Kud...</b> <b>Fri 09 Dec 2022 ... 129 KB</b> <b>This message ...</b> You don't often get email from postmaster@birdlife.org.za. Learn why this is important < <a href="https://aka.ms/LearnAboutSenderIdentification">https://aka.ms/LearnAboutSenderIdentification</a> >				
					postmaster@...	<b>Delivered: RE: Availability of Draft Scoping Reports for Comment - Kud...</b> <b>Fri 09 Dec 2022 ... 127 KB</b> <b>This message ...</b> You don't often get email from postmaster@outlook.com. Learn why this is important < <a href="https://aka.ms/LearnAboutSenderIdentification">https://aka.ms/LearnAboutSenderIdentification</a> >				
					postmaster@...	<b>Delivered: RE: Availability of Draft Scoping Reports for Comment - Kud...</b> <b>Fri 09 Dec 2022 ... 129 KB</b> <b>This message ...</b> You don't often get email from postmaster@wessa.co.za. Learn why this is important < <a href="https://aka.ms/LearnAboutSenderIdentification">https://aka.ms/LearnAboutSenderIdentification</a> >				
					postmaster@...	<b>Delivered: RE: Availability of Draft Scoping Reports for Comment - Kud...</b> <b>Fri 09 Dec 2022 ... 127 KB</b> <b>This message ...</b> You don't often get email from postmaster@netorg7356748.onmicrosoft.com. Learn why this is important < <a href="https://aka.ms/LearnAboutSenderIdentification">https://aka.ms/LearnAboutSenderIdentification</a> >				
					postmaster@...	<b>Delivered: RE: Availability of Draft Scoping Reports for Comment - Kud...</b> <b>Fri 09 Dec 2022 ... 129 KB</b> <b>This message ...</b> You don't often get email from postmaster@birdlife.org.za. Learn why this is important < <a href="https://aka.ms/LearnAboutSenderIdentification">https://aka.ms/LearnAboutSenderIdentification</a> >				
					postmaster@...	<b>Delivered: RE: Availability of Draft Scoping Reports for Comment - Kud...</b> <b>Fri 09 Dec 2022 ... 125 KB</b> <b>This message ...</b> You don't often get email from postmaster@nocci.co.za. Learn why this is important < <a href="https://aka.ms/LearnAboutSenderIdentification">https://aka.ms/LearnAboutSenderIdentification</a> >				
					postmaster@...	<b>Delivered: RE: Availability of Draft Scoping Reports for Comment - Kud...</b> <b>Fri 09 Dec 2022 ... 128 KB</b> <b>This message ...</b> You don't often get email from postmaster@mulilo.com. Learn why this is important < <a href="https://aka.ms/LearnAboutSenderIdentification">https://aka.ms/LearnAboutSenderIdentification</a> >				
						<b>Mail Delivery... Relayed: Availability of Draft Scoping Reports for Comment - Kudu Sola...</b> <b>Fri 09 Dec 2022 ... 77 KB</b> <b>This message ...</b> [You don't often get email from mailer-daemon@hostserv.co.za. Learn why this is important at <a href="https://aka.ms/LearnAboutSenderIdentification">https://aka.ms/LearnAboutSenderIdentification</a> ]				
						<b>Mail Delivery... Relayed: Availability of Draft Scoping Reports for Comment - Kudu Sola...</b> <b>Fri 09 Dec 2022 ... 75 KB</b> <b>This message ...</b> [You don't often get email from mailer-daemon@hostserv.co.za. Learn why this is important at <a href="https://aka.ms/LearnAboutSenderIdentification">https://aka.ms/LearnAboutSenderIdentification</a> ]				

## APPENDICES

### SCOPING REPORT: Scoping and Environmental Impact Assessment (EIA) Process for the Proposed Development of a Solar Photovoltaic (PV) Facility (Kudu Solar Facility 8) and associated infrastructure, near De Aar, Northern Cape Province

EMS - Delivery Reports						By Date ▾ ↑					
					From	Subject	Received ▾	Size	Categories	Mention	
					postmaster@...	<b>Delivered: RE: Availability of Draft Scoping Reports for Comment - Kud...</b> You don't often get email from postmaster@birdlife.org.za. Learn why this is important < <a href="https://aka.ms/LearnAboutSenderIdentification">https://aka.ms/LearnAboutSenderIdentification</a> >	Fri 09 Dec 2022 ...	129 KB			<b>This message ...</b>
					postmaster@...	<b>Delivered: RE: Availability of Draft Scoping Reports for Comment - Kud...</b> You don't often get email from postmaster@nocci.co.za. Learn why this is important < <a href="https://aka.ms/LearnAboutSenderIdentification">https://aka.ms/LearnAboutSenderIdentification</a> >	Fri 09 Dec 2022 ...	125 KB			<b>This message ...</b>
					postmaster@...	<b>Delivered: RE: Availability of Draft Scoping Reports for Comment - Kud...</b> You don't often get email from postmaster@mulilo.com. Learn why this is important < <a href="https://aka.ms/LearnAboutSenderIdentification">https://aka.ms/LearnAboutSenderIdentification</a> >	Fri 09 Dec 2022 ...	128 KB			<b>This message ...</b>
					Mail Delivery...	<b>Relayed: Availability of Draft Scoping Reports for Comment - Kudu Sola...</b> [You don't often get email from mailer-daemon@hostserv.co.za. Learn why this is important at <a href="https://aka.ms/LearnAboutSenderIdentification">https://aka.ms/LearnAboutSenderIdentification</a> ]	Fri 09 Dec 2022 ...	77 KB			<b>This message ...</b>
					Mail Delivery...	<b>Relayed: Availability of Draft Scoping Reports for Comment - Kudu Sola...</b> [You don't often get email from mailer-daemon@hostserv.co.za. Learn why this is important at <a href="https://aka.ms/LearnAboutSenderIdentification">https://aka.ms/LearnAboutSenderIdentification</a> ]	Fri 09 Dec 2022 ...	75 KB			<b>This message ...</b>
					Mail Delivery...	<b>Relayed: Availability of Draft Scoping Reports for Comment - Kudu Sola...</b> [You don't often get email from mailer-daemon@mailgate.sao.ac.za. Learn why this is important at <a href="https://aka.ms/LearnAboutSenderIdentification">https://aka.ms/LearnAboutSenderIdentification</a> ]	Fri 09 Dec 2022 ...	75 KB			<b>This message ...</b>
					Mail Delivery...	<b>Relayed: Availability of Draft Scoping Reports for Comment - Kudu Sola...</b> [You don't often get email from mailer-daemon@pta-smg4.csir.co.za. Learn why this is important at <a href="https://aka.ms/LearnAboutSenderIdentification">https://aka.ms/LearnAboutSenderIdentification</a> ] This is the mail	Fri 09 Dec 2022 ...	67 KB			<b>This message ...</b>
					Mail Delivery...	<b>Relayed: Availability of Draft Scoping Reports for Comment - Kudu Sola...</b> [You don't often get email from mailer-daemon@pta-smg4.csir.co.za. Learn why this is important at <a href="https://aka.ms/LearnAboutSenderIdentification">https://aka.ms/LearnAboutSenderIdentification</a> ] This is the mail	Fri 09 Dec 2022 ...	67 KB			<b>This message ...</b>
					Microsoft Ou...	<b>Delivered: RE: Availability of Draft Scoping Reports for Comment - Kud...</b> Your message has been delivered to the following recipients:	Fri 09 Dec 2022 ...	159 KB			<b>This message ...</b>
					Microsoft Ou...	<b>Delivered: RE: Availability of Draft Scoping Reports for Comment - Kud...</b> Your message has been delivered to the following recipients:	Fri 09 Dec 2022 ...	159 KB			<b>This message ...</b>
					Microsoft Ou...	<b>Delivered: RE: Availability of Draft Scoping Reports for Comment - Kud...</b> Your message has been delivered to the following recipients:	Fri 09 Dec 2022 ...	158 KB			<b>This message ...</b>
					Microsoft Ou...	<b>Delivered: RE: Availability of Draft Scoping Reports for Comment - Kud...</b> Your message has been delivered to the following recipients:	Fri 09 Dec 2022 ...	158 KB			<b>This message ...</b>

## APPENDICES

SCOPING REPORT: Scoping and Environmental Impact Assessment (EIA) Process for the Proposed Development of a Solar Photovoltaic (PV) Facility (Kudu Solar Facility 8) and associated infrastructure, near De Aar, Northern Cape Province

---

### 4. Proof of SMS Text Messages sent to I&APs, Stakeholders and Organs of State (where cellphone numbers are available) on 9 December 2022

**Copy of text included in the SMS:** Dear Stakeholder, Draft Scoping Reports for the proposed Kudu Solar Facilities 1-12 near De Aar, NC are available for comment until 30 Jan 2023. Visit [https://bit.ly/KUDU\\_SOLAR\\_PV](https://bit.ly/KUDU_SOLAR_PV) or [https://bit.ly/CSIR\\_EIA](https://bit.ly/CSIR_EIA) to access the reports. To send comments, queries or to opt out of future communication on these projects, email [ems@csir.co.za](mailto:ems@csir.co.za). Regards, CSIR EMS Team ([https://bit.ly/CSIR\\_privacy](https://bit.ly/CSIR_privacy))

created_time	msisdn	status	status_text	origin_address	delivered_time	batch_id
2022-12-09 15:11:55.0	[REDACTED]	11	Delivered to phone	[REDACTED]	2022-12-09 15:11:00.0	1608184918
2022-12-09 15:11:55.0	[REDACTED]	11	Delivered to phone	[REDACTED]	2022-12-09 15:11:00.0	1608184918
2022-12-09 15:11:55.0	[REDACTED]	11	Delivered to phone	[REDACTED]	2022-12-09 15:12:00.0	1608184918
2022-12-09 15:11:55.0	[REDACTED]	11	Delivered to phone	[REDACTED]	2022-12-09 15:11:00.0	1608184918
2022-12-09 15:11:55.0	[REDACTED]	11	Delivered to phone	[REDACTED]	2022-12-09 15:12:00.0	1608184918
2022-12-09 15:11:55.0	[REDACTED]	11	Delivered to phone	[REDACTED]	2022-12-09 15:11:00.0	1608184918
2022-12-09 15:11:55.0	[REDACTED]	11	Delivered to phone	[REDACTED]	2022-12-11 14:42:00.0	1608184918
2022-12-09 15:11:55.0	[REDACTED]	50	Failed	[REDACTED]	2022-12-11 15:40:00.0	1608184918
2022-12-09 15:11:55.0	[REDACTED]	50	Failed	[REDACTED]	2022-12-11 15:40:00.0	1608184918
2022-12-09 15:11:55.0	[REDACTED]	50	Failed	[REDACTED]	2022-12-09 15:11:00.0	1608184918
2022-12-09 15:11:55.0	[REDACTED]	50	Failed	[REDACTED]	2022-12-09 15:11:00.0	1608184918
2022-12-09 15:11:55.0	[REDACTED]	50	Failed	[REDACTED]	2022-12-09 15:11:00.0	1608184918
2022-12-09 15:11:55.0	[REDACTED]	11	Delivered to phone	[REDACTED]	2022-12-09 15:11:00.0	1608184918
2022-12-09 15:11:55.0	[REDACTED]	11	Delivered to phone	[REDACTED]	2022-12-09 15:11:00.0	1608184918
2022-12-09 15:11:55.0	[REDACTED]	11	Delivered to phone	[REDACTED]	2022-12-09 15:11:00.0	1608184918
2022-12-09 15:11:55.0	[REDACTED]	11	Delivered to phone	[REDACTED]	2022-12-09 15:11:00.0	1608184918
2022-12-09 15:11:55.0	[REDACTED]	11	Delivered to phone	[REDACTED]	2022-12-09 15:11:00.0	1608184918
2022-12-09 15:11:55.0	[REDACTED]	11	Delivered to phone	[REDACTED]	2022-12-09 15:11:00.0	1608184918
2022-12-09 15:11:55.0	[REDACTED]	11	Delivered to phone	[REDACTED]	2022-12-09 15:12:00.0	1608184918
2022-12-09 15:11:55.0	[REDACTED]	11	Delivered to phone	[REDACTED]	2022-12-09 15:12:00.0	1608184918
2022-12-09 15:11:55.0	[REDACTED]	11	Delivered to phone	[REDACTED]	2022-12-09 15:12:00.0	1608184918
2022-12-09 15:11:55.0	[REDACTED]	11	Delivered to phone	[REDACTED]	2022-12-09 15:12:00.0	1608184918
2022-12-09 15:11:55.0	[REDACTED]	11	Delivered to phone	[REDACTED]	2022-12-09 15:12:00.0	1608184918
2022-12-09 15:11:55.0	[REDACTED]	11	Delivered to phone	[REDACTED]	2022-12-09 15:12:00.0	1608184918
2022-12-09 15:11:55.0	[REDACTED]	11	Delivered to phone	[REDACTED]	2022-12-09 15:12:00.0	1608184918

APPENDICES

SCOPING REPORT: Scoping and Environmental Impact Assessment (EIA) Process for the Proposed Development of a Solar Photovoltaic (PV) Facility (Kudu Solar Facility 8) and associated infrastructure, near De Aar, Northern Cape Province

---

created_time	msisdn	status	status_text	origin_address	delivered_time	batch_id
2022-12-09 15:11:55.0	[REDACTED]	11	Delivered to phone	[REDACTED]	2022-12-09 15:12:00.0	1608184918
2022-12-09 15:11:55.0	[REDACTED]	11	Delivered to phone	[REDACTED]	2022-12-09 15:11:00.0	1608184918
2022-12-09 15:11:55.0	[REDACTED]	11	Delivered to phone	[REDACTED]	2022-12-09 15:11:00.0	1608184918
2022-12-09 15:11:55.0	[REDACTED]	11	Delivered to phone	[REDACTED]	2022-12-09 15:11:00.0	1608184918
2022-12-09 15:11:55.0	[REDACTED]	11	Delivered to phone	[REDACTED]	2022-12-09 15:11:00.0	1608184918
2022-12-09 15:11:55.0	[REDACTED]	11	Delivered to phone	[REDACTED]	2022-12-09 15:12:00.0	1608184918
2022-12-09 15:11:55.0	[REDACTED]	11	Delivered to phone	[REDACTED]	2022-12-09 15:12:00.0	1608184918
2022-12-09 15:11:55.0	[REDACTED]	11	Delivered to phone	[REDACTED]	2022-12-09 15:11:00.0	1608184918
2022-12-09 15:11:55.0	[REDACTED]	11	Delivered to phone	[REDACTED]	2022-12-09 15:12:00.0	1608184918
2022-12-09 15:11:55.0	[REDACTED]	11	Delivered to phone	[REDACTED]	2022-12-09 15:11:00.0	1608184918
2022-12-09 15:11:55.0	[REDACTED]	11	Delivered to phone	[REDACTED]	2022-12-09 15:11:00.0	1608184918
2022-12-09 15:11:55.0	[REDACTED]	11	Delivered to phone	[REDACTED]	2022-12-09 15:11:00.0	1608184918
2022-12-09 15:11:55.0	[REDACTED]	11	Delivered to phone	[REDACTED]	2022-12-09 15:11:00.0	1608184918
2022-12-09 15:11:55.0	[REDACTED]	11	Delivered to phone	[REDACTED]	2022-12-09 15:11:00.0	1608184918
2022-12-09 15:11:55.0	[REDACTED]	11	Delivered to phone	[REDACTED]	2022-12-09 15:11:00.0	1608184918
2022-12-09 15:11:55.0	[REDACTED]	11	Delivered to phone	[REDACTED]	2022-12-09 15:11:00.0	1608184918
2022-12-09 15:11:55.0	[REDACTED]	11	Delivered to phone	[REDACTED]	2022-12-09 15:11:00.0	1608184918
2022-12-09 15:11:55.0	[REDACTED]	11	Delivered to phone	[REDACTED]	2022-12-09 15:11:00.0	1608184918
2022-12-09 15:11:55.0	[REDACTED]	11	Delivered to phone	[REDACTED]	2022-12-09 15:11:00.0	1608184918
2022-12-09 15:11:55.0	[REDACTED]	11	Delivered to phone	[REDACTED]	2022-12-09 15:11:00.0	1608184918
2022-12-09 15:11:55.0	[REDACTED]	11	Delivered to phone	[REDACTED]	2022-12-09 15:11:00.0	1608184918
2022-12-09 15:11:55.0	[REDACTED]	11	Delivered to phone	[REDACTED]	2022-12-09 15:11:00.0	1608184918
2022-12-09 15:11:55.0	[REDACTED]	11	Delivered to phone	[REDACTED]	2022-12-09 15:11:00.0	1608184918
2022-12-09 15:11:55.0	[REDACTED]	11	Delivered to phone	[REDACTED]	2022-12-09 15:12:00.0	1608184918
2022-12-09 15:11:55.0	[REDACTED]	11	Delivered to phone	[REDACTED]	2022-12-09 15:12:00.0	1608184918
2022-12-09 15:11:55.0	[REDACTED]	11	Delivered to phone	[REDACTED]	2022-12-09 15:12:00.0	1608184918
2022-12-09 15:11:55.0	[REDACTED]	11	Delivered to phone	[REDACTED]	2022-12-09 15:12:00.0	1608184918
2022-12-09 15:11:55.0	[REDACTED]	11	Delivered to phone	[REDACTED]	2022-12-09 15:12:00.0	1608184918
2022-12-09 15:11:55.0	[REDACTED]	11	Delivered to phone	[REDACTED]	2022-12-09 15:12:00.0	1608184918

**APPENDICES**

SCOPING REPORT: Scoping and Environmental Impact Assessment (EIA) Process for the Proposed Development of a Solar Photovoltaic (PV) Facility (Kudu Solar Facility 8) and associated infrastructure, near De Aar, Northern Cape Province

---

<b>created_time</b>	<b>msisdn</b>	<b>status</b>	<b>status_text</b>	<b>origin_address</b>	<b>delivered_time</b>	<b>batch_id</b>
2022-12-09 15:11:55.0	[REDACTED]	11	Delivered to phone	[REDACTED]	2022-12-09 15:12:00.0	1608184918
2022-12-09 15:11:55.0	[REDACTED]	11	Delivered to phone	[REDACTED]	2022-12-09 15:11:00.0	1608184918
2022-12-09 15:11:55.0	[REDACTED]	11	Delivered to phone	[REDACTED]	2022-12-09 15:13:00.0	1608184918
2022-12-09 15:11:55.0	[REDACTED]	11	Delivered to phone	[REDACTED]	2022-12-09 15:12:00.0	1608184918
2022-12-09 15:11:55.0	[REDACTED]	11	Delivered to phone	[REDACTED]	2022-12-09 19:44:00.0	1608184918
2022-12-09 15:11:55.0	[REDACTED]	11	Delivered to phone	[REDACTED]	2022-12-09 19:41:00.0	1608184918
2022-12-09 15:11:55.0	[REDACTED]	11	Delivered to phone	[REDACTED]	2022-12-09 19:46:00.0	1608184918
2022-12-09 15:11:55.0	[REDACTED]	11	Delivered to phone	[REDACTED]	2022-12-09 15:17:00.0	1608184918
2022-12-09 15:11:55.0	[REDACTED]	11	Delivered to phone	[REDACTED]	2022-12-09 15:17:00.0	1608184918
2022-12-09 15:11:55.0	[REDACTED]	11	Delivered to phone	[REDACTED]	2022-12-09 15:12:00.0	1608184918
2022-12-09 15:11:55.0	[REDACTED]	50	Failed	[REDACTED]	2022-12-09 15:11:00.0	1608184918
2022-12-09 15:11:55.0	[REDACTED]	50	Failed	[REDACTED]	2022-12-09 15:11:00.0	1608184918
2022-12-09 15:11:55.0	[REDACTED]	50	Failed	[REDACTED]	2022-12-09 15:12:00.0	1608184918
2022-12-09 15:11:55.0	[REDACTED]	11	Delivered to phone	[REDACTED]	2022-12-09 15:12:00.0	1608184918
2022-12-09 15:11:55.0	[REDACTED]	11	Delivered to phone	[REDACTED]	2022-12-09 15:12:00.0	1608184918
2022-12-09 15:11:55.0	[REDACTED]	11	Delivered to phone	[REDACTED]	2022-12-09 15:12:00.0	1608184918
2022-12-09 15:11:55.0	[REDACTED]	11	Delivered to phone	[REDACTED]	2022-12-09 15:11:00.0	1608184918
2022-12-09 15:11:55.0	[REDACTED]	11	Delivered to phone	[REDACTED]	2022-12-09 15:11:00.0	1608184918
2022-12-09 15:11:55.0	[REDACTED]	11	Delivered to phone	[REDACTED]	2022-12-09 15:11:00.0	1608184918
2022-12-09 15:11:55.0	[REDACTED]	11	Delivered to phone	[REDACTED]	2022-12-09 15:12:00.0	1608184918
2022-12-09 15:11:55.0	[REDACTED]	11	Delivered to phone	[REDACTED]	2022-12-09 15:12:00.0	1608184918
2022-12-09 15:11:55.0	[REDACTED]	11	Delivered to phone	[REDACTED]	2022-12-09 15:13:00.0	1608184918
2022-12-09 15:11:55.0	[REDACTED]	11	Delivered to phone	[REDACTED]	2022-12-09 15:12:00.0	1608184918
2022-12-09 15:11:55.0	[REDACTED]	11	Delivered to phone	[REDACTED]	2022-12-09 15:11:00.0	1608184918
2022-12-09 15:11:55.0	[REDACTED]	11	Delivered to phone	[REDACTED]	2022-12-09 15:11:00.0	1608184918
2022-12-09 15:11:55.0	[REDACTED]	11	Delivered to phone	[REDACTED]	2022-12-09 15:12:00.0	1608184918
2022-12-09 15:11:55.0	[REDACTED]	11	Delivered to phone	[REDACTED]	2022-12-09 15:12:00.0	1608184918
2022-12-09 15:11:55.0	[REDACTED]	11	Delivered to phone	[REDACTED]	2022-12-09 15:12:00.0	1608184918
2022-12-09 15:11:55.0	[REDACTED]	11	Delivered to phone	[REDACTED]	2022-12-09 15:11:00.0	1608184918
2022-12-09 15:11:55.0	[REDACTED]	11	Delivered to phone	[REDACTED]	2022-12-09 15:11:00.0	1608184918

## APPENDICES

### SCOPING REPORT: Scoping and Environmental Impact Assessment (EIA) Process for the Proposed Development of a Solar Photovoltaic (PV) Facility (Kudu Solar Facility 8) and associated infrastructure, near De Aar, Northern Cape Province

---

created_time	msisdn	status	status_text	origin_address	delivered_time	batch_id
2022-12-09 15:11:55.0	[REDACTED]	11	Delivered to phone	[REDACTED]	2022-12-09 15:11:00.0	1608184918
2022-12-09 15:11:55.0	[REDACTED]	11	Delivered to phone	[REDACTED]	2022-12-09 15:12:00.0	1608184918
2022-12-09 15:11:55.0	[REDACTED]	11	Delivered to phone	[REDACTED]	2022-12-09 15:12:00.0	1608184918
2022-12-09 15:11:55.0	[REDACTED]	11	Delivered to phone	[REDACTED]	2022-12-09 15:12:00.0	1608184918
2022-12-09 15:11:55.0	[REDACTED]	11	Delivered to phone	[REDACTED]	2022-12-09 15:12:00.0	1608184918
2022-12-09 15:11:55.0	[REDACTED]	11	Delivered to phone	[REDACTED]	2022-12-09 15:12:00.0	1608184918
2022-12-09 15:11:55.0	[REDACTED]	11	Delivered to phone	[REDACTED]	2022-12-09 15:12:00.0	1608184918
2022-12-09 15:11:55.0	[REDACTED]	11	Delivered to phone	[REDACTED]	2022-12-09 15:12:00.0	1608184918
2022-12-09 15:11:55.0	[REDACTED]	11	Delivered to phone	[REDACTED]	2022-12-09 15:13:00.0	1608184918
2022-12-09 15:11:55.0	[REDACTED]	11	Delivered to phone	[REDACTED]	2022-12-09 15:12:00.0	1608184918
2022-12-09 15:11:55.0	[REDACTED]	11	Delivered to phone	[REDACTED]	2022-12-09 15:12:00.0	1608184918
2022-12-09 15:11:55.0	[REDACTED]	11	Delivered to phone	[REDACTED]	2022-12-09 15:12:00.0	1608184918
2022-12-09 15:11:55.0	[REDACTED]	11	Delivered to phone	[REDACTED]	2022-12-09 15:12:00.0	1608184918
2022-12-09 15:11:55.0	[REDACTED]	11	Delivered to phone	[REDACTED]	2022-12-09 15:13:00.0	1608184918
2022-12-09 15:11:55.0	[REDACTED]	11	Delivered to phone	[REDACTED]	2022-12-09 15:11:00.0	1608184918
2022-12-09 15:11:55.0	[REDACTED]	11	Delivered to phone	[REDACTED]	2022-12-09 15:12:00.0	1608184918
2022-12-09 15:11:55.0	[REDACTED]	11	Delivered to phone	[REDACTED]	2022-12-09 15:11:00.0	1608184918
2022-12-09 15:11:55.0	[REDACTED]	11	Delivered to phone	[REDACTED]	2022-12-09 15:12:00.0	1608184918
2022-12-09 15:11:55.0	[REDACTED]	11	Delivered to phone	[REDACTED]	2022-12-09 15:12:00.0	1608184918
2022-12-09 15:11:55.0	[REDACTED]	11	Delivered to phone	[REDACTED]	2022-12-09 15:12:00.0	1608184918
2022-12-09 15:11:55.0	[REDACTED]	11	Delivered to phone	[REDACTED]	2022-12-09 15:12:00.0	1608184918
2022-12-09 15:11:55.0	[REDACTED]	11	Delivered to phone	[REDACTED]	2022-12-09 15:12:00.0	1608184918
2022-12-09 15:11:55.0	[REDACTED]	11	Delivered to phone	[REDACTED]	2022-12-09 15:12:00.0	1608184918
2022-12-09 15:11:55.0	[REDACTED]	11	Delivered to phone	[REDACTED]	2022-12-09 15:12:00.0	1608184918
2022-12-09 15:11:55.0	[REDACTED]	11	Delivered to phone	[REDACTED]	2022-12-09 15:12:00.0	1608184918
2022-12-09 15:11:55.0	[REDACTED]	11	Delivered to phone	[REDACTED]	2022-12-09 15:12:00.0	1608184918
2022-12-09 15:11:55.0	[REDACTED]	50	Failed	[REDACTED]	2022-12-10 15:11:00.0	1608184918
2022-12-09 15:11:55.0	[REDACTED]	50	Failed	[REDACTED]	2022-12-10 15:11:00.0	1608184918
2022-12-09 15:11:55.0	[REDACTED]	50	Failed	[REDACTED]	2022-12-10 15:12:00.0	1608184918
2022-12-09 15:11:55.0	[REDACTED]	11	Delivered to phone	[REDACTED]	2022-12-09 15:12:00.0	1608184918
2022-12-09 15:11:55.0	[REDACTED]	11	Delivered to phone	[REDACTED]	2022-12-09 15:12:00.0	1608184918
2022-12-09 15:11:55.0	[REDACTED]	11	Delivered to phone	[REDACTED]	2022-12-09 15:12:00.0	1608184918
2022-12-09 15:11:55.0	[REDACTED]	11	Delivered to phone	[REDACTED]	2022-12-11 08:51:00.0	1608184918
2022-12-09 15:11:55.0	[REDACTED]	11	Delivered to phone	[REDACTED]	2022-12-11 08:55:00.0	1608184918

**APPENDICES**

SCOPING REPORT: Scoping and Environmental Impact Assessment (EIA) Process for the Proposed Development of a Solar Photovoltaic (PV) Facility (Kudu Solar Facility 8) and associated infrastructure, near De Aar, Northern Cape Province

---

<b>created_time</b>	<b>msisdn</b>	<b>status</b>	<b>status_text</b>	<b>origin_address</b>	<b>delivered_time</b>	<b>batch_id</b>
2022-12-09 15:11:55.0	[REDACTED]	11	Delivered to phone	[REDACTED]	2022-12-11 08:57:00.0	1608184918
2022-12-09 15:11:55.0	[REDACTED]	52	Failed: delivery to network failed	[REDACTED]		1608184918
2022-12-09 15:11:55.0	[REDACTED]	52	Failed: delivery to network failed	[REDACTED]		1608184918
2022-12-09 15:11:55.0	[REDACTED]	52	Failed: delivery to network failed	[REDACTED]		1608184918
2022-12-09 15:11:55.0	[REDACTED]	11	Delivered to phone	[REDACTED]	2022-12-09 15:12:00.0	1608184918
2022-12-09 15:11:55.0	[REDACTED]	11	Delivered to phone	[REDACTED]	2022-12-09 15:12:00.0	1608184918
2022-12-09 15:11:55.0	[REDACTED]	11	Delivered to phone	[REDACTED]	2022-12-09 15:12:00.0	1608184918
2022-12-09 15:11:55.0	[REDACTED]	11	Delivered to phone	[REDACTED]	2022-12-09 15:11:00.0	1608184918
2022-12-09 15:11:55.0	[REDACTED]	11	Delivered to phone	[REDACTED]	2022-12-09 15:12:00.0	1608184918
2022-12-09 15:11:55.0	[REDACTED]	11	Delivered to phone	[REDACTED]	2022-12-09 15:12:00.0	1608184918
2022-12-09 15:11:55.0	[REDACTED]	11	Delivered to phone	[REDACTED]	2022-12-09 15:12:00.0	1608184918
2022-12-09 15:11:55.0	[REDACTED]	11	Delivered to phone	[REDACTED]	2022-12-09 15:12:00.0	1608184918
2022-12-09 15:11:55.0	[REDACTED]	52	Failed: delivery to network failed	[REDACTED]		1608184918
2022-12-09 15:11:55.0	[REDACTED]	52	Failed: delivery to network failed	[REDACTED]		1608184918
2022-12-09 15:11:55.0	[REDACTED]	52	Failed: delivery to network failed	[REDACTED]		1608184918
2022-12-09 15:11:55.0	[REDACTED]	11	Delivered to phone	[REDACTED]	2022-12-09 15:11:00.0	1608184918
2022-12-09 15:11:55.0	[REDACTED]	11	Delivered to phone	[REDACTED]	2022-12-09 15:11:00.0	1608184918
2022-12-09 15:11:55.0	[REDACTED]	11	Delivered to phone	[REDACTED]	2022-12-09 15:12:00.0	1608184918
2022-12-09 15:11:55.0	[REDACTED]	11	Delivered to phone	[REDACTED]	2022-12-09 15:11:00.0	1608184918
2022-12-09 15:11:55.0	[REDACTED]	11	Delivered to phone	[REDACTED]	2022-12-09 15:11:00.0	1608184918
2022-12-09 15:11:55.0	[REDACTED]	11	Delivered to phone	[REDACTED]	2022-12-09 15:12:00.0	1608184918
2022-12-09 15:11:55.0	[REDACTED]	11	Delivered to phone	[REDACTED]	2022-12-09 15:11:00.0	1608184918
2022-12-09 15:11:55.0	[REDACTED]	11	Delivered to phone	[REDACTED]	2022-12-09 15:11:00.0	1608184918
2022-12-09 15:11:55.0	[REDACTED]	11	Delivered to phone	[REDACTED]	2022-12-09 15:11:00.0	1608184918
2022-12-09 15:11:55.0	[REDACTED]	11	Delivered to phone	[REDACTED]	2022-12-09 15:11:00.0	1608184918





## APPENDICES

### SCOPING REPORT: Scoping and Environmental Impact Assessment (EIA) Process for the Proposed Development of a Solar Photovoltaic (PV) Facility (Kudu Solar Facility 8) and associated infrastructure, near De Aar, Northern Cape Province

#### 5. Proof of Upload of the DSR to the CSIR Project Website

The screenshot displays a web browser window with the URL [csir.co.za/environmental-impact-assessment](https://csir.co.za/environmental-impact-assessment). The page features the CSIR logo and a navigation menu. The main content area lists the following documents:

- Scoping and Environmental Impact Assessment (EIA) Processes for the Proposed Development of the Kudu Solar Photovoltaic (PV) Facilities and associated Infrastructure, near De Aar, Northern Cape Province:
- Scoping Report for Kudu Solar Facility 1
  - Draft scoping report
  - Executive summary
- Scoping Report for Kudu Solar Facility 2
  - Draft scoping report
  - Executive summary
- Scoping Report for Kudu Solar Facility 3
  - Draft scoping report
  - Executive summary
- Scoping Report for Kudu Solar Facility 4
  - Draft scoping report
  - Executive summary
- Scoping Report for Kudu Solar Facility 5
  - Draft scoping report
  - Executive summary
- Scoping Report for Kudu Solar Facility 6
  - Draft scoping report
  - Executive summary
- Scoping Report for Kudu Solar Facility 7
  - Draft scoping report
  - Executive summary
- Scoping Report for Kudu Solar Facility 8
  - Draft scoping report
  - Executive summary
- Scoping Report for Kudu Solar Facility 9
  - Draft scoping report
  - Executive summary
- Scoping Report for Kudu Solar Facility 10
  - Draft scoping report
  - Executive summary
- Scoping Report for Kudu Solar Facility 11
  - Draft scoping report
  - Executive summary
- Scoping Report for Kudu Solar Facility 12
  - Draft scoping report
  - Executive summary
- I&AP Notification Letter for Draft Scoping Report Availability

Report and Appendices also available at [https://bit.ly/KUDU\\_PV](https://bit.ly/KUDU_PV)  
For enquiries and to request report appendices send an email to [ems@csir.co.za](mailto:ems@csir.co.za)

ABO Wind renewable energies (Pty) Ltd  
Northern Cape

## APPENDICES

### SCOPING REPORT: Scoping and Environmental Impact Assessment (EIA) Process for the Proposed Development of a Solar Photovoltaic (PV) Facility (Kudu Solar Facility 8) and associated infrastructure, near De Aar, Northern Cape Province

#### 6. Proof of Upload of the DSR to Google Drive

The screenshot displays the Google Drive interface in a web browser. The address bar shows the URL: [drive.google.com/drive/folders/1OI2c0ZXSXa\\_5EC\\_SXPjk6QSM2DXhypzc](https://drive.google.com/drive/folders/1OI2c0ZXSXa_5EC_SXPjk6QSM2DXhypzc). The page title is "KUDU SOLAR FACILITIES 1-12". The interface shows a search bar, navigation icons, and a list of files. The files are organized into a table with columns for Name, Owner, Last modified, and File size. All files are draft scoping reports for various Kudu Solar Facilities, owned by Lizandé Kellerman, and last modified on Nov 30, 2022. The storage usage is shown as 23.82 GB of 100 GB used.

Name	Owner	Last modified	File size
Kudu Solar Facility 12 - Draft Scoping Report	Lizandé Kellerman	Nov 30, 2022	Lizandé Kellerman -
Kudu Solar Facility 11 - Draft Scoping Report	Lizandé Kellerman	Nov 30, 2022	Lizandé Kellerman -
Kudu Solar Facility 10 - Draft Scoping Report	Lizandé Kellerman	Nov 30, 2022	Lizandé Kellerman -
Kudu Solar Facility 9 - Draft Scoping Report	Lizandé Kellerman	Nov 30, 2022	Lizandé Kellerman -
Kudu Solar Facility 8 - Draft Scoping Report	Lizandé Kellerman	Nov 30, 2022	Lizandé Kellerman -
Kudu Solar Facility 7 - Draft Scoping Report	Lizandé Kellerman	Nov 30, 2022	Lizandé Kellerman -
Kudu Solar Facility 6 - Draft Scoping Report	Lizandé Kellerman	Nov 30, 2022	Lizandé Kellerman -
Kudu Solar Facility 5 - Draft Scoping Report	Lizandé Kellerman	Nov 30, 2022	Lizandé Kellerman -
Kudu Solar Facility 4 - Draft Scoping Report	Lizandé Kellerman	Nov 30, 2022	Lizandé Kellerman -
Kudu Solar Facility 3 - Draft Scoping Report	Lizandé Kellerman	Nov 30, 2022	Lizandé Kellerman -
Kudu Solar Facility 2 - Draft Scoping Report	Lizandé Kellerman	Nov 30, 2022	Lizandé Kellerman -
Kudu Solar Facility 1 - Draft Scoping Report	Lizandé Kellerman	Nov 30, 2022	Lizandé Kellerman -

## APPENDICES

# SCOPING REPORT: Scoping and Environmental Impact Assessment (EIA) Process for the Proposed Development of a Solar Photovoltaic (PV) Facility (Kudu Solar Facility 8) and associated infrastructure, near De Aar, Northern Cape Province

## 7. Proof of Upload of the DSR to SAHRIS (Kudu Solar Facility 8)

**SAHRIS**  
 Explore | Calendar | Maps | Help

Heritage Cases

**Special Notice**  
 Following comments received on the proposed Revised Schedule of Fees for applications made to the South African Heritage Resources Agency (SAHRA), made in terms of Section 25(2)(l) of the National Heritage Resources Act No. 25 of 1999 (NHRA) and published in the Government Gazette of 22 July 2022, SAHRA hereby publishes the final Revised Schedule of Fees for Applications made to SAHRA. Applications for provision of services submitted to the South African Heritage Resources Authority (SAHRA), in terms of the National Heritage Resources Act, No. 25 of 1999 (NHRA) must be accompanied by a payment of the appropriate fee, taking effect from 1 January 2023

Revised Schedule of Fees for Applications made to the South African Heritage Resources Agency (SAHRA)

**Official Decisions & Comments**

Date	DecStatus
25/01/2023	Interim Comment

Like 0 | Tweet | in

**Kudu Solar Facility 8**  
 Log in or register to post comments 12 reads

**CaseHeader** | LocationInfo | Admin

**Status:** Studies Pending  
**HeritageAuthority(s):** SAHRA  
 NBKB  
**Case Type:** Section 38 (8) - Statutory Comment Required  
**Development Type:** Renewable Energy

**ProposalDescription:**  
 ABO Wind renewable energies (Pty) Ltd is proposing to develop 12 Solar Photovoltaic (PV) power generation facilities and associated Electrical Grid Infrastructure (EGI), north-east of the town of De Aar, in the Renosterberg Local Municipality and Pixley Ka Seme District Municipality, in the Northern Cape Province. Scoping and Environmental Impact Assessment (EIA) Processes are currently being undertaken for the 12 Solar PV facilities. Separate Basic Assessment (BA) and/or EGI Standard Registration processes will be commissioned separately, once finalised, for the EGI projects. This case is for the proposed Kudu Solar Facility 8.  
**ApplicationDate:** Sunday, December 11, 2022 - 22:12  
**CaseID:** 20343  
**OtherReferences:**

Dept	CaseReference	DueDate	FinalDecision
DFFE		30/01/2023	

**Heritage Reports:** Kudu Solar Facility 8 Heritage Scoping Report  
 Kudu Solar Facility and EGI Palaeontology SSV

**ReferenceList:**

**AdditionalDocuments**

- Draft Scoping Report Kudu Solar Facility 8
- Appendix C Maps Kudu Solar Facility 8
- Appendix E PPP Kudu Solar Facility 8
- Appendix F Pre-App Consultation Kudu Solar Facility 8
- Appendix G 5 VIA Scoping Level Kudu Solar Facility 8

Back to Top

South African Heritage Resources Agency (SAHRA)  
 111 Harrington Street  
 Cape Town  
 8001

PO Box 4637  
 Cape Town, 8000  
 Tel 021 462 4502/Fax 021 462 4509  
 Email info@sahra.org.za  
 Web www.sahra.org.za

An agency of the Department of Arts & Culture

Powered by Drupal | Site best viewed using Google Chrome | Disclaimer

## APPENDICES

SCOPING REPORT: Scoping and Environmental Impact Assessment (EIA) Process for the Proposed Development of a Solar Photovoltaic (PV) Facility (Kudu Solar Facility 8) and associated infrastructure, near De Aar, Northern Cape Province

### 8. Proof of Courier of USBs to Libraries



## Shipment Receipt

### Shipment From

CSR  
Debbie Cloete / Rohaida Abed  
11 Jan Cilliers Street

7600 STELLENBOSCH  
South Africa  
+27218882400

### Shipment To

Philippstown Library  
Station Street  
Church Street

8795 PHILIPSTOWN  
South Africa

### Shipment Details

Shipment Date: 2023-01-03  
Waybill Number: 4561994021  
Service Type: EXPRESS DOMESTIC  
Packaging Type: Flyer  
Number of Pieces: 1  
Total Weight: 1.00kg  
Dimensional: 0.36kg  
Chargeable: 1.00kg  
Insured Amount:  
Terms of Trade:

### International Information

Declared Value:  
Duties&taxes acct:  
Dutiable Status: Non-Dutiable  
Estimated Del date: Monday, 09 Jan, 2023  
Promo Code:

### Billing Information

Payment Type: DHL Account Number  
Billing Account: 305048439  
Duties&taxes acct:  
Charge Breakdown: 444.25 ZAR

Special Services: Fuel Surcharge/Remote Area Delivery

Charge is estimated until DHL reweigh

### Reference Information

Reference: PO 1000811537  
Pickup reference nr:

### Description of Contents

USB Memory sticks

2019 © Deutsche Post AG - All rights reserved

9.

APPENDICES

SCOPING REPORT: Scoping and Environmental Impact Assessment (EIA) Process for the Proposed Development of a Solar Photovoltaic (PV) Facility (Kudu Solar Facility 8) and associated infrastructure, near De Aar, Northern Cape Province

**DHL** **Shipment Receipt**

---

**Shipment From** **Shipment To**

CS&K  
Debbie Cloete / Rohaida Abed  
11 Jan Cilliers Street

PHILIPSTOWN LIBRARY  
Station Street  
Church Street

7800 STELLENBOSCH  
South Africa  
+27218882400

8795 PHILIPSTOWN  
South Africa

---

**Shipment Details** **International Information**

Shipment Date: 2023-01-04  
Waybill Number: 5796768471  
Service Type: EXPRESS DOMESTIC  
Packaging Type: Flyer  
Number of Pieces: 1  
Total Weight: 1.00kg  
Dimensional: 0.36kg  
Chargeable: 1.00kg  
Insured Amount:  
Terms of Trade:

Declared Value:  
Duties&taxes acct:  
Dutiable Status: Non-Dutiable  
Estimated Del date: Monday, 09 Jan, 2023  
Promo Code:

*South  
4/01*

**Billing Information**

Payment Type: DHL Account Number  
Billing Account: 305048439  
Duties&taxes acct:  
Charge Breakdown: 444.25 ZAR

Special Services: Fuel Surcharge/Remote Area Delivery

Charge is estimated until DHL reweigh

**Reference Information**

Reference: PO 1000811537  
Pickup reference nr:

**Description of Contents**

USB Memory sticks

2019 © Deutsche Post AG - All rights reserved

10.

## APPENDICES

SCOPING REPORT: Scoping and Environmental Impact Assessment (EIA) Process for the Proposed Development of a Solar Photovoltaic (PV) Facility (Kudu Solar Facility 8) and associated infrastructure, near De Aar, Northern Cape Province

---



## Shipment Receipt

### Shipment From

CSIR  
Debbie Cloete / Rohaida Abed  
11 Jan Cilliers Street

7600 STELLENBOSCH  
South Africa  
+27218882400



### Shipment To

Hennie Liebenberg Junior Library  
[Redacted] (Librarian)\*  
Station Street

7000 DE AAR  
South Africa  
[Redacted]

### Shipment Details

Shipment Date: 2023-01-03  
Waybill Number: 5898928033  
Service Type: EXPRESS DOMESTIC  
Packaging Type: Flyer  
Number of Pieces: 1  
Total Weight: 1.00kg  
Dimensional: 0.36kg  
Chargeable: 1.00kg  
Insured Amount:  
Terms of Trade:

### International Information

Declared Value:  
Duties&taxes acct:  
Dutiable Status: Non-Dutiable  
Estimated Del date: Monday, 09 Jan, 2023  
Promo Code:

### Billing Information

Payment Type: DHL Account Number  
Billing Account: 305048439  
Duties&taxes acct:  
Charge Breakdown: 409.30 ZAR

Special Services: Fuel Surcharge/Remote Area Delivery

Charge is estimated until DHL reweigh

### Reference Information

Reference: PO 1000811537  
Pickup reference nr:

### Description of Contents

USB Memory sticks

## APPENDICES

SCOPING REPORT: Scoping and Environmental Impact Assessment (EIA) Process for the Proposed Development of a Solar Photovoltaic (PV) Facility (Kudu Solar Facility 8) and associated infrastructure, near De Aar, Northern Cape Province

---

### 9. Follow-Up/ Reminder Email sent to all I&APs, Stakeholders, and Organs of State on 17 January 2023

---

**From:** EMS  
**Sent:** Tuesday, 17 January 2023 12:06  
**To:** EMS  
**Subject:** Reminder - Availability of Draft Scoping Reports for Comment - Kudu Solar PV  
**Attachments:** Kudu Solar\_Letter 2\_DSR Release\_General IAPs\_FINAL\_091222.pdf

**Categories:** This message has been archived by Retain on January 24 2023 18:56

Dear Stakeholders and I&APs

**RE: REMINDER OF THE RELEASE OF THE DRAFT SCOPING REPORTS FOR A 30-DAY COMMENT PERIOD FOR THE PROPOSED DEVELOPMENT OF 12 SOLAR PHOTOVOLTAIC (PV) FACILITIES (I.E. KUDU SOLAR FACILITIES) AND VARIOUS ASSOCIATED INFRASTRUCTURE, NEAR DE AAR, NORTHERN CAPE**

Further to the email notification below, this serves as a reminder that the 30-day public comment period on the Draft Scoping Reports for the proposed 12 Solar Photovoltaic (PV) facilities (i.e. Kudu Solar Facilities) and various associated infrastructure, near De Aar, Northern Cape, as detailed below, closes on 30 January 2023.

As indicated below, the Draft Scoping Reports can be accessed as follows:

- Google Drive: [https://bit.ly/KUDU\\_SOLAR\\_PV](https://bit.ly/KUDU_SOLAR_PV)
- Project website: <https://www.csir.co.za/environmental-impact-assessment>

You are kindly requested to register your interest and submit any comments you may have on the Draft Scoping Reports to the CSIR by 30 January 2023 (details are provided below and in the attached).

Thank you to those of you that have already provided comment.

Please do not hesitate to contact us should you have any queries relating to the above.

In accordance with the Protection of Personal Information Act (Act 4 of 2013), the CSIR will conduct itself responsibly when collecting, processing, storing and sharing any personal information collected for the purposes of Public Participation Processes (PPP) in terms of the 2014 NEMA EIA Regulations (as amended). By registering as an Interested and Affected Party (I&AP) and/or submitting information and comments, you consent to the collection, collation, processing, and storing of such information and the use and disclosure of such information for the aforementioned purpose (<https://www.csir.co.za/csir-privacy-notice>). If you would like to opt out of communications on this project, please do so by responding to this correspondence via email.

Kind Regards,  
Rohaida Abed

CSIR Environmental Management Services  
E-mail: [ems@csir.co.za](mailto:ems@csir.co.za)  
Postal Address: P.O. Box 59081, Umbilo, Durban, 4075  
Tel: 031 242 2300



## APPENDICES

### SCOPING REPORT: Scoping and Environmental Impact Assessment (EIA) Process for the Proposed Development of a Solar Photovoltaic (PV) Facility (Kudu Solar Facility 8) and associated infrastructure, near De Aar, Northern Cape Province

#### 10. Proof of Delivery of Follow Up/ Reminder Email sent to all I&APs, Stakeholders, and Organs of State on 17 January 2023

EMS - Delivery Reports							By Date <span style="font-size: small;">v</span> <span style="font-size: small;">↑</span>				
					From	Subject	Received <span style="font-size: small;">v</span>	Size	Categories	Mention	
						<b>Mail Delivery... Undeliverable: Reminder - Availability of Draft Scoping Reports for Co...</b>	Mon 23 Jan 2023...	37 KB			
<small>[You don't often get email from mailer-daemon@mailgate1.inextweb.co.za. Learn why this is important at <a href="https://aka.ms/LearnAboutSenderIdentification">https://aka.ms/LearnAboutSenderIdentification</a> ]</small>											
						<b>Mail Delivery... Undeliverable: Reminder - Availability of Draft Scoping Reports for Co...</b>	Sun 22 Jan 2023...	37 KB		<b>This message ...</b>	
<small>[You don't often get email from mailer-daemon@pta-smg2.csir.co.za. Learn why this is important at <a href="https://aka.ms/LearnAboutSenderIdentification">https://aka.ms/LearnAboutSenderIdentification</a> ] This is the mail</small>											
						<b>Mail Delivery... Undeliverable: Reminder - Availability of Draft Scoping Reports for Co...</b>	Sun 22 Jan 2023...	36 KB		<b>This message ...</b>	
<small>[You don't often get email from mailer-daemon@pta-smg2.csir.co.za. Learn why this is important at <a href="https://aka.ms/LearnAboutSenderIdentification">https://aka.ms/LearnAboutSenderIdentification</a> ] This is the mail</small>											
						<b>Mail Delivery... Undeliverable: Reminder - Availability of Draft Scoping Reports for Co...</b>	Sun 22 Jan 2023...	38 KB		<b>This message ...</b>	
<small>[You don't often get email from mailer-daemon@pta-smg2.csir.co.za. Learn why this is important at <a href="https://aka.ms/LearnAboutSenderIdentification">https://aka.ms/LearnAboutSenderIdentification</a> ] This is the mail</small>											
<b>Two Weeks Ago</b>											
					postmaster@...	<b>Delivered: Reminder - Availability of Draft Scoping Reports for Comme...</b>	Tue 17 Jan 2023...	133 KB		<b>This message ...</b>	
<small>You don't often get email from postmaster@outlook.com. Learn why this is important &lt;<a href="https://aka.ms/LearnAboutSenderIdentification">https://aka.ms/LearnAboutSenderIdentification</a>&gt;</small>											
						<b>Mail Delivery... Relayed: Reminder - Availability of Draft Scoping Reports for Comment...</b>	Tue 17 Jan 2023...	72 KB		<b>This message ...</b>	
<small>[You don't often get email from mailer-daemon@pta-smg2.csir.co.za. Learn why this is important at <a href="https://aka.ms/LearnAboutSenderIdentification">https://aka.ms/LearnAboutSenderIdentification</a> ] This is the mail</small>											
						<b>Mail Delivery... Relayed: Reminder - Availability of Draft Scoping Reports for Comment...</b>	Tue 17 Jan 2023...	66 KB		<b>This message ...</b>	
<small>[You don't often get email from mailer-daemon@pta-smg2.csir.co.za. Learn why this is important at <a href="https://aka.ms/LearnAboutSenderIdentification">https://aka.ms/LearnAboutSenderIdentification</a> ] This is the mail</small>											
						<b>Mail Delivery... Undeliverable: Reminder - Availability of Draft Scoping Reports for Co...</b>	Tue 17 Jan 2023...	31 KB		<b>This message ...</b>	
<small>[You don't often get email from mailer-daemon@pta-smg2.csir.co.za. Learn why this is important at <a href="https://aka.ms/LearnAboutSenderIdentification">https://aka.ms/LearnAboutSenderIdentification</a> ] This is the mail</small>											
						<b>Mail Delivery... Relayed: Reminder - Availability of Draft Scoping Reports for Comment...</b>	Tue 17 Jan 2023...	73 KB		<b>This message ...</b>	
<small>[You don't often get email from mailer-daemon@pta-smg2.csir.co.za. Learn why this is important at <a href="https://aka.ms/LearnAboutSenderIdentification">https://aka.ms/LearnAboutSenderIdentification</a> ] This is the mail</small>											
					postmaster@...	<b>Undeliverable: Reminder - Availability of Draft Scoping Reports for Co...</b>	Tue 17 Jan 2023...	262 KB		<b>This message ...</b>	
<small>You don't often get email from postmaster@transnet.net. Learn why this is important &lt;<a href="https://aka.ms/LearnAboutSenderIdentification">https://aka.ms/LearnAboutSenderIdentification</a>&gt;</small>											
						<b>Mail Delivery... Undeliverable: This email might be SPAM This email might be SPAM Re...</b>	Tue 17 Jan 2023...	36 KB		<b>This message ...</b>	
<small>[You don't often get email from mailer-daemon@delivery.e-purifier.com. Learn why this is important at <a href="https://aka.ms/LearnAboutSenderIdentification">https://aka.ms/LearnAboutSenderIdentification</a> ]</small>											
					postmaster@...	<b>Delivered: Reminder - Availability of Draft Scoping Reports for Comme...</b>	Tue 17 Jan 2023...	139 KB		<b>This message ...</b>	
<small>You don't often get email from postmaster@dws.gov.za. Learn why this is important &lt;<a href="https://aka.ms/LearnAboutSenderIdentification">https://aka.ms/LearnAboutSenderIdentification</a>&gt;</small>											
					postmaster@...	<b>Delivered: Reminder - Availability of Draft Scoping Reports for Comme...</b>	Tue 17 Jan 2023...	139 KB		<b>This message ...</b>	
<small>You don't often get email from postmaster@dws.gov.za. Learn why this is important &lt;<a href="https://aka.ms/LearnAboutSenderIdentification">https://aka.ms/LearnAboutSenderIdentification</a>&gt;</small>											

## APPENDICES

### SCOPING REPORT: Scoping and Environmental Impact Assessment (EIA) Process for the Proposed Development of a Solar Photovoltaic (PV) Facility (Kudu Solar Facility 8) and associated infrastructure, near De Aar, Northern Cape Province

EMS - Delivery Reports						By Date ▾ ↑					
					From	Subject	Received ▾	Size	Categories	Mention	
					postmaster@...	<b>Delivered: Reminder - Availability of Draft Scoping Reports for Comme...</b> Your message has been delivered to the following recipients:	Tue 17 Jan 2023...	133 KB			<a href="#">This message ...</a>
					postmaster@...	<b>Delivered: Reminder - Availability of Draft Scoping Reports for Comme...</b> You don't often get email from postmaster@dws.gov.za. Learn why this is important < <a href="https://aka.ms/LearnAboutSenderIdentification">https://aka.ms/LearnAboutSenderIdentification</a> >	Tue 17 Jan 2023...	139 KB			<a href="#">This message ...</a>
					postmaster@...	<b>Delivered: Reminder - Availability of Draft Scoping Reports for Comme...</b> You don't often get email from postmaster@dws.gov.za. Learn why this is important < <a href="https://aka.ms/LearnAboutSenderIdentification">https://aka.ms/LearnAboutSenderIdentification</a> >	Tue 17 Jan 2023...	139 KB			<a href="#">This message ...</a>
					postmaster@...	<b>Delivered: Reminder - Availability of Draft Scoping Reports for Comme...</b> You don't often get email from postmaster@dws.gov.za. Learn why this is important < <a href="https://aka.ms/LearnAboutSenderIdentification">https://aka.ms/LearnAboutSenderIdentification</a> >	Tue 17 Jan 2023...	132 KB			<a href="#">This message ...</a>
					postmaster@...	<b>Delivered: Reminder - Availability of Draft Scoping Reports for Comme...</b> You don't often get email from postmaster@corp.akuoenergy.com. Learn why this is important < <a href="https://aka.ms/LearnAboutSenderIdentification">https://aka.ms/LearnAboutSenderIdentification</a> >	Tue 17 Jan 2023...	136 KB			<a href="#">This message ...</a>
					postmaster@...	<b>Delivered: Reminder - Availability of Draft Scoping Reports for Comme...</b> You don't often get email from postmaster@r-n.co.za. Learn why this is important < <a href="https://aka.ms/LearnAboutSenderIdentification">https://aka.ms/LearnAboutSenderIdentification</a> >	Tue 17 Jan 2023...	135 KB			<a href="#">This message ...</a>
					postmaster@...	<b>Undeliverable: Reminder - Availability of Draft Scoping Reports for Co...</b> [The e-mail server of the sender could not be verified (SPF Record)]	Tue 17 Jan 2023...	260 KB			<a href="#">This message ...</a>
					postmaster@...	<b>Delivered: Reminder - Availability of Draft Scoping Reports for Comme...</b> You don't often get email from postmaster@g7energies.com. Learn why this is important < <a href="https://aka.ms/LearnAboutSenderIdentification">https://aka.ms/LearnAboutSenderIdentification</a> >	Tue 17 Jan 2023...	137 KB			<a href="#">This message ...</a>
					postmaster@...	<b>Delivered: Reminder - Availability of Draft Scoping Reports for Comme...</b> You don't often get email from postmaster@g7energies.com. Learn why this is important < <a href="https://aka.ms/LearnAboutSenderIdentification">https://aka.ms/LearnAboutSenderIdentification</a> >	Tue 17 Jan 2023...	137 KB			<a href="#">This message ...</a>
					postmaster@...	<b>Delivered: Reminder - Availability of Draft Scoping Reports for Comme...</b> You don't often get email from postmaster@g7energies.com. Learn why this is important < <a href="https://aka.ms/LearnAboutSenderIdentification">https://aka.ms/LearnAboutSenderIdentification</a> >	Tue 17 Jan 2023...	137 KB			<a href="#">This message ...</a>
					postmaster@...	<b>Delivered: Reminder - Availability of Draft Scoping Reports for Comme...</b> You don't often get email from postmaster@g7energies.com. Learn why this is important < <a href="https://aka.ms/LearnAboutSenderIdentification">https://aka.ms/LearnAboutSenderIdentification</a> >	Tue 17 Jan 2023...	137 KB			<a href="#">This message ...</a>
					postmaster@...	<b>Delivered: Reminder - Availability of Draft Scoping Reports for Comme...</b> You don't often get email from postmaster@g7energies.com. Learn why this is important < <a href="https://aka.ms/LearnAboutSenderIdentification">https://aka.ms/LearnAboutSenderIdentification</a> >	Tue 17 Jan 2023...	137 KB			<a href="#">This message ...</a>

## APPENDICES

### SCOPING REPORT: Scoping and Environmental Impact Assessment (EIA) Process for the Proposed Development of a Solar Photovoltaic (PV) Facility (Kudu Solar Facility 8) and associated infrastructure, near De Aar, Northern Cape Province

EMS - Delivery Reports										By Date ▾ ↑	
					From	Subject	Received ▾	Size	Categories	Mention	
					postmaster@...	<b>Delivered: Reminder - Availability of Draft Scoping Reports for Comme...</b> Tue 17 Jan 2023... 137 KB <b>This message ...</b> You don't often get email from postmaster@g7energies.com. Learn why this is important <https://aka.ms/LearnAboutSenderIdentification>					
					postmaster@...	<b>Delivered: Reminder - Availability of Draft Scoping Reports for Comme...</b> Tue 17 Jan 2023... 137 KB <b>This message ...</b> You don't often get email from postmaster@g7energies.com. Learn why this is important <https://aka.ms/LearnAboutSenderIdentification>					
					postmaster@...	<b>Delivered: Reminder - Availability of Draft Scoping Reports for Comme...</b> Tue 17 Jan 2023... 137 KB <b>This message ...</b> You don't often get email from postmaster@g7energies.com. Learn why this is important <https://aka.ms/LearnAboutSenderIdentification>					
					postmaster@...	<b>Delivered: Reminder - Availability of Draft Scoping Reports for Comme...</b> Tue 17 Jan 2023... 137 KB <b>This message ...</b> You don't often get email from postmaster@g7energies.com. Learn why this is important <https://aka.ms/LearnAboutSenderIdentification>					
					postmaster@...	<b>Delivered: Reminder - Availability of Draft Scoping Reports for Comme...</b> Tue 17 Jan 2023... 137 KB <b>This message ...</b> You don't often get email from postmaster@g7energies.com. Learn why this is important <https://aka.ms/LearnAboutSenderIdentification>					
					postmaster@...	<b>Delivered: Reminder - Availability of Draft Scoping Reports for Comme...</b> Tue 17 Jan 2023... 126 KB <b>This message ...</b> You don't often get email from postmaster@weathersa.co.za. Learn why this is important <https://aka.ms/LearnAboutSenderIdentification>					
					postmaster@...	<b>Delivered: Reminder - Availability of Draft Scoping Reports for Comme...</b> Tue 17 Jan 2023... 126 KB <b>This message ...</b> You don't often get email from postmaster@weathersa.co.za. Learn why this is important <https://aka.ms/LearnAboutSenderIdentification>					
					postmaster@...	<b>Delivered: Reminder - Availability of Draft Scoping Reports for Comme...</b> Tue 17 Jan 2023... 126 KB <b>This message ...</b> You don't often get email from postmaster@weathersa.co.za. Learn why this is important <https://aka.ms/LearnAboutSenderIdentification>					
					Mail Delivery...	<b>Undeliverable: Reminder - Availability of Draft Scoping Reports for Co...</b> Tue 17 Jan 2023... 30 KB <b>This message ...</b> [You don't often get email from mailer-daemon@pta-smg2.csir.co.za. Learn why this is important at https://aka.ms/LearnAboutSenderIdentification ] This is the mail					
					Mail Delivery...	<b>Relayed: Reminder - Availability of Draft Scoping Reports for Comment...</b> Tue 17 Jan 2023... 110 KB <b>This message ...</b> [You don't often get email from mailer-daemon@pta-smg2.csir.co.za. Learn why this is important at https://aka.ms/LearnAboutSenderIdentification ] This is the mail					
					postmaster@...	<b>Undeliverable: Reminder - Availability of Draft Scoping Reports for Co...</b> Tue 17 Jan 2023... 259 KB <b>This message ...</b> [The e-mail server of the sender could not be verified (SPF Record)]					
					Mail Delivery...	<b>Delivered: Reminder - Availability of Draft Scoping Reports for Comme...</b> Tue 17 Jan 2023... 78 KB <b>This message ...</b> [You don't often get email from mailer-daemon@server.itdesign.co.za. Learn why this is important at https://aka.ms/LearnAboutSenderIdentification ] This message					

## APPENDICES

### SCOPING REPORT: Scoping and Environmental Impact Assessment (EIA) Process for the Proposed Development of a Solar Photovoltaic (PV) Facility (Kudu Solar Facility 8) and associated infrastructure, near De Aar, Northern Cape Province

EMS - Delivery Reports										By Date <span style="font-size: small;">v</span> <span style="font-size: small;">↑</span>	
					From	Subject	Received <span style="font-size: small;">v</span>	Size	Categories	Mention	
						<b>Mail Delivery... Relayed: Reminder - Availability of Draft Scoping Reports for Comment...</b>	Tue 17 Jan 2023...	98 KB		<b>This message ...</b>	[You don't often get email from mailer-daemon@pta-smg2.csir.co.za. Learn why this is important at <a href="https://aka.ms/LearnAboutSenderIdentification">https://aka.ms/LearnAboutSenderIdentification</a> ] This is the mail
						<b>Mail Delivery... Undeliverable: Reminder - Availability of Draft Scoping Reports for Co...</b>	Tue 17 Jan 2023...	36 KB		<b>This message ...</b>	[You don't often get email from mailer-daemon@pta-smg2.csir.co.za. Learn why this is important at <a href="https://aka.ms/LearnAboutSenderIdentification">https://aka.ms/LearnAboutSenderIdentification</a> ] This is the mail
						<b>Mail Delivery... Relayed: Reminder - Availability of Draft Scoping Reports for Comment...</b>	Tue 17 Jan 2023...	113 KB		<b>This message ...</b>	[You don't often get email from mailer-daemon@pta-smg2.csir.co.za. Learn why this is important at <a href="https://aka.ms/LearnAboutSenderIdentification">https://aka.ms/LearnAboutSenderIdentification</a> ] This is the mail
						<b>Mail Delivery... Undeliverable: Reminder - Availability of Draft Scoping Reports for Co...</b>	Tue 17 Jan 2023...	34 KB		<b>This message ...</b>	[You don't often get email from mailer-daemon@pta-smg2.csir.co.za. Learn why this is important at <a href="https://aka.ms/LearnAboutSenderIdentification">https://aka.ms/LearnAboutSenderIdentification</a> ] This is the mail
						<b>Mail Delivery... Relayed: Reminder - Availability of Draft Scoping Reports for Comment...</b>	Tue 17 Jan 2023...	109 KB		<b>This message ...</b>	[You don't often get email from mailer-daemon@pta-smg2.csir.co.za. Learn why this is important at <a href="https://aka.ms/LearnAboutSenderIdentification">https://aka.ms/LearnAboutSenderIdentification</a> ] This is the mail
						<b>Mail Delivery... Relayed: Reminder - Availability of Draft Scoping Reports for Comment...</b>	Tue 17 Jan 2023...	83 KB		<b>This message ...</b>	[You don't often get email from mailer-daemon@hostserv.co.za. Learn why this is important at <a href="https://aka.ms/LearnAboutSenderIdentification">https://aka.ms/LearnAboutSenderIdentification</a> ]
					postmaster@...	<b>Delivered: Reminder - Availability of Draft Scoping Reports for Comme...</b>	Tue 17 Jan 2023...	131 KB		<b>This message ...</b>	You don't often get email from postmaster@birdlife.org.za. Learn why this is important < <a href="https://aka.ms/LearnAboutSenderIdentification">https://aka.ms/LearnAboutSenderIdentification</a> >
					postmaster@...	<b>Delivered: Reminder - Availability of Draft Scoping Reports for Comme...</b>	Tue 17 Jan 2023...	132 KB		<b>This message ...</b>	You don't often get email from postmaster@wessa.co.za. Learn why this is important < <a href="https://aka.ms/LearnAboutSenderIdentification">https://aka.ms/LearnAboutSenderIdentification</a> >
					postmaster@...	<b>Delivered: Reminder - Availability of Draft Scoping Reports for Comme...</b>	Tue 17 Jan 2023...	131 KB		<b>This message ...</b>	You don't often get email from postmaster@outlook.com. Learn why this is important < <a href="https://aka.ms/LearnAboutSenderIdentification">https://aka.ms/LearnAboutSenderIdentification</a> >
					postmaster@...	<b>Delivered: Reminder - Availability of Draft Scoping Reports for Comme...</b>	Tue 17 Jan 2023...	131 KB		<b>This message ...</b>	You don't often get email from postmaster@birdlife.org.za. Learn why this is important < <a href="https://aka.ms/LearnAboutSenderIdentification">https://aka.ms/LearnAboutSenderIdentification</a> >
					postmaster@...	<b>Delivered: Reminder - Availability of Draft Scoping Reports for Comme...</b>	Tue 17 Jan 2023...	133 KB		<b>This message ...</b>	You don't often get email from postmaster@outlook.com. Learn why this is important < <a href="https://aka.ms/LearnAboutSenderIdentification">https://aka.ms/LearnAboutSenderIdentification</a> >
					MAILER-DAE...	<b>Failure Notice</b>	Tue 17 Jan 2023...	120 KB		<b>This message ...</b>	[You don't often get email from mailer-daemon@yahoo.com. Learn why this is important at <a href="https://aka.ms/LearnAboutSenderIdentification">https://aka.ms/LearnAboutSenderIdentification</a> ]
						<b>Mail Delivery... Delivered: Reminder - Availability of Draft Scoping Reports for Comme...</b>	Tue 17 Jan 2023...	83 KB		<b>This message ...</b>	[You don't often get email from mailer-daemon@ci74p00im-qukt09072702.me.com. Learn why this is important at <a href="https://aka.ms/LearnAboutSenderIdentification">https://aka.ms/LearnAboutSenderIdentification</a> ]

## APPENDICES

### SCOPING REPORT: Scoping and Environmental Impact Assessment (EIA) Process for the Proposed Development of a Solar Photovoltaic (PV) Facility (Kudu Solar Facility 8) and associated infrastructure, near De Aar, Northern Cape Province

EMS - Delivery Reports										By Date <span style="font-size: small;">v</span> <span style="font-size: small;">↑</span>
From	Subject	Received <span style="font-size: x-small;">v</span>	Size	Categories	Mention					
<b>Mail Delivery...</b>	<b>Undeliverable: Reminder - Availability of Draft Scoping Reports for Co...</b>	Tue 17 Jan 2023...	36 KB			<b>This message ...</b>	[You don't often get email from mailer-daemon@mailcape.saa.ac.za. Learn why this is important at <a href="https://aka.ms/LearnAboutSenderIdentification">https://aka.ms/LearnAboutSenderIdentification</a> ]			
<b>postmaster@...</b>	<b>Delivered: Reminder - Availability of Draft Scoping Reports for Comme...</b>	Tue 17 Jan 2023...	131 KB			<b>This message ...</b>	You don't often get email from postmaster@birdlife.org.za. Learn why this is important < <a href="https://aka.ms/LearnAboutSenderIdentification">https://aka.ms/LearnAboutSenderIdentification</a> >			
<b>postmaster@...</b>	<b>Delivered: Reminder - Availability of Draft Scoping Reports for Comme...</b>	Tue 17 Jan 2023...	130 KB			<b>This message ...</b>	You don't often get email from postmaster@outlook.com. Learn why this is important < <a href="https://aka.ms/LearnAboutSenderIdentification">https://aka.ms/LearnAboutSenderIdentification</a> >			
<b>postmaster@...</b>	<b>Delivered: Reminder - Availability of Draft Scoping Reports for Comme...</b>	Tue 17 Jan 2023...	131 KB			<b>This message ...</b>	You don't often get email from postmaster@netorg6186573.onmicrosoft.com. Learn why this is important < <a href="https://aka.ms/LearnAboutSenderIdentification">https://aka.ms/LearnAboutSenderIdentification</a> >			
<b>postmaster@...</b>	<b>Delivered: Reminder - Availability of Draft Scoping Reports for Comme...</b>	Tue 17 Jan 2023...	129 KB			<b>This message ...</b>	You don't often get email from postmaster@netorg7356748.onmicrosoft.com. Learn why this is important < <a href="https://aka.ms/LearnAboutSenderIdentification">https://aka.ms/LearnAboutSenderIdentification</a> >			
<b>postmaster@...</b>	<b>Delivered: Reminder - Availability of Draft Scoping Reports for Comme...</b>	Tue 17 Jan 2023...	131 KB			<b>This message ...</b>	You don't often get email from postmaster@agrlink.co.za. Learn why this is important < <a href="https://aka.ms/LearnAboutSenderIdentification">https://aka.ms/LearnAboutSenderIdentification</a> >			
<b>postmaster@...</b>	<b>Delivered: Reminder - Availability of Draft Scoping Reports for Comme...</b>	Tue 17 Jan 2023...	131 KB			<b>This message ...</b>	You don't often get email from postmaster@agrlink.co.za. Learn why this is important < <a href="https://aka.ms/LearnAboutSenderIdentification">https://aka.ms/LearnAboutSenderIdentification</a> >			
<b>postmaster@...</b>	<b>Delivered: Reminder - Availability of Draft Scoping Reports for Comme...</b>	Tue 17 Jan 2023...	131 KB			<b>This message ...</b>	You don't often get email from postmaster@mulilo.com. Learn why this is important < <a href="https://aka.ms/LearnAboutSenderIdentification">https://aka.ms/LearnAboutSenderIdentification</a> >			
<b>postmaster@...</b>	<b>Delivered: Reminder - Availability of Draft Scoping Reports for Comme...</b>	Tue 17 Jan 2023...	127 KB			<b>This message ...</b>	You don't often get email from postmaster@nocci.co.za. Learn why this is important < <a href="https://aka.ms/LearnAboutSenderIdentification">https://aka.ms/LearnAboutSenderIdentification</a> >			
<b>Mail Delivery...</b>	<b>Relayed: Reminder - Availability of Draft Scoping Reports for Comment...</b>	Tue 17 Jan 2023...	66 KB			<b>This message ...</b>	[You don't often get email from mailer-daemon@pta-smg2.csir.co.za. Learn why this is important at <a href="https://aka.ms/LearnAboutSenderIdentification">https://aka.ms/LearnAboutSenderIdentification</a> ] This is the mail			
<b>Mail Delivery...</b>	<b>Relayed: Reminder - Availability of Draft Scoping Reports for Comment...</b>	Tue 17 Jan 2023...	78 KB			<b>This message ...</b>	[You don't often get email from mailer-daemon@hostserv.co.za. Learn why this is important at <a href="https://aka.ms/LearnAboutSenderIdentification">https://aka.ms/LearnAboutSenderIdentification</a> ]			
<b>Mail Delivery...</b>	<b>Relayed: Reminder - Availability of Draft Scoping Reports for Comment...</b>	Tue 17 Jan 2023...	72 KB			<b>This message ...</b>	[You don't often get email from mailer-daemon@pta-smg2.csir.co.za. Learn why this is important at <a href="https://aka.ms/LearnAboutSenderIdentification">https://aka.ms/LearnAboutSenderIdentification</a> ] This is the mail			
<b>Microsoft Ou...</b>	<b>Delivered: Reminder - Availability of Draft Scoping Reports for Comme...</b>	Tue 17 Jan 2023...	172 KB			<b>This message ...</b>	Your message has been delivered to the following recipients:			

## APPENDICES

### SCOPING REPORT: Scoping and Environmental Impact Assessment (EIA) Process for the Proposed Development of a Solar Photovoltaic (PV) Facility (Kudu Solar Facility 8) and associated infrastructure, near De Aar, Northern Cape Province

---

-  **Microsoft Outlook** Delivered: Reminder - Availability of Draft Scoping Reports for Comm... Tue 17 Jan 2023... 172 KB [This message ...](#)  
Your message has been delivered to the following recipients:
-  **Microsoft Outlook** Delivered: Reminder - Availability of Draft Scoping Reports for Comm... Tue 17 Jan 2023... 172 KB [This message ...](#)  
Your message has been delivered to the following recipients:
-  **Microsoft Outlook** Delivered: Reminder - Availability of Draft Scoping Reports for Comm... Tue 17 Jan 2023... 180 KB [This message ...](#)  
Your message has been delivered to the following recipients:

**APPENDICES**

SCOPING REPORT: Scoping and Environmental Impact Assessment (EIA) Process for the Proposed Development of a Solar Photovoltaic (PV) Facility (Kudu Solar Facility 8) and associated infrastructure, near De Aar, Northern Cape Province

---

**11. Proof of SMS Reminder Text Message sent to all I&APs, Stakeholders, and Organs of State (where cell phone numbers were available) on 17 January 2023**

**Copy of text included in the SMS:** Dear Stakeholder, Reminder that the comment period on the Draft Scoping Reports for the proposed Kudu Solar Facilities 1-12 near De Aar, NC closes 30 Jan 2023. Visit [https://bit.ly/KUDU\\_SOLAR\\_PV](https://bit.ly/KUDU_SOLAR_PV) or [https://bit.ly/CSIR\\_EIA](https://bit.ly/CSIR_EIA) to access the reports. To send comments, queries or to opt out of future communication on these projects, email [ems@csir.co.za](mailto:ems@csir.co.za). Regards, CSIR EMS Team ([https://bit.ly/CSIR\\_privacy](https://bit.ly/CSIR_privacy))

created_time	msisdn	status	status_text	origin_address	delivered_time	batch_id
2023-01-17 12:51:08.0	[REDACTED]	11	Delivered to phone	[REDACTED]	2023-01-17 12:51:00.0	1625809243
2023-01-17 12:51:08.0	[REDACTED]	11	Delivered to phone	[REDACTED]	2023-01-17 12:51:00.0	1625809243
2023-01-17 12:51:08.0	[REDACTED]	11	Delivered to phone	[REDACTED]	2023-01-17 12:51:00.0	1625809243
2023-01-17 12:51:08.0	[REDACTED]	11	Delivered to phone	[REDACTED]	2023-01-17 12:51:00.0	1625809243
2023-01-17 12:51:08.0	[REDACTED]	11	Delivered to phone	[REDACTED]	2023-01-17 12:51:00.0	1625809243
2023-01-17 12:51:08.0	[REDACTED]	11	Delivered to phone	[REDACTED]	2023-01-17 12:51:00.0	1625809243
2023-01-17 12:51:08.0	[REDACTED]	11	Delivered to phone	[REDACTED]	2023-01-17 12:51:00.0	1625809243
2023-01-17 12:51:08.0	[REDACTED]	11	Delivered to phone	[REDACTED]	2023-01-17 12:51:00.0	1625809243
2023-01-17 12:51:08.0	[REDACTED]	11	Delivered to phone	[REDACTED]	2023-01-17 12:51:00.0	1625809243
2023-01-17 12:51:08.0	[REDACTED]	50	Failed	[REDACTED]	2023-01-17 13:06:00.0	1625809243
2023-01-17 12:51:08.0	[REDACTED]	50	Failed	[REDACTED]	2023-01-17 13:06:00.0	1625809243
2023-01-17 12:51:08.0	[REDACTED]	50	Failed	[REDACTED]	2023-01-17 13:06:00.0	1625809243
2023-01-17 12:51:08.0	[REDACTED]	11	Delivered to phone	[REDACTED]	2023-01-17 12:51:00.0	1625809243
2023-01-17 12:51:08.0	[REDACTED]	11	Delivered to phone	[REDACTED]	2023-01-17 12:51:00.0	1625809243
2023-01-17 12:51:08.0	[REDACTED]	11	Delivered to phone	[REDACTED]	2023-01-17 12:51:00.0	1625809243
2023-01-17 12:51:08.0	[REDACTED]	11	Delivered to phone	[REDACTED]	2023-01-17 12:51:00.0	1625809243
2023-01-17 12:51:08.0	[REDACTED]	11	Delivered to phone	[REDACTED]	2023-01-17 12:51:00.0	1625809243
2023-01-17 12:51:08.0	[REDACTED]	11	Delivered to phone	[REDACTED]	2023-01-17 12:51:00.0	1625809243
2023-01-17 12:51:08.0	[REDACTED]	11	Delivered to phone	[REDACTED]	2023-01-17 12:51:00.0	1625809243
2023-01-17 12:51:08.0	[REDACTED]	11	Delivered to phone	[REDACTED]	2023-01-17 12:51:00.0	1625809243
2023-01-17 12:51:08.0	[REDACTED]	11	Delivered to phone	[REDACTED]	2023-01-17 12:51:00.0	1625809243
2023-01-17 12:51:08.0	[REDACTED]	11	Delivered to phone	[REDACTED]	2023-01-17 12:51:00.0	1625809243





**APPENDICES**

SCOPING REPORT: Scoping and Environmental Impact Assessment (EIA) Process for the Proposed Development of a Solar Photovoltaic (PV) Facility (Kudu Solar Facility 8) and associated infrastructure, near De Aar, Northern Cape Province

---

created_time	msisdn	status	status_text	origin_address	delivered_time	batch_id
2023-01-17 12:51:08.0	[REDACTED]	11	Delivered to phone	[REDACTED]	2023-01-17 12:51:00.0	1625809243
2023-01-17 12:51:08.0	[REDACTED]	11	Delivered to phone	[REDACTED]	2023-01-17 12:51:00.0	1625809243
2023-01-17 12:51:08.0	[REDACTED]	11	Delivered to phone	[REDACTED]	2023-01-17 12:51:00.0	1625809243
2023-01-17 12:51:08.0	[REDACTED]	11	Delivered to phone	[REDACTED]	2023-01-17 12:51:00.0	1625809243
2023-01-17 12:51:08.0	[REDACTED]	11	Delivered to phone	[REDACTED]	2023-01-17 12:51:00.0	1625809243
2023-01-17 12:51:08.0	[REDACTED]	11	Delivered to phone	[REDACTED]	2023-01-17 12:51:00.0	1625809243
2023-01-17 12:51:08.0	[REDACTED]	11	Delivered to phone	[REDACTED]	2023-01-17 12:51:00.0	1625809243
2023-01-17 12:51:08.0	[REDACTED]	11	Delivered to phone	[REDACTED]	2023-01-17 12:51:00.0	1625809243
2023-01-17 12:51:08.0	[REDACTED]	11	Delivered to phone	[REDACTED]	2023-01-17 12:52:00.0	1625809243
2023-01-17 12:51:08.0	[REDACTED]	11	Delivered to phone	[REDACTED]	2023-01-17 12:51:00.0	1625809243
2023-01-17 12:51:08.0	[REDACTED]	11	Delivered to phone	[REDACTED]	2023-01-17 12:51:00.0	1625809243
2023-01-17 12:51:08.0	[REDACTED]	11	Delivered to phone	[REDACTED]	2023-01-17 12:51:00.0	1625809243
2023-01-17 12:51:08.0	[REDACTED]	50	Failed	[REDACTED]	2023-01-17 12:51:00.0	1625809243
2023-01-17 12:51:08.0	[REDACTED]	50	Failed	[REDACTED]	2023-01-17 12:51:00.0	1625809243
2023-01-17 12:51:08.0	[REDACTED]	50	Failed	[REDACTED]	2023-01-17 12:51:00.0	1625809243
2023-01-17 12:51:08.0	[REDACTED]	11	Delivered to phone	[REDACTED]	2023-01-17 12:51:00.0	1625809243
2023-01-17 12:51:08.0	[REDACTED]	11	Delivered to phone	[REDACTED]	2023-01-17 12:51:00.0	1625809243
2023-01-17 12:51:08.0	[REDACTED]	11	Delivered to phone	[REDACTED]	2023-01-17 12:52:00.0	1625809243
2023-01-17 12:51:08.0	[REDACTED]	11	Delivered to phone	[REDACTED]	2023-01-17 12:51:00.0	1625809243
2023-01-17 12:51:08.0	[REDACTED]	11	Delivered to phone	[REDACTED]	2023-01-17 12:51:00.0	1625809243
2023-01-17 12:51:08.0	[REDACTED]	11	Delivered to phone	[REDACTED]	2023-01-17 12:51:00.0	1625809243
2023-01-17 12:51:08.0	[REDACTED]	11	Delivered to phone	[REDACTED]	2023-01-17 12:51:00.0	1625809243
2023-01-17 12:51:08.0	[REDACTED]	11	Delivered to phone	[REDACTED]	2023-01-17 12:51:00.0	1625809243
2023-01-17 12:51:08.0	[REDACTED]	11	Delivered to phone	[REDACTED]	2023-01-17 12:51:00.0	1625809243
2023-01-17 12:51:08.0	[REDACTED]	11	Delivered to phone	[REDACTED]	2023-01-17 14:12:00.0	1625809243
2023-01-17 12:51:08.0	[REDACTED]	11	Delivered to phone	[REDACTED]	2023-01-17 14:25:00.0	1625809243
2023-01-17 12:51:08.0	[REDACTED]	11	Delivered to phone	[REDACTED]	2023-01-17 14:26:00.0	1625809243
2023-01-17 12:51:08.0	[REDACTED]	11	Delivered to phone	[REDACTED]	2023-01-17 12:51:00.0	1625809243
2023-01-17 12:51:08.0	[REDACTED]	11	Delivered to phone	[REDACTED]	2023-01-17 12:51:00.0	1625809243
2023-01-17 12:51:08.0	[REDACTED]	11	Delivered to phone	[REDACTED]	2023-01-17 12:51:00.0	1625809243

**APPENDICES**

SCOPING REPORT: Scoping and Environmental Impact Assessment (EIA) Process for the Proposed Development of a Solar Photovoltaic (PV) Facility (Kudu Solar Facility 8) and associated infrastructure, near De Aar, Northern Cape Province

---

created_time	msisdn	status	status_text	origin_address	delivered_time	batch_id
2023-01-17 12:51:08.0	[REDACTED]	11	Delivered to phone	[REDACTED]	2023-01-17 12:51:00.0	1625809243
2023-01-17 12:51:08.0	[REDACTED]	11	Delivered to phone	[REDACTED]	2023-01-17 12:51:00.0	1625809243
2023-01-17 12:51:08.0	[REDACTED]	11	Delivered to phone	[REDACTED]	2023-01-17 12:51:00.0	1625809243
2023-01-17 12:51:08.0	[REDACTED]	11	Delivered to phone	[REDACTED]	2023-01-17 12:51:00.0	1625809243
2023-01-17 12:51:08.0	[REDACTED]	11	Delivered to phone	[REDACTED]	2023-01-17 12:51:00.0	1625809243
2023-01-17 12:51:08.0	[REDACTED]	11	Delivered to phone	[REDACTED]	2023-01-17 12:51:00.0	1625809243
2023-01-17 12:51:08.0	[REDACTED]	11	Delivered to phone	[REDACTED]	2023-01-17 12:51:00.0	1625809243
2023-01-17 12:51:08.0	[REDACTED]	11	Delivered to phone	[REDACTED]	2023-01-17 12:51:00.0	1625809243
2023-01-17 12:51:08.0	[REDACTED]	11	Delivered to phone	[REDACTED]	2023-01-17 12:51:00.0	1625809243
2023-01-17 12:51:08.0	[REDACTED]	11	Delivered to phone	[REDACTED]	2023-01-17 12:52:00.0	1625809243
2023-01-17 12:51:08.0	[REDACTED]	11	Delivered to phone	[REDACTED]	2023-01-17 12:51:00.0	1625809243
2023-01-17 12:51:08.0	[REDACTED]	11	Delivered to phone	[REDACTED]	2023-01-17 12:51:00.0	1625809243
2023-01-17 12:51:08.0	[REDACTED]	11	Delivered to phone	[REDACTED]	2023-01-17 12:51:00.0	1625809243
2023-01-17 12:51:08.0	[REDACTED]	11	Delivered to phone	[REDACTED]	2023-01-17 12:51:00.0	1625809243
2023-01-17 12:51:08.0	[REDACTED]	11	Delivered to phone	[REDACTED]	2023-01-17 12:51:00.0	1625809243
2023-01-17 12:51:08.0	[REDACTED]	11	Delivered to phone	[REDACTED]	2023-01-17 12:51:00.0	1625809243
2023-01-17 12:51:08.0	[REDACTED]	11	Delivered to phone	[REDACTED]	2023-01-17 12:51:00.0	1625809243
2023-01-17 12:51:08.0	[REDACTED]	11	Delivered to phone	[REDACTED]	2023-01-17 12:51:00.0	1625809243
2023-01-17 12:51:08.0	[REDACTED]	11	Delivered to phone	[REDACTED]	2023-01-17 12:51:00.0	1625809243
2023-01-17 12:51:08.0	[REDACTED]	11	Delivered to phone	[REDACTED]	2023-01-17 12:51:00.0	1625809243
2023-01-17 12:51:08.0	[REDACTED]	11	Delivered to phone	[REDACTED]	2023-01-17 12:51:00.0	1625809243
2023-01-17 12:51:08.0	[REDACTED]	11	Delivered to phone	[REDACTED]	2023-01-17 12:51:00.0	1625809243
2023-01-17 12:51:08.0	[REDACTED]	11	Delivered to phone	[REDACTED]	2023-01-17 12:51:00.0	1625809243
2023-01-17 12:51:08.0	[REDACTED]	11	Delivered to phone	[REDACTED]	2023-01-17 12:51:00.0	1625809243
2023-01-17 12:51:08.0	[REDACTED]	50	Failed	[REDACTED]	2023-01-18 12:51:00.0	1625809243
2023-01-17 12:51:08.0	[REDACTED]	50	Failed	[REDACTED]	2023-01-18 12:51:00.0	1625809243
2023-01-17 12:51:08.0	[REDACTED]	50	Failed	[REDACTED]	2023-01-18 12:51:00.0	1625809243
2023-01-17 12:51:08.0	[REDACTED]	11	Delivered to phone	[REDACTED]	2023-01-17 12:51:00.0	1625809243
2023-01-17 12:51:08.0	[REDACTED]	11	Delivered to phone	[REDACTED]	2023-01-17 12:51:00.0	1625809243
2023-01-17 12:51:08.0	[REDACTED]	11	Delivered to phone	[REDACTED]	2023-01-17 12:51:00.0	1625809243

**APPENDICES**

SCOPING REPORT: Scoping and Environmental Impact Assessment (EIA) Process for the Proposed Development of a Solar Photovoltaic (PV) Facility (Kudu Solar Facility 8) and associated infrastructure, near De Aar, Northern Cape Province

---

created_time	msisdn	status	status_text	origin_address	delivered_time	batch_id
2023-01-17 12:51:08.0	[REDACTED]	11	Delivered to phone	[REDACTED]	2023-01-17 12:51:00.0	1625809243
2023-01-17 12:51:08.0	[REDACTED]	11	Delivered to phone	[REDACTED]	2023-01-17 12:51:00.0	1625809243
2023-01-17 12:51:08.0	[REDACTED]	11	Delivered to phone	[REDACTED]	2023-01-17 12:52:00.0	1625809243
2023-01-17 12:51:08.0	[REDACTED]	52	Failed: delivery to network failed	[REDACTED]		1625809243
2023-01-17 12:51:08.0	[REDACTED]	52	Failed: delivery to network failed	[REDACTED]		1625809243
2023-01-17 12:51:08.0	[REDACTED]	52	Failed: delivery to network failed	[REDACTED]		1625809243
2023-01-17 12:51:08.0	[REDACTED]	11	Delivered to phone	[REDACTED]	2023-01-17 12:51:00.0	1625809243
2023-01-17 12:51:08.0	[REDACTED]	11	Delivered to phone	[REDACTED]	2023-01-17 12:51:00.0	1625809243
2023-01-17 12:51:08.0	[REDACTED]	11	Delivered to phone	[REDACTED]	2023-01-17 12:51:00.0	1625809243
2023-01-17 12:51:08.0	[REDACTED]	11	Delivered to phone	[REDACTED]	2023-01-17 12:51:00.0	1625809243
2023-01-17 12:51:08.0	[REDACTED]	11	Delivered to phone	[REDACTED]	2023-01-17 12:51:00.0	1625809243
2023-01-17 12:51:08.0	[REDACTED]	11	Delivered to phone	[REDACTED]	2023-01-17 12:51:00.0	1625809243
2023-01-17 12:51:08.0	[REDACTED]	11	Delivered to phone	[REDACTED]	2023-01-17 14:14:00.0	1625809243
2023-01-17 12:51:08.0	[REDACTED]	11	Delivered to phone	[REDACTED]	2023-01-17 14:14:00.0	1625809243
2023-01-17 12:51:08.0	[REDACTED]	11	Delivered to phone	[REDACTED]	2023-01-17 14:14:00.0	1625809243
2023-01-17 12:51:08.0	[REDACTED]	52	Failed: delivery to network failed	[REDACTED]		1625809243
2023-01-17 12:51:08.0	[REDACTED]	52	Failed: delivery to network failed	[REDACTED]		1625809243
2023-01-17 12:51:08.0	[REDACTED]	52	Failed: delivery to network failed	[REDACTED]		1625809243
2023-01-17 12:51:08.0	[REDACTED]	11	Delivered to phone	[REDACTED]	2023-01-17 12:51:00.0	1625809243
2023-01-17 12:51:08.0	[REDACTED]	11	Delivered to phone	[REDACTED]	2023-01-17 12:51:00.0	1625809243
2023-01-17 12:51:08.0	[REDACTED]	11	Delivered to phone	[REDACTED]	2023-01-17 12:51:00.0	1625809243
2023-01-17 12:51:08.0	[REDACTED]	11	Delivered to phone	[REDACTED]	2023-01-17 12:51:00.0	1625809243
2023-01-17 12:51:08.0	[REDACTED]	11	Delivered to phone	[REDACTED]	2023-01-17 12:51:00.0	1625809243
2023-01-17 12:51:08.0	[REDACTED]	11	Delivered to phone	[REDACTED]	2023-01-17 12:51:00.0	1625809243
2023-01-17 12:51:08.0	[REDACTED]	11	Delivered to phone	[REDACTED]	2023-01-17 12:51:00.0	1625809243
2023-01-17 12:51:08.0	[REDACTED]	11	Delivered to phone	[REDACTED]	2023-01-17 12:51:00.0	1625809243
2023-01-17 12:51:08.0	[REDACTED]	11	Delivered to phone	[REDACTED]	2023-01-17 12:51:00.0	1625809243

**APPENDICES**

SCOPING REPORT: Scoping and Environmental Impact Assessment (EIA) Process for the Proposed Development of a Solar Photovoltaic (PV) Facility (Kudu Solar Facility 8) and associated infrastructure, near De Aar, Northern Cape Province

---

created_time	msisdn	status	status_text	origin_address	delivered_time	batch_id
2023-01-17 12:51:08.0	[REDACTED]	11	Delivered to phone	[REDACTED]	2023-01-17 12:51:00.0	1625809243
2023-01-17 12:51:08.0	[REDACTED]	11	Delivered to phone	[REDACTED]	2023-01-17 12:51:00.0	1625809243
2023-01-17 12:51:08.0	[REDACTED]	11	Delivered to phone	[REDACTED]	2023-01-17 12:51:00.0	1625809243
2023-01-17 12:51:08.0	[REDACTED]	11	Delivered to phone	[REDACTED]	2023-01-17 12:51:00.0	1625809243
2023-01-17 12:51:08.0	[REDACTED]	11	Delivered to phone	[REDACTED]	2023-01-17 12:51:00.0	1625809243
2023-01-17 12:51:08.0	[REDACTED]	11	Delivered to phone	[REDACTED]	2023-01-17 12:51:00.0	1625809243
2023-01-17 12:51:08.0	[REDACTED]	11	Delivered to phone	[REDACTED]	2023-01-17 12:51:00.0	1625809243
2023-01-17 12:51:08.0	[REDACTED]	11	Delivered to phone	[REDACTED]	2023-01-17 12:51:00.0	1625809243
2023-01-17 12:51:08.0	[REDACTED]	11	Delivered to phone	[REDACTED]	2023-01-17 12:51:00.0	1625809243
2023-01-17 12:51:08.0	[REDACTED]	11	Delivered to phone	[REDACTED]	2023-01-17 12:51:00.0	1625809243
2023-01-17 12:51:08.0	[REDACTED]	11	Delivered to phone	[REDACTED]	2023-01-17 12:51:00.0	1625809243
2023-01-17 12:51:08.0	[REDACTED]	11	Delivered to phone	[REDACTED]	2023-01-17 12:51:00.0	1625809243
2023-01-17 12:51:08.0	[REDACTED]	50	Failed	[REDACTED]	2023-01-19 04:51:00.0	1625809243
2023-01-17 12:51:08.0	[REDACTED]	50	Failed	[REDACTED]	2023-01-18 08:51:00.0	1625809243
2023-01-17 12:51:08.0	[REDACTED]	50	Failed	[REDACTED]	2023-01-18 18:51:00.0	1625809243
2023-01-17 12:51:08.0	[REDACTED]	11	Delivered to phone	[REDACTED]	2023-01-17 12:51:00.0	1625809243
2023-01-17 12:51:08.0	[REDACTED]	11	Delivered to phone	[REDACTED]	2023-01-17 12:51:00.0	1625809243
2023-01-17 12:51:08.0	[REDACTED]	11	Delivered to phone	[REDACTED]	2023-01-17 12:51:00.0	1625809243
2023-01-17 12:51:08.0	[REDACTED]	11	Delivered to phone	[REDACTED]	2023-01-17 12:51:00.0	1625809243
2023-01-17 12:51:08.0	[REDACTED]	11	Delivered to phone	[REDACTED]	2023-01-17 12:51:00.0	1625809243
2023-01-17 12:51:08.0	[REDACTED]	11	Delivered to phone	[REDACTED]	2023-01-17 12:51:00.0	1625809243
2023-01-17 12:51:08.0	[REDACTED]	50	Failed	[REDACTED]	2023-01-18 04:03:00.0	1625809243
2023-01-17 12:51:08.0	[REDACTED]	50	Failed	[REDACTED]	2023-01-17 21:24:00.0	1625809243
2023-01-17 12:51:08.0	[REDACTED]	50	Failed	[REDACTED]	2023-01-17 21:28:00.0	1625809243
2023-01-17 12:51:08.0	[REDACTED]	11	Delivered to phone	[REDACTED]	2023-01-17 12:51:00.0	1625809243
2023-01-17 12:51:08.0	[REDACTED]	11	Delivered to phone	[REDACTED]	2023-01-17 12:51:00.0	1625809243
2023-01-17 12:51:08.0	[REDACTED]	11	Delivered to phone	[REDACTED]	2023-01-17 12:51:00.0	1625809243
2023-01-17 12:51:08.0	[REDACTED]	11	Delivered to phone	[REDACTED]	2023-01-17 12:52:00.0	1625809243
2023-01-17 12:51:08.0	[REDACTED]	11	Delivered to phone	[REDACTED]	2023-01-17 12:51:00.0	1625809243

**APPENDICES**

SCOPING REPORT: Scoping and Environmental Impact Assessment (EIA) Process for the Proposed Development of a Solar Photovoltaic (PV) Facility (Kudu Solar Facility 8) and associated infrastructure, near De Aar, Northern Cape Province

---

created_time	msisdn	status	status_text	origin_address	delivered_time	batch_id
2023-01-17 12:51:08.0	[REDACTED]	11	Delivered to phone	[REDACTED]	2023-01-17 12:51:00.0	1625809243
2023-01-17 12:51:08.0	[REDACTED]	10	Delivered upstream	[REDACTED]		1625809243
2023-01-17 12:51:08.0	[REDACTED]	50	Failed	[REDACTED]	2023-01-18 06:56:00.0	1625809243
2023-01-17 12:51:08.0	[REDACTED]	50	Failed	[REDACTED]	2023-01-18 06:56:00.0	1625809243
2023-01-17 12:51:08.0	[REDACTED]	50	Failed	[REDACTED]	2023-01-17 12:51:00.0	1625809243
2023-01-17 12:51:08.0	[REDACTED]	50	Failed	[REDACTED]	2023-01-17 12:51:00.0	1625809243
2023-01-17 12:51:08.0	[REDACTED]	50	Failed	[REDACTED]	2023-01-17 12:51:00.0	1625809243
2023-01-17 12:51:08.0	[REDACTED]	11	Delivered to phone	[REDACTED]	2023-01-17 12:51:00.0	1625809243
2023-01-17 12:51:08.0	[REDACTED]	11	Delivered to phone	[REDACTED]	2023-01-17 12:51:00.0	1625809243
2023-01-17 12:51:08.0	[REDACTED]	11	Delivered to phone	[REDACTED]	2023-01-17 12:51:00.0	1625809243
2023-01-17 12:51:08.0	[REDACTED]	11	Delivered to phone	[REDACTED]	2023-01-17 12:52:00.0	1625809243
2023-01-17 12:51:08.0	[REDACTED]	11	Delivered to phone	[REDACTED]	2023-01-17 12:51:00.0	1625809243
2023-01-17 12:51:08.0	[REDACTED]	11	Delivered to phone	[REDACTED]	2023-01-17 12:51:00.0	1625809243
2023-01-17 12:51:08.0	[REDACTED]	11	Delivered to phone	[REDACTED]	2023-01-17 12:51:00.0	1625809243
2023-01-17 12:51:08.0	[REDACTED]	11	Delivered to phone	[REDACTED]	2023-01-17 12:51:00.0	1625809243
2023-01-17 12:51:08.0	[REDACTED]	11	Delivered to phone	[REDACTED]	2023-01-17 12:51:00.0	1625809243
2023-01-17 12:51:08.0	[REDACTED]	50	Failed	[REDACTED]	2023-01-17 13:06:00.0	1625809243
2023-01-17 12:51:08.0	[REDACTED]	50	Failed	[REDACTED]	2023-01-17 13:06:00.0	1625809243
2023-01-17 12:51:08.0	[REDACTED]	50	Failed	[REDACTED]	2023-01-17 13:06:00.0	1625809243

## APPENDICES

### SCOPING REPORT: Scoping and Environmental Impact Assessment (EIA) Process for the Proposed Development of a Solar Photovoltaic (PV) Facility (Kudu Solar Facility 8) and associated infrastructure, near De Aar, Northern Cape Province

---

#### 12. Personalised Reminder Email sent to key I&APs, Stakeholders and Organs of State (as determined by the DFFE) on 24 and 25 January 2023

---

##### Personalised Reminder Email Sent to Landowners

---

**From:** Helen Antonopoulos  
**Sent:** Tuesday, 24 January 2023 10:13  
**To:** [REDACTED]  
**Cc:** Helen Antonopoulos  
**Subject:** Kudu Sonfasiliteite Konsepverslae

**Categories:** This message has been archived by Retain on January 31 2023 21:17

Goeie môre [REDACTED]

Baie dankie vir vanoggend se vriendelike gesprek!

Soos genoem, die konsepverslae en opsommings kan soos volg verkry word:

- Google Drive: [https://bit.ly/KUDU\\_SOLAR\\_PV](https://bit.ly/KUDU_SOLAR_PV)
- Projekwebtuiste: <https://www.csir.co.za/environmental-impact-assessment>

Laat weet asseblief as julle enige vrae of kommentaar het oor die verslae – ons waardeer enige insette. Die kommentaarperiode eindig op 30 Januarie.

Groete  
Helen

---

---

**From:** Helen Antonopoulos  
**Sent:** Tuesday, 24 January 2023 11:02  
**To:** [REDACTED]  
**Cc:** EMS  
**Subject:** Kudu Sonfasiliteite Konsepverslae Kommentaarperiode

**Categories:** This message has been archived by Retain on January 31 2023 21:17

Goeie môre

Ek het vroeër vanoggend probeer geskakel i.v.m. die openbare kommentaarperiode vir die Kudu Sonfasiliteite se konsepverslae.

Die WNNR is aangestel as die onafhanklike omgewingskonsultant vir die projekte en ons wil graag vir u herinner dat die kommentaarperiode 30 Januarie 2023 sluit.

Die verslae en opsommings kan soos volg verkry word:

- Google Drive: [https://bit.ly/KUDU\\_SOLAR\\_PV](https://bit.ly/KUDU_SOLAR_PV)
- Projekwebtuiste: <https://www.csir.co.za/environmental-impact-assessment>

Laat weet asseblief as u enige vrae of kommentaar het oor die verslae – ons waardeer alle insette. U is meer as welkom op ons telefonies (060 829 0202) of per e-pos te kontak.

Vriendelike groete  
Helen

## APPENDICES

SCOPING REPORT: Scoping and Environmental Impact Assessment (EIA) Process for the Proposed Development of a Solar Photovoltaic (PV) Facility (Kudu Solar Facility 8) and associated infrastructure, near De Aar, Northern Cape Province

---

### Personalised Reminder Email Sent to the South African Heritage Resource Agency (SAHRA)

---

**From:** EMS <ems@csir.co.za>  
**Sent:** Wednesday, 25 January 2023 08:57  
**To:** Natasha Higgitt  
**Cc:** EMS  
**Subject:** RE: Reminder - Availability of Draft Scoping Reports for Comment - Kudu Solar PV - SAHRA  
**Attachments:** RE: Kudu Solar PV Draft Scoping Reports  
**Categories:** This message has been archived by Retain on February 01 2023 19:00

Dear Natasha

I hope that you are well. All the best for 2023. I hope that you had a good break.

I am kindly following up on the Kudu PV Projects, as per our communications last year (copied here).

Please let me know if SAHRA is able to send us comments on the Draft Scoping Reports by 30 Jan 2023?

Thanks for your inputs throughout this process.

Thank you and kind regards,  
Rohaida Abed

CSIR Environmental Management Services  
E-mail: [ems@csir.co.za](mailto:ems@csir.co.za)  
Postal Address: P.O. Box 59081, Umbilo, Durban, 4075  
Tel: 031 242 2300

---

## APPENDICES

SCOPING REPORT: Scoping and Environmental Impact Assessment (EIA) Process for the Proposed Development of a Solar Photovoltaic (PV) Facility (Kudu Solar Facility 8) and associated infrastructure, near De Aar, Northern Cape Province

---

### Personalised Reminder Email Sent to the Northern Cape Department of Agriculture, Environmental Affairs, Rural Development and Land Reform (NCDAEARDLR)

---

**From:** EMS <ems@csir.co.za>  
**Sent:** Wednesday, 25 January 2023 10:07  
**To:** Samantha De la Fontaine; elsabe.dtec; nuys.denc@gmail.com  
**Cc:** EMS  
**Subject:** RE: Reminder - Availability of Draft Scoping Reports for Comment - Kudu Solar PV - NCDAEARDLR Comment

**Categories:** This message has been archived by Retain on February 01 2023 19:00

Good day Elsabe, Samantha and Natalie

I trust that you are well. The emails below regarding the Draft Scoping Reports for the Kudu Solar Facility 1 to 12 have reference.

Please kindly let us know if the Northern Cape Department of Agriculture, Environmental Affairs, Rural Development and Land Reform has any comments on the projects? If so, are you able to kindly submit these comments by 30 Jan 2023?

In addition, the National Department of Forestry, Fisheries and the Environment (DFFE) is the Competent Authority for the projects, and provided the following comment on the Draft Scoping Reports:

*It has been noted that activities 4, 12, 14, 18 and 23 of LN 3 have been applied for, as the "entire study area or a site fall within an Ecological Support Area (ESA) according to the Northern Cape Critical Biodiversity Area (CBA) Map (2016)". Therefore, the CA request the following to be addressed in the final report: You are advised to obtain a written confirmation from the relevant CA that there is an adopted bioregional plan to determine the applicability of the aforesaid activities.*

The above listed activities have been included based on the study area and sites falling within an ESA as per the 2016 Northern Cape CBA Map, and therefore potentially triggering the following:

- Critical biodiversity areas as identified in systematic biodiversity plans adopted by the competent authority or in bioregional plans
- Within critical biodiversity areas identified in bioregional plans
- Critical biodiversity areas or ecosystem service areas as identified in systematic biodiversity plans adopted by the competent authority or in bioregional plans
- Critical biodiversity areas as identified in systematic biodiversity plans adopted by the competent authority or in bioregional plans
- Critical biodiversity areas as identified in systematic biodiversity plans adopted by the competent authority or in bioregional plans

Please could you kindly confirm via email if the 2016 Northern Cape CBA maps used would trigger the above listed activities, i.e. would serve as CBAs in 1) systematic biodiversity plans adopted by the competent authority or 2) in bioregional plans?

Please kind provide feedback on the above and if your Department has any comments on the Draft Scoping Reports.

We look forward to your feedback and thank you for your inputs thus far.

Kind Regards,  
Rohaida Abed

CSIR Environmental Management Services  
E-mail: [ems@csir.co.za](mailto:ems@csir.co.za)  
Postal Address: P.O. Box 59081, Umbilo, Durban, 4075  
Tel: 031 242 2300



## APPENDICES

SCOPING REPORT: Scoping and Environmental Impact Assessment (EIA) Process for the Proposed Development of a Solar Photovoltaic (PV) Facility (Kudu Solar Facility 8) and associated infrastructure, near De Aar, Northern Cape Province

---

### Personalised Reminder Email Sent to the Air Traffic and Navigation Services (ATNS)

---

**From:** EMS <ems@csir.co.za>  
**Sent:** Wednesday, 25 January 2023 12:32  
**To:** Obstacles@atns.co.za  
**Cc:** EMS  
**Subject:** RE: Reminder - Availability of Draft Scoping Reports for Comment - Kudu Solar PV

**Categories:** This message has been archived by Retain on February 01 2023 19:00

Good day

I hope this email finds you well.

I am kindly following up on the Kudu PV Projects, as per our communications last year (copied here).

Please let me know if ATNS is able to send us comments on the Draft Scoping Reports by 30 Jan 2023?

Thank you in advance.

Kind regards  
Helen Antonopoulos

---

### Personalised Reminder Email Sent to the Civil Aviation Authorities (CAA)

---

**From:** EMS <ems@csir.co.za>  
**Sent:** Wednesday, 25 January 2023 12:37  
**To:** [REDACTED]; [REDACTED]; [REDACTED]  
**Cc:** EMS  
**Subject:** RE: Reminder - Availability of Draft Scoping Reports for Comment - Kudu Solar PV

**Categories:** This message has been archived by Retain on February 01 2023 19:00

Dear All

I hope this email finds you well.

I am kindly following up on the Kudu PV Projects, as per our communications last year (copied here).

Please let me know if the CAA is able to send us comments on the Draft Scoping Reports by 30 Jan 2023?

Thank you in advance.

Kind regards  
Helen Antonopoulos

## APPENDICES

SCOPING REPORT: Scoping and Environmental Impact Assessment (EIA) Process for the Proposed Development of a Solar Photovoltaic (PV) Facility (Kudu Solar Facility 8) and associated infrastructure, near De Aar, Northern Cape Province

---

### Personalised Reminder Email Sent to AgriSA

---

**From:** EMS <ems@csir.co.za>  
**Sent:** Wednesday, 25 January 2023 13:27  
**To:** janse@agrisa.co.za  
**Cc:** EMS  
**Subject:** RE: Reminder - Availability of Draft Scoping Reports for Comment - Kudu Solar PV

**Categories:** This message has been archived by Retain on February 01 2023 19:00

Good day

I hope this email finds you well.

I am kindly following up on the Kudu PV Projects, as per our communications last year (copied here).

Please let me know if AgriSA is able to send us comments on the Draft Scoping Reports by 30 Jan 2023?

Thank you in advance.

Kind regards  
Helen Antonopoulos

---

### Personalised Reminder Email Sent to Agri NC

---

**From:** EMS <ems@csir.co.za>  
**Sent:** Wednesday, 25 January 2023 13:26  
**To:** ontvangs@agrink.co.za; bestuurder@agrink.co.za  
**Cc:** EMS  
**Subject:** RE: Reminder - Availability of Draft Scoping Reports for Comment - Kudu Solar PV

**Categories:** This message has been archived by Retain on February 01 2023 19:00

Good day

I hope this email finds you well.

I am kindly following up on the Kudu PV Projects, as per our communications last year (copied here).

Please let me know if Agri NC is able to send us comments on the Draft Scoping Reports by 30 Jan 2023?

Thank you in advance.

Kind regards  
Helen Antonopoulos

---

## APPENDICES

SCOPING REPORT: Scoping and Environmental Impact Assessment (EIA) Process for the Proposed Development of a Solar Photovoltaic (PV) Facility (Kudu Solar Facility 8) and associated infrastructure, near De Aar, Northern Cape Province

---

### Personalised Reminder Email Sent to the Endangered Wildlife Trust (EWT)

---

**From:** EMS <ems@csir.co.za>  
**Sent:** Wednesday, 25 January 2023 12:41  
**To:** eia@ewt.org.za  
**Cc:** EMS  
**Subject:** RE: Reminder - Availability of Draft Scoping Reports for Comment - Kudu Solar PV

**Categories:** This message has been archived by Retain on February 01 2023 19:00

Good day

I hope this email finds you well.

I am kindly following up on the Kudu PV Projects, as per our communications last year (copied here).

Please let me know if EWT is able to send us comments on the Draft Scoping Reports by 30 Jan 2023?

Thank you in advance.

Kind regards  
Helen Antonopoulos

---

### Personalised Reminder Email Sent to Birdlife SA

---

**From:** EMS <ems@csir.co.za>  
**Sent:** Wednesday, 25 January 2023 12:45  
**To:** info@birdlife.org.za; spothil@gmail.com; advocacy@birdlife.org.za; energy@birdlife.org.za  
**Cc:** EMS  
**Subject:** RE: Reminder - Availability of Draft Scoping Reports for Comment - Kudu Solar PV

**Categories:** This message has been archived by Retain on February 01 2023 19:00

Good day

I hope this email finds you well.

I am kindly following up on the Kudu PV Projects, as per our communications last year (copied here).

Please let me know if Birdlife SA is able to send us comments on the Draft Scoping Reports by 30 Jan 2023?

Thank you in advance.

Kind regards  
Helen Antonopoulos

---

## APPENDICES

SCOPING REPORT: Scoping and Environmental Impact Assessment (EIA) Process for the Proposed Development of a Solar Photovoltaic (PV) Facility (Kudu Solar Facility 8) and associated infrastructure, near De Aar, Northern Cape Province

---

### Personalised Reminder Email Sent to Earthlife Africa

---

**From:** EMS <ems@csir.co.za>  
**Sent:** Wednesday, 25 January 2023 12:48  
**To:** seccp@earthlife.org.za; mabule@ghouse.org.za  
**Cc:** EMS  
**Subject:** RE: Reminder - Availability of Draft Scoping Reports for Comment - Kudu Solar PV

**Categories:** This message has been archived by Retain on February 01 2023 19:00

Good day

I hope this email finds you well.

I am kindly following up on the Kudu PV Projects, as per our communications last year (copied here).

Please let me know if Earthlife Africa is able to send us comments on the Draft Scoping Reports by 30 Jan 2023?

Thank you in advance.

Kind regards  
Helen Antonopoulos

---

### Personalised Reminder Email Sent to the Wildlife and Environment Society of South Africa Northern Cape

---

**From:** EMS <ems@csir.co.za>  
**Sent:** Wednesday, 25 January 2023 12:51  
**To:** wessanc@yahoo.com  
**Cc:** EMS  
**Subject:** RE: Reminder - Availability of Draft Scoping Reports for Comment - Kudu Solar PV

**Categories:** This message has been archived by Retain on February 01 2023 19:00

Dear Suzanne

I hope this email finds you well.

I am kindly following up on the Kudu PV Projects, as per our communications last year (copied here).

Please let me know if WESSA NC is able to send us comments on the Draft Scoping Reports by 30 Jan 2023?

Thank you in advance.

Kind regards  
Helen Antonopoulos

---

## APPENDICES

SCOPING REPORT: Scoping and Environmental Impact Assessment (EIA) Process for the Proposed Development of a Solar Photovoltaic (PV) Facility (Kudu Solar Facility 8) and associated infrastructure, near De Aar, Northern Cape Province

---

### Personalised Reminder Email Sent to the Department of Human Settlement, Water and Sanitation

---

**From:** EMS <ems@csir.co.za>  
**Sent:** Wednesday, 25 January 2023 13:09  
**To:** kgapholam@dws.gov.za; MeiM@dwa.gov.za; SchwartzC@dws.gov.za; ranwedzim@dwa.gov.za; CloeteS@dws.gov.za; JansenMe@dws.gov.za  
**Cc:** EMS  
**Subject:** RE: Reminder - Availability of Draft Scoping Reports for Comment - Kudu Solar PV  
**Categories:** This message has been archived by Retain on February 01 2023 19:00

Dear All

I hope this email finds you well.

I am kindly following up on the Kudu PV Projects, as per our communications last year (copied here).

Please let me know if the Department of Human Settlement, Water and Sanitation is able to send us comments on the Draft Scoping Reports by 30 Jan 2023?

Thank you in advance.

Kind regards  
Helen Antonopoulos

---

### Personalised Reminder Email Sent to the South African National Defence Force

---

**From:** EMS <ems@csir.co.za>  
**Sent:** Wednesday, 25 January 2023 13:22  
**To:** [REDACTED]; [REDACTED]; [REDACTED]  
**Cc:** EMS  
**Subject:** RE: Availability of Draft Scoping Reports for Comment - Kudu Solar PV  
**Categories:** This message has been archived by Retain on February 01, 2023 19:00

Dear All

I hope this email finds you well.

I am kindly following up on the Kudu PV Projects, as per our communications last year (copied here).

Please let me know if the SANDF is able to send us comments on the Draft Scoping Reports by 30 Jan 2023?

Thank you in advance.

Kind regards  
Helen Antonopoulos

---

## APPENDICES

SCOPING REPORT: Scoping and Environmental Impact Assessment (EIA) Process for the Proposed Development of a Solar Photovoltaic (PV) Facility (Kudu Solar Facility 8) and associated infrastructure, near De Aar, Northern Cape Province

---

### Personalised Reminder Email Sent to the Pixley Ka Seme District Municipality (PKSDM)

---

**From:** EMS <ems@csir.co.za>  
**Sent:** Wednesday, 25 January 2023 14:23  
**To:** dmotaung@pk SDM.gov.za; pixley@telkomsa.net; mm@pk SDM.gov.za; emoffice@pk SDM.gov.za; snkondeshe@pk SDM.gov.za; asibeko@pk SDM.gov.za; otshékela@pk SDM.gov.za; fqumba@pk SDM.gov.za; idh@pk SDM.gov.za  
**Cc:** EMS  
**Subject:** RE: Reminder - Availability of Draft Scoping Reports for Comment - Kudu Solar PV  
**Categories:** This message has been archived by Retain on February 01 2023 19:00

Dear All

I hope this email finds you well.

I am kindly following up on the Kudu PV Projects, as per our communications last year (copied here).

Please let me know if the Pixley ka Seme District Municipality is able to send us comments on the Draft Scoping Reports by 30 Jan 2023?

Thank you in advance.

Kind regards  
Helen Antonopoulos

---

### Personalised Reminder Email Sent to the Renosterberg Local Municipality (RLM)

---

**From:** EMS <ems@csir.co.za>  
**Sent:** Wednesday, 25 January 2023 13:48  
**To:** renosterbergmun@xsinet.co.za; [REDACTED]; xolisam@renosterberg.gov.za; themba@crfund.co.za; [REDACTED]; [REDACTED]  
**Cc:** EMS  
**Subject:** RE: Reminder - Availability of Draft Scoping Reports for Comment - Kudu Solar PV  
**Categories:** This message has been archived by Retain on February 01, 2023 19:00

Dear All

I hope this email finds you well.

I am kindly following up on the Kudu PV Projects, as per our communications last year (copied here).

Please let me know if the Renosterberg Local Municipality is able to send us comments on the Draft Scoping Reports by 30 Jan 2023? We would also greatly appreciate it if you could please provide us with the contact information (name, email address, and cell no.) of the ward councilors, as well as the details of the Rate Payers Association (should such an association be in operation).

Thank you in advance.

Kind regards  
Helen Antonopoulos

## APPENDICES

SCOPING REPORT: Scoping and Environmental Impact Assessment (EIA) Process for the Proposed Development of a Solar Photovoltaic (PV) Facility (Kudu Solar Facility 8) and associated infrastructure, near De Aar, Northern Cape Province

---

### Personalised Reminder Email Sent to a Renosterberg Local Municipality Councillor

---

**From:** EMS  
**Sent:** Wednesday, 25 January 2023 13:42  
**To:** [REDACTED]  
**Cc:** EMS  
**Subject:** RE: Reminder - Availability of Draft Scoping Reports for Comment - Kudu Solar PV

**Categories:** This message has been archived by Retain on February 01, 2023 19:00

Dear Cllr [REDACTED]

I hope this email finds you well.

I am kindly following up on the Kudu PV Projects, as per our communications last year (copied here).

Please let me know if you are able to send us comments on the Draft Scoping Reports by 30 Jan 2023? We would also greatly appreciate it if you could please send us the contact information of other ward councillors, as well as the details of the Rate Payers Association (should such an association be in operation).

Thank you in advance.

Kind regards  
Helen Antonopoulos

## APPENDICES

### SCOPING REPORT: Scoping and Environmental Impact Assessment (EIA) Process for the Proposed Development of a Solar Photovoltaic (PV) Facility (Kudu Solar Facility 8) and associated infrastructure, near De Aar, Northern Cape Province

#### 13. Proof of Delivery of Personalised Reminder Email sent to key I&APs, Stakeholders and Organs of State (as determined by the DFFE) on 24 and 25 January 2023

EMS - Delivery Reports						By Date ▾ ↑
From	Subject	Received ▾	Size	Categories	Mention	
postmaster@outlo...	<b>Delivered: RE: Reminder - Availability of Draft Scoping Reports for Comment - Kudu Solar PV</b> You don't often get email from postmaster@outlook.com. Learn why this is important <https://aka.ms/LearnAboutSenderIdentification>	Wed 25 Jan 2023 23:12	137 KB	This message has bee...		
	<b>Mail Delivery System Relayed: Reminder - Availability of Draft Scoping Reports for Comment - Kudu Solar PV</b> [You don't often get email from mailer-daemon@pta-smg4.csir.co.za. Learn why this is important at https://aka.ms/LearnAboutSenderIdentification ] This is the mail system at host pta-smg4.csir.co.za. Your message was successfully	Wed 25 Jan 2023 14:24	83 KB	This message has bee...		
postmaster@outlo...	<b>Delivered: RE: Reminder - Availability of Draft Scoping Reports for Comment - Kudu Solar PV</b> You don't often get email from postmaster@outlook.com. Learn why this is important <https://aka.ms/LearnAboutSenderIdentification>	Wed 25 Jan 2023 14:23	141 KB	This message has bee...		
	<b>Mail Delivery System Relayed: Reminder - Availability of Draft Scoping Reports for Comment - Kudu Solar PV</b> [You don't often get email from mailer-daemon@pta-smg4.csir.co.za. Learn why this is important at https://aka.ms/LearnAboutSenderIdentification ] This is the mail system at host pta-smg4.csir.co.za. Your message was successfully	Wed 25 Jan 2023 14:23	83 KB	This message has bee...		
	<b>Mail Delivery System Undeliverable: Reminder - Availability of Draft Scoping Reports for Comment - Kudu Solar PV</b> [You don't often get email from mailer-daemon@pta-smg4.csir.co.za. Learn why this is important at https://aka.ms/LearnAboutSenderIdentification ] This is the mail system at host pta-smg4.csir.co.za. I'm sorry to have to inform you	Wed 25 Jan 2023 14:23	36 KB	This message has bee...		
	<b>Mail Delivery System Relayed: Reminder - Availability of Draft Scoping Reports for Comment - Kudu Solar PV - NCDAEAR...</b> This is the mail system at host pta-smg1.csir.co.za. Your message was successfully delivered to the destination(s) listed below. If the message was delivered to mailbox you will receive no further notifications. Otherwise you may still	Wed 25 Jan 2023 14:06	66 KB	This message has bee...		
Microsoft Outlook	<b>Delivered: RE: Reminder - Availability of Draft Scoping Reports for Comment - Kudu Solar PV - NC...</b> Your message has been delivered to the following recipients:	Wed 25 Jan 2023 14:06	101 KB	This message has bee...		
	<b>Mail Delivery System Relayed: Reminder - Availability of Draft Scoping Reports for Comment - Kudu Solar PV</b> [You don't often get email from mailer-daemon@pta-smg4.csir.co.za. Learn why this is important at https://aka.ms/LearnAboutSenderIdentification ] This is the mail system at host pta-smg4.csir.co.za. Your message was successfully	Wed 25 Jan 2023 13:48	74 KB	This message has bee...		
	<b>Mail Delivery System Undeliverable: Reminder - Availability of Draft Scoping Reports for Comment - Kudu Solar PV</b> [You don't often get email from mailer-daemon@pta-smg4.csir.co.za. Learn why this is important at https://aka.ms/LearnAboutSenderIdentification ] This is the mail system at host pta-smg4.csir.co.za. I'm sorry to have to inform you	Wed 25 Jan 2023 13:48	30 KB	This message has bee...		
Microsoft Outlook	<b>Delivered: RE: Reminder - Availability of Draft Scoping Reports for Comment - Kudu Solar PV</b> Your message has been delivered to the following recipients:	Wed 25 Jan 2023 13:48	89 KB	This message has bee...		
	<b>Mail Delivery System Relayed: Reminder - Availability of Draft Scoping Reports for Comment - Kudu Solar PV</b> This is the mail system at host pta-smg1.csir.co.za. Your message was successfully delivered to the destination(s) listed below. If the message was delivered to mailbox you will receive no further notifications. Otherwise you may still	Wed 25 Jan 2023 13:45	65 KB	This message has bee...		
Microsoft Outlook	<b>Delivered: RE: Reminder - Availability of Draft Scoping Reports for Comment - Kudu Solar PV</b> Your message has been delivered to the following recipients:	Wed 25 Jan 2023 13:42	84 KB	This message has bee...		
postmaster@agrisa...	<b>Delivered: RE: Reminder - Availability of Draft Scoping Reports for Comment - Kudu Solar PV</b> Your message has been delivered to the following recipients:	Wed 25 Jan 2023 13:27	129 KB	This message has bee...		



## APPENDICES

### SCOPING REPORT: Scoping and Environmental Impact Assessment (EIA) Process for the Proposed Development of a Solar Photovoltaic (PV) Facility (Kudu Solar Facility 8) and associated infrastructure, near De Aar, Northern Cape Province

EMS - Delivery Reports							By Date <span style="font-size: 0.8em;">v</span> <span style="font-size: 0.8em;">↑</span>
	From	Subject	Received <span style="font-size: 0.8em;">v</span>	Size	Categories	Mention <span style="font-size: 0.8em;">v</span>	
	Microsoft Outlook	Delivered: RE: Reminder - Availability of Draft Scoping Reports for Comment - Kudu Solar PV Your message has been delivered to the following recipients:	Wed 25 Jan 2023 13:27	83 KB	This message has bee...		
	postmaster@agrink...	Delivered: RE: Reminder - Availability of Draft Scoping Reports for Comment - Kudu Solar PV You don't often get email from postmaster@agrink.co.za. Learn why this is important < <a href="https://aka.ms/LearnAboutSenderIdentification">https://aka.ms/LearnAboutSenderIdentification</a> >	Wed 25 Jan 2023 13:26	133 KB	This message has bee...		
	postmaster@agrink...	Delivered: RE: Reminder - Availability of Draft Scoping Reports for Comment - Kudu Solar PV You don't often get email from postmaster@agrink.co.za. Learn why this is important < <a href="https://aka.ms/LearnAboutSenderIdentification">https://aka.ms/LearnAboutSenderIdentification</a> >	Wed 25 Jan 2023 13:26	133 KB	This message has bee...		
	Microsoft Outlook	Delivered: RE: Reminder - Availability of Draft Scoping Reports for Comment - Kudu Solar PV Your message has been delivered to the following recipients:	Wed 25 Jan 2023 13:26	85 KB	This message has bee...		
	postmaster@dws.g...	Delivered: RE: Reminder - Availability of Draft Scoping Reports for Comment - Kudu Solar PV You don't often get email from postmaster@dws.gov.za. Learn why this is important < <a href="https://aka.ms/LearnAboutSenderIdentification">https://aka.ms/LearnAboutSenderIdentification</a> >	Wed 25 Jan 2023 13:11	138 KB	This message has bee...		
	postmaster@dws.g...	Delivered: RE: Reminder - Availability of Draft Scoping Reports for Comment - Kudu Solar PV You don't often get email from postmaster@dws.gov.za. Learn why this is important < <a href="https://aka.ms/LearnAboutSenderIdentification">https://aka.ms/LearnAboutSenderIdentification</a> >	Wed 25 Jan 2023 13:11	138 KB	This message has bee...		
	postmaster@dws.g...	Delivered: RE: Reminder - Availability of Draft Scoping Reports for Comment - Kudu Solar PV You don't often get email from postmaster@dws.gov.za. Learn why this is important < <a href="https://aka.ms/LearnAboutSenderIdentification">https://aka.ms/LearnAboutSenderIdentification</a> >	Wed 25 Jan 2023 13:11	139 KB	This message has bee...		
	postmaster@dws.g...	Delivered: RE: Reminder - Availability of Draft Scoping Reports for Comment - Kudu Solar PV You don't often get email from postmaster@dws.gov.za. Learn why this is important < <a href="https://aka.ms/LearnAboutSenderIdentification">https://aka.ms/LearnAboutSenderIdentification</a> >	Wed 25 Jan 2023 13:11	137 KB	This message has bee...		
	Microsoft Outlook	Delivered: RE: Reminder - Availability of Draft Scoping Reports for Comment - Kudu Solar PV Your message has been delivered to the following recipients:	Wed 25 Jan 2023 13:09	88 KB	This message has bee...		
	Mail Delivery System	Undeliverable: Reminder - Availability of Draft Scoping Reports for Comment - Kudu Solar PV [You don't often get email from mailer-daemon@pta-smg3.csir.co.za. Learn why this is important at <a href="https://aka.ms/LearnAboutSenderIdentification">https://aka.ms/LearnAboutSenderIdentification</a> ] This is the mail system at host pta-smg3.csir.co.za. I'm sorry to have to inform you	Wed 25 Jan 2023 12:52	30 KB	This message has bee...		
	Microsoft Outlook	Delivered: RE: Reminder - Availability of Draft Scoping Reports for Comment - Kudu Solar PV Your message has been delivered to the following recipients:	Wed 25 Jan 2023 12:51	83 KB	This message has bee...		
	Mail Delivery System	Relayed: Reminder - Availability of Draft Scoping Reports for Comment - Kudu Solar PV [You don't often get email from mailer-daemon@pta-smg2.csir.co.za. Learn why this is important at <a href="https://aka.ms/LearnAboutSenderIdentification">https://aka.ms/LearnAboutSenderIdentification</a> ] This is the mail system at host pta-smg2.csir.co.za. Your message was successfully	Wed 25 Jan 2023 12:49	65 KB	This message has bee...		
	Mail Delivery System	Relayed: Reminder - Availability of Draft Scoping Reports for Comment - Kudu Solar PV [You don't often get email from mailer-daemon@hostserv.co.za. Learn why this is important at <a href="https://aka.ms/LearnAboutSenderIdentification">https://aka.ms/LearnAboutSenderIdentification</a> ]	Wed 25 Jan 2023 12:49	76 KB	This message has bee...		

## APPENDICES

### SCOPING REPORT: Scoping and Environmental Impact Assessment (EIA) Process for the Proposed Development of a Solar Photovoltaic (PV) Facility (Kudu Solar Facility 8) and associated infrastructure, near De Aar, Northern Cape Province

EMS - Delivery Reports							By Date <span style="font-size: small;">v</span> <span style="font-size: small;">↑</span>			
					From	Subject	Received	Size	Categories	Mention
					Microsoft Outlook	<b>Delivered: RE: Reminder - Availability of Draft Scoping Reports for Comment - Kudu Solar PV</b> Your message has been delivered to the following recipients:	Wed 25 Jan 2023 12:48	84 KB		This message has bee...
					postmaster@birdlif...	<b>Delivered: RE: Reminder - Availability of Draft Scoping Reports for Comment - Kudu Solar PV</b> You don't often get email from postmaster@birdlife.org.za. Learn why this is important <https://aka.ms/LearnAboutSenderIdentification>	Wed 25 Jan 2023 12:46	134 KB		This message has bee...
					postmaster@birdlif...	<b>Delivered: RE: Reminder - Availability of Draft Scoping Reports for Comment - Kudu Solar PV</b> You don't often get email from postmaster@birdlife.org.za. Learn why this is important <https://aka.ms/LearnAboutSenderIdentification>	Wed 25 Jan 2023 12:46	134 KB		This message has bee...
					postmaster@birdlif...	<b>Delivered: RE: Reminder - Availability of Draft Scoping Reports for Comment - Kudu Solar PV</b> You don't often get email from postmaster@birdlife.org.za. Learn why this is important <https://aka.ms/LearnAboutSenderIdentification>	Wed 25 Jan 2023 12:46	134 KB		This message has bee...
					Mail Delivery System	<b>Relayed: Reminder - Availability of Draft Scoping Reports for Comment - Kudu Solar PV</b> [You don't often get email from mailer-daemon@pta-smg4.csir.co.za. Learn why this is important at https://aka.ms/LearnAboutSenderIdentification ] This is the mail system at host pta-smg4.csir.co.za. Your message was successfully	Wed 25 Jan 2023 12:46	67 KB		This message has bee...
					Microsoft Outlook	<b>Delivered: RE: Reminder - Availability of Draft Scoping Reports for Comment - Kudu Solar PV</b> Your message has been delivered to the following recipients:	Wed 25 Jan 2023 12:45	86 KB		This message has bee...
					Mail Delivery System	<b>Relayed: Reminder - Availability of Draft Scoping Reports for Comment - Kudu Solar PV</b> This is the mail system at host pta-smg1.csir.co.za. Your message was successfully delivered to the destination(s) listed below. If the message was delivered to mailbox you will receive no further notifications. Otherwise you may still	Wed 25 Jan 2023 12:41	64 KB		This message has bee...
					Microsoft Outlook	<b>Delivered: RE: Reminder - Availability of Draft Scoping Reports for Comment - Kudu Solar PV</b> Your message has been delivered to the following recipients:	Wed 25 Jan 2023 12:41	83 KB		This message has bee...
					Mail Delivery System	<b>Relayed: Reminder - Availability of Draft Scoping Reports for Comment - Kudu Solar PV</b> This is the mail system at host pta-smg1.csir.co.za. Your message was successfully delivered to the destination(s) listed below. If the message was delivered to mailbox you will receive no further notifications. Otherwise you may still	Wed 25 Jan 2023 12:37	71 KB		This message has bee...
					Microsoft Outlook	<b>Delivered: RE: Reminder - Availability of Draft Scoping Reports for Comment - Kudu Solar PV</b> Your message has been delivered to the following recipients:	Wed 25 Jan 2023 12:37	86 KB		This message has bee...
					Microsoft Outlook	<b>Delivered: RE: Reminder - Availability of Draft Scoping Reports for Comment - Kudu Solar PV</b> Your message has been delivered to the following recipients:	Wed 25 Jan 2023 12:32	83 KB		This message has bee...
					Mail Delivery System	<b>Relayed: [CAUTION:EXTERNAL EMAIL] - Reminder - Availability of Draft Scoping Reports for Comm...</b> [You don't often get email from mailer-daemon@pta-smg3.csir.co.za. Learn why this is important at https://aka.ms/LearnAboutSenderIdentification ] This is the mail system at host pta-smg3.csir.co.za. Your message was successfully	Wed 25 Jan 2023 11:29	72 KB		This message has bee...
					Microsoft Outlook	<b>Delivered: RE: [CAUTION:EXTERNAL EMAIL] - Reminder - Availability of Draft Scoping Reports for C...</b> Your message has been delivered to the following recipients:	Wed 25 Jan 2023 11:29	271 KB		This message has bee...
					Mail Delivery System	<b>Relayed: Reminder - Availability of Draft Scoping Reports for Comment - Kudu Solar PV - NCDAEAR...</b> [You don't often get email from mailer-daemon@pta-smg2.csir.co.za. Learn why this is important at https://aka.ms/LearnAboutSenderIdentification ] This is the mail system at host pta-smg2.csir.co.za. Your message was successfully	Wed 25 Jan 2023 10:31	77 KB		This message has bee...
					Mail Delivery System	<b>Relayed: Reminder - Availability of Draft Scoping Reports for Comment - Kudu Solar PV - NCDAEAR...</b> [You don't often get email from mailer-daemon@pta-smg2.csir.co.za. Learn why this is important at https://aka.ms/LearnAboutSenderIdentification ] This is the mail system at host pta-smg2.csir.co.za. Your message was successfully	Wed 25 Jan 2023 10:31	76 KB		This message has bee...
					Microsoft Outlook	<b>Delivered: RE: Reminder - Availability of Draft Scoping Reports for Comment - Kudu Solar PV - NC...</b> Your message has been delivered to the following recipients:	Wed 25 Jan 2023 10:24	95 KB		This message has bee...

## APPENDICES

SCOPING REPORT: Scoping and Environmental Impact Assessment (EIA) Process for the Proposed Development of a Solar Photovoltaic (PV) Facility (Kudu Solar Facility 8) and associated infrastructure, near De Aar, Northern Cape Province

---

### 14. Proof of SMS Communication Sent to a Renosterberg Local Municipality Councillor



## APPENDICES

SCOPING REPORT: Scoping and Environmental Impact Assessment (EIA) Process for the Proposed Development of a Solar Photovoltaic (PV) Facility (Kudu Solar Facility 8) and associated infrastructure, near De Aar, Northern Cape Province

---

### 15. Proof of Communication Attempts with a Stakeholder Regarding the Visual Impacts of the Kudu Solar Facilities on their Farm Portion and Farmstead

---

#### Proof of Email Communication Sent on 1 February 2023

---

**From:** Helen Antonopoulos  
**Sent:** Wednesday, 01 February 2023 12:37  
**To:** [REDACTED]  
**Cc:** EMS  
**Subject:** Bevestiging van plaasgedeelte i.v.m. die voorgestelde Kudu Sonfasiliteite naby Philipstown en Petrusville

Goeie middag [REDACTED]

Ek het vroeër vandag probeer skakel i.v.m. die voorgestelde Kudu sonplase naby Philipstown en Petrusville.

Die visuele spesialiste het bevestig dat hulle terugvoer gaan lewer op u kommentaar. Ons wil dus graag bevestig of die volgende inligting rakende u grond korrek is op ons databasis, sodat ons die visuele spesialiste kan inlig waar u grond geleë is in verhouding tot die voorgestelde projekte:

- Gedeelte 0 (RES) van Plaas Farm 197 (ook bekend as [REDACTED])
- SG kode: [REDACTED]

Ons wil ook graag bevestig of daar 'n plaasopstal op Vanwyngaardspan is?

U is meer as welkom om my te kontak as u enige vrae het. Sien asseblief kontakbesonderhede hieronder.

Baie dankie  
Helen Antonopoulos

(Sel: 060 829 0202; E-pos [hantonopoulos@csir.co.za](mailto:hantonopoulos@csir.co.za))  
Get [Outlook for Android](#)

## APPENDICES

### SCOPING REPORT: Scoping and Environmental Impact Assessment (EIA) Process for the Proposed Development of a Solar Photovoltaic (PV) Facility (Kudu Solar Facility 8) and associated infrastructure, near De Aar, Northern Cape Province

---

---

**From:** EMS <ems@csir.co.za>  
**Sent:** Wednesday, 01 February 2023 12:38  
**To:** [REDACTED]  
**Cc:** EMS  
**Subject:** RE: Comment on the Kudu Solar Facilities

Good day [REDACTED]

Thank you for your comments on the Kudu Solar Facilities, it is appreciated.

We will add your comments to the Comments and Responses Report in the Final Scoping Report, and provide responses therein.

Please kindly send us a map or location file of the [REDACTED] as well as the homestead, if possible? Thank you and

kind regards,  
Rohaida Abed

CSIR Environmental Management Services  
E-mail: [ems@csir.co.za](mailto:ems@csir.co.za)  
Postal Address: P.O. Box 59081, Umbilo, Durban, 4075  
Tel: 031 242 2300

## APPENDICES

### SCOPING REPORT: Scoping and Environmental Impact Assessment (EIA) Process for the Proposed Development of a Solar Photovoltaic (PV) Facility (Kudu Solar Facility 8) and associated infrastructure, near De Aar, Northern Cape Province

---

#### Proof of Cellular Communication Sent on 2 February 2023



## APPENDICES

### SCOPING REPORT: Scoping and Environmental Impact Assessment (EIA) Process for the Proposed Development of a Solar Photovoltaic (PV) Facility (Kudu Solar Facility 8) and associated infrastructure, near De Aar, Northern Cape Province

---

#### Proof of Telephonic Communication on 3 February 2023

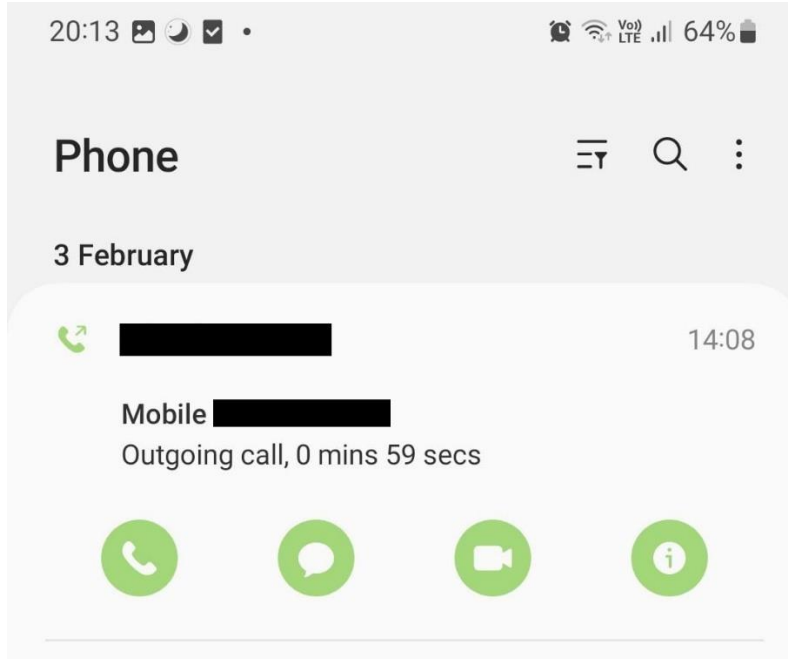

#### Proof of Cellular Communication Sent on 4 February 2023



## APPENDICES

### SCOPING REPORT: Scoping and Environmental Impact Assessment (EIA) Process for the Proposed Development of a Solar Photovoltaic (PV) Facility (Kudu Solar Facility 8) and associated infrastructure, near De Aar, Northern Cape Province

#### 16. Read Receipts of All Email Communication to Stakeholders During the DSR Release Phase

EMS - Read Receipts						By Date <span style="font-size: small;">▼</span> <span style="font-size: small;">↑</span>			
				From	Subject	Received <span style="font-size: small;">▼</span>	Size	Categories	Mention <span style="font-size: small;">▼</span>
<span style="font-size: small;">▼</span> Two Weeks Ago									
				<b>Sharon Steyn</b> Your message	<b>Not read: Reminder - Availability of Draft Scoping Reports for Comment - Kudu Solar PV</b>	Fri 27 Jan 2023 20:13	56 KB		This message has bee...
				<b>Jansen Melinda(UP...</b> Your message	<b>Read: Reminder - Availability of Draft Scoping Reports for Comment - Kudu Solar PV</b>	Fri 27 Jan 2023 09:53	50 KB		This message has bee...
				<b>Jansen Melinda(UP...</b> Your message	<b>Read: Reminder - Availability of Draft Scoping Reports for Comment - Kudu Solar PV</b>	Fri 27 Jan 2023 09:48	50 KB		This message has bee...
				<b>dmotaung@pksdm...</b> [The e-mail server of the sender could not be verified (SPF Record)] <end>	<b>Read: Reminder - Availability of Draft Scoping Reports for Comment - Kudu Solar PV</b>	Fri 27 Jan 2023 09:02	41 KB		This message has bee...
				<b>Sam Ralston</b> [The e-mail server of the sender failed SPF checks and maybe malicious (SPF Record)] Your message	<b>Read: RE: Reminder - Availability of Draft Scoping Reports for Comment - Kudu Solar PV</b>	Thu 26 Jan 2023 15:12	48 KB		This message has bee...
				<b>idh@pksdm.gov.za</b> [The e-mail server of the sender could not be verified (SPF Record)] <end>	<b>Read: Reminder - Availability of Draft Scoping Reports for Comment - Kudu Solar PV</b>	Thu 26 Jan 2023 10:04	41 KB		This message has bee...
				<b>asibeko@pksdm.g...</b> [You don't often get email from asibeko@pksdm.gov.za. Learn why this is important at <a href="https://aka.ms/LearnAboutSenderIdentification">https://aka.ms/LearnAboutSenderIdentification</a> ]	<b>Read: Reminder - Availability of Draft Scoping Reports for Comment - Kudu Solar PV</b>	Thu 26 Jan 2023 08:38	42 KB		This message has bee...
				<b>otshekela@pksdm....</b> [You don't often get email from otshekela@pksdm.gov.za. Learn why this is important at <a href="https://aka.ms/LearnAboutSenderIdentification">https://aka.ms/LearnAboutSenderIdentification</a> ]	<b>Read: Reminder - Availability of Draft Scoping Reports for Comment - Kudu Solar PV</b>	Thu 26 Jan 2023 08:17	47 KB		This message has bee...
				<b>emoffice@pksdm.g...</b> [The e-mail server of the sender could not be verified (SPF Record)] <end>	<b>Read: Reminder - Availability of Draft Scoping Reports for Comment - Kudu Solar PV</b>	Thu 26 Jan 2023 07:54	42 KB		This message has bee...
				<b>Sonwabile Nkonde...</b>	<b>Read: Reminder - Availability of Draft Scoping Reports for Comment - Kudu Solar PV</b>	Thu 26 Jan 2023 07:32	36 KB		This message has bee...
				<b>Earthlife Africa JHB</b> [The e-mail server of the sender could not be verified (SPF Record)] Your message	<b>Read: Reminder - Availability of Draft Scoping Reports for Comment - Kudu Solar PV</b>	Wed 25 Jan 2023 14:19	51 KB		This message has bee...
				<b>Bestuurder</b> Your message	<b>Read: Reminder - Availability of Draft Scoping Reports for Comment - Kudu Solar PV</b>	Wed 25 Jan 2023 13:29	49 KB		This message has bee...
				<b>Cloete Shaun</b> You don't often get email from cloetes@dws.gov.za. Learn why this is important < <a href="https://aka.ms/LearnAboutSenderIdentification">https://aka.ms/LearnAboutSenderIdentification</a> > Your message	<b>Read: Reminder - Availability of Draft Scoping Reports for Comment - Kudu Solar PV</b>	Wed 25 Jan 2023 13:14	51 KB		This message has bee...



## APPENDICES

### SCOPING REPORT: Scoping and Environmental Impact Assessment (EIA) Process for the Proposed Development of a Solar Photovoltaic (PV) Facility (Kudu Solar Facility 8) and associated infrastructure, near De Aar, Northern Cape Province

EMS - Read Receipts								By Date <span style="font-size: small;">v</span> <span style="font-size: small;">↑</span>	
				From	Subject	Received <span style="font-size: small;">v</span>	Size	Categories	Mention <span style="font-size: small;">v</span>
				<b>John Geeringh</b> Your message	<b>Read: [CAUTION:EXTERNAL EMAIL] - Reminder - Availability of Draft Scoping Reports for Comment...</b>	Wed 25 Jan 2023 13:12	52 KB		This message has bee...
				<b>Mmoni Suza</b> [The e-mail server of the sender failed SPF checks and maybe malicious (SPF Record)] Your message	<b>Not read: Availability of Draft Scoping Reports for Comment - Kudu Solar PV</b>	Mon 23 Jan 2023 08:28	39 KB		This message has bee...
				<b>Mmoni Suza</b> Your message	<b>Not read: Reminder - Availability of Draft Scoping Reports for Comment - Kudu Solar PV</b>	Mon 23 Jan 2023 08:28	45 KB		This message has bee...
<b>Three Weeks Ago</b>									
				<b>Nokukhanya Khum...</b> [The e-mail server of the sender failed SPF checks and maybe malicious (SPF Record)] Nokukhanya Khumalo	<b>Read: Reminder - Availability of Draft Scoping Reports for Comment - Kudu Solar PV</b>	Fri 20 Jan 2023 16:28	71 KB		This message has bee...
				<b>Mahlatse Shubane</b> Your message	<b>Not read: Reminder - Availability of Draft Scoping Reports for Comment - Kudu Solar PV</b>	Thu 19 Jan 2023 09:56	47 KB		This message has bee...
				<b>Thivhulawi Nethon...</b> Your message	<b>Read: Reminder - Availability of Draft Scoping Reports for Comment - Kudu Solar PV</b>	Wed 18 Jan 2023 12:07	42 KB		This message has bee...
				<b>Karl Naude</b> Your message	<b>Read: Reminder - Availability of Draft Scoping Reports for Comment - Kudu Solar PV</b>	Wed 18 Jan 2023 11:58	41 KB		This message has bee...
				<b>Mashudu Mudau</b> Your message	<b>Read: Reminder - Availability of Draft Scoping Reports for Comment - Kudu Solar PV</b>	Wed 18 Jan 2023 10:57	41 KB		This message has bee...
				<b>Sonwabile Nkonde...</b> Your message	<b>Read: Reminder - Availability of Draft Scoping Reports for Comment - Kudu Solar PV</b>	Wed 18 Jan 2023 10:48	39 KB		This message has bee...
				<b>dmotaung@pkstdm...</b> You don't often get email from dmotaung@pkstdm.gov.za. Learn why this is important < <a href="https://aka.ms/LearnAboutSenderIdentification">https://aka.ms/LearnAboutSenderIdentification</a> >	<b>Read: Reminder - Availability of Draft Scoping Reports for Comment - Kudu Solar PV</b>	Wed 18 Jan 2023 09:40	41 KB		This message has bee...
				<b>Sydney Nkosi</b> You don't often get email from shnkosi@dffe.gov.za. Learn why this is important < <a href="https://aka.ms/LearnAboutSenderIdentification">https://aka.ms/LearnAboutSenderIdentification</a> > Your message	<b>Read: Reminder - Availability of Draft Scoping Reports for Comment - Kudu Solar PV</b>	Wed 18 Jan 2023 09:17	43 KB		This message has bee...
				<b>[REDACTED]</b> You don't often get email from [REDACTED]. Learn why this is important < <a href="https://aka.ms/LearnAboutSenderIdentification">https://aka.ms/LearnAboutSenderIdentification</a> > Your message	<b>Read: Reminder - Availability of Draft Scoping Reports for Comment - Kudu Solar PV</b>	Tue 17 Jan 2023 16:03	46 KB		This message has bee...
				<b>[REDACTED]</b> [The e-mail server of the sender could not be verified (SPF Record)] Your message	<b>Read: Reminder - Availability of Draft Scoping Reports for Comment - Kudu Solar PV</b>	Tue 17 Jan 2023 15:45	40 KB		This message has bee...

## APPENDICES

### SCOPING REPORT: Scoping and Environmental Impact Assessment (EIA) Process for the Proposed Development of a Solar Photovoltaic (PV) Facility (Kudu Solar Facility 8) and associated infrastructure, near De Aar, Northern Cape Province

EMS - Read Receipts By Date ▾ ↑

From	Subject	Received	Size	Categories	Mention
☑ [Redacted]	<b>Read: Reminder - Availability of Draft Scoping Reports for Comment - Kudu Solar PV</b> <small>[The e-mail server of the sender could not be verified (SPF Record)]</small>	Tue 17 Jan 2023 14:45	43 KB	This message has bee...	
☑ emoffice@pkisd.gov.za	<b>Read: Reminder - Availability of Draft Scoping Reports for Comment - Kudu Solar PV</b> <small>You don't often get email from emoffice@pkisd.gov.za. Learn why this is important &lt;https://aka.ms/LearnAboutSenderIdentification&gt;</small>	Tue 17 Jan 2023 14:40	45 KB	This message has bee...	
☑ Flora Mokgohloa	<b>Read: Reminder - Availability of Draft Scoping Reports for Comment - Kudu Solar PV</b> <small>You don't often get email from fmokgohloa@dfle.gov.za. Learn why this is important &lt;https://aka.ms/LearnAboutSenderIdentification&gt;</small> Your message	Tue 17 Jan 2023 14:33	43 KB	This message has bee...	
☑ Morgan Griffiths	<b>Read: Reminder - Availability of Draft Scoping Reports for Comment - Kudu Solar PV</b> Your message	Tue 17 Jan 2023 13:17	49 KB	This message has bee...	
☒ Henk Kruger (SESSA)	<b>Not read: Reminder - Availability of Draft Scoping Reports for Comment - Kudu Solar PV</b> <small>You don't often get email from treasurer@sessa.org.za. Learn why this is important &lt;https://aka.ms/LearnAboutSenderIdentification&gt;</small> Your message	Tue 17 Jan 2023 13:06	42 KB	This message has bee...	
☑ Helen Antonopoulos	<b>Read: Reminder - Availability of Draft Scoping Reports for Comment - Kudu Solar PV</b> Your message	Tue 17 Jan 2023 13:00	21 KB	This message has bee...	
☑ Rofhiwa Magodi	<b>Read: Reminder - Availability of Draft Scoping Reports for Comment - Kudu Solar PV</b> Your message	Tue 17 Jan 2023 12:58	41 KB	This message has bee...	
☑ [Redacted]	<b>Read: Reminder - Availability of Draft Scoping Reports for Comment - Kudu Solar PV</b> <small>You don't often get email from [Redacted]. Learn why this is important &lt;https://aka.ms/LearnAboutSenderIdentification&gt;</small> Your message	Tue 17 Jan 2023 12:29	76 KB	This message has bee...	
☑ [Redacted]	<b>Read: Reminder - Availability of Draft Scoping Reports for Comment - Kudu Solar PV</b> <small>You don't often get email from [Redacted]. Learn why this is important &lt;https://aka.ms/LearnAboutSenderIdentification&gt;</small> Your message	Tue 17 Jan 2023 12:28	77 KB	This message has bee...	
☑ pixley@albieswireless.co.za	<b>Read: Reminder - Availability of Draft Scoping Reports for Comment - Kudu Solar PV</b> <small>You don't often get email from pixley@albieswireless.co.za. Learn why this is important &lt;https://aka.ms/LearnAboutSenderIdentification&gt;</small>	Tue 17 Jan 2023 12:25	45 KB	This message has bee...	
☑ Earthlife Africa JHB	<b>Read: Reminder - Availability of Draft Scoping Reports for Comment - Kudu Solar PV</b> <small>You don't often get email from seccp@earthlife.org.za. Learn why this is important &lt;https://aka.ms/LearnAboutSenderIdentification&gt;</small>	Tue 17 Jan 2023 12:21	44 KB	This message has bee...	
☑ otshékela@pkisd.gov.za	<b>Read: Reminder - Availability of Draft Scoping Reports for Comment - Kudu Solar PV</b> <small>You don't often get email from otshékela@pkisd.gov.za. Learn why this is important &lt;https://aka.ms/LearnAboutSenderIdentification&gt;</small>	Tue 17 Jan 2023 12:21	41 KB	This message has bee...	
☑ Julliet Mahlangu	<b>Read: Reminder - Availability of Draft Scoping Reports for Comment - Kudu Solar PV</b> Your message	Tue 17 Jan 2023 12:21	41 KB	This message has bee...	

## APPENDICES

### SCOPING REPORT: Scoping and Environmental Impact Assessment (EIA) Process for the Proposed Development of a Solar Photovoltaic (PV) Facility (Kudu Solar Facility 8) and associated infrastructure, near De Aar, Northern Cape Province

EMS - Read Receipts By Date ▼ ↑

		From	Subject	Received	Size	Categories	Mention
		<b>Chris Schutte (CE)</b> Your message	<b>Read: Reminder - Availability of Draft Scoping Reports for Comment - Kudu Solar PV</b>	Tue 17 Jan 2023 12:17	54 KB	This message has bee...	
		<b>Zama Langa</b> You don't often get email from zlanga@dffe.gov.za. Learn why this is important < <a href="https://aka.ms/LearnAboutSenderIdentification">https://aka.ms/LearnAboutSenderIdentification</a> > Your message	<b>Read: Reminder - Availability of Draft Scoping Reports for Comment - Kudu Solar PV</b>	Tue 17 Jan 2023 12:11	42 KB	This message has bee...	
<b>▼ Last Month</b>							
		<b>asibeko@pksgdm.g...</b> You don't often get email from asibeko@pksgdm.gov.za. Learn why this is important < <a href="https://aka.ms/LearnAboutSenderIdentification">https://aka.ms/LearnAboutSenderIdentification</a> >	<b>Read: Availability of Draft Scoping Reports for Comment - Kudu Solar PV</b>	Tue 10 Jan 2023 13:30	49 KB	This message has bee...	
		<b>Mahlatshe Shubane</b> Your message	<b>Read: Availability of Draft Scoping Reports for Comment - Kudu Solar PV</b>	Fri 06 Jan 2023 12:54	46 KB	This message has bee...	
		<b>Sydney Nkosi</b> You don't often get email from shnkosi@dffe.gov.za. Learn why this is important < <a href="https://aka.ms/LearnAboutSenderIdentification">https://aka.ms/LearnAboutSenderIdentification</a> > Your message	<b>Read: Availability of Draft Scoping Reports for Comment - Kudu Solar PV</b>	Tue 03 Jan 2023 10:44	43 KB	This message has bee...	
<b>▼ Older</b>							
		<b>rysselboerdery@g...</b> [The e-mail server of the sender could not be verified (SPF Record)] Your message	<b>Read: Availability of Draft Scoping Reports for Comment - Kudu Solar PV</b>	Wed 14 Dec 2022 15:16	40 KB	This message has bee...	
		<b>Ludwig &amp; Eileen M...</b> This is a receipt for the email message you sent to	<b>Read: Availability of Draft Scoping Reports for Comment - Kudu Solar PV</b>	Wed 14 Dec 2022 08:26	36 KB	This message has bee...	
		<b>Helen Antonopoulos</b> Your message	<b>Read: Availability of Draft Scoping Reports for Comment - Kudu Solar PV</b>	Tue 13 Dec 2022 08:25	30 KB	This message has bee...	
		<b>Savannah Public Pr...</b> Your message	<b>Read: Availability of Draft Scoping Reports for Comment - Kudu Solar PV</b>	Mon 12 Dec 2022 20:14	41 KB	This message has bee...	
		<b>Rohaida Abed</b> Your message	<b>Read: Availability of Draft Scoping Reports for Comment - Kudu Solar PV</b>	Mon 12 Dec 2022 17:29	21 KB	This message has bee...	
		<b>dmotaung@pksgdm...</b> [The e-mail server of the sender could not be verified (SPF Record)] Your message	<b>Read: Availability of Draft Scoping Reports for Comment - Kudu Solar PV</b>	Mon 12 Dec 2022 16:04	39 KB	This message has bee...	
		<b>Karl Naude</b> Your message	<b>Read: Availability of Draft Scoping Reports for Comment - Kudu Solar PV</b>	Mon 12 Dec 2022 14:47	41 KB	This message has bee...	

## APPENDICES

### SCOPING REPORT: Scoping and Environmental Impact Assessment (EIA) Process for the Proposed Development of a Solar Photovoltaic (PV) Facility (Kudu Solar Facility 8) and associated infrastructure, near De Aar, Northern Cape Province

EMS - Read Receipts						By Date <span style="font-size: small;">v</span> <span style="font-size: small;">↑</span>
From	Subject	Received	Size	Categories	Mention	v
<b>Chris Schutte (CE)</b> <small>Your message</small>	<b>Read: Reminder - Availability of Draft Scoping Reports for Comment - Kudu Solar PV</b>	Tue 17 Jan 2023 12:17	54 KB		This message has bee...	
<b>Zama Langa</b> <small>You don't often get email from zlanga@dffe.gov.za. Learn why this is important &lt;https://aka.ms/LearnAboutSenderIdentification&gt; Your message</small>	<b>Read: Reminder - Availability of Draft Scoping Reports for Comment - Kudu Solar PV</b>	Tue 17 Jan 2023 12:11	42 KB		This message has bee...	
<b>▼ Last Month</b>						
<b>asibeko@pksgdm.go...</b> <small>You don't often get email from asibeko@pksgdm.gov.za. Learn why this is important &lt;https://aka.ms/LearnAboutSenderIdentification&gt;</small>	<b>Read: Availability of Draft Scoping Reports for Comment - Kudu Solar PV</b>	Tue 10 Jan 2023 13:30	49 KB		This message has bee...	
<b>Mahlatshe Shubane</b> <small>Your message</small>	<b>Read: Availability of Draft Scoping Reports for Comment - Kudu Solar PV</b>	Fri 06 Jan 2023 12:54	46 KB		This message has bee...	
<b>Sydney Nkosi</b> <small>You don't often get email from shnkosi@dffe.gov.za. Learn why this is important &lt;https://aka.ms/LearnAboutSenderIdentification&gt; Your message</small>	<b>Read: Availability of Draft Scoping Reports for Comment - Kudu Solar PV</b>	Tue 03 Jan 2023 10:44	43 KB		This message has bee...	
<b>▼ Older</b>						
<b>[REDACTED]</b> <small>[The e-mail server of the sender could not be verified (SPF Record)] Your message</small>	<b>Read: Availability of Draft Scoping Reports for Comment - Kudu Solar PV</b>	Wed 14 Dec 2022 15:16	40 KB		This message has bee...	
<b>[REDACTED]</b> <small>This is a receipt for the email message you sent to</small>	<b>Read: Availability of Draft Scoping Reports for Comment - Kudu Solar PV</b>	Wed 14 Dec 2022 08:26	36 KB		This message has bee...	
<b>Helen Antonopoulos</b> <small>Your message</small>	<b>Read: Availability of Draft Scoping Reports for Comment - Kudu Solar PV</b>	Tue 13 Dec 2022 08:25	30 KB		This message has bee...	
<b>Savannah Public Pr...</b> <small>Your message</small>	<b>Read: Availability of Draft Scoping Reports for Comment - Kudu Solar PV</b>	Mon 12 Dec 2022 20:14	41 KB		This message has bee...	
<b>Rohaida Abed</b> <small>Your message</small>	<b>Read: Availability of Draft Scoping Reports for Comment - Kudu Solar PV</b>	Mon 12 Dec 2022 17:29	21 KB		This message has bee...	
<b>dmotaung@pksgdm...</b> <small>[The e-mail server of the sender could not be verified (SPF Record)] Your message</small>	<b>Read: Availability of Draft Scoping Reports for Comment - Kudu Solar PV</b>	Mon 12 Dec 2022 16:04	39 KB		This message has bee...	
<b>Karl Naude</b> <small>Your message</small>	<b>Read: Availability of Draft Scoping Reports for Comment - Kudu Solar PV</b>	Mon 12 Dec 2022 14:47	41 KB		This message has bee...	

## APPENDICES

### SCOPING REPORT: Scoping and Environmental Impact Assessment (EIA) Process for the Proposed Development of a Solar Photovoltaic (PV) Facility (Kudu Solar Facility 8) and associated infrastructure, near De Aar, Northern Cape Province

EMS - Read Receipts							By Date <span style="font-size: small;">v</span> <span style="font-size: small;">↑</span>
From	Subject	Received	Size	Categories	Mention		
<b>Howard Hendricks</b> <small>[The e-mail server of the sender could not be verified (SPF Record)]</small>	<b>Read: Availability of Draft Scoping Reports for Comment - Kudu Solar PV</b>	Sun 11 Dec 2022 12:44	42 KB			This message has bee...	
<b>doornkloofnr@gm...</b> <small>You don't often get email from doornkloofnr@gmail.com. Learn why this is important &lt;https://aka.ms/LearnAboutSenderIdentification&gt;</small>	<b>Read: Availability of Draft Scoping Reports for Comment - Kudu Solar PV</b>	Sat 10 Dec 2022 08:10	44 KB			This message has bee...	
<b>quarantine@csir.co...</b> <small>Sophos quarantined the following messages because they appear to be either spam or bulk messages. These messages can contain malicious content. To request a message to be released from quarantine and delivered to you,</small>	<b>Quarantined spam and bulk messages since Dec 09 15:00</b>	Sat 10 Dec 2022 08:01	26 KB			This message has bee...	
<b>Portia Makitla</b> <small>Your message</small>	<b>Read: RE: Availability of Draft Scoping Reports for Comment - Kudu Solar PV</b>	Fri 09 Dec 2022 23:56	40 KB			This message has bee...	
<b>Lucius Moolman</b> <small>You don't often get email from lucius.moolman@sanparks.org. Learn why this is important &lt;https://aka.ms/LearnAboutSenderIdentification&gt;</small>	<b>Read: RE: Availability of Draft Scoping Reports for Comment - Kudu Solar PV</b>	Fri 09 Dec 2022 18:12	43 KB			This message has bee...	
<b>Azrah Essop</b> <small>You don't often get email from aessop@dffe.gov.za. Learn why this is important &lt;https://aka.ms/LearnAboutSenderIdentification&gt;</small>	<b>Read: RE: Availability of Draft Scoping Reports for Comment - Kudu Solar PV</b> <small>Your message</small>	Fri 09 Dec 2022 15:57	42 KB			This message has bee...	
<b>[REDACTED]</b> <small>You don't often get email from [REDACTED]. Learn why this is important &lt;https://aka.ms/LearnAboutSenderIdentification&gt;</small>	<b>Read: Availability of Draft Scoping Reports for Comment - Kudu Solar PV</b> <small>Your message</small>	Fri 09 Dec 2022 15:40	46 KB			This message has bee...	
<b>Nokukhanya Khum...</b> <small>[The e-mail server of the sender failed SPF checks and maybe malicious (SPF Record)] Nokukhanya Khumalo</small>	<b>Read: Availability of Draft Scoping Reports for Comment - Kudu Solar PV</b>	Fri 09 Dec 2022 15:32	71 KB			This message has bee...	
<b>[REDACTED]</b> <small>You don't often get email from [REDACTED]. Learn why this is important &lt;https://aka.ms/LearnAboutSenderIdentification&gt;</small>	<b>Read: Availability of Draft Scoping Reports for Comment - Kudu Solar PV</b> <small>Your message</small>	Fri 09 Dec 2022 15:11	79 KB			This message has bee...	
<b>Earthlife Africa JHB</b> <small>You don't often get email from seccp@earthlife.org.za. Learn why this is important &lt;https://aka.ms/LearnAboutSenderIdentification&gt;</small>	<b>Read: Availability of Draft Scoping Reports for Comment - Kudu Solar PV</b>	Fri 09 Dec 2022 15:10	47 KB			This message has bee...	
<b>Helen Antonopoulos</b> <small>Your message</small>	<b>Read: Availability of Draft Scoping Reports for Comment - Kudu Solar PV</b>	Fri 09 Dec 2022 15:08	21 KB			This message has bee...	
<b>Natasha Higgitt</b> <small>[The e-mail server of the sender failed SPF checks and maybe malicious (SPF Record)] Natasha Higgitt</small>	<b>Read: Availability of Draft Scoping Reports for Comment - Kudu Solar PV</b>	Fri 09 Dec 2022 15:08	70 KB			This message has bee...	
<b>Rohaida Abed</b> <small>Your message</small>	<b>Read: Availability of Draft Scoping Reports for Comment - Kudu Solar PV</b>	Fri 09 Dec 2022 15:07	21 KB			This message has bee...	

## APPENDICES

SCOPING REPORT: Scoping and Environmental Impact Assessment (EIA) Process for the Proposed Development of a Solar Photovoltaic (PV) Facility (Kudu Solar Facility 8) and associated infrastructure, near De Aar, Northern Cape Province

---

### **APPENDIX E.9: PROOF OF SUBMISSION OF THE DSR AND APPLICATION FORM TO THE DFFE**

*App. E.9/...*

## APPENDICES

### SCOPING REPORT: Scoping and Environmental Impact Assessment (EIA) Process for the Proposed Development of a Solar Photovoltaic (PV) Facility (Kudu Solar Facility 8) and associated infrastructure, near De Aar, Northern Cape Province

#### 1. Copy of Email sent to the DFFE for Submission of the DSR and Application Form on 9 December 2022

**Rohaida Abed**

**From:** Rohaida Abed  
**Sent:** Friday, 09 December 2022 11:36  
**To:** EIA Applications  
**Cc:** Du Toit Malherbe; Petrus Scheepers; Rob Invernizzi; Paul Lochner; Helen Antonopoulos; Constance Musemburi; Makhosi Yeni; Mahlatshe Shubane; Olivia Letlalo; Lerato Mokoena; Wayne Hector; Jay-Jay Mpelane; Zama Langa; Nyiko Nkosi; Thembisile Hlatshwayo; Azrah Essop; Julliet Mahlangu  
**Subject:** Submission of EA Application Form and DSR for Comment: Kudu Solar Facility 8  
**Attachments:** 01\_Cover Letter\_Kudu Solar Facility 8\_FINAL.pdf; Document Control Form\_Kudu Solar Facility 8.pdf; Proof of Submission\_Kudu Solar Facility 8\_DSR\_App Form.PNG  
**Categories:** This message has been archived by Retain on December 16 2022 20:47

Good day,

**SCOPING AND ENVIRONMENTAL IMPACT ASSESSMENT (EIA) PROCESS FOR THE PROPOSED DEVELOPMENT OF A SOLAR PHOTOVOLTAIC (PV) FACILITY (KUDU SOLAR FACILITY 8) AND ASSOCIATED INFRASTRUCTURE, NEAR DE AAR, NORTHERN CAPE PROVINCE**

Kindly note that an Application for Environmental Authorisation (EA) and the Draft Scoping Report, inclusive of all supporting appendices, as well as a Cover Letter for the above proposed Kudu Solar Facility 8 project has been uploaded to the Novell S-File system.

The Draft Scoping Report for the proposed Kudu Solar Facility 8 project is also being made available to stakeholders and registered Interested and/or Affected Parties (I&APs) for a 30-day comment period extending from **9 December 2022 to 30 January 2023** (excluding the regulated shutdown period).

Please note that a pre-application meeting took place with the Competent Authority, the National Department of Forestry, Fisheries and the Environment (DFFE) on 26 April 2022 (Reference Number: 2022-04-0005), in order to discuss and agree on various aspects with the DFFE prior to release of the Draft Scoping Report. Refer to Appendix 1 of the Application for EA for the proof of such correspondence, as well as Appendix F of the Draft Scoping Report.

The proposed project forms part of a cluster of twelve (12) Solar Facilities (i.e. Kudu Solar Facility 1 to Kudu Solar Facility 12) and are located on adjoining farm portions.

Separate Applications for EA and Draft Scoping Reports for each project have been compiled and are being uploaded to the system in parallel (separate emails are being sent for these).

The relevant DFFE officials have been copied on this email.

This submission is in line with the "Process for Submitting files to the CD IEA\_082022" document. To this end, please find attached to this email:

- Cover Letter to DFFE regarding submission of the Draft Scoping Report for the abovementioned project;
- Proof of upload of the Application for EA, Draft Scoping Report and Appendices (i.e. Screenshot of the upload); and
- Document Control Form.

Kindly note that the Cover Letter is also included as part of the zipped folder uploaded.

We trust that you find this submission in order, and we look forward to your feedback.

Please do not hesitate to contact us should you have any queries relating to the above.

Thank you and kind regards,  
Rohaida



## APPENDICES

### SCOPING REPORT: Scoping and Environmental Impact Assessment (EIA) Process for the Proposed Development of a Solar Photovoltaic (PV) Facility (Kudu Solar Facility 8) and associated infrastructure, near De Aar, Northern Cape Province

#### 2. Proof of Upload of the DSR to the DFFE Novell S-File on 9 December 2022

The screenshot shows a web browser window displaying a file management interface for 'My Files'. The browser address bar shows the URL: [sfler.environment.gov.za:8443/ssf/a/c/p\\_name/ss\\_forum/p\\_action/1/action/view\\_permalink/showCollection/-1/entityType/user/entrytd/ss\\_user\\_id\\_place\\_holder/nov\\_lurl/1/nov\\_root/1#16705...](https://sfler.environment.gov.za:8443/ssf/a/c/p_name/ss_forum/p_action/1/action/view_permalink/showCollection/-1/entityType/user/entrytd/ss_user_id_place_holder/nov_lurl/1/nov_root/1#16705...)

The interface includes a search bar and a 'Filter List' dropdown. Below the search bar, there are buttons for 'New Folder...', 'Share...', 'Delete', 'Add Files...', and 'More...'. The main content area displays a table of files with the following columns: Name, Size, and Modified.

Name	Size	Modified
Application for an EA for the Vaal Lodge Development		Nov 30, 2022 8:02 PM
00 Allocated - PLEASE DO NOT UPLOAD INTO OR DELETE THIS FOLDER		Dec 9, 2022 10:57 AM
01 Unallocated - PLEASE DO NOT UPLOAD INTO OR DELETE THIS FOLDER		Dec 9, 2022 11:16 AM
Kudu Solar 1_EAApp_Draft Scoping Report.zip	139,340 KB	Dec 9, 2022 9:04 AM
Kudu Solar 2_EAApp_Draft Scoping Report.zip	139,731 KB	Dec 9, 2022 10:14 AM
Kudu Solar 3_EAApp_Draft Scoping Report.zip	139,879 KB	Dec 9, 2022 10:16 AM
Kudu Solar 4_EAApp_Draft Scoping Report.zip	139,634 KB	Dec 9, 2022 10:16 AM
Kudu Solar 5_EAApp_Draft Scoping Report.zip	140,250 KB	Dec 9, 2022 10:17 AM
Kudu Solar 6_EAApp_Draft Scoping Report.zip	139,316 KB	Dec 9, 2022 10:17 AM
Kudu Solar 7_EAApp_Draft Scoping Report.zip	139,071 KB	Dec 9, 2022 10:18 AM
<input checked="" type="checkbox"/> Kudu Solar 8_EAApp_Draft Scoping Report.zip	138,603 KB	Dec 9, 2022 10:19 AM
Kudu Solar 9_EAApp_Draft Scoping Report.zip	137,714 KB	Dec 9, 2022 10:19 AM
Final BAR and EMP: Verzamelings to Leiden.zip	90,909 KB	Dec 9, 2022 11:01 AM
Part 1 EA Amentment - Shangori Gate_14-12-16-3-3-1-1730.zip	15,105 KB	Dec 9, 2022 11:55 AM

The file 'Kudu Solar 8\_EAApp\_Draft Scoping Report.zip' is highlighted in blue and has a checkmark in the left column. The interface also shows a 'View What's New' button and a 'Filter List' dropdown.

The Windows taskbar at the bottom shows the system tray with the date and time: 11:28, 09 Dec 2022.



## APPENDICES

SCOPING REPORT: Scoping and Environmental Impact Assessment (EIA) Process for the Proposed Development of a Solar Photovoltaic (PV) Facility (Kudu Solar Facility 8) and associated infrastructure, near De Aar, Northern Cape Province

---

### **APPENDIX E.10: COMMENTS RECEIVED FROM STAKEHOLDERS DURING THE 30-DAY REVIEW OF THE DSR**

*App. E.10/...*

## APPENDICES

### SCOPING REPORT: Scoping and Environmental Impact Assessment (EIA) Process for the Proposed Development of a Solar Photovoltaic (PV) Facility (Kudu Solar Facility 8) and associated infrastructure, near De Aar, Northern Cape Province

---

#### 1. Comments Received from the Department of Forestry, Fisheries and the Environment (DFFE)

---

##### 1.1 The DFFE Directorate: Integrated Environmental Authorisation: Kudu Solar Facility 8

---

**From:** Ephron Maradwa <EMaradwa@dffe.gov.za>  
**Sent:** Friday, 09 December 2022 14:50  
**To:** Rohaida Abed  
**Cc:** Constance Musemburi; ElAadmin; Salome Mambane  
**Subject:** 14/12/16/3/3/2/2251

**Categories:** This message has been archived by Retain on December 16 2022 20:46

Dear Rohaida

14/12/16/3/3/2/2251

**ACKNOWLEDGEMENT OF RECEIPT OF THE NEW APPLICATION AND DRAFT SCOPING REPORT FOR ENVIRONMENTAL AUTHORISATION FOLLOWING A SCOPING ASSESSMENT PROCESS FOR THE PROPOSED DEVELOPMENT OF A SOLAR PHOTOVOLTAIC (PV) FACILITY (KUDU SOLAR FACILITY 8) AND ASSOCIATED INFRASTRUCTURE, NEAR DE AAR, NORTHERN CAPE PROVINCE.**

The Department confirms having received the Application form and Draft Scoping Report for Environmental Authorisation for the abovementioned project on 09 December 2022. You have submitted these documents to comply with the Environmental Impact Assessment (EIA) Regulations, 2014, as amended.

Kindly note that your application for Environmental Authorisation falls within the ambit of an application applied for in terms of Part 3 of Chapter 4 of the EIA Regulations, 2014, as amended. You are therefore referred to Regulation 21 of the EIA Regulations, 2014 as amended.

Please take note of Regulation 40(3) of the EIA Regulations, 2014, as amended, which states that potential Interested & Affected Parties, including the Competent Authority, may be provided with an opportunity to comment on reports and plans contemplated in Regulation 40(1) of the EIA Regulations, 2014, as amended, prior to the submission of an application but must be provided an opportunity to comment on such reports once an application has been submitted to the Competent Authority.

Note that in terms of Regulation 45 of the EIA Regulations, 2014, as amended, this application will lapse if the applicant fails to meet any of the time-frames prescribed in terms of these Regulations, unless an extension has been granted by the Department in terms of Regulation 3(7) of the EIA Regulations, 2014, as amended.

You are hereby reminded of Section 24F of the National Environmental Management Act, Act No. 107 of 1998, as amended, that no activity may commence prior to an Environmental Authorisation being granted by the Department.

Kindly quote the abovementioned reference number in any future correspondence in respect of the application.

EIA Applications  
Integrated Environmental Authorisations  
Department of Forestry, Fisheries and the Environment

Please note that this email is for the receipt and processing of online applications only, and is not monitored for responses. All queries must be directed to [ElAadmin@dffe.gov.za](mailto:ElAadmin@dffe.gov.za).

You are advised that this mailbox has a 48 hour response time.

*Please note that this mailbox has a 5mb mail limit. No zip files are to be attached in any email.*

## APPENDICES

SCOPING REPORT: Scoping and Environmental Impact Assessment (EIA) Process for the Proposed Development of a Solar Photovoltaic (PV) Facility (Kudu Solar Facility 8) and associated infrastructure, near De Aar, Northern Cape Province

---

**From:** Lydia Kutu <LKutu@dffe.gov.za>

**Sent:** Wednesday, 25 January 2023 14:02

**To:** Paul Lochner <PLochner@csir.co.za>; Rohaida Abed <RAbed@csir.co.za>; Du Toit Malherbe <du-toit.malherbe@abo-wind.com>; Petrus.Scheepers@abo-wind.com; nuys.denc@gmail.com

**Cc:** Constance Musemburi <CMusemburi@dffe.gov.za>; EIAAdmin <EIAAdmin@dffe.gov.za>; Salome Mambane <SMAMBANE@dffe.gov.za>

**Subject:** 14/12/16/3/3/2/2251

Good day.

Please find herein the attached letter for the above mentioned.

**Please do not respond to this mailbox with any queries related to the decision been issued. All queries on the attached decision must be directed to official whose contact details is listed as enquiries.**

I hope you find all in order.

Thank you.

Kind Regards,

Lydia Kutu

Integrated Environmental Authorisations:

Priority Infrastructure Developments

Tel: (012) 399 9370

Email: [LKutu@dffe.gov.za](mailto:LKutu@dffe.gov.za)

*To God be the Glory!!!*

## APPENDICES

### SCOPING REPORT: Scoping and Environmental Impact Assessment (EIA) Process for the Proposed Development of a Solar Photovoltaic (PV) Facility (Kudu Solar Facility 8) and associated infrastructure, near De Aar, Northern Cape Province

---



#### forestry, fisheries & the environment

Department:  
Forestry, Fisheries and the Environment  
**REPUBLIC OF SOUTH AFRICA**

Private Bag X 447- PRETORIA 0001- Environment House 473 Steve Biko Road, Arcadia, PRETORIA

**DFFE Reference:** 14/12/16/3/3/2/2251

**Enquiries:** Mr Wayne Hector

**Telephone:** (012) 399 9410 **E-mail:** [WHector@dffe.gov.za](mailto:WHector@dffe.gov.za)

Mr Paul Lochner  
Council for Scientific and Industrial Research (CSIR)  
PO Box 320  
**STELLENBOSCH**  
7599

Telephone Number:

Email Address:

[PLochner@csir.co.za](mailto:PLochner@csir.co.za)

[RAbed@csir.co.za](mailto:RAbed@csir.co.za)

#### PER MAIL / E-MAIL

Dear Mr Lochner

#### COMMENTS ON THE DRAFT SCOPING REPORT FOR THE PROPOSED DEVELOPMENT OF AN UP TO 350MW<sub>ac</sub> SOLAR PHOTOVOLTAIC (PV) FACILITY (KUDU SOLAR FACILITY 8) AND ASSOCIATED INFRASTRUCTURE, NEAR DE AAR, NORTHERN CAPE PROVINCE.

The Application for Environmental Authorisation and Draft Scoping Report (DSR) dated December 2022, received and acknowledged by the Department on 9 December 2022, refer.

This letter serves to inform you that the following information must be included to the final SR (FSR):

#### 1. Application form

- It is not clear why this Department is the Competent Authority for the proposed development. It is not clear whether the applicant intends to bid the proposed development into future Renewable Independent Power Producer Programme (REIPPP) bid rounds. Please note that the Minister is the competent authority for applications for facilities or infrastructure, that will form part of the Integrated Resource Plan (IRP) Programmes for technologies whose procurement processes have been determined under the Electricity Regulation Act, 2006 and / or the Electricity Regulations on New Generation Capacity. If the applicant will not, or does not intend to, participate in any of the IRP programmes, the competent authority will be the MEC responsible for environmental affairs in the respective province. Be advised that this information must be clearly presented in Section 1 – Competent Authority in the application form.
- Further note that should the proposed development not link with the national grid or be part of the REIPPPP, this Department will not be the Competent Authority responsible for the processing of the application and the application will have to be withdrawn and be submitted to the relevant MEC.
- Considering the above, the reasons provided in Section 1 of the application form for this Department being the Competent Authority in terms of S24C of NEMA are, therefore, incorrect and incomplete. This must be rectified and expanded on in the application form as well as the report. Please refer to GN 779.

*wk*

## APPENDICES

### SCOPING REPORT: Scoping and Environmental Impact Assessment (EIA) Process for the Proposed Development of a Solar Photovoltaic (PV) Facility (Kudu Solar Facility 8) and associated infrastructure, near De Aar, Northern Cape Province

---

Chief Directorate: Integrated Environmental Authorisations

---

- In addition, please ensure that the need and desirability of the proposed development must include reference to REIPPPP.

#### 2. **Project Description and Listed Activities**

- a) The project description states that *“is important to note at the outset that the exact specifications of the proposed project components will only be determined during the detailed engineering phase prior to construction (subsequent to the issuing of an EA)....”*. Further when describing the listed activities, the EAP made use of the words such as, *“is expected, potentially,”* etc. Please note that the Project Description and Listed Activities are not based on a precautionary approach. The EAP/Applicant must be certain why listed activities are being triggered to enable the competent authority to apply its mind to all the assessed listed activities during decision making. Only applicable listed activities must be applied for and the project description must be specific on what is being proposed in the FSR.
- b) Please ensure that all relevant listed activities are applied for, are specific and can be linked to the development activity or infrastructure (including thresholds) as described in the project description. Only activities (and sub-activities) applicable to the development must be applied for and assessed.
- c) Activity 11 LN1: please clarify whether the IPP substation will be included as part of the application for the PV or as a separate application in terms of the EGI standard. The IPP substation may be included as part of the PV application, should the applicant wish to include it.
- d) Please take note that Activity 14 LN1, referring to the development and related operation of facilities or infrastructure, for the storage and handling, of dangerous goods, being applied for is depended on the type of technology to be used. If the preferred technology is the Solid-State Lithium-Ion Batteries for the BESS, this activity may not be applicable. Installations, facilities or infrastructure related to the development (or expansion) of battery energy storage systems, will not trigger any of the activities related to the development and related operation of facilities or infrastructure, for the storage, or storage and handling of a dangerous good, where such storage occurs in containers with a combined capacity, quantified by the relevant threshold for the activity listed or specified in the relevant Listing Notice. Please note that the FSR requires that you clarify and confirm the applicability of the abovementioned activity.
- e) You are required to confirm whether systematic biodiversity plans or bioregional plans are adopted by the competent authority? You applied for certain activities in Listing Notice 3 that requires that Bioregional Plans be adopted.
- f) It is imperative that the relevant authorities are continuously involved throughout the environmental impact assessment process, as the development property possibly falls within geographically designated areas in terms of Listing Notice 3 Activities. Written comments must be obtained from the relevant authorities (or proof of consultation if no comments were received) and submitted to this Department. In addition, a graphical representation of the proposed development within the respective geographical areas must be provided.
- g) If the activities applied for in the application form differ from those mentioned in the FSR, an amended application form must be submitted. Please note that the Department’s application form template has been amended and can be downloaded from the following link <https://www.dffe.gov.za/documents/forms>.
- h) A signed amended application with correct applicable listed activities and correctly completed must be submitted in this regard.

#### 3. **Layout & Sensitivity Maps**

- a) Please provide a layout map which indicates the following:
  - the PV development area;
  - Position of all infrastructure e.g. panels, BESS, substations, grid connection etc.;

*wk*

## APPENDICES

### SCOPING REPORT: Scoping and Environmental Impact Assessment (EIA) Process for the Proposed Development of a Solar Photovoltaic (PV) Facility (Kudu Solar Facility 8) and associated infrastructure, near De Aar, Northern Cape Province

---

Chief Directorate: Integrated Environmental Authorisations

---

- Permanent laydown area footprint;
  - All supporting onsite infrastructure e.g. roads (existing and proposed);
  - Substation(s) and/or transformer(s) sites including their entire footprint;
  - Connection routes (including pylon positions) to the distribution/transmission network; and
  - All existing infrastructure on the site.
  - The location of sensitive environmental features on site e.g., CBAs, heritage sites, wetlands, drainage lines etc. that will be affected;
  - Buffer areas; and
  - All “no-go” areas.
- b) The above map must be overlain with a sensitivity map and a cumulative map which shows neighbouring renewable energy developments and existing grid infrastructure. All available biodiversity information must be used in the finalisation of the map and infrastructure must not encroach on highly sensitive areas as far as possible.
- c) Ensure that similar colours are not used to differentiate between infrastructure. i.e. items must be easily distinguishable in the Legend.
- d) Google maps will not be accepted for decision-making purposes.
4. **Public Participation Process**
- a) Please ensure that all issues raised, and comments received on the DSR from registered I&APs and organs of state which have jurisdiction (including this Department’s Biodiversity Section: [BCAdmin@dffe.gov.za](mailto:BCAdmin@dffe.gov.za)) in respect of the proposed activity are adequately addressed in the Final SR. Proof of correspondence with the various stakeholders must be included in the FSR. Should you be unable to obtain comments, proof must be submitted to the Department of the attempts that were made to obtain comments. The Public Participation Process must be conducted in terms of the approved public participation plan and Regulation 39, 40, 41, 42, 43 & 44 of the EIA Regulations 2014, as amended.
- b) A comments and response trail report (C&R) must be submitted with the FSR. The C&R report must incorporate all historical comments (pre and post submission of the DSR) for this development. The C&R report must be a separate document from the main report and the format must be in the table format which reflects the details of the I&APs and date of comments received, actual comments received, and response provided. Please ensure that comments made by I&APs are comprehensively captured (copy verbatim if required) and responded to clearly and fully. Please note that a response such as “Noted” is not regarded as an adequate response to I&AP’s comments.
5. **Specialist Assessments to be conducted in the EIA Phase**
- a) Ensure that the avifaunal assessment consults the guideline: “*BirdLife South Africa. 2017. Birds & Solar Energy: Guidelines for assessing and monitoring the impact of solar power generating facilities on birds in Southern Africa (compiled by Jenkins AR, Ralston-Paton S and Smit-Robinson HA).*”
- b) Specialist studies to be conducted must provide a detailed description of their methodology, as well as indicate the locations and descriptions of PV arrays, and all other associated infrastructures that they have assessed and are recommending for authorisations.
- c) The specialist studies must also provide a detailed description of all limitations to their studies. All specialist studies must be conducted in the right season and providing that as a limitation, will not be accepted.

*wk*

## APPENDICES

### SCOPING REPORT: Scoping and Environmental Impact Assessment (EIA) Process for the Proposed Development of a Solar Photovoltaic (PV) Facility (Kudu Solar Facility 8) and associated infrastructure, near De Aar, Northern Cape Province

---

Chief Directorate: Integrated Environmental Authorisations

---

- d) Should the appointed specialists specify contradicting recommendations, the EAP must clearly indicate the most reasonable recommendation and substantiate this with defensible reasons; and where necessary, include further expertise advice.
- e) It is further brought to your attention that Procedures for the Assessment and Minimum Criteria for Reporting on identified Environmental Themes in terms of Sections 24(5)(a) and (h) and 44 of the National Environmental Management Act, 1998, when applying for Environmental Authorisation, which were promulgated in Government Notice No. 320 of 20 March 2020 (i.e. "the Protocols"), and in Government Notice No. 1150 of 30 October 2020 (i.e. protocols for terrestrial plant and animal species), have come into effect. Please note that specialist assessments must be conducted in accordance with these protocols.
- f) Additionally, the protocols specify that an assessment must be prepared by a specialist who is an expert in the field and is SACNASP registered for e.g. an aquatic assessment must be prepared by a specialist registered with SACNASP, with expertise in the field of aquatic sciences.
- g) The screening tool output:
- The screening tool and the gazetted protocols (GN R320 of 20 March 2020 and GN R 1150 of 30 October 2020) require a site sensitivity verification to be completed to either confirm or dispute the findings and sensitivity ratings of the screening tool.
  - Site sensitivity verifications for all the identified specialist studies (according to the screening tool) must be provided.
  - The screening tool (Application form) identifies thirteen (13) Specialist assessments. It is the responsibility of the EAP to confirm this list and to motivate in the assessment report, the reason for not including any of the identified specialist study including the provision of photographic evidence of the site situation. The site sensitivity verification for each of the recommended studies, as per the protocols, must be compiled and attached. If the findings of the site verification differed from the screening tool and was found to be of a different sensitivity level, then a compliance statement would be acceptable.
  - Please include a table in the report, summarising the specialist studies required by the Department's Screening Tool, a column indicating whether these studies were conducted and a column with motivation for any studies not conducted. Please note that if any of the specialists' studies and requirements/protocols recommended in the Department's Screening Tool are not commissioned, motivation for such must be provided in the report per the requirements of the Protocols.
- h) Should the appointed specialists specify contradicting recommendations, the EAP must clearly indicate the most reasonable recommendation and substantiate this with defensible reasons; and where necessary, include further expertise advice.
6. **Environmental Management Programme**  
The EMP must include the following:
- a) It is drawn to your attention that for substation and overhead electricity transmission and distribution infrastructure, when such facilities trigger activity 11 or 47 of the Environmental Impact Assessment Regulations Listing Notice 1 of 2014, as amended, and any other listed and specified activities necessary for the realisation of such facilities, the Generic Environmental Management Programme, must be used and submitted with the final report over and above the EMP for the facility i.e. separate EMP for the substation, powerline and the facility.
- b) Further to the above, you are required to comply with the content of the EMP in terms of Appendix 4 of the Environmental Impact Assessment Regulations, 2014, as amended.

*wh*

## APPENDICES

### SCOPING REPORT: Scoping and Environmental Impact Assessment (EIA) Process for the Proposed Development of a Solar Photovoltaic (PV) Facility (Kudu Solar Facility 8) and associated infrastructure, near De Aar, Northern Cape Province

---

Chief Directorate: Integrated Environmental Authorisations

---

#### **General**

You are further reminded to comply with Regulation 21(1) of the NEMA EIA Regulations 2014, as amended, which states that:

*"If S&EIR must be applied to an application, the applicant must, within 44 days of receipt of the application by the competent authority, submit to the competent authority a SR which has been subjected to a public participation process of at least 30 days and which reflects the incorporation of comments received, including any comments of the competent authority"*

You are further reminded that the final SR to be submitted to this Department must comply with all the requirements in terms of the scope of assessment and content of SRs in accordance with Appendix 2 and Regulation 21(1) of the NEMA EIA Regulations 2014, as amended.

Further note that in terms of Regulation 45 of the EIA Regulations 2014, as amended, this application will lapse if the applicant fails to meet any of the timeframes prescribed in terms of these Regulations, unless an extension has been granted in terms of Regulation 3(7).

You are hereby reminded of Section 24F of the National Environmental Management Act, Act No. 107 of 1998, as amended, that no activity may commence prior to an Environmental Authorisation being granted by the Department.

Yours sincerely



**Mr Vusi Skosana**  
**Acting Chief Director: Integrated Environmental Authorisations**  
**Department of Forestry, Fisheries and the Environment**  
**Letter signed by: Mr Wayne Hector**  
**Designation: Deputy Director: Priority Infrastructure Projects**  
**Date: 25/01/23**

cc:	Du Toit Malherbe	Kudu Solar Facility 8 (Pty) Ltd	Email: Du-Toit.Malherbe@abo-wind.com
	Petrus Scheepers	Kudu Solar Facility 8 (Pty) Ltd	Email: Petrus.Scheepers@abo-wind.com
	Natalie Uys	NC: DALRRD	Email: nuys.denc@gmail.com



## APPENDICES

SCOPING REPORT: Scoping and Environmental Impact Assessment (EIA) Process for the Proposed Development of a Solar Photovoltaic (PV) Facility (Kudu Solar Facility 8) and associated infrastructure, near De Aar, Northern Cape Province

---

### 1.2 The DFFE Directorate: Biodiversity Conservation

---

---

**From:** Kamogelo Mathetja <KMathetja@dffe.gov.za>  
**Sent:** Monday, 12 December 2022 17:05  
**To:** EMS  
**Cc:** Portia Makitla; Mashudu Mudau  
**Subject:** RE: Availability of Draft Scoping Reports for Comment - Kudu Solar PV

**Categories:** This message has been archived by Retain on December 19 2022 18:52

Dear Sir/Madam

DFFE Directorate: Biodiversity Conservation hereby acknowledge receipt of the invitation to review and comment on the project mentioned on the subject line. Kindly note that the project has been allocated to Mrs P Makitla and Ms M Mudau (Both copied on this email).

Please note: All Public Participation Process documents related to Biodiversity EIA review and any other Biodiversity EIA queries will be submitted to the Directorate: Biodiversity Conservation at Email: BCAdmin@environment.gov.za for attention of Mr Seoka Lekota

Regards,  
Kamogelo

---

## APPENDICES

### SCOPING REPORT: Scoping and Environmental Impact Assessment (EIA) Process for the Proposed Development of a Solar Photovoltaic (PV) Facility (Kudu Solar Facility 8) and associated infrastructure, near De Aar, Northern Cape Province

---

---

**From:** BC Admin <bcadmin@dff.gov.za>  
**Sent:** Tuesday, 17 January 2023 15:42  
**To:** EMS  
**Cc:** Kamogelo Mathetja  
**Subject:** RE: Reminder - Availability of Draft Scoping Reports for Comment - Kudu Solar PV

**Categories:** This message has been archived by Retain on January 24 2023 18:51

Good day Rohaida.

Thank you for the reminder, kindly note the aforementioned project is still under review and we will be providing comments within the legislative timeframe (latest by 30/01/2023).

*Thanks & Regards,*

*Mashudu Mudau*

Biodiversity Mainstreaming & EIA  
Department of Forestry, Fisheries and the Environment  
Environment House  
473 Steve Biko and Soutpansberg Streets  
PRETORIA  
Tel: (012) 399 9945  
Cell: [REDACTED]  
E-mail: [mamudau@dff.gov.za](mailto:mamudau@dff.gov.za)



## APPENDICES

### SCOPING REPORT: Scoping and Environmental Impact Assessment (EIA) Process for the Proposed Development of a Solar Photovoltaic (PV) Facility (Kudu Solar Facility 8) and associated infrastructure, near De Aar, Northern Cape Province

---

---

**From:** Portia Makitla <PMakitla@dffe.gov.za>  
**Sent:** Tuesday, 31 January 2023 15:15  
**To:** EMS  
**Cc:** Mashudu Mudau  
**Subject:** Draft Scoping Reports for Comment - Kudu Solar PV  
**Attachments:** Kudu PV 1 DSR Comments\_.pdf

Good day

Please find the attached comments for your consideration.

*Thanks & Regards* 

Ms. Mashienyane Portia Makitla  
**CBO: Biodiversity Mainstreaming & EIA**  
Department of Forestry, Fisheries and the Environment  
Environment House  
473 Steve Biko and Soutpansberg Streets  
PRETORIA  
Tel: (012) 399 9411  
Cell: [REDACTED]  
E-mail: [pmakitla@dffe.gov.za](mailto:pmakitla@dffe.gov.za)  
Call Centre: 086 111 2468



## APPENDICES

### SCOPING REPORT: Scoping and Environmental Impact Assessment (EIA) Process for the Proposed Development of a Solar Photovoltaic (PV) Facility (Kudu Solar Facility 8) and associated infrastructure, near De Aar, Northern Cape Province

---



#### forestry, fisheries & the environment

Department:  
Forestry, Fisheries and the Environment  
REPUBLIC OF SOUTH AFRICA

Private Bag X 447, Pretoria, 0001, Environment House, 473 Steve Biko Road, Pretoria, Tel: +27 12 399 9000, Fax: +27 86 625 1042

Reference: Kudu Solar Facilities

Enquiries: Ms. Mashudu Mudau

Telephone: 012 399 9411 E-mail: [pmakita@dfpe.gov.za](mailto:pmakita@dfpe.gov.za)

Rohaida Abed  
Exigent Engineering Consultants CC  
P.O. Box 59081  
Umbilo  
**DURBAN**  
4075

Telephone Number: +27 31 242 2300  
Email Address: [ems@csir.co.za](mailto:ems@csir.co.za)

#### PER E-MAIL

Dear Sir/Madam

#### COMMENTS ON THE DRAFT SCOPING REPORT PROPOSED DEVELOPMENT OF THE PROPOSED DEVELOPMENT OF 12 SOLAR PHOTOVOLTAIC (PV) FACILITIES (I.E. KUDU SOLAR FACILITIES) AND VARIOUS ASSOCIATED INFRASTRUCTURE, NEAR DE AAR, NORTHERN CAPE

The Directorate: Biodiversity Conservation has reviewed and evaluated the reports and does not have any objection to the Scoping Report and the Plan of Study, however, must comply with the procedures for the assessment and minimum criteria for reporting on identified environmental themes in terms of sections 24(5)(A) and (H) and 44 of the National Environmental Management Act, 1998.

The final report must comply with all the requirements as outlined in the Environmental Impact Assessment (EIA) guideline for renewable energy projects and the Best Practice Guideline for Birds & Solar Energy for assessing and monitoring the impact of solar energy facilities on birds in Southern Africa.

In conclusion, the Public Participation Process documents related to Biodiversity EIA for review and queries should be submitted to the Directorate: Biodiversity Conservation at Email; [BCAdmin@dfpe.gov.za](mailto:BCAdmin@dfpe.gov.za) for the attention of Mr. Seoka Lekota.

Yours faithfully

**Mr. Seoka Lekota**  
Control Biodiversity Officer Grade B: Biodiversity Conservation



*Batho pele*- putting people first.

## APPENDICES

### SCOPING REPORT: Scoping and Environmental Impact Assessment (EIA) Process for the Proposed Development of a Solar Photovoltaic (PV) Facility (Kudu Solar Facility 8) and associated infrastructure, near De Aar, Northern Cape Province

---

The Proposed Development Of 12 Solar Photovoltaic (Pv) Facilities (I.E. Kudu Solar Facilities) And Various Associated Infrastructure, Near De Aar, Northern Cape

Department of Forestry, Fisheries & the Environment  
Letter signed by: Portia Makitla  
Date: 30/01/2023



*Batho pele*- putting people first.

## APPENDICES

SCOPING REPORT: Scoping and Environmental Impact Assessment (EIA) Process for the Proposed Development of a Solar Photovoltaic (PV) Facility (Kudu Solar Facility 8) and associated infrastructure, near De Aar, Northern Cape Province

---

### 1.3 The DFFE Directorate: Protected Areas Planning and Management Effectiveness

---

---

**From:** Thivhulawi Nethononda <TNETHONONDA@dffe.gov.za>  
**Sent:** Tuesday, 24 January 2023 09:05  
**To:** EMS  
**Cc:** Karl Naude; Lindokuhle Vilakati  
**Subject:** Comments on the Draft Scoping Reports for Comment - Kudu Solar PV  
**Attachments:** Protected Areas and NPAES.PNG

**Categories:** This message has been archived by Retain on January 31 2023 21:17

Dear CSIR Team,

The Directorate: Protected Areas Planning and Management Effectiveness, would like to thank you for the opportunity to review the Scoping Report and supporting documents for the proposed development of 12 solar photovoltaic (PV) facilities (i.e., Kudu solar facilities) and various associated infrastructure, near De Aar, Northern Cape.

After conducting the review of the submitted documents, we have noted that the proposed developments will not take place within any kind of protected areas in terms of Section 9 of the National Environmental Management: Protected Areas Act (NEMPAA), Act No. 57 of 2003. Subsequently, this directorate provides comments or input on the projects which are affecting the protected areas.

However, the EAP must consult and get comments (if not yet consulted) from the Biodiversity and Conservation Directorate of the Department of Forestry, Fisheries and the Environment (DFFE) which can be contacted at [BCAdmin@environment.gov.za](mailto:BCAdmin@environment.gov.za) for the attention of Mr. Seoka Lekota. Further, also notify the provincial departments, local municipality, and other associated entities for comments.

Kind Regards,

Thivhulawi

---

## APPENDICES

### SCOPING REPORT: Scoping and Environmental Impact Assessment (EIA) Process for the Proposed Development of a Solar Photovoltaic (PV) Facility (Kudu Solar Facility 8) and associated infrastructure, near De Aar, Northern Cape Province

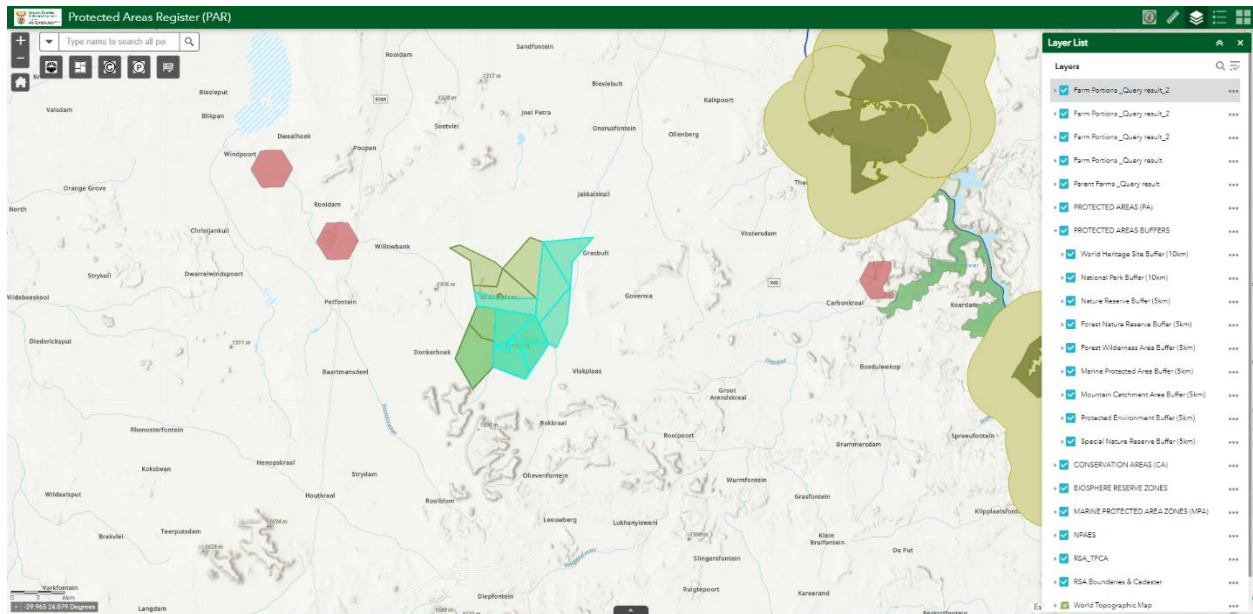

From: Thivhulawi Nethononda <[TNETHONONDA@dffe.gov.za](mailto:TNETHONONDA@dffe.gov.za)>

Sent: Wednesday, 18 January 2023 12:07

To: Lindokuhle Vilakati <[LVilakati@dffe.gov.za](mailto:LVilakati@dffe.gov.za)>

Subject: FW: Reminder - Availability of Draft Scoping Reports for Comment - Kudu Solar PV

Please review the attached documents

## APPENDICES

SCOPING REPORT: Scoping and Environmental Impact Assessment (EIA) Process for the Proposed Development of a Solar Photovoltaic (PV) Facility (Kudu Solar Facility 8) and associated infrastructure, near De Aar, Northern Cape Province

---

### 2. Comments received from the Northern Cape Department of Agriculture, Environmental Affairs, Rural Development and Land Reform

---

---

**From:** Natalie Uys <nuys.denc@gmail.com>  
**Sent:** Wednesday, 25 January 2023 13:31  
**To:** EMS  
**Subject:** Re: Reminder - Availability of Draft Scoping Reports for Comment - Kudu Solar PV - NCDAEARDLR Comment

**Categories:** This message has been archived by Retain on February 01 2023 18:59

Good afternoon Rohaida

Thank you for your email. We will reply to your question.  
Ito the developments, could you please provide me with the spatial kml/ gis file of the site

From: EMS <[ems@csir.co.za](mailto:ems@csir.co.za)>  
Date: Wed, 25 Jan 2023 at 14:05  
Subject: RE: Reminder - Availability of Draft Scoping Reports for Comment - Kudu Solar PV - NCDAEARDLR Comment  
To: Natalie Uys <[nuys.denc@gmail.com](mailto:nuys.denc@gmail.com)>  
Cc: EMS <[ems@csir.co.za](mailto:ems@csir.co.za)>

Dear Natalie

Thanks very much for your reply, it is appreciated.

Please see attached a KMZ of the study area for the 12 Kudu Solar Facilities.

We look forward to your feedback on the query below and whether the Department has any comments.

Thanks and kind regards,

Rohaida



## APPENDICES

### SCOPING REPORT: Scoping and Environmental Impact Assessment (EIA) Process for the Proposed Development of a Solar Photovoltaic (PV) Facility (Kudu Solar Facility 8) and associated infrastructure, near De Aar, Northern Cape Province

---

---

**From:** Natalie Uys <nuys.denc@gmail.com>  
**Sent:** Thursday, 02 February 2023 08:33  
**To:** EMS  
**Cc:** elsabe.dtec  
**Subject:** Re: Reminder - Availability of Draft Scoping Reports for Comment - Kudu Solar PV - NCDAEARDLR Comment  
**Attachments:** Comments\_Kudu\_DSR\_NU.pdf

Dear Rohida

My sincere apologies for the delay in my reply. I am still catching up on all the work and emails since being back from maternity leave.

Our EO who deals with the Pixley comments has left the department and it is currently just me giving comments on all the developments.

Please find attached general comments for your consideration on the proposed developments

I.t.o. your question regarding the CBA map, the CBA map has been adopted by our department as an environmental tool.

Best regards  
Natalie

## APPENDICES

### SCOPING REPORT: Scoping and Environmental Impact Assessment (EIA) Process for the Proposed Development of a Solar Photovoltaic (PV) Facility (Kudu Solar Facility 8) and associated infrastructure, near De Aar, Northern Cape Province

---



agriculture, environmental affairs,  
rural development and land reform

Department:  
agriculture, environmental affairs,  
rural development and land reform,  
NORTHERN CAPE PROVINCE  
REPUBLIC OF SOUTH AFRICA

#### Environmental Research and Development (ERD)

90 Long Street, Kimberley, Northern Cape, South Africa, 8300, Tel: (053) 807 7300

E-mail: [nuys.denc@gmail.com](mailto:nuys.denc@gmail.com), web: [www.agrinc.gov.za](http://www.agrinc.gov.za)

Date:	2 February 2023	File:	
To:	<a href="mailto:ems@csir.co.za">ems@csir.co.za</a>	From:	N Uys
Subject:	Availability of Draft Scoping Reports for Comment - Kudu Solar PV		

Rohaida Abed

CSIR Environmental Management Services

[ems@csir.co.za](mailto:ems@csir.co.za)

P.O. Box 59081, Umbilo, Durban, 4075

Tel: 031 242 2300

Fax: 031 261 8172

#### RE: Availability of Draft Scoping Reports for Comment - Kudu Solar PV

1. Please take note that these are general comments relating to the development footprint. Our capacity is severely limited at this stage to work through all the 12 x Kudu PV draft scoping reports and their appendices. In light of the before mentioned, would it be possible for you to please provide an overview document / presentation from the next phase of the project from results from the EIA studies showing environmental sensitivities and new layouts.
2. Please include Birdlife South Africa and Endangered Wildlife Trust (EWT) in your stakeholder list.
3. I.t.o. the question asked regarding the CBA, the Northern Cape Critical Biodiversity Areas Map has been accepted by the department as an environmental tool. The province currently does not have any bioregional plans.
4. Fauna and flora permits will be needed from the department for handling/ removing/ relocating/ destroying all specially protected and protected flora and fauna. Estimated numbers for species that need to be removed must be provided for permit approval.
5. *Boscia albitrunca* is protected under both the National Forest Act and under the Northern Cape Nature Conservation Act. Estimated densities must be calculated or the actual number of trees to be removed must be provided for permit purposes. Contact person for DFFE Forestry in the Northern Cape is Jacoline Mans, [jmans@dffe.gov.za](mailto:jmans@dffe.gov.za).
6. Please take note that *Olea europaea subsp. africana* is a protected tree under the Northern Cape Nature Conservation Act.
7. Alien and invasive species management must be done throughout the lifetime of the projects. Please take note that cacti species such as *Opuntia* spp cannot dumped at general waste sites without prior treatment (drying/ chemical). Please liaise with Dr Thabiso Mokotjomela, 073 324 6118, [mokotjomela@sanbi.org.za](mailto:mokotjomela@sanbi.org.za), on the management and disposal of cacti.
8. The availability of foundational and baseline data for the Northern Cape is limited and as a result the Screening Tool has limitations and shortcomings when assessing impacts for this area. Proper site surveys are for that reason critically important and always recommended.



## APPENDICES

### SCOPING REPORT: Scoping and Environmental Impact Assessment (EIA) Process for the Proposed Development of a Solar Photovoltaic (PV) Facility (Kudu Solar Facility 8) and associated infrastructure, near De Aar, Northern Cape Province

---

9. The initial vegetation map generated for the site reflects the limitations as mentioned before reflecting the gaps in the National Vegetation Map.
10. The 1km around the Verreux eagle nests are questioned in light of the associated power lines that will be constructed for the each of these PV developments. It is recommended that habitat fragmentation must be looked at during the assessment for this species. Verreux eagle habit mapping is also recommended. Please liaise with Birdlife South Africa in this regard, contact person Samantha Ralston-Paton, [energy@birdlife.org.za](mailto:energy@birdlife.org.za).
11. I.t.o. the terrestrial biodiversity please assess, mitigate and make provision for in the EMPR the following:
  - a. Please take note that tortoise populations are affected by the following:
    - i. electrocutions with electric fences.
    - ii. predations by crows – (relates to waste management).
  - b. Giant bull frogs were found in De Aar area in pans after the recent rains. Most of the injuries and mortalities to this species occurs from collision with vehicles when moving between their breeding sites (pans) and their burrows. Their burrows can range from 200m to 1km from the pans and they are capable of estivating underground for 7 years. Herbicide and pesticide use should also be restricted near the sites (Yetman, undated). Please liaise with EWT in this regard.
  - c. The following are concerns i.t.o. of the cumulative footprint of the 12 x PV's and should be assessed:
    - i. The heat island effect (local warming, impacts on reptiles etc.).
    - ii. Lake effect on birds (mortalities and injuries on birds) as the site is located in an Important Bird Area.
    - iii. Lake effect on insects (e.g. insects have been laying eggs on panels instead of pans).
    - iv. Insect mortalities (security lights at these sites at night attract insects).
    - v. Bat impacts (bats are attracted to by the security lights). Various bat species have been recorded around Vanderkloof and in De Aar.
12. In the EMPR, please make provision for the correct disposal and possible recycling of PV panels during construction, operation and closure phases. There have been cases in the past were broken panels arrived at the construction sites that were illegally disposed at a site in a burrow pit.

Yours sincerely



**N UYS**

**PRODUCTION SCIENTIST GRADE A: BOTANIST**

**ACTING SCIENTIFIC MANAGER GR B: RESEARCH AND DEVELOPMENT SUPPORT**

## APPENDICES

### SCOPING REPORT: Scoping and Environmental Impact Assessment (EIA) Process for the Proposed Development of a Solar Photovoltaic (PV) Facility (Kudu Solar Facility 8) and associated infrastructure, near De Aar, Northern Cape Province

---

---

**From:** EMS  
**Sent:** Thursday, 02 February 2023 09:06  
**To:** Natalie Uys  
**Cc:** elsabe.dtec; EMS  
**Subject:** RE: Reminder - Availability of Draft Scoping Reports for Comment - Kudu Solar PV - NCDAEARDLR Comment

Hi Natalie

I hope that you are well.

I appreciate your time and inputs into the Kudu DSR considering your work load. Thank you very much.

We will add your comments into the Comments and Responses Report and respond accordingly.

Thanks for your feedback on the legal status of the CBA Map and its implications for Listing Notice 3.

Your comment notes "I.t.o. the question asked regarding the CBA, the Northern Cape Critical Biodiversity Areas Map has been accepted by the department as an environmental tool. The province currently does not have any bioregional plans".

The majority of the activities that we included in the application relate to "systematic biodiversity plans adopted by the competent authority or in bioregional plans".

So now based on your comment, the bioregional plan does not apply. But since the CBA Map has been accepted by the Department, then it would meet the definition below in LN3 regarding systematic biodiversity plans? Is this correct? Therefore, the relevant triggers we have included in LN3 regarding CBAs and ESAs would still apply?

*"systematic biodiversity plan" is a plan that identifies important areas for biodiversity conservation, taking into account biodiversity patterns (i.e. the principle of representation) and the ecological and evolutionary processes that sustain them (i.e. the principle of persistence). A systematic biodiversity plan must set quantitative targets/thresholds for aquatic and terrestrial biodiversity features in order to conserve a representative sample of biodiversity pattern and ecological processes;*

Apologies for this last query.

We look forward to your feedback.

Kind Regards,  
Rohaida

---

## APPENDICES

### SCOPING REPORT: Scoping and Environmental Impact Assessment (EIA) Process for the Proposed Development of a Solar Photovoltaic (PV) Facility (Kudu Solar Facility 8) and associated infrastructure, near De Aar, Northern Cape Province

---

---

**From:** Natalie Uys <nuys.denc@gmail.com>  
**Sent:** Friday, 03 February 2023 16:34  
**To:** EMS  
**Cc:** elsabe.dtec  
**Subject:** Feedback: NC CBA map - Systematic biodiversity plan L3

Dear Rohieda

Thank you for the consideration of our comments.

I had to double check our documents and liaise with our biodiversity planner regarding your question, therefore delay in my reply.

You provided the following definition from L3:

*"systematic biodiversity plan" is a plan that identifies important areas for biodiversity conservation, taking into account biodiversity patterns (i.e. the principle of representation) and the ecological and evolutionary processes that sustain them (i.e. the principle of persistence). A systematic biodiversity plan must set quantitative targets/thresholds for aquatic and terrestrial biodiversity features in order to conserve a representative sample of biodiversity pattern and ecological processes;"*

Our CBA map was signed off by the head of the department as an *"instrument for informing decisions and priorities on biodiversity"*. Based on the above definition of a systematic biodiversity plan, our CBA map meets both the criterias as important biodiversity areas were identified and targets for both terrestrial and freshwater systems were determined (Holness & Oosthuysen, 2016). Thus, the triggers we mentioned for LN3 regarding CBAs and ESAs would still apply.

Best regards  
Natalie

Reference:

Holness, S., & Oosthuysen, E. (2016). Critical Biodiversity Areas of the Northern Cape : Technical Report.

## APPENDICES

SCOPING REPORT: Scoping and Environmental Impact Assessment (EIA) Process for the Proposed Development of a Solar Photovoltaic (PV) Facility (Kudu Solar Facility 8) and associated infrastructure, near De Aar, Northern Cape Province

---

### 3. Comments received from Eskom

---

---

From: John Geeringh <GeerinJH@eskom.co.za>

Sent: Tuesday, 17 January 2023 12:45

To: EMS <ems@csir.co.za>

Subject: RE: [CAUTION:EXTERNAL EMAIL] - Reminder - Availability of Draft Scoping Reports for Comment - Kudu Solar PV

Please send me KMZ files of the affected properties, proposed layouts and proposed grid connection. Please find attached Eskom requirements for work at or near Eskom infrastructure and servitudes, as well as a renewable energy setbacks guideline.

Kind regards

John Geeringh (Pr Sci Nat) Reg. EAP (EAPASA)  
Senior Consultant Environmental Management  
Grid Planning: Land and Rights  
Eskom Transmission Division  
Megawatt Park, D1Y42, Maxwell Drive, Sunninghill, Sandton.  
P O Box 1091, Johannesburg, 2000.  
Tel: [REDACTED]  
Cell: [REDACTED]  
Fax: 086 661 4064  
E-mail: [john.geeringh@eskom.co.za](mailto:john.geeringh@eskom.co.za)

## APPENDICES

SCOPING REPORT: Scoping and Environmental Impact Assessment (EIA) Process for the Proposed Development of a Solar Photovoltaic (PV) Facility (Kudu Solar Facility 8) and associated infrastructure, near De Aar, Northern Cape Province

---

### TO WHOM IT MAY CONCERN

#### Eskom requirements for work in or near Eskom servitudes.

1. Eskom's rights and services must be acknowledged and respected at all times.
2. Eskom shall at all times retain unobstructed access to and egress from its servitudes.
3. Eskom's consent does not relieve the developer from obtaining the necessary statutory, land owner or municipal approvals.
4. Any cost incurred by Eskom as a result of non-compliance to any relevant environmental legislation will be charged to the developer.
5. If Eskom has to incur any expenditure in order to comply with statutory clearances or other regulations as a result of the developer's activities or because of the presence of his equipment or installation within the servitude restriction area, the developer shall pay such costs to Eskom on demand.
6. The use of explosives of any type within 500 metres of Eskom's services shall only occur with Eskom's previous written permission. If such permission is granted the developer must give at least fourteen working days prior notice of the commencement of blasting. This allows time for arrangements to be made for supervision and/or precautionary instructions to be issued in terms of the blasting process. It is advisable to make application separately in this regard.
7. Changes in ground level may not infringe statutory ground to conductor clearances or statutory visibility clearances. After any changes in ground level, the surface shall be rehabilitated and stabilised so as to prevent erosion. The measures taken shall be to Eskom's satisfaction.
8. Eskom shall not be liable for the death of or injury to any person or for the loss of or damage to any property whether as a result of the encroachment or of the use of the servitude area by the developer, his/her agent, contractors, employees, successors in title, and assignees. The developer indemnifies Eskom against loss, claims or damages including claims pertaining to consequential damages by third parties and whether as a result of damage to or interruption of or interference with Eskom's services or apparatus or otherwise. Eskom will not be held responsible for damage to the developer's equipment.
9. No mechanical equipment, including mechanical excavators or high lifting machinery, shall be used in the vicinity of Eskom's apparatus and/or services, without prior written permission having been granted by Eskom. If such permission is granted the developer must give at least seven working days' notice prior to the commencement of work. This allows time for arrangements to be made for supervision and/or precautionary instructions to be issued by the relevant Eskom Manager Note: Where and electrical outage is required, at least fourteen work days are required to arrange it.
10. Eskom's rights and duties in the servitude shall be accepted as having prior right at all times and shall not be obstructed or interfered with.

## APPENDICES

SCOPING REPORT: Scoping and Environmental Impact Assessment (EIA) Process for the Proposed Development of a Solar Photovoltaic (PV) Facility (Kudu Solar Facility 8) and associated infrastructure, near De Aar, Northern Cape Province

---

11. Under no circumstances shall rubble, earth or other material be dumped within the servitude restriction area. The developer shall maintain the area concerned to Eskom's satisfaction. The developer shall be liable to Eskom for the cost of any remedial action which has to be carried out by Eskom.
12. The clearances between Eskom's live electrical equipment and the proposed construction work shall be observed as stipulated by *Regulation 15 of the Electrical Machinery Regulations of the Occupational Health and Safety Act, 1993 (Act 85 of 1993)*.
13. Equipment shall be regarded electrically live and therefore dangerous at all times.
14. In spite of the restrictions stipulated by Regulation 15 of the Electrical Machinery Regulations of the Occupational Health and Safety Act, 1993 (Act 85 of 1993), as an additional safety precaution, Eskom will not approve the erection of houses, or structures occupied or frequented by human beings, under the power lines or within the servitude restriction area.
15. Eskom may stipulate any additional requirements to highlight any possible exposure to Customers or Public to coming into contact or be exposed to any dangers of Eskom plant.
16. It is required of the developer to familiarise himself with all safety hazards related to Electrical plant.
17. Any third party servitudes encroaching on Eskom servitudes shall be registered against Eskom's title deed at the developer's own cost. If such a servitude is brought into being, its existence should be endorsed on the Eskom servitude deed concerned, while the third party's servitude deed must also include the rights of the affected Eskom servitude.

John Geeringh (Pr Sci Nat)(EAPASA)  
Senior Consultant Environmental Management  
Eskom Transmission Division: Land & Rights  
Megawatt Park, D1Y42, Maxwell Drive, Sunninghill, Sandton.  
P O Box 1091, Johannesburg, 2000.  
Tel: [REDACTED]  
Cell: [REDACTED]  
Fax: 086 661 4064  
E-mail: john.geeringh@eskom.co.za



## APPENDICES

SCOPING REPORT: Scoping and Environmental Impact Assessment (EIA) Process for the Proposed Development of a Solar Photovoltaic (PV) Facility (Kudu Solar Facility 8) and associated infrastructure, near De Aar, Northern Cape Province

---

	<b>SCOT</b>	<b>Technology</b>
---	-------------	-------------------

Title: **Renewable Energy Generation Plant Setbacks to Eskom Infrastructure** Unique Identifier: **240-65559775**

Alternative Reference Number: **N/A**

Area of Applicability: **Power Line Engineering**

Documentation Type: **Guideline**

Revision: **2**

Total Pages: **9**

Next Review Date: **N/A**

Disclosure Classification: **CONTROLLED DISCLOSURE**

---

Compiled by	Approved by	Authorised by
		
<b>J W Chetty</b> Mechanical Engineer	<b>B Ntshuntsha</b> Chief Engineer (Lines)	<b>R A Vajeth</b> Snr Manager (Lines) and SCOT/SC/ Chairperson
Date: 15/09/2020	Date: 30/10/2020	Date: 30/10/2020

---

## APPENDICES

### SCOPING REPORT: Scoping and Environmental Impact Assessment (EIA) Process for the Proposed Development of a Solar Photovoltaic (PV) Facility (Kudu Solar Facility 8) and associated infrastructure, near De Aar, Northern Cape Province

---

**Renewable Energy Generation Plant Setbacks to Eskom Infrastructure**

Unique Identifier: **240-65559775**  
Revision: **2**  
Page: **2 of 9**

---

## CONTENTS

	<b>Page</b>
<b>EXECUTIVE SUMMARY</b> .....	<b>3</b>
<b>1. INTRODUCTION</b> .....	<b>4</b>
<b>2. SUPPORTING CLAUSES</b> .....	<b>4</b>
2.1 SCOPE .....	4
2.1.1 Purpose .....	5
2.1.2 Applicability .....	5
2.2 NORMATIVE/INFORMATIVE REFERENCES .....	5
2.2.1 Normative .....	5
2.2.2 Informative .....	5
2.3 DEFINITIONS .....	6
2.3.1 Disclosure Classification .....	6
2.4 ABBREVIATIONS .....	6
2.5 ROLES AND RESPONSIBILITIES .....	6
2.6 PROCESS FOR MONITORING .....	6
2.7 RELATED/SUPPORTING DOCUMENTS .....	6
<b>3. DOCUMENT CONTENT</b> .....	<b>6</b>
3.1 INTERNATIONAL SETBACK COMPARISON .....	6
3.2 ESKOM REQUIRED SETBACKS .....	7
<b>4. AUTHORISATION</b> .....	<b>9</b>
<b>5. REVISIONS</b> .....	<b>9</b>
<b>6. DEVELOPMENT TEAM</b> .....	<b>9</b>

## FIGURES

Figure 1: Horizontal Axis Wind Turbine .....	8
--	---

### **CONTROLLED DISCLOSURE**

When downloaded from the EDMS, this document is uncontrolled and the responsibility rests with the user to ensure it is in line with the authorised version on the system.

## APPENDICES

### SCOPING REPORT: Scoping and Environmental Impact Assessment (EIA) Process for the Proposed Development of a Solar Photovoltaic (PV) Facility (Kudu Solar Facility 8) and associated infrastructure, near De Aar, Northern Cape Province

---

**Renewable Energy Generation Plant Setbacks to Eskom Infrastructure**

Unique Identifier: **240-65559775**  
Revision: **2**  
Page: **3 of 9**

---

#### EXECUTIVE SUMMARY

In recent decades, the use of wind turbines, concentrated solar plants and photovoltaic plants have been on the increase as it serves as an abundant source of energy. This document specifies proposed setbacks for wind turbines and the reasons for these setbacks from infrastructure as well as setbacks for concentrated solar plants and photovoltaic plants. Setbacks for wind turbines employed in other countries were compared and a general setback to be used by Eskom was suggested for use with wind turbines and other renewable energy generation plants.

#### **CONTROLLED DISCLOSURE**

When downloaded from the EDMS, this document is uncontrolled and the responsibility rests with the user to ensure it is in line with the authorised version on the system.

## APPENDICES

### SCOPING REPORT: Scoping and Environmental Impact Assessment (EIA) Process for the Proposed Development of a Solar Photovoltaic (PV) Facility (Kudu Solar Facility 8) and associated infrastructure, near De Aar, Northern Cape Province

---

#### Renewable Energy Generation Plant Setbacks to Eskom Infrastructure

Unique Identifier: 240-65559775  
Revision: 2  
Page: 4 of 9

---

## 1. INTRODUCTION

During the last few decades, a large amount of wind turbines have been installed in wind farms to accommodate for the large demand of energy and depleting fossil fuels. Wind is one of the most abundant sources of renewable energy. Wind turbines harness the energy of this renewable resource for integration in electricity networks. The extraction of wind energy is its primary function and thus the aerodynamics of the wind turbine is important. There are many different types of wind turbines which will all exhibit different wind flow characteristics. The most common wind turbine used commercially is the Horizontal Axis Wind Turbine. Wind flow characteristics of this turbine are important to analyse as it may have an effect on surrounding infrastructure.

Wind turbines also cause large turbulence downwind that may affect existing infrastructure. Debris or parts of the turbine blade, in the case of a failure, may be tossed behind the turbine and may lead to damage of infrastructure in the wake path.

This document outlines the minimum distances that need to be introduced between a wind turbine and Eskom infrastructure to ensure that debris and / or turbulence would not negatively impact on the infrastructure and future expansion of infrastructure (lines and substation) as per the long term planning scenario.

Safety distances of wind turbines from other structures as implemented by other countries were also considered and the reasons for their selection were noted. All renewable energy developments are approved by The Department of Environmental Affairs, Forestry and Fisheries (DEFF) in terms of NEMA. The DEFF is aware of the setbacks guideline, however they cannot use it in terms of decision making since the setbacks document has no legal standing in SA and it would be outside of their mandate who have been advised to follow the guidelines herein.

Concentrated solar plants and photovoltaic plants setbacks away from substations were also to be considered to prevent restricting possible power line access routes to the substation and possible expansion of substations.

## 2. SUPPORTING CLAUSES

### 2.1 SCOPE

This document provides guidance on the safe distance that a wind turbine should be located from any Eskom power line or substation. Although it is not based on any legislative requirement, it is deemed important that Eskom's infrastructure and future network expansion planning is not impeded. The document specifies proposed setback distances for transmission lines (220 kV to 765 kV), distribution lines

#### CONTROLLED DISCLOSURE

When downloaded from the EDMS, this document is uncontrolled and the responsibility rests with the user to ensure it is in line with the authorised version on the system.

## APPENDICES

### SCOPING REPORT: Scoping and Environmental Impact Assessment (EIA) Process for the Proposed Development of a Solar Photovoltaic (PV) Facility (Kudu Solar Facility 8) and associated infrastructure, near De Aar, Northern Cape Province

---

#### Renewable Energy Generation Plant Setbacks to Eskom Infrastructure

Unique Identifier: 240-65559775  
Revision: 2  
Page: 5 of 9

---

(66 kV to 132 kV) and all Eskom substations. Proposed setbacks for concentrated solar plants and photovoltaic plants are also specified away from substations.

#### 2.1.1 Purpose

Setbacks for wind turbines and power lines / substations are required for various reasons. These include possible catastrophic failure of the turbine blade that may release fragments and which may be thrown onto nearby power lines that may result in damage with associated unplanned outages. Turbulence behind the turbine may affect helicopter flight during routine Eskom live line maintenance and inspections that may lead to safety risk of the aircraft / personnel. Concentrated solar plants and photovoltaic plants setback away from substations were required to prevent substations from being boxed in by these renewable generation plants limiting line route access to the substations and possible future substation expansion.

#### 2.1.2 Applicability

This document is applicable to the siting of all new and existing wind turbines, concentrated solar plants and photovoltaic plants near power lines and substations and in line of site between Eskom telecommunication infrastructure, including future Eskom renewable energy development.

### 2.2 NORMATIVE/INFORMATIVE REFERENCES

#### 2.2.1 Normative

1. <http://www.envir.ee/orb.aw/class=file/action=preview/id=1170403/Hiumaa+turbulence+impact+EMD.pdf>
2. <http://www.energy.ca.gov/2005publications/CEC-500-2005-184/CEC-500-2005-184.PDF>
3. <http://www.adamscountywind.com/Revised%20Site/Windmills/Adams%20County%20Ordinance/Adams%20County%20Wind%20Ord.htm>
4. [http://www.dsireusa.org/incentives/incentive.cfm?Incentive\\_Code=PA11R&RE=1&EE=1](http://www.dsireusa.org/incentives/incentive.cfm?Incentive_Code=PA11R&RE=1&EE=1)
5. <http://www.wind-watch.org/documents/european-setbacks-minimum-distance-between-wind-turbines-and-habitations/>
6. <http://www.publications.parliament.uk/pa/ld201011/ldbills/017/11017.1-i.html>
7. [http://www.caw.ca/assets/pdf/Turbine\\_Safety\\_Report.pdf](http://www.caw.ca/assets/pdf/Turbine_Safety_Report.pdf)
8. Rogers J, Slegers N, Costello M. (2011) A method for defining wind turbine setback standards. Wind energy 10.1002/we.468

#### 2.2.2 Informative

None

#### CONTROLLED DISCLOSURE

When downloaded from the EDMS, this document is uncontrolled and the responsibility rests with the user to ensure it is in line with the authorised version on the system.

## APPENDICES

### SCOPING REPORT: Scoping and Environmental Impact Assessment (EIA) Process for the Proposed Development of a Solar Photovoltaic (PV) Facility (Kudu Solar Facility 8) and associated infrastructure, near De Aar, Northern Cape Province

---

**Renewable Energy Generation Plant Setbacks to Eskom Infrastructure**

Unique Identifier: **240-65559775**  
Revision: **2**  
Page: **6 of 9**

---

#### 2.3 DEFINITIONS

Definition	Description
Setback	The minimum distance between a wind turbine and boundary line/dwelling/road/infrastructure/servitude etc.
Flicker	Effect caused when rotating wind turbine blades periodically cast shadows
Tip Height	The total height of the wind turbine ie. Hub height plus half rotor diameter (see Figure1)

##### 2.3.1 Disclosure Classification

**Controlled disclosure:** controlled disclosure to external parties (either enforced by law, or discretionary).

#### 2.4 ABBREVIATIONS

Abbreviation	Description
None	

#### 2.5 ROLES AND RESPONSIBILITIES

All parties involved in the positioning wind turbines, concentrated solar plants and photovoltaic plants near power lines/substations should endeavour to follow the setbacks outlined in this guideline.

#### 2.6 PROCESS FOR MONITORING

Agreement by Eskom in writing on any encroachment of the setbacks distance should be requested via the Grid Access Unit. Eskom should ensure that every application for renewable energy (RE) developments are informed about the existence of the setbacks document early in the RE planning process to ensure maximum effect. This includes Eskom RE development.

#### 2.7 RELATED/SUPPORTING DOCUMENTS

None

### 3. DOCUMENT CONTENT

#### 3.1 INTERNATIONAL SETBACK COMPARISON

Wind Turbine setbacks employed by various countries were considered. It was found that setbacks were determined for various reasons that include noise, flicker, turbine blade failure and wind effects as well as

#### **CONTROLLED DISCLOSURE**

When downloaded from the EDMS, this document is uncontrolled and the responsibility rests with the user to ensure it is in line with the authorised version on the system.

## APPENDICES

### SCOPING REPORT: Scoping and Environmental Impact Assessment (EIA) Process for the Proposed Development of a Solar Photovoltaic (PV) Facility (Kudu Solar Facility 8) and associated infrastructure, near De Aar, Northern Cape Province

---

#### Renewable Energy Generation Plant Setbacks to Eskom Infrastructure

Unique Identifier: 240-65559775  
Revision: 2  
Page: 7 of 9

---

future network expansion planning. The distances (setbacks) varied based on these factors and were influenced by the type of infrastructure

Wind turbine setbacks varied for roads, power lines, dwellings, buildings and property and it was noted that the largest setbacks were employed for reasons of noise and flicker related issues [1-7]. Very few countries specified setbacks for power lines.

The literature survey [1-7], yielded information about studies and experiments were conducted to determine the distance that a broken fragment from a wind turbine might be thrown. Even though of low probability of hitting a power line [ $5.0 \times 10^{-5}$ ]<sup>[8]</sup>, the distances recorded were significant [750m]<sup>[8]</sup>

Wind turbines may also cause changes in wind patterns with turbulent effects behind the hub. These factors influence the wind turbine setbacks specified in this document.

Setbacks were thus introduced to prevent any damage to Eskom infrastructure and impedance to operation and future network expansion planning.

Renewable energy plant can also limit access into substations for power lines of all voltages. A setback distance should therefore be employed to prevent substations from being boxed in by these generation plants and preventing future network expansion. These setback distances are specified in this document.

#### 3.2 ESKOM RECOMMENDED SETBACKS

Any renewable energy applicant should engage with Eskom to determine if their plant layout or positioning of turbines, CSP or PV infrastructure would encroach on the proposed setbacks provided for in this guideline and to ensure that their planning and Eskom's future expansion planning is taken into account. Eskom must inform all renewable energy developers, including Eskom RE, of the existence of the setbacks guideline early in the development process. Should there be an encroachment, a formal request should be sent to and accepted by Eskom in writing if any of the below mentioned setback distances are infringed upon:

- Eskom requests a setback distance of 3 times the tip height of the wind turbine from the edge of the closest Eskom servitude (including vacant servitudes) for transmission lines (220kV to 765kV) and Substations.
- Eskom requests a setback distance of 1 times the tip height of the wind turbine from the edge of the closest Eskom servitude (including vacant servitudes) for distribution lines (66 kV to 132 kV) and Substations.

#### CONTROLLED DISCLOSURE

When downloaded from the EDMS, this document is uncontrolled and the responsibility rests with the user to ensure it is in line with the authorised version on the system.

## APPENDICES

### SCOPING REPORT: Scoping and Environmental Impact Assessment (EIA) Process for the Proposed Development of a Solar Photovoltaic (PV) Facility (Kudu Solar Facility 8) and associated infrastructure, near De Aar, Northern Cape Province

---

#### Renewable Energy Generation Plant Setbacks to Eskom Infrastructure

Unique Identifier: 240-65559775  
Revision: 2  
Page: 8 of 9

---

- A written request should be sent to Eskom via the Grid Access Unit regarding any proposed wind turbine, concentrated solar plants and photovoltaic activity within a 5 km radius of a substation for Eskom to comment on.
- Where concentrated solar plants, photovoltaic structures, battery storage systems (BESS) and other renewable generation plants fall within a 2 km radius of the closest point of a transmission or distribution substation (66kV to 765kV), a written agreement with Eskom is recommended during the planning phase of such plant or structures to ensure Eskom's future planning is not impeded.
- Applicants should not position any wind turbine in the line of site between and two Eskom Radio Telecommunication masts. It should be proven that Eskom radio telecommunication systems (mainly microwave systems) will not be affected in any way by wind turbines due to the criticality of this infrastructure in terms of network operation. Eskom Telecommunications should be engaged on this matter.
- If the position or size of any turbine changes and subsequently infringes on any of the above stated setbacks, a request for relaxation must be sent through to Eskom as per the point mentioned above.

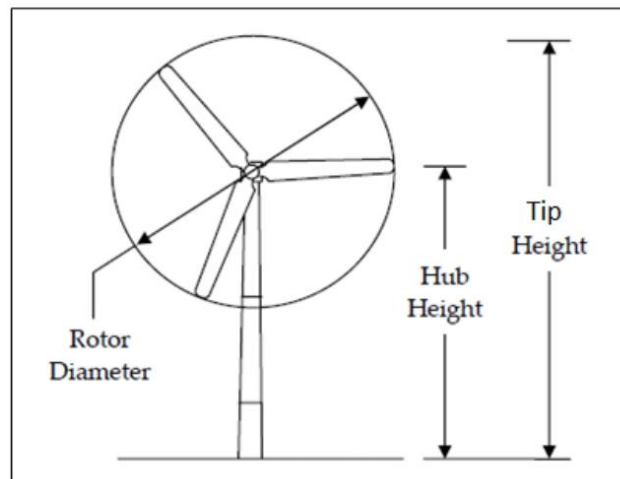

Figure 1: Horizontal Axis Wind Turbine <sup>[2]</sup>

#### CONTROLLED DISCLOSURE

When downloaded from the EDMS, this document is uncontrolled and the responsibility rests with the user to ensure it is in line with the authorised version on the system.



## APPENDICES

### SCOPING REPORT: Scoping and Environmental Impact Assessment (EIA) Process for the Proposed Development of a Solar Photovoltaic (PV) Facility (Kudu Solar Facility 8) and associated infrastructure, near De Aar, Northern Cape Province

---

**Renewable Energy Generation Plant Setbacks to Eskom Infrastructure**

Unique Identifier: **240-65559775**  
Revision: **2**  
Page: **9 of 9**

---

#### 4. AUTHORISATION

This document has been seen and accepted by:

Name & Surname	Designation
V Naidoo	Chief Engineer
Dr P Pretorius	Electrical Specialist
J Geeringh	Snr Consultant Environ Mngt
B Haridass	Snr Consultant Engineer
B Ntshuntsha	Chief Engineer
R Vajeth	Snr Manager (Lines)
D A Tunncliff	Snr Manager L&R (Acting)
B Branfield	Snr Consultant Engineer

#### 5. REVISIONS

Date	Rev.	Compiler	Remarks
November 2013	0	J W Chetty	First Publication - No renewable energy generation plant setback specification in existence.
October 2018	1	JW Chetty	Modification to sub-section 3.2 to provide more clarity for application procedure.
June 2020	2	JW Chetty	Content within the guideline was re-worded to explain the benefits of mutual agreements between the applicants and ESKOM rather than the application being a legal obligation.

#### 6. DEVELOPMENT TEAM

The following people were involved in the development of this document:

Jonathan Chetty (Mechanical Engineer)  
Vivendhra Naidoo (Chief Engineer)  
Dr Pieter Pretorius (Electrical Specialist)  
John Geeringh (Snr Consultant Environ Mngt)  
Bharat Haridass (Snr Consultant Engineer)  
Riaz Vajeth (Snr Manager (Lines))  
Bruce Ntshuntsha (Chief Engineer)  
David Tunncliff (Snr Manager L&R Acting)

#### CONTROLLED DISCLOSURE

When downloaded from the EDMS, this document is uncontrolled and the responsibility rests with the user to ensure it is in line with the authorised version on the system.

## APPENDICES

SCOPING REPORT: Scoping and Environmental Impact Assessment (EIA) Process for the Proposed Development of a Solar Photovoltaic (PV) Facility (Kudu Solar Facility 8) and associated infrastructure, near De Aar, Northern Cape Province

---

---

**From:** EMS  
**Sent:** Wednesday, 25 January 2023 11:28  
**To:** John Geeringh  
**Cc:** EMS  
**Subject:** RE: [CAUTION:EXTERNAL EMAIL] - Reminder - Availability of Draft Scoping Reports for Comment - Kudu Solar PV  
**Attachments:** RE: Proposed Kudu PV and EGI Project - Eskom Hydra B Substation; 2022-10-27\_Kudu PV1-12.kmz; 2021\_11\_03\_Land\_portions.kmz; 2022-11-30\_Proposed\_EGI Corridor.kml  
**Categories:** This message has been archived by Retain on February 01 2023 19:00

Dear John

I hope that you are well. All the best for 2023.

The Eskom requirements for work at or near Eskom infrastructure and servitudes, as well as a renewable energy setbacks guideline has been forwarded to the Developer for consideration.

Please see attached previous communication we had regarding this project.

Please also see attached the following KMZs:

1. Proposed layouts (revised scoping buildable areas) to be taken into the EIA Phase.
2. Affected properties.
3. Proposed EGI corridors. The EGI corridor will be subjected to separate BA / Standard Registration processes. The Kudu Solar Facilities 1 to 12 are currently being undertaken for now.

Please let us know if you have any feedback on the proposed Hydra B Substation location?

Thanks and kind regards,  
Rohaida Abed

CSIR Environmental Management Services  
E-mail: [ems@csir.co.za](mailto:ems@csir.co.za)  
Postal Address: P.O. Box 59081, Umbilo, Durban, 4075  
Tel: 031 242 2300

## APPENDICES

SCOPING REPORT: Scoping and Environmental Impact Assessment (EIA) Process for the Proposed Development of a Solar Photovoltaic (PV) Facility (Kudu Solar Facility 8) and associated infrastructure, near De Aar, Northern Cape Province

---

### 4. Comments received from Telkom: Kudu Solar Facility 8 (Telkom Ref No. CPLT0804-22)

---

**From:** Chris Schutte (CE) <SchutCE5@telkom.co.za>  
**Sent:** Monday, 19 December 2022 16:25  
**To:** EMS  
**Subject:** FW: CPLT0804-22 Kudu Solar Facility 8

**Categories:** This message has been archived by Retain on December 26 2022 19:24

Good day

Hereby do we acknowledge your proposed project.

For future reference please quote CPLT0804-22.

Kind regards

Chris Schutte  
Mvelaphande Trading  
[SchutCE5@telkom.co.za](mailto:SchutCE5@telkom.co.za)  
078 741 5862

==== This e-mail and its contents are subject to the Telkom SA SOC Ltd. E-mail legal notice  
<http://www.telkom.co.za/TelkomEMailLegalNotice.PDF> =====

## APPENDICES

SCOPING REPORT: Scoping and Environmental Impact Assessment (EIA) Process for the Proposed Development of a Solar Photovoltaic (PV) Facility (Kudu Solar Facility 8) and associated infrastructure, near De Aar, Northern Cape Province

---

---

**From:** Chris Schutte (CE) <SchutCE5@telkom.co.za>  
**Sent:** Monday, 16 January 2023 16:55  
**To:** EMS  
**Cc:** Vivian Groenewald (VR)  
**Subject:** CPLT0804-22 Kudu Solar Facility 8  
**Attachments:** CPLT0804-22 COVER LETTER TO AUTH.pdf; CPLT0804-22 UPDATED SKETCH.pdf

**Categories:** This message has been archived by Retain on January 23 2023 21:25

Good day

With reference to your above- mentioned application, I hereby confirm that the proposed work installation is approved in terms of Section 29 of the Electronic Communications Act No. 36 of 2005 as amended.

No infrastructure of our Client (Openserve) will be affected by this proposal. **We did our utmost to ensure that we indicate our route as accurate as possible and should you discover any of our cables that is not on the sketch please stop and contact us immediately to arrange a site meeting. In the event that our cables are exposed and damaged/stolen by a third party the damages will be repaired at the customer's account. Please make use of pilot holes in order not too damage our infrastructure.** Therefore any damages occurred during construction of work will be repaired at the customer's account.

**Although we are not affected by this proposal, Mr Vivian Groenewald must be contacted at telephone number [REDACTED] [REDACTED] from our Network Field Services. Two (2) weeks prior to commencement of proposed work.**

Approval of the proposed route is valid for six months. If construction has not yet commenced within this period, then the file must be resubmitted for approval.

Kind regards

Chris Schutte  
Mvelaphande Trading  
[SchutCE5@telkom.co.za](mailto:SchutCE5@telkom.co.za)  
078 741 5862

==== This e-mail and its contents are subject to the Telkom SA SOC Ltd. E-mail legal notice  
<http://www.telkom.co.za/TelkomEMailLegalNotice.PDF> =====

## APPENDICES

### SCOPING REPORT: Scoping and Environmental Impact Assessment (EIA) Process for the Proposed Development of a Solar Photovoltaic (PV) Facility (Kudu Solar Facility 8) and associated infrastructure, near De Aar, Northern Cape Province

---



**Mvelaphande Trading**  
**P/A C Schutte**  
**3 La Motte Street**  
**Bayswater**  
**Bloemfontein**  
**9301**

**Enquiries:** Chris Schutte  
**Telephone:** 078 741 5862  
**E-mail:** Schutce5@telkom.co.za

Our Ref no: CPLT0804-22

Your Ref: **Kudu Solar Facility 8**

16 January 2023

**CSIR Environmental Management Services**  
PO Box 395  
Pretoria  
0001

**FOR ATTENTION:** Rohaida Abed

**RE: NOTIFICATION OF THE RELEASE OF DRAFT SCOPING REPORTS FOR A 30-DAY COMMENT PERIOD FOR THE PROPOSED DEVELOPMENT OF 12 SOLAR PHOTOVOLTAIC (PV) FACILITIES (I.E. KUDU SOLAR FACILITIES) AND VARIOUS ASSOCIATED INFRASTRUCTURE, NEAR DE AAR, NORTHERN CAPE**

With reference to your above- mentioned application, I hereby confirm that the proposed work installation is approved in terms of Section 29 of the Electronic Communications Act No. 36 of 2005 as amended.

No infrastructure of our Client (Openserve) will be affected by this proposal. **We did our utmost to ensure that we indicate our route as accurate as possible and should you discover any of our cables that is not on the sketch please stop and contact us immediately to arrange a site meeting. In the event that our cables are exposed and damaged/stolen by a third party the damages will be repaired at the customer's account. Please make use of pilot holes in order not too damage our infrastructure.** Therefore any damages occurred during construction of work will be repaired at the customer's account.

**Although we are not affected by this proposal, Mr Vivian Groenewald must be contacted at telephone number [REDACTED] from our Network Field Services. Two (2) weeks prior to commencement of proposed work.**

Approval of the proposed route is valid for six months. If construction has not yet commenced within this period, then the file must be resubmitted for approval.

Any changes/deviations from the original planning during or prior to construction must immediately be communicated to this office.

Mvelaphande Trading Reg No: 2002-029553-23  
Members: Bopape P. M ; Makgakge M.G

## APPENDICES

### SCOPING REPORT: Scoping and Environmental Impact Assessment (EIA) Process for the Proposed Development of a Solar Photovoltaic (PV) Facility (Kudu Solar Facility 8) and associated infrastructure, near De Aar, Northern Cape Province

---

**On completion of this project, please certify that all requirements as stipulated in this letter have been met. Please note that should any of our Client (Openserve) infrastructure has to be relocated or altered as a result of your activities the cost for such alteration or relocation will be for your account in terms of section 25 of the Electronic Communication Act.**

**Mr Vivian Groenewald must be contacted at telephone number [REDACTED]. Two (2) weeks prior to commencement of proposed work. It's important that all services are shown on site before construction starts.**

Approval of the proposed route is valid for six months. If construction has not yet commenced within this period, then the file must be resubmitted for approval. Any changes / deviations from the original planning during or prior to construction must immediately be communicated to this office.

Please notify this office and forward an as built plan, within 30 days of completion of construction.

**Mr Vivian Groenewald must be contacted at telephone number 081 362 6738. Two (2) weeks prior to commencement of proposed work. It's important that all services are shown on site before construction starts.**

Yours sincerely



CHRIS SCHUTTE

## APPENDICES

### SCOPING REPORT: Scoping and Environmental Impact Assessment (EIA) Process for the Proposed Development of a Solar Photovoltaic (PV) Facility (Kudu Solar Facility 8) and associated infrastructure, near De Aar, Northern Cape Province

SCOPING REPORT: Scoping and Environmental Impact Assessment (EIA) Process for the Proposed Development of a Solar Photovoltaic (PV) Facility (Kudu Solar Facility 1) and associated infrastructure, near De Aar, Northern Cape Province C:\PLT\014-22

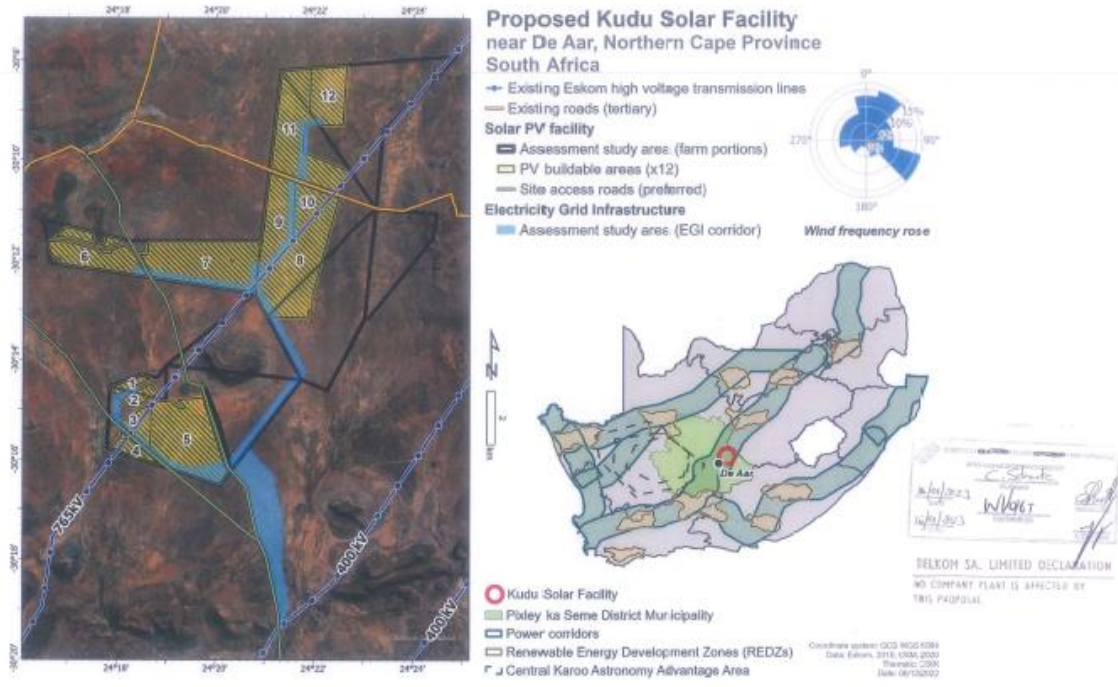

Figure 1.2: Locality map for the proposed Kudu Solar Facilities 1 to 12 and EGI near De Aar in the Northern Cape. Note that the EGI Projects are not part of the current application and report. The EGI Projects will be considered separately at a later stage. The EGI corridor indicated in this Figure is indicative.

## APPENDICES

SCOPING REPORT: Scoping and Environmental Impact Assessment (EIA) Process for the Proposed Development of a Solar Photovoltaic (PV) Facility (Kudu Solar Facility 8) and associated infrastructure, near De Aar, Northern Cape Province

---

### 5. Comments received from the South African Heritage Resources Agency (SAHRA)

---

---

From: Rohaida Abed <[RAbed@csir.co.za](mailto:RAbed@csir.co.za)>  
Sent: 09 December 2022 15:21  
To: Natasha Higgitt <[nhiggitt@sahra.org.za](mailto:nhiggitt@sahra.org.za)>  
Subject: Kudu Solar PV Draft Scoping Reports

Hi Natasha

Hope you are well.

Just wanted to check in about the separate cases for our Kudu project (interim comments attached).

Please let me know if we can only upload the main report and the Scoping Level Heritage Inputs, and the Scoping Level Palaeo Inputs?

Or do we need to upload all appendices as well? There are quite a lot of files though, so just checking if we can streamline the upload to SAHRIS in anyway?

Thanks  
Rohaida

---

From: Natasha Higgitt <[nhiggitt@sahra.org.za](mailto:nhiggitt@sahra.org.za)>  
Sent: Friday, 09 December 2022 15:30  
To: Rohaida Abed <[RAbed@csir.co.za](mailto:RAbed@csir.co.za)>  
Subject: RE: Kudu Solar PV Draft Scoping Reports

[The e-mail server of the sender failed SPF checks and maybe malicious (SPF Record)]  
Hi there,

Upload the DSR and I will have a look at what appendices you have. I will let you know what we need after that.

Reports that we will definitely need are Social, Visual, Consultation reports, appendices with maps and layouts and any draft EMP type documents.

I might only be able to look at the cases on Monday, but will let you know what we need.

Kind regards,

Please note that I will be on leave from the 19<sup>th</sup> December 2022 and I will return on the 9<sup>th</sup> January 2023.



## APPENDICES

### SCOPING REPORT: Scoping and Environmental Impact Assessment (EIA) Process for the Proposed Development of a Solar Photovoltaic (PV) Facility (Kudu Solar Facility 8) and associated infrastructure, near De Aar, Northern Cape Province

---

From: Rohaida Abed <[RAbed@csir.co.za](mailto:RAbed@csir.co.za)>  
Sent: 11 December 2022 23:27  
To: Natasha Higgitt <[nhiggitt@sahra.org.za](mailto:nhiggitt@sahra.org.za)>  
Subject: RE: Kudu Solar PV Draft Scoping Reports

Hi Natasha

Hope you are well. Thanks for your email. The following cases have been created on SAHRIS.

20336 Kudu Solar Facility 1  
20337 Kudu Solar Facility 2  
20338 Kudu Solar Facility 3  
20339 Kudu Solar Facility 4  
20340 Kudu Solar Facility 5  
20341 Kudu Solar Facility 6  
20342 Kudu Solar Facility 7  
20343 Kudu Solar Facility 8  
20344 Kudu Solar Facility 9  
20345 Kudu Solar Facility 10  
20346 Kudu Solar Facility 11  
20347 Kudu Solar Facility 12

I have uploaded the DSR, Maps and the HIA Scoping Level Assessment, and PIA SSV (under Heritage Reports).

As previously discussed, the PIA is one single report for the entire study area, which has been determined by the specialist to be low sensitivity. So I have only created one PIA report number. However in an error I created a separate one for PV2 but it is the same attachment – is it possible for me to delete this?

Is it also possible to allow an additional person from our group to have editing and upload rights to the cases?

Thanks  
Rohaida

## APPENDICES

SCOPING REPORT: Scoping and Environmental Impact Assessment (EIA) Process for the Proposed Development of a Solar Photovoltaic (PV) Facility (Kudu Solar Facility 8) and associated infrastructure, near De Aar, Northern Cape Province

---

---

**From:** Natasha Higgitt <[nhiggitt@sahra.org.za](mailto:nhiggitt@sahra.org.za)>  
**Sent:** Monday, 12 December 2022 11:01  
**To:** Rohaida Abed <[RAbed@csir.co.za](mailto:RAbed@csir.co.za)>  
**Subject:** RE: Kudu Solar PV Draft Scoping Reports

[The e-mail server of the sender failed SPF checks and maybe malicious (SPF Record)]  
Good morning,

Thank you for the email. I have assigned myself to the cases and added them to my schedule.

I will ask the SAHRIS Admin team to delete that report file. You must just link to the other PIA report file (which is linked to all the others cases) to PV 2 case.

We are not able to provide editing rights to more than one profile. I would recommend creating a company profile, that everyone in your company will have access to. This way more than one person may use the profile. This will also help when people leave companies and we don't need to transfer authorship to someone else.

Kind regards,

Please note that I will be on leave from the 19<sup>th</sup> December 2022 and I will return on the 9<sup>th</sup> January 2023.

---

**From:** Rohaida Abed  
**Sent:** Monday, 12 December 2022 11:17  
**To:** Natasha Higgitt <[nhiggitt@sahra.org.za](mailto:nhiggitt@sahra.org.za)>  
**Subject:** RE: Kudu Solar PV Draft Scoping Reports

Hi Natasha

Thanks so much for your feedback, I appreciate it.

Please let me know if you need any more appendices to be uploaded.

Thanks  
Rohaida

## APPENDICES

SCOPING REPORT: Scoping and Environmental Impact Assessment (EIA) Process for the Proposed Development of a Solar Photovoltaic (PV) Facility (Kudu Solar Facility 8) and associated infrastructure, near De Aar, Northern Cape Province

---

---

**From:** Rohaida Abed <[RAbed@csir.co.za](mailto:RAbed@csir.co.za)>  
**Sent:** 14 December 2022 17:47  
**To:** Natasha Higgitt <[nhiggitt@sahra.org.za](mailto:nhiggitt@sahra.org.za)>  
**Subject:** RE: Kudu Solar PV Draft Scoping Reports

Hi Natasha

Hope you are well. Just checking if you need any more appendices to be uploaded? I will do them before the break.

Hope you have a wonderful holiday.

Thanks  
Rohaida

---

**From:** Natasha Higgitt <[nhiggitt@sahra.org.za](mailto:nhiggitt@sahra.org.za)>  
**Sent:** Thursday, 15 December 2022 09:39  
**To:** Rohaida Abed <[RAbed@csir.co.za](mailto:RAbed@csir.co.za)>  
**Subject:** RE: Kudu Solar PV Draft Scoping Reports

[The e-mail server of the sender failed SPF checks and maybe malicious (SPF Record)]  
Good morning,

Please upload the Visual Scoping Reports and Appendix F for each development application. I assume that Appendix E Public Participation has no information at this stage in the Scoping Phase. If there is any public comments at this stage and they form part of that Appendix, please upload them to each case.

Kind regards,

Please note that I will be on leave from the 19<sup>th</sup> December 2022 and I will return on the 9<sup>th</sup> January 2023.

## APPENDICES

SCOPING REPORT: Scoping and Environmental Impact Assessment (EIA) Process for the Proposed Development of a Solar Photovoltaic (PV) Facility (Kudu Solar Facility 8) and associated infrastructure, near De Aar, Northern Cape Province

---

---

**From:** Rohaida Abed  
**Sent:** Wednesday, 21 December 2022 20:37  
**To:** Natasha Higgitt  
**Cc:** Helen Antonopoulos  
**Subject:** RE: Kudu Solar PV Draft Scoping Reports

Hi Natasha

I hope that you are well.

We have saved the Visual Scoping Reports, Appendix E (PPP) and Appendix F (DFFE Pre-Consultation) onto SAHRIS earlier in the week.

Thanks again for your assistance.

Kind Regards,  
Rohaida

---

**From:** EMS <ems@csir.co.za>  
**Sent:** 25 January 2023 08:57  
**To:** Natasha Higgitt <nhiggitt@sahra.org.za>  
**Cc:** EMS <ems@csir.co.za>  
**Subject:** RE: Reminder - Availability of Draft Scoping Reports for Comment - Kudu Solar PV - SAHRA

Dear Natasha

I hope that you are well. All the best for 2023. I hope that you had a good break.

I am kindly following up on the Kudu PV Projects, as per our communications last year (copied here).

Please let me know if SAHRA is able to send us comments on the Draft Scoping Reports by 30 Jan 2023?

Thanks for your inputs throughout this process.

Thank you and kind regards,  
Rohaida Abed

CSIR Environmental Management Services  
E-mail: [ems@csir.co.za](mailto:ems@csir.co.za)  
Postal Address: P.O. Box 59081, Umbilo, Durban, 4075  
Tel: 031 242 2300

## APPENDICES

SCOPING REPORT: Scoping and Environmental Impact Assessment (EIA) Process for the Proposed Development of a Solar Photovoltaic (PV) Facility (Kudu Solar Facility 8) and associated infrastructure, near De Aar, Northern Cape Province

---

---

**From:** Natasha Higgitt <nhiggitt@sahra.org.za>  
**Sent:** Wednesday, 25 January 2023 09:16  
**To:** EMS  
**Subject:** RE: Reminder - Availability of Draft Scoping Reports for Comment - Kudu Solar PV - SAHRA

**Categories:** This message has been archived by Retain on February 01 2023 18:59

[The e-mail server of the sender failed SPF checks and maybe malicious (SPF Record)]  
Good morning,

I am currently drafting comments on the cases which I hope to issue by Friday.

Kind regards,

# APPENDICES

## SCOPING REPORT: Scoping and Environmental Impact Assessment (EIA) Process for the Proposed Development of a Solar Photovoltaic (PV) Facility (Kudu Solar Facility 8) and associated infrastructure, near De Aar, Northern Cape Province

### SAHRIS

MyDashboard Explore Create Calendar Maps Help

SAHRIS Case ID 20336 - 20347

Between you and [natasha.higgitt](#)

[natasha.higgitt](#) Jan 25 New

Good afternoon,

Please note that Interim Comments have been issued on SAHRIS Case ID 20336 - 20347. Please see links to the cases.

Kind regards,  
Natasha Higgitt

**CaseReference:**

- [Kudu Solar Facility 1](#)
- [Kudu Solar Facility 2](#)
- [Kudu Solar Facility 3](#)
- [Kudu Solar Facility 4](#)
- [Kudu Solar Facility 5](#)
- [Kudu Solar Facility 6](#)
- [Kudu Solar Facility 7](#)
- [Kudu Solar Facility 8](#)
- [Kudu Solar Facility 9](#)
- [Kudu Solar Facility 10](#)
- [Kudu Solar Facility 11](#)
- [Kudu Solar Facility 12](#)

**Add message to tracker:**

#### Reply

CaseReference

ADD ANOTHER ITEM

Message

Add message to tracker

After the message is send, automatically create Case Tracking with message content.

SEND MESSAGE [Clear](#)

Messages

[Back to Top](#)

South African Heritage Resources Agency  
(SAHRA)  
111 Harrington Street  
Cape Town  
8001

PO Box 4637  
Cape Town, 8000  
Tel 021 462 4502/Fax 021 462 4509  
Email [info@sahra.org.za](mailto:info@sahra.org.za)  
Web [www.sahra.org.za](http://www.sahra.org.za)  
(<http://www.sahra.org.za>)



An agency of the Department of Arts & Culture

Powered by [Drupal](#)

[Site best viewed using Google Chrome](#)  
[Disclaimers](#)

Chat (12)

## APPENDICES

### SCOPING REPORT: Scoping and Environmental Impact Assessment (EIA) Process for the Proposed Development of a Solar Photovoltaic (PV) Facility (Kudu Solar Facility 8) and associated infrastructure, near De Aar, Northern Cape Province

#### Interim Comment: Kudu Solar Facility 8

**Kudu Solar Facility 8**

**Our Ref:**



an agency of the  
Department of Arts and Culture

T: +27 21 462 4502 | F: +27 21 462 4509 | E: info@sahra.org.za  
South African Heritage Resources Agency | 111 Harrington Street | Cape Town  
P.O. Box 4637 | Cape Town | 8001  
www.sahra.org.za

Enquiries: Natasha Higgitt  
Tel: 021 462 4502  
Email: nhiggitt@sahra.org.za  
CaseID: 20343

Date: Wednesday January 25, 2023  
Page No: 1

#### Interim Comment

In terms of Section 38(3), 38(8) of the National Heritage Resources Act (Act 25 of 1999)

Attention: Kudu Solar Facility 8 (Pty) Ltd

**ABO Wind renewable energies (Pty) Ltd is proposing to develop 12 Solar Photovoltaic (PV) power generation facilities and associated Electrical Grid Infrastructure (EGI), north-east of the town of De Aar, in the Renosterberg Local Municipality and Pixley Ka Seme District Municipality, in the Northern Cape Province. Scoping and Environmental Impact Assessment (EIA) Processes are currently being undertaken for the 12 Solar PV facilities. Separate Basic Assessment (BA) and/or EGI Standard Registration processes will be commissioned separately, once finalised, for the EGI projects. This case is for the proposed Kudu Solar Facility 8.**

The Council for Scientific and Industrial Research (CSIR) has been appointed by ABO Wind renewable energies (Pty) Ltd to undertake an Environmental Authorisation Application for the proposed Kudu Solar Facility 8 and associated infrastructure, near De Aar, Northern Cape Province.

A Draft Scoping Report (DSR) has been submitted in terms of the National Environmental Management Act, 1998 (NEMA) and the NEMA Environmental Impact Assessment (EIA) Regulations. The proposed activities will include the construction of solar panels, auxiliary buildings, inverter/transformer stations, on-site substation complex, battery energy storage system (BESS), underground cables, access roads, internal roads, fencing, storm water channels, panel cleaning and maintenance area, laydown areas with an overall application area of 538 ha.

Natura Viva CC and ASHA Consulting (Pty) Ltd were appointed to provide heritage specialist input as part of the EA process as per section 24(4)(iii) of NEMA and section 38(8) of the National Heritage Resources Act, Act 25 of 1999 (NHRA).

*Almond, J. E. 2022. Site Sensitivity Verification Report: Proposed Development of the Kudu Solar Photovoltaic Facilities and Associated Infrastructure near Philipstown and De Aar, Pixley Ka Seme District, Northern Cape Province.*

A report that combines the assessment of all 12 Kudu Solar Projects has been submitted.

## APPENDICES

### SCOPING REPORT: Scoping and Environmental Impact Assessment (EIA) Process for the Proposed Development of a Solar Photovoltaic (PV) Facility (Kudu Solar Facility 8) and associated infrastructure, near De Aar, Northern Cape Province

#### Kudu Solar Facility 8

Our Ref:



an agency of the  
Department of Arts and Culture

T: +27 21 462 4502 | F: +27 21 462 4509 | E: [info@sahra.org.za](mailto:info@sahra.org.za)  
South African Heritage Resources Agency | 111 Harrington Street | Cape Town  
P.O. Box 4637 | Cape Town | 8001  
[www.sahra.org.za](http://www.sahra.org.za)

Enquiries: Natasha Higgitt  
Tel: 021 462 4502  
Email: [nhiggitt@sahra.org.za](mailto:nhiggitt@sahra.org.za)  
CaseID: 20343

Date: Wednesday January 25, 2023  
Page No: 2

The proposed development footprint is underlain by the Waterford Formation, the Tierberg Formation and are overlain by the Late Caenozoic calcrete hardpans, alluvial deposits, surface gravels and soils of low sensitivity. A Chance Finds Procedure is recommended to be implemented.

*Orton, J. 2022. Heritage Specialist Scoping Report Inputs: Scoping and Environmental Impact Assessment (EIA) Process for the Proposed Development of a Solar Photovoltaic Facility (Kudu Solar Facility 8) and associated infrastructure, near De Aar, Northern Cape Province*

A total of four heritage resources were identified within the Kudu Solar Facility 8 with two sites on the outskirts of the development. These include a surface scatter of Stone Age lithics of very low heritage significance and farm features of low heritage significance.

Recommendations provided in the report include the following:

- A Chance Finds Procedure is recommended; and
- the recommendations of the Visual Impact Assessment must be followed.

#### Interim Comment

The SAHRA Archaeology, Palaeontology and Meteorites (APM) Unit requests that the HIA must be revised to include a map of the track logs and show all project components such as the access roads etc. The table of identified heritage resources i.e. Table 2, must be revised to indicate in which Kudu project each heritage resources is located within and any specific mitigation and/or management measures required. An addendum to the PIA must be provided with specific results for the Kudu Solar 8 project.

Further comments will be issued upon receipt of the above revised reports and draft EIA inclusive of appendices.

Should you have any further queries, please contact the designated official using the case number quoted above in the case header.

Yours faithfully



## APPENDICES

### SCOPING REPORT: Scoping and Environmental Impact Assessment (EIA) Process for the Proposed Development of a Solar Photovoltaic (PV) Facility (Kudu Solar Facility 8) and associated infrastructure, near De Aar, Northern Cape Province

---

#### Kudu Solar Facility 8

Our Ref:



an agency of the  
Department of Arts and Culture

T: +27 21 462 4502 | F: +27 21 462 4509 | E: info@sahra.org.za  
South African Heritage Resources Agency | 111 Harrington Street | Cape Town  
P.O. Box 4637 | Cape Town | 8001  
www.sahra.org.za

Enquiries: Natasha Higgitt  
Tel: 021 462 4502  
Email: nhiggitt@sahra.org.za  
CaseID: 20343

Date: Wednesday January 25, 2023  
Page No: 3

---

Natasha Higgitt  
Heritage Officer  
South African Heritage Resources Agency

---

Phillip Hine  
Manager: Archaeology, Palaeontology and Meteorites Unit  
South African Heritage Resources Agency

---

**ADMIN:**  
Direct URL to case: <https://sahris.sahra.org.za/node/611041>  
(DFFE, Ref: )

## APPENDICES

SCOPING REPORT: Scoping and Environmental Impact Assessment (EIA) Process for the Proposed Development of a Solar Photovoltaic (PV) Facility (Kudu Solar Facility 8) and associated infrastructure, near De Aar, Northern Cape Province

---

### 6. Comments received from General Stakeholders and I&APS

---

**From:** [REDACTED] <[REDACTED]>  
**Sent:** Monday, 12 December 2022 09:29  
**To:** EMS  
**Subject:** Re: Availability of Draft Scoping Reports for Comment - Kudu Solar PV  
**Categories:** This message has been archived by Retain on December 19, 2022, 18:52

You don't often get email from [REDACTED]. [Learn why this is important](#)

Hi Rahida

has received the documents and place on the Notice Board

Regards  
[REDACTED]

---

**From:** Helen Antonopoulos  
**Sent:** Tuesday, 24 January 2023 11:02  
**To:** [REDACTED]  
**Cc:** EMS  
**Subject:** Kudu Sonfasiliteite Konsepverslae Kommentaarperiode  
**Categories:** This message has been archived by Retain on January 31 2023 21:17

Goeie môre

Ek het vroeër vanoggend probeer geskakel i.v.m. die openbare kommentaarperiode vir die Kudu Sonfasiliteite se konsepverslae.

Die WNNR is aangestel as die onafhanklike omgewingskonsultant vir die projekte en ons wil graag vir u herinner dat die kommentaarperiode 30 Januarie 2023 sluit.

Die verslae en opsommings kan soos volg verkry word:

- Google Drive: [https://bit.ly/KUDU\\_SOLAR\\_PV](https://bit.ly/KUDU_SOLAR_PV)
- Projekwebuiste: <https://www.csir.co.za/environmental-impact-assessment>

Laat weet asseblief as u enige vrae of kommentaar het oor die verslae – ons waardeer alle insette. U is meer as welkom on ons telefonies (060 829 0202) of per e-pos te kontak.

Vriendelike groete  
Helen

## APPENDICES

### SCOPING REPORT: Scoping and Environmental Impact Assessment (EIA) Process for the Proposed Development of a Solar Photovoltaic (PV) Facility (Kudu Solar Facility 8) and associated infrastructure, near De Aar, Northern Cape Province

---

---

**From:** [REDACTED] <[REDACTED]>  
**Sent:** Tuesday, 24 January 2023 11:43  
**To:** Helen Antonopoulos  
**Subject:** Re: Kudu Sonfasiliteite Konsepverslae Kommentaarperiode

Goeie dag Helen

Ons het probleme met kommunikasie netwerke.

In 'n neutedop: waarom gaan die verslae waarop kommentaar gelewer moet word? (Voor ek nou alles download en in elk geval nie gaan verstaan nie) 😊

Groete

---

**From:** Helen Antonopoulos  
**Sent:** Tuesday, 24 January 2023 15:15  
**To:** [REDACTED]  
**Subject:** RE: Kudu Sonfasiliteite Konsepverslae Kommentaarperiode

**Categories:** This message has been archived by Retain on January 31 2023 21:17

Goeie middag [REDACTED]

ABO Wind renewable energies (Edms) Bpk het die WNNR aangestel om die omgewingsimpakproses te bahartig vir die voorgestelde Kudu sonplase wat op u grond (Gedeelte 0 (RES) van Plaas Bas Berg 88; Gedeelte 3 (RES) van Plaas Bas Berg 88; Gedeelte 4 van Plaas Bas Berg 88) naby Petrusville/ Philipstown in die Noord-Kaap gebou sal word indien die projekte omgewingsgoedkeuring sou ontvang van die Departement van Bosbou, Visserye en die Omgewing.

Die verslae bevat opsommings van die die spesialiste se bevindinge rakende die voorgestelde Kudu sonplase. Elke verslag is baie lank, maar daar is 'n opsomming ("Executive Summary") beskikbaar van elke verslag op die webtuiste en Google Drive.

Laat weet asseblief as u enige vrae het. Ek is enige tyd beskikbaar, alhoewel die netwerk soms sukkel tydens loadshedding. Ons waardeer alle insette opreg.

Baie dankie  
Helen

## APPENDICES

SCOPING REPORT: Scoping and Environmental Impact Assessment (EIA) Process for the Proposed Development of a Solar Photovoltaic (PV) Facility (Kudu Solar Facility 8) and associated infrastructure, near De Aar, Northern Cape Province

---

---

**From:** [REDACTED] <[REDACTED]>  
**Sent:** Tuesday, 24 January 2023 16:08  
**To:** Helen Antonopoulos  
**Subject:** Re: Kudu Sonfasiliteite Konsepverslae Kommentaarperiode

Baie dankie vir jou spoedige terugvoer.

---

**From:** [REDACTED] <[REDACTED]>  
**Sent:** Monday, 30 January 2023 08:52  
**To:** EMS; [REDACTED]  
**Subject:** Comments on Kudu Development  
**Attachments:** Kudu.pdf

You don't often get email from [REDACTED]. [Learn why this is important](#)

Dear Rohaida Abed  
Attached my comments on the Kudu Development as an I&AP.  
Also note that my email changed from [REDACTED] to [REDACTED]

Regards

[REDACTED]

## APPENDICES

### SCOPING REPORT: Scoping and Environmental Impact Assessment (EIA) Process for the Proposed Development of a Solar Photovoltaic (PV) Facility (Kudu Solar Facility 8) and associated infrastructure, near De Aar, Northern Cape Province

---

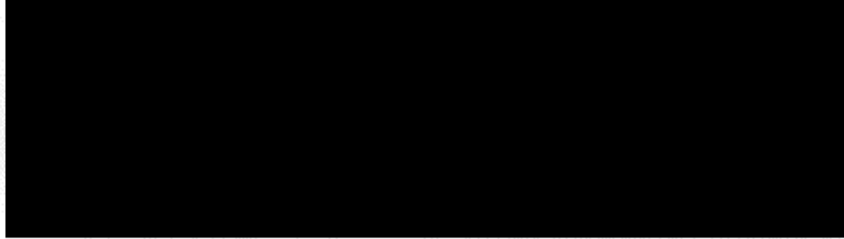

[Redacted]  
[Redacted]

29 January 2023

Good day,

#### INPUT AND OBJECTION TOWARDS THE KUDU DEVELOPMENT

I registered as an interested and affected party to the proposed Kudu development in the Philipstown district.

1. We understand according to documents at our disposal that your development is a massive one proposed on only two farms. As a neighbour who has been farming for my entire life in the Karoo, I want to know what the water use of this project will be. Further, I also request information on measures that you have put in place to test the availability of water resources.
2. According to the layouts of the solar farms, it appears the majority of certain farms will be covered almost entirely under panels. What is your company's viewpoint and understanding of the subdivision of agricultural land act (Act 70 of 1970)? How would the act impact on your proposed developments?
3. What benefits would your proposed development have for the farming community of Philipstown district?

I also register my objection against the development as it does not enhance agricultural sustainability.

Kind regards,

[Redacted]  
[Redacted]

(Note my email changed from [Redacted] to [Redacted] )

## APPENDICES

SCOPING REPORT: Scoping and Environmental Impact Assessment (EIA) Process for the Proposed Development of a Solar Photovoltaic (PV) Facility (Kudu Solar Facility 8) and associated infrastructure, near De Aar, Northern Cape Province

---

---

**From:** [REDACTED]  
**Sent:** Monday, 30 January 2023 12:44  
**To:** EMS; [REDACTED]  
**Subject:** Objections  
**Attachments:** Kudu.pdf

You don't often get email from [REDACTED]. [Learn why this is important](#)

**APPENDICES**

**SCOPING REPORT: Scoping and Environmental Impact Assessment (EIA) Process for the Proposed Development of a Solar Photovoltaic (PV) Facility (Kudu Solar Facility 8) and associated infrastructure, near De Aar, Northern Cape Province**

---

[REDACTED]  
[REDACTED]  
[REDACTED]  
[REDACTED]

30 January 2023

Good day,

**INPUT AND OBJECTION TOWARDS THE KUDU DEVELOPMENT**

I registered as an interested and affected party to the proposed Kudu development in the Philipstown district.

1. We understand according to documents at our disposal that your development is a massive one proposed on only two farms. As a neighbor who has been farming for my entire life in the Karoo, I want to know what the water use of this project will be. Further, I also request information on measures that you have put in place to test the availability of water resources.

2. According to the layouts of the solar farms, it appears the majority of certain farms will be covered almost entirely under panels. What is your company's viewpoint and understanding of the subdivision of agricultural land act (Act 70 of 1970)? How would the act impact on your proposed developments?

3. What benefits would your proposed development have for the farming community of Philipstown district?

I also register my objection against the development as it does not enhance agricultural sustainability.

Kind regards,

[REDACTED]  
[REDACTED]  
[REDACTED]

[REDACTED]

## APPENDICES

SCOPING REPORT: Scoping and Environmental Impact Assessment (EIA) Process for the Proposed Development of a Solar Photovoltaic (PV) Facility (Kudu Solar Facility 8) and associated infrastructure, near De Aar, Northern Cape Province

---

---

**From:** [REDACTED]  
**Sent:** Monday, 30 January 2023 12:45  
**To:** EMS; [REDACTED]  
**Subject:** Objections  
**Attachments:** Kudu.pdf

You don't often get email from [REDACTED]. [Learn why this is important](#)



## APPENDICES

### SCOPING REPORT: Scoping and Environmental Impact Assessment (EIA) Process for the Proposed Development of a Solar Photovoltaic (PV) Facility (Kudu Solar Facility 8) and associated infrastructure, near De Aar, Northern Cape Province

---

[REDACTED]  
[REDACTED]  
[REDACTED]  
[REDACTED]

30 January 2023

Good day,

#### INPUT AND OBJECTION TOWARDS THE KUDU DEVELOPMENT

I registered as an interested and affected party to the proposed Kudu development in the Philipstown district.

1. We understand according to documents at our disposal that your development is a massive one proposed on only two farms. As a neighbor who has been farming for my entire life in the Karoo, I want to know what the water use of this project will be. Further, I also request information on measures that you have put in place to test the availability of water resources.

2. According to the layouts of the solar farms, it appears the majority of certain farms will be covered almost entirely under panels. What is your company's viewpoint and understanding of the subdivision of agricultural land act (Act 70 of 1970)? How would the act impact on your proposed developments?

3. What benefits would your proposed development have for the farming community of Philipstown district?

I also register my objection against the development as it does not enhance agricultural sustainability.

Kind regards,

[REDACTED]  
[REDACTED]  
[REDACTED]

[REDACTED]

## APPENDICES

SCOPING REPORT: Scoping and Environmental Impact Assessment (EIA) Process for the Proposed Development of a Solar Photovoltaic (PV) Facility (Kudu Solar Facility 8) and associated infrastructure, near De Aar, Northern Cape Province

---

---

**From:** [REDACTED] <[REDACTED]>  
**Sent:** Monday, 30 January 2023 17:52  
**To:** EMS  
**Subject:** Attention:RohaidAbed  
**Attachments:** Kudu Development.pdf

Sent from [Mail](#) for Windows



Virus-free [www.avast.com](http://www.avast.com)

## APPENDICES

### SCOPING REPORT: Scoping and Environmental Impact Assessment (EIA) Process for the Proposed Development of a Solar Photovoltaic (PV) Facility (Kudu Solar Facility 8) and associated infrastructure, near De Aar, Northern Cape Province

---

[REDACTED]  
[REDACTED]  
[REDACTED]  
[REDACTED]  
[REDACTED]

29 January 2023

Good day

#### INPUT AND OBJECTION TO THE PROPOSED KUDU DEVELOPMENT – PHILIPSTOWN DISTRICT

I/we submit the following questions regarding the Kudu Development:

I/We understand that projects of this nature need to have an approved water license for each borehole. What measures have you put in place to adhere to this requirement?

According to your documents and proposed layout received, it seems your development will only benefit to two landowners. Do you believe it's fair and equitable to the surrounding farmers and landowners?

How do you intend to maintain the infrastructure, such as road and water courses, during construction? Can you provide a plan on how you will manage the dust pollution that will be created by the heavy trucks and increased traffic?

I/We also object to the entire project given the fact that we believe that the approach followed by the developer is against the letter and spirit of current legislation and regulatory frameworks that ensure agricultural sustainability especially in the Karoo.

Yours sincerely,

[REDACTED]

LANDOWNERS

## APPENDICES

SCOPING REPORT: Scoping and Environmental Impact Assessment (EIA) Process for the Proposed Development of a Solar Photovoltaic (PV) Facility (Kudu Solar Facility 8) and associated infrastructure, near De Aar, Northern Cape Province

---

---

**From:** [REDACTED]  
**Sent:** Monday, 30 January 2023 19:14  
**To:** EMS  
**Subject:** Objection towards KUDU  
**Attachments:** img20230130\_19045071.pdf

Good day Rohaida

Please find attached my objections towards the planned KUDU development.

Kind regards

[REDACTED]

## APPENDICES

### SCOPING REPORT: Scoping and Environmental Impact Assessment (EIA) Process for the Proposed Development of a Solar Photovoltaic (PV) Facility (Kudu Solar Facility 8) and associated infrastructure, near De Aar, Northern Cape Province

---



29 January 2023

Good day;

#### INPUT AND OBJECTION TOWARDS THE KUDU DEVELOPMENT

I registered as an interested and affected party to the proposed Kudu development in the Philipstown district.

1. We understand according to documents at our disposal that your development is a massive one proposed on only two farms. As a neighbour who has been farming for my entire life in the Karoo, I want to know what the water use of this project will be. Further, I also request information on measures that you have put in place to test the availability of water resources.

2. According to the layouts of the solar farms, it appears the majority of certain farms will be covered almost entirely under panels. What is your company's viewpoint and understanding of the subdivision of agricultural land act (Act 70 of 1970)? How would the act impact on your proposed developments?

YOUR LOGO  
HERE



## APPENDICES

### SCOPING REPORT: Scoping and Environmental Impact Assessment (EIA) Process for the Proposed Development of a Solar Photovoltaic (PV) Facility (Kudu Solar Facility 8) and associated infrastructure, near De Aar, Northern Cape Province

---



3. What benefits would your proposed development have for the broader farming community of Philipstown district?

4. What benefits would your proposed development have for the socio-economical upliftment of farmers and their employees (including their families/dependents) of the greater area rather than the proposed two farms and the owner/beneficiary there-of ?

I also register my objection against the development as it does not enhance agricultural sustainability.

Kind regards,



LANDOWNER/DIRECTOR – 

YOUR LOGO  
HERE

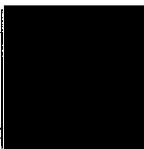

## APPENDICES

SCOPING REPORT: Scoping and Environmental Impact Assessment (EIA) Process for the Proposed Development of a Solar Photovoltaic (PV) Facility (Kudu Solar Facility 8) and associated infrastructure, near De Aar, Northern Cape Province

---

**From:** [REDACTED] <[REDACTED]>

**Sent:** Monday, 30 January 2023 23:44

**To:** EMS <ems@csir.co.za>

**Subject:**

You don't often get email from [REDACTED]. [Learn why this is important](#)

## APPENDICES

SCOPING REPORT: Scoping and Environmental Impact Assessment (EIA) Process for the Proposed Development of a Solar Photovoltaic (PV) Facility (Kudu Solar Facility 8) and associated infrastructure, near De Aar, Northern Cape Province

---

### Objection to the Kudu in its current format and layout development

To whom it may concern:

My name is [REDACTED] I am the owner of the farm [REDACTED]. My farm is next to the Kudu Development.

Please consider and respond to the following issues of serious concern to me.

1. The Kudu development appears to be an enormous concentrated development of several thousands of hectares, laying in one massive block.

\*Please indicate what impact this development will have to the underground water resources of the area.



## APPENDICES

SCOPING REPORT: Scoping and Environmental Impact Assessment (EIA) Process for the Proposed Development of a Solar Photovoltaic (PV) Facility (Kudu Solar Facility 8) and associated infrastructure, near De Aar, Northern Cape Province

---

\* How much water will be withdrawn from the underground resources to service the development ?

How long will the withdrawing of such an amount of water, to serve the maintenance of the development, be sustainable ?

What will the effect be to the windmills/ boreholes on my farm that I use to supply drinking water to my sheep and cattle.

I am living for more than 47 years in this area. A part of my daily life and daily bread is an ongoing effort to serve the area with drinking water for the sheep and cattle. My way crossed a lot with hydrologists, discussing the underground water of this specific huge plains of the Upper Karoo. The most of the farmers around me. Does the same by just supply enough drinking water to sheep and cattle.

## APPENDICES

### SCOPING REPORT: Scoping and Environmental Impact Assessment (EIA) Process for the Proposed Development of a Solar Photovoltaic (PV) Facility (Kudu Solar Facility 8) and associated infrastructure, near De Aar, Northern Cape Province

---

I want to make the following remarks that I would like your specialists to respond on.

- The most of the windmills and boreholes on the farm is just enough for the sheep. Some off the boreholes even dried up in the drought season.
- The point I am making is that the underground water is slow running.
- The underground water is moving in this area from south to north.
- That the depth of the water surface in this area differs from 10 to 40 meters and is slowly sinking deeper as the time go by and the drought Seasons get closer.
- Almost all the boreholes feeding windmills to provide drinking water stops on the dolorite bank (differs from 50-80meter from the surface) and were made by the old bore machines of the previous century.

## APPENDICES

SCOPING REPORT: Scoping and Environmental Impact Assessment (EIA) Process for the Proposed Development of a Solar Photovoltaic (PV) Facility (Kudu Solar Facility 8) and associated infrastructure, near De Aar, Northern Cape Province

---

2. This farm belongs to my family since 1893. We as children were always told to work responsible with the under ground water and overgrazing fields because of the low underground water levels. Given the huge area that will be covered by the panels in a block of several thousands of hectares, how will this proposed development contribute to, and ensure long term agriculture sustainability in this semi- arid Upper Karoo ?

## APPENDICES

SCOPING REPORT: Scoping and Environmental Impact Assessment (EIA) Process for the Proposed Development of a Solar Photovoltaic (PV) Facility (Kudu Solar Facility 8) and associated infrastructure, near De Aar, Northern Cape Province

---

3. Visual impact. Please provide me with information and sketches about the visual impact that this development will have on my farm and farming.

I hereby want to register an objection in the Kudu development in its current format and layout.

[REDACTED]

[REDACTED]

## APPENDICES

SCOPING REPORT: Scoping and Environmental Impact Assessment (EIA) Process for the Proposed Development of a Solar Photovoltaic (PV) Facility (Kudu Solar Facility 8) and associated infrastructure, near De Aar, Northern Cape Province

---

---

**From:** [REDACTED] <[REDACTED]>  
**Sent:** Monday, 30 January 2023 15:17  
**To:** EMS  
**Subject:** Objection to the Kudu Solar Facilities development in its current format and layout. Renosterberg local Municipality  
**Attachments:** IMG-20230130-WA0016.jpg; IMG-20230130-WA0018.jpg; IMG-20230130-WA0017.jpg

You don't often get email from [REDACTED]. [Learn why this is important](#)

Attention: Rohaida Abed

Good day,

please find the letter consist out of three pages that are attached.

Sincerely

[REDACTED]

## APPENDICES

SCOPING REPORT: Scoping and Environmental Impact Assessment (EIA) Process for the Proposed Development of a Solar Photovoltaic (PV) Facility (Kudu Solar Facility 8) and associated infrastructure, near De Aar, Northern Cape Province

---

[REDACTED]

[REDACTED]

Kontak persoon: [REDACTED]

Cell: [REDACTED]

Email: [REDACTED]

[REDACTED]

### **Objection to the Kudu development in its current format and layout.**

To whom it may concern:

My name is [REDACTED] I am the owner of the farm [REDACTED]. My farm is a neighbor farm of the Kudu Development, bordering it for [REDACTED] meters to the [REDACTED]

*Please consider and respond to the following issues of serious concern to me.*

1. The Kudu development appears to be an enormous concentrated development of several thousands of hectares, laying in one massive block.

\*Please indicate what impact this development will have to the underground water resources of the area.

## APPENDICES

SCOPING REPORT: Scoping and Environmental Impact Assessment (EIA) Process for the Proposed Development of a Solar Photovoltaic (PV) Facility (Kudu Solar Facility 8) and associated infrastructure, near De Aar, Northern Cape Province

---

- \* How much water will be withdrawn from the underground resources to service the development ?
- \* How long will the withdrawing of such an amount of water, to serve the maintenance of the development, be sustainable ?
- \* What will the effect be to the current windmills/boreholes that I use to serve my extensive sheep and game farm activities with drinking water.

I am no hydrologist but I am living for more than 50 years in this area. A part of my daily life and daily bread is an ongoing effort to serve the area with drinking water for the sheep and game. My way crossed a lot with hydrologists, discussing the underground water of this specific huge plains of the Upper Karoo.

I want to make the following remarks that I would like your specialists to respond on.

- The most of the underground water in this area is fossil water. Stored for many years underground.
  - The little supplement of underground water is slow and occur only once every few years.
  - The underground water is moving in this area from south to north.
  - That the depth of the water surface in this area differs from 10 to 30 meters and is slowly sinking deeper as the time go by.
  - Almost all the boreholes feeding windmills to provide drinking water stops on the dolorite bank (differs from 30 -50 meter from the surface) and were made by the old bore machines of the previous century.
2. This farm belongs to my family since 1867. We always stove to practice responsible farming activities to enhance agricultural sustainability in the Karoo. Given the huge area that will be covered by the panels in a block of several thousands of hectares, how will this proposed development contribute to, and ensure long term agriculture sustainability in this semi-arid Upper Karoo ?

## APPENDICES

SCOPING REPORT: Scoping and Environmental Impact Assessment (EIA) Process for the Proposed Development of a Solar Photovoltaic (PV) Facility (Kudu Solar Facility 8) and associated infrastructure, near De Aar, Northern Cape Province

---

3. Visual impact. Please provide me with information and sketches about the visual impact that this development will have on my farm and farming activities like the offering of hunting- and photographic safaris to clients from all over the world ?

**I hereby want to register an objection in the Kudu development in its current format and layout.**

[REDACTED]

Yours sincerely

[REDACTED]

Footnote: In the Karoo is the overuse of underground water the same sin to nature as the overgrazing of the natural pasture.



## APPENDICES

SCOPING REPORT: Scoping and Environmental Impact Assessment (EIA) Process for the Proposed Development of a Solar Photovoltaic (PV) Facility (Kudu Solar Facility 8) and associated infrastructure, near De Aar, Northern Cape Province

---

---

**From:** [REDACTED] <[REDACTED]>  
**Sent:** Monday, 30 January 2023 15:20  
**To:** EMS  
**Subject:** Fw: Objection to the Kudu Solar Facilities development in its current format and layout. Renosterberg local Municipality  
**Attachments:** IMG-20230130-WA0016.jpg; IMG-20230130-WA0018.jpg; IMG-20230130-WA0017.jpg

You don't often get email from [REDACTED]. [Learn why this is important](#)

---

Attention: Rohaida Abed

Good day,

please find the letter consist out of three pages that are attached.

Sincerely

[REDACTED]

## APPENDICES

SCOPING REPORT: Scoping and Environmental Impact Assessment (EIA) Process for the Proposed Development of a Solar Photovoltaic (PV) Facility (Kudu Solar Facility 8) and associated infrastructure, near De Aar, Northern Cape Province

---

[REDACTED]

[REDACTED]

Kontak persoon: [REDACTED]

Cell: [REDACTED]

Email: [REDACTED]

[REDACTED]

### **Objection to the Kudu development in its current format and layout.**

To whom it may concern:

My name is [REDACTED] I am the owner of the farm [REDACTED]. My farm is a neighbor farm of the Kudu Development, bordering it for [REDACTED] meters to the [REDACTED]

*Please consider and respond to the following issues of serious concern to me.*

1. The Kudu development appears to be an enormous concentrated development of several thousands of hectares, laying in one massive block.

\*Please indicate what impact this development will have to the underground water resources of the area.

## APPENDICES

SCOPING REPORT: Scoping and Environmental Impact Assessment (EIA) Process for the Proposed Development of a Solar Photovoltaic (PV) Facility (Kudu Solar Facility 8) and associated infrastructure, near De Aar, Northern Cape Province

---

- \* How much water will be withdrawn from the underground resources to service the development ?
- \* How long will the withdrawing of such an amount of water, to serve the maintenance of the development, be sustainable ?
- \* What will the effect be to the current windmills/boreholes that I use to serve my extensive sheep and game farm activities with drinking water.

I am no hydrologist but I am living for more than 50 years in this area. A part of my daily life and daily bread is an ongoing effort to serve the area with drinking water for the sheep and game. My way crossed a lot with hydrologists, discussing the underground water of this specific huge plains of the Upper Karoo.

I want to make the following remarks that I would like your specialists to respond on.

- The most of the underground water in this area is fossil water. Stored for many years underground.
  - The little supplement of underground water is slow and occur only once every few years.
  - The underground water is moving in this area from south to north.
  - That the depth of the water surface in this area differs from 10 to 30 meters and is slowly sinking deeper as the time go by.
  - Almost all the boreholes feeding windmills to provide drinking water stops on the dolorite bank (differs from 30 -50 meter from the surface) and were made by the old bore machines of the previous century.
2. This farm belongs to my family since 1867. We always stoved to practice responsible farming activities to enhance agricultural sustainability in the Karoo. Given the huge area that will be covered by the panels in a block of several thousands of hectares, how will this proposed development contribute to, and ensure long term agriculture sustainability in this semi-arid Upper Karoo ?

## APPENDICES

SCOPING REPORT: Scoping and Environmental Impact Assessment (EIA) Process for the Proposed Development of a Solar Photovoltaic (PV) Facility (Kudu Solar Facility 8) and associated infrastructure, near De Aar, Northern Cape Province

---

3. Visual impact. Please provide me with information and sketches about the visual impact that this development will have on my farm and farming activities like the offering of hunting- and photographic safaris to clients from all over the world ?

**I hereby want to register an objection in the Kudu development in its current format and layout.**

[REDACTED]

Yours sincerely

[REDACTED]

Footnote: In the Karoo is the overuse of underground water the same sin to nature as the overgrazing of the natural pasture.

## APPENDICES

SCOPING REPORT: Scoping and Environmental Impact Assessment (EIA) Process for the Proposed Development of a Solar Photovoltaic (PV) Facility (Kudu Solar Facility 8) and associated infrastructure, near De Aar, Northern Cape Province

---

---

**From:** [REDACTED] <[REDACTED]>  
**Sent:** Tuesday, 31 January 2023 20:28  
**To:** EMS  
**Subject:** KUDU  
**Attachments:** KUDU DEVELOPMENT LO'S [REDACTED].[REDACTED].[REDACTED].[REDACTED].[REDACTED].(2).docx

You don't often get email from [REDACTED]. [Learn why this is important](#)

ATTENTION: ROHAIDA ABED,

Good day, i tried to submit this letter [yesterday](#), 30 January2023 but had no [wifi](#) signal and internet.

I hope you still accept this letter of interest as it is one day late. sorry for the delay but it was out of my hands.

PLEASE FIND ATTACHED THE LETTER OF CONCERN.

Yours sincerely

[REDACTED]

## APPENDICES

SCOPING REPORT: Scoping and Environmental Impact Assessment (EIA) Process for the Proposed Development of a Solar Photovoltaic (PV) Facility (Kudu Solar Facility 8) and associated infrastructure, near De Aar, Northern Cape Province

---



29 January 2023

Good day

### INPUT AND OBJECTION TO THE PROPOSED KUDU DEVELOPMENT – PHILIPSTOWN DISTRICT

I/we submit the following questions regarding the Kudu Development:

I/We understand that projects of this nature need to have an approved water license for each borehole. What measures have you put in place to adhere to this requirement?

According to your documents and proposed layout received, it seems your development will only benefit to two landowners. Do you believe it's fair and equitable to the surrounding farmers and landowners?

How do you intend to maintain the infrastructure, such as road and water courses, during construction? Can you provide a plan on how you will manage the dust pollution that will be created by the heavy trucks and increased traffic?

I/We also object to the entire project given the fact that we believe that the approach followed by the developer is against the letter and spirit of current legislation and regulatory frameworks that ensure agricultural sustainability especially in the Karoo.

As the direct neighbour I am concerned about the dust pollution over the long term in years to come due to the very large area that wont have any vegetation. All the roads goes past and threw

## APPENDICES

SCOPING REPORT: Scoping and Environmental Impact Assessment (EIA) Process for the Proposed Development of a Solar Photovoltaic (PV) Facility (Kudu Solar Facility 8) and associated infrastructure, near De Aar, Northern Cape Province

---

my farm and dust piles on to my vegetation and the animals eats the dust with the vegetation wich piles up into their stomachs and causes illness and leads to death.

Yours sincerely,

■

LANDOWNERS |

## APPENDICES

### SCOPING REPORT: Scoping and Environmental Impact Assessment (EIA) Process for the Proposed Development of a Solar Photovoltaic (PV) Facility (Kudu Solar Facility 8) and associated infrastructure, near De Aar, Northern Cape Province

---

**From:** [REDACTED] <[REDACTED]>  
**Sent:** Tuesday, 31 January 2023 15:47  
**To:** EMS  
**Subject:** OBJECTION - KUDU DEVELOPMENT  
**Attachments:** Letter - CSIR.pdf

You don't often get email from [REDACTED]. [Learn why this is important](#)

Good day

Kindly find herewith a letter for your urgent attention and feedback.

Kind Regards

[REDACTED]  
Attorney and Conveyancer

[REDACTED] [REDACTED] [REDACTED]  
Prokureurs / Attorneys / Igqwetha

The information contained in this communication from the sender is confidential. It is intended solely for use by the recipient and others authorized to receive it. If you are not the recipient, you are hereby notified that any disclosure, copying, distribution or taking action in relation of the contents of this information is strictly prohibited and may be unlawful.



## APPENDICES

SCOPING REPORT: Scoping and Environmental Impact Assessment (EIA) Process for the Proposed Development of a Solar Photovoltaic (PV) Facility (Kudu Solar Facility 8) and associated infrastructure, near De Aar, Northern Cape Province

---



Prokureurs / Attorneys / Igqwetha

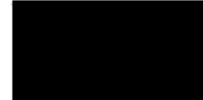

---

Datum/Date:  
31 January 2023

Ons verw/Our ref:

u Verw/Your ref:

---

CSIR  
UMBILO

Attention: Rohaida Abed  
Per E-mail: [ems@csir.co.za](mailto:ems@csir.co.za)

Re: INPUT AND OBJECTION TOWARDS THE KUDU DEVELOPMENT

We refer to the abovementioned matter and confirm that we are acting on behalf of [REDACTED] and [REDACTED] who are both an interested and affected party to the proposed Kudu development in the Philipstown district.

1. We understand according to documents at our disposal that your development is a massive one proposed on only two farms. As neighbours our clients have been farming for their entire life in the Karoo, and we want to know what the water use of this project will be. Further, we also request information on measures that you have put in place to test the availability of water resources.
2. According to the layouts of the solar farms, it appears the majority of certain farms will be covered almost entirely under panels. What is your company's

---

[REDACTED] - B.A. LLB (US)

## APPENDICES

### SCOPING REPORT: Scoping and Environmental Impact Assessment (EIA) Process for the Proposed Development of a Solar Photovoltaic (PV) Facility (Kudu Solar Facility 8) and associated infrastructure, near De Aar, Northern Cape Province

---

viewpoint and understanding of the subdivision of agricultural land act (Act 70 of 1970)? How would the act impact on your proposed developments?

3. What benefits would your proposed development have for the farming community of Philipstown district?
4. We also register our objection on behalf of my clients against the development as it does not enhance agricultural sustainability.
5. I take note that this objection had to be filed on/before 30 January 2023. I kindly request that you condone the late filing of this objection as we are of the opinion the there will be no prejudice of filing this objection 1 day late.
6. If you fail to condone the late filing of this objection and respond in detail to our objections we hold instruction to bring a court application in order to stop the development.

We trust you find the above in order.

Yours Faithfully

[REDACTED]

.....  
[REDACTED]

*(electronically send therefore unsigned)*

---

[REDACTED] - B.A. LLB (US)

## APPENDICES

SCOPING REPORT: Scoping and Environmental Impact Assessment (EIA) Process for the Proposed Development of a Solar Photovoltaic (PV) Facility (Kudu Solar Facility 8) and associated infrastructure, near De Aar, Northern Cape Province

---

---

**From:** [REDACTED] <[REDACTED]>  
**Sent:** Monday, 30 January 2023 21:25  
**To:** EMS  
**Attachments:** 20230130212420\_001.jpg

You don't often get email from [REDACTED]. [Learn why this is important](#)

Sent from my Galaxy

## APPENDICES

SCOPING REPORT: Scoping and Environmental Impact Assessment (EIA) Process for the Proposed Development of a Solar Photovoltaic (PV) Facility (Kudu Solar Facility 8) and associated infrastructure, near De Aar, Northern Cape Province

---

PLEASE ADD ADDRESS OR LETTERHEAD

29 January 2023

Good day

INPUT AND OBJECTION TO THE PROPOSED KUDU DEVELOPMENT – PHILIPSTOWN DISTRICT

I/we submit the following questions regarding the Kudu Development:

I/We understand that projects of this nature need to have an approved water license for each borehole. What measures have you put in place to adhere to this requirement?

According to your documents and proposed layout received, it seems your development will only benefit to two landowners. Do you believe it's fair and equitable to the surrounding farmers and landowners?

How do you intend to maintain the infrastructure, such as road and water courses, during construction? Can you provide a plan on how you will manage the dust pollution that will be created by the heavy trucks and increased traffic?

I/We also object to the entire project given the fact that we believe that the approach followed by the developer is against the letter and spirit of current legislation and regulatory frameworks that ensure agricultural sustainability especially in the Karoo.

Yours sincerely,

LANDOWNERS

