

EIA REPORT



APPENDICES

Appendix A	Curriculum Vitae of the Environmental Assessment Practitioner and Specialists
Appendix B	Declarations of Interest and Independence of the Environmental Assessment Practitioner and Specialists
Appendix C	Database of Interested and Affected Parties
Appendix D	Copy of Newspaper Advertisement
Appendix E	Copies and Proof of Correspondence sent to I&APs during Scoping Phase
Appendix F	Copy of Site Notice Board and Proof of Placement
Appendix G	Copies of Correspondence from I&APs during the Scoping Phase
Appendix H	Copies of Correspondence from I&APs during the 30-day Review of the Scoping Report
Appendix I	DEA Correspondence
Appendix J	Maps and Title Deeds
Appendix K	Technical Report: Cumulative Topographical Analysis of Proposed PV Projects in AGA Area

Scoping and Environmental Impact Assessment for the Proposed Development of a 75 MW Solar Photovoltaic Facility (KENHARDT PV 1) on the remaining extent of Onder Rugzeer Farm 168, north-east of Kenhardt, Northern Cape Province

EIA REPORT

APPENDIX A:

Curriculum Vitae of the Environmental Assessment Practitioner and Specialists

Scoping and Environmental Impact Assessment for the Proposed Development of a 75 MW Solar Photovoltaic Facility (KENHARDT PV 1) on the remaining extent of Onder Rugzeer Farm 168, north-east of Kenhardt, Northern Cape Province

Curriculum Vitae	
1. EAP	Surina Laurie
2. Project Manager	Rohaida Abed
3. Ecology Specialist	Simon Bundy
4. Ecology Specialist	Andrew Blackmore
5. Visual Specialist	Henry Holland
6. Heritage Specialist	Dr. Jayson Orton
7. Palaeontological Specialist	Dr. John Almond
8. Geohydrological Specialist	Julian Conrad
9. Geohydrological Specialist	Charles Peek
10. Soils Specialist	Johann Lanz
11. Social Specialist	Rudolph du Toit

Curriculum Vitae of Surina Laurie - Project Leader

Name of firm	CSIR
Name of staff	Surina Laurie
Profession	Environmental Assessment Practitioner
Position in firm	Project Manager
Years' experience	4 years
Nationality	South African

Biographical sketch

Surina has more than 5 years' experience as an Environmental Assessment Practitioner (EAP). She completed both her BSc in Conservation Ecology and MPhil in Environmental Management (part-time) at the University of Stellenbosch. With her honours project, she worked closely with the Endangered Wildlife Trust Riverine Rabbit Working Group and was responsible for determining the conservation opportunity for the Riverine Rabbit in the Karoo. With this project, she gained valuable experience in how to interact and manage stakeholders in such a way that a project's objectives and conservation goals are met without the stakeholders not being included in the decision-making process. The management of stakeholders and the ability to incorporate their needs into the objectives of a project is seen as an essential component of an Environmental Impact Assessment (EIA) process.

With her Masters' thesis she researched and addressed why there is a need to undertake a Cost Benefit Analysis (CBA) as part of any EIA. The need for a CBA stems from the fact that losing environmental services will have an economic impact on a regional/national level in the long term but this is usually not considered during an EIA process. A CBA will look at both the economic benefits (profit) from a project and the economic losses because of loss of ecosystem services or rehabilitation costs. By including a CBA in an EIA, both the economic and environmental financial implications (not just the environmental significance of an impact) of a project will be considered by the decision making authority prior to the issuing of Environmental Authorisations or permits.

She has experience in undertaking Basic Assessments and Scoping and Environmental Impact Assessments for various sectors, including renewable energy, industry and tourism. She also has experience in undertaking environmental audits, due diligence assessments and the compilation of Environmental Management Programmes.

Registered Professional Natural Scientist (Pr. Sci. Nat.) in Environmental Science (Reg. No: 400033/15) with the South African Council of Natural Scientific Professions.

Education	2015 (current)	Certificate in Environmental Economics, University of London (SOAS)
	2013	Project Management Course, University of Cape Town Graduate School of Business
	2011-2012 (Part-time)	MPhil Environmental Management, University of Stellenbosch
	2007-2010	BSc Conservation Ecology, University of Stellenbosch
Employment Record	Feb 2014 to present	CSIR, Project Manager, EAP
	Sept 2011 to Jan 2014	WSP Environmental (Pty) Ltd, Environmental Consultant
	Nov 2010 to Aug 2011	EnviroAfrica, Junior Environmental Consultant

Scoping and Environmental Impact Assessment for the proposed Development of a 75 MW Solar Photovoltaic Facility (KENHARDT PV 1) on the remaining extent of Onder Rugzeer Farm 168, north-east of Kenhardt, Northern Cape Province

Experience record *Abridged experience in Environmental Impact and Basic Assessment processes:*

Date	Project Description	Role	Client
2014 - present	Integrated Scoping and EIA process for the construction of three Photovoltaic (PV) or Concentrated Photovoltaic (CPV) Solar Facilities with a generating capacity of 75 MW each on the farms remaining extent of Portion 3 of the Farm Gemsbok Bult 120 and Boven Rugzeer remaining extent of 169, located 30 km north-east of Kenhardt. Two of the projects will be located on the farm remaining extent of Portion 3 of the Farm Gemsbok Bult 120 and one on Boven Rugzeer remaining extent 169.	Project Manager	Mulilo Renewable Project Development (Pty) Ltd
2014 - present	Integrated Scoping and EIA process for the development of twelve (12) Photovoltaic (PV) or Concentrated Photovoltaic (CPV) Solar Facilities with a generating capacity of 75 MW/100MW each, near Dealesville, Free State.	Project Manager	South Africa Mainstream Renewable Power Developments (Pty) Ltd
2013-2014	Basic Assessment for the construction of three additional petroleum storage tanks at the Cape Town Harbour.	Environmental Consultant	FFS Refiners (Pty) Ltd
2013-2014	Scoping and EIA for the construction of a Sewage Package Plant on Robben Island.	Environmental Consultant	Department of Public Works
2013	Development of an EMPr for the undertaking of maintenance work on the Stilbaai Fishing Harbour's Slipway located in Stilbaai, Western Cape, South Africa. In order to be compliant to the requirements of the National Environmental Management Act (Act 107 of 1998) and Environmental Impact Assessment (EIA) Regulations, a Maintenance Management Plan (MMP) needed to be developed to manage the environmental impacts associated with maintenance work that is scheduled to be undertaken on the Stilbaai Fishing Harbour's Slipway as well as any future on-going maintenance requirements.	Environmental Consultant	Department of Public Works
2012-2014	Waste Management License for the proposed storage of Ferrous HMS 1+2, Shredded Ferrous and Bales located at the K/L Berth at Duncan Road, Port of Cape Town	Environmental Consultant	The New Reclamation Group (Pty) Ltd
2012-2014	Scoping and EIA for the construction a biodiesel refinery in the Coega Industrial Development Zone (IDZ). The proposed project entails the import of used vegetable oil from the USA and converting it through various processes to biodiesel which will be exported to Europe. The proposed project requires an Air Emissions License, a Waste Management License and Environmental Authorisation.	Environmental Consultant	FIS Biofuels (Ltd)
2013-2013	Basic Assessment for the proposed redevelopment of Berths B, C and D in Duncan Dock at the Port of Cape Town.	Assistant Environmental Consultant	FPT (Pty) Ltd
2011- 2012	Development of an EMPr for the Eerstelingsfontein Opencast Project (EOP).	Assistant Environmental Consultant	Exxaro Resources Limited
2011-2014	Basic Assessment for the proposed reinstatement of the Blue Stone Quarry located on Robben Island.	Assistant Environmental Consultant	Department of Public Works
2011	Scoping and EIA for the proposed upgrade to the Struisbaai WWTW.	Assistant Environmental Consultant	Cape Agulhas Municipality
2011	Basic Assessment for the construction of a cellular mast.	Environmental Consultant	MTN (Pty) Ltd
2010-2011	Basic Assessment for the construction of a Heritage Centre.	Environmental Consultant	Waenhuiskrans Arniston Community Development Trust
2010-2011	Scoping and EIA for the rezoning of the area from open space to residential, the construction of six residential units and the upgrading of the existing Waste Water Treatment Plant.	Environmental Consultant	Private developer

Abridged experience in undertaking the role of an Environmental Control Officer and compliance auditing:

Date	Project Description	Role	Client
2013- 2014	The proposed extension project involved the installation of five new above ground storage tanks. The two largest tanks have a tank capacity of 2,500m ³ each and a height of 18m. The three smaller tanks have a tank capacity of 2,300m ³ , 1,350m ³ and 212m ³ and heights of 18m, 10.8m and 10.8m respectively, giving an additional 8862m ³ storage capacity to the current FFS operation	ECO	FFS Refiners (Pty) Ltd
2012- 2014	Compliance auditing of drum re-conditioners for the used oil industry in the Western Cape.	Assistant Environmental Consultant	The Rose Foundation
2012	Environmental legal compliance auditing of various Much Asphalt sites. The audit entailed review of national, provincial legislation and municipal by-laws and a site visit in order to determine whether the sites were compliant to the relevant environmental legislation.	Environmental Consultant	Much Asphalt
2011- 2013	Construction of a new De-Ashing Plant for FFS Vissershok Construction of a De-Ashing Plant. This project involved the monthly independent audits and reports of all the environmental and social aspects of the construction phase the new De-Ashing Plant at Vissershok.	ECO	FFS Refiners (Pty) Ltd
2011- 2012	Construction of the new 1200m ³ Tank at FFS Cape Town Harbour Site. This project involved two site audits per month to ensure compliance to the Environmental Authorisation and Environmental Management Plan for the proposed project.	ECO	FFS Refiners (Pty) Ltd

Language capabilities	<i>Speaking</i>	<i>Reading</i>	<i>Writing</i>
	Afrikaans	Excellent	Excellent
English	Excellent	Excellent	Excellent

Curriculum Vitae of Rohaida Abed - Project Manager

Name of firm	CSIR
Name of staff	Rohaida Abed
Profession	Environmental Assessment Practitioner
Position in firm	Junior Environmental Assessment Practitioner
Years' experience	5 years
Nationality	South African

Biographical Sketch Rohaida is a Junior Environmental Assessment Practitioner in the CSIR Environmental Management Services team based in Durban. She has five years of experience in the Environmental Management field, and has been involved in various transport infrastructure related projects as an Environmental Control Officer, which included monitoring compliance with Environmental Authorizations and Environmental Management Plans. She has also been conducting Scoping and Environmental Impact Assessments for projects within the Coega Industrial Development Zone.

Registered Professional Natural Scientist (Pr. Sci. Nat.) in Environmental Science (Reg. No: 400247/14) with the South African Council of Natural Scientific Professions.

Education	2005	Bachelor of Science (Environmental Science)
	2006	Bachelor of Science Honours (Environmental Science)
	2010	Master of Science (Environmental Science)

Employment Record	2006 - 2008	University of KwaZulu-Natal (Academic Demonstrator)
	March 2010 - April 2010	EnAq Consulting (Environmental Officer)
	May 2010 - September 2011	Henwood & Nxumalo Consulting Engineers (Environmental Scientist)
	October 2011 - to present	CSIR (Junior Environmental Assessment Practitioner)

Short Courses	May 2009	Management of Estuaries in South Africa (Marine and Estuarine Research, FET Water, and Water Research Commission)
	October 2010	Environmental Impact Assessment: A Practical Approach (North West University (Potchefstroom Campus), Centre for Environmental Management)

Experience record

Date	Project Description	Role	Client
2010 - 2011	The Repair and Rehabilitation of the Umzinto River Bridge Number 823 on the South Coast of KwaZulu-Natal	Environmental Control Officer	KwaZulu-Natal Department of Transport
2010 - 2011	The Construction of the Kwahlongwa Bridge Number 3257 over the Kwa-Malukaka River on D297 near Umzumbe, South Coast of KwaZulu-Natal	Environmental Control Officer	KwaZulu-Natal Department of Transport
2010 - 2011	The Construction of a bridge and approach roads across the Indaka River at Eludimbi, within the Msinga Local Municipality, KwaZulu-Natal	Environmental Control Officer	KwaZulu-Natal Department of Transport
2010 - 2011	The Extension of the Lion Park Pipeline along the P566 and D2173 in the Manyavu area, KwaZulu-Natal	Environmental Control Officer	Umgeni Water
2010 - 2011	The Construction of a bridge and approach roads across the Tugela River at Thulwane, within the Nkandla Local Municipality, KwaZulu-Natal	Environmental Control Officer	KwaZulu-Natal Department of Transport
2010 - 2011	The Construction of a bridge and approach roads	Environmental Control	KwaZulu-Natal

Scoping and Environmental Impact Assessment for the proposed Development of a 75 MW Solar Photovoltaic Facility (KENHARDT PV 1) on the remaining extent of Onder Rugzeer Farm 168, north-east of Kenhardt, Northern Cape Province

Date	Project Description	Role	Client
	across the Mona River at Nqolotshe, within the Hlabisa and Nongoma Local Municipalities, KwaZulu-Natal	Officer	Department of Transport
2010 - 2011	The Construction of the Mdloti River Bridge (Northbound) on the R102, within the eThekweni Municipality, KwaZulu-Natal.	Environmental Control Officer	KwaZulu-Natal Department of Transport
2010 - 2011	The Upgrade of the R102 from the Duffs Road Interchange to King Shaka International Airport, within the eThekweni Municipality, KwaZulu-Natal.	Environmental Control Officer	KwaZulu-Natal Department of Transport
2010 - 2011	The Construction of the P701 Provincial Road from Ulundi to Empangeni, KwaZulu-Natal	Environmental Control Officer	KwaZulu-Natal Department of Transport
2010	Environmental Impact Assessment for the construction of a bridge and approach roads across the Mona River at Nqolotshe, within the Hlabisa and Nongoma Local Municipalities, KwaZulu-Natal	Project Assistant	KwaZulu-Natal Department of Transport
2011 - 2014	Environmental Impact Assessment for the proposed Bulk Liquid Storage and Handling Facility in Zone 8 of the Coega IDZ, Port of Ngqura	Project Consultant	Oiltanking Grindrod Calulo (PTY) Ltd
2012 - 2014	Environmental Impact Assessment for the proposed Manganese Export Terminal in Zones 8, 9 and 11 of the Coega IDZ, including the Port of Ngqura, and surrounding area	Project Assistant	Hatch Africa (PTY) Ltd c/o Transnet
2012 - 2014	Basic Assessment for the Provision of Landside Structures and Infrastructure to the Bulk Liquid Storage and Handling Facility in the Port of Ngqura	Project Manager	Eastern Cape Infrastructure Joint Venture c/o Transnet Capital Projects
2013 - 2014	Environmental Impact Assessment for the Provision of Marine Infrastructure, including a General Cargo Berth and Liquid Bulk Berths at the Port of Ngqura	Project Manager	Transnet Capital Projects
2013 ongoing	- Basic Assessment for the decommissioning of unused infrastructure at the Port of Ngqura	Project Manager	Transnet Capital Projects
2014 ongoing	- Basic Assessment for the Proposed Decommissioning and Upgrade of a Bulk Liquid Storage and Handling Facility at Maydon Wharf, Port of Durban, KwaZulu-Natal	Project Manager	Oiltanking Grindrod Calulo Terminals (PTY) Ltd
2015 ongoing	- Environmental Management Plan for the Proposed Construction of a Bulk Liquid Storage and Handling Facility in the Port of Cape Town, Western Cape	Project Manager	Oiltanking Grindrod Calulo Terminals (PTY) Ltd

Language capabilities

	<i>Speaking</i>	<i>Reading</i>	<i>Writing</i>
English	Excellent	Excellent	Excellent

Curriculum Vitae of Simon Bundy - Ecological Specialist

NAME Simon Colin Bundy

PROFESSION Ecologist

DATE OF BIRTH 7 September 1966

PLACE OF BIRTH Glasgow, Scotland

NATIONALITY South African / British

MEMBERSHIP OF PROFESSIONAL BODIES: South African Council of Natural Scientific Professionals No. 400093/06 - Professional Ecologist

KEY QUALIFICATIONS

Simon Bundy has been involved in environmental and development projects and programmes since 1991 at provincial, national and international level, with employment in the municipal, NGO and private sectors, providing a broad overview and understanding of the function of these sectors. Bundy has a core competency in coastal management and botanical issues and has worked on coastal projects in the Seychelles and Tanzania providing ecological and general environmental advice and support. Bundy has been involved in a number of renewable energy projects including the Kalkbult, Dreunberg and Lindes Solar Parks in the Northern and Eastern Cape, as well as wind energy and solar projects in the Western Cape and Rwanda. In such projects Bundy has provided both technical ecological support, as well as the undertaking of environmental impact assessments.

Allied to the above, Bundy has provided technical assistance to the "Save the Wild Coast" initiative through a technical report outlining the concerns relating to dune mining in and around the Xolobeni prospecting region while also evaluating critically, a number of environmental impact assessments and technical reports for various clients. Such evaluations have included "sea defence structures at Buffalo Bay, Western Cape", through the Nelson Mandela University. Bundy has also assisted iSimangaliso Wetland Park in its initiatives against unlawful developments in the Bangha Nek area. Bundy has also acted as expert witness on ecological issues on a number of legal cases.

From a technical specialist perspective, Bundy is competent in a large number of ecological methodologies and analytical methods including statistical methods ; multivariate analysis and ordination. Bundy is competent in wetland delineation and has formulated ecological coastal set back methodologies for EKZN Wildlife and the Oceanographic Research Institute. Bundy acts as botanical specialist for Eskom Eastern Region, with specific interest in coastal habitat forms.

EDUCATION

BSc Biological Science MSc University of Natal, Diploma Project Management (1997) Executive Education, PhD candidate Dept of Engineering UKZN

1998 : "Sustainable development initiatives" in Europe. Training Programme in Berlin, Germany

2000 : Training course : "Environmental Economics and Development".

University of Colorado (Boulder) USA.

SELECTED RELEVANT PROJECT EXPERIENCE

Task Team Chair and Project Ecologist: Task Team for Coastal Disaster Management, KwaDukuza 2007 - 2011

Management of coastal clean up programme immediately following March storm event of 2007. Activities included introduction of geofabric bag protection options, coastal retreat implementation and development of policy on coastal management following destruction of coastline.

Ecological Review of Lake Mzingazi for Umhlatuze Water : University of KwaZulu-Natal - (2010)
Review of habitat structure and integrity of Mzingazi Lake System at Richards Bay required to interpret transformation of aquatic system over time and evaluate forecast for future reference.

Ecological Review and Agricultural Assessment - Dreunberg Solar Park, Eastern Cape: Scatec Solar - (2012)

Ecological review of proposed solar park near Burgersdorp, with additional evaluation of veld carrying capacity.

Ecological Review and Rehabilitation Planning : Sodwana Bay: iSimanagalis Wetland Park Authority - (2013 - 2014)

Analysis and review of state of dune cordon in and around Sodwana Bay with consideration of the impacts of removing exotic trees from route to rejuvenate dune and beach dynamics

Ecological Review of Kalkbult Solar Park (2009)

Ecological review and delineation of ecologically significant areas within the proposed Kalkbult Solar Park, near Potsfontein, Northern Cape.

Ecological and Dune retreat investigation of the Kosi Bay Illegal Development Isimangalis Wetland Park Authority (2011)

Specialist investigation into the impact upon the dune cordon of structures placed in and close to dune cordon near Kosi Bay mouth.

PUBLICATIONS

Bundy S C and Forbes N T 2015. *“Coastal dune mobility and their use in establishing a set back line”* 9th West Indian Ocean Marine Science Conference 2015

Bundy S C and Smith A M 2009 *“ Analysis of the Recovery of Two Separate Coastal Dune Systems Following the 2006 - 2007 Marine Erosion Event and Assessment of the Artificial Dune System in Coastal Management”* KZN Marine and Coastal Management Symposium, Durban South Africa.

Bundy S C , Smith AM, Mather AA 2010 *“ Dune retreat and stability on the Northern Amanzimtoti Dune Cordon”* EKZN Wildlife Conservation Symposium 2010

Smith, A Mather AM Bundy SC, Cooper AS Guastella L, Ramsay PJ and Theron A ; 2010 *“Contrasting styles of swell-driven coastal erosion: examples from KwaZulu-Natal, South Africa”* Geology Journal”, Cambridge University Press

Smith, AM, L Guastella , SC Bundy and AA Mather 2007 *“Coastal Storm Damage in the March 2007 Storm SA Journal of Science 2007 “A Synopsis of Recent Storm Events”*

Guastella L, Smith A Mather A and Bundy S 2008 *“As Memories Fade - A Review of the Post 2007 Coastal Erosion Events”* African Wildlife 32 / 2008

Smith A, Mather A, Theron A, Bundy S and Guastella L 2008 *“The 2006-2007 KwaZulu - Natal Coastal Erosion Event in Perspective”* 2009 Contribution to the The South African Environmental Observation Network publication *“ Climate Change in Southern Africa”*

Smith A and Bundy S 2009 *“Coastal erosion: reparative work on the Ballito coastline, KwaZulu-Natal, South Africa, was it enough?”* 2009 International Multi Purpose Reef and Coastal Conference, Jeffrey's Bay South Africa.

Smith AM, SC Bundy 2012 *“Review of Coastal Defence Systems in Southern Africa”* Article for Springer Scientific Publications through Ulster University, Pilkey and Cooper

Bundy SC AM Smith, L Guastella 2012 *“A Review of Select Dune Rehabilitation Initiatives and a Proposed Methodology towards Ensuring a Prudent Approach towards the “Greening of Dunes”* VI International Sandy Beaches Symposium Emphakweni Port Alfred

Various popular articles including documentaries on coastal and climate change issues

Curriculum Vitae of Andrew Craig Blackmore - Ecological Specialist

Full name Andrew Craig Blackmore
Postal address 96 Uplands Road, Blackridge, Pietermaritzburg, 3201 Kwa-Zulu-Natal South Africa
Language English (Excellent spoken & written)
Nationality South African

TERTIARY EDUCATION

Diploma - Multilateral Agreements University of Finland (2011)
Master of Laws (Environmental Law) *cum laude* University of KwaZulu-Natal, Pietermaritzburg (2005)
Master of Science - Ecology University of the Witwatersrand (1992)
Bachelor of Science (Honours) University of the Witwatersrand (1987)
Bachelor of Science University of the Witwatersrand (1986)
Candidate PhD - University of Tilburg Holland

PROFESSIONAL EXPERIENCE

- Research Officer. University of Witwatersrand. 1987 - 1990
- Nature Conservation Scientist. Natal Parks Board. 1990 - 1997
- Regional Ecologist. KZN Conservation Service. 1997 - 1999
- Head Integrated Environmental Management. Ezemvelo KZN Wildlife. 1999 - 2012
- Manager Protected Area Planning & Integrated Environmental Management. Ezemvelo KZN Wildlife 2012 - Present
- External Examiner Environmental Law, University of KZN - Howard Collage 2007 - Present
- Council Member of the Botanical Society of South Africa 2013 - Present
- Executive Member of the Botanical Society of South Africa 2013 - Present

PROFESSIONAL MEMBERSHIP

- Environmental Law Association
- Botanical Society of Society
- Elephant Specialist Advisory Group (Trustee)

References

Mr Trevor Sandwith Director, Global Protected Areas Policy Deputy Chair: World Commission on Protected Areas tsandwith@tnc.org Tel Washington (703) 841-2644

Mr R Porter Previous Head Biodiversity Planning. Ezemvelo KZN Wildlife roger.n.poter@gmail.com
+27 (0) 82908488

Curriculum Vitae of Henry Holland - Visual Specialist

Profession: GIS Consultant
Date of Birth: 26 December 1968

BIOGRAPHICAL SKETCH

Henry has been doing GIS related work since 1992 when he started his M.Sc. in Geology. Since finishing his Masters he worked in Angola establishing a GIS department for a diamond exploration company, after which he worked on a freelance basis for eight years doing GIS related work and computer programming. In 2005 he established the Mapthis Trust which provides geospatial services for a range of environmental and geological companies and projects. Henry has been involved in Visual Impact Assessments (VIAs) since 1997.

TERTIARY EDUCATION

1996 M. Sc. Geology/GIS Rhodes University
1986 B.Sc. Hons UOFS

KEY EXPERIENCE

The table below presents an abridged list of Henry's project experience relevant to this proposal:

Completion Date	Project Description	Role	Client
2015	Umgeni Water Lovu and Tongaat Desalination Plants EIAs, KwaZulu-Natal	Author	CSIR
2015	Inyanda-Roodeplaat WEF, Uitenhage, EC	Author	SRK
2015	OTGC Oil Storage Terminal BA - Visual Impact, Durban, KZN	Author	CSIR
2014	Mainstream Dealesville Solar Plants VIA, Freestate Province	Author	CSIR
2014	Mulilo Solar Plants VIA, Northern Cape	Author	CSIR
2014	Frontier SRMOP EIA, Saldanha, WC	Author	CSIR
2013	Ishwati Emoyeni Wind Energy Facility VIA, Western Cape	Author	CSIR
2013	Venter Fert Composting and Fertiliser Plant	Author	Public Process Consultants
2013	Kipeto Power Line, Kenya	Author	Kipeto Energy Ltd.
2012	Ngqura Manganese Export Facility VIA, Coega, Eastern Cape	Author	CSIR
2012	Toliara Sands Mining Project VIA, Toliara, Madagascar	Author	CES
2012	Mkuze Biofuel Power Plant VIA, Mkuze, KwaZulu-Natal	Author	CSIR
2012	Vleesbaai WEF VIA, Western Cape	Author	CSIR
2012	Saldanha Desalination Plant VIA, Saldanha Bay, Western Cape	Author	CSIR
2012	Mossel Bay WEF, Western Cape	Author	CES
2012	Keimoes Solar Energy Facility, NC	Author	CSIR
2012	Douglas Solar Energy Facility, NC	Author	CSIR
2012	Richards Bay WEF VIA, KZN	Author	CES

Completion Date	Project Description	Role	Client
2012	Hluhluwe WEF VIA, KZN	Author	CES
2012	Plan8 Grahamstown Wind Farm VIA, Eastern Cape	Author	CES
2012	Kipeto Wind Farm VIA, Kenya	Author	Galetech Energy Developments Ltd.
2011	Coega IDZ Zone 12 Wind Farm	Author	CSIR
2011	Haverfontein Wind Farm, Mpumalanga	Author	CES
2011	Middleton Wind Farm, Cookhouse	Author	CES
2011	Broadlands PV Plant, Humansdorp	Author	CSIR
2011	Ubuntu Wind Farm, Jeffrey's Bay	Author	CSIR
2011	Lushington Park Wind Farm, East London	Author	CES
2011	Chaba Wind Farm, Komga	Author	CES
2010	Thomas River Wind Farm and PV Park VIA, Stutterheim	Author	CES
2010	Eskom Power Line VIA, Kouga	Author	CES
2010	Laguna Bay Resort VIA	Author	CES
2010	Kouga Wind Farm VIA	Author	Arcus GIBB
2010	Electrawinds Coega Wind Farm VIA	Author	CSIR
2010	Innowind Coega Wind Farm VIA	Author	CES
2010	Jeffrey's Bay Wind Farm VIA, Jeffrey's Bay	Author	CSIR
2010	Cookhouse Wind Farm VIA, Cookhouse	Author	CES
2009	Waainek Wind Farm VIA, Grahamstown	Author	CES
2009	Coega Wind Turbine BA (Visual Input)	Author	CSIR
2009	Sierra Leone Ethanol Plant VIA	Author	CSIR
2009	NamWater Desalination Plant VIA, Swakopmund, Namibia	Author	CSIR
2009	Nooitgedagt/Coega Water Supply VIA, Motherwell	Author	SRK
2009	CDM Brewery VIA, Nampula, Mozambique	Author	CES
2009	TankaTara Preliminary Visibility Analysis, Addo	Author	CES
2008	Kouga Wind Energy Project VIA, Jeffreys Bay	Author	CSIR
2008	Aston Bay VIA	Author	CES
2008	NPA Boundary Wall VIA, Port Elizabeth	Author	CSIR
2008	Elitheni Coal Mining VIA, Indwe	Author	Savannah Environmental (PTY) Ltd.
2008	Coegakamma Chicken Broiler Housing VIA	Author	Public Consultants Process
2008	Amanzi Country Lifestyle Estate VIA, Uitenhage	Author	Public Consultants Process

Curriculum Vitae of Dr. Jayson Orton - Heritage Specialist

Contact Details and personal information:

Address: 6A Scarborough Road, Muizenberg, 7945
Telephone: (021) 788 8425
Cell Phone: 083 272 3225
Email: jayson@asha-consulting.co.za

Birth date and place: 22 June 1976, Cape Town, South Africa
Citizenship: South African
ID no: 760622 522 4085
Driver's License: Code 08
Marital Status: Married to Carol Orton
Languages spoken: English and Afrikaans

Education:

SA College High School	Matric	1994
University of Cape Town	B.A. (Archaeology, Environmental & Geographical Science)	1997
University of Cape Town	B.A. (Honours) (Archaeology)*	1998
University of Cape Town	M.A. (Archaeology)	2004
University of Oxford	D.Phil. (Archaeology)	2013

*Frank Schweitzer memorial book prize for an outstanding student and the degree in the First Class.

Employment History:

Spatial Archaeology Research Unit, UCT	Research assistant	Jan 1996 - Dec 1998
Department of Archaeology, UCT	Field archaeologist	Jan 1998 - Dec 1998
UCT Archaeology Contracts Office	Field archaeologist	Jan 1999 - May 2004
UCT Archaeology Contracts Office	Heritage & archaeological consultant	Jun 2004 - May 2012
School of Archaeology, University of Oxford	Undergraduate Tutor	Oct 2008 - Dec 2008
ACO Associates cc	Associate, Heritage & archaeological consultant	Jan 2011 - Dec 2013
ASHA Consulting (Pty) Ltd	Director, Heritage & archaeological consultant	Jan 2014 -

Memberships and affiliations:

South African Archaeological Society Council member	2004 -
Assoc. Southern African Professional Archaeologists (ASAPA) member	2006 -
ASAPA Cultural Resources Management Section member	2007 -
UCT Department of Archaeology Research Associate	2013 -
Heritage Western Cape APM Committee member	2013 -
UNISA Department of Archaeology and Anthropology Research Fellow	2014 -
Fish Hoek Valley Historical Association	2014 -

Professional Accreditation:

ASAPA membership number: 233, CRM Section member
Principal Investigator: Coastal shell middens (awarded 2007)
 Stone Age archaeology (awarded 2007)
 Grave relocation (awarded 2014)
Field Director: Rock art (awarded 2007)
 Colonial period archaeology (awarded 2007)

Fieldwork and project experience:

Extensive fieldwork as both Field Director and Principle Investigator throughout the Western and Northern Cape, and also in the western parts of the Free State and Eastern Cape as follows:

Phase 1 surveys and impact assessments:

- Project types
 - Notification of Intent to Develop applications (for Heritage Western Cape)
 - Heritage Impact Assessments (largely in the Environmental Impact Assessment or Basic Assessment context under NEMA and Section 38(8) of the NHRA, but also self-standing assessments under Section 38(1) of the NHRA)
 - Archaeological specialist studies
 - Phase 1 test excavations in historical and prehistoric sites
 - Archaeological research projects
- Development types
 - Mining and borrow pits
 - Roads (new and upgrades)
 - Residential, commercial and industrial development
 - Dams and pipe lines
 - Power lines and substations
 - Renewable energy facilities (wind energy, solar energy and hydro-electric facilities)

Phase 2 mitigation and research excavations:

- ESA open sites
 - Duinefontein, Gouda
- MSA rock shelters
 - Fish Hoek, Yzerfontein, Cederberg, Namaqualand
- MSA open sites
 - Swartland, Bushmanland, Namaqualand
- LSA rock shelters
 - Cederberg, Namaqualand, Bushmanland
- LSA open sites (inland)
 - Swartland, Franschhoek, Namaqualand, Bushmanland
- LSA coastal shell middens
 - Melkbosstrand, Yzerfontein, Saldanha Bay, Paternoster, Dwarskersbos, Infanta, Knysna, Namaqualand
- LSA burials
 - Melkbosstrand, Saldanha Bay, Namaqualand, Knysna
- Historical sites
 - Franschhoek (farmstead and well), Waterfront (fort, dump and well), Noordhoek (cottage), variety of small excavations in central Cape Town and surrounding suburbs
- Historic burial grounds
 - Green Point (Prestwich Street), V&A Waterfront (Marina Residential), Paarl

Curriculum Vitae of Dr. John Almond - Palaeontological Specialist

JOHN E. ALMOND Ph.D. (Cantab)

Natura Viva cc, PO Box 12410 Mill Street, Cape Town 8010, RSA
tel: (021) 462 3622 e-mail: naturaviva@universe.co.za

- Honours Degree in Natural Sciences (Zoology), University of Cambridge, UK (1980).
- PhD in Earth Sciences (Palaeontology), University of Cambridge, UK (1986).
- Post-doctoral Research Fellowships at University of Cambridge, UK and Tübingen University, Germany (Humboldt Research Fellow).
- Visiting Scientist at various research institutions in Europe, North America, South Africa and fieldwork experience in all these areas, as well as in North Africa.
- Scientific Officer, Council for Geoscience, RSA (1990-1998) - palaeontological research and fieldwork - especially in western RSA and Namibia.
- Managing Member, *Natura Viva* cc - a Cape Town-based company specialising in broad-based natural history education, tourism and research - especially in the Arid West of Southern Africa (2000 onwards). *Natura Viva* cc produces technical reports on palaeontology, geology, botany and other aspects of natural history for public and private nature reserves.
- Current palaeontological research focuses on fossil record of the Precambrian / Cambrian boundary (especially trace fossils), and the Cape Supergroup of South Africa.
- Registered Field Guide for South Africa and Namibia
- Member of the A-team, Botanical Society of SA (Kirstenbosch Branch) - involved in teaching and training leaders for botanical excursions. Invited leader of annual Botanical Society excursions (Kirstenbosch Branch) to Little Karoo, Cederberg, Namaqualand and other areas since 2005.
- Professional training of Western and Eastern Cape Field Guides (FGASA Level 1 & 2, in conjunction with *The Gloriosa Nature Company*) and of Tourist Guides in various aspects of natural history.
- Involved in extra-mural teaching in natural history since the early 1980s. Extensive experience in public lecturing, running intensive courses and leading field excursions for professional academics as well as enthusiastic amateurs (e.g. Geological Society / Archaeological Society / Friends of the SA Museum / Cape Natural History Club / Mineral Club / Botanical Society of South Africa / SA Museum Summer & Winter School Programmes / UCT Summer School)
- Development of palaeontological teaching materials (textbooks, teachers guides, palaeontological displays) and teacher training for the new school science curriculum (GET, FET).
- Former long-standing member of Archaeology, Palaeontology and Meteorites Committee for Heritage Western Cape (HWC). Advisor on palaeontological conservation and management issues for the Palaeontological Society of South Africa (PSSA), HWC and SAHRA (including APM Permit Committee at HWC). Compilation of technical reports on provincial palaeontological heritage of Western, Northern and Eastern Cape for SAHRA and HWC.

Accredited member of PSSA and APHP (Association of Professional Heritage Practitioners, Western Cape).

- **Palaeontological impact assessments for developments in the Western Cape, Eastern Cape, Northern Cape, Free State, Northwest Province, Mpumalanga, Gauteng.**
- Several hundred **palaeontological heritage desktop studies and field assessments** completed over the past few years. Examples of recent larger projects include:
 - (1) Several major alternative energy projects (wind / solar) in the Prieska, De Aar and Cookhouse / Middleton areas (N. Cape, E. Cape)
 - (2) Palaeontological heritage survey of the Coega IDZ (E. Cape)
 - (3) On-going survey of borrow pits in the Western Cape
 - (4) Palaeontological heritage assessments for the Transnet 16 mtpa railway development, Hotazel to Coega IDZ (N. Cape, E. Cape)
 - (5) Eskom transmission line developments such as Gamma-Omega and Gamma Perseus projects (N. Cape, W. Cape, Free State)
 - (6) Mining exploration studies on the Great Karoo
 - (7) National Wind and Solar PV Strategic Environmental Assessment Specialist Report - Heritage (palaeontological component)
- **Reviews of fossil heritage** related to new 1: 250 000 geological maps published by the Council for Geoscience (Geological Survey of SA) - e.g. Clanwilliam, Loeriesfontein, Alexander Bay sheets.

Curriculum Vitae of Julian Conrad - Geohydrological Specialist

GENERAL

Nationality: South African
Profession: Geohydrologist
Specialization: Groundwater exploration, development, management and monitoring and the application of spatial technologies for geohydrological assessment and management purposes
Position in firm: Director: GEOSS -Geohydrological and Spatial Solutions International (Pty) Ltd
Language skills: English (mother tongue), Afrikaans (average).

Key skills

- Project leadership and management for the delivery of contract projects on brief, budget and time.
- Groundwater Resource Directed Measures (RDM) projects, including Reserve determinations; Classification; and Resource Quality Objectives. Groundwater Catchment Management Strategies as well as groundwater Validation and Verification. Legal compliance of groundwater use.
- Groundwater management and monitoring - database design, development and analysis of groundwater level and quality data.
- Groundwater development - borehole drilling and test pumping supervision and analysis.
- Groundwater exploration - (aerial photo interpretation, resistivity, magnetic and EM34 geophysical surveys for borehole siting purposes)
- Specialization in Geographical Information Systems (GIS) for geohydrological application.

Educational and professional status

Qualifications

1995: M.Sc. (Hydrogeology and GIS) University of Rhode Island, United States of America.
1985: B.Sc. (Hon) (Engineering geology) University of Natal, Durban, South Africa.
1984: B.Sc. (Geology) University of Natal, Durban, South Africa.

Courses

2010 Introduction to QGIS (GISSA) / Skills Presentation (Elsabé Daneel Productions cc)
2006 South African Groundwater Decision Tool (SAGDT)
2004 Fractured Rock Aquifer Assessment / 2001 Isotope Techniques in Catchment Management
2000 Groundwater Recharge
1999 Remote Sensing and Geohydrology / Applied 3D Groundwater Modelling (MODFLOW)
1997 Avenue Programming / 1995 ArcView (GIMS)
1991 Advanced training on Arc/Info (DWA&F) / 1990 Pump test analysis (IGS-UOFS).

Memberships

- International Association of Hydrogeologists (IAH)
- Geological Society of South Africa (GSSA) / Groundwater Division of the Geological Society of South Africa
- Water Institute of South Africa (WISA)
- Geo-Information Society of South Africa (GISSA)
- South African Council for Natural Scientific Professions (SACNASP)

EMPLOYMENT RECORD

1 March 2001 - present: Founded GEOSS - a company specializing in geohydrology
1 May 1990 - 28 Feb. 2001 Hydrogeologist with Environmentek, Groundwater Group, CSIR
Jan. 1986 - Dec. 1988 Geotechnical geologist with Rössing Uranium Limited, Namibia

RELEVANT EXPERIENCE

- 25 years' experience in geohydrology, including the development of the GRDM and Water Resources Classification methodologies. This includes work in Validation and Verification projects and the development of the groundwater component of Catchment Management Strategies.
- Numerous groundwater exploration; development; monitoring and management projects have been completed.
- Numerous Environmental Impact Assessment (EIA) projects have been completed, that have triggered groundwater studies, both at the Scoping and EIA phases.
- Project management of numerous groundwater projects and large projects that have included many sub-consultants and specialists, especially RDM studies.

PUBLICATIONS (DETAILS ON REQUEST)

Curriculum Vitae of Charles Peek - Geohydrological Specialist

GENERAL

Nationality: South African
Profession: Geohydrologist
Specialization: Groundwater exploration, development, monitoring and management including GIS and Remote Sensing expertise.
Position in firm: Geohydrologist at GEOSS - Geohydrological and Spatial Solutions International (Pty) Ltd
Date commenced: 4th February 2013
Language skills: English (good - speaking, reading and writing)
Afrikaans (fair - speaking, reading and writing).

Key skills

- Groundwater exploration, development, monitoring and management.
- Arc GIS software (ESRI products)
- Proficient in working with and analysis of SPOT and Landsat imagery, using ERDAS, PCI Geoinformatica, eCognition, and ENVI

RELEVANT EXPERIENCE

- Numerous groundwater exploration, development, monitoring and management projects.
- Extensive satellite image data processing (including geo-referencing) for the Validation and Verification projects within the Breede-Overberg Catchment Management Agency.

EDUCATIONAL AND PROFESSIONAL STATUS

Qualifications

2012 BSc Hon - Geoinformatics University of the Stellenbosch, South Africa
2011 BSc - Earth Science Degree: University of the Stellenbosch, South Africa

Memberships

- South African Council for National Scientific Professions (SACNASP) Mem. No. 500030/13

EMPLOYMENT RECORD

February 2013 to present: GEOSS - Geohydrological and Spatial Solutions International (Pty) Ltd, Stellenbosch
April 2011 to November 2011: Central Analytical Facilities, Geography and Geo-environmental Science, University of Stellenbosch.

Curriculum Vitae of Johann Lanz - Soils Specialist

Education

- | | | |
|--|----------------------------|------------------|
| • M.Sc. (Environmental Geochemistry) | University of Cape Town | 1996 - June 1997 |
| • B.Sc. Agriculture (Soil Science, Chemistry) | University of Stellenbosch | 1992 - 1995 |
| • BA (English, Environmental & Geographical Science) | University of Cape Town | 1989 - 1991 |
| • Matric Exemption | Wynberg Boy's High School | 1983 |

Professional work experience

I am registered as a Professional Natural Scientist (Pri.Sci.Nat.) in the field of soil science, registration number 400268/12.

- **Soil Science Consultant** **Self employed** **2002 - present**

I run a soil science consulting business, servicing clients in both the environmental and agricultural industries. Typical consulting projects involve:

- Soil specialist study inputs to EIA's, SEA's and EMPR's. These have focused on impact assessments and rehabilitation on agricultural land, rehabilitation and re-vegetation of mining and industrially disturbed and contaminated soils, as well as more general aspects of soil resource management. Recent clients include: CSIR; SiVEST; Savannah Environmental; Aurecon; Subsolar; Red Cap Investments; MBB Consulting Engineers; Enviroworks; Sharples Environmental Services; Mainstream Renewable Power; Haw & Inglis; BioTherm Energy; WKN Windcurrent; Corobrik; Western Cape Provincial Department of Environmental Affairs and Development Planning; Alcan aluminium smelter (Coega); Namaqualand Restoration Initiative; AECL; Afrimat; Tiptrans.
- Soil resource evaluations and mapping for agricultural land use planning and management. Recent clients include: Zewenwacht Wine Estate, Lourensford Fruit Company; Thelema Mountain Vineyards; Delaire Wine estate; Newton-Johnson Wines; Spier Estate; Colors Fruit; Kaarsten Boerdery; Amanzi Country Estate (Port Elizabeth); Rudera Wines; Flagstone Wines; Cob Creek Estate (Jeffreys Bay); Solms Delta Wines; Dornier Wines.
- I have conducted several recent research projects focused on conservation farming, soil health and carbon sequestration.
- I have project managed the development of soil nutrition software for Farmsecure Agri Science.

- **Soil Science Consultant** **Agricultural Consultors** **1998 - end 2001**
International (Tinie du Preez)

Responsible for providing all aspects of a soil science technical consulting service directly to clients in the wine, fruit and environmental industries all over South Africa, and in Chile, South America.

- **Contracting Soil Scientist** **De Beers Namaqualand Mines** **July 1997 - Jan 1998**

Completed a contract to make recommendations on soil rehabilitation and re-vegetation of mined areas.

Publications

- Lanz, J. 2012. Soil health: sustaining Stellenbosch's roots. In: M Swilling, B Sebitosi & R Loots (eds). *Sustainable Stellenbosch: opening dialogues*. Stellenbosch: SunMedia.
- Lanz, J. 2010. Soil health indicators: physical and chemical. South African Fruit Journal, April / May 2010 issue.
- Lanz, J. 2009. Soil health constraints. South African Fruit Journal, August / September 2009 issue.
- Lanz, J. 2009. Soil carbon research. *AgriProbe*, Department of Agriculture.
- Lanz, J. 2005. Special Report: Soils and wine quality. *Wineland Magazine*.

I am a reviewing scientist for the *South African Journal of Plant and Soil*.

Curriculum Vitae of Rudolph du Toit - Social Specialist

Personal information

Name: Rudolph du Toit
Firm: Council for Scientific and Industrial Research (CSIR)
Position in Firm: Senior Environmental Planner
Profession: Environmental Planning, Assessment & Management
Date of Birth: 23 May 1978
Languages: English and Afrikaans
Marital status: Married
Email: rdutoit@csir.co.za
Telephone number: 021 888 2538 / 076 902 6479

Tertiary Education

Undergraduate

Bachelor of Arts (BA) Environmental and Development Studies
Department of Geography and Environmental Studies
University of Stellenbosch (US), 2003-2005

Bachelor of Law (LLB) (in progress)
College of Law
University of South Africa (UNISA), 2015

Honours

Bachelor of Philosophy (B.Phil.) Sustainable Development Planning and Management
School for Public Leadership
University of Stellenbosch (US), 2006

Masters

Master of Philosophy (M.Phil.) Development Planning
School of Public Leadership
University of Stellenbosch (US), 2007-2009

Employment Experienc

- 1. Organisation:** Independent contractor for the CapeNature Working for Water Project
Position: Team leader: Natural resource management (Alien clearing)
Period: 1998 to 2001
- 2. Organisation:** Magnetic South
Position: Outdoor pursuit management
Period: 2003 to 2007 (part-time during studies)
- 3. Organisation:** Strategic Environmental Focus (SEF) (Pty) Ltd.
Position: Sustainability coordinator: Environmental planning & reporting
Period: 2008 to 2010
- 4. Organisation:** Council for Scientific and Industrial Research (CSIR)
Position: Environmental Planner
Period: 2010 to present
- 5. Organisation:** University of Stellenbosch
Position: Guest lecturer: Development Planning and Environmental Analysis module (part-time)

Period: 2013 to present

6. Organisation: University of Stellenbosch
Position: External moderator: Development Planning (School for Public Leadership) (part-time)
Period: 2015

Professional Affiliations

Registered member of the South African Institute for Impact Assessment (Registration Number 2779)

Research Publications

- Du Toit, R. (2009). *Developing a Scorecard for Sustainable Transport: A Cape Town Application*. Stellenbosch University Press
- Michelle Audouin, Mike Burns, Alex Weaver, David le Maitre, Patrick O'Farrell, Rudolph du Toit, Jeanne Nel. (2015). *An Introduction to Sustainability Science and its Links to Sustainability Assessment*. In Morrison-Saunders, A. and Pope, J., Eds. *Handbook of Sustainability Assessment*. Edward Elgar Publishing, 321 -349. ISBN 978-1-78347-136-2

Conference Presentations & Papers

- Du Toit, R. (2012). *Wind Energy and Public Participation: A one-sided debate?* Proceedings of the 17th Annual Conference of the International Association for Impact Assessment South Africa: "Urban Evolution", 27 - 29 August, 2012.
- Du Toit, R. & Van der Westhuizen, C. (2013). *Strategic Environmental Assessment (SEA) as a means of building the Green Economy in South Africa: The development of a national wind and solar energy roll-out plan*. Proceedings of the OECD DAC SEA Task Team Workshop on SEA & Green Economy, Lusaka (Zambia), 17- 18 January 2013.
- Contributing author to: Dalal-Clayton, B. (2013) *The Role of Strategic Environmental Assessment in Promoting a Green Economy: Background document for the OECD DAC SEA task Team workshop on SEA & Green Economy, Lusaka, 17- 18 January 2013*. IIED, London
- Burns, M., Du Toit, R. & Schreiner, G. (2013). *Graphical Causal Loop modelling of socio-ecological systems to identify & evaluate key impact "strings"*. Proceedings of the 18th Annual Conference of the International Association for Impact Assessment South Africa: 16 - 18 September, 2013.

Key courses

- Advanced Facilitation & Experiential Learning: Team Building Institute (Pty) Ltd (2001)
- Clean Development Mechanism (CDM) Project Development Training: Danish Energy Management (Pty) Ltd (2008)
- Project Management Principles & Practice: University of Pretoria (2011)
- Integrating Sustainability with Environmental Assessment in South Africa (Presented by A. Morrison -Saunders & J. Pope): North-West University (2012)
- Sharpening the Tool: New techniques and methods in Environmental Impact Assessment: Sustainable Environmental Solutions (Pty) Ltd (2015)
- Effective Skills for Challenging Meetings & Engagements: Conflict Dynamics (2015)

Projects and Environmental Assessment Reports

The following table presents an abridged list of projects that I have been involved in, indicating my role in each project:

Environmental Impact Assessment (EIA) Experience		
Project	Role	Date
1. Basic Assessment: Bottelary Road Upgrade: Van der Merwe Venter Twenty Group and Silmore Trust	Environmental Control Officer	July 2009
2. MTN Remote Hub: Umbutho Civil & Electrical	Environmental Control Officer	July 2009
3. Basic Assessment: Hermanus (Overberg Municipality) substation upgrade & underground cable	Junior Environmental Manager and co-author	August 2009
4. Basic Assessment for the InnoWind Swellendam wind energy project: Single test turbine construction	Project Manager and Lead Author	January 2010
5. Basic Assessment for the InnoWind Heidelberg wind energy project: Single test turbine construction	Project Manager and Lead Author	January 2010
6. Basic Assessment for the InnoWind Albertinia wind energy project: Single test turbine construction	Project Manager and Lead Author	January 2010
7. Basic Assessment for the InnoWind Mossel Bay wind energy project: Single test turbine construction	Project Manager and Lead Author	January 2010
8. EIA for InnoWind Swellendam wind energy project, Western Cape	Project Manager and Lead Author	July 2010
9. EIA for InnoWind Heidelberg wind energy project, Western Cape	Project Manager and Lead Author	July 2010
10. EIA for InnoWind Albertinia wind energy project, Western Cape	Project Manager and Lead Author	July 2010
11. EIA for InnoWind Mossel Bay wind energy project, Western Cape	Project Manager and Lead Author	July 2010
12. EIA for the Electrawinds (NL) Coega IDZ Wind Energy Project: Proposed construction of 75 MW installed capacity	Project Manager	January 2010
13. EIA for Glencore Exploration (UK): On-shore and off-shore exploration drilling operation; Matanda Block, Cameroon	Project Manager	November 2010
14. EIA for Noble Energy (Cameroon): Off-shore exploration drilling, Yoyo Concession and Tilapia Exploration Block, Cameroon	Management, integration and drafting of water quality section of the EIA report.	April 2011
15. EIA for the Vleesbaai Independent Power Producer (VIPP) Wind Energy Facility near Vleesbaai	Project Manager and Lead Author	August 2012 (on-going)
16. Windlab Developments South Africa (Pty) Ltd Ishwati Emoyeni 140 MW Wind Energy EIA near Murraysburg in the Western Cape	Project Manager	September 2014 (on-going)
17. EIA for the City of Cape Town 1500 MW Gas-to-power facility, Atlantis, Western Cape	Project Leader	July 2015 (on-going)

Scoping and Environmental Impact Assessment for the proposed Development of a 75 MW Solar Photovoltaic Facility (KENHARDT PV 1) on the remaining extent of Onder Rugzeer Farm 168, north-east of Kenhardt, Northern Cape Province

Strategic Environmental Assessment (SEA) Experience		
Project	Role	Date
18. Strategic Environmental Assessment (SEA) for the Port of Saldanha: Transnet National Ports Authority (TNPA)	Project Manager and Lead Author	July 2012
19. City of Cape Town Far South Strategic Environmental Assessment (SEA)	Project Manager and Lead Author	June 2014

Specialist Study Experience		
Project	Role	Date
20. Mulilo Renewable Project Developments (Pty) Ltd Gembok Solar PV1 75MW Solar Photovoltaic EIA in the Northern Cape	Conducting the Social Impact Assessment (SIA) as part of the suite of EIA specialist studies	September 2014
21. Mulilo Renewable Project Developments (Pty) Ltd Gembok Solar PV2 75MW Solar Photovoltaic EIA in the Northern Cape	Conducting the Social Impact Assessment (SIA) as part of the suite of EIA specialist studies	September 2014
22. Mulilo Renewable Project Developments (Pty) Ltd Boven Solar PV1 75MW Solar Photovoltaic EIA in the Northern Cape	Conducting the Social Impact Assessment (SIA) as part of the suite of EIA specialist studies	September 2014
23. Scatec Solar 330 (Pty) Ltd Kenhardt PV 1 75MW Solar Photovoltaic EIA in the Northern Cape	Conducting the Social Impact Assessment (SIA) as part of the suite of EIA specialist studies	August 2015
24. Scatec Solar 350 (Pty) Ltd Kenhardt PV 2 75MW Solar Photovoltaic EIA in the Northern Cape	Conducting the Social Impact Assessment (SIA) as part of the suite of EIA specialist studies	August 2015
25. Scatec Solar 370 (Pty) Ltd Kenhardt PV 3 75MW Solar Photovoltaic EIA in the Northern Cape	Conducting the Social Impact Assessment (SIA) as part of the suite of EIA specialist studies	August 2015
26. Scatec Solar 163 (Pty) Ltd Kenhardt PV 1 - Transmission Line Basic Assessment to service the proposed Kenhardt PV 1 75MW Solar Facility in the Northern Cape	Conducting the Social Impact Assessment (SIA) as part of the suite of BA specialist studies	August 2015
27. Scatec Solar 163 (Pty) Ltd Kenhardt PV 1 - Transmission Line Basic Assessment to service the proposed Kenhardt PV 1 75MW Solar Facility in the Northern Cape	Conducting the Social Impact Assessment (SIA) as part of the suite of BA specialist studies	August 2015
28. Scatec Solar 163 (Pty) Ltd Kenhardt PV 1 - Transmission Line Basic Assessment to service the proposed Kenhardt PV 1 75MW Solar Facility in the Northern Cape	Conducting the Social Impact Assessment (SIA) as part of the suite of BA specialist studies	August 2015

Environmental Management & Sustainability Planning Experience		
Project	Role	Date
29. Working for Water (CapeNature) alien clearing project: Uniondale Poort	Team Leader: natural resource management	January 1998
30. Working for Water (CapeNature) alien clearing project: Avontuur area	Team Leader: natural resource management	March 1999
31. Working for Water (CapeNature) alien clearing project: Prince Alfred Pass area	Team Leader: natural resource management	January 2000
32. Working for Water (CapeNature) alien clearing project: Langkloof farms	Team Leader: natural resource management	February 2001
33. Qualitative Environmental Impact Analysis related to Major Incident: PetroSA Mossel	Project Manager and Lead Author	October 2010

Scoping and Environmental Impact Assessment for the proposed Development of a 75 MW Solar Photovoltaic Facility (KENHARDT PV 1) on the remaining extent of Onder Rugzeer Farm 168, north-east of Kenhardt, Northern Cape Province

Environmental Management & Sustainability Planning Experience		
Project	Role	Date
Bay GTL refinery		
34. Maseve Platinum Sustainability Assessment, Rustenburg	Project Manager	August 2011
35. Notice of Impacts Associated with Exploration Drilling in BHP Billiton Gabon's Licensed Areas of Okondja, Akieni & Lastoursville (Gabon)	Project Manager	June 2011
36. PetroSA LNG Importation Pipeline Screening Study (Saldanha Bay to Mosselbay)	Responsible investigating and assessing planning impacts	March 2014
37. Department of Environmental Affairs (DEA) National Sustainable Development Strategy and Action Plan (NSSD) 1: Monitoring & Evaluation Report	Project manager and lead author	November 2013 (on-going)
38. Apollo Brick (Pty) Ltd energy efficiency and fuel switching CDM project	Investigation of possible conversion of the energy efficiency project to an accredited CDM project	January 2008
39. Mxit Lifestyle (Pty) Ltd carbon footprint audit	Carbon audit of Mxit Lifestyle (Pty) Ltd	January 2009
40. EIA for Addax Petroleum: Off-shore exploration/appraisal drilling; Ngosso Permit, Cameroon	Research team: collection of benthic macrofauna samples and bio-indicators for water quality analysis	August 2010
41. EIA for Glencore Exploration (UK): Off-shore exploration drilling, Bolongo Block, Cameroon	Research team: collection of benthic macrofauna samples and bio-indicators for water quality analysis	February 2011
42. Integrated State of the Environment Report For Namibia (Phase 1)	Project Leader	June 2015 (on-going)
43. Guest lecturer: Stellenbosch University's Sustainability Institute (School of Public Leadership)	Guest lecturer: Theory & Practice of Sustainability Assessment	July 2013 (on-going)

EIA REPORT

APPENDIX B:

Declarations of Interest and Independence of the Environmental Assessment Practitioner and Specialists

**Scoping and Environmental Impact
Assessment** for the Proposed
Development of a 75 MW Solar
Photovoltaic Facility (KENHARDT PV 1)
on the remaining extent of Onder Rugzeer
Farm 168, north-east of Kenhardt,
Northern Cape Province

Declarations of Interest	
1. EAP	Surina Laurie
2. Ecology Specialist	Simon Bundy
3. Visual Specialist	Henry Holland
4. Heritage Specialist	Dr. Jayson Orton
5. Palaeontological Specialist	Dr. John Almond
6. Geohydrological Specialist	Julian Conrad
7. Soils Specialist	Johann Lanz
8. Social Specialist	Rudolph du Toit

Declaration of Interest: EAP

I, Surina Laurie, declare that:

- I act as the independent environmental practitioner in this application;
- I will perform the work relating to the application in an objective manner, even if this results in views and findings that are not favourable to the applicant;
- I declare that there are no circumstances that may compromise my objectivity in performing such work;
- I have expertise in conducting environmental impact assessments, including knowledge of the Act, regulations and any guidelines that have relevance to the proposed activity;
- I will comply with the Act, Regulations and all other applicable legislation;
- I will take into account, to the extent possible, the matters listed in regulation 8 of the Regulations when preparing the application and any report relating to the application;
- I have no, and will not engage in, conflicting interests in the undertaking of the activity;
- I undertake to disclose to the applicant and the competent authority all material information in my possession that reasonably has or may have the potential of influencing - any decision to be taken with respect to the application by the competent authority; and - the objectivity of any report, plan or document to be prepared by myself for submission to the competent authority;
- I will ensure that information containing all relevant facts in respect of the application is distributed or made available to interested and affected parties and the public and that participation by interested and affected parties is facilitated in such a manner that all interested and affected parties will be provided with a reasonable opportunity to participate and to provide comments on documents that are produced to support the application;
- I will ensure that the comments of all interested and affected parties are considered and recorded in reports that are submitted to the competent authority in respect of the application, provided that comments that are made by interested and affected parties in respect of a final report that will be submitted to the competent authority may be attached to the report without further amendment to the report;
- I will keep a register of all interested and affected parties that participated in a public participation process;
- I will provide the competent authority with access to all information at my disposal regarding the application, whether such information is favourable to the applicant or not;
- I will provide the competent authority any information that is provided by the EAP to interested and affected parties and any responses; by the EAP to comments or inputs made by interested or affected parties;
- I affirm that the information provided in this report includes input and recommendations from specialist reports where relevant;
- the information provided in this report has been sourced from relevant literature, legislation, previous studies and specialist input and is therefore believed to be correct;
- I will perform all other obligations as expected from an environmental assessment practitioner in terms of the Regulations; and
- I realise that a false declaration is an offence in terms of regulation 48 and is punishable in terms of section 24F of the Act.

Signed at Stellenbosch on the 29th of February
2016

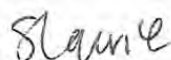

Environmental Assessment Practitioner

Declaration of Interest: Simon Bundy

I, Simon C Bundy, as the appointed independent specialist, in terms of the 2014 EIA Regulations, hereby declare that I:

- I act as the independent specialist in this application;
- I perform the work relating to the application in an objective manner, even if this results in views and findings that are not favourable to the applicant;
- regard the information contained in this report as it relates to my specialist input/study to be true and correct, and do not have and will not have any financial interest in the undertaking of the activity, other than remuneration for work performed in terms of the NEMA, the Environmental Impact Assessment Regulations, 2014 and any specific environmental management Act;
- I declare that there are no circumstances that may compromise my objectivity in performing such work;
- I have expertise in conducting the specialist report relevant to this application, including knowledge of the Act, Regulations and any guidelines that have relevance to the proposed activity;
- I will comply with the Act, Regulations and all other applicable legislation;
- I have no, and will not engage in, conflicting interests in the undertaking of the activity;
- I have no vested interest in the proposed activity proceeding;
- I undertake to disclose to the applicant and the competent authority all material information in my possession that reasonably has or may have the potential of influencing - any decision to be taken with respect to the application by the competent authority; and - the objectivity of any report, plan or document to be prepared by myself for submission to the competent authority;
- I have ensured that information containing all relevant facts in respect of the specialist input/study was distributed or made available to interested and affected parties and the public and that participation by interested and affected parties was facilitated in such a manner that all interested and affected parties were provided with a reasonable opportunity to participate and to provide comments on the specialist input/study;
- I have ensured that the comments of all interested and affected parties on the specialist input/study were considered, recorded and submitted to the competent authority in respect of the application;
- all the particulars furnished by me in this specialist input/study are true and correct; and
- I realise that a false declaration is an offence in terms of regulation 48 and is punishable in terms of section 24F of the Act.

Signature of the specialist: _____



Name of Specialist: Simon C Bundy

Date: 8 February 2016



environmental affairs

Department:
Environmental Affairs
REPUBLIC OF SOUTH AFRICA

DETAILS OF SPECIALIST AND DECLARATION OF INTEREST

File Reference Number:	(For official use only) 12/12/20/ or 12/9/11/L
NEAS Reference Number:	DEA/EIA
Date Received:	

Application for integrated environmental authorisation and waste management licence in terms of the-

- (1) National Environmental Management Act, 1998 (Act No. 107 of 1998), as amended and the Environmental Impact Assessment Regulations, 2014; and
- (2) National Environmental Management Act: Waste Act, 2008 (Act No. 59 of 2008) and Government Notice 921, 2013

PROJECT TITLE

Scoping and Environmental Impact Assessment for the Proposed Development of a 75 MW Solar Photovoltaic Facility (KENHARDT PV 1) on the remaining extent of Onder Rugzeer Farm 168, north-east of Kenhardt, Northern Cape Province

Specialist:	SDP Ecological and Environmental Services		
Contact person:	Simon C Bundy		
Postal address:	P O Box 1016, Ballito		
Postal code:	4420	Cell:	082 446 4847
Telephone:	032-9460685	Fax:	032-9460784
E-mail:	simon@ecocoast.co.za		
Professional affiliation(s) (if any)	SACNASP 400093/06		

Project Consultant:	Council for Scientific and Industrial Research (CSIR)		
Contact person:	Surina Laurie		
Postal address:	PO Box 320, Stellenbosch		
Postal code:	7599	Cell:	082 468 0962
Telephone:	021 888 2490 or 021 888 2661	Fax:	021 888 2693
E-mail:	SLaurie@csir.co.za		

4.2 The specialist appointed in terms of the Regulations_

I, Simon C Bundy _____, declare that –

General declaration:

I act as the independent specialist in this application;
I will perform the work relating to the application in an objective manner, even if this results in views and findings that are not favourable to the applicant;
I declare that there are no circumstances that may compromise my objectivity in performing such work;
I have expertise in conducting the specialist report relevant to this application, including knowledge of the Act, Regulations and any guidelines that have relevance to the proposed activity;
I will comply with the Act, Regulations and all other applicable legislation;
I have no, and will not engage in, conflicting interests in the undertaking of the activity;
I undertake to disclose to the applicant and the competent authority all material information in my possession that reasonably has or may have the potential of influencing - any decision to be taken with respect to the application by the competent authority; and - the objectivity of any report, plan or document to be prepared by myself for submission to the competent authority;
all the particulars furnished by me in this form are true and correct; and
I realise that a false declaration is an offence in terms of regulation 48 and is punishable in terms of section 24F of the Act.

Signature of the specialist:

SDP Ecological and Environmental Services

Name of company (if applicable):

9 February 2016

Date:

Declaration of Interest: Henry Holland

I, Henry Holland, as the appointed independent specialist, in terms of the 2014 EIA Regulations, hereby declare that I:

- I act as the independent specialist in this application;
- I perform the work relating to the application in an objective manner, even if this results in views and findings that are not favourable to the applicant;
- regard the information contained in this report as it relates to my specialist input/study to be true and correct, and do not have and will not have any financial interest in the undertaking of the activity, other than remuneration for work performed in terms of the NEMA, the Environmental Impact Assessment Regulations, 2014 and any specific environmental management Act;
- I declare that there are no circumstances that may compromise my objectivity in performing such work;
- I have expertise in conducting the specialist report relevant to this application, including knowledge of the Act, Regulations and any guidelines that have relevance to the proposed activity;
- I will comply with the Act, Regulations and all other applicable legislation;
- I have no, and will not engage in, conflicting interests in the undertaking of the activity;
- I have no vested interest in the proposed activity proceeding;
- I undertake to disclose to the applicant and the competent authority all material information in my possession that reasonably has or may have the potential of influencing - any decision to be taken with respect to the application by the competent authority; and - the objectivity of any report, plan or document to be prepared by myself for submission to the competent authority;
- I have ensured that information containing all relevant facts in respect of the specialist input/study was distributed or made available to interested and affected parties and the public and that participation by interested and affected parties was facilitated in such a manner that all interested and affected parties were provided with a reasonable opportunity to participate and to provide comments on the specialist input/study;
- I have ensured that the comments of all interested and affected parties on the specialist input/study were considered, recorded and submitted to the competent authority in respect of the application;
- all the particulars furnished by me in this specialist input/study are true and correct; and
- I realise that a false declaration is an offence in terms of regulation 48 and is punishable in terms of section 24F of the Act.

Signature of the specialist:



Name of Specialist: Henry Holland

Date: 15 February 2016

Scoping and Environmental Impact Assessment for the proposed Development of a 75 MW Solar Photovoltaic Facility (KENHARDT PV 1) on the remaining extent of Onder Rugzeer Farm 168, north-east of Kenhardt, Northern Cape Province



environmental affairs

Department:
Environmental Affairs
REPUBLIC OF SOUTH AFRICA

DETAILS OF SPECIALIST AND DECLARATION OF INTEREST

File Reference Number:	(For official use only) 12/12/20/ or 12/9/11/L
NEAS Reference Number:	DEA/EIA
Date Received:	

Application for integrated environmental authorisation and waste management licence in terms of the-

- (1) National Environmental Management Act, 1998 (Act No. 107 of 1998), as amended and the Environmental Impact Assessment Regulations, 2014; and
- (2) National Environmental Management Act: Waste Act, 2008 (Act No. 59 of 2008) and Government Notice 921, 2013

PROJECT TITLE

Scoping and Environmental Impact Assessment for the Proposed Development of a 75 MW Solar Photovoltaic Facility (KENHARDT PV 1) on the remaining extent of Onder Rugzeer Farm 168, north-east of Kenhardt, Northern Cape Province

Specialist:	Visual Specialist	
Contact person:	Henry Holland	
Postal address:	8 Cathcart Street	
Postal code:	6139	Cell: 082 2266689
Telephone:	046 6228735	Fax:
E-mail:	hholland@gmail.com	
Professional affiliation(s) (if any)		

Project Consultant:	Council for Scientific and Industrial Research (CSIR)	
Contact person:	Surina Laurie	
Postal address:	PO Box 320, Stellenbosch	
Postal code:	7599	Cell: 082 468 0962
Telephone:	021 888 2490 or 021 888 2661	Fax: 021 888 2693
E-mail:	SLaurie@csir.co.za	

4.2 The specialist appointed in terms of the Regulations_

I, Henry Holland, declare that—

General declaration:

I act as the independent specialist in this application;
I will perform the work relating to the application in an objective manner, even if this results in views and findings that are not favourable to the applicant;
I declare that there are no circumstances that may compromise my objectivity in performing such work;
I have expertise in conducting the specialist report relevant to this application, including knowledge of the Act, Regulations and any guidelines that have relevance to the proposed activity;
I will comply with the Act, Regulations and all other applicable legislation;
I have no, and will not engage in, conflicting interests in the undertaking of the activity;
I undertake to disclose to the applicant and the competent authority all material information in my possession that reasonably has or may have the potential of influencing - any decision to be taken with respect to the application by the competent authority, and - the objectivity of any report, plan or document to be prepared by myself for submission to the competent authority;
all the particulars furnished by me in this form are true and correct; and
I realise that a false declaration is an offence in terms of regulation 48 and is punishable in terms of section 24F of the Act.

Henry Holland
Signature of the specialist:

Name of company (if applicable):

08 February 2018
Date:

Declaration of Interest: Dr. Jayson Orton

I, Jayson Orton, as the appointed independent specialist, in terms of the 2014 EIA Regulations, hereby declare that I:

- I act as the independent specialist in this application;
- I perform the work relating to the application in an objective manner, even if this results in views and findings that are not favourable to the applicant;
- regard the information contained in this report as it relates to my specialist input/study to be true and correct, and do not have and will not have any financial interest in the undertaking of the activity, other than remuneration for work performed in terms of the NEMA, the Environmental Impact Assessment Regulations, 2014 and any specific environmental management Act;
- I declare that there are no circumstances that may compromise my objectivity in performing such work;
- I have expertise in conducting the specialist report relevant to this application, including knowledge of the Act, Regulations and any guidelines that have relevance to the proposed activity;
- I will comply with the Act, Regulations and all other applicable legislation;
- I have no, and will not engage in, conflicting interests in the undertaking of the activity;
- I have no vested interest in the proposed activity proceeding;
- I undertake to disclose to the applicant and the competent authority all material information in my possession that reasonably has or may have the potential of influencing - any decision to be taken with respect to the application by the competent authority; and - the objectivity of any report, plan or document to be prepared by myself for submission to the competent authority;
- I have ensured that information containing all relevant facts in respect of the specialist input/study was distributed or made available to interested and affected parties and the public and that participation by interested and affected parties was facilitated in such a manner that all interested and affected parties were provided with a reasonable opportunity to participate and to provide comments on the specialist input/study;
- I have ensured that the comments of all interested and affected parties on the specialist input/study were considered, recorded and submitted to the competent authority in respect of the application;
- all the particulars furnished by me in this specialist input/study are true and correct; and
- I realise that a false declaration is an offence in terms of regulation 48 and is punishable in terms of section 24F of the Act.

Signature of the specialist: _____

Name of Specialist: JAYSON ORTON

Date: 01 FEBRUARY 2016



environmental affairs

Department:
Environmental Affairs
REPUBLIC OF SOUTH AFRICA

DETAILS OF SPECIALIST AND DECLARATION OF INTEREST

File Reference Number:	(For official use only)
NEAS Reference Number:	12/12/201 or 12/9/11/L
Date Received:	DEA/EIA

Application for integrated environmental authorisation and waste management licence in terms of the-

- (1) National Environmental Management Act, 1998 (Act No. 107 of 1998), as amended and the Environmental Impact Assessment Regulations, 2014; and
- (2) National Environmental Management Act: Waste Act, 2008 (Act No. 59 of 2008) and Government Notice 921, 2013

PROJECT TITLE
Scoping and Environmental Impact Assessment for the Proposed Development of a 75 MW Solar Photovoltaic Facility (KENHARDT PV 1) on the remaining extent of Onder Rugzeer Farm 168, north-east of Kenhardt, Northern Cape Province

Specialist:	ASHA Consulting (Pty) Ltd		
Contact person:	Dr Jayson Orton		
Postal address:	6A Scarborough Road, Muizenberg		
Postal code:	7945	Cell:	083 272 3225
Telephone:	021 788 8425	Fax:	n/a
E-mail:	jayson@asha-consulting.co.za		
Professional affiliation(s) (if any)	ASAPA CRM Section member #233 APHP accredited professional heritage practitioner		
Project Consultant:	Council for Scientific and Industrial Research (CSIR)		
Contact person:	Surima Laurie		
Postal address:	PO Box 320, Stellenbosch		
Postal code:	7609	Cell:	082 468 0962
Telephone:	021 888 2490 or 021 888 2661	Fax:	021 888 2693
E-mail:	SLaurie@csir.co.za		

4.2 The specialist appointed in terms of the Regulations

I, JAYSON ORTON, declare that -

General declaration:

I act as the independent specialist in this application;
I will perform the work relating to the application in an objective manner, even if this results in views and findings that are not favourable to the applicant;
I declare that there are no circumstances that may compromise my objectivity in performing such work;
I have expertise in conducting the specialist report relevant to this application, including knowledge of the Act, Regulations and any guidelines that have relevance to the proposed activity;
I will comply with the Act, Regulations and all other applicable legislation;
I have no, and will not engage in, conflicting interests in the undertaking of the activity;
I undertake to disclose to the applicant and the competent authority all material information in my possession that reasonably has or may have the potential of influencing - any decision to be taken with respect to the application by the competent authority; and - the objectivity of any report, plan or document to be prepared by myself for submission to the competent authority;
all the particulars furnished by me in this form are true and correct; and
I realise that a false declaration is an offence in terms of regulation 48 and is punishable in terms of section 24F of the Act.

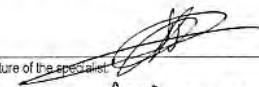
Signature of the specialist: 
Name of company (if applicable): ASHA CONSULTING (PTY) LTD
Date: 27-01-2016

Declaration of Interest: Dr. John Almond

I, Dr John Edward Almond, as the appointed independent specialist, in terms of the 2014 EIA Regulations, hereby declare that I:

- I act as the independent specialist in this application;
- I perform the work relating to the application in an objective manner, even if this results in views and findings that are not favourable to the applicant;
- regard the information contained in this report as it relates to my specialist input/study to be true and correct, and do not have and will not have any financial interest in the undertaking of the activity, other than remuneration for work performed in terms of the NEMA, the Environmental Impact Assessment Regulations, 2014 and any specific environmental management Act;
- I declare that there are no circumstances that may compromise my objectivity in performing such work;
- I have expertise in conducting the specialist report relevant to this application, including knowledge of the Act, Regulations and any guidelines that have relevance to the proposed activity;
- I will comply with the Act, Regulations and all other applicable legislation;
- I have no, and will not engage in, conflicting interests in the undertaking of the activity;
- I have no vested interest in the proposed activity proceeding;
- I undertake to disclose to the applicant and the competent authority all material information in my possession that reasonably has or may have the potential of influencing - any decision to be taken with respect to the application by the competent authority; and - the objectivity of any report, plan or document to be prepared by myself for submission to the competent authority;
- I have ensured that information containing all relevant facts in respect of the specialist input/study was distributed or made available to interested and affected parties and the public and that participation by interested and affected parties was facilitated in such a manner that all interested and affected parties were provided with a reasonable opportunity to participate and to provide comments on the specialist input/study;
- I have ensured that the comments of all interested and affected parties on the specialist input/study were considered, recorded and submitted to the competent authority in respect of the application;
- all the particulars furnished by me in this specialist input/study are true and correct; and
- I realize that a false declaration is an offence in terms of regulation 48 and is punishable in terms of section 24F of the Act.



Signature of the specialist:

Name of Specialist: Dr John Edward Almond

Date: 29 January 2016

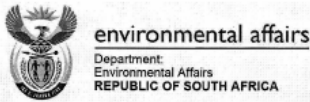

environmental affairs

Department:
Environmental Affairs
REPUBLIC OF SOUTH AFRICA

DETAILS OF SPECIALIST AND DECLARATION OF INTEREST

File Reference Number:	(For official use only) 12/12/20/ or 12/9/11/L
NEAS Reference Number:	DEA/EIA
Date Received:	

Application for integrated environmental authorisation and waste management licence in terms of the-

- (1) National Environmental Management Act, 1998 (Act No. 107 of 1998), as amended and the Environmental Impact Assessment Regulations, 2014; and
- (2) National Environmental Management Act: Waste Act, 2008 (Act No. 59 of 2008) and Government Notice 921, 2013

PROJECT TITLE

Scoping and Environmental Impact Assessment for the Proposed Development of a 75 MW Solar Photovoltaic Facility (KENHARDT PV 1) on the remaining extent of Onder Rugzeer Farm 168, north-east of Kenhardt, Northern Cape Province

Specialist:	Dr John E. Almond
Contact person:	As above
Postal address:	PO Box 12410 Mill Street, CAPE TOWN, RSA
Postal code:	8010
Telephone:	0211 462 3622
E-mail:	almond@universe.co.za
Professional affiliation(s) (if any)	Palaeontological Society of Southern Africa, Association of Professional Heritage Practitioners (WCape)
Project Consultant:	Council for Scientific and Industrial Research (CSIR)
Contact person:	Surina Laurie
Postal address:	PO Box 320, Stellenbosch
Postal code:	7599
Telephone:	021 888 2490 or 021 888 2661
E-mail:	SLaurie@csir.co.za

4.2 The specialist appointed in terms of the Regulations

I, Dr. John Edward Almond, declare that -- General declaration:

I act as the independent specialist in this application;
I will perform the work relating to the application in an objective manner, even if this results in views and findings that are not favourable to the applicant;
I declare that there are no circumstances that may compromise my objectivity in performing such work;
I have expertise in conducting the specialist report relevant to this application, including knowledge of the Act, Regulations and any guidelines that have relevance to the proposed activity;
I will comply with the Act, Regulations and all other applicable legislation;
I have no, and will not engage in, conflicting interests in the undertaking of the activity;
I undertake to disclose to the applicant and the competent authority all material information in my possession that reasonably has or may have the potential of influencing - any decision to be taken with respect to the application by the competent authority; and - the objectivity of any report, plan or document to be prepared by myself for submission to the competent authority;
all the particulars furnished by me in this form are true and correct; and
I realise that a false declaration is an offence in terms of regulation 48 and is punishable in terms of section 24F of the Act.

Signature of the specialist:

John E. Almond

Name of company (if applicable):

NATURA VIVA CC

Date:

8 February 2016

Declaration of Interest: Julian Conrad

I, **Julian Conrad**, as the appointed independent specialist, in terms of the 2014 EIA Regulations, hereby declare that I:

- I act as the independent specialist in this application;
- I perform the work relating to the application in an objective manner, even if this results in views and findings that are not favourable to the applicant;
- regard the information contained in this report as it relates to my specialist input/study to be true and correct, and do not have and will not have any financial interest in the undertaking of the activity, other than remuneration for work performed in terms of the NEMA, the Environmental Impact Assessment Regulations, 2014 and any specific environmental management Act;
- I declare that there are no circumstances that may compromise my objectivity in performing such work;
- I have expertise in conducting the specialist report relevant to this application, including knowledge of the Act, Regulations and any guidelines that have relevance to the proposed activity;
- I will comply with the Act, Regulations and all other applicable legislation;
- I have no, and will not engage in, conflicting interests in the undertaking of the activity;
- I have no vested interest in the proposed activity proceeding;
- I undertake to disclose to the applicant and the competent authority all material information in my possession that reasonably has or may have the potential of influencing - any decision to be taken with respect to the application by the competent authority; and - the objectivity of any report, plan or document to be prepared by myself for submission to the competent authority;
- I have ensured that information containing all relevant facts in respect of the specialist input/study was distributed or made available to interested and affected parties and the public and that participation by interested and affected parties was facilitated in such a manner that all interested and affected parties were provided with a reasonable opportunity to participate and to provide comments on the specialist input/study;
- I have ensured that the comments of all interested and affected parties on the specialist input/study were considered, recorded and submitted to the competent authority in respect of the application;
- all the particulars furnished by me in this specialist input/study are true and correct; and
- I realise that a false declaration is an offence in terms of regulation 48 and is punishable in terms of section 24F of the Act.



Signature of the specialist

Name of company: GEOSS - Geohydrological & Spatial Solutions International (Pty) Ltd.

Professional Registration (including number): SACNASP - 400159/05

Date: 21 February 2016.

Scoping and Environmental Impact Assessment for the proposed Development of a 75 MW Solar Photovoltaic Facility (KENHARDT PV 1) on the remaining extent of Onder Rugzeer Farm 168, north-east of Kenhardt, Northern Cape Province



environmental affairs

Department:
Environmental Affairs
REPUBLIC OF SOUTH AFRICA

DETAILS OF SPECIALIST AND DECLARATION OF INTEREST

File Reference Number:	(For official use only) 12/12/20/ or 12/9/11/L
NEAS Reference Number:	DEA/EIA
Date Received:	

Application for integrated environmental authorisation and waste management licence in terms of the-

- (1) National Environmental Management Act, 1998 (Act No. 107 of 1998), as amended and the Environmental Impact Assessment Regulations, 2014; and
- (2) National Environmental Management Act: Waste Act, 2008 (Act No. 59 of 2008) and Government Notice 921, 2013

PROJECT TITLE

Scoping and Environmental Impact Assessment for the Proposed Development of a 75 MW Solar Photovoltaic Facility (KENHARDT PV 1) on the remaining extent of Onder Rugzeer Farm 168, north-east of Kenhardt, Northern Cape Province

Specialist:	Geohydrological and Spatial Solutions International (Pty) Ltd	
Contact person:	Julian Conrad	
Postal address:	P O Box 12412, Die Boord, Stellenbosch	
Postal code:	7613	Cell: 082 871 5772
Telephone:	021 880 1079	Fax: 021 880 1164
E-mail:	jconrad@geoss.co.za	
Professional affiliation(s) (if any)		

Project Consultant:	Council for Scientific and Industrial Research (CSIR)	
Contact person:	Surina Laurie	
Postal address:	PO Box 320, Stellenbosch	
Postal code:	7599	Cell: 082 468 0962
Telephone:	021 888 2490 or 021 888 2661	Fax: 021 888 2693
E-mail:	SLaurie@csir.co.za	

4.2 The specialist appointed in terms of the Regulations_

Julian Conrad

I, _____, declare that --

General declaration:

I act as the independent specialist in this application;
I will perform the work relating to the application in an objective manner, even if this results in views and findings that are not favourable to the applicant;
I declare that there are no circumstances that may compromise my objectivity in performing such work;
I have expertise in conducting the specialist report relevant to this application, including knowledge of the Act, Regulations and any guidelines that have relevance to the proposed activity;
I will comply with the Act, Regulations and all other applicable legislation;
I have no, and will not engage in, conflicting interests in the undertaking of the activity;
I undertake to disclose to the applicant and the competent authority all material information in my possession that reasonably has or may have the potential of influencing - any decision to be taken with respect to the application by the competent authority; and - the objectivity of any report, plan or document to be prepared by myself for submission to the competent authority;
all the particulars furnished by me in this form are true and correct; and
I realise that a false declaration is an offence in terms of regulation 48 and is punishable in terms of section 24F of the Act.

Signature of the specialist:

Geohydrological and Spatial Solutions International (Pty) Ltd

Name of company (if applicable):

4 February 2016

Date:

Declaration of Interest: Johann Lanz

I, Johann Lanz, as the appointed independent specialist, in terms of the 2014 EIA Regulations, hereby declare that I:

- I act as the independent specialist in this application;
- I perform the work relating to the application in an objective manner, even if this results in views and findings that are not favourable to the applicant;
- regard the information contained in this report as it relates to my specialist input/study to be true and correct, and do not have and will not have any financial interest in the undertaking of the activity, other than remuneration for work performed in terms of the NEMA, the Environmental Impact Assessment Regulations, 2014 and any specific environmental management Act;
- I declare that there are no circumstances that may compromise my objectivity in performing such work;
- I have expertise in conducting the specialist report relevant to this application, including knowledge of the Act, Regulations and any guidelines that have relevance to the proposed activity;
- I will comply with the Act, Regulations and all other applicable legislation;
- I have no, and will not engage in, conflicting interests in the undertaking of the activity;
- I have no vested interest in the proposed activity proceeding;
- I undertake to disclose to the applicant and the competent authority all material information in my possession that reasonably has or may have the potential of influencing - any decision to be taken with respect to the application by the competent authority; and - the objectivity of any report, plan or document to be prepared by myself for submission to the competent authority;
- I have ensured that information containing all relevant facts in respect of the specialist input/study was distributed or made available to interested and affected parties and the public and that participation by interested and affected parties was facilitated in such a manner that all interested and affected parties were provided with a reasonable opportunity to participate and to provide comments on the specialist input/study;
- I have ensured that the comments of all interested and affected parties on the specialist input/study were considered, recorded and submitted to the competent authority in respect of the application;
- all the particulars furnished by me in this specialist input/study are true and correct; and
- I realise that a false declaration is an offence in terms of regulation 48 and is punishable in terms of section 24F of the Act.

Signature of the specialist:



Name of specialist:

Johann Lanz

Professional Registration (including number):

SACNASP Registration Number: 400268/12

Date:

05 February 2016



environmental affairs

Department:
Environmental Affairs
REPUBLIC OF SOUTH AFRICA

DETAILS OF SPECIALIST AND DECLARATION OF INTEREST

	(For official use only)
File Reference Number:	12/12/20/ or 12/9/11/L
NEAS Reference Number:	DEAT/EIA
Date Received:	

Application for integrated environmental authorisation and waste management licence in terms of the-
 (1) National Environmental Management Act, 1998 (Act No. 107 of 1998), as amended and the Environmental Impact Assessment Regulations, 2014; and
 (2) National Environmental Management Act: Waste Act, 2008 (Act No. 59 of 2008) and
 Government Notice 921, 2013

PROJECT TITLE

Scoping and Environmental Impact Assessment for the Proposed Development of a 75 MW Solar Photovoltaic Facility (KENHARDT PV 1) on the remaining extent of Onder Rugzeer Farm 168, north-east of Kenhardt, Northern Cape Province

Specialist:	Private Soil Science Consultant	
Contact person:	Johann Lanz	
Postal address:	P.O. Box 6209, UNIEDAL	
Postal code:	7612	Cell: 082 927 9018
Telephone:	021 886 1518	Fax:
E-mail:	johann@johannlanz.co.za	
Professional affiliation(s) (if any):	South African Council for Natural Scientific Professions; Soil Science Society of SA	

Project Consultant:	Council for Scientific and Industrial Research (CSIR)	
Contact person:	Surina Laurie	
Postal address:	PO Box 320, Stellenbosch	
Postal code:	7599	Cell: 082 468 0962
Telephone:	021 888 2490	Fax: 021 888 2693
E-mail:	Slaurie@csir.co.za	

4.2 The specialist appointed in terms of the Regulations

I, **Johann Lanz**, declare that

General declaration:

- I act as the independent specialist in this application
- I will perform the work relating to the application in an objective manner, even if this results in views and findings that are not favourable to the applicant
- I declare that there are no circumstances that may compromise my objectivity in performing such work;
- I have expertise in conducting the specialist report relevant to this application, including knowledge of the Act, regulations and any guidelines that have relevance to the proposed activity;
- I will comply with the Act, regulations and all other applicable legislation;
- I have no, and will not engage in, conflicting interests in the undertaking of the activity;
- I undertake to disclose to the applicant and the competent authority all material information in my possession that reasonably has or may have the potential of influencing - any decision to be taken with respect to the application by the competent authority; and - the objectivity of any report, plan or document to be prepared by myself for submission to the competent authority;
- all the particulars furnished by me in this form are true and correct; and
- I realise that a false declaration is an offence in terms of Regulation 71 and is punishable in terms of section 24F of the Act.

Signature of the specialist:

Johann Lanz – Soil Scientist (sole proprietor)

Name of company (if applicable):

09 February 2016

Date:

Declaration of Interest: Rudolph du Toit

I, **Rudolph du Toit**, as the appointed independent specialist, in terms of the 2014 EIA Regulations, hereby declare that I:

- I act as the independent specialist in this application;
- I perform the work relating to the application in an objective manner, even if this results in views and findings that are not favourable to the applicant;
- regard the information contained in this report as it relates to my specialist input/study to be true and correct, and do not have and will not have any financial interest in the undertaking of the activity, other than remuneration for work performed in terms of the NEMA, the Environmental Impact Assessment Regulations, 2014 and any specific environmental management Act;
- I declare that there are no circumstances that may compromise my objectivity in performing such work;
- I have expertise in conducting the specialist report relevant to this application, including knowledge of the Act, Regulations and any guidelines that have relevance to the proposed activity;
- I will comply with the Act, Regulations and all other applicable legislation;
- I have no, and will not engage in, conflicting interests in the undertaking of the activity;
- I have no vested interest in the proposed activity proceeding;
- I undertake to disclose to the applicant and the competent authority all material information in my possession that reasonably has or may have the potential of influencing - any decision to be taken with respect to the application by the competent authority; and - the objectivity of any report, plan or document to be prepared by myself for submission to the competent authority;
- I have ensured that information containing all relevant facts in respect of the specialist input/study was distributed or made available to interested and affected parties and the public and that participation by interested and affected parties was facilitated in such a manner that all interested and affected parties were provided with a reasonable opportunity to participate and to provide comments on the specialist input/study;
- I have ensured that the comments of all interested and affected parties on the specialist input/study were considered, recorded and submitted to the competent authority in respect of the application;
- all the particulars furnished by me in this specialist input/study are true and correct; and
- I realise that a false declaration is an offence in terms of regulation 48 and is punishable in terms of section 24F of the Act.

Signature of the specialist:

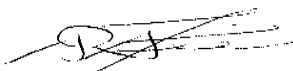

Name of Specialist: **Rudolph**

Date: **28 January 2016**

Scoping and Environmental Impact Assessment for the proposed Development of a 75 MW Solar Photovoltaic Facility (KENHARDT PV 1) on the remaining extent of Onder Rugzeer Farm 168, north-east of Kenhardt, Northern Cape Province



environmental affairs

Department:
Environmental Affairs
REPUBLIC OF SOUTH AFRICA

DETAILS OF SPECIALIST AND DECLARATION OF INTEREST

File Reference Number:	(For official use only) 12/12/20/ or 12/9/11/L
NEAS Reference Number:	DEA/EIA
Date Received:	

Application for integrated environmental authorisation and waste management licence in terms of the-

- (1) National Environmental Management Act, 1998 (Act No. 107 of 1998), as amended and the Environmental Impact Assessment Regulations, 2014; and
- (2) National Environmental Management Act: Waste Act, 2008 (Act No. 59 of 2008) and Government Notice 921, 2013

PROJECT TITLE

Scoping and Environmental Impact Assessment for the Proposed Development of a 75 MW Solar Photovoltaic Facility (KENHARDT PV 1) on the remaining extent of Onder Rugzeer Farm 168, north-east of Kenhardt, Northern Cape Province

Specialist:	Rudolph du Toit
Contact person:	Rudolph du Toit
Postal address:	PO Box 320, Stellenbosch
Postal code:	7599
Telephone:	021 888 2538
E-mail:	rdutoit@csir.co.za
Professional affiliation(s) (if any):	n/a

Project Consultant:	Council for Scientific and Industrial Research (CSIR)
Contact person:	Surina Laurie
Postal address:	PO Box 320, Stellenbosch
Postal code:	7599
Telephone:	021 888 2490 or 021 888 2661
E-mail:	SLaurie@csir.co.za

4.2 The specialist appointed in terms of the Regulations_

I, Rudolph du Toit, declare that --

General declaration:

I act as the independent specialist in this application;
I will perform the work relating to the application in an objective manner, even if this results in views and findings that are not favourable to the applicant;
I declare that there are no circumstances that may compromise my objectivity in performing such work;
I have expertise in conducting the specialist report relevant to this application, including knowledge of the Act, Regulations and any guidelines that have relevance to the proposed activity;
I will comply with the Act, Regulations and all other applicable legislation;
I have no, and will not engage in, conflicting interests in the undertaking of the activity;
I undertake to disclose to the applicant and the competent authority all material information in my possession that reasonably has or may have the potential of influencing - any decision to be taken with respect to the application by the competent authority; and - the objectivity of any report, plan or document to be prepared by myself for submission to the competent authority;
all the particulars furnished by me in this form are true and correct, and
I realise that a false declaration is an offence in terms of regulation 48 and is punishable in terms of section 24F of the Act.

Rudolph du Toit
Signature of the specialist:

CSIR
Name of company (if applicable):

20 January 2016
Date:

EIA REPORT

APPENDIX C:

Database of Interested and Affected Parties

Scoping and Environmental Impact Assessment for the Proposed Development of a 75 MW Solar Photovoltaic Facility (KENHARDT PV 1) on the remaining extent of Onder Rugzeer Farm 168, north-east of Kenhardt, Northern Cape Province

Scoping and Environmental Impact Assessment for the proposed Development of a 75 MW Solar Photovoltaic Facility (KENHARDT PV 1) on the remaining extent of Onder Rugzeer Farm 168, north-east of Kenhardt, Northern Cape Province

Number	First Name	Surname	Company/ Organisation	Deregister interest	Let 1: BID	Request to Register	Comment BID	Let 2: Notice of Release of Consultation Scoping Reports	Comment on Consultation Scoping Reports	Email: Notice of Submission of Scoping Reports to DEA	Let 3: Notice of Release of Consultation EIA Reports and BA Reports	Comment on Consultation EIA Reports and BA Reports	Email: Notice of Submission of EIA Reports and BA Reports to DEA	Let 4: Notice of EA for BAs and EIAs	Let 5: Outcome of Appeal Process
Organs of State															
1.	Mmatlala	Rabothatha	National DEA: Integrated Environmental Authorisations		X			X		X					
2.	Muhammad	Essop	National DEA: Integrated Environmental Authorisations		X			X		X					
3.	Director-General		National DEA: Biodiversity and Conservation					X							
4.	Herman	Alberts	National DEA: Integrated Environmental Authorisations							X					
5.	A	Yaphi	Provincial Department of Environment and Nature Conservation (DENC): Northern Cape		X			X		X					
6.	M	Mathews	Provincial DENC: Northern Cape		X			X		X					
7.	Samantha	De la Fontaine	Provincial DENC: Northern Cape		X	X	X	X	X	X					
8.	Elsabe	Swart	Provincial DENC: Northern Cape						X	X					
9.	Sibonelo	Mbanjwa	Provincial DENC: Northern Cape		X			X		X					
10.	Luzane	Tools-Bernado	Provincial DENC: Northern Cape						X	X					
11.	Eric	Ngxanga	ZF Mgqawu District Municipality - Municipal Manager		X			X		X					
12.	Frikkie	Ruping	ZF Mgqawu District Municipality - Environmental Manager		X			X		X					
13.	H.T	Scheepers	!Kheis Municipality - Municipal Manager		X			X		X					
14.	Gloria	Matlakala	!Kheis Municipality						X	X					
15.	JG	Lategan	Kai ! Garib Municipality - Municipal Manager		X			X		X					
16.	M.	Clarke	Kai ! Garib Municipality - Manager: Electromechanical							X					

Scoping and Environmental Impact Assessment for the proposed Development of a 75 MW Solar Photovoltaic Facility (KENHARDT PV 1) on the remaining extent of Onder Rugzeer Farm 168, north-east of Kenhardt, Northern Cape Province

Number	First Name	Surname	Company/ Organisation	Deregister interest	Let 1: BID	Request to Register	Comment BID	Let 2: Notice of Release of Consultation Scoping Reports	Comment on Consultation Scoping Reports	Email: Notice of Submission of Scoping Reports to DEA	Let 3: Notice of Release of Consultation EIA Reports and BA Reports	Comment on Consultation EIA Reports and BA Reports	Email: Notice of Submission of EIA Reports and BA Reports to DEA	Let 4: Notice of EA for BAs and EIAs	Let 5: Outcome of Appeal Process
			Services												
17.	Mashudu	Randwedzi	Department of Water and Sanitation		X			X							
18.	Melinda	Mei	Department of Water and Sanitation		X		X	X	X						
19.	Shaun	Cloete	Department of Water and Sanitation					X		X					
20.	Chantèl	Schwartz	Department of Water and Sanitation						X	X					
21.	Mandla	Ndzilili	Ministry of Environment and Nature Conservation		X			X		X					
22.	Mashudu	Marubini	National Department of Agriculture, Forestry and Fisheries (DAFF)		X			X		X					
23.	Thoko	Buthelezi	National DAFF - AgriLand Liaison office		X			X		X					
24.	D	Nhlakad	National DAFF - AgriLand Liaison office		X			X		X					
25.	Anneliza	Collett	National DAFF - AgriLand Liaison office		X			X		X					
26.	H. J.	Buys	National DAFF (Land Use and Soil Management)						X	X					
27.	Jacoline	Mans	Provincial DAFF		X			X	X	X					
28.	Ali	Diteme	Provincial Department of Agriculture, Land Reform & Rural Development		X			X		X					
29.	Pieter	Buys	National Energy Regulator of South Africa		X			X		X					
30.	IA	Bulane	Department of Public Works, Roads and Transport		X			X							
31.	Denver	Van Heerden	Department of Public Works, Roads and Transport		X			X		X					
32.	Rene	de kock	South African Roads Agency Limited - Northern Cape (Western Region)		X		X	X		X					

Scoping and Environmental Impact Assessment for the proposed Development of a 75 MW Solar Photovoltaic Facility (KENHARDT PV 1) on the remaining extent of Onder Rugzeer Farm 168, north-east of Kenhardt, Northern Cape Province

Number	First Name	Surname	Company/ Organisation	Deregister interest	Let 1: BID	Request to Register	Comment BID	Let 2: Notice of Release of Consultation Scoping Reports	Comment on Consultation Scoping Reports	Email: Notice of Submission of Scoping Reports to DEA	Let 3: Notice of Release of Consultation EIA Reports and BA Reports	Comment on Consultation EIA Reports and BA Reports	Email: Notice of Submission of EIA Reports and BA Reports to DEA	Let 4: Notice of EA for BAs and EIAs	Let 5: Outcome of Appeal Process
33.	Nicole	Abrahams	South African Roads Agency Limited (Western Region)						X	X					
34.	M	Lepheane	Department of Labour		X			X		X					
35.	A	Botes	Department of Social Development		X			X		X					
36.	Riaan	Warie	Northern Cape Economic Development Agency		X			X		X					
37.	Andrew	Timothy	Directorate Heritage, Department - Sports, Arts and Culture		X			X		X					
38.	Lizell	Stroh	South African Civilian Aviation Authority		X			X		X					
39.	John	Geeringh	ESKOM		X			X	X	X					
40.	Kevin	Leask	ESKOM		X			X		X					
41.	Justine	Wyngaardt	ESKOM (Western Operating Unit, Distribution)		X			X		X					
42.	Lindi	Haarhoff	ESKOM (Nieuwehoop Substation)					X		X					
43.	Sharon	Steyn	Northern Cape Chamber of Commerce and Industry		X			X		X					
44.	P.J.J	van Rensburg	Agri Northern Cape		X					X					
45.	H.	Myburgh	Agri Northern Cape ¹					X		X					
46.	Adrian	Tiplady	SKA SA		X		X	X	X	X					
47.	Marina	Lourens	Transnet Freight Rail					X	X	X					
48.	Gilbert	Nortier	Transnet Freight Rail		X		X	X		X					

¹ Note that during the Project Initiation Phase, correspondence was sent to Mr. P. J. J. van Rensburg of Agri Northern Cape. However, the CSIR was requested (via telephone), to replace Mr. P. J. J. van Rensburg with Mr. H. Myburgh on the database. Mr. P. J. J. van Rensburg has therefore been removed from the project database going forward. For record purposes, Mr. P. J. J. van Rensburg will still be reflected on the database in the EIA Reporting to show interaction during the Project Initiation Phase only.

Scoping and Environmental Impact Assessment for the proposed Development of a 75 MW Solar Photovoltaic Facility (KENHARDT PV 1) on the remaining extent of Onder Rugzeer Farm 168, north-east of Kenhardt, Northern Cape Province

Number	First Name	Surname	Company/ Organisation	Deregister interest	Let 1: BID	Request to Register	Comment BID	Let 2: Notice of Release of Consultation Scoping Reports	Comment on Consultation Scoping Reports	Email: Notice of Submission of Scoping Reports to DEA	Let 3: Notice of Release of Consultation EIA Reports and BA Reports	Comment on Consultation EIA Reports and BA Reports	Email: Notice of Submission of EIA Reports and BA Reports to DEA	Let 4: Notice of EA for BAs and EIAs	Let 5: Outcome of Appeal Process
49.	Mayvyn	Bhana	Transnet		X			X		X					
50.	Clive	Stephenson	Transnet		X			X		X					
51.	Director		Department of Energy Northern Cape		X			X							
52.	Ragna	Redelstorff	South African Heritage Resources Agency ²		X		X	X		X					
53.	Kgauta	Mokoena	Department of Mineral Resources												
54.	Elliot	Sibeko	Department of Telecommunication & Postal Services												
55.	Director		Department of Communications												
56.	Chris	Coetzee	Southern African Large Telescope (SALT) Sutherland												
57.	Raoul	Van den Berg	Southern African Large Telescope (SALT) Sutherland												
Stakeholders (NGOs and Conservation Organisations)															
58.	Simon	Gear	Birdlife South Africa		X			X		X					
59.	Lubabalo	Ntsolo	C.A.P.E. Co-ordination Unit: Northern Cape		X			X		X					
60.	Freyne	du Toit	Grasslands Society of Southern Africa		X			X		X					
61.			Endangered Wildlife Trust, Wildlife and Energy Programme		X			X		X					
62.	Dr. Howard	Hendricks	South African National Parks - Snr GM: Policy & Governance Conservation Services Division		X			X		X					
63.	Dr. Joh R	Henschel	SAEON Arid Lands Node												

² Note that submissions to the SAHRA have been made via the online SAHRIS. The details provided are those of the designated case officer assigned to the application.

Scoping and Environmental Impact Assessment for the proposed Development of a 75 MW Solar Photovoltaic Facility (KENHARDT PV 1) on the remaining extent of Onder Rugzeer Farm 168, north-east of Kenhardt, Northern Cape Province

Number	First Name	Surname	Company/ Organisation	Deregister interest	Let 1: BID	Request to Register	Comment BID	Let 2: Notice of Release of Consultation Scoping Reports	Comment on Consultation Scoping Reports	Email: Notice of Submission of Scoping Reports to DEA	Let 3: Notice of Release of Consultation EIA Reports and BA Reports	Comment on Consultation EIA Reports and BA Reports	Email: Notice of Submission of EIA Reports and BA Reports to DEA	Let 4: Notice of EA for BAs and EIAs	Let 5: Outcome of Appeal Process
64.	Praneel	Ruplal	Independent Communications Authority of South Africa (ICASA)												
Landowner															
65.	Andre	Van Niekerk	Van Niekerk Gesins Trust					X		X					
Adjacent Property Owners															
66.	Andre	Van Niekerk	Kamkuip Boerdery (Pty) Ltd		X			X		X					
67.	D.J./Sarel	Strauss	Kamkuip Boerdery (Pty) Ltd		X			X		X					
68.	Rudolph	Grobler	Farm Name: Brussel and Gerhards Puts		X			X		X					
69.	Hendrik	Van Wyk	Wilcaris Pty Ltd		X			X		X					
70.	Ernest	Connan	Ernest Connan Trust		X			X		X					
71.	Johan	Steenkamp	JHJ Steenkamp Trust		X			X		X					
72.	Handre	van Wyk	Farm Name: Narougas (Straus Heim)		X										
73.	Plankiesd	Van der Walt	Farm Name: Varsputs		X										
Additional I&APs															
74.	Mitchell	Hodgson	Scatec Solar		X			X		X					
75.	Claude	Bosman	Veroniva (PTY) Ltd - Renewable Energy		X			X		X					
76.	Naveenraj	Challa	Marcyrox NPC		X			X		X					

Scoping and Environmental Impact Assessment for the proposed Development of a 75 MW Solar Photovoltaic Facility (KENHARDT PV 1) on the remaining extent of Onder Rugzeer Farm 168, north-east of Kenhardt, Northern Cape Province

Number	First Name	Surname	Company/ Organisation	Deregister interest	Let 1: BID	Request to Register	Comment BID	Let 2: Notice of Release of Consultation Scoping Reports	Comment on Consultation Scoping Reports	Email: Notice of Submission of Scoping Reports to DEA	Let 3: Notice of Release of Consultation EIA Reports and BA Reports	Comment on Consultation EIA Reports and BA Reports	Email: Notice of Submission of EIA Reports and BA Reports to DEA	Let 4: Notice of EA for BAs and EIAs	Let 5: Outcome of Appeal Process
77.	Karen	Low	Mulilo Renewable Energy Developments		X		X	X		X					
78.	Melanie	Miles	Leads 2 Business		X	X	X	X		X					
79.	Morgan	Townsend			X	X		X		X					
80.	John	de Bruin	Henrohn Security			X	X	X		X					

EIA REPORT

APPENDIX D:

Copy of Newspaper Advertisement

Scoping and Environmental Impact Assessment for the Proposed Development of a 75 MW Solar Photovoltaic Facility (KENHARDT PV 1) on the remaining extent of Onder Rugzeer Farm 168, north-east of Kenhardt, Northern Cape Province

Newspaper Advertisement – The Gemsbok

NOTICE OF BASIC ASSESSMENT AND SCOPING AND ENVIRONMENTAL IMPACT ASSESSMENT (EIA) PROCESSES

THE PROPOSED DEVELOPMENT OF THREE SOLAR PHOTOVOLTAIC FACILITIES AND ASSOCIATED ELECTRICAL INFRASTRUCTURE NORTH-EAST OF KENHARDT, NORTHERN CAPE PROVINCE

CSIR REFERENCE: EMS0102/SCATEC/2015

Scatec Solar SA 163 (PTY) Ltd (hereinafter referred to as Scatec Solar) (i.e. the Project Applicant), is proposing to develop three 75 Megawatt (MW) Solar Photovoltaic (PV) power generation facilities and associated electrical infrastructure (132 kV transmission lines for each 75 MW facility) on the remaining extent of Onder Rugzeer Farm 168 and the connection points to the substation on the remaining extent of Portion 3 of Gemsbok Bult Farm 120, approximately 80 km south of Upington and 30 km north-east of Kenhardt within the !Kheis Local Municipality, Northern Cape Province.

In terms of the National Environmental Management Act (Act 107 of 1998, as amended) (NEMA) and the 2014 NEMA EIA Regulations promulgated in Government Gazette 38282 and Government Notice (GN) R982, R983, R984 and R985 on 8 December 2014, the proposed projects require a full Scoping and EIA Process for the construction of the three Solar PV facilities. A separate Basic Assessment Process is also required and will be undertaken for the development of the proposed transmission lines. The CSIR has been appointed by Scatec Solar to undertake the requisite Basic Assessment and Scoping and EIA Processes for the proposed projects. The proposed project potentially triggers the following listed activities:

- Basic Assessment Process: GN R983: Activity 11 (i);
- Scoping and EIA Process: GN R983: Activity 9 (i) and (ii); Activity 12 (x) and (xii); Activity 19 (i); Activity 24 (ii) and Activity 28 (ii); and GN R984: Activity 1 and Activity 15.

Since the proposed 75 MW Solar PV facilities are located within the same geographical area and constitute the same type of activity, an integrated Public Participation Process will be undertaken for the proposed projects. However, separate Applications for Environmental Authorisation (EA) will be lodged with the Competent Authority (i.e. the National Department of Environmental Affairs (DEA)) for each proposed 75 MW Solar PV facility and transmission line, which will be referred to as Kenhardt PV 1, Kenhardt PV 2, Kenhardt PV 3, Kenhardt PV 1 – Transmission Line, Kenhardt PV 2 – Transmission Line, and Kenhardt PV 3 – Transmission Line. As such, separate reports (i.e. Basic Assessment and Scoping and EIA Reports) will be compiled for each project.

To ensure that you are included on the project register, as well as to raise any issues and concerns for inclusion in the Basic Assessment and Scoping Reports, you are kindly requested to register your interest in the projects and submit any comments you may have to the CSIR (at the details indicated below) within **30 days** of this notification (i.e. by no later than **31 August 2015**). Kindly note that available project information can be accessed at the following website: <http://www.csir.co.za/eia/ScatecSolarPV/>. For more information and/or to register as an Interested and Affected Party, please contact: Rohaida Abed; CSIR; P. O. Box 17001, Congella, Durban, 4013; Phone: 031 242 2300; Fax: 031 261 2509; Email: RAbed@csir.co.za

BLADSY 4

DIE GEMSBOK

31 JULIE 2015

GEMSBOK-POFADDER: Die skoolhoof van die Laerskool Francois Visser op Pofadder wie daarvan beskuldig word dat hy skoolklasse in wooneenhede vir buitelanders wat as sonplaaswerkers werk omskep het, is ondanks die Khai Ma Gemeenskap Monitorings Forum se protes optog onlangs, weer terug in die tuig.

Volgens Erick Strauss, van die GMF, het die gemeenskap net betyds ingetree en het geen

Skoolhoof wou klasse aan buitelanders verhuur

buitelanders nog in die eenhede ingetrek nie, maar al die TV's, beddegoed ens wat reeds aangekoop is, staan tans nog netso by die skool.

Nadat die GMF glo die klagtes by verskeie departementshoofde by die Departement van Onderwys in die Namakwastreek ahangig gemaak het, het hulle besluit om gemeenskapslede en ouers van die skool in protes optog na die skool laat opruk om 'n versoekskrif te oorhandig.

Onder die klagtes word daar glo ook beweer dat die verkiesing van die skool se SBL nie heeltemal "grondwetlik" hanteer is nie.

Die GMF het in hul versoekskrif, wat aan Mnr Ruiter (adjunkhoof van onderwys in die Namakwastreek) en mnr Engelbrecht (kring bestuurder van onderwys in die Namakwastreek) oorhandig is, daarop aangedring dat die skoolhoof, mnr Fadil Faro, binne 48 uur uit sy pos verwyder moes word.

Volgens Strauss het die departement 'n dringende vergadering belê om agter die kap van die byl te kom en die gemeenskap het van die geleentheid gebruik gemaak om hulle ontvredenheid met die manier waarop die skoolhoof die skool bestuur, uit te spreek.

Na die 48 uur tydperk wat tydens die optog aan die dept onderwys gegee is om van Faro ontslae te maak, het die gemeenskap weer na die skool opgeruk, waarna Faro van die perseel verwyder moes word.

Blykbaar is die SBL ook ontbind. In gesprek met mnr Ruiter het die GemSBok vasgestel dat Faro weer terug is in sy pos.

Blykbaar is Faro die enigste een wat aan die Gr 7 leerders kan onderrig gee en daarom is hy weer, ondanks die klagtes teen hom, terug in die tuig.

Mnr Sam Ruiter het die volgende op die aantygings van die GMF te sê gehad: "Eintlik reageer die Departement nie op sulke leë niksseggende aantygings

nie. Tog wil die volgende noem: Die Departement het reeds die infrastruktuurprobleem ondersoek voordat die klagskrif ontvang is. Die skoolhoof is, in gevolge departementele prosesse tydelik gesuspendeer, sodat die saak sonder inmenging ondersoek kon word.

Nadat die ondersoek afgehandel is het die distrikbestuur op 20 Julie vergadering met die ouergemeenskap gehou, waartydens die aankondiging van die terugplasing van die skoolhoof gedoen is. Die ouergemeenskap het dit met luide applous verwelkom. Die rede vir die terugplasing soos aangevoer is dus heeltemal verkeerd."



Die Pofadder gemeenskap in oproer. Volgens die GMF dring hulle daarop aan dat die skoolhoof van Laerskool Francois Visser uit sy pos geskors word, nadat hy glo die Graad R klasse van die skool in wooneenhede vir buitelanders wou omskep.

Verdagtes vas na gewapende roof

GEMSBOK-KURUMAN: Drie verdagtes van Bankarra het, na wat soos 'n arretasie uit 'n aksie film gebeur het, onlangs op aanklag van gewapende roof en die onwettige besit van vuurwapens en ammunisie in die hof verskyn.

Daar word beweer dat op Sondag 26 Julie, 2015 omstreeks 16:30, die klaer saam met 'n vriend in Bankarra gestap het, toe hulle gestop word deur die drie verdagtes in 'n wit VW Golf.

Die mans het die 28-jarige klaer met 'n vuurwapen, messe en 'n panga bedreig en hom beroof van sy kontant en selfoon.

Polisie is onmiddellik in kennis gestel en die klaer het die polisie na 'n huis in die omgewing verwys, aangesien hy een van die verdagtes herken het.

Toe die verdagtes egter die polisie opmerk het een verdagte probeer om weg te hardloop.

So in die hardloop, gooi hy toe 'n sak op die dak van een van die huise. Die polisie het hom ingehaal en gearresteer en die sak van die dak af gehaal.

Daar was twee rewolwers en ammunisie in die sak. Pangas en meer ammunisie gekonfiskeer uit die huis.

Die VW Golf is ook op beslag gelê. Drie verdagtes tussen 27 en 35 jaar oud is in hegtenis geneem.

R3000 uit motor gesteel

GEMSBOK-UPINGTON: Die Speurtak van Upington SAPD ondersoek 'n klagte van diefstal vanuit 'n motorvoertuig nadat daar R3000 in kontant, na bewering uit 'n voertuig in Le Rouxstraat, Upington, gesteel is.

Dit is onbekend hoe toegang tot die voertuig verkry is. Niemand is in verband met die voorval in hegtenis geneem nie.

Die polisie ondersoek duur voort. Enige persoon met inligting word versoek om die Speurtak te kontak by tel. (054) 337 3400.

NG KERK UPINGTON-OOS
BASAAR & VEILING

VRYDAG, 31 JULIE 2015

Braaivleisverkope 10:00
Rouvlis & Witloflant-tafel 14:00
Teetuin & Speletjies 15:00

Gesigverf, Ballonkunsenaar, Springkasteel, Skattejag, Inkleurkompetisie en 'n Mini kar om in te speel!

AMPTELIKE OPENING 17:00

Veiling 17:30

- 1 Arabier Hings (Jack Maritz)
- 2 Dorperamme
- 10 Meatmaster oosie
- Luserniale

Navrae aan die Skriba - 054 338 0378

PADONGELUKFONDS

IS U ONLANGS ERNSTIG BESEER IN 'N MOTORONGELUK OF HET U 'N GELIEFDE VERLOOR?

OF HET U ONLANGS U PADONGELUKFONDS EIS DIREK MET DIE FONDS GESKIK?

KONTAK GERT NEL PROKUREURS BY 087 233 9188 VIR 'N GRATIS EVALUASIE VIR 'N MOONTLIKE EIS TEEN DIE PADONGELUKFONDS.

GERT NEL PROKUREURS
087 233 9188
www.gertnelincattorneys.co.za

NOTICE OF BASIC ASSESSMENT AND SCOPING AND ENVIRONMENTAL IMPACT ASSESSMENT (EIA) PROCESSES

THE PROPOSED DEVELOPMENT OF THREE SOLAR PHOTOVOLTAIC FACILITIES AND ASSOCIATED ELECTRICAL INFRASTRUCTURE NORTH-EAST OF KENHARDT, NORTHERN CAPE PROVINCE

CSIR REFERENCE: EMS0102/SCATEC/2015

Scatec Solar SA 163 (Pty) Ltd (hereinafter referred to as Scatec Solar) (i.e. the Project Applicant), is proposing to develop three 75 Megawatt (MW) Solar Photovoltaic (PV) power generation facilities and associated electrical infrastructure (132 kV transmission lines for each 75 MW facility) on the remaining extent of Onder Rugzeer Farm 168 and the connection points to the substation on the remaining extent of Portion 3 of GemSBok Bull Farm 120, approximately 80 km south of Upington and 30 km north-east of Kenhardt within the Ikheis Local Municipality, Northern Cape Province.

In terms of the National Environmental Management Act (Act 107 of 1998, as amended) (NEMA) and the 2014 NEMA EIA Regulations promulgated in Government Gazette 38282 and Government Notice (GN) R982, R983, R984 and R985 on 8 December 2014, the proposed projects require a full Scoping and EIA Process for the construction of the three Solar PV facilities. A separate Basic Assessment Process is also required and will be undertaken for the development of the proposed transmission lines. The CSIR has been appointed by Scatec Solar to undertake the requisite Basic Assessment and Scoping and EIA Processes for the proposed projects. The proposed project potentially triggers the following listed activities:

- Basic Assessment Process: GN R983: Activity 11 (i);
- Scoping and EIA Process: GN R983: Activity 9 (i) and (ii); Activity 12 (x) and (xii); Activity 19 (i); Activity 24 (i) and Activity 28 (ii); and GN R984: Activity 1 and Activity 15;

Since the proposed 75 MW Solar PV facilities are located within the same geographical area and constitute the same type of activity, an integrated Public Participation Process will be undertaken for the proposed projects. However, separate Applications for Environmental Authorisation (EA) will be lodged with the Competent Authority (i.e. the National Department of Environmental Affairs (DEA)) for each proposed 75 MW Solar PV facility and transmission line, which will be referred to as Kenhardt PV 1, Kenhardt PV 2, Kenhardt PV 3, Kenhardt PV 1 – Transmission Line, Kenhardt PV 2 – Transmission Line, and Kenhardt PV 3 – Transmission Line. As such, separate reports (i.e. Basic Assessment and Scoping and EIA Reports) will be compiled for each project.

To ensure that you are included on the project register, as well as to raise any issues and concerns for inclusion in the Basic Assessment and Scoping Reports, you are kindly requested to register your interest in the projects and submit any comments you may have to the CSIR (at the details indicated below) within **30 days** of this notification (i.e. by no later than **31 August 2015**). Kindly note that available project information can be accessed at the following website: <http://www.csir.co.za/ea/ScatecSolarPV/>. For more information and/or to register as an Interested and Affected Party, please contact: Rohaida Abed, CSIR, P. O. Box 17001, Congella, Durban, 4013; Phone: 031 242 2300; Fax: 031 261 2509; Email: RAbed@csir.co.za

Abrahams Christopher (Boere)

Dit is nou al 10 jaar dat jy weg is Boere. Die hartseer en skielik en baie groot om jou te verloor. Ons mis jou baie, maar sal jou sityd in ons harte koester.

24/12/1944
29/07/2005

Van jou vrou, kinders en kleinkinders.

GRATIS

- *BYBEL STUDIE LESSE
- *BOEKE
- *AUDIO/VIDEO LERINGE

Besoek ons webtuiste **www.coyhwh.com**

Om meer uit te vind oor:

- *Die Naam van YAHWEH
- *Yahshua die Messias
- *Die 7de Dag Sabbat
- *Die Heilige Dae
- *Wet en Genade werk saam
- En veel meer.

Kontak: Shemuel 076 196 8233
coyhwhharies@gmail.com

Met leedwese maak ons bekend die skielike afsterwe van ons ma

Johanna Pieters

Roudiens navrae: Suster Mokati 083 512 1667
Begrafnis navrae: Greg 071 913 8070

"Spread Love everywhere you go. Let no one ever come to you without leaving happier."
- Mother Teresa

16/09/1951 - 23/07/2015

Van: Sonnes & Familie

Northern Cape Arabian Horse Club Training Seminar

Presented by Jack & Fanie Maritz and Jacobus Barnard

- Basic Horsemanship
- Biting & Longline
- Show classes
- Novice
- Hunter
- Western
- Country
- Costume
- English
- Halter Training and Showing
- Conditioning & Prepping for a Show
- Exercise
- Coat care
- Main and Tail
- Face and Body Clip
- Tack •Bits •Training tack •Showing tack

7 & 8 August
Fish Eagle Estate,
Zamzikar Arabians

Contact: Jacobus Barnard 072 994 2392
Danelle Gouws 076 679 1392

Note from the CSIR: The GemSBok is a weekly newspaper which is distributed every Wednesday and made available from Wednesday to Friday; however it is dated for a Friday (in this case, 31 July 2015). The newspaper advert was distributed on 29 July 2015.

EIA REPORT

APPENDIX E:

Copies and Proof of Correspondence sent to I&APs during the Scoping Phase

Scoping and Environmental Impact Assessment for the Proposed Development of a 75 MW Solar Photovoltaic Facility (KENHARDT PV 1) on the remaining extent of Onder Rugzeer Farm 168, north-east of Kenhardt, Northern Cape Province

Copies and Proof of Correspondence Sent to I&APs for the Project Initiation Phase (Prior to the Release of the Scoping Report for I&AP Review)

Letter 1: Notification of the BA, Scoping and EIA Processes

P. O. Box 17001, Congella, Durban, 4013
Tel: 031 242 2300
Fax: 031 261 2509
Email: RAbed@csir.co.za



30 July 2015

Dear Interested and Affected Party

RE: NOTICE OF BASIC ASSESSMENT AND SCOPING AND ENVIRONMENTAL IMPACT ASSESSMENT (EIA) FOR THE PROPOSED DEVELOPMENT OF THREE SOLAR PHOTOVOLTAIC FACILITIES AND ASSOCIATED ELECTRICAL INFRASTRUCTURE NORTH-EAST OF KENHARDT, NORTHERN CAPE PROVINCE (CSIR REFERENCE: EMS0102/SCATEC/2015)

Scatec Solar SA 163 (PTY) Ltd (hereinafter referred to as Scatec Solar) (i.e. the Project Applicant), is proposing to develop three 75 Megawatt (MW) Solar Photovoltaic (PV) power generation facilities and associated electrical infrastructure (132 kV transmission lines for each 75 MW facility) on the remaining extent of Onder Rugzeer Farm 168 and the connection points to the substation on the remaining extent of Portion 3 of Gembok Built Farm 120, approximately 80 km south of Upington and 30 km north-east of Kenhardt within the IKhels Local Municipality, Northern Cape Province.

In terms of the National Environmental Management Act (Act 107 of 1998, as amended) (NEMA) and the 2014 NEMA EIA Regulations promulgated in Government Gazette 38282 and Government Notice (GN) R982, R983, R984 and R985 on 8 December 2014, the proposed projects require a full Scoping and EIA Process for the construction of the three Solar PV facilities. A separate Basic Assessment Process is also required and will be undertaken for the development of the proposed transmission lines. The CSIR has been appointed by Scatec Solar to undertake the requisite Basic Assessment and Scoping and EIA Processes for the proposed projects.

Scatec Solar is an integrated independent power producer that is focused on making solar energy a sustainable and affordable source on a global scale. Linked to enhancing its operations within South Africa, each 75 MW Solar PV facility proposed by Scatec Solar will cover an approximate area of 200 hectares (ha) and will be constructed adjacent to each other (with a collective footprint of approximately 600 ha and a combined power generation capacity of 225 MW). The proposed projects will entail the construction of the solar field, buildings, electrical infrastructure, internal access roads, and associated infrastructure and structures.

Since the proposed 75 MW Solar PV facilities are located within the same geographical area and constitute the same type of activity, an Integrated Public Participation Process will be undertaken for the proposed projects. However, separate Applications for Environmental Authorisation will be lodged with the Competent Authority (i.e. the National Department of Environmental Affairs (DEA)) for each proposed 75 MW Solar PV facility and transmission line, which will be referred to as Kenhardt PV 1, Kenhardt PV 2, Kenhardt PV 3, Kenhardt PV 1 – Transmission Line, Kenhardt PV 2 – Transmission Line, and Kenhardt PV 3 – Transmission Line. As such, separate reports (i.e. Basic Assessment and Scoping and EIA Reports) will be compiled for each project. The Project Applicant for each proposed 75 MW Solar PV facility and transmission line project will be various subsidiaries and divisions of Scatec Solar.

In line with this, notice is hereby given that Basic Assessment and Scoping and EIA Processes will be undertaken for each of the proposed 75 MW Solar PV facilities and transmission lines. In accordance with the 2014 NEMA EIA Regulations, you have been identified as an Interested and Affected Party (I&AP) and have been included on the project I&AP database.

Please find enclosed, a Background Information Document (including a Comment and Registration Form), which provides an overview of the proposed projects, as well as the potential listed activities that form part of the Basic Assessment and Scoping and EIA Processes and require Environmental Authorisation from the National DEA. The proposed project potentially triggers the following listed activities:

- Basic Assessment Process: GN R983: Activity 11 (I);
- Scoping and EIA Process: GN R983: Activity 9 (I) and (II); Activity 12 (x) and (xii); Activity 19 (I); Activity 24 (II) and Activity 28 (II); and GN R984: Activity 1 and Activity 15.

A comment and registration period of 30 days has been allocated for the review of the Background Information Document, for the submission of any issues or concerns, and for the registration of I&APs (which requires the completion of the enclosed Comment and Registration Form). Kindly complete the enclosed Comment and Registration Form and submit it to the CSIR at the contact details provided above by 31 August 2015. All comments received during this 30 day period will be recorded and included in the Basic Assessment and Scoping Reports.

Kindly note that available project information can be accessed at the following website: <http://www.csir.co.za/eia/ScatecSolarPV/>

Should you have any queries or require additional information please do not hesitate to contact the undersigned using the contact details provided above.

Sincerely,

Surina Laurie
Project Leader
CSIR Environmental Management Services

Rohalida Abed
Project Manager
CSIR Environmental Management Services

Comment and Registration Form sent with Letter 1

BASIC ASSESSMENT AND SCOPING AND ENVIRONMENTAL IMPACT ASSESSMENT (EIA) FOR THE PROPOSED DEVELOPMENT OF THREE SOLAR PHOTOVOLTAIC FACILITIES AND ASSOCIATED ELECTRICAL INFRASTRUCTURE NORTH-EAST OF KENHARDT, NORTHERN CAPE PROVINCE (KENHARDT PV 1, KENHARDT PV 2, KENHARDT PV 3, KENHARDT PV 1 – TRANSMISSION LINE, KENHARDT PV 2 – TRANSMISSION LINE, AND KENHARDT PV 3 – TRANSMISSION LINE)

CSIR REFERENCE: EMS0102/SCATEC/2015

Project Applicant: Scatec Solar SA 163 (PTY) Ltd

COMMENT AND REGISTRATION FORM

30 July 2015

Name:	Telephone:
Organisation:	Fax:
Designation:	Email:
Physical address:	Postal address:

Please indicate if you would like to register as an Interested and Affected Party (I&AP) for the proposed projects. Registration is required in order to receive further correspondence during the Basic Assessment and Scoping and EIA Processes. Please tick the appropriate box.

YES

NO

Please indicate if you have any interest (business, financial, personal or other) in the proposed projects and/or the Applications for Environmental Authorisation:

Please describe any issues or concerns you may have regarding the proposed projects, which you think should be considered during the Basic Assessment and Scoping and EIA Processes.

Please provide details of any other individuals or organisations that should be registered as I&APs:

Please complete this Comment and Registration Form by **31 August 2015** and submit it to:

Rohaida Abed
CSIR
Postal Address: P. O. Box 17001, Congella, Durban, 4013
Tel: 031 242 2300
Fax: 031 261 2509
E-mail: RAbed@csir.co.za
Project Website: <http://www.csir.co.za/eia/ScatecSolarPV/>



Background Information Document sent with Letter 1

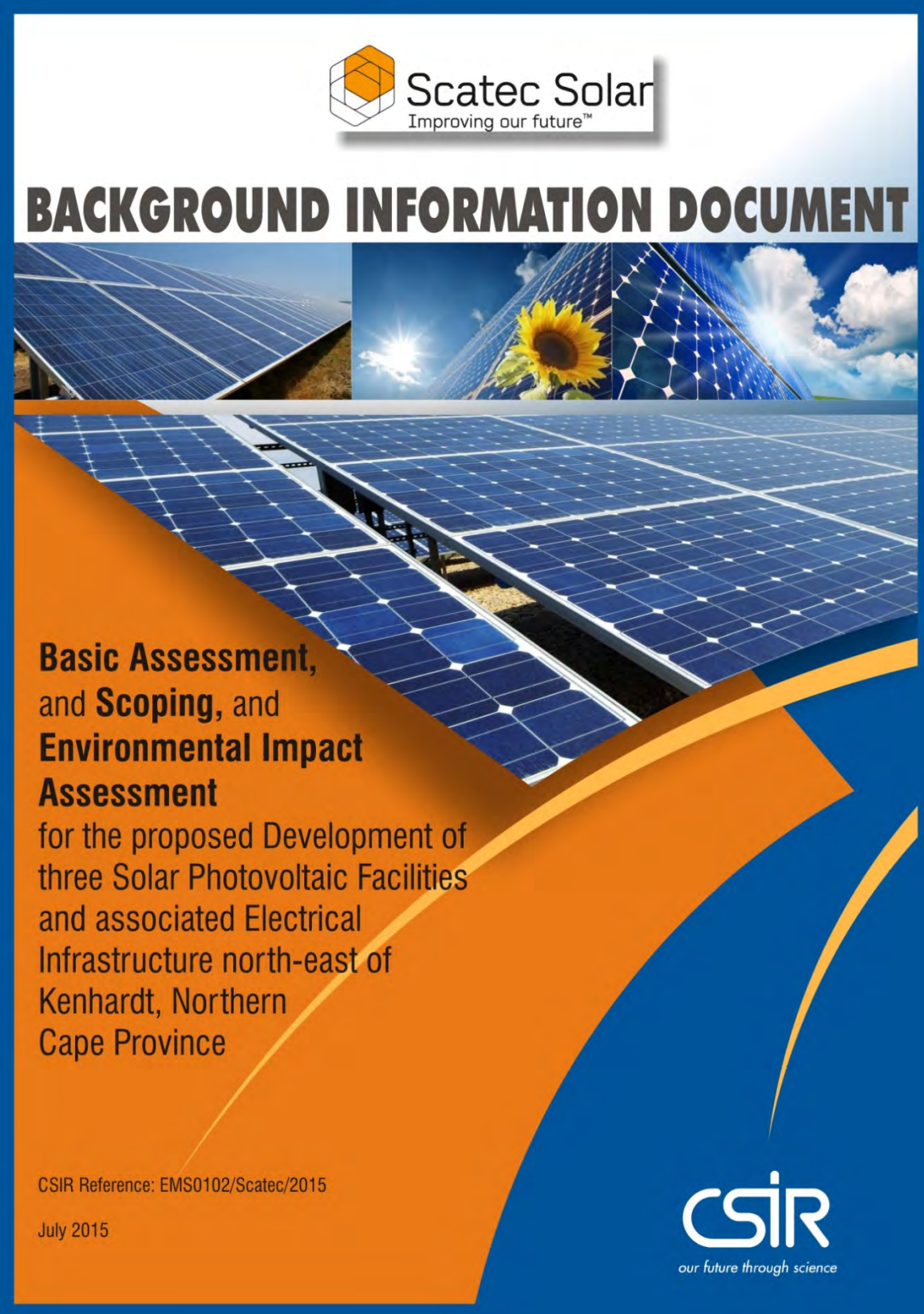

 **Scatec Solar**
Improving our future™

BACKGROUND INFORMATION DOCUMENT

**Basic Assessment,
and Scoping, and
Environmental Impact
Assessment**
for the proposed Development of
three Solar Photovoltaic Facilities
and associated Electrical
Infrastructure north-east of
Kenhardt, Northern
Cape Province

CSIR Reference: EMS0102/Scatec/2015
July 2015

our future through science

Basic Assessment and Scoping and Environmental Impact Assessment for the proposed Development of three Solar Photovoltaic Facilities and associated Electrical Infrastructure north-east of Kenhardt, Northern Cape Province

1. INTRODUCTION TO THE PROPOSED PROJECT

Scatec Solar SA 163 (PTY) Ltd (hereinafter referred to as Scatec Solar) is proposing to develop three 75 Megawatt (MW) Solar Photovoltaic (PV) power generation facilities and associated electrical infrastructure (132 kV transmission lines for each 75 MW facility) on the remaining extent of Onder Rugzeer Farm 168 and the connection points to the substation on the remaining extent of Portion 3 of Gembok Bult Farm 120, approximately 80 km south of Upington and 30 km north-east of Kenhardt within the !Kheis Local Municipality, Northern Cape Province.

Scatec Solar is an integrated independent power producer that is focused on making solar energy a sustainable and affordable source on a global scale. Scatec Solar was founded in 2001 and holds its headquarters in Norway. The company develops, builds, owns and operates a number of solar power plants internationally and within Africa. The company is growing significantly and is currently planned to provide a combined 207 MW of power in the United States, Honduras and Jordan. In addition, Scatec Solar collectively delivers more than 219 MW of power in the Czech Republic, South Africa and Rwanda. Specifically linked to investment within South Africa, Scatec Solar has been involved in the following major solar energy projects:

- The Linde Solar Plant (40 MW) is located in the Northern Cape and is considered to be the first of the large-scale PV plants in production from the second round of the Renewable Energy Independent Power Producer Programme (REIPPP).
- The Dreunberg Solar Plant (75 MW) is the only REIPPP Solar PV Project to be located in the Eastern Cape.
- The Kalkbult Solar Plant (75 MW) is located in the Northern Cape and was the first REIPPP project to be connected to the grid and operational in South Africa.

Linked to enhancing its operations within South Africa, each 75 MW Solar PV facility proposed by Scatec Solar will cover an approximate area of 200 hectares (ha) and will be constructed adjacent to each other (with a collective footprint of approximately 600 ha and a combined power generation capacity of 225 MW). The proposed projects are located in proximity to the Eskom Nieuwehoop Substation (which is currently being constructed on the farm Gembok Bult (remaining extent of Portion 3 of Farm 120)). Each proposed 132 kV transmission line will link to the Eskom Nieuwehoop Substation.

Separate Applications for Environmental Authorisation (EA) will be lodged with the Competent Authority (i.e. the National Department of Environmental Affairs (DEA)) for each proposed 75 MW Solar PV facility and transmission line, which will be referred to as:

Scoping and EIA Processes: Proposed 75 MW Solar PV Facilities	Basic Assessment Processes: Proposed 132 kV Transmission Lines
<ul style="list-style-type: none"> • Kenhardt PV 1 • Kenhardt PV 2 • Kenhardt PV 3 	<ul style="list-style-type: none"> • Kenhardt PV 1 – Transmission Line • Kenhardt PV 2 – Transmission Line • Kenhardt PV 3 – Transmission Line



BACKGROUND INFORMATION DOCUMENT

Basic Assessment and Scoping and Environmental Impact Assessment for the proposed Development of three Solar Photovoltaic Facilities and associated Electrical Infrastructure north-east of Kenhardt, Northern Cape Province

The Project Applicant for each of the above proposed projects will be various subsidiaries and divisions of Scatec Solar.

In terms of the National Environmental Management Act (Act 107 of 1998, as amended) (NEMA) and the 2014 NEMA Environmental Impact Assessment (EIA) Regulations promulgated in Government Gazette 38282 and Government Notice (GN) R982, R983, R984 and R985 on 8 December 2014, the proposed projects require a full Scoping and EIA Process for the construction of the three Solar PV facilities. A separate Basic Assessment Process is also required and will be undertaken for the development of the proposed transmission lines. The CSIR has been appointed to undertake the requisite Basic Assessment and EIA Process for the proposed projects.

Since the proposed 75 MW Solar PV facilities are located within the same geographical area and constitute the same type of activity, an integrated Public Participation Process (PPP) will be undertaken for the proposed projects. However, as mentioned above, separate Applications for EA will be lodged with the National DEA for each proposed project and as such, separate reports (i.e. Basic Assessment and Scoping and EIA Reports) will be compiled for each project.

2. NEED AND JUSTIFICATION FOR THE PROPOSED PROJECTS

At a national level, South Africa is facing serious electricity shortages as well as water scarcity. Linked to this, the proposed projects aim to supply additional electricity to the national grid. Furthermore, the urgent need to reduce greenhouse gas emissions and the importance of a secure and diversified energy supply has resulted in a global shift towards, and an increased focus on, the use of renewable energy technologies. In South Africa, national government has encouraged the utilisation of renewable energy through national policy and strategic planning. The objective is to expand electricity generation capacity in South Africa and promote the practice of sustainable development.

The Integrated Resource Plan for South Africa for the period 2010 to 2030 (hereinafter referred to as "IRP 2010") was released by government in 2010 and

proposes to develop and secure 17 800 MW of renewable energy capacity by 2030 (including wind, solar and other energy sources). The IRP 2010 has set up a target of 3 725 MW of renewable energy to be produced by Independent Power Producers (IPPs) by 2016.

Linked to this, in 2011, the Department of Energy (DOE) launched the REIPPP and invited potential IPPs to submit proposals for the financing, construction, operation and maintenance of the first 3 725 MW of onshore wind, solar thermal, solar PV, biomass, biogas, landfill gas or small hydro projects. The two main evaluation criteria for compliant proposals are price and economic development, with other selection criteria including technical feasibility and grid connectivity, environmental acceptability, black economic empowerment, community development, and local economic and manufacturing propositions. The bidders with the highest rankings (according to the aforementioned criteria) are appointed as "Preferred Bidders" by the DoE.

The proposed projects aim to contribute to the above strategic imperative.

3. WHAT DOES THIS DOCUMENT TELL YOU?

This Background Information Document (BID) provides you, as an Interested and Affected Party (I&AP), with:

- Background information on the proposed projects;
- A description of the Basic Assessment and EIA and Public Participation Processes that will be undertaken for the proposed projects; and
- Details on how to register your interest in the projects and receive further information.

As a registered I&AP, there will be opportunities for you to be involved in the Basic Assessment and Scoping and EIA Processes through receiving information, registering your interest on the project database, raising issues of concern and commenting on reports. The input from I&APs, together with the information and assessment provided by the Environmental Assessment Practitioner and relevant specialists, will assist the National DEA with their decision-making in terms of whether to grant or refuse EA for the proposed projects.

BACKGROUND INFORMATION DOCUMENT

Basic Assessment and Scoping and Environmental Impact Assessment for the proposed Development of three Solar Photovoltaic Facilities and associated Electrical Infrastructure north-east of Kenhardt, Northern Cape Province

4. WHAT DO THE PROPOSED PROJECTS ENTAIL?

The locality map (Figure 1) included with this BID provides an overview of the proposed locality of the projects on the remaining extent of Onder Rugzeer Farm 168 and their connection points on the remaining extent of Portion 3 of Gembok Bult Farm 120, north-east of Kenhardt in the Northern Cape. The proposed projects will take place on land that is owned by a third party, and as such consent will be obtained from the landowner accordingly. It is anticipated that the property on which the proposed projects will be constructed will be leased from the landowner.

Each Solar PV facility will consist of the components listed below. The components and their dimensions will be discussed within the relevant Basic Assessment and Scoping and EIA Reports produced for each facility:

Solar Field

- Solar Arrays
- Building infrastructure
 - ▶ Offices;
 - ▶ Operational control centre;
 - ▶ Warehouse/workshop;
 - ▶ Ablution facilities; and
 - ▶ Converter station.

Associated Infrastructure

- Electrical infrastructure (including transmission lines and substations);
- Access roads;
- Internal gravel roads;
- Fencing;
- Operation and Maintenance Area;
- Laydown Area;
- Stormwater channels; and
- Water pipelines.

5. ENVIRONMENTAL AUTHORISATION

In terms of the NEMA and the 2014 NEMA EIA Regulations published in GN R982, R983, R984 and R985 on 8 December 2014 in Government Gazette 38282, notice is hereby given that a Basic Assessment and full Scoping and EIA Process are required as the proposed projects include, amongst others, the following activities shown in Tables 1 and 2. Tables 1 and 2 indicate the applicable listed activities together with a summary of the listed activity in the context of the proposed project activities.

Table 1: Listed Activities for the Basic Assessment Processes – Proposed Transmission Lines

Relevant Notice and Activity Number	Description of the planned activity that relates to the applicable listed activity
GN R983: Activity 11 (i)	The proposed project will entail the construction and installation of a total of three overhead transmission lines with a capacity of 132 kV each. One transmission line will be constructed for each 75 MW Solar PV facility. The proposed project will take place on the remaining extent of Onder Rugzeer Farm 168 and the connection points to the substation will take place on the remaining extent of Portion 3 of Gembok Bult Farm 120, north-east of Kenhardt in the Northern Cape Province, outside an urban area.



Basic Assessment and Scoping and Environmental Impact Assessment for the proposed Development of three Solar Photovoltaic Facilities and associated Electrical Infrastructure north-east of Kenhardt, Northern Cape Province

Table 2: Listed Activities for the Scoping and EIA Processes – Proposed 75 MW Solar PV Facilities

Relevant Notice and Activity Number	Description of the planned activity that relates to the applicable listed activity
GN R983: Activity 9 (i) and (ii)	The proposed project will entail the construction of stormwater channels and water pipelines. These structures may exceed 1000 m in length, may have an internal diameter of 0.36 m or more, and possibly a peak throughput of 120 l/s or more.
GN R983: Activity 12 (x) and (xii)	Each proposed 75 MW Solar PV facility will entail the construction of building infrastructure and structures (such as the solar field, offices, workshops, ablution facilities, on-site substations, laydown areas and security enclosures). The buildings and infrastructure are expected to exceed a footprint of 100 m ² and some of which are likely to occur within 32 m of a watercourse.
GN R983: Activity 19 (i)	The proposed project may entail the excavation, removal and moving of more than 5 m ³ of soil, sand, pebbles or rock from the nearby watercourse. The proposed project may also entail the infilling of more than 5 m ³ of material into the nearby watercourse.
GN R983: Activity 24 (ii)	The proposed project will entail the construction of internal access roads. These roads could possibly be wider than 8 m (without a road reserve).
GN R983: Activity 28 (ii)	The proposed project will take place on the remaining extent of Onder Rugzeer Farm 168 and the connection points to the substation will take place on the remaining extent of Portion 3 of Gembok Bult Farm 120, north-east of Kenhardt in the Northern Cape. It is understood that the land is currently used for agricultural purposes. The proposed projects (i.e. commercial/industrial development) will cover a total combined footprint of approximately 600 ha.
GN R984: Activity 1	The proposed project will entail the construction of three 75 MW Solar PV facilities (i.e. facilities for the generation of electricity from a renewable resource). The proposed project will take place on the farm Onder Rugzeer 168 and the connection points to the substation will take place on the remaining extent of Portion 3 of Gembok Bult Farm 120, north-east of Kenhardt in the Northern Cape Province, outside an urban area.
GN R984: Activity 15	The total footprint of the proposed project is expected to be approximately 600 ha (i.e. 200 ha for each proposed 75 MW Solar PV facility). As a result, more than 20 ha or more of indigenous vegetation could possibly be removed for the construction of the proposed Solar PV facilities.

Note from the CSIR:

It is also important to note that a precautionary approach has been adopted by the CSIR when identifying listed activities, in that if there is any doubt at this stage of the project planning whether or not an activity is included in the project design, then the activity is listed. This list may be refined during the course of the Basic Assessment and Scoping and EIA Processes, and listed triggers may be removed or added as applicable.

The applicable listed activities require EA from the National DEA. The Basic Assessment and Scoping and EIA Process needs to show the Competent Authority, the National DEA, and the project proponent, Scatec Solar, the consequences their choices will have on the biophysical, social and economic environment. The steps in the Basic Assessment and Scoping and EIA Process are outlined below.

6. SCOPING AND EIA PROCESS

The Scoping and EIA Process being implemented can be summarised as follows:

Stage 1: Environmental Scoping:

This Scoping Process is being planned and conducted in a manner that is intended to provide sufficient information to enable the authorities to reach a decision regarding the scope of issues to be addressed in the EIA, and in particular to convey the range of specialist studies that will be included as part of the Environmental Impact Reporting Phase of the EIA, as well as the approach to these specialist studies. Within this context, the main objectives of this Scoping Process are to:

- Identify and inform a broad range of stakeholders about the proposed projects;
- Through a process of broad-based consultation with stakeholders, conduct an open, participatory and transparent Public Participation Process and facilitate the inclusion of any concerns and issues raised by stakeholders;
- Identify the relevant policies and legislation relevant to the proposed project;
- Provide the need and desirability of the proposed project, as well as the need and desirability of the project in the context of the preferred location;
- Identify and confirm the preferred activity, technology

BACKGROUND INFORMATION DOCUMENT

Basic Assessment and Scoping and Environmental Impact Assessment for the proposed Development of three Solar Photovoltaic Facilities and associated Electrical Infrastructure north-east of Kenhardt, Northern Cape Province

alternative, and preferred site (i.e. clarify the scope and nature of the proposed activities and the alternatives being considered);

- Identify and document the key issues to be addressed in the subsequent EIA Phase;
- Confirm the level of assessment required, impact assessment methodology, and the specialist input; and
- Identify suitable measures to avoid, manage or mitigate identified impacts and to determine the extent of the residual risks that need to be managed and monitored.

Stage 2: EIA:

The purpose of this stage of the EIA Process is to:

- Undertake specialist investigations to address the issues of concern that have been raised and identified through the Scoping Process.
- Assess reasonable and feasible alternatives that form part of the proposed project (including the No Go Option);
- Determine the policy and legislative context of the proposed project;
- Describe the need and desirability of the proposed project, as well as the need and desirability of the project in the context of the preferred location;
- Identify the location of the proposed development footprint within the preferred site;
- Identify the most ideal location for the proposed activity within the preferred site;
- Identify, determine and assess the significance of the predicted impacts in line with the accepted Plan of Study for EIA;
- Recommend management actions to enhance positive benefits or avoid/minimise potential negative impacts (based on specialist input); and
- Identify residual risks that need to be managed and monitored.

The following specialist studies have been identified, at this stage, to form part of the EIA Phase of the proposed projects:

- Ecological Impact Assessment (including Terrestrial Ecology, Aquatic Ecology and Avifauna);
- Visual Impact Assessment;
- Heritage Impact Assessment (Archaeology and Cultural Landscape);
- Desktop Palaeontological Impact Assessment;
- Geohydrological Assessment;
- Soils and Agricultural Potential Assessment; and
- Social Impact Assessment

7. BASIC ASSESSMENT PROCESS

The objectives of the Basic Assessment Processes being implemented will be similar to that of the Scoping and EIA Processes as explained above. The

proposed transmission lines will be assessed separately as part of a Basic Assessment Process in order to facilitate the administrative aspects surrounding the REIPPP evaluation process and potential transfer of the lines to Eskom. The abovementioned specialist studies undertaken for the Scoping and EIA Processes will feed into the Basic Assessment.

8. PUBLIC PARTICIPATION PROCESS

Public involvement forms an important component of the Basic Assessment and EIA Process by assisting in the identification of issues and alternatives to be evaluated. The following outlines the steps in the Public Participation Process which will be undertaken to run in parallel to the Basic Assessment and Scoping and EIA Processes.

Step 1: Notify Authorities and I&APs of the Basic Assessment and Scoping and EIA Processes (30 days)

The initial step entails providing notification to Authorities and potential I&APs of the proposed projects and the commencement of the Basic Assessment and Scoping and EIA Processes. An initial database of potential I&APs and Authorities will be compiled. Authorities and potential I&APs will be provided with a BID (i.e. this document), including a Comment and Registration Form and written notification. Advertisements will also be placed in a local newspaper during this phase. I&APs will be provided with a 30-day review period within which to raise any issues or concerns for inclusion in the Basic Assessment and Scoping Reports. During this review period, I&APs are required to register their interest on the project database in order to be included from the outset of the Basic Assessment and Scoping and EIA Processes.

Step 2: Preparation of Applications for EA, and Basic Assessment and Scoping Reports

Separate Applications for EA for each proposed 75 MW Solar PV facility and transmission line will be prepared (i.e. a total of six applications will be prepared). In addition, the Basic Assessment Reports will be compiled in line with Appendix 1 of the 2014 EIA Regulations (GN R982), and the Scoping Reports and Plan of Study for EIA will be compiled in line with Appendix 2 of the 2014 EIA Regulations (GN R982). All issues and concerns raised by the Authorities and I&APs during the review of the BID will be recorded and compiled into an Issues and Responses Trail for inclusion in the Basic Assessment and Scoping Reports.

Step 3: Submission of Applications for EA

Submit the Applications for EA for each proposed 75 MW Solar PV facility and transmission line (i.e. a total of six applications) to the National DEA for processing.

BACKGROUND INFORMATION DOCUMENT

Basic Assessment and Scoping and Environmental Impact Assessment for the proposed Development of three Solar Photovoltaic Facilities and associated Electrical Infrastructure north-east of Kenhardt, Northern Cape Province

Step 4: Authority and I&AP Review of the Scoping Reports (30 days)

The Scoping Reports will be released to the public for a 30-day review period. All Authorities and registered I&APs on the project database will be notified in writing of the opportunity to review the Scoping Reports. A Comment and Registration Form will also be sent with the written notification to all registered stakeholders. Copies of the Scoping Reports will be placed on the project website (<http://www.csir.co.za/eia/ScatecSolarPV/>), and at the local public library.

Step 5: Submission of Scoping Reports to the National DEA for Decision-Making

The comments received from I&APs during the 30-day review of the Scoping Reports will be recorded into a comprehensive Issues and Responses Trail, and will be included in the Scoping Reports before submission to the National DEA. The Scoping Reports will thereafter be finalised and submitted to the National DEA for decision making. All registered I&APs on the project database will be notified of the submission of the Scoping Reports.

The National DEA will have 43 days (from receipt of the Scoping Reports) to either accept the Scoping Reports with or without conditions, or refuse EA.

Step 6: Undertake Specialist Studies and Preparation of Basic Assessment and EIA Reports (including the Environmental Management Programme (EMPr))

Once the National DEA accepts the Scoping Reports, the Impact Assessment Phase may commence.

During this phase, the specialist studies (as listed above) will be undertaken and the EIA Reports (including the EMPr) will be compiled in line with the 2014 EIA Regulations and the accepted Plan of Study for EIA.

During this phase, the Basic Assessment Reports (including the EMPr) will also be compiled in line with the 2014 EIA Regulations.

Step 7: Authority and I&AP Review of the Basic Assessment and EIA Reports and EMPr (30 days)

During this phase, the Basic Assessment and EIA Reports will be released to the public for a 30-day review period. All Authorities and registered I&APs on the project database will be notified in writing of the opportunity to review the EIA Reports. A Comment and Registration Form will also be sent with the written notification to all registered stakeholders. Copies of the Basic Assessment and EIA Reports will be placed on the project website (<http://www.csir.co.za/eia/ScatecSolarPV/>), and at the local public library.

Step 8: Submission of the Basic Assessment and EIA Reports to the National DEA for Decision-Making

A key component of the Basic Assessment and EIA Process

is documenting and responding to the comments received from I&APs and Authorities. The comments received from I&APs during the 30-day review of the Basic Assessment and EIA Reports will be recorded into a comprehensive Comments and Responses Trail, and will be included in the EIA Reports before submission to the National DEA. The Comments and Responses Trail will indicate the nature of the comment, when and who raised the comment, as well as indicate how the comment received has been considered in the Basic Assessment and EIA Reports, in the project design or the EMPr. The Basic Assessment and EIA Reports will thereafter be finalised and submitted to the National DEA for decision making. All registered I&APs on the project database will be notified of the submission of the Basic Assessment and EIA Reports.

The National DEA will have 10 days (from receipt of the EIA Reports) to acknowledge the reports and will thereafter have 107 days to grant or refuse EA.

Step 9: Notification of Environmental Decision and Appeal Period

All registered stakeholders on the project database will be notified in writing of the environmental decision for the proposed projects, and will be informed of the opportunity to appeal.

HOW CAN YOU GET INVOLVED?

1. By responding to our invitation for your involvement advertised in local newspapers.
2. By mailing or faxing a Comment and Registration Form to the CSIR (contact details provided below).
3. By telephonically contacting the CSIR if you have a query, comment, or require further project information.
4. By reviewing the various reports within the stipulated comment periods provided.
5. By attending any feedback meetings, which may be held during the review period.

CSIR Contact Details:

To register as an I&AP, please complete the Comment and Registration Form included with this BID and kindly return to:

Rohaida Abed
Email: RAbed@csir.co.za
Tel: 031 242 2300
Fax: 031 261 2509
Postal Address: P. O. Box 17001, Congella,
Durban, 4013



Basic Assessment and Scoping and Environmental Impact Assessment for the proposed Development of three Solar Photovoltaic Facilities and associated Electrical Infrastructure north-east of Kenhardt, Northern Cape Province

Figure 1 – Locality Map for the Proposed Project

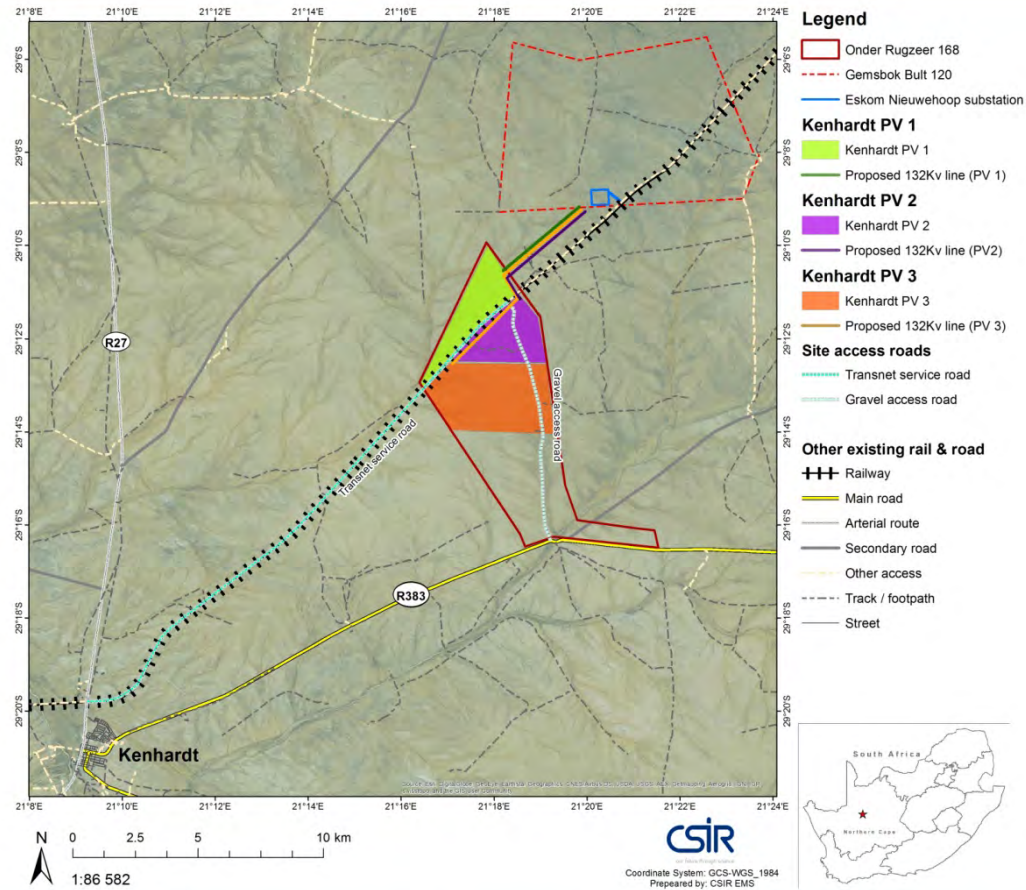

Scoping and Environmental Impact Assessment for the proposed Development of a 75 MW Solar Photovoltaic Facility (KENHARDT PV 1) on the remaining extent of Onder Rugzeer Farm 168, north-east of Kenhardt, Northern Cape Province

Proof of Correspondence with I&APs (Registered Mail Receipts for Letter 1)

**DALBRIDGE POST OFFICE
LIST OF REGISTERED MAIL FOR CSIR DURBAN – July 2015**

SCATEC SOLAR - DISTRIBUTION LIST FOR Rohaida Abed – Unit: CAS

No.	Name	Surname	Company	Designation	Postal	Registered Number Customer Copy (for CSIR)
1	Muhammad	Abdullah	National Department of Environmental Affairs: Department of Environmental Affairs: Integrated Environmental Authorisations	Competent Authority	Private Bag X447 Pretoria 0001	REGISTERED LETTER (with a domestic insurance option) R.C. 073 712 466 Z.A. CUSTOMER COPY 301028H
2	Muhammad	Essop	National Department of Environmental Affairs: Department of Environmental Affairs: Integrated Environmental Authorisations	Competent Authority	Private Bag X447 Pretoria 0002	REGISTERED LETTER (with a domestic insurance option) R.C. 073 712 506 Z.A. CUSTOMER COPY 301028H
3	A	Yaphi	Provincial Department of Environment and Nature Conservation: Northern Cape	Provincial Environmental Authority	Private Bag X6102 Kimberley 8300	REGISTERED LETTER (with a domestic insurance option) R.C. 073 712 516 Z.A. CUSTOMER COPY 301028R
4	M	Mathews	Provincial Department of Environment and Nature Conservation: Northern Cape	Provincial Environmental Authority	Private Bag X6102 Kimberley 8300	REGISTERED LETTER (with a domestic insurance option) R.C. 073 712 533 Z.A. CUSTOMER COPY 301028R
5	Mr Eric	Ngxanga	ZF Mgcawu District Municipality - Municipal Manager	Municipal Manager	Private Bag X6039 Upington 8800	REGISTERED LETTER (with a domestic insurance option) R.C. 073 712 537 Z.A. CUSTOMER COPY 301028R
6	H.T	Scheepers	IKhels Municipality - Municipal Manager	Municipal Manager	Private Bag X2, Oranje Street 97, Groblershoop 8850	REGISTERED LETTER (with a domestic insurance option) R.C. 073 712 545 Z.A. CUSTOMER COPY 301028H
7	J.G	Lategan	Kai I Garib Municipality - Municipal Manager	Municipal Manager	Private Bag X5, Kakamas, 8870	REGISTERED LETTER (with a domestic insurance option) R.C. 073 712 553 Z.A. CUSTOMER COPY 301028H
8	Mashudu	Randwedzi	Department of Water and Sanitation	DWS	Private Bag X5912 Upington 8800	REGISTERED LETTER (with a domestic insurance option) R.C. 073 712 568 Z.A. CUSTOMER COPY 301028H
9	Melinda	Mei	Department of Water and Sanitation	DWS	Private Bag X5912 Upington 8800	REGISTERED LETTER (with a domestic insurance option) R.C. 073 712 576 Z.A. CUSTOMER COPY 301028H
10	Mandla	Ndzili	Ministry of Environment and Nature Conservation		Private Bag X6120 Kimberley 8301	REGISTERED LETTER (with a domestic insurance option) R.C. 073 713 461 Z.A. CUSTOMER COPY 301028R
11	Mr Sibonelo	Mbanjwa	Provincial Department of Environment and Nature Conservation: Northern Cape		Private Bag X6120 Kimberley 8301	REGISTERED LETTER (with a domestic insurance option) R.C. 073 713 475 Z.A. CUSTOMER COPY 301028H
12	Ms Mashudu	Merubini	Department of Agriculture, Forestry and Fisheries - Delegate of the Minister (Act 70 of 1970)	Delegate of the Minister (Act 70 of 1970)	Private Bag X120, Pretoria 0001	REGISTERED LETTER (with a domestic insurance option) R.C. 073 713 458 Z.A. CUSTOMER COPY 301028H



Scoping and Environmental Impact Assessment for the proposed Development of a 75 MW Solar Photovoltaic Facility (KENHARDT PV 1) on the remaining extent of Onder Rugzeer Farm 168, north-east of Kenhardt, Northern Cape Province

No.	Name	Surname	Company	Designation	Postal	Registered Number Customer Copy (for CSIR)
13	Thoko	Bulhelezi	Department of Agriculture, Forestry and Fisheries - Agriland Liaison office		Private Bag X120, Pretoria 0001	REGISTERED LETTER (with a domestic insurance option) ShreeCorp 0863 713 925 www.spcorp.co.za RC 073 713 444 ZA CUSTOMER COPY 301028R
14	D	Nhlakad	Department of Agriculture, Forestry and Fisheries - Agriland Liaison office		Private Bag X120, Pretoria 0001	REGISTERED LETTER (with a domestic insurance option) ShreeCorp 0863 713 925 www.spcorp.co.za RC 073 713 427 ZA CUSTOMER COPY 301028R
15	Anneliza	Collett	Department of Agriculture, Forestry and Fisheries - Agriland Liaison office		Private Bag X120, Pretoria 0001	REGISTERED LETTER (with a domestic insurance option) ShreeCorp 0863 713 925 www.spcorp.co.za RC 073 713 435 ZA CUSTOMER COPY 301028R
16	Jacoline	Mans	Department of Agriculture, Forestry and Fisheries - Chief Forester: NFA Regulation		PO BOX 2782 Upington 8800	REGISTERED LETTER (with a domestic insurance option) ShreeCorp 0863 713 925 www.spcorp.co.za RC 073 713 360 ZA CUSTOMER COPY 301028R
17	All	Ditama	Agriculture, Land Reform & Rural Development		Private Bag X 5018, Kimberley, 8300	REGISTERED LETTER (with a domestic insurance option) ShreeCorp 0863 713 925 www.spcorp.co.za RC 073 713 373 ZA CUSTOMER COPY 301028R
18	Pieter	Buys	National Energy Regulator of South Africa (NERSA)		PO Box 40343, Arcadia, 0007	REGISTERED LETTER (with a domestic insurance option) ShreeCorp 0863 713 925 www.spcorp.co.za RC 073 713 387 ZA CUSTOMER COPY 301028R
19	IA	Bulane	Department of Public Works, Roads and Transport		PO Box 3132, Squarehill Park, Kimberley 8300	REGISTERED LETTER (with a domestic insurance option) ShreeCorp 0863 713 925 www.spcorp.co.za RC 073 713 400 ZA CUSTOMER COPY 301028R
20	Denver	Van Heerden	Department of Public Works, Roads and Transport		PO Box 3132, Squarehill Park, Kimberley 8300	REGISTERED LETTER (with a domestic insurance option) ShreeCorp 0863 713 925 www.spcorp.co.za RC 073 713 413 ZA CUSTOMER COPY 301028R
21	Rene	de kock	South African Roads Agency Limited (SANRAL) Northern Cape (Western Region)		Private Bag X19 Bellville, 7535	REGISTERED LETTER (with a domestic insurance option) ShreeCorp 0863 713 925 www.spcorp.co.za RC 073 713 395 ZA CUSTOMER COPY 301028R
22	Ms. M	Lepheane	Department of Labour		Private Bag X5012, Kimberley, 8300	REGISTERED LETTER (with a domestic insurance option) ShreeCorp 0863 713 925 www.spcorp.co.za RC 073 713 308 ZA CUSTOMER COPY 301028R
23	Mr. A.	Botes	Department of Social Development		Private Bag X 5042, Kimberley 8300	REGISTERED LETTER (with a domestic insurance option) ShreeCorp 0863 713 925 www.spcorp.co.za RC 073 713 311 ZA CUSTOMER COPY 301028R
24	Mr. Riaan	Warie	Northern Cape Economic Development Agency		227 Du Toitspan Road, Belgravia, Kimberley 8301	REGISTERED LETTER (with a domestic insurance option) ShreeCorp 0863 713 925 www.spcorp.co.za RC 073 713 325 ZA CUSTOMER COPY 301028R
25	Mr Andrew	Timothy	Directorate Heritage, Department - Sports, Arts and Culture		P. O. Box 1930, Kimberley 8300	REGISTERED LETTER (with a domestic insurance option) ShreeCorp 0863 713 925 www.spcorp.co.za RC 073 713 339 ZA CUSTOMER COPY 301028R



Scoping and Environmental Impact Assessment for the proposed Development of a 75 MW Solar Photovoltaic Facility (KENHARDT PV 1) on the remaining extent of Onder Rugzeer Farm 168, north-east of Kenhardt, Northern Cape Province

No.	Name	Surname	Company	Designation	Postal	Registered Number Customer Copy (for CSIR)
29	Lizell	Stroh	South African Civilian Aviation Authority		Private Bag X73 Halfway House 1685	REGISTERED LETTER (with a domestic insurance option) Should Call 0860 771 822 when applicable RC 073 713 268 ZA CUSTOMER COPY 301028R
30	John	Geeringh	ESKOM	Commenting authority	P.O. Box 1091 Johannesburg 2157	REGISTERED LETTER (with a domestic insurance option) Should Call 0860 771 822 when applicable RC 073 713 299 ZA CUSTOMER COPY 301028R
31	Justine	Wyrngaardt	Eskom Holdings Limited: Eskom Distribution Western Operating Unit			REGISTERED LETTER (with a domestic insurance option) Should Call 0860 771 822 when applicable RC 073 713 271 ZA CUSTOMER COPY 301028R
32	Sharon	Steyn	Northern Cape Chamber of Commerce and Industry		PO Box 350, Kimberley 8300	REGISTERED LETTER (with a domestic insurance option) Should Call 0860 771 822 when applicable RC 073 713 245 ZA CUSTOMER COPY 301028R
33	P.J.J	van Rensburg	Agri Northern Cape		PO Box 1094, Kimberley 8300	REGISTERED LETTER (with a domestic insurance option) Should Call 0860 771 822 when applicable RC 073 713 254 ZA CUSTOMER COPY 301028R
35	Adnan	Tipisdy	SKA SA		11 Baker Street Rosebank Johannesburg South Africa 2196	REGISTERED LETTER (with a domestic insurance option) Should Call 0860 771 822 when applicable RC 073 713 237 ZA CUSTOMER COPY 301028R
37	The Director		Department of Energy Northern Cape		Private Bag X6093 Kimberley, 8300	REGISTERED LETTER (with a domestic insurance option) Should Call 0860 771 822 when applicable RC 073 713 210 ZA CUSTOMER COPY 301028R
38	Simon	Gear	Birdlife South Africa		PO Box 515 Randburg, 2194	REGISTERED LETTER (with a domestic insurance option) Should Call 0860 771 822 when applicable RC 073 713 199 ZA CUSTOMER COPY 301028R



No.	Name	Surname	Company	Designation	Postal	Registered Number Customer Copy (for CSIR)
39	Lubabalo	Ntsolo	C.A.P.E. co-ordination unit: Northern Cape		Private Bag X7, Claremont, 7735	REGISTERED LETTER (with a domestic insurance option) Should Call 0860 771 822 when applicable RC 073 713 183 ZA CUSTOMER COPY 301028R
41	Dr. Howard	Hendricks	South African National Parks (SANParks) - Snr GM: Policy & Governance Conservation Services Division		PO Box 787, Pretoria, 0001	REGISTERED LETTER (with a domestic insurance option) Should Call 0860 771 822 when applicable RC 073 713 166 ZA CUSTOMER COPY 301028R
42	Rudolph	Grobler			PO Box 41, Keimos 8850	REGISTERED LETTER (with a domestic insurance option) Should Call 0860 771 822 when applicable RC 073 713 152 ZA CUSTOMER COPY 301028R
43	Ernest	Connan	Ernest Connan Trust		PO Box 290, Upington, 8800	REGISTERED LETTER (with a domestic insurance option) Should Call 0860 771 822 when applicable RC 073 713 149 ZA CUSTOMER COPY 301028R
44	Johan	Steenkamp	JHJ Steenkamp Trust		JHJ Steenkamp Trust PO Box 3267 Upington 8800	REGISTERED LETTER (with a domestic insurance option) Should Call 0860 771 822 when applicable RC 073 713 135 ZA CUSTOMER COPY 301028R
	DOMANINA	DE LA Fontaine	Northern Cape Department of Environment and Nature Conservation		PROVINCIAL BUILDING 5th FLOOR GATER BUIKAMP WELDENWATERED UPINGTON 8800	REGISTERED LETTER (with a domestic insurance option) Should Call 0860 771 822 when applicable RC 089 995 411 ZA CUSTOMER COPY 301028R



Email 1 sent to all I&APs on 29 July 2015 (English and Afrikaans)

From: Rohaida Abed
To: Abed, Rohaida
BC Clive.Stephenson@transnet.net; GeerinJH@eskom.co.za; Gilbert.Nortier@transnet.net; JacquelineMa@daff.gov.za; Laurie, Surina; LeaskK@eskom.co.za; MashuduMa@daff.gov.za; Mayvyn.Bhana@transnet.net; MeiM@dwa.gov.za; Rabothata, MMatlala; ThokoB@daff.gov.za; WyngaaJO@eskom.co.za; aditeme@agri.ncape.gov.za; admin@grasslands.org.za; advocacy@birdlife.org.za; ameliastrauss2@gmail.com; andre.vanniekerk10@gmail.com; annelizac@nda.agric.za; atiplady@ska.ac.za; boozahunter@yahoo.com; claude@veroniva.co.za; ernest.connan@donco.co.za; fpr@bodr.gov.za; hendri@aheadtrading.co.za; howard.hendricks@sanparks.org; jhjs@webmail.co.za; karen@mulilo.com; klawrence@trpw.ncape.gov.za; kraaines@mweb.co.za; lntsolo@sanbi.org.za; marcyroxnpc@gmail.com; messop@environment.gov.za; mitchell.hodgson@scatecsolar.com; mm@kaigarib.gov.za; mmathews@ncpg.gov.za; mndzilili@ncpg.gov.za; monica.lepheane@labour.gov.za; ncagric@worldonline.co.za; nhlakad@daff.gov.za; nyaphi@ncpg.gov.za; peter.buys@nersa.org.za; ratha.timothy@gmail.com; rwarie@ncpg.gov.za; sb@siyanda.gov.za; sdelafontaine@gmail.com; sharon@nocci.co.za; smbanjwa@ncpg.gov.za; straussdj@orientis.co.za; strohl@caa.co.za; teresascheepers@vodamail.co.za; waltjc@nra.co.za; wep@ewt.org.za
Date: 29/07/2015 16:01
Subject: Notice of BA and EIA Process - Solar PV Facilities and Associated Electrical Infrastructure, Northern Cape
Attachments: Scatec Solar BID_A4_8 PAGES_July2015_LOW RES.pdf; CSIR Letter 1 to I&APs_Scatec Solar NC.pdf; Comment and Response Form_Scatec Solar NC.pdf

Dear Stakeholders and Interested and Affected Parties

NOTICE OF BASIC ASSESSMENT AND SCOPING AND ENVIRONMENTAL IMPACT ASSESSMENT FOR THE PROPOSED DEVELOPMENT OF THREE SOLAR PHOTOVOLTAIC FACILITIES AND ASSOCIATED ELECTRICAL INFRASTRUCTURE NORTH-EAST OF KENHARDT, NORTHERN CAPE PROVINCE

Competent Authority: National Department of Environmental Affairs

CSIR Reference: EMS0102/SCATEC/2015

This e-mail correspondence serves to inform you of the initiation of a Basic Assessment (BA) Process and Scoping and Environmental Impact Assessment (EIA) Process for the above-mentioned proposed project, located approximately 80 km south of Upington and 30 km north-east of Kenhardt within the !Kheis Local Municipality, Northern Cape Province. The Project Applicant is Scatec Solar SA 163 (PTY) Ltd (hereinafter referred to as Scatec Solar). The CSIR has been appointed by Scatec Solar to undertake the required BA Process, and Scoping and EIA Process.

A full Scoping and EIA Process is required for the development of three 75 Megawatt (MW) Solar Photovoltaic (PV) power generation facilities on the remaining extent of Onder Rugzeer Farm 168. A separate BA Process is also required and will be undertaken for the development of three transmission lines and the connection points to the Eskom Nieuwehoop Substation (which is currently being constructed) on the remaining extent of Portion 3 of Gemsbok Bult Farm 120.

The proposed 75 MW Solar PV facilities and transmission lines are located within the same geographical area and constitute the same type of activity; hence an integrated Public Participation Process will be undertaken. However, separate Applications for Environmental Authorisation will be lodged with the National Department of Environmental Affairs (DEA) for each proposed 75 MW Solar PV facility and transmission line. Furthermore, separate BA, Scoping and EIA Reports will be compiled for each project, which will be referred to as:

Scoping and EIA Processes: Proposed 75 MW Solar PV Facilities	BA Processes: Proposed 132 kV Transmission Lines
- Kenhardt PV 1	- Kenhardt PV 1 – Transmission Line
- Kenhardt PV 2	- Kenhardt PV 2 – Transmission Line
- Kenhardt PV 3	- Kenhardt PV 3 – Transmission Line

The proposed projects are being assessed in terms of the National Environmental Management Act (Act 107 of 1998), as amended (NEMA), and the NEMA EIA Regulations, published in Government Notice (GN) R982, R983, R984 and R985 on 8 December 2014.

Please find attached the following:

- Background Information Document (BID);
- Letter 1 to Interested & Affected Parties (I&APs); and
- Comment and Registration Form.

The BID, which provides an overview of the proposed project, is being released to Stakeholders and I&APs for a 30-day comment period extending from **30 July 2015 to 31 August 2015**.

Hard copies of the above-mentioned documents have also been sent to those of you for which postal addresses are available. In addition, the above-mentioned project information can be accessed at the following website:

<http://www.csir.co.za/eia/ScatecSolarPV/>

Kindly ensure that all comments are submitted to the CSIR Project Manager (details provided below) by **31 August 2015**.

Thank you and kind regards,

Rohaida Abed

CSIR - Environmental Management Services
P. O. Box 17001, Congella, Durban, 4013
Tel: 031 242 2300
Fax: 031 261 2509
Email: RAbed@csir.co.za

Beste Belanghebbende en Geïnteresseerde Party

GESAMENTLIKE KENNISGEWING VAN BASIESE EN OMGEWINGSIMPAKEVALUERINGSPROSESSE VIR DIE VOORGESTELDE ONTWIKKELING VAN DRIE SONKRAGANLEGTE EN ELEKTRIESE INFRASTRUKTUUR NOORD-OOS VAN KENHARDT, NOORD- KAAP PROVINSIE

Bevoegde Owerheid: Die Nasionale Departement van Omgewingsake

WNNR/CSIR verwysingsnommer: EMS0102/SCATEC2015

Hierdie e-pos korrespondensie se doel is om u in kennis te stel van die Basiese evaluerings- en Bestek en Omgewingsimpakevalueringproses vir die bogenoemde projekte, wat 80 km suid van Upington en 30 km noord-oos van Kenhardt in die !Kheis munisipaliteit voorgestel word. Die Aansoeker vir die projek is Scatec Solar SA 163 (PTY) Ltd ("Scatec Solar"). Die WNNR is aangestel deur Scatec Solar om die Basiese evaluerings- en Bestek en Omgewingsimpakevalueringproses vir die bogenoemde projekte uit te voer.

'n Bestek en Omgewingsimpakevalueringproses word vereis vir elk van die drie 75 MW Fotovoltaïese (PV) sonkragsfasiliteite wat op die plaas Restant van Onder Rugzeer 168 voorgestel word. Aparte Basiese evalueringprosesse word ook vereis vir die voorgestelde 132 kV kraglyne en die konneksiepunte aan die Eskom Nieuwehoop Substasie (wat tans gebou word) op die plaas Restant van Gedeelte 3 van Gembok Bult 120.

Aangesien die sonkragsprojekte en die voorgestelde elektriese infrastruktuur in dieselfde geografiese area gebou gaan word en dieselfde tipe projekte is, word dit voorgestel dat 'n geïntegreerde Publieke Deelname Proses gedoen gaan word. Aparte aansoeke gaan by die Nasionale Departement van Omgewingsake ingedien word vir die verskillende projekte en aparte verslae sal ook vir elke projek saamgestel en uitgestuur word. Die projekte sal na verwys word as:

Bestek en Omgewingsimpakevalueringproses: Voorgestelde drie 75 MW PV sonkragsprojekte	Basiese evalueringprosesse: Voorgestelde drie 132 kV kraglyne
- Kenhardt PV 1	- Kenhardt PV 1 – Transmission Line
- Kenhardt PV 2	- Kenhardt PV 2 – Transmission Line
- Kenhardt PV 3	- Kenhardt PV 3 – Transmission Line

Die voorgestelde projekte sal ge-evalueer word volgens die Nasionale Omgewingsbeheer Wet, 1998 (Wet No 107 van 1998) (NEMA) en die Omgewingsimpakstudie (OIS) Regulasies soos gepubliseer in Staatskennisgewing R982 in Staatskoerant No 38282 van 08 Desember 2014.

Vind asseblief aangeheg die volgende:

- Beskrywing van die projek (word na verwys as die "BID")
- Brief aan die Belanghebbende en Geïnteresseerde Partye (B&GP'e)
- Kommentaar en Registrasievorm

Die BID, wat dien as agtergrond van die projek, bevat 'n beskrywing van die projek, die gelyste aktiwiteite en is vir 30-dae beskikbaar vir oorsig en kommentaar (**30 Julie 2015 - 31 Augustus 2015**). 'n Harde kopie van die bogenoemde dokumente is ook gestuur aan diegene vir wie ons posadresse het. Inligting van die projek is ook beskikbaar op die projekwebuiste: <http://www.csir.co.za/eia/ScatecSolarPV/>.

Ons versoek graag dat alle kommentaar aan die WNNR Projekbestuurder (kontakbesonderhede onder aangedui) teen **31 Augustus 2015** verskaf word.

By voorbaat dankie,

Rohaida Abed
CSIR - Environmental Management Services
Posbus 17001, Congella, Durban, 4013
Tel: 031 242 2300
Faks: 031 261 2509
E-pos: RAbed@csir.co.za

Proof of Delivery of Email 1 sent to all I&APs on 29 July 2015

Message ID: 55B8DCA1.FB3 : 179 : 65115
 Subject: Notice of BA and EIA Process - Solar PV Facilities and Associated Electrical Infrastructure, Northern Cape
 Created By: RAbed@caitr.co.za
 Scheduled Date:
 Creation Date: 29/07/2015 16:01
 From: Rohaida Abed

Recipients:

Recipient	Action	Date & Time	Comment
agri.ncape.gov.za	Transferred	29/07/2015 16:01	
BC: aditeme@agri.ncape.gov.za (aditeme@agri.ncape.gov.za)	Delivered	29/07/2015 16:02	
aheadtrading.co.za	Transferred	29/07/2015 16:01	
BC: hendri@aheadtrading.co.za (hendri@aheadtrading.co.za)	Delivered	29/07/2015 16:02	
birdlife.org.za	Transferred	29/07/2015 16:01	
BC: advocacy@birdlife.org.za (advocacy@birdlife.org.za)	Delivered	29/07/2015 16:02	
bodr.gov.za	Transferred	29/07/2015 16:01	
BC: fpr@bodr.gov.za (fpr@bodr.gov.za)	Undeliverable	29/07/2015 16:02	
caa.co.za	Transferred	29/07/2015 16:01	
BC: stroh@caa.co.za (stroh@caa.co.za)	Delivered	29/07/2015 16:08	
daff.gov.za	Transferred	29/07/2015 16:01	
BC: JacquelineMa@daff.gov.za (JacolineMa@daff.gov.za)			
BC: MashuduMa@daff.gov.za (MashuduMa@daff.gov.za)			
BC: nhakad@daff.gov.za (nhakad@daff.gov.za)			
BC: ThokoB@daff.gov.za (ThokoB@daff.gov.za)			
donco.co.za	Transferred	29/07/2015 16:01	
BC: ernest.connan@donco.co.za (ernest.connan@donco.co.za)	Delivered	29/07/2015 16:02	
dwa.gov.za	Transferred	29/07/2015 16:01	
BC: MeiM@dwa.gov.za (MeiM@dwa.gov.za)	Delivered	29/07/2015 16:02	
environment.gov.za	Transferred	29/07/2015 16:01	
BC: messop@environment.gov.za (messop@environment.gov.za)	Delivered	29/07/2015 16:03	
BC: Rabothata_MiMatlala (MRabothata@environment.gov.za)	Delivered	29/07/2015 16:03	
eskom.co.za	Transferred	29/07/2015 16:01	
BC: GeerinJH@eskom.co.za (GeerinJH@eskom.co.za)	Delivered	29/07/2015 16:02	
BC: LeaskK@eskom.co.za (LeaskK@eskom.co.za)	Delivered	29/07/2015 16:02	
BC: WynaasJO@eskom.co.za (WynaasJO@eskom.co.za)	Delivered	29/07/2015 16:02	
ewt.org.za	Transferred	29/07/2015 16:01	
BC: wep@ewt.org.za (wep@ewt.org.za)	Delivered	29/07/2015 16:11	2.0.0 recipients expanded
gmail.com	Transferred	29/07/2015 16:01	
BC: amelastruss2@gmail.com (amelastruss2@gmail.com)	Delivered	29/07/2015 16:03	
BC: andre.vanniekerk10@gmail.com (andre.vanniekerk10@gmail.com)	Delivered	29/07/2015 16:03	
BC: marcyroxnpc@gmail.com (marcyroxnpc@gmail.com)	Delivered	29/07/2015 16:03	
BC: ratha.timothy@gmail.com (ratha.timothy@gmail.com)	Delivered	29/07/2015 16:03	
BC: odelafontaine@gmail.com (odelafontaine@gmail.com)	Delivered	29/07/2015 16:03	
grasslands.org.za	Transferred	29/07/2015 16:01	
BC: admin@grasslands.org.za (admin@grasslands.org.za)	Delivered	29/07/2015 16:02	
kalgarb.gov.za	Transferred	29/07/2015 16:01	
BC: mm@kalgarb.gov.za (mm@kalgarb.gov.za)	Delivered	29/07/2015 16:03	
labour.gov.za	Transferred	29/07/2015 16:01	
BC: monica.lepheane@labour.gov.za (monica.lepheane@labour.gov.za)	Delivered	29/07/2015 16:03	
mullo.com	Transferred	29/07/2015 16:01	
BC: karen@mullo.com (karen@mullo.com)	Delivered	29/07/2015 16:03	
mweb.co.za	Transferred	29/07/2015 16:01	
BC: kraaines@mweb.co.za (kraaines@mweb.co.za)	Delivered	29/07/2015 16:03	
ncp.gov.za	Transferred	29/07/2015 16:01	
BC: mmathews@ncpg.gov.za (mmathews@ncpg.gov.za)	Delivered	29/07/2015 16:03	
BC: mindzill@ncpg.gov.za (mindzill@ncpg.gov.za)	Delivered	29/07/2015 16:03	
BC: nyaphi@ncpg.gov.za (nyaphi@ncpg.gov.za)	Delivered	29/07/2015 16:03	

BC: rwane@ncpg.gov.za (rwane@ncpg.gov.za)	Delivered	29/07/2015 16:03
BC: smbanjwa@ncpg.gov.za (smbanjwa@ncpg.gov.za)	Delivered	29/07/2015 16:03
nda.agric.za	Transferred	29/07/2015 16:01
BC: annelzacc@nda.agric.za (annelzacc@nda.agric.za)	Delivered	31/07/2015 21:50
nersa.org.za	Transferred	29/07/2015 16:01
BC: peter.buys@nersa.org.za (peter.buys@nersa.org.za)	Delivered	29/07/2015 16:09
nocci.co.za	Transferred	29/07/2015 16:01
BC: sharon@nocci.co.za (sharon@nocci.co.za)		
nra.co.za	Transferred	29/07/2015 16:01
BC: waitjc@nra.co.za (waitjc@nra.co.za)	Delivered	29/07/2015 16:02
orientis.co.za	Transferred	29/07/2015 16:01
BC: straussd@orientis.co.za (straussd@orientis.co.za)	Delivered	29/07/2015 16:02
POBOX1.DURBAN	Delivered	29/07/2015 16:01
To: Rohalida Abed (RAbed@csir.co.za)	Read	29/07/2015 16:01
POBOX1.STELLBOS	Delivered	29/07/2015 16:01
BC: Surina Laurie (SLaurie@csir.co.za)	Third-Party Downloaded Read	29/07/2015 16:01 29/07/2015 16:02
sanbi.org.za	Transferred	29/07/2015 16:01
BC: lntsolo@sanbi.org.za (lntsolo@sanbi.org.za)	Undeliverable	29/07/2015 16:02
sanparks.org	Transferred	29/07/2015 16:01
BC: howard.hendricks@sanparks.org (howard.hendricks@sanparks.org)	Delivered	29/07/2015 16:12
scatecsolar.com	Transferred	29/07/2015 16:01
BC: mitchell.hodgson@scatecsolar.com (mitchell.hodgson@scatecsolar.com)	Delivered	29/07/2015 16:03
siyanda.gov.za	Transferred	29/07/2015 16:01
BC: sb@siyanda.gov.za (sb@siyanda.gov.za)	Undeliverable	03/08/2015 16:27
ska.ac.za	Transferred	29/07/2015 16:01
BC: atipiady@ska.ac.za (atipiady@ska.ac.za)	Delivered	29/07/2015 16:02
transnet.net	Transferred	29/07/2015 16:01
BC: Olive.Stephenson@transnet.net (Olive.Stephenson@transnet.net)	Delivered	29/07/2015 16:03
BC: Gilbert.Nortier@transnet.net (Gilbert.Nortier@transnet.net)	Delivered	29/07/2015 16:03
BC: Mayvyn.Bhana@transnet.net (Mayvyn.Bhana@transnet.net)	Delivered	29/07/2015 16:03
tpw.ncape.gov.za	Transferred	29/07/2015 16:01
BC: kiawrence@tpw.ncape.gov.za (kiawrence@tpw.ncape.gov.za)	Undeliverable	29/07/2015 16:02
veroniva.co.za	Transferred	29/07/2015 16:01
BC: claude@veroniva.co.za (claude@veroniva.co.za)	Delivered	29/07/2015 16:03
vodamail.co.za	Transferred	29/07/2015 16:01
BC: teresascheepers@vodamail.co.za (terasascheepers@vodamail.co.za)	Delivered	29/07/2015 16:19 2.0.0 recipients expanded
webmail.co.za	Transferred	29/07/2015 16:01
BC: jhs@webmail.co.za (jhs@webmail.co.za)	Transferred	29/07/2015 16:30 2.0.0 message relayed
worldonline.co.za	Transferred	29/07/2015 16:01
BC: ncagric@worldonline.co.za (ncagric@worldonline.co.za)	Delivered	29/07/2015 16:02
yahoo.com	Transferred	29/07/2015 16:01
BC: boozahunter@yahoo.com (boozahunter@yahoo.com)	Delivered	29/07/2015 16:03

Post Offices

Post Office	Delivered	Route
agri.ncape.gov.za		agri.ncape.gov.za
aheadtrading.co.za		aheadtrading.co.za
birdlife.org.za		birdlife.org.za
boor.gov.za		boor.gov.za
caa.co.za		caa.co.za
daff.gov.za		daff.gov.za
donco.co.za		donco.co.za
dwa.gov.za		dwa.gov.za
environment.gov.za		environment.gov.za

eskom.co.za		eskom.co.za
ewf.org.za		ewf.org.za
gmail.com		gmail.com
grasslands.org.za		grasslands.org.za
kalgarib.gov.za		kalgarib.gov.za
labour.gov.za		labour.gov.za
mullo.com		mullo.com
mweb.co.za		mweb.co.za
nccpg.gov.za		nccpg.gov.za
nda.agric.za		nda.agric.za
nersa.org.za		nersa.org.za
nocci.co.za		nocci.co.za
nra.co.za		nra.co.za
orientis.co.za		orientis.co.za
POBOX1.DURBAN	29/07/2015 16:01	csir.co.za
POBOX1.STELLBOG	29/07/2015 16:01	csir.co.za
sanbi.org.za		sanbi.org.za
sanparks.org		sanparks.org
scatecsolar.com		scatecsolar.com
siyanda.gov.za		siyanda.gov.za
ska.ac.za		ska.ac.za
transnet.net		transnet.net
tpw.ncape.gov.za		tpw.ncape.gov.za
veroniva.co.za		veroniva.co.za
vodamail.co.za		vodamail.co.za
webmail.co.za		webmail.co.za
worldonline.co.za		worldonline.co.za
yahoo.com		yahoo.com

Files

File	Size	Date & Time
Comment and Response Form_Scaterc Solar NC.pdf	86206	28/07/2015 15:14
CSIR Letter 1 to I&APs_Scaterc Solar NC.pdf	123630	28/07/2015 15:15
MESSAGE	13601	29/07/2015 16:01
Scaterc Solar BID_A4_8 PAGES_July2015_LOW RES.pdf	751766	29/07/2015 08:56
TEXT.htm	35806	29/07/2015 16:01

Options

Auto Delete:	No
Concealed Subject:	No
Expiration Date:	None
Notify Recipients:	Yes
Priority:	Standard
Reply requested by:	None
Security:	Standard
To Be Delivered:	Immediate

Record Id

Record Id:	55B8F9C1.DURBAN.POBOX1.100.1356D37.1.C449.1
Common Record Id:	55B8F9C1.DURBAN.POBOX1.200.20000B3.1.30C8D.1

Response and Follow-up Emails sent to I&APs and Stakeholders during the 30-day review of the BID

From: Rohaida Abed
To: (UPN), Mei Melinda
CC: Shaun, Cloete
Date: 05/08/2015 08:48
Subject: Re: Hard Copies: Notice of BA and EIA Process - Solar PV Facilities and Associated Electrical Infrastructure, Northern Cape

Dear Melinda

Thank you for your email. Hard copies of the BID, Comment Form and Letter 1 has been sent to the following address via registered mail on 30 July 2015:

Department Of Water and Sanitation
Private Bag X 5912
Upington
8800

The documents were sent to the following representatives of DWS (please note the tracking numbers as well).

- Mashudu Randwedzi - Tracking Number: RC 073 712 568 ZA
- Melinda Mei - Tracking Number: RC 073 712 571 ZA

Please let me know once you receive the documents.

Thanks and kind regards,
Rohaida

>>> "Mei Melinda (UPN)" <MeiM@dws.gov.za> 04/08/2015 13:38 >>>

Good morning Mr. Abed

Your notice received with regards to Basic Assessment; Scoping and Environmental Impact Assessment for the Proposed Development of the three Solar Photovoltaic Facilities and Associated Electrical Infrastructure; North-East of Kenhardt; Northern Cape is of reference.

DWS requires you to forward hard copies of the above mentioned project to either of the following address:

Physical Address:
Department Of Water and Sanitation
Louisvale Road Upington
8801
OR

Postal Address:
Department Of Water and Sanitation
Private Bag X 5912
Upington
8800

Your co-operation and assistance is highly appreciated.

With kind regards,

Melinda Mei
Senior Administration Clerk
Water Quality Management: Lower Orange Water Management Area
Tel: 054 338 5836
Fax: 054 334 0205
Mail: MeiM@dwa.gov.za

Scoping and Environmental Impact Assessment for the proposed Development of a 75 MW Solar Photovoltaic Facility (KENHARDT PV 1) on the remaining extent of Onder Rugzeer Farm 168, north-east of Kenhardt, Northern Cape Province

From: Rohaida Abed [mailto:RAbed@csir.co.za]

Sent: 29 July 2015 04:01 PM

To: Rohaida Abed

Subject: Notice of BA and EIA Process - Solar PV Facilities and Associated Electrical Infrastructure, Northern Cape

Dear Stakeholders and Interested and Affected Parties

NOTICE OF BASIC ASSESSMENT AND SCOPING AND ENVIRONMENTAL IMPACT ASSESSMENT FOR THE PROPOSED DEVELOPMENT OF THREE SOLAR PHOTOVOLTAIC FACILITIES AND ASSOCIATED ELECTRICAL INFRASTRUCTURE NORTH-EAST OF KENHARDT, NORTHERN CAPE PROVINCE

Competent Authority: National Department of Environmental Affairs

CSIR Reference: EMS0102/SCATEC/2015

This e-mail correspondence serves to inform you of the initiation of a Basic Assessment (BA) Process and Scoping and Environmental Impact Assessment (EIA) Process for the above-mentioned proposed project, located approximately 80 km south of Upington and 30 km north-east of Kenhardt within the !Kheis Local Municipality, Northern Cape Province. The Project Applicant is Scatec Solar SA 163 (PTY) Ltd (hereinafter referred to as Scatec Solar). The CSIR has been appointed by Scatec Solar to undertake the required BA Process, and Scoping and EIA Process.

A full Scoping and EIA Process is required for the development of three 75 Megawatt (MW) Solar Photovoltaic (PV) power generation facilities on the remaining extent of Onder Rugzeer Farm 168. A separate BA Process is also required and will be undertaken for the development of three transmission lines and the connection points to the Eskom Nieuwehoop Substation (which is currently being constructed) on the remaining extent of Portion 3 of Gembok Bult Farm 120.

The proposed 75 MW Solar PV facilities and transmission lines are located within the same geographical area and constitute the same type of activity; hence an integrated Public Participation Process will be undertaken. However, separate Applications for Environmental Authorisation will be lodged with the National Department of Environmental Affairs (DEA) for each proposed 75 MW Solar PV facility and transmission line. Furthermore, separate BA, Scoping and EIA Reports will be compiled for each project, which will be referred to as:

Scoping and EIA Processes: Proposed 75 MW Solar PV Facilities	BA Processes: Proposed 132 kV Transmission Lines
- Kenhardt PV 1	- Kenhardt PV 1 – Transmission Line
- Kenhardt PV 2	- Kenhardt PV 2 – Transmission Line
- Kenhardt PV 3	- Kenhardt PV 3 – Transmission Line

The proposed projects are being assessed in terms of the National Environmental Management Act (Act 107 of 1998), as amended (NEMA), and the NEMA EIA Regulations, published in Government Notice (GN) R982, R983, R984 and R985 on 8 December 2014.

Please find attached the following:

- Background Information Document (BID);
- Letter 1 to Interested & Affected Parties (I&APs); and
- Comment and Registration Form.

The BID, which provides an overview of the proposed project, is being released to Stakeholders and I&APs for a 30-day comment period extending from **30 July 2015 to 31 August 2015**.

Hard copies of the above-mentioned documents have also been sent to those of you for which postal addresses are available.

In addition, the above-mentioned project information can be accessed at the following website: <http://www.csir.co.za/eia/ScatecSolarPV/>

Kindly ensure that all comments are submitted to the CSIR Project Manager (details provided below) by **31 August 2015**.

Thank you and kind regards,

Rohaida Abed

CSIR - Environmental Management Services
P. O. Box 17001, Congella, Durban, 4013
Tel: 031 242 2300
Fax: 031 261 2509
Email: RAbed@csir.co.za

Beste Belanghebbende en Geïnteresseerde Party

GESAMENTLIKE KENNISGEWING VAN BASIESE EN OMGEWINGSIMPAKEVALUERINGSPROSESSE VIR DIE VOORGESTELDE ONTWIKKELING VAN DRIE SONKRAGANLEGTE EN ELEKTRIESE INFRASTRUKTUUR NOORD-OOS VAN KENHARDT, NOORD- KAAP PROVINSIE

Bevoegde Owerheid: Die Nasionale Departement van Omgewingsake

WNNR/CSIR verwysingsnommer: EMS0102/SCATEC/2015

Hierdie e-pos korrespondensie se doel is om u in kennis te stel van die Basiese evaluerings- en Bestek en Omgewingsimpakevalueringproses vir die bogenoemde projekte, wat 80 km suid van Upington en 30 km noord-oos van Kenhardt in die !Kheis munisipaliteit voorgestel word. Die Aansoeker vir die projek is Scatec Solar SA 163 (PTY) Ltd ("Scatec Solar"). Die WNNR is aangestel deur Scatec Solar om die Basiese evaluerings- en Bestek en Omgewingsimpakevalueringproses vir die bogenoemde projekte uit te voer.

'n Bestek en Omgewingsimpakevalueringproses word vereis vir elk van die drie 75 MW Fotovoltaïese (PV) sonkragfasiliteite wat op die plaas Restant van Onder Rugzeer 168 voorgestel word. Aparte Basiese evalueringprosesse word ook vereis vir die voorgestelde 132 kV kraglyne en die konneksiepunte aan die Eskom Nieuwehoop Substasie (wat tans gebou word) op die plaas Restant van Gedeelte 3 van Gembok Bult 120.

Aangesien die sonkragprojekte en die voorgestelde elektriese infrastruktuur in dieselfde geografiese area gebou gaan word en dieselfde tipe projekte is, word dit voorgestel dat 'n geïntegreerde Publieke Deelname Proses gedoen gaan word. Aparte aansoeke gaan by die Nasionale Departement van Omgewingsake ingedien word vir die verskillende projekte en aparte verslae sal ook vir elke projek saamgestel en uitgestuur word. Die projekte sal na verwys word as:

Bestek en Omgewingsimpakevalueringproses: Voorgestelde drie 75 MW PV sonkragprojekte	Basiese evalueringprosesse: Voorgestelde drie 132 kV kraglyne
- Kenhardt PV 1	- Kenhardt PV 1 – Transmission Line
- Kenhardt PV 2	- Kenhardt PV 2 – Transmission Line
- Kenhardt PV 3	- Kenhardt PV 3 – Transmission Line

Die voorgestelde projekte sal ge-evalueer word volgens die Nasionale Omgewingsbeheer Wet, 1998 (Wet No 107 van 1998) (NEMA) en die Omgewingsimpakstudie (OIS) Regulasies soos gepubliseer in Staatskennisgewing R982 in Staatskoerant No 38282 van 08 Desember 2014.

Vind asseblief aangeheg die volgende:

- Beskrywing van die projek (word na verwys as die "BID")
- Brief aan die Belanghebbende en Geïnteresseerde Partye (B&GP'e)
- Kommentaar en Registrasievorm

Die BID, wat dien as agtergrond van die projek, bevat 'n beskrywing van die projek, die gelyste aktiwiteite en is vir 30-dae beskikbaar vir oorsig en kommentaar (**30 Julie 2015 - 31 Augustus 2015**). 'n Harde kopie van die bogenoemde dokumente is ook gestuur aan diegene vir wie ons posadresse het. Inligting van die projek is ook beskikbaar op die projekwebtuiste: <http://www.csir.co.za/eia/ScatecSolarPV/>.

Ons versoek graag dat alle kommentaar aan die WNNR Projekbestuurder (kontakbesonderhede onder aangedui) teen **31 Augustus 2015** verskaf word.

By voorbaat dankie,

Rohaida Abed

CSIR - Environmental Management Services
Posbus 17001, Congella, Durban, 4013
Tel: 031 242 2300
Faks: 031 261 2509
E-pos: RAbed@csir.co.za

From: Rohaida Abed
To: townsendmorgan029@gmail.com
Date: 26/08/2015 17:03
Subject: Fwd: Notice of BA and EIA Process - Solar PV Facilities and Associated Electrical Infrastructure, Northern Cape
Attachments: Scatec Solar BID_A4_8 PAGES_July2015_LOW RES.pdf; CSIR Letter 1 to I&APs_Scatec Solar NC.pdf; Comment and Response Form_Scatec Solar NC.pdf

Good day

I understand that you contacted our offices for additional information on the proposed Solar PV projects in the Northern Cape. If you would like to register on the database as an I&AP, please complete the attached comment and response form and return it

to me via email. Please also see attached a Background Information Document and letter.

Thanks and kind regards,
Rohaida

CSIR - Environmental Management Services
P. O. Box 17001, Congella, Durban, 4013
Tel: 031 242 2300
Fax: 031 261 2509
Email: RAbed@csir.co.za

>>> Rohaida Abed 29/07/2015 16:01 >>>

Dear Stakeholders and Interested and Affected Parties

NOTICE OF BASIC ASSESSMENT AND SCOPING AND ENVIRONMENTAL IMPACT ASSESSMENT FOR THE PROPOSED DEVELOPMENT OF THREE SOLAR PHOTOVOLTAIC FACILITIES AND ASSOCIATED ELECTRICAL INFRASTRUCTURE NORTH-EAST OF KENHARDT, NORTHERN CAPE PROVINCE

Competent Authority: National Department of Environmental Affairs

CSIR Reference: EMS0102/SCATEC/2015

This e-mail correspondence serves to inform you of the initiation of a Basic Assessment (BA) Process and Scoping and Environmental Impact Assessment (EIA) Process for the above-mentioned proposed project, located approximately 80 km south of Upington and 30 km north-east of Kenhardt within the !Kheis Local Municipality, Northern Cape Province. The Project Applicant is Scatec Solar SA 163 (PTY) Ltd (hereinafter referred to as Scatec Solar). The CSIR has been appointed by Scatec Solar to undertake the required BA Process, and Scoping and EIA Process.

A full Scoping and EIA Process is required for the development of three 75 Megawatt (MW) Solar Photovoltaic (PV) power generation facilities on the remaining extent of Onder Rugzeer Farm 168. A separate BA Process is also required and will be undertaken for the development of three transmission lines and the connection points to the Eskom Nieuwehoop Substation (which is currently being constructed) on the remaining extent of Portion 3 of Gembok Bult Farm 120.

The proposed 75 MW Solar PV facilities and transmission lines are located within the same geographical area and constitute the same type of activity; hence an integrated Public Participation Process will be undertaken. However, separate Applications for Environmental Authorisation will be lodged with the National Department of Environmental Affairs (DEA) for each proposed 75 MW Solar PV facility and transmission line. Furthermore, separate BA, Scoping and EIA Reports will be compiled for each project, which will be referred to as:

Scoping and EIA Processes: Proposed 75 MW Solar PV Facilities	BA Processes: Proposed 132 kV Transmission Lines
- Kenhardt PV 1	- Kenhardt PV 1 – Transmission Line
- Kenhardt PV 2	- Kenhardt PV 2 – Transmission Line
- Kenhardt PV 3	- Kenhardt PV 3 – Transmission Line

The proposed projects are being assessed in terms of the National Environmental Management Act (Act 107 of 1998), as amended (NEMA), and the NEMA EIA Regulations, published in Government Notice (GN) R982, R983, R984 and R985 on 8 December 2014.

Please find attached the following:

- Background Information Document (BID);
- Letter 1 to Interested & Affected Parties (I&APs); and
- Comment and Registration Form.

The BID, which provides an overview of the proposed project, is being released to Stakeholders and I&APs for a 30-day comment period extending from **30 July 2015 to 31 August 2015**.

Hard copies of the above-mentioned documents have also been sent to those of you for which postal addresses are available.

In addition, the above-mentioned project information can be accessed at the following website:
<http://www.csir.co.za/eia/ScatecSolarPV/>

Kindly ensure that all comments are submitted to the CSIR Project Manager (details provided below) by **31 August 2015**.

Thank you and kind regards,

Rohaida Abed

CSIR - Environmental Management Services
P. O. Box 17001, Congella, Durban, 4013
Tel: 031 242 2300

Fax: 031 261 2509
Email: RAbed@csir.co.za

Beste Belanghebbende en Geïnteresseerde Party

GESAMENTLIKE KENNISGEWING VAN BASIESE EN OMGEWINGSIMPAKEVALUERINGSPROSESSE VIR DIE VOORGESTELDE ONTWIKKELING VAN DRIE SONKRAGAAANLEGTE EN ELEKTRIESE INFRASTRUKTUUR NOORD-OOS VAN KENHARDT, NOORD- KAAP PROVINSIE

Bevoegde Owerheid: Die Nasionale Departement van Omgewingsake

WNNR/CSIR verwysingsnommer: EMS0102/SCATEC/2015

Hierdie e-pos korrespondensie se doel is om u in kennis te stel van die Basiese evaluerings- en Bestek en Omgewingsimpakevalueringproses vir die bogenoemde projekte, wat 80 km suid van Upington en 30 km noord-oos van Kenhardt in die !Kheis munisipaliteit voorgestel word. Die Aansoeker vir die projek is Scatec Solar SA 163 (PTY) Ltd ("Scatec Solar"). Die WNNR is aangestel deur Scatec Solar om die Basiese evaluerings- en Bestek en Omgewingsimpakevalueringproses vir die bogenoemde projekte uit te voer.

'n Bestek en Omgewingsimpakevalueringproses word vereis vir elk van die drie 75 MW Fotovoltaïese (PV) sonkragfasiliteite wat op die plaas Restant van Onder Rugzeer 168 voorgestel word. Aparte Basiese evalueringprosesse word ook vereis vir die voorgestelde 132 kV kraglyne en die konneksiepunte aan die Eskom Nieuwehoop Substasie (wat tans gebou word) op die plaas Restant van Gedeelte 3 van Gembok Bult 120.

Aangesien die sonkragprojekte en die voorgestelde elektriese infrastruktuur in dieselfde geografiese area gebou gaan word en dieselfde tipe projekte is, word dit voorgestel dat 'n geïntegreerde Publieke Deelname Proses gedoen gaan word. Aparte aansoeke gaan by die Nasionale Departement van Omgewingsake ingedien word vir die verskillende projekte en aparte verslae sal ook vir elke projek saamgestel en uitgestuur word. Die projekte sal na verwys word as:

Bestek en Omgewingsimpakevalueringproses: Voorgestelde drie 75 MW PV sonkragprojekte	Basiese evalueringprosesse: Voorgestelde drie 132 kV kraglyne
- Kenhardt PV 1	- Kenhardt PV 1 – Transmission Line
- Kenhardt PV 2	- Kenhardt PV 2 – Transmission Line
- Kenhardt PV 3	- Kenhardt PV 3 – Transmission Line

Die voorgestelde projekte sal ge-evalueer word volgens die Nasionale Omgewingsbeheer Wet, 1998 (Wet No 107 van 1998) (NEMA) en die Omgewingsimpakstudie (OIS) Regulasies soos gepubliseer in Staatskennisgewing R982 in Staatskoerant No 38282 van 08 Desember 2014.

Vind asseblief aangeheg die volgende:

- Beskrywing van die projek (word na verwys as die "BID")
- Brief aan die Belanghebbende en Geïnteresseerde Partye (B&GP'e)
- Kommentaar en Registrasievorm

Die BID, wat dien as agtergrond van die projek, bevat 'n beskrywing van die projek, die gelyste aktiwiteite en is vir 30-dae beskikbaar vir oorsig en kommentaar (**30 Julie 2015 - 31 Augustus 2015**). 'n Harde kopie van die bogenoemde dokumente is ook gestuur aan diegene vir wie ons posadresse het. Inligting van die projek is ook beskikbaar op die projekwebtuiste: <http://www.csir.co.za/eia/ScatecSolarPV/>.

Ons versoek graag dat alle kommentaar aan die WNNR Projekbestuurder (kontakbesonderhede onder aangedui) teen **31 Augustus 2015** verskaf word.

By voorbaat dankie,

Rohaida Abed

CSIR - Environmental Management Services
Posbus 17001, Congella, Durban, 4013
Tel: 031 242 2300
Faks: 031 261 2509
E-pos: RAbed@csir.co.za

Scoping and Environmental Impact Assessment for the proposed Development of a 75 MW Solar Photovoltaic Facility (KENHARDT PV 1) on the remaining extent of Onder Rugzeer Farm 168, north-east of Kenhardt, Northern Cape Province

From: Rohaida Abed
To: Miles, Melanie
Date: 27/08/2015 09:33
Subject: Re: Proposed Development of Three Solar Photovoltaic Facilities and Associated Electrical Infrastructure
Attachments: Scatec Solar BID_A4_8 PAGES_July2015_LOW RES.pdf; Comment and Response Form_Scatec Solar NC.pdf; CSIR Letter 1 to I&APs_Scatec Solar NC.pdf

Dear Melanie

As requested, please find attached a copy of the BID for the proposed project, as well as Letter 1 and Comment and Registration Form. Kindly note that the comment period closes on 31 August 2015. We will add you to the project database. Please note that all project information is available on the project website: <http://www.csir.co.za/eia/ScatecSolarPV/>

Thanks and kind regards,
Rohaida

>>> "Melanie Miles" <MelanieM@L2B.co.za> 03/08/2015 10:17 >>>

Good Morning,

Your company is currently conducting an Environmental Impact Assessment for the Proposed Development of Three Solar Photovoltaic Facilities and Associated Electrical Infrastructure North East of Kenhardt. Please could you forward me the BID for this application and register me as a Interested & Affected party?

Thanking you in anticipation of a favourable response.

Kindest Regards,

Melanie Miles
Content Researcher
MelanieM@L2B.co.za

Leads 2 Business (www.L2B.co.za)

0860836337 or 0860 TENDER
Fax: 033 343 5882

Copies and Proof of Correspondence Sent to I&APs for the Release of the Scoping Report for I&AP Review

Letter 2 - dated 25 September 2015: Notification of the Release of the Scoping Reports for a 30-day Review Period

CSIR Environmental Management Services
P. O. Box 17001, Congella, Durban, 4013
Tel: 031 242 2300
Fax: 031 261 2509
Email: RAbed@csir.co.za



25 September 2015

Dear Interested and Affected Party

RE: RELEASE OF SCOPING REPORTS FOR THE PROPOSED DEVELOPMENT OF THREE SOLAR PHOTOVOLTAIC (PV) FACILITIES (REFERRED TO AS KENHARDT PV 1, KENHARDT PV 2 AND KENHARDT PV 3) ON THE REMAINING EXTENT OF ONDER RUGZEER FARM 168, NORTH-EAST OF KENHARDT, NORTHERN CAPE PROVINCE (CSIR REFERENCE: EMS0102/SCATEC/2015)

Scatec Solar SA 163 (PTY) Ltd is proposing to develop three 75 Megawatt (MW) Solar Photovoltaic (PV) power generation facilities and associated electrical infrastructure (including 132 kV transmission lines for each 75 MW facility) on the remaining extent of Onder Rugzeer Farm 168 and the connection points to the Eskom Nieuwehoop Substation on the remaining extent of Portion 3 of Gembok Bult Farm 120, approximately 80 km south of Upington and 30 km north-east of Kenhardt within the IKheis Local Municipality, Northern Cape Province.

In terms of the National Environmental Management Act (Act 107 of 1998, as amended) (NEMA) and the 2014 NEMA Environmental Impact Assessment (EIA) Regulations promulgated in Government Gazette 38282 and Government Notice (GN) R982, R983, R984 and R985 on 8 December 2014, a full Scoping and EIA Process is required for the construction of the three Solar PV facilities. A separate Basic Assessment Process will be undertaken for the development of the proposed transmission lines, associated electrical infrastructure and connection to the Eskom Nieuwehoop Substation. The Council for Scientific and Industrial Research (CSIR) has been appointed by the Project Applicant to undertake the separate requisite Basic Assessment and Scoping and EIA Processes for the proposed projects.

The proposed 75 MW Solar PV facility projects (requiring a Scoping and EIA Process) and the Basic Assessment projects are referred to as:

Scoping and EIA Processes: Proposed 75 MW Solar PV Facilities	Basic Assessment Processes: Proposed 132 kV Transmission Lines and Associated Electrical Infrastructure
<ul style="list-style-type: none">Kenhardt PV 1Kenhardt PV 2Kenhardt PV 3	<ul style="list-style-type: none">Kenhardt PV 1 – Transmission LineKenhardt PV 2 – Transmission LineKenhardt PV 3 – Transmission Line

Scatec Solar SA 163 (PTY) Ltd consists of various subsidiary companies, three of which will serve as the Project Applicant for the proposed Scoping and EIA projects. Table 1 below indicates the Project Applicant details, as well as brief project details.

Table 1: Details of the Scoping and EIA Projects

Project Reference	Project Applicant	Generation Capacity	Project Footprint	Available Development Area
Kenhardt PV 1	Scatec Solar SA 330 (PTY) Ltd	75 MW	250 ha	450 ha
Kenhardt PV 2	Scatec Solar SA 350 (PTY) Ltd	75 MW	250 ha	540 ha
Kenhardt PV 3	Scatec Solar SA 370 (PTY) Ltd	75 MW	250 ha	1000 ha

Scatec Solar is an integrated independent power producer that is focused on making solar energy a sustainable and affordable source on a global scale. Linked to enhancing its operations within South Africa, each 75 MW Solar PV facility will cover an approximate area of 250 ha (as noted in Table 1 above). The required project footprint has increased from 200 ha (as reported in the Background Information Document dated July 2015) to 250 ha for each proposed solar PV facility in order to ensure optimum operations. The proposed solar PV facilities will be constructed adjacent to each other and will therefore have a collective footprint of approximately 750 ha and a combined power generation capacity of 225 MW. Preferred and alternative sites (referred to as Kenhardt PV 1b, Kenhardt PV 2b, and Kenhardt PV 3b) located within the remaining extent of Onder Rugzeer Farm 168 have been considered in the Scoping Phase. The preferred sites will be assessed in the EIA Phase. The area available to develop at the preferred sites exceeds the required project footprint area, and therefore there is scope to avoid major environmental constraints through the final design and layout of the facility. The proposed projects will entail the construction of a solar field, buildings, electrical infrastructure, internal access roads, and associated infrastructure and structures.

Since the proposed 75 MW Solar PV facilities are located within the same geographical area and constitute the same type of activity, an integrated Public Participation Process (PPP) will be undertaken for the proposed projects. However, separate Applications for Environmental Authorisation (EA) have been lodged with the Competent Authority (i.e. the National Department of Environmental Affairs (DEA)) for each proposed Scoping and EIA project and will be lodged for each Basic Assessment project. Furthermore, separate reports (i.e. Basic Assessment and Scoping and EIA Reports) will be compiled for each project. The Basic Assessment Reports will be made available for Interested and Affected Party (I&AP) and stakeholder review together with the EIA Reports.

In line with the above, as a registered I&AP on the project database, you are hereby notified of the release of the Scoping Reports for the Kenhardt PV 1, Kenhardt PV 2 and Kenhardt PV 3 projects to all registered I&APs and stakeholders for a 30-day review period, which will extend from **25 September 2015 to 27 October 2015**. Please find enclosed an Executive Summary of each Scoping Report (including a Comment and Registration Form), which provides an overview of the proposed project and the Scoping Process. Kindly complete the enclosed Comment and Registration Form in order to submit any comments, issues or concerns you may have. Please submit the completed form to the CSIR Project Manager at the contact details provided above by **27 October 2015**.

Hard copies of the Scoping Reports are available for public viewing at the Kenhardt Library (in Park Street) and the Groblershoop Library (at 97 Oranje Street). The Scoping Reports can also be downloaded from the following website: <http://www.csir.co.za/eia/ScatecSolarPV/>

All comments received during this 30 day review period will be recorded and included in the Scoping Reports for submission to the National DEA for decision-making in line with Regulations 21 and 22 of the 2014 EIA Regulations (GN R982). As a registered I&AP on the project database, you will be notified of the submission of the Scoping Reports to the DEA for decision-making.

Should you have any queries or require additional information please do not hesitate to contact the undersigned using the contact details provided above.

Sincerely,

Surina Laurie
Project Leader
CSIR Environmental Management Services

Rohaida Abed
Project Manager
CSIR Environmental Management Services

Comment and Registration Form sent with Letter 2 (dated 25 September 2015)

BASIC ASSESSMENT AND SCOPING AND ENVIRONMENTAL IMPACT ASSESSMENT (EIA) FOR THE PROPOSED DEVELOPMENT OF THREE SOLAR PHOTOVOLTAIC FACILITIES AND ASSOCIATED ELECTRICAL INFRASTRUCTURE NORTH-EAST OF KENHARDT, NORTHERN CAPE PROVINCE (KENHARDT PV 1, KENHARDT PV 2, KENHARDT PV 3, KENHARDT PV 1 – TRANSMISSION LINE, KENHARDT PV 2 – TRANSMISSION LINE, AND KENHARDT PV 3 – TRANSMISSION LINE)

RELEASE OF SCOPING REPORTS FOR KENHARDT PV 1, KENHARDT PV 2, KENHARDT PV 3

CSIR REFERENCE: EMS0102/SCATEC/2015

Project Applicant: Scatec Solar SA 330 (PTY) Ltd, Scatec Solar SA 350 (PTY) Ltd, and Scatec Solar SA 370 (PTY) Ltd

COMMENT AND REGISTRATION FORM

25 September 2015

Name:	Telephone:
Organisation:	Fax:
Designation:	Email:
Physical address:	Postal address:

Please indicate if you would like to register as an Interested and Affected Party (I&AP) for the proposed projects. Registration is required in order to receive further correspondence during the Basic Assessment and Scoping and EIA Processes. Please tick the appropriate box.

YES	
NO	

Please indicate if you have any interest (business, financial, personal or other) in the proposed projects and/or the Applications for Environmental Authorisation:

--

Please describe any issues or concerns you may have regarding the proposed projects, which you think should be considered during the Basic Assessment and Scoping and EIA Processes.

Please provide details of any other individuals or organisations that should be registered as I&APs:

Please complete this Comment and Registration Form by 27 October 2015 and submit it to:

Rohaida Abed CSIR Postal Address: P. O. Box 17001, Congella, Durban, 4013 Tel: 031 242 2300 Fax: 031 261 2509 E-mail: RAbed@csir.co.za Project Website: http://www.csir.co.za/eia/ScatecSolarPV/



Executive Summary of the Kenhardt PV 1 Scoping Report sent with Letter 2

Scoping and Environmental Impact Assessment for the Proposed Development of a 75 MW Solar Photovoltaic Facility (KENHARDT PV 1) on the remaining extent of Onder Rugzeer Farm 168, north-east of Kenhardt, Northern Cape Province

CSIR Report Number: CSIR/CAS/EMS/ER/2015/0007/B
CSIR Reference: EMS0102/Scatec/2015

Scoping Report – Executive Summary

1. PROJECT OVERVIEW

Scatec Solar SA 163 (PTY) Ltd is proposing to develop three 75 Megawatt (MW) Solar Photovoltaic (PV) power generation facilities and associated electrical infrastructure (132 kV transmission lines for each 75 MW facility) on the remaining extent of Onder Rugzeer Farm 168 and the connection points to the Eskom Nieuwehoop Substation on the remaining extent of Portion 3 of Gembok Bult Farm 120, approximately 80 km south of Upington and 30 km north-east of Kenhardt within the !Kheis Local Municipality, Northern Cape Province. Scatec Solar SA 163 (PTY) Ltd consists of various subsidiary companies, one of which is Scatec Solar SA 330 (PTY) Ltd. Scatec Solar SA 330 (PTY) Ltd (hereinafter referred to as Scatec Solar) is the Project Applicant for this proposed 75 MW solar PV project (referred to as Kenhardt PV 1).

In terms of the National Environmental Management Act (Act 107 of 1998, as amended) (NEMA) and the 2014 NEMA Environmental Impact Assessment (EIA) Regulations promulgated in Government Gazette 38282 and Government Notice (GN) R982, R983, R984 and R985 on 8 December 2014, a full Scoping and EIA Process is required for the construction of the three Solar PV facilities. A separate Basic Assessment Process will be undertaken for the development of the proposed transmission lines, associated electrical infrastructure and connection to the Eskom Nieuwehoop Substation. The Applicant has appointed the Council for Scientific and Industrial Research (CSIR) to undertake the separate EIA and Basic Assessment Processes in order to determine the biophysical, social and economic impacts associated with undertaking the proposed activity.

Since the proposed 75 MW Solar PV facilities are located within the same geographical area and constitute the same type of activity, an integrated Public Participation Process (PPP) will be undertaken for the proposed projects. However, separate Applications for Environmental Authorisation (EA) have been lodged with the Competent Authority (i.e. the National Department of Environmental Affairs (DEA)) for each proposed Scoping and EIA project and will be lodged for each Basic Assessment project. Furthermore, separate reports (i.e. Basic Assessment and Scoping and EIA Reports) will be compiled for each project. The Basic Assessment Reports will be made available for Interested and Affected Party (I&AP) review with the EIA Reports.

The proposed 75 MW Solar PV facility projects (requiring a Scoping and EIA Process) are referred to as:

- Kenhardt PV 1;
- Kenhardt PV 2; and
- Kenhardt PV 3.

The proposed 132 kV transmission line projects (requiring a Basic Assessment Process) are referred to as:

- Kenhardt PV 1 – Transmission Line;
- Kenhardt PV 2 – Transmission Line; and
- Kenhardt PV 3 – Transmission Line.

This Scoping Report only discusses the proposed **Kenhardt PV 1** project.

2. NEED FOR THE PROJECT

The Integrated Resource Plan for South Africa for the period 2010 to 2030 (referred to as "IRP 2010") was released by government in 2010, and proposes to develop and secure 17 800 MW of renewable energy capacity by 2030 (including wind, solar and other energy sources). The IRP was updated in 2013. The IRP 2010 has set up a target of 3 725 MW of renewable energy to be produced by Independent Power Producers (IPPs) by 2016. On 18 August 2015, an additional target of 6 300 MW to be procured and generated from renewable energy sources was added to the Renewable Energy

Independent Power Producer Procurement Programme (REIPPPP) as noted Government Gazette 39111. The additional target allocated for solar PV energy is 2 200 MW.

In 2011, the Department of Energy (DOE) launched the REIPPPP and invited potential IPPs to submit proposals for the financing, construction, operation and maintenance of the first 3 725 MW of onshore wind, solar thermal, solar PV, biomass, biogas, landfill gas or small hydro projects. The two main evaluation criteria for compliant proposals are price and economic development, with other selection criteria including technical feasibility and grid connectivity, environmental acceptability, black economic empowerment, community development, and local economic and manufacturing propositions. The bidders with the highest rankings (according to the aforementioned criteria) are appointed as "Preferred Bidders" by the DOE. The proposed projects aim to contribute to the above strategic imperative.

3. PROJECT DESCRIPTION

It is important to point out at the outset that the exact specifications of the proposed project components will be determined during the detailed engineering phase.

Linked to enhancing its operations within South Africa, the 75 MW Solar PV facility (i.e. Kenhardt PV 1) proposed by Scatec Solar will cover an approximate area of 250 hectares (ha). A preferred and alternative site (referred to as Kenhardt PV 1b) have been considered in the Scoping Phase. The preferred site will be assessed in the EIA Phase. The preferred site includes approximately 450 ha of land. Due to the fact that this project only requires 250 ha of land, there is scope to avoid major environmental constraints through the final design of the facility.

The proposed project will make use of PV solar technology to generate electricity from the sun's energy. The Applicant is proposing to develop a facility with a possible maximum installed capacity of 100 MW Direct Current (DC) which produces 75 MW Alternating Current (AC) of electricity from PV solar energy.

Once a Power Purchase Agreement (PPA) is awarded, the proposed facility will generate electricity for a minimum period of 20 years. It is proposed that Scatec Solar will implement the Self-Build Option for the additional electrical infrastructure to be constructed (which includes the 132 kV transmission line and additional feeder bay(s), busbar(s), transformer bay, and extension to the platform at the Eskom Nieuwehoop Substation (which will be assessed separately as part of a Basic Assessment Process)). Following the construction phase, the proposed transmission line will either be transferred into the ownership of Eskom or remain in the ownership of Scatec Solar.

The solar facility will consist of the following components:

- Solar Field:
 - Solar Arrays:
 - PV Modules;
 - Tracking structures;
 - Solar module mounting structures comprised of galvanised steel and aluminium; and
 - Foundations which will likely be drilled and concreted into the ground.
- Building Infrastructure:
 - Offices;
 - Operational and maintenance control centre;
 - Warehouse/workshop;
 - Ablution facilities;
 - Converter station;
 - On-site substation building; and
 - Guard House.
- Associated Infrastructure
 - 132 kV overhead transmission line (as mentioned above this will be subject to a separate Basic Assessment Process, referred to as Kenhardt PV 1 – Transmission Line);
 - Associated electrical infrastructure at the Eskom Nieuwehoop Substation (including but not limited to feeders, Busbars, transformer bay and extension to the platform at the Eskom Nieuwehoop Substation) (as mentioned above this will be subject to a separate Basic Assessment Process, referred to as Kenhardt PV 1 – Transmission Line);

- On-site substation;
- Internal transmission lines/underground cables;
- Underground low voltage cables or cable trays;
- Access roads;
- Internal gravel roads;
- Fencing;
- Panel maintenance and cleaning area;
- Stormwater channels;
- Water pipelines; and
- Temporary work area during the construction phase (i.e. laydown area).

4. NEED FOR AN ENVIRONMENTAL IMPACT ASSESSMENT

As noted above, in terms of the EIA Regulations promulgated under Chapter 5 of the NEMA published in GN R982, R983, R984 and R985 on 4 December 2014 and enforced on 8 December 2014, a full Scoping and EIA Process is required for the proposed project. The need for the full Scoping and EIA is triggered by, amongst others, the inclusion of Activity 1 listed in GN R984 (Listing Notice 2):

- *"The development of facilities or infrastructure for the generation of electricity from a renewable resource where the electricity output is 20 megawatts or more, excluding where such development of facilities or infrastructure is for photovoltaic installations and occurs within an urban area".*

Given that energy related projects have been elevated to national strategic importance in terms of the EA Process, the proposed project requires authorisation from the National DEA, acting in consultation with other spheres of government.

The purpose of the EIA is to identify, assess and report on any potential impacts the proposed project, if implemented, may have on the receiving environment. The Environmental Assessment therefore needs to show the Competent Authority, the DEA; and the project proponent, Scatec Solar, what the consequences of their choices will be in terms of impacts on the biophysical and socio-economic environment and how such impacts can be, as far as possible, enhanced or mitigated and managed as the case may be.

5. PURPOSE OF THE SCOPING REPORT

The Scoping Phase of the EIA refers to the process of determining the spatial and temporal boundaries for the EIA. In broad terms, the objectives of the Scoping Process in terms of the 2014 NEMA EIA Regulations (GN R982) are to:

- Confirm the process to be followed and opportunities for stakeholder engagement;
- Clarify the project scope to be covered;
- Identify and confirm the preferred activity and technology alternative;
- Identify and confirm the preferred site for the preferred activity;
- Identify the key issues to be addressed in the impact assessment phase and the approach to be followed in addressing these issues; and
- Confirm the level of assessment to be undertaken during the impact assessment

This is achieved through parallel initiatives of consulting with:

- The lead authorities involved in the decision-making for this EIA application;
- The public to ensure that local issues are well understood; and
- The EIA specialist team to ensure that technical issues are identified.

The Scoping Process is supported by a review of relevant background literature on the local area. Through this comprehensive process, the environmental assessment can identify and focus on key issues requiring assessment.

The primary objective of the Scoping Report is to present key stakeholders (including affected organs of state) with an overview of the project and key issues that require assessment in the EIA Phase and allow the opportunity for the identification of additional issues that may require assessment.

Issues raised thus far during the Scoping Process have been captured in the Issues and Responses Trail in Chapter 7 of the Scoping Report. Issues raised in response to this Scoping Report (currently being released for a 30-day comment period) will be captured in an Issues and Responses Trail as an appendix to the Scoping Report, which will be submitted to the National DEA for decision-making (i.e. approval or rejection) in line with Regulation 21 (1) of GN R982. This approval is planned to mark the end of the Scoping Phase after which the EIA Process moves into the impact assessment and reporting phase.

6. IDENTIFICATION OF ISSUES

The project was advertised in one local newspaper and letters regarding the Basic Assessment and EIA Process were mailed to all pre-identified key stakeholders on the database. The Scoping Report includes the issues identified to date as part of the Scoping Process. A synthesis of these issues is provided in the Issues and Response Trail (Chapter 7), which includes an explanation of how the issues will be addressed in the EIA Phase.

The list below indicates the main issues identified thus far during the Scoping Phase and to be addressed during the EIA Process.

6.1. Terrestrial Ecology Impacts:

- Construction Phase: Ousting of fauna through increased anthropogenic activities, disturbance of refugia (location of an isolated population that was widespread in the past) and general change in habitat.
- Construction Phase: Increased electrical light pollution leading to changes in nocturnal behavioural patterns amongst fauna.
- Construction Phase: Exclusion (or entrapment) of in particular, larger fauna on account of the fencing of the site.
- Construction Phase: Changes in edaphics (soils) on account of excavation and import of material, leading to alteration of plant communities and fossorial species in and around these points.
- Operational Phase: Alteration of ecological processes on account of the exclusion of certain species inherent to the functional state of land within the PV facility i.e. larger fossorial species and predators will be excluded from the PV facility site by virtue of its fencing, generally leading to possible variations in populations of other species that remain within the site, with concomitant ecological change.
- Operational Phase: Increased shading of vegetation as a consequence of the PV arrays, will lead to changes in plant water relations and possible changes in plant community structures within the site.
- Operational Phase: Changes in meteorological factors at a localised scale on account of the PV facility is likely to arise (e.g. subtle changes in wind dynamics, "heat bubbles", as well as alteration in run off of surface water and evapotranspiration states), leading to long term, but generally latent changes in habitat.
- Operational Phase: The fencing of the site, possibly with electric fencing, is likely to impact upon faunal behaviour, leading to the exclusion of certain species and possible mortalities. Alternatively, such changes may also favour some specific individuals, particularly those that remain within the confines of the proposed PV facility, which is likely to lead to further localised alteration in habitat and ecological processes within the facility.

6.2. Aquatic Ecology Impacts:

- Construction Phase: Alteration in surface drainage patterns on account of construction activities leading to rapid change in plant communities and general habitat structure both within the site and immediately adjacent to site.
- Construction Phase: Alteration of surface water quality on account of construction activities that lead to changes in water chemistry (e.g. use of concrete, increased hydrocarbon input, increased sediment within run off etc. alter various chemical parameters).
- Construction Phase: Depending upon the origin of water (import or through abstraction of groundwater) changes in sub-surface water resources may arise, particularly in the case of the latter.
- Operational Phase: Abstraction of ground water for the cleaning of modules will alter the state of sub-surface water resources, depending upon nature and origin of such water.

6.3. Visual Impacts:

- Construction Phase: Potential visual intrusion of construction activities on the existing views of sensitive visual receptors in the rural landscape.
- Construction Phase: Potential visual intrusion of a large area cleared of vegetation on the existing views of sensitive visual receptors.

- Construction Phase: Potential visual impact of night lighting during the construction phase on the nightscape of the region.
- Operational Phase: Potential landscape impact of introducing a large solar plant into a remote rural landscape.
- Operational Phase: Potential visual intrusion of a large solar field on the existing views of sensitive visual receptors.
- Operational Phase: Potential visual intrusion of tall, relatively large structures on the existing views of sensitive visual receptors.
- Operational Phase: Potential impact of night lighting of the development on the relatively dark rural nightscape.

6.4. Archaeology and Cultural Landscape:

- Construction and Operational Phases:
 - Direct disturbance and/or destruction of archaeological material;
 - Direct impacts to the landscape through introduction of industrial type facilities; and
 - Direct disturbance and/or destruction of possible graves (although unlikely).

6.5. Palaeontology:

- Potential damage to or destruction of fossil heritage at or near the surface within the study area.

6.6. Geohydrology:

- Construction and Operational Phases:
 - Limited groundwater availability in the region;
 - Water quality of the existing boreholes present within the study area; and
 - Borehole yields of existing boreholes that are present within the study area.

6.7. Soils and Agricultural Potential

- Operational Phase: Economic consequences of the proposed project at local/regional scale due to the modification/loss of agricultural potential on the site.
- Operational Phase: Whether soil conditions will be transformed and agricultural soil resources will be damaged or lost.

6.8. Social Issues:

- Construction and Operational Phases:
 - Influx of jobseekers;
 - Increased competition for urban-based employment;
 - Increases in social deviance;
 - Increases in incidence of HIV/AIDS infections;
 - Expectations regarding jobs;
 - Local spending;
 - Local employment; and
 - Job losses at the end of the project life-cycle.

The Plan of Study for EIA (Chapter 8) presents the approach to the forthcoming EIA Phase. This includes the Terms of Reference for the various specialist studies that are proposed to address the issues raised, where necessary.

Proof of Correspondence with I&APs (Registered Mail Receipts for Letter 2 (dated 25 September 2015))

**DALBRIDGE POST OFFICE
LIST OF REGISTERED MAIL FOR CSIR DURBAN – September 2015**

SCATEC SOLAR - DISTRIBUTION LIST FOR Rohaida Abed – Unit: CAS

No	Name	Surname	Company	Designation	Postal Address	Registered Number Customer Copy (for CSIR)
1	Mmatlala	Robothata	National Department of Environmental Affairs; Department of Environmental Affairs; Integrated Environmental Authorisations	Competent Authority	Private Bag X447 Pretoria 0001	REGISTERED LETTER (with a domestic insurance option) Sharcad 0800 111 531 www.saps.co.za RC 073 712 585 ZA CUSTOMER COPY 301028
2	M	Mathews	Provincial Department of Environment and Nature Conservation: Northern Cape	Provincial Environmental Authority	Private Bag X6102 Kimberley 8300	REGISTERED LETTER (with a domestic insurance option) Sharcad 0800 111 531 www.saps.co.za RC 073 712 599 ZA CUSTOMER COPY 301028
3	Samantha	De la Fontaine	Provincial Department of Environment and Nature Conservation: Northern Cape	Provincial Environmental Authority (District Ecologist (Candidate Scientist)	Provincial Building (First Floor) Corner of Olivier & Nelson Mandela Road, Upington, 8200	REGISTERED LETTER (with a domestic insurance option) Sharcad 0800 111 531 www.saps.co.za RC 073 712 608 ZA CUSTOMER COPY 301028
4	Eric	Ngxanga	ZF Mgcawu District Municipality - Municipal Manager	Municipal Manager	Private Bag X6034 Upington 8800	REGISTERED LETTER (with a domestic insurance option) Sharcad 0800 111 531 www.saps.co.za RC 073 712 625 ZA CUSTOMER COPY 301028
5	H.T	Scheepers	IKheis Municipality - Municipal Manager	Municipal Manager	Private Bag X2, Orange Street 97, Groblershoop 8850	REGISTERED LETTER (with a domestic insurance option) Sharcad 0800 111 531 www.saps.co.za RC 073 712 683 ZA CUSTOMER COPY 301028
6	JG	Lategan	Kai I Garib Municipality - Municipal Manager	Municipal Manager	Private Bag X6, Kakamas, 8870	REGISTERED LETTER (with a domestic insurance option) Sharcad 0800 111 531 www.saps.co.za RC 073 712 681 ZA CUSTOMER COPY 301028
7	Mashudu	Randwedzi	Department of Water and Sanitation	DWS	Private Bag X5912 Upington 8800	REGISTERED LETTER (with a domestic insurance option) Sharcad 0800 111 531 www.saps.co.za RC 073 712 684 ZA CUSTOMER COPY 301028
8	Shaun	Cloete	Department of Water and Sanitation	DWS	Private Bag X5912 Upington 8801	REGISTERED LETTER (with a domestic insurance option) Sharcad 0800 111 531 www.saps.co.za RC 073 712 682 ZA CUSTOMER COPY 301028
9	Mandla	Ndzilili	Ministry of Environment and Nature Conservation		Private Bag X6120 Kimberley 8301	REGISTERED LETTER (with a domestic insurance option) Sharcad 0800 111 531 www.saps.co.za RC 073 712 695 ZA CUSTOMER COPY 301028
10	Sibonelo	Mbariwa	Provincial Department of Environment and Nature Conservation: Northern Cape		Private Bag X6120 Kimberley 8301	REGISTERED LETTER (with a domestic insurance option) Sharcad 0800 111 531 www.saps.co.za RC 073 712 611 ZA CUSTOMER COPY 301028
11	Mashudu	Marubini	Department of Agriculture, Forestry and Fisheries - Delegate of the Minister (Act 70 of 1970)	Delegate of the Minister (Act 70 of 1970)	Private Bag X120, Pretoria 0001	REGISTERED LETTER (with a domestic insurance option) Sharcad 0800 111 531 www.saps.co.za RC 073 712 639 ZA CUSTOMER COPY 301028
12	Thoko	Buthelezi	Department of Agriculture, Forestry and Fisheries - AgriLand Liaison office		Private Bag X120, Pretoria 0001	REGISTERED LETTER (with a domestic insurance option) Sharcad 0800 111 531 www.saps.co.za RC 088 033 947 ZA CUSTOMER COPY 301028
13	D	Nhlakad	Department of Agriculture, Forestry and Fisheries - AgriLand Liaison office		Private Bag X120, Pretoria 0001	REGISTERED LETTER (with a domestic insurance option) Sharcad 0800 111 531 www.saps.co.za RC 088 033 902 ZA CUSTOMER COPY 301028
14	Anneliza	Colet	Department of Agriculture, Forestry and Fisheries - AgriLand Liaison office		Private Bag X120, Pretoria 0001	REGISTERED LETTER (with a domestic insurance option) Sharcad 0800 111 531 www.saps.co.za RC 088 033 920 ZA CUSTOMER COPY 301028
15	Ali	Ditene	Agriculture, Land Reform & Rural Development		Private Bag X 5018, Kimberley, 8300	REGISTERED LETTER (with a domestic insurance option) Sharcad 0800 111 531 www.saps.co.za RC 088 033 916 ZA CUSTOMER COPY 301028
16	Plejet	Buys	National Energy Regulator of South Africa (NERSA)		PO Box 40343, Arcadia, 0007	REGISTERED LETTER (with a domestic insurance option) Sharcad 0800 111 531 www.saps.co.za RC 088 033 933 ZA CUSTOMER COPY 301028
17	IA	Bulane	Department of Public Works, Roads and Transport		PO Box 3132, Squarehill Park, Kimberley 8300	REGISTERED LETTER (with a domestic insurance option) Sharcad 0800 111 531 www.saps.co.za RC 088 033 955 ZA CUSTOMER COPY 301028

Scoping and Environmental Impact Assessment for the proposed Development of a 75 MW Solar Photovoltaic Facility (KENHARDT PV 1) on the remaining extent of Onder Rugzeer Farm 168, north-east of Kenhardt, Northern Cape Province

No	Name	Surname	Company	Designation	Postal Address	Registered Number Customer Copy (for CSIR)
18	Denver	Van Heerden	Department of Public Works, Roads and Transport		PO Box 3132, Souterehill Park, Kimberley 8300	REGISTERED LETTER (with a domestic insurance option) Standard 080 711 801 www.espost.co.za RC 088 033 046 ZA CUSTOMER COPY 301028R
19	Rene	de kock	South African Roads Agency Limited (SANRAL) Northern Cape (Western Region)		Private Bag X19 Bellville, 7535	REGISTERED LETTER (with a domestic insurance option) Standard 080 711 801 www.espost.co.za RC 088 033 010 ZA CUSTOMER COPY 301028R
20	M	Lephane	Department of Labour		Private Bag X5012, Kimberley, 8300	REGISTERED LETTER (with a domestic insurance option) Standard 080 711 801 www.espost.co.za RC 088 033 023 ZA CUSTOMER COPY 301028R
21	A	Botes	Department of Social Development		Private Bag X 5042, Kimberley 8300	REGISTERED LETTER (with a domestic insurance option) Standard 080 711 801 www.espost.co.za RC 088 033 037 ZA CUSTOMER COPY 301028R
22	Riaan	Warie	Northern Cape Economic Development Agency		227 Dr. Toitsoan Road, Selgriavia, Kimberley 8301	REGISTERED LETTER (with a domestic insurance option) Standard 080 711 801 www.espost.co.za RC 088 033 045 ZA CUSTOMER COPY 301028R
23	Andrew	Timothy	Directorate Heritage, Department - Sports, Arts and Culture		P. O. Box 1030, Kimberley 8300	REGISTERED LETTER (with a domestic insurance option) Standard 080 711 801 www.espost.co.za RC 088 033 054 ZA CUSTOMER COPY 301028R
24	Lizell	Stroh	South African Civilian Aviation Authority		Private Bag X73 Halfway House 1685	REGISTERED LETTER (with a domestic insurance option) Standard 080 711 801 www.espost.co.za RC 073 713 082 ZA CUSTOMER COPY 301028R
25	John	Geeringh	ESKOM	Commenting authority	P.O.Box 1091 Johannesburg 2157	REGISTERED LETTER (with a domestic insurance option) Standard 080 711 801 www.espost.co.za RC 073 713 076 ZA CUSTOMER COPY 301028R
26	Shaaron	Steyn	Northern Cape Chamber of Commerce and Industry		PO Box 350, Kimberley 8300	REGISTERED LETTER (with a domestic insurance option) Standard 080 711 801 www.espost.co.za RC 073 713 020 ZA CUSTOMER COPY 301028R
27	H	Myburgh	Agri Northern Cape		PO Box 1094, Kimberley 8300	REGISTERED LETTER (with a domestic insurance option) Standard 080 711 801 www.espost.co.za RC 073 713 033 ZA CUSTOMER COPY 301028R
28	The Director		Department of Energy Northern Cape		Private Bag X6093 Kimberley, 8300	REGISTERED LETTER (with a domestic insurance option) Standard 080 711 801 www.espost.co.za RC 073 713 047 ZA CUSTOMER COPY 301028R
29	Simon	Gear	Birdlife South Africa		PO Box 515 Randburg, 2194	REGISTERED LETTER (with a domestic insurance option) Standard 080 711 801 www.espost.co.za RC 073 713 055 ZA CUSTOMER COPY 301028R
30	Lubabalo	Nisole	C.A.P.E. Co-ordination Unit: Northern Cape		Private Bag X7, Claremont, 7735	REGISTERED LETTER (with a domestic insurance option) Standard 080 711 801 www.espost.co.za RC 073 712 982 ZA CUSTOMER COPY 301028R
31	Dr. Howard	Hendricks	South African National Parks (SANParks) - Snr GM: Policy & Governance Conservation Services Division		PO Box 787, Pretoria, 0001	REGISTERED LETTER (with a domestic insurance option) Standard 080 711 801 www.espost.co.za RC 073 712 885 ZA CUSTOMER COPY 301028R
32	Rudolph	Grobler			PO Box 41 Keimoes 8860	REGISTERED LETTER (with a domestic insurance option) Standard 080 711 801 www.espost.co.za RC 073 712 894 ZA CUSTOMER COPY 301028R
33	Ernest	Connan	Ernest Connan Trust		PO Box 290, Upington, 8800	REGISTERED LETTER (with a domestic insurance option) Standard 080 711 801 www.espost.co.za RC 073 712 996 ZA CUSTOMER COPY 301028R
34	Johan	Steenkamp	JHJ Steenkamp Trust		JHJ Steenkamp Trust PO Box 3267 Upington 8800	REGISTERED LETTER (with a domestic insurance option) Standard 080 711 801 www.espost.co.za RC 073 712 903 ZA CUSTOMER COPY 301028R



Scoping and Environmental Impact Assessment for the proposed Development of a 75 MW Solar Photovoltaic Facility (KENHARDT PV 1) on the remaining extent of Onder Rugzeer Farm 168, north-east of Kenhardt, Northern Cape Province

REGISTERED LETTER GEREGISTREERDE BRIEF <small>(with an insurance option/ met 'n versekeringsopsie)</small>			Postage paid R _____ c
			Service fee / Diensgeld R _____ c
			Insurance / Versekering R _____ c
			Total / Totaal R _____ c
Full tracking and tracing/Volledige volg en spoor		Insured value of contents Versekering waarde van inhoud R _____ c	
Addressed to/Geadresseer aan <u>CSIR</u>		Enquiries/Navrae Sharecall number/nommer 0860 111 502 www.postoffice.co.za	Initial of accepting officer <u>JW</u>
<u>34/Christyford</u> <input type="checkbox"/> <input type="checkbox"/> <input type="checkbox"/> <input type="checkbox"/> Post code Poskode			
<small>The value of the contents of this letter is as indicated and compensation is not payable for a letter received unconditionally. Compensation is limited to R100,00. No compensation is payable without documentary proof. Optional insurance up to R2 000,00 is available and applies to domestic registered letters only. Die waarde van die inhoud van hierdie brief is soos aangedui en vergoeding sal nie betaal word vir 'n brief wat sonder voorbehoud ontvang word nie. Vergoeding is beperk tot R100,00. Geen vergoeding is sonder dokumentêre bewys betaalbaar nie. Opsionele versekering tot R2 000,00 is beskikbaar en is slegs op binnelandse geregisterde briewe van toepassing.</small>		Affix Track and Trace customer copy	
		Plak Volg en Spoor Klientafstrik	Peraaf van aaneem- beampte Datumstempel

Email 2 sent to all I&APs on 23 September 2015

From: Rohaida Abed
To: Abed, Rohaida
BC Clive.Stephenson@transnet.net; CloeteS@dws.gov.za; GeerinJH@eskom.co.za; Gilbert.Nortier@transnet.net; HaarhL@eskom.co.za; JacolineMa@daff.gov.za; Laurie, Surina; LeaskK@eskom.co.za; MRabothata@environment.gov.za; Marina.Lourens@transnet.net; MashuduMa@daff.gov.za; Mayvyn.Bhana@transnet.net; MeiM@dwa.gov.za; MelanieM@L2B.co.za; ThokoB@daff.gov.za; WyngaaJO@eskom.co.za; aditeme@agri.ncape.gov.za; admin@grasslands.org.za; advocacy@birdlife.org.za; ameliastrauss2@gmail.com; andre.vanniekerk10@gmail.com; annelizac@nda.agric.za; atiplady@ska.ac.za; boozahunter@yahoo.com; Claude Bosman; ernest.connan@donco.co.za; fpr@bodr.gov.za; hendri@aheadtrading.co.za; jdbhenrohn@gmail.com; jhjs@webmail.co.za; karen@mulilo.com; klawrence@trpw.ncape.gov.za; kraaines@mweb.co.za; l.ntsolo@sanbi.org.za; marcyroxnpc@gmail.com; messop@environment.gov.za; mitchell.hodgson@scatecsolar.com; mm@kaigarib.gov.za; mmathews@ncpg.gov.za; mndzilili@ncpg.gov.za; monica.lepheane@labour.gov.za; ncagric@worldonline.co.za; nhlakad@daff.gov.za; nyaphi@ncpg.gov.za; ontvang@agric.co.za; peter.buys@nersa.org.za; ratha.timothy@gmail.com; rwarie@ncpg.gov.za; sb@siyanda.gov.za; sdelafontaine@gmail.com; sharon@nocci.co.za; smbajwa@ncpg.gov.za; straussdj@orientis.co.za; strohl@caa.co.za; teresascheepers@vodamail.co.za; townsendmorgan029@gmail.com; waltjc@nra.co.za; wep@ewt.org.za
Date: 23/09/2015 15:29
Subject: Release of Scoping Reports - Solar PV Facilities and Associated Electrical Infrastructure, Northern Cape
Attachments: Scatec Solar PV1_SR_SUMMARY.pdf; Scatec Solar PV2_SR_SUMMARY.pdf; Scatec Solar PV3_SR_SUMMARY.pdf; CSIR Letter 2 to I&APs_Scatec Solar NC.pdf; Comment and Response Form_Scatec Solar_NC.pdf

Dear Stakeholders and Interested and Affected Parties

NOTICE OF RELEASE OF SCOPING REPORTS FOR THE PROPOSED DEVELOPMENT OF THREE SOLAR PHOTOVOLTAIC (PV) FACILITIES (REFERRED TO AS KENHARDT PV 1, KENHARDT PV 2, AND KENHARDT PV 3) ON THE REMAINING EXTENT OF ONDER RUGZEER FARM 168, NORTH-EAST OF KENHARDT, NORTHERN CAPE PROVINCE

Competent Authority: National Department of Environmental Affairs

CSIR REFERENCE: EMS0102/Scatec/2015

This e-mail correspondence serves to inform you of the release of Scoping Reports for the development of three 75 Megawatt (MW) Solar Photovoltaic (PV) power generation facilities, located on the remaining extent of Onder Rugzeer Farm 168, approximately 80 km south of Upington and 30 km north-east of Kenhardt within the !Kheis Local Municipality, Northern Cape Province. The proposed 75 MW Solar PV projects are referred to as: Kenhardt PV 1, Kenhardt PV 2 and Kenhardt PV 3 respectively. The Project Applicant is Scatec Solar SA 330 (PTY) Ltd for Kenhardt PV 1, Scatec Solar SA 350 (PTY) Ltd for Kenhardt PV 2 and Scatec Solar SA 370 (PTY) Ltd for Kenhardt PV 3.

In terms of the National Environmental Management Act (Act 107 of 1998, as amended) (NEMA) and the 2014 NEMA Environmental Impact Assessment (EIA) Regulations promulgated in Government Gazette 38282 and Government Notice (GN) R982, R983, R984 and R985 on 8 December 2014, a full Scoping and EIA Process is required for the construction of the three Solar PV facilities. A separate Basic Assessment Process will be undertaken for the development of the proposed transmission lines, associated electrical infrastructure and connection to the Eskom Nieuwehoop Substation (which is currently being constructed) on the remaining extent of Portion 3 of Gemsbok Bult Farm 120. The CSIR has been appointed by the Project Applicant to undertake the separate requisite Basic Assessment, and Scoping and EIA Processes for the proposed projects.

The proposed 75 MW Solar PV facilities are located within the same geographical area and constitute the same type of activity; hence an integrated Public Participation Process will be undertaken. However, separate Applications for Environmental Authorisation are currently being lodged with the National Department of Environmental Affairs (DEA) for each proposed 75 MW Solar PV facility and will be lodged for each Basic Assessment project. Furthermore, separate Basic Assessment, Scoping and EIA Reports will be compiled for each project.

In line with the above, as a registered Interested and Affected Party (I&AP) on the project database, you are hereby notified of the release of the Scoping Reports for the Kenhardt PV 1, Kenhardt PV 2 and Kenhardt PV 3 projects for a 30-day review period, which will extend from **25 September 2015 to 27 October 2015**.

Please find attached the following:
- Executive Summary of each Scoping Report;

- Letter 2 to I&APs; and
- Comment and Registration Form.

Hard copies of the Scoping Reports are available for public viewing at the Kenhardt Library (in Park Street) and the Groblershoop Library (at 97 Oranje Street).

In addition, the above-mentioned project information can be accessed at the following website: <http://www.csir.co.za/eia/ScatecSolarPV/>

Kindly ensure that all comments are submitted to the CSIR Project Manager (details provided below) by **27 October 2015**.

Thank you and kind regards,

Rohaida Abed

CSIR - Environmental Management Services
P. O. Box 17001, Congella, Durban, 4013
Tel: 031 242 2300
Fax: 031 261 2509
Email: RAbed@csir.co.za

Proof of Delivery of Email 2 sent to all I&APs on 23 September 2015

Page 1 of 3

Message Id: 5602A91C.47F : 179 : 65115
 Subject: Release of Scoping Reports - Solar PV Facilities and Associated Electrical Infrastructure, Northern Cape
 Created By: RAbed@csir.co.za
 Scheduled Date:
 Creation Date: 23/09/2015 15:29
 From: Rohalda Abed

Recipients:

Recipient	Action	Date & Time	Comment
 agr.ncape.gov.za	Transferred	23/09/2015 15:29	
BC: adleme@agr.ncape.gov.za(adleme@agr.ncape.gov.za)	Delivered	23/09/2015 15:30	
 agric.co.za	Transferred	23/09/2015 15:29	
BC: onbvang@agric.co.za(onbvang@agric.co.za)	Undeliverable	23/09/2015 15:30	
 aheadtrading.co.za	Transferred	23/09/2015 15:29	
BC: hendri@aheadtrading.co.za(hendri@aheadtrading.co.za)	Delivered	23/09/2015 15:30	
 birdlife.org.za	Transferred	23/09/2015 15:29	
BC: advocacy@birdlife.org.za(advocacy@birdlife.org.za)	Delivered	23/09/2015 15:30	
 bodr.gov.za	Transferred	23/09/2015 15:29	
BC: fpr@bodr.gov.za(fpr@bodr.gov.za)	Undeliverable	23/09/2015 15:30	
 caa.co.za	Transferred	23/09/2015 15:29	
BC: stroh@caa.co.za(stroh@caa.co.za)	Delivered	23/09/2015 15:30	
 daff.gov.za	Transferred	23/09/2015 15:29	
BC: JacquelineMa@daff.gov.za(JacolineMa@daff.gov.za)	Delivered	23/09/2015 16:13	
BC: MashudiMa@daff.gov.za(MashudiMa@daff.gov.za)	Delivered	23/09/2015 16:13	
BC: rhlakad@daff.gov.za(rhlakad@daff.gov.za)	Delivered	23/09/2015 16:13	
BC: ThokoB@daff.gov.za(ThokoB@daff.gov.za)	Delivered	23/09/2015 16:13	
 donco.co.za	Transferred	23/09/2015 15:29	
BC: emest.connan@donco.co.za(emest.connan@donco.co.za)	Delivered	23/09/2015 15:30	
 dwa.gov.za	Transferred	23/09/2015 15:29	
BC: MeM@dwa.gov.za(MeM@dwa.gov.za)	Delivered	23/09/2015 15:30	
 dws.gov.za	Transferred	23/09/2015 15:29	
BC: OloeteS@dws.gov.za(OloeteS@dws.gov.za)	Delivered	23/09/2015 15:31	
 environment.gov.za	Transferred	23/09/2015 15:29	
BC: messop@environment.gov.za(messop@environment.gov.za)	Delivered	23/09/2015 15:31	
BC: MRabothata@environment.gov.za(MRabothata@environment.gov.za)	Delivered	23/09/2015 15:31	
 eskom.co.za	Transferred	23/09/2015 15:29	
BC: GeeruiH@eskom.co.za(GeeruiH@eskom.co.za)	Delivered	23/09/2015 15:31	
BC: HaarlL@eskom.co.za(HaarlL@eskom.co.za)	Delivered	23/09/2015 15:31	
BC: LeaskK@eskom.co.za(LeaskK@eskom.co.za)	Delivered	23/09/2015 15:31	
BC: WynnasaJO@eskom.co.za(WynnasaJO@eskom.co.za)	Delivered	23/09/2015 15:31	
 ewt.org.za	Transferred	23/09/2015 15:29	
BC: wsp@ewt.org.za(wsp@ewt.org.za)	Delivered	23/09/2015 15:31	
 gmail.com	Transferred	23/09/2015 15:29	
BC: amelastrousa2@gmail.com(ameIaStrauss2@gmail.com)	Delivered	23/09/2015 15:30	
BC: andre.vanniekerk1D@gmail.com(andre.vanniekerk1D@gmail.com)	Delivered	23/09/2015 15:30	
BC: jdbhenrohn@gmail.com(jdbhenrohn@gmail.com)	Delivered	23/09/2015 15:30	
BC: marcyrowmpc@gmail.com(marcyrowmpc@gmail.com)	Delivered	23/09/2015 15:30	
BC: rathatimothy@gmail.com(rathatimothy@gmail.com)	Delivered	23/09/2015 15:30	
BC: sdelafontaine@gmail.com(sdelafontaine@gmail.com)	Delivered	23/09/2015 15:30	
BC: townsendmorgan029@gmail.com(townsendmorgan029@gmail.com)	Delivered	23/09/2015 15:30	
 grasslands.org.za	Transferred	23/09/2015 15:29	
BC: admin@grasslands.org.za(admin@grasslands.org.za)	Delivered	23/09/2015 15:30	
 kalgarib.gov.za	Transferred	23/09/2015 15:29	
BC: mm@kalgarib.gov.za(mm@kalgarib.gov.za)	Delivered	23/09/2015 15:30	
 L3S.co.za	Transferred	23/09/2015 15:29	
BC: MelanieM@L3S.co.za(MelanieM@L3S.co.za)	Delivered	23/09/2015 15:29	
 labour.gov.za	Transferred	23/09/2015 15:29	

BC: monica.lepheane@labour.gov.za(monica.lepheane@labour.gov.za)	Delivered	23/09/2015 15:30
mullo.com	Transferred	23/09/2015 15:29
BC: karen@mullo.com(karen@mullo.com)	Delivered	23/09/2015 15:30
mweb.co.za	Transferred	23/09/2015 15:29
BC: kraaines@mweb.co.za(kraaines@mweb.co.za)	Delivered	23/09/2015 15:30
ncpg.gov.za	Transferred	23/09/2015 15:29
BC: mmafhews@ncpg.gov.za(mmafhews@ncpg.gov.za)	Delivered	23/09/2015 15:32
BC: mndzll@ncpg.gov.za(mndzll@ncpg.gov.za)	Delivered	23/09/2015 15:32
BC: nysphi@ncpg.gov.za(nysphi@ncpg.gov.za)	Delivered	23/09/2015 15:32
BC: nwarie@ncpg.gov.za(nwarie@ncpg.gov.za)	Delivered	23/09/2015 15:32
BC: smbanjwa@ncpg.gov.za(smbanjwa@ncpg.gov.za)	Delivered	23/09/2015 15:32
nda.agric.za	Transferred	23/09/2015 15:29
BC: annelizac@nda.agric.za(annelizac@nda.agric.za)	Delivered	23/09/2015 15:30
nersa.org.za	Transferred	23/09/2015 15:29
BC: peter.buys@nersa.org.za(peter.buys@nersa.org.za)	Delivered	23/09/2015 15:40
nocci.co.za	Transferred	23/09/2015 15:29
BC: sharon@nocci.co.za(sharon@nocci.co.za)		
nra.co.za	Transferred	23/09/2015 15:29
BC: waltjo@nra.co.za(waltjo@nra.co.za)	Delivered	23/09/2015 15:31
orientis.co.za	Transferred	23/09/2015 15:29
BC: straussd@orientis.co.za(straussd@orientis.co.za)	Delivered	23/09/2015 15:30
POBOX 1, DURBAN	Delivered	23/09/2015 15:29
To: Rohaida Abed RAbed@csir.co.za)	Read	23/09/2015 15:29
POBOX 1, STELLBOS	Delivered	23/09/2015 15:29
BC: Surina Laurie@csir.co.za)	Third-Party Downloaded Read	23/09/2015 15:29 23/09/2015 15:29
sanbi.org.za	Transferred	23/09/2015 15:29
BC: lntboio@sanbi.org.za(lntboio@sanbi.org.za)	Undeliverable	23/09/2015 15:32
scatecsolar.com	Transferred	23/09/2015 15:29
BC: mitchell.hodgson@scatecsolar.com(mitchell.hodgson@scatecsolar.com)		
siyanda.gov.za	Transferred	23/09/2015 15:29
BC: sb@siyanda.gov.za(sb@siyanda.gov.za)	Undeliverable	28/09/2015 15:49
ska.ac.za	Transferred	23/09/2015 15:29
BC: atplady@ska.ac.za(atplady@ska.ac.za)	Delivered	23/09/2015 15:31
transnet.net	Transferred	23/09/2015 15:29
BC: Olive.Stephenson@transnet.net(Olive.Stephenson@transnet.net)	Delivered	23/09/2015 15:32
transnet.net	Transferred	23/09/2015 15:29
BC: Gilbert.Nortier@transnet.net(Gilbert.Nortier@transnet.net)	Delivered	23/09/2015 15:32
BC: Marina.Lourens@transnet.net(Marina.Lourens@transnet.net)	Delivered	23/09/2015 15:32
BC: Mayvyn.Bhana@transnet.net(Mayvyn.Bhana@transnet.net)	Delivered	23/09/2015 15:32
tpw.ncape.gov.za	Transferred	23/09/2015 15:29
BC: Klawrence@tpw.ncape.gov.za(Klawrence@tpw.ncape.gov.za)	Undeliverable	23/09/2015 15:31
veroniva.co.za	Transferred	23/09/2015 15:29
BC: Claude.Bosman@cloude@veroniva.co.za)	Delivered	23/09/2015 15:31
vodamail.co.za	Transferred	23/09/2015 15:29
BC: teresascheepers@vodamail.co.za(teresascheepers@vodamail.co.za)	Delivered	23/09/2015 15:42 2.0.0 recipients expanded
webmail.co.za	Transferred	23/09/2015 15:29
BC: hjs@webmail.co.za(hjs@webmail.co.za)	Transferred	23/09/2015 16:09 2.0.0 message relayed
worldonline.co.za	Transferred	23/09/2015 15:29
BC: ncagric@worldonline.co.za(ncagric@worldonline.co.za)	Delivered	23/09/2015 15:30
yahoo.com	Transferred	23/09/2015 15:29
BC: boozahunter@yahoo.com(boozahunter@yahoo.com)	Delivered	23/09/2015 15:32

Post Offices

Scoping and Environmental Impact Assessment for the proposed Development of a 75 MW Solar Photovoltaic Facility (KENHARDT PV 1) on the remaining extent of Onder Rugzeer Farm 168, north-east of Kenhardt, Northern Cape Province

Post Office	Delivered	Route
agri.ncape.gov.za		agri.ncape.gov.za
agric.co.za		agric.co.za
ahedstrading.co.za		ahedstrading.co.za
birdlife.org.za		birdlife.org.za
boodr.gov.za		boodr.gov.za
caa.co.za		caa.co.za
daff.gov.za		daff.gov.za
donco.co.za		donco.co.za
dwa.gov.za		dwa.gov.za
dws.gov.za		dws.gov.za
environment.gov.za		environment.gov.za
eskom.co.za		eskom.co.za
ewf.org.za		ewf.org.za
gmail.com		gmail.com
grasslands.org.za		grasslands.org.za
kgarib.gov.za		kgarib.gov.za
L2B.co.za		L2B.co.za
labour.gov.za		labour.gov.za
mullio.com		mullio.com
mweb.co.za		mweb.co.za
ncpg.gov.za		ncpg.gov.za
nda.agric.za		nda.agric.za
nersa.org.za		nersa.org.za
nocd.co.za		nocd.co.za
nra.co.za		nra.co.za
orientis.co.za		orientis.co.za
POBOX1 DURBAN	23/09/2015 15:29	csir.co.za
POBOX1 STELLENBOS	23/09/2015 15:29	csir.co.za
sarbi.org.za		sarbi.org.za
scatecsolar.com		scatecsolar.com
siyanda.gov.za		siyanda.gov.za
ska.ac.za		ska.ac.za
transnet.net		transnet.net
transnet.net		transnet.net
trpw.ncape.gov.za		trpw.ncape.gov.za
veroniva.co.za		veroniva.co.za
vodamail.co.za		vodamail.co.za
webmail.co.za		webmail.co.za
worldonline.co.za		worldonline.co.za
yahoo.com		yahoo.com

File	Size	Date & Time
Comment and Response Form_Scaterc Solar_NC.pdf	86616	22/09/2015 11:15
CSIR Letter 2 to I&APs_Scaterc Solar NC.pdf	138555	22/09/2015 11:55
MESSAGE	5572	23/09/2015 15:29
Scaterc Solar PV1_SR_SUMMARY.pdf	191656	21/09/2015 11:42
Scaterc Solar PV2_SR_SUMMARY.pdf	191331	21/09/2015 11:39
Scaterc Solar PV3_SR_SUMMARY.pdf	191451	21/09/2015 11:35
TEXT.htm	12478	23/09/2015 15:28

Options	
Auto Delete:	No
Concatenated Subject:	No
Expiration Date:	None
Notify Recipients:	Yes
Priority:	Standard
Reply requested by Security:	None
To Be Delivered:	Standard
	Immediate

Record Id	
Record Id:	56020530.DURBAN.POBOX1.100.1395037.1.CE85.1
Common Record Id:	56020530.DURBAN.POBOX1.200.2000083.1.327F4.1

Message Id: 5602B75B.65A : 179 : 65115
Subject: Release of Scoping Reports - Solar PV Facilities and Associated Electrical Infrastructure, Northern Cape
Created By: RAbed@csir.co.za
Scheduled Date:
Creation Date: 23/09/2015 16:29
From: Rohaida Abed

Recipients:

Recipient	Action	Date & Time	Comment
 agrink.co.za	Transferred	23/09/2015 16:30	
To: onhvango@agrnk.co.za;onhvango@agrnk.co.za)	Delivered	23/09/2015 16:31	

Post Offices

Post Office	Delivered	Route
agrnk.co.za		agrnk.co.za

Files



File	Size	Date & Time
Comment and Response Form_Scatec Solar_NC.pdf	66615	23/09/2015 11:15
CSIR Letter 2 to I&APs_Scatec Solar NC.pdf	136666	23/09/2015 11:55
MESSAGE	3572	23/09/2015 16:29
Scatec Solar PV1_SR_SUMMARY.pdf	191656	21/09/2015 11:42
Scatec Solar PV2_SR_SUMMARY.pdf	191331	21/09/2015 11:39
Scatec Solar PV3_SR_SUMMARY.pdf	191451	21/09/2015 11:36
TEXT.htm	12452	23/09/2015 16:29



Options
Auto Delete: No
Concealed Subject: No
Expiration Date: None
Notify Recipients: Yes
Priority: Standard
Reply requested by Security: None
To Be Delivered: Immediate

Record Id
Record Id: 5602D37B.DURBAN.POB0X1.100.1366D37.1.CE95.1
Common Record Id: 5602D37B.DURBAN.POB0X1.200.20000B3.1.3266D.1

Scoping and Environmental Impact Assessment for the proposed Development of a 75 MW Solar Photovoltaic Facility (KENHARDT PV 1) on the remaining extent of Onder Rugzeer Farm 168, north-east of Kenhardt, Northern Cape Province

Proof of Correspondence with I&APs (Courier Waybills and Receipt of Hard Copy and/or CD copy of the Scoping Report, Letter 2, Comment and Registration Form and Executive Summary)

		Head Office: Johannesburg 0961 388 863 Branches: Bloemfontein East London Polokwane Brisa George Port Elizabeth Cape Town Nelspruit Pretoria Durban Pietermaritzburg Richards Bay www.globeflight.com Reg. No. 1998/009052/07/ VAT NO. 4650175351				2714273926	
DATE	ACCOUNT NUMBER	TOUR NUMBER	SHIPPER'S REFERENCE	ORIGIN	DESTINATION	NO. OF PIECES	ACTUAL WEIGHT
30-09-2015	P01521		ems0102/RW 04100/04010			1	
SHIPPER (YOUR NAME)			TO (RECIPIENT'S NAME)				
S. Laurie			Mmatlala Rabothatha				
COMPANY NAME			COMPANY NAME				
CSIR - STELLENBOSCH			Nat Dept of Env Affairs; Integrated Environmental				
STREET ADDRESS			STREET ADDRESS				
JAN CILLIERS STR			Authorisations - Environmental House;				
CITY			CITY				
STELLENBOSCH			473 Steve Biko Rd; Arcadia				
CPT			CPT				
RSA			S.A.				
POST/ZIP CODE			POST/ZIP CODE				
7599			0001				
TELEPHONE NUMBER & E-MAIL			TELEPHONE NUMBER & E-MAIL				
021 888 2400			012 - 399 9372				
GLOBAL DOCUMENT EXPRESS		OVERNIGHT EXPRESS		SAME DAY			
<input type="checkbox"/>		<input checked="" type="checkbox"/>		<input type="checkbox"/>			
GLOBAL PARCEL EXPRESS		IN CITY DELIVERY		DAWN DELIVERY BY 09H00			
<input type="checkbox"/>		<input type="checkbox"/>		<input type="checkbox"/>			
GLOBAL MAIL		BUDGET CARGO 24-48 HRS		SATURDAY DELIVERY			
<input type="checkbox"/>		<input type="checkbox"/>		<input type="checkbox"/>			
AIRFREIGHT		ROAD FREIGHT 48-96 HRS		AFTER HOURS			
<input type="checkbox"/>		<input type="checkbox"/>		<input type="checkbox"/>			
CROSS BORDER ROAD FREIGHT		RECEIVED IN GOOD ORDER AND CONDITION					
<input type="checkbox"/>		PRINT NAME: A Taylor					
CUSTOMS VALUE		WE HAVE SEEN AND AGREE TO THE STANDARD CONDITIONS OF CARRIAGE OF GLOBEFLIGHT WORLDWIDE EXPRESS		RECEIVED BY GLOBEFLIGHT WORLDWIDE EXPRESS		RECEIVED IN GOOD ORDER AND CONDITION	
		PRINT NAME: A Taylor		PRINT NAME: A Taylor		PRINT NAME: A Taylor	
HAZARDOUS CARGO? YES NO		SIGNATURE: A Taylor		SIGNATURE: A Taylor		CONSIGNEE SIGNATURE:	
INSURANCE YES NO		DATE: _____ TIME: _____		DATE: _____ TIME: _____		DATE: _____ TIME: _____	
AMOUNT: _____		TOP COPY - P.O.D.; 2ND COPY - CONSIGNEE; 3RD COPY - ACCOUNTS; BOTTOM COPY - SENDER COPY					

		Head Office: Johannesburg 0961 388 863 Branches: Bloemfontein East London Polokwane Brisa George Port Elizabeth Cape Town Nelspruit Pretoria Durban Pietermaritzburg Richards Bay www.globeflight.com Reg. No. 1998/009052/07/ VAT NO. 4650175351				2714273927	
DATE	ACCOUNT NUMBER	TOUR NUMBER	SHIPPER'S REFERENCE	ORIGIN	DESTINATION	NO. OF PIECES	ACTUAL WEIGHT
30-09-2015	P01521		ems0102/RW 04100/04010			1	
SHIPPER (YOUR NAME)			TO (RECIPIENT'S NAME)				
S. Laurie			Muhammed Essop				
COMPANY NAME			COMPANY NAME				
CSIR - STELLENBOSCH			Dept of Env Affairs; Integrated Environmental				
STREET ADDRESS			STREET ADDRESS				
JAN CILLIERS STR			Authorisations - Environmental House				
CITY			CITY				
STELLENBOSCH			473 Steve Biko Road; Arcadia				
CPT			CPT				
RSA			S.A.				
POST/ZIP CODE			POST/ZIP CODE				
7599			0001				
TELEPHONE NUMBER & E-MAIL			TELEPHONE NUMBER & E-MAIL				
021 888 2400			012 - 399 9300				
GLOBAL DOCUMENT EXPRESS		OVERNIGHT EXPRESS		SAME DAY			
<input type="checkbox"/>		<input checked="" type="checkbox"/>		<input type="checkbox"/>			
GLOBAL PARCEL EXPRESS		IN CITY DELIVERY		DAWN DELIVERY BY 09H00			
<input type="checkbox"/>		<input type="checkbox"/>		<input type="checkbox"/>			
GLOBAL MAIL		BUDGET CARGO 24-48 HRS		SATURDAY DELIVERY			
<input type="checkbox"/>		<input type="checkbox"/>		<input type="checkbox"/>			
AIRFREIGHT		ROAD FREIGHT 48-96 HRS		AFTER HOURS			
<input type="checkbox"/>		<input type="checkbox"/>		<input type="checkbox"/>			
CROSS BORDER ROAD FREIGHT		RECEIVED IN GOOD ORDER AND CONDITION					
<input type="checkbox"/>		PRINT NAME: A Taylor					
CUSTOMS VALUE		WE HAVE SEEN AND AGREE TO THE STANDARD CONDITIONS OF CARRIAGE OF GLOBEFLIGHT WORLDWIDE EXPRESS		RECEIVED BY GLOBEFLIGHT WORLDWIDE EXPRESS		RECEIVED IN GOOD ORDER AND CONDITION	
		PRINT NAME: A Taylor		PRINT NAME: A Taylor		PRINT NAME: A Taylor	
HAZARDOUS CARGO? YES NO		SIGNATURE: A Taylor		SIGNATURE: A Taylor		CONSIGNEE SIGNATURE:	
INSURANCE YES NO		DATE: _____ TIME: _____		DATE: _____ TIME: _____		DATE: _____ TIME: _____	
AMOUNT: _____		TOP COPY - P.O.D.; 2ND COPY - CONSIGNEE; 3RD COPY - ACCOUNTS; BOTTOM COPY - SENDER COPY					

Scoping and Environmental Impact Assessment for the proposed Development of a 75 MW Solar Photovoltaic Facility (KENHARDT PV 1) on the remaining extent of Onder Rugzeer Farm 168, north-east of Kenhardt, Northern Cape Province

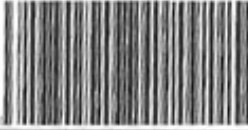
		Head Office: Johannesburg 0861 388 883 Branches: <table border="0"> <tr> <td>Bloemfontein</td> <td>East London</td> <td>Pretoria</td> </tr> <tr> <td>Bits</td> <td>George</td> <td>Port Elizabeth</td> </tr> <tr> <td>Cape Town</td> <td>Nelspruit</td> <td>Richards Bay</td> </tr> <tr> <td>Durban</td> <td>Pietermaritzburg</td> <td></td> </tr> </table> www.globeflight.com Reg. No. 1958/009052/07/ VAT NO. 4650175351		Bloemfontein	East London	Pretoria	Bits	George	Port Elizabeth	Cape Town	Nelspruit	Richards Bay	Durban	Pietermaritzburg				2714273928	
Bloemfontein	East London	Pretoria																	
Bits	George	Port Elizabeth																	
Cape Town	Nelspruit	Richards Bay																	
Durban	Pietermaritzburg																		
DATE	ACCOUNT NUMBER	LOGO/CARTAS	SHIPPER'S REFERENCE	ORIGIN	DESTINATION	NO. OF PIECES													
30-09-2015	P01521		ems0102/rw 0910010k610			1													
SHIPPER (YOUR NAME) S. Laurie		TO (RECIPIENT'S NAME) A. Yaphi																	
COMPANY NAME CSIR - STELLENBOSCH		COMPANY NAME Prov Dept of Environment + Nature Conservation																	
STREET ADDRESS JAN CILLIERS STR		STREET ADDRESS Northern Cape; Sasko Building																	
CITY STELLENBOSCH		CITY Kimberley																	
CPT																			
COUNTRY RSA	POST/ZIP CODE 7599	COUNTRY S.A.	POST/ZIP CODE 8301																
TELEPHONE NUMBER & E-MAIL 021 888 2400		TELEPHONE NUMBER & E-MAIL 053 - 807 7430																	
<input type="checkbox"/> GLOBAL DOCUMENT EXPRESS <input type="checkbox"/> GLOBAL PARCELEXPRESS <input type="checkbox"/> GLOBAL MAIL AIRFREIGHT <input type="checkbox"/> CROSS BORDER ROAD FREIGHT CUSTOMS VALUE		<input checked="" type="checkbox"/> OVERNIGHT EXPRESS <input type="checkbox"/> IN CITY DELIVERY <input type="checkbox"/> BUDGET CARGO 24-48 HRS <input type="checkbox"/> ROAD FREIGHT 48-96 HRS		<input type="checkbox"/> SAME DAY <input type="checkbox"/> DAWN DELIVERY BY 09H00 <input type="checkbox"/> SATURDAY DELIVERY AFTER HOURS															
HAZARDOUS CARGO? YES NO		RECEIVED BY GLOBEFLIGHT WORLDWIDE EXPRESS PRINT NAME A Taylor		RECEIVED IN GOOD ORDER AND CONDITION PRINT NAME															
INSURANCE YES NO		SIGNATURE Taylor		CONSIGNEE SIGNATURE															
AMOUNT		DATE		DATE															
TOP COPY - P.O.D.; 2ND COPY - CONSIGNEE; 3RD COPY - ACCOUNTS; BOTTOM COPY - SENDER COPY																			

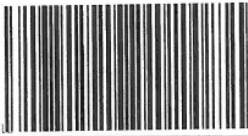

		Head Office: Johannesburg 0861 388 883 Branches: <table border="0"> <tr> <td>Bloemfontein</td> <td>East London</td> <td>Pretoria</td> </tr> <tr> <td>Bits</td> <td>George</td> <td>Port Elizabeth</td> </tr> <tr> <td>Cape Town</td> <td>Nelspruit</td> <td>Richards Bay</td> </tr> <tr> <td>Durban</td> <td>Pietermaritzburg</td> <td></td> </tr> </table> www.globeflight.com Reg. No. 1958/009052/07/ VAT NO. 4650175351		Bloemfontein	East London	Pretoria	Bits	George	Port Elizabeth	Cape Town	Nelspruit	Richards Bay	Durban	Pietermaritzburg				2714273929	
Bloemfontein	East London	Pretoria																	
Bits	George	Port Elizabeth																	
Cape Town	Nelspruit	Richards Bay																	
Durban	Pietermaritzburg																		
DATE	ACCOUNT NUMBER	LOGO/CARTAS	SHIPPER'S REFERENCE	ORIGIN	DESTINATION	NO. OF PIECES													
30-09-2015	P01521		ems0102/rw 0910010k610			1													
SHIPPER (YOUR NAME) S. Laurie		TO (RECIPIENT'S NAME) Melinda Mei																	
COMPANY NAME CSIR - STELLENBOSCH		COMPANY NAME Dept of Water + Sanitation																	
STREET ADDRESS JAN CILLIERS STR		STREET ADDRESS Louisvale Road																	
CITY STELLENBOSCH		CITY Upington																	
CPT																			
COUNTRY RSA	POST/ZIP CODE 7599	COUNTRY S.A.	POST/ZIP CODE 8801																
TELEPHONE NUMBER & E-MAIL 021 888 2400		TELEPHONE NUMBER & E-MAIL 054 - 338 5836																	
<input type="checkbox"/> GLOBAL DOCUMENT EXPRESS <input type="checkbox"/> GLOBAL PARCELEXPRESS <input type="checkbox"/> GLOBAL MAIL AIRFREIGHT <input type="checkbox"/> CROSS BORDER ROAD FREIGHT CUSTOMS VALUE		<input checked="" type="checkbox"/> OVERNIGHT EXPRESS <input type="checkbox"/> IN CITY DELIVERY <input type="checkbox"/> BUDGET CARGO 24-48 HRS <input type="checkbox"/> ROAD FREIGHT 48-96 HRS		<input type="checkbox"/> SAME DAY <input type="checkbox"/> DAWN DELIVERY BY 09H00 <input type="checkbox"/> SATURDAY DELIVERY AFTER HOURS															
HAZARDOUS CARGO? YES NO		RECEIVED BY GLOBEFLIGHT WORLDWIDE EXPRESS PRINT NAME A Taylor		RECEIVED IN GOOD ORDER AND CONDITION PRINT NAME															
INSURANCE YES NO		SIGNATURE Taylor		CONSIGNEE SIGNATURE															
AMOUNT		DATE		DATE															
TOP COPY - P.O.D.; 2ND COPY - CONSIGNEE; 3RD COPY - ACCOUNTS; BOTTOM COPY - SENDER COPY																			

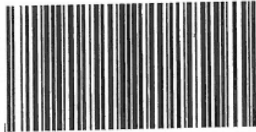

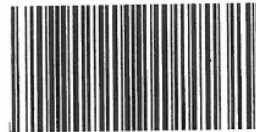
Scoping and Environmental Impact Assessment for the proposed Development of a 75 MW Solar Photovoltaic Facility (KENHARDT PV 1) on the remaining extent of Onder Rugzeer Farm 168, north-east of Kenhardt, Northern Cape Province

		Head Office: Johannesburg 0861 388 888 Branches: Bloemfontein East London Polokwane Brits George Port Elizabeth Cape Town Nelspruit Pretoria Durban Pietermaritzburg Richards Bay www.globoflight.com Reg. No. 1998/009052/07/ VAT NO. 4650175351				2714273930	
DATE	ACCOUNT NUMBER	POST OFFICE	SHIPPER'S REFERENCE	ORIGIN	DESTINATION	ACTUAL WEIGHT	
30-09-2015	P01521		emsoioz/RW 0410010610			1	
SHIPPER (YOUR NAME)			TO (RECIPIENT'S NAME)				
S. Laurie			Jacoline Mans				
COMPANY NAME			COMPANY NAME				
CSIR - STELLENBOSCH			Chief Forester, NFA Regulation				
STREET ADDRESS			STREET ADDRESS				
JAN CILLIERS STR			Dept of Agriculture, Forestry + Fisheries				
CITY			CITY				
STELLENBOSCH			Louisvale Road				
CPT			Upington				
COUNTRY		POST/ZIP CODE	COUNTRY		POST/ZIP CODE		
RSA		7599	S. A.		8801		
TELEPHONE NUMBER & E-MAIL			TELEPHONE NUMBER & E-MAIL				
021 888 2400			054-338 5860				
GLOBAL DOCUMENT EXPRESS		OVERNIGHT EXPRESS		SAME DAY			
<input type="checkbox"/>		<input checked="" type="checkbox"/>		<input type="checkbox"/>			
GLOBAL PARCEL EXPRESS		IN CITY DELIVERY		DAWN DELIVERY BY 09H00			
<input type="checkbox"/>		<input type="checkbox"/>		<input type="checkbox"/>			
GLOBAL MAIL		BUDGET CARGO 24-48 HRS		SATURDAY DELIVERY			
<input type="checkbox"/>		<input type="checkbox"/>		<input type="checkbox"/>			
AIRFREIGHT		ROAD FREIGHT 48-96 HRS		AFTER HOURS			
<input type="checkbox"/>		<input type="checkbox"/>		<input type="checkbox"/>			
CROSS BORDER ROAD FREIGHT		RECEIVED IN GOOD ORDER AND CONDITION					
CUSTOMS VALUE		WE HAVE SEEN AND AGREE TO THE STANDARD CONDITIONS OF CARRIAGE OF GLOBEFLIGHT WORLDWIDE EXPRESS		RECEIVED BY GLOBEFLIGHT WORLDWIDE EXPRESS		PRINT NAME:	
		PRINT NAME: A TAYLOR		SIGNATURE: <i>A Taylor</i>		CONSIGNEE SIGNATURE:	
HAZARDOUS CARGO? YES NO		SIGNATURE: <i>A Taylor</i>		DATE: _____ TIME: _____		DATE: _____ TIME: _____	
INSURANCE YES NO		DATE: _____ TIME: _____		DATE: _____ TIME: _____		DATE: _____ TIME: _____	
AMOUNT:		TOP COPY - P.O.D.; 2ND COPY - CONSIGNEE; 3RD COPY - ACCOUNTS; BOTTOM COPY - SENDER COPY					
		Documents					



		Head Office: Johannesburg 0861 388 888 Branches: Bloemfontein East London Polokwane Brits George Port Elizabeth Cape Town Nelspruit Pretoria Durban Pietermaritzburg Richards Bay www.globoflight.com Reg. No. 1998/009052/07/ VAT NO. 4650175351				2714273931	
DATE	ACCOUNT NUMBER	POST OFFICE	SHIPPER'S REFERENCE	ORIGIN	DESTINATION	ACTUAL WEIGHT	
30/09/2015	P01521		emsoioz/RW 0410010610			1	
SHIPPER (YOUR NAME)			TO (RECIPIENT'S NAME)				
S. Laurie			Justine Wyngaardt				
COMPANY NAME			COMPANY NAME				
CSIR - STELLENBOSCH			Eskom Holdings Ltd; Eskom Distribution				
STREET ADDRESS			STREET ADDRESS				
JAN CILLIERS STR			Western Operating Unit				
CITY			CITY				
STELLENBOSCH			Eskom Road				
CPT			Brackenfell				
COUNTRY		POST/ZIP CODE	COUNTRY		POST/ZIP CODE		
RSA		7599	S. A.		7561		
TELEPHONE NUMBER & E-MAIL			TELEPHONE NUMBER & E-MAIL				
021 888 2400			021-980 3112				
GLOBAL DOCUMENT EXPRESS		OVERNIGHT EXPRESS		SAME DAY			
<input type="checkbox"/>		<input checked="" type="checkbox"/>		<input type="checkbox"/>			
GLOBAL PARCEL EXPRESS		IN CITY DELIVERY		DAWN DELIVERY BY 09H00			
<input type="checkbox"/>		<input type="checkbox"/>		<input type="checkbox"/>			
GLOBAL MAIL		BUDGET CARGO 24-48 HRS		SATURDAY DELIVERY			
<input type="checkbox"/>		<input type="checkbox"/>		<input type="checkbox"/>			
AIRFREIGHT		ROAD FREIGHT 48-96 HRS		AFTER HOURS			
<input type="checkbox"/>		<input type="checkbox"/>		<input type="checkbox"/>			
CROSS BORDER ROAD FREIGHT		RECEIVED IN GOOD ORDER AND CONDITION					
CUSTOMS VALUE		WE HAVE SEEN AND AGREE TO THE STANDARD CONDITIONS OF CARRIAGE OF GLOBEFLIGHT WORLDWIDE EXPRESS		RECEIVED BY GLOBEFLIGHT WORLDWIDE EXPRESS		PRINT NAME:	
		PRINT NAME: A TAYLOR		SIGNATURE: <i>A Taylor</i>		CONSIGNEE SIGNATURE:	
HAZARDOUS CARGO? YES NO		SIGNATURE: <i>A Taylor</i>		DATE: _____ TIME: _____		DATE: _____ TIME: _____	
INSURANCE YES NO		DATE: _____ TIME: _____		DATE: _____ TIME: _____		DATE: _____ TIME: _____	
AMOUNT:		TOP COPY - P.O.D.; 2ND COPY - CONSIGNEE; 3RD COPY - ACCOUNTS; BOTTOM COPY - SENDER COPY					
		Documents					



Scoping and Environmental Impact Assessment for the proposed Development of a 75 MW Solar Photovoltaic Facility (KENHARDT PV 1) on the remaining extent of Onder Rugzeer Farm 168, north-east of Kenhardt, Northern Cape Province

		Head Office: Johannesburg 0861 388 883 Branches: Bloemfontein East London Polokwane Brits George Port Elizabeth Cape Town Nelspruit Pretoria Durban Pietermaritzburg Richards Bay www.globeflight.com Reg. No. 1998/009052/07/ VAT NO. 4850175351				2714273932	
DATE	ACCOUNT NUMBER	SHIPPER'S REFERENCE	ORIGIN	DESTINATION	No. OF PIECES		ACTUAL WEIGHT
30/09/2015	P01521	ems0102/rw 0410010K610			1		
SHIPPER (YOUR NAME) S. Laurie			TO (RECIPIENT'S NAME) Adrian Tiplady				
COMPANY NAME CSIR - STELLENBOSCH			COMPANY NAME SKA - SA - Head: Strategy				
STREET ADDRESS JAN CILLIERS STR			STREET ADDRESS 17 Baker Street				
CITY STELLENBOSCH			CITY Rosebank				
COUNTRY RSA		POST/ZIP CODE 7599	COUNTRY S.A.		POST/ZIP CODE 2196		
TELEPHONE NUMBER & E-MAIL 021 888 2400			TELEPHONE NUMBER & E-MAIL 011-442 2434				
GLOBAL DOCUMENT EXPRESS		OVERNIGHT EXPRESS	IN CITY DELIVERY		SAME DAY		
GLOBAL PARCEL EXPRESS			BUDGET CARGO 24-48 HRS		DAWN DELIVERY BY 09H00		
GLOBAL MAIL			ROAD FREIGHT 48-96 HRS		SATURDAY DELIVERY		
AIRFREIGHT			ROAD FREIGHT 48-96 HRS		AFTER HOURS		
CROSS BORDER ROAD FREIGHT		CUSTOMS VALUE		RECEIVED BY GLOBEFLIGHT WORLDWIDE EXPRESS			
HAZARDOUS CARGO? YES NO		SIGNATURE A Taylor		SIGNATURE		RECEIVED IN GOOD ORDER AND CONDITION	
INSURANCE YES NO		DATE 30/09/2015		DATE		PRINT NAME	
AMOUNT:						CONSIGNEE SIGNATURE	
						DATE	
						TIME	
						TIME	
TOP COPY - P.O.D.; 2ND COPY - CONSIGNEE; 3RD COPY - ACCOUNTS; BOTTOM COPY - SENDER COPY							

		Head Office: Johannesburg 0861 388 883 Branches: Bloemfontein East London Polokwane Brits George Port Elizabeth Cape Town Nelspruit Pretoria Durban Pietermaritzburg Richards Bay www.globeflight.com Reg. No. 1998/009052/07/ VAT NO. 4850175351				2714273933	
DATE	ACCOUNT NUMBER	SHIPPER'S REFERENCE	ORIGIN	DESTINATION	No. OF PIECES		ACTUAL WEIGHT
30/09/2015	P01521	ems0102/rw 0410010K610			1		
SHIPPER (YOUR NAME) S. Laurie			TO (RECIPIENT'S NAME) Konell van Rooi				
COMPANY NAME CSIR - STELLENBOSCH			COMPANY NAME Groblershoop Library				
STREET ADDRESS JAN CILLIERS STR			STREET ADDRESS 97 Oranje Street				
CITY STELLENBOSCH			CITY Groblershoop				
COUNTRY RSA		POST/ZIP CODE 7599	COUNTRY S.A.		POST/ZIP CODE 8850		
TELEPHONE NUMBER & E-MAIL 021 888 2400			TELEPHONE NUMBER & E-MAIL 054 - 833 0075				
GLOBAL DOCUMENT EXPRESS		OVERNIGHT EXPRESS	IN CITY DELIVERY		SAME DAY		
GLOBAL PARCEL EXPRESS			BUDGET CARGO 24-48 HRS		DAWN DELIVERY BY 09H00		
GLOBAL MAIL			ROAD FREIGHT 48-96 HRS		SATURDAY DELIVERY		
AIRFREIGHT			ROAD FREIGHT 48-96 HRS		AFTER HOURS		
CROSS BORDER ROAD FREIGHT		CUSTOMS VALUE		RECEIVED BY GLOBEFLIGHT WORLDWIDE EXPRESS			
HAZARDOUS CARGO? YES NO		SIGNATURE A Taylor		SIGNATURE		RECEIVED IN GOOD ORDER AND CONDITION	
INSURANCE YES NO		DATE 30/09/2015		DATE		PRINT NAME	
AMOUNT:						CONSIGNEE SIGNATURE	
						DATE	
						TIME	
						TIME	
TOP COPY - P.O.D.; 2ND COPY - CONSIGNEE; 3RD COPY - ACCOUNTS; BOTTOM COPY - SENDER COPY							

Scoping and Environmental Impact Assessment for the proposed Development of a 75 MW Solar Photovoltaic Facility (KENHARDT PV 1) on the remaining extent of Onder Rugzeer Farm 168, north-east of Kenhardt, Northern Cape Province

		Head Office: Johannesburg 0861 388 883 Branches: Bloemfontein East London Polokwane Brits George Port Elizabeth Cape Town Nelspruit Pretoria Durban Pietermaritzburg Richards Bay www.globeflight.com Reg. No. 1998/008032/07/ VAT NO: 4650175351				2714273934	
DATE	ACCOUNT NUMBER	COSY CODE	SHIPPER'S REFERENCE	ORIGIN	DESTINATION	QUANTITY OF PIECES	ADDITIONAL INFO
30/09/2015	P01521		ems0102/RUN 0410010KGI0			1	
SHIPPER (YOUR NAME)			TO (RECIPIENT'S NAME)				
S. Lawrie			Geene Einam				
COMPANY NAME			COMPANY NAME				
CSIR - STELLENBOSCH			Kenhardt Library				
STREET ADDRESS			STREET ADDRESS				
JAN CILLIERS STR			Park Street				
CITY			CITY				
STELLENBOSCH			Kenhardt				
CPT COUNTRY		POST/ZIP CODE	COUNTRY		POST/ZIP CODE		
RSA		7599	S.A.		8900		
TELEPHONE NUMBER & E-MAIL			TELEPHONE NUMBER & E-MAIL				
			054 - 431 6300				
021 888 2400		OVERNIGHT EXPRESS		SAME DAY			
<input type="checkbox"/>		<input checked="" type="checkbox"/>		<input type="checkbox"/>			
GLOBAL DOCUMENT EXPRESS		IN CITY DELIVERY		DAWN DELIVERY BY 09H00			
<input type="checkbox"/>		<input type="checkbox"/>		<input type="checkbox"/>			
GLOBAL PARCEL EXPRESS		BUDGET CARGO 24-48 HRS		SATURDAY DELIVERY			
<input type="checkbox"/>		<input type="checkbox"/>		<input type="checkbox"/>			
GLOBAL MAIL		ROAD FREIGHT 48-96 HRS		AFTER HOURS			
<input type="checkbox"/>		<input type="checkbox"/>		<input type="checkbox"/>			
AIRFREIGHT		CROSS BORDER ROAD FREIGHT					
<input type="checkbox"/>		<input type="checkbox"/>					
CUSTOMS VALUE		WE HAVE SEEN AND AGREE TO THE STANDARD CONDITIONS OF CARRIAGE OF GLOBEFLIGHT WORLDWIDE EXPRESS		RECEIVED BY GLOBEFLIGHT WORLDWIDE EXPRESS		RECEIVED IN GOOD ORDER AND CONDITION	
		PRINT NAME: A Taylor		PRINT NAME:		PRINT NAME:	
HAZARDOUS CARGO?		SIGNATURE		SIGNATURE		CONSIGNEE SIGNATURE	
YES <input type="checkbox"/> NO <input type="checkbox"/>		A Taylor					
INSURANCE		DATE		DATE		DATE	
YES <input type="checkbox"/> NO <input type="checkbox"/>		30/09/2015					
AMOUNT:		DATE		TIME		DATE	
TOP COPY - P.O.D.; 2ND COPY - CONSIGNEE; 3RD COPY - ACCOUNTS; BOTTOM COPY - SENDER COPY							

		Head Office: Johannesburg 0861 388 883 Branches: Bloemfontein East London Polokwane Brits George Port Elizabeth Cape Town Nelspruit Pretoria Durban Pietermaritzburg Richards Bay www.globeflight.com Reg. No. 1998/008032/07/ VAT NO: 4650175351				2714273925	
DATE	ACCOUNT NUMBER	COSY CODE	SHIPPER'S REFERENCE	ORIGIN	DESTINATION	QUANTITY OF PIECES	ADDITIONAL INFO
1 Oct 2015	P01521		ems0102/RUN 0410010KGI0			1	
SHIPPER (YOUR NAME)			TO (RECIPIENT'S NAME)				
Rohaida Abed			Directorate: Biodiversity + Conservation				
COMPANY NAME			COMPANY NAME				
CSIR - STELLENBOSCH			National Dept of Environmental Affairs				
STREET ADDRESS			STREET ADDRESS				
JAN CILLIERS STR			Environment House				
CITY			CITY				
STELLENBOSCH			473 Steve Biko Road				
CPT COUNTRY		POST/ZIP CODE	COUNTRY		POST/ZIP CODE		
RSA		7599	S.A.		0001		
TELEPHONE NUMBER & E-MAIL			TELEPHONE NUMBER & E-MAIL				
			012-399 9515 / 399 9000				
021 888 2400		OVERNIGHT EXPRESS		SAME DAY			
<input type="checkbox"/>		<input checked="" type="checkbox"/>		<input type="checkbox"/>			
GLOBAL DOCUMENT EXPRESS		IN CITY DELIVERY		DAWN DELIVERY BY 09H00			
<input type="checkbox"/>		<input type="checkbox"/>		<input type="checkbox"/>			
GLOBAL PARCEL EXPRESS		BUDGET CARGO 24-48 HRS		SATURDAY DELIVERY			
<input type="checkbox"/>		<input type="checkbox"/>		<input type="checkbox"/>			
GLOBAL MAIL		ROAD FREIGHT 48-96 HRS		AFTER HOURS			
<input type="checkbox"/>		<input type="checkbox"/>		<input type="checkbox"/>			
AIRFREIGHT		CROSS BORDER ROAD FREIGHT					
<input type="checkbox"/>		<input type="checkbox"/>					
CUSTOMS VALUE		WE HAVE SEEN AND AGREE TO THE STANDARD CONDITIONS OF CARRIAGE OF GLOBEFLIGHT WORLDWIDE EXPRESS		RECEIVED BY GLOBEFLIGHT WORLDWIDE EXPRESS		RECEIVED IN GOOD ORDER AND CONDITION	
		PRINT NAME: A Taylor		PRINT NAME:		PRINT NAME:	
HAZARDOUS CARGO?		SIGNATURE		SIGNATURE		CONSIGNEE SIGNATURE	
YES <input type="checkbox"/> NO <input type="checkbox"/>		A Taylor					
INSURANCE		DATE		DATE		DATE	
YES <input type="checkbox"/> NO <input type="checkbox"/>		1 Oct 2015					
AMOUNT:		DATE		TIME		DATE	
TOP COPY - P.O.D.; 2ND COPY - CONSIGNEE; 3RD COPY - ACCOUNTS; BOTTOM COPY - SENDER COPY							

Copies and Proof of Correspondence Sent to I&APs for the Release of the Addendum to the Scoping Report for I&AP Review (6 October 2015)

Email 3 sent to all I&APs on 6 October 2015

From: Rohaida Abed
To: Abed, Rohaida
BC Clive.Stephenson@transnet.net; CloeteS@dws.gov.za; GeerinJH@eskom.co.za; Gilbert.Nortier@transnet.net; HaarhL@eskom.co.za; JacolineMa@daff.gov.za; Laurie, Surina; LeaskK@eskom.co.za; MRabothata@environment.gov.za; Marina.Lourens@transnet.net; MashuduMa@daff.gov.za; Mayvyn.Bhana@transnet.net; MeiM@dwa.gov.za; MelanieM@L2B.co.za; ThokoB@daff.gov.za; WyngaaJO@eskom.co.za; aditeme@agri.ncape.gov.za; admin@grasslands.org.za; advocacy@birdlife.org.za; ameliastrauss2@gmail.com; andre.vanniekerk10@gmail.com; annelizac@nda.agric.za; atiplady@ska.ac.za; boozahunter@yahoo.com; claude@veroniva.co.za; ernest.connan@donco.co.za; fpr@bodr.gov.za; hendri@aheadtrading.co.za; jdbhenrohn@gmail.com; jhjs@webmail.co.za; karen@mulilo.com; klawrence@trpw.ncape.gov.za; kraines@mweb.co.za; l.ntsolo@sanbi.org.za; marcyroxnpc@gmail.com; messop@environment.gov.za; mitchell.hodgson@scatecsolar.com; mm@kaigarib.gov.za; mmathews@ncpg.gov.za; mndzilili@ncpg.gov.za; monica.lepheane@labour.gov.za; ncagric@worldonline.co.za; nhlakad@daff.gov.za; nyaphi@ncpg.gov.za; ontvangs@agrink.co.za; peter.buys@nersa.org.za; ratha.timothy@gmail.com; rwarie@ncpg.gov.za; sb@siyanda.gov.za; sdelafontaine@gmail.com; sharon@nocci.co.za; smbanjwa@ncpg.gov.za; straussdj@orientis.co.za; strohl@caa.co.za; teresascheepers@vodamail.co.za; townsendmorgan029@gmail.com; waltjc@nra.co.za; wep@ewt.org.za
Date: 06/10/2015 16:25
Subject: Release of Addendum to Scoping Reports - Solar PV Facilities and Associated Electrical Infrastructure, Northern Cape
Attachments: Scatec Solar PV1_DSR_Addendum_FINAL.pdf; Scatec Solar PV2_DSR_Addendum_FINAL.pdf; Scatec Solar PV3_DSR_Addendum_FINAL.pdf; Comment and Response Form_Scatec Solar_NC_FINAL.pdf

Dear Stakeholders and Interested and Affected Parties

NOTICE OF RELEASE OF AN ADDENDUM TO THE SCOPING REPORTS FOR THE PROPOSED DEVELOPMENT OF THREE SOLAR PHOTOVOLTAIC (PV) FACILITIES (REFERRED TO AS KENHARDT PV 1, KENHARDT PV 2, AND KENHARDT PV 3) ON THE REMAINING EXTENT OF ONDER RUGZEER FARM 168, NORTH-EAST OF KENHARDT, NORTHERN CAPE PROVINCE

Competent Authority: National Department of Environmental Affairs

CSIR REFERENCE: EMS0102/SCATEC/2015

This e-mail correspondence serves to inform you of the release of an Addendum to the Scoping Reports for the three proposed 75 Megawatt (MW) Solar Photovoltaic (PV) power generation facilities, located on the remaining extent of Onder Rugzeer Farm 168, approximately 80 km south of Upington and 30 km north-east of Kenhardt within the !Kheis Local Municipality, Northern Cape Province. The proposed 75 MW Solar PV projects are referred to as: Kenhardt PV 1, Kenhardt PV 2 and Kenhardt PV 3 respectively. The Project Applicant is Scatec Solar SA 330 (PTY) Ltd for Kenhardt PV 1, Scatec Solar SA 350 (PTY) Ltd for Kenhardt PV 2 and Scatec Solar SA 370 (PTY) Ltd for Kenhardt PV 3.

As you are aware, in terms of the National Environmental Management Act (Act 107 of 1998, as amended) (NEMA) and the 2014 NEMA Environmental Impact Assessment (EIA) Regulations promulgated in Government Gazette 38282 and Government Notice (GN) R982, R983, R984 and R985 on 8 December 2014, a full Scoping and EIA Process is required for the construction of the three Solar PV facilities. A separate Basic Assessment Process will be undertaken for the development of the proposed transmission lines, associated electrical infrastructure and connection to the Eskom Nieuwehoop Substation (which is currently being constructed) on the remaining extent of Portion 3 of Gemsbok Bult Farm 120. The CSIR has been appointed by the Project Applicant to undertake the separate requisite Basic Assessment, and Scoping and EIA Processes for the proposed projects.

As a registered Interested and Affected Party (I&AP) on the project database, you were notified on 23 September 2015 via email and registered mail of the release of the Scoping Reports for the Kenhardt PV 1, Kenhardt PV 2 and Kenhardt PV 3 projects for a 30-day review period, which extends from 25 September 2015 to 27 October 2015.

However, a pre-application meeting was held with the National Department of Environmental Affairs (DEA) on 17 September 2015 to discuss the proposed projects and requirements for the Basic Assessment, and Scoping and EIA Phases. The CSIR compiled notes of the pre-application meeting and submitted it to the DEA on 23 September 2015 for review and acceptance. Due to the fact that no significant issues were raised during the pre-application meeting that

was not addressed in the Scoping Reports for the proposed projects, the Scoping Reports were sent out for public comment for 30 days as noted above.

Subsequent to this, the DEA provided comments on the meeting notes and approval thereof via email on 1 October 2015. As part of the comments received on the meeting notes, the DEA recommended that specialist studies should be included with the Scoping Report, which needs to be site specific (in terms of the applicable alternatives that have been considered in the Scoping Phase). As such, the CSIR has compiled an addendum to the Scoping Report for the Kenhardt PV 1, Kenhardt PV 2 and Kenhardt PV 3 projects in order to provide the additional information, as per the DEA's request. It should be noted that the CSIR project team has undertaken the assessment of alternatives based on desktop literature, previous experience of working on Solar PV facilities and the specialist studies undertaken for the proposed Nieuwehoop Solar Development located adjacent to this proposed project.

It is important to note that the Addendums do not present any new information that has not been used in the compilation of the Scoping Reports but serves to provide the DEA and I&APs with a more detailed assessment of how the preferred site location was determined.

In line with the above, as a registered I&AP on the project database, you are hereby notified of the release of the Addendum to the Scoping Reports for the Kenhardt PV 1, Kenhardt PV 2 and Kenhardt PV 3 projects to all registered I&APs and stakeholders for a 30-day review period, which will extend from **6 October 2015 to 5 November 2015**.

Please find attached the following:

- Kenhardt PV 1 Addendum to the Scoping Report;
- Kenhardt PV 2 Addendum to the Scoping Report;
- Kenhardt PV 3 Addendum to the Scoping Report; and a
- Comment and Registration Form to facilitate the commenting process.

The above-mentioned project information can be accessed at the following website:
<http://www.csir.co.za/eia/ScatecSolarPV/>

Kindly ensure that all comments are submitted to the CSIR Project Manager (details provided below) by **5 November 2015**.

Thank you and kind regards,

Rohaida Abed
CSIR - Environmental Management Services
P. O. Box 17001, Congella, Durban, 4013
Tel: 031 242 2300
Fax: 031 261 2509
Email: RAbed@csir.co.za























Proof of Delivery of Email 3 sent to all I&APs on 6 October 2015

Message Id: 5613D9F7.AB3 : 179 : 65115
 Subject: Release of Addendum to Scoping Reports - Solar PV Facilities and Associated Electrical Infrastructure, Northern Cape
 Created By: RAbed@cafr.co.za
 Scheduled Date:
 Creation Date: 06/10/2015 16:25
 From: Rohalida Abed

Recipients:

Recipient	Action	Date & Time	Comment
agri.ncpe.gov.za	Transferred	06/10/2015 16:26	
BC: adileme@agri.ncpe.gov.za(adileme@agri.ncpe.gov.za)	Delivered	06/10/2015 16:27	
agrink.co.za	Transferred	06/10/2015 16:26	
BC: ontvangs@agrink.co.za(ontvangs@agrink.co.za)	Delivered	06/10/2015 16:42	
aheadtrading.co.za	Transferred	06/10/2015 16:26	
BC: hendri@aheadtrading.co.za(hendri@aheadtrading.co.za)	Delivered	06/10/2015 16:27	
birdlife.org.za	Transferred	06/10/2015 16:26	
BC: advocacy@birdlife.org.za(advocacy@birdlife.org.za)	Delivered	06/10/2015 16:27	
bodf.gov.za	Transferred	06/10/2015 16:26	
BC: fpr@bodf.gov.za(fpr@bodf.gov.za)	Undeliverable	06/10/2015 16:27	
caa.co.za	Transferred	06/10/2015 16:26	
BC: stroh@caa.co.za(stroh@caa.co.za)	Delivered	06/10/2015 16:29	
daff.gov.za	Transferred	06/10/2015 16:26	
BC: JacquelineMa@daff.gov.za(JacolineMa@daff.gov.za)	Delivered	06/10/2015 17:17	
BC: MashuduMa@daff.gov.za(MashuduMa@daff.gov.za)	Delivered	06/10/2015 17:17	
BC: nhlakad@daff.gov.za(nhlakad@daff.gov.za)	Delivered	06/10/2015 17:17	
BC: ThokoB@daff.gov.za(ThokoB@daff.gov.za)	Delivered	06/10/2015 17:17	
donco.co.za	Transferred	06/10/2015 16:26	
BC: ernest.connan@donco.co.za(ernest.connan@donco.co.za)	Delivered	06/10/2015 16:29	
dwa.gov.za	Transferred	06/10/2015 16:26	
BC: MeM@dwa.gov.za(MeM@dwa.gov.za)	Delivered	06/10/2015 16:27	
dws.gov.za	Transferred	06/10/2015 16:26	
BC: CloeteS@dws.gov.za(CloeteS@dws.gov.za)	Delivered	06/10/2015 16:27	
environment.gov.za	Transferred	06/10/2015 16:26	
BC: messop@environment.gov.za(messop@environment.gov.za)	Delivered	06/10/2015 16:27	
BC: MRabobhata@environment.gov.za(MRabobhata@environment.gov.za)	Delivered	06/10/2015 16:27	
eskom.co.za	Transferred	06/10/2015 16:26	
BC: GeerinJH@eskom.co.za(GeerinJH@eskom.co.za)	Delivered	06/10/2015 16:29	
BC: HaarnL@eskom.co.za(HaarnL@eskom.co.za)	Delivered	06/10/2015 16:29	
BC: LeaskK@eskom.co.za(LeaskK@eskom.co.za)	Delivered	06/10/2015 16:29	
BC: WynгааJO@eskom.co.za(WynгааJO@eskom.co.za)	Delivered	06/10/2015 16:29	
ewt.org.za	Transferred	06/10/2015 16:26	
BC: wep@ewt.org.za(wep@ewt.org.za)	Delivered	06/10/2015 16:44	
gmail.com	Transferred	06/10/2015 16:26	
BC: amelastrauss2@gmail.com(ameilastrauss2@gmail.com)	Delivered	06/10/2015 16:30	
BC: andre.vanniekerk10@gmail.com(andre.vanniekerk10@gmail.com)	Delivered	06/10/2015 16:30	
BC: jdbhenrohn@gmail.com(jdbhenrohn@gmail.com)	Delivered	06/10/2015 16:30	
BC: marcyroxpc@gmail.com(marcyroxpc@gmail.com)	Delivered	06/10/2015 16:30	
BC: ratha.timothy@gmail.com(ratha.timothy@gmail.com)	Delivered	06/10/2015 16:30	
BC: sdelafontaine@gmail.com(sdelafontaine@gmail.com)	Delivered	06/10/2015 16:30	
BC: townsendmorgan029@gmail.com(townsendmorgan029@gmail.com)	Delivered	06/10/2015 16:30	
grasslands.org.za	Transferred	06/10/2015 16:26	
BC: admin@grasslands.org.za(admin@grasslands.org.za)	Delivered	06/10/2015 16:29	
kalgarib.gov.za	Transferred	06/10/2015 16:26	
BC: mm@kalgarib.gov.za(mm@kalgarib.gov.za)			
L2B.co.za	Transferred	06/10/2015 16:26	
BC: MelanieM@L2B.co.za(MelanieM@L2B.co.za)	Delivered	06/10/2015 16:27	

Scoping and Environmental Impact Assessment for the proposed Development of a 75 MW Solar Photovoltaic Facility (KENHARDT PV 1) on the remaining extent of Onder Rugzeer Farm 168, north-east of Kenhardt, Northern Cape Province

 labour.gov.za	Transferred	06/10/2015 16:26
BC: monica.ephene@labour.gov.za(monica.ephene@labour.gov.za)	Delivered	06/10/2015 16:28
 mullo.com	Transferred	06/10/2015 16:26
BC: karen@mullo.com(karen@mullo.com)	Delivered	06/10/2015 16:27
 mweb.co.za	Transferred	06/10/2015 16:26
BC: kraaines@mweb.co.za(kraaines@mweb.co.za)	Delivered	06/10/2015 16:27
 ncpg.gov.za	Transferred	06/10/2015 16:27
BC: mmathews@ncpg.gov.za(mmathews@ncpg.gov.za)	Delivered	06/10/2015 16:27
BC: mndzili@ncpg.gov.za(mndzili@ncpg.gov.za)	Delivered	06/10/2015 16:27
BC: nyaphi@ncpg.gov.za(nyaphi@ncpg.gov.za)	Delivered	06/10/2015 16:27
BC: nwane@ncpg.gov.za(nwane@ncpg.gov.za)	Delivered	06/10/2015 16:27
BC: sribanjwa@ncpg.gov.za(sribanjwa@ncpg.gov.za)	Delivered	06/10/2015 16:27
 nda.agric.za	Transferred	06/10/2015 16:27
BC: annelzacc@nda.agric.za(annelzacc@nda.agric.za)	Delivered	06/10/2015 16:27
 nersa.org.za	Transferred	06/10/2015 16:27
BC: peter.buys@nersa.org.za(peter.buys@nersa.org.za)	Delivered	06/10/2015 16:28
 nocci.co.za	Transferred	06/10/2015 16:27
BC: sharon@nocci.co.za(sharon@nocci.co.za)		
 nra.co.za	Transferred	06/10/2015 16:27
BC: wa1@nra.co.za(wa1@nra.co.za)	Delivered	06/10/2015 16:30
 orientis.co.za	Transferred	06/10/2015 16:27
BC: straussd@orientis.co.za(straussd@orientis.co.za)	Delivered	06/10/2015 16:30
 POBOX1.DURBAN		
To: Rohaida Abedi.RAbedi@csir.co.za	Read	06/10/2015 16:26
 POBOX1.STELLBOS	Delivered	06/10/2015 16:26
BC: Surina Laurie(SLaurie@csir.co.za)	Third-Party Downloaded Read	06/10/2015 16:26 06/10/2015 16:26
 sanbi.org.za	Transferred	06/10/2015 16:27
BC: lntolo@sanbi.org.za(lntolo@sanbi.org.za)	Undeliverable	06/10/2015 16:30
 scatecsolar.com	Transferred	06/10/2015 16:27
BC: mitchell.hodgson@scatecsolar.com(mitchell.hodgson@scatecsolar.com)		
 siyanda.gov.za	Transferred	06/10/2015 16:27
BC: sb@siyanda.gov.za(sb@siyanda.gov.za)	Undeliverable	11/10/2015 16:43
 ska.ac.za	Transferred	06/10/2015 16:27
BC: atipiady@ska.ac.za(atipiady@ska.ac.za)	Delivered	06/10/2015 16:28
 transnet.net	Transferred	06/10/2015 16:27
BC: Olive.Stephenson@transnet.net(Olive.Stephenson@transnet.net)	Delivered	06/10/2015 16:28
 transnet.net	Transferred	06/10/2015 16:27
BC: Gilbert.Nortier@transnet.net(Gilbert.Nortier@transnet.net)	Delivered	06/10/2015 16:28
BC: Marina.Lourens@transnet.net(Marina.Lourens@transnet.net)	Delivered	06/10/2015 16:28
BC: Mayvyn.Bhana@transnet.net(Mayvyn.Bhana@transnet.net)	Delivered	06/10/2015 16:28
 tpw.ncape.gov.za	Transferred	06/10/2015 16:27
BC: klawrence@tpw.ncape.gov.za(klawrence@tpw.ncape.gov.za)	Undeliverable	06/10/2015 16:28
 veroniva.co.za	Transferred	06/10/2015 16:27
BC: claude@veroniva.co.za(claude@veroniva.co.za)	Delivered	06/10/2015 16:28
 vodamail.co.za	Transferred	06/10/2015 16:27
BC: teresascheepers@vodamail.co.za(teresascheepers@vodamail.co.za)	Delivered	06/10/2015 16:42 2.0.0 recipients expanded
 webmail.co.za	Transferred	06/10/2015 16:27
BC: jhs@webmail.co.za(jhs@webmail.co.za)	Transferred	06/10/2015 16:56 2.0.0 message relayed
 worldonline.co.za	Transferred	06/10/2015 16:27
BC: ncagric@worldonline.co.za(ncagric@worldonline.co.za)	Delivered	06/10/2015 16:28
 yahoo.com	Transferred	06/10/2015 16:27
BC: boozahunter@yahoo.com(boozahunter@yahoo.com)	Delivered	06/10/2015 16:28

Post Offices		
Post Office	Delivered	Route
agri.ncape.gov.za		agrincape.gov.za
agrink.co.za		agrink.co.za
aheadtrading.co.za		aheadtrading.co.za
birdlife.org.za		birdlife.org.za
boofr.gov.za		boofr.gov.za
caa.co.za		caa.co.za
daff.gov.za		daff.gov.za
donco.co.za		donco.co.za
dwa.gov.za		dwa.gov.za
dws.gov.za		dws.gov.za
environment.gov.za		environment.gov.za
eskom.co.za		eskom.co.za
ewf.org.za		ewf.org.za
gmail.com		gmail.com
grasslands.org.za		grasslands.org.za
kgalgarib.gov.za		kgalgarib.gov.za
L2B.co.za		L2B.co.za
labour.gov.za		labour.gov.za
mullio.com		mullio.com
mweb.co.za		mweb.co.za
nccpg.gov.za		nccpg.gov.za
nda.agric.za		nda.agric.za
nersa.org.za		nersa.org.za
nocci.co.za		nocci.co.za
nra.co.za		nra.co.za
orientis.co.za		orientis.co.za
POBOX1.DURBAN	06/10/2015 16:25	csir.co.za
POBOX1.STELLBOS	06/10/2015 16:26	csir.co.za
sanbi.org.za		sanbi.org.za
scalecsolar.com		scalecsolar.com
siyanda.gov.za		siyanda.gov.za
ska.ac.za		ska.ac.za
transnet.net		transnet.net
transnet.net		transnet.net
trpw.ncape.gov.za		trpw.ncape.gov.za
veroniva.co.za		veroniva.co.za
vodamail.co.za		vodamail.co.za
webmail.co.za		webmail.co.za
worldonline.co.za		worldonline.co.za
yahoo.com		yahoo.com
Files		
File	Size	Date & Time
Comment and Response Form_Scatec Solar_NC_FINAL.pdf	86780	06/10/2015 13:05
MESSAGE	7348	06/10/2015 16:25
Scatec Solar PV1_DSR_Addendum_FINAL.pdf	672079	06/10/2015 12:50
Scatec Solar PV2_DSR_Addendum_FINAL.pdf	672385	06/10/2015 12:55
Scatec Solar PV3_DSR_Addendum_FINAL.pdf	575258	06/10/2015 13:02
TEXT.htm	15044	06/10/2015 16:25
Options		
Auto Delete:	No	
Concealed Subject:	No	
Expiration Date:	None	
Notify Recipients:	Yes	
Priority:	Standard	
Reply requested by Security:	None	
To Be Delivered:	Standard	
	Immediate	
Record Id		
Record Id:	5613F617.DURBAN.POB0X1.100.1366037.1.D129.1	
Common Record Id:	5613F617.DURBAN.POB0X1.200.2000083.1.32FA7.1	

Addendum to the Scoping Report for Kenhardt PV 1 sent with Email 3 on 6 October 2015

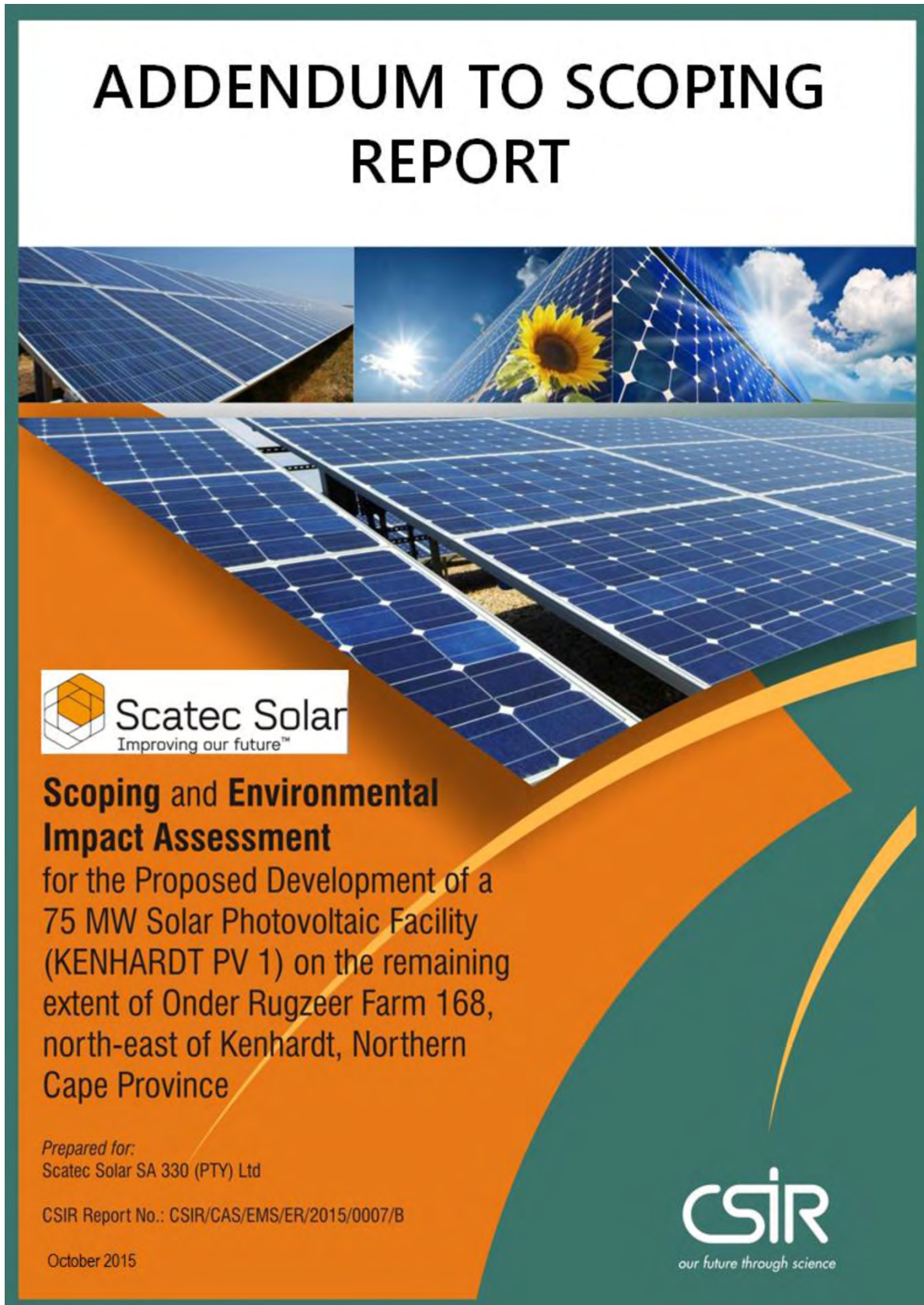

ADDENDUM TO SCOPING REPORT



Scoping and Environmental Impact Assessment
for the Proposed Development of a
75 MW Solar Photovoltaic Facility
(KENHARDT PV 1) on the remaining
extent of Onder Rugzeer Farm 168,
north-east of Kenhardt, Northern
Cape Province

Prepared for:
Scatec Solar SA 330 (PTY) Ltd

CSIR Report No.: CSIR/CAS/EMS/ER/2015/0007/B

October 2015



Scoping and Environmental Impact Assessment for the proposed Development of a 75 MW Solar Photovoltaic Facility (KENHARDT PV 1) on the remaining extent of Onder Rugzeer Farm 168, north-east of Kenhardt, Northern Cape Province

report details

Title:	Scoping and Environmental Impact Assessment for the Proposed Development of a 75 MW Solar Photovoltaic Facility (KENHARDT PV 1) on the remaining extent of Onder Rugzeer Farm 168, north-east of Kenhardt, Northern Cape Province: ADDENDUM TO SCOPING REPORT
Prepared for:	The Scoping Report for the proposed Kenhardt PV 1 project is being made available to all stakeholders for a 30-day review period, extending from 25 September 2015 to 27 October 2015. Additional information has been requested by the National Department of Environmental Affairs, and as such, this addendum has been compiled by the CSIR. This Addendum to the Scoping Report for the proposed Kenhardt PV 1 project will be made available to I&APs from 6 October 2015 to 5 November 2015.
Prepared for:	Scatec Solar SA 330 (PTY) Ltd Contact Person: Claude Bosman / Mitchell Hodgson
Prepared by:	CSIR P O Box 17001, Congella, Durban, 4013, South Africa Tel: +27 31 242 2300 Fax: +27 31 261 2509
Authors:	Paul Lochner, Surina Laurie and Rohaida Abed
Mapping:	Luanita van der Walt
CSIR Report Number:	CSIR/CAS/EMS/ER/2015/0007/B
CSIR Project Number:	EMS0102
CSIR Reference:	EMS0102/Scatec/2015
Date:	October 2015
To be cited as:	CSIR, 2015. Scoping and Environmental Impact Assessment for the Proposed Development of a 75 MW Solar Photovoltaic Facility (KENHARDT PV 1) on the remaining extent of Onder Rugzeer Farm 168, north-east of Kenhardt, Northern Cape Province: Addendum to Scoping Report. CSIR Report Number: CSIR/CAS/EMS/ER/2015/0007/B
Copyright:	© CSIR 2015. All rights to the intellectual property and/or contents of this document remain vested in the CSIR. This document is issued for the sole purpose for which it is supplied. No part of this publication may be reproduced, stored in a retrieval system or transmitted, in any form or by means electronic, mechanical, photocopying, recording or otherwise without the express written permission of the CSIR. It may also not be lent, resold, hired out or otherwise disposed of by way of trade in any form of binding or cover than that in which it is published.

contents

1. PURPOSE OF THIS ADDENDUM	3
2. METHODOLOGY FOR THE ASSESSMENT OF ALTERNATIVES	4
3. ASSESSMENT OF LOCATION ALTERNATIVES.....	6
4. CONCLUSION	11
5. REFERENCES.....	11
Table 1: Assessment of Impacts/Risks of the Location Alternatives identified for the proposed project.....	7
Figure 1: Guide to assessing risk/impact significance as a result of consequence and probability.	4

1. PURPOSE OF THIS ADDENDUM

A pre-application meeting was held with the National Department of Environmental Affairs (DEA) (i.e. Herman Alberts and Mmamohale Kabasa) and the CSIR on 17 September 2015 at the DEA's offices to discuss the proposed projects (i.e. Kenhardt PV 1, Kenhardt PV 2 and Kenhardt PV 3 and their associated electrical infrastructure) and requirements for the Basic Assessment, and Scoping and EIA Phases. The CSIR compiled notes of the pre-application meeting and submitted it to the DEA on 23 September 2015 for review and acceptance. Due to the strict timeframes for this project and the fact that no significant issues were raised during the pre-application meeting that was not addressed in the Scoping Report for this project, the Scoping Report was sent out for public comment for 30 days (25 September 2015 to 27 October 2015). Subsequent to this, the DEA provided comments on the meeting notes and approval thereof via email on 1 October 2015. As part of the comments received on the meeting notes, the DEA recommended that specialist studies should be included with the Scoping Report, which needs to be site specific. The need for specialist studies in this regard is related to the assessment of applicable alternatives that have been considered in the Scoping Phase in order to determine the preferred alternatives.

This Addendum to the Scoping Report has been compiled to provide the additional information, as per the DEA's request. It should be noted that the CSIR project team has undertaken this assessment based on desktop literature, previous experience of working on Solar PV facilities and the specialist studies undertaken for the proposed Nieuwehoop Solar Development located adjacent to this proposed project.

This Addendum to the Scoping Report only discusses the proposed **Kenhardt PV 1** project and must be read in conjunction with the project's Scoping Report.

It is important to note that Chapter 5 of the Scoping Report provides a detailed explanation of the advantages and disadvantages of the location alternatives of the proposed PV projects. Furthermore, specialist input (i.e. Terrestrial Ecology, Aquatic Ecology, Avifauna, Visual Landscape, Archaeology and Palaeontology, Geohydrology, Soils and Agricultural Land, and Social Aspects) has also been provided and integrated into the following chapters of the Scoping Report:

- Chapter 3 - Description of the Affected Environment;
- Chapter 6 - Issues and Potential Impacts; and
- Chapter 8 - Plan of Study for EIA.

Therefore, this document (i.e. Addendum to the Scoping Report for Kenhardt PV 1), aims to address the additional comments from the DEA (as requested on 1 October 2015) and to provide the following (in line with Appendix 2 (2) (h) of the 2014 EIA Regulations):

- impacts and risks identified for each alternative, including the nature, significance, consequence, extent, duration and probability of the impacts, including the degree to which these impacts - (aa) can be reversed; (bb) may cause irreplaceable loss of resources; and (cc) can be avoided, managed or mitigated; and
- the methodology used in determining and ranking the nature, significance, consequences, extent, duration and probability of potential environmental impacts and risks associated with the alternatives.

It is important to note that the following aspects (in line with Appendix 2 (2) (h) of the 2014 EIA Regulations) have been addressed in Chapter 5 (i.e. Project Alternatives) of the Scoping Reports:

- positive and negative impacts that the proposed activity and alternatives will have on the environment and on the community that may be affected focusing on the geographical, physical, biological, social, economic, heritage and cultural aspects;
- the outcome of the site selection matrix;
- motivation for not considering certain alternatives; and

Scoping and Environmental Impact Assessment for the proposed Development of a 75 MW Solar Photovoltaic Facility (KENHARDT PV 1) on the remaining extent of Onder Rugzeer Farm 168, north-east of Kenhardt, Northern Cape Province

- a concluding statement indicating the preferred alternatives, including preferred location of the activity.

It is therefore important to note that this Addendum does not present new information that have not been used in the compilation of the Scoping Report but serves to provide the DEA and Interested and Affected Parties (I&APs) with a more detailed assessment of how the preferred site location was determined.

2. METHODOLOGY FOR THE ASSESSMENT OF ALTERNATIVES

The following methodology has been adopted to rank and determine the nature, significance, consequences, extent, duration and probability of the potential impacts and risks identified for each of the **location alternatives** identified (i.e. Kenhardt PV 1b). As noted in Chapter 5 of the Scoping Report, applicable and relevant technology alternatives will be described during the EIA Phase, such as those relating to the mounting system. This Addendum therefore only relates to the assessment of the location alternatives considered by the Applicant.

A risk assessment approach was used to preliminarily assess (at a scoping level) the potential risks/impacts that the proposed development may impose on the receiving environment. Potential issues have been identified and assessed based on available information on generally expected impacts associated with solar PV facilities. As noted above, information was mainly sourced from existing specialist studies as part of EIAs carried out in the surrounding area (such as the proposed Nieuwehoop Solar Development located adjacent to this proposed project).

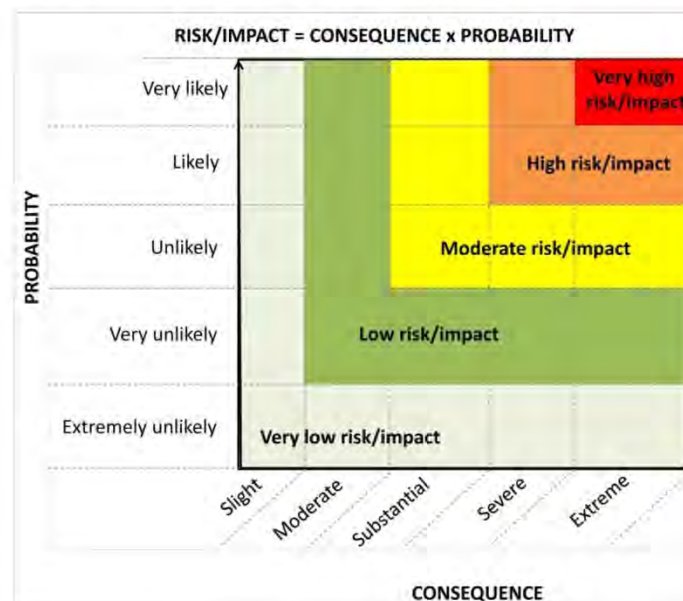

Figure 1: Guide to assessing risk/impact significance as a result of consequence and probability.

The risk assessment approach followed for this Scoping Phase incorporates internationally recognised methods from the Intergovernmental Panel on Climate Change (IPCC) (2014) assessment of the effects of climate change. The approach is based on an interpretation of existing information in relation to the proposed activity, to generate an integrated picture of the risks related to a specified activity in a given location, with and without mitigation. Risk is assessed for each significant stressor (e.g. physical disturbance), on each different type of receiving entity (e.g. the municipal capacity, a sensitive wetland), qualitatively (very low, low, moderate, high, and very high) against a predefined set of criteria (i.e. probability and consequence), as indicated in Figure 1.

The following criteria have been considered in the assessment of risk/impacts of the location alternatives:

- Status - Whether the risk/impact on the overall environment will be:
 - Positive - environment overall will benefit from the impact; or
 - Negative - environment overall will be adversely affected by the impact.
- Spatial extent - The size of the area that will be affected by the risk/impact:
 - Site;
 - Local (<10 km from site);
 - Regional (<100 km of site);
 - National; or
 - International (e.g. Greenhouse Gas emissions or migrant birds).
- Duration - The timeframe during which the risk/impact will be experienced:
 - Very short term (instantaneous);
 - Short term (less than 1 year);
 - Medium term (1 to 10 years);
 - Long term (the impact will occur for the project duration); or
 - Permanent (mitigation will not occur in such a way or in such a time span that the impact can be considered transient (i.e. the impact will occur beyond the project decommissioning)).
- Consequence - The anticipated consequence of the risk/impact:
 - Slight;
 - Moderate;
 - Substantial;
 - Severe; and
 - Extreme.
- Probability - The probability of the impact occurring:
 - Very likely;
 - Likely;
 - Unlikely;
 - Very unlikely; and
 - Extremely unlikely.
- Reversibility of the Impacts - the extent to which the risks/impacts are reversible assuming that the project has reached the end of its life cycle (decommissioning phase):
 - Yes: High reversibility of impacts (impact is highly reversible at end of project life);
 - Partially: Moderate reversibility of impacts; or
 - No: Impacts are non-reversible (impact is permanent).
- Irreplaceability of Receiving Environment/Resource Loss caused by risk/impacts - the degree to which the impact causes irreplaceable loss of resources assuming that the project has reached the end of its life cycle (decommissioning phase):
 - High irreplaceability of resources (project will destroy unique resources that cannot be replaced);

Scoping and Environmental Impact Assessment for the proposed Development of a 75 MW Solar Photovoltaic Facility (KENHARDT PV 1) on the remaining extent of Onder Rugzeer Farm 168, north-east of Kenhardt, Northern Cape Province

- Moderate irreplaceability of resources; or
- Low irreplaceability of resources.

The significance of the risk/impact is then determined through a combination of the consequence and probability and is rated qualitatively as follows:

- Very low (the risk/impact may result in very minor alterations of the environment and can be easily avoided by implementing appropriate mitigation measures, and will not have an influence on decision-making);
- Low (the risk/impact may result in minor alterations of the environment and can be easily avoided by implementing appropriate mitigation measures, and will not have an influence on decision-making);
- Moderate (the risk/impact will result in moderate alteration of the environment and can be reduced or avoided by implementing the appropriate mitigation measures, and will only have an influence on the decision-making if not mitigated);
- High (the risk/impact will result in major alteration to the environment even with the implementation on the appropriate mitigation measures and will have an influence on decision-making); and
- Very high (the impact will result in very major alteration to the environment even with the implementation on the appropriate mitigation measures and will have an influence on decision-making (i.e. the project cannot be authorised unless major changes to the engineering design are carried out to reduce the significance rating)).

Please note that impacts with a positive status (e.g. employment opportunities and diversified economy) may also be indicated as being high or very high. In these cases high and very high ratings are desirable and indicate benefits to the particular receiving environment.

With the implementation of mitigation measures, the residual impacts/risks are ranked as follows in terms of significance:

- Very low = 5;
- Low = 4;
- Moderate = 3;
- High = 2; and
- Very high = 1.

It must be noted that the results of this high-level preliminary impact assessment (which has been conducted by the CSIR project team based on existing information) will be verified by relevant specialists during the EIA Phase. Refer to Chapter 8 of the Scoping Report for the Terms of Reference for the specialist studies that will be undertaken during the EIA Phase. Section 3 below provides the results of the alternatives assessment.

3. ASSESSMENT OF LOCATION ALTERNATIVES

Table 1 below shows the assessment of the potential impacts and risks for the location alternatives in terms of nature, significance, consequences, extent, duration and probability.

Scoping and Environmental Impact Assessment for the proposed Development of a 75 MW Solar Photovoltaic Facility (KENHARDT PV 1) on the remaining extent of Onder Rugzeer Farm 168, north-east of Kenhardt, Northern Cape Province

Scoping and Environmental Impact Assessment for the proposed Development of a 75 MW Solar Photovoltaic Facility (KENHARDT PV 1) on the remaining extent of Onder Rugzeer Farm 168, north-east of Kenhardt, Northern Cape Province

Table 1: Assessment of Impacts/Risks of the Location Alternatives Identified for the proposed project

Impact Pathway	Nature of the Potential Impact/Risk	Alternative Site	Status	Phase (Construction, Operation and Decommissioning)	Spatial Extent	Duration	Consequence	Probability	Significance of Impact/Risk (Without Mitigation)	Reversibility	Inevitability	Can the Impact/Risk be Avoided?	Can the Impact/Risk be Mitigated/Managed?	Potential Mitigation Measures	Significance of Residual Impact/Risk (With Mitigation)	Ranking of Significance of Residual Impact/Risk (With Mitigation)
Biophysical																
Clearing of approximately 250 ha of vegetation	Habitat and species loss	Kenhardt PV 1 (Preferred)	Negative	Construction Phase	Site	Medium Term	Substantial	Very likely	Moderate	Yes (Rehabilitation after decommissioning)	Moderate	No	Yes	<ul style="list-style-type: none"> Implement a plant search and rescue programme prior to the commencement of construction and vegetation clearing. 	Moderate	3
		Kenhardt PV 1a (Alternative)	Negative	Construction Phase	Site	Medium Term	Substantial	Very likely	Moderate	Yes (Rehabilitation after decommissioning)	Moderate	No	Yes	<ul style="list-style-type: none"> Implement a plant search and rescue programme prior to the commencement of construction and vegetation clearing. 	Moderate	3
	Exposed soil susceptible to erosion	Kenhardt PV 1 (Preferred)	Negative	Construction and Decommissioning Phases	Site	Long Term	Slight	Very likely	Very Low	Yes (Rehabilitation after decommissioning)	Low	Yes	Yes	<ul style="list-style-type: none"> Implement an Erosion Management Plan during the construction and decommissioning phases. Implement an effective system of run-off control (where required). Undertake vegetation removal in a systematic, sequential manner, in order to avoid bare soil for long periods. 	Very low	5
		Kenhardt PV 1b (Alternative)	Negative	Construction and Decommissioning Phases	Site	Long Term	Slight	Very likely	Very Low	Yes (Rehabilitation after decommissioning)	Low	Yes	Yes	<ul style="list-style-type: none"> Implement an Erosion Management Plan during the construction and decommissioning phases. Implement an effective system of run-off control (where required). Undertake vegetation removal in a systematic, sequential manner, in order to avoid bare soil for long periods. 	Very low	5
Excavation of watercourses	Habitat and species loss	Kenhardt PV 1 (Preferred)	Negative	Construction and Decommissioning Phases	Local	Long-term	Substantial	Extremely unlikely	Very Low	Partially (Rehabilitation after decommissioning)	Low (No NFEPA Wetlands)	Yes	Yes	<ul style="list-style-type: none"> Adaptive project design to avoid watercourses and wetlands (if any). The site layout needs to accommodate the need for effective setbacks of the development and its infrastructure from the aquatic habitats. Management of flow into any wetlands or drainage areas should be such that the development, regardless of extent of setback, does not result in any impacts to sensitive aquatic systems. 	Very low	5
		Kenhardt PV 1b (Alternative)	Negative	Construction and Decommissioning Phases	Local	Long-term	Substantial	Extremely unlikely	Very Low	Partially (Rehabilitation after decommissioning)	Low (No NFEPA Wetlands)	Yes	Yes	<ul style="list-style-type: none"> Adaptive project design to avoid watercourses and wetlands (if any). The site layout needs to accommodate the need for effective setbacks of the development and its infrastructure from the aquatic habitats. Management of flow into any wetlands or drainage areas should be such that the development, regardless of extent of setback, does not result in any impacts to sensitive aquatic systems. 	Very low	5
Water Runoff	Altered hydrological regime and water quality	Kenhardt PV 1 (Preferred)	Negative	Construction, Operations and Decommissioning Phases	Local	Long-term	Substantial	Unlikely	Moderate	Partially (Rehabilitation after decommissioning)	Low (No NFEPA Wetlands)	No	Yes	<ul style="list-style-type: none"> Chemical storage containers must be regularly inspected to ensure that leaks are detected early. Chemicals must be stored in impermeable, bunded areas. 	Very low	5

Copyright 2015 © CSIR - ADDENDUM TO SCOPING REPORT
Page 7

Scoping and Environmental Impact Assessment for the proposed Development of a 75 MW Solar Photovoltaic Facility (KENHARDT PV 1) on the remaining extent of Onder Rugzeer Farm 168, north-east of Kenhardt, Northern Cape Province

Impact Pathway	Nature of the Potential Impact/Risk	Alternative Site	Status	Phase (Construction, Operation and Decommissioning)	Spatial Extent	Duration	Consequence	Probability	Significance of Impact/Risk (Without Mitigation)	Reversibility	Inevitability	Can the Impact/Risk be Avoided?	Can the Impact/Risk be Mitigated/Managed?	Potential Mitigation Measures	Significance of Residual Impact/Risk (With Mitigation)	Ranking of Significance of Residual Impact/Risk (With Mitigation)
Disturbance of soils	Alien plant invasion in disturbed areas	Kenhardt PV 1b (Alternative)	Negative	Construction, Operations and Decommissioning Phases	Local	Long-term	Substantial	Very unlikely	Low	Partially (Rehabilitation after decommissioning)	High (based on expected sparse alien invasive plants)	No	Yes	<ul style="list-style-type: none"> Lifting and contamination of water sources during construction must be prevented by effective construction camp management. No stockpiling should take place within a watercourse. All stockpiles must be protected from erosion, stored on flat areas where run-off will be minimised. Stockpiles and abatement facilities must be located away from river channels i.e. further than 32 m away. 	Very low	5
		Kenhardt PV 1 (Preferred)	Negative	Construction, Operations and Decommissioning Phases	Local	Long-term	Severe	Very likely	High	Partially (Rehabilitation after decommissioning)	High (based on expected sparse alien invasive plants)	No	Yes	<ul style="list-style-type: none"> All plant and machinery should be cleaned at the contractor's depot / facilities before these are transported to the site. Clearing of vegetation should be kept to a minimum. An alien invasive management plan should be implemented to reduce the invasion of alien species and ensure that the continuous monitoring and removal of alien species is undertaken. 	Low	4
	Disturbance of soils	Kenhardt PV 1b (Alternative)	Negative	Construction, Operations and Decommissioning Phases	Local	Long-term	Severe	Very likely	High	Partially (Rehabilitation after decommissioning)	Low (No NFEPA Wetlands)	Yes	Yes	<ul style="list-style-type: none"> All plant and machinery should be cleaned at the contractor's depot / facilities before these are transported to the site. Clearing of vegetation should be kept to a minimum. An alien invasive management plan should be implemented to reduce the invasion of alien species and ensure that the continuous monitoring and removal of alien species is undertaken. 	Low	4
		Kenhardt PV 1 (Preferred)	Negative	Construction, Operations and Decommissioning Phases	Local	Long-term	Severe	Very likely	High	Partially (Rehabilitation after decommissioning)	Low (No NFEPA Wetlands)	Yes	Yes	<ul style="list-style-type: none"> All plant and machinery should be cleaned at the contractor's depot / facilities before these are transported to the site. Clearing of vegetation should be kept to a minimum. An alien invasive management plan should be implemented to reduce the invasion of alien species and ensure that the continuous monitoring and removal of alien species is undertaken. 	Low	4
Social																
Influx of people (jobseekers)	Disruption of social fabric (e.g. crime) and pressure on available services (e.g. schools)	Kenhardt PV 1 (Preferred)	Negative	Construction, Operations and Decommissioning Phases	Local	Medium-term	Substantial	Very Likely	Moderate	No	Moderate	No	Yes	<ul style="list-style-type: none"> Develop and implement a Workforce Recruitment Plan. Reserve employment, where practical, for local residents. Develop and implement a Stakeholder Engagement Plan. 	Low	4

Copyright 2015 © CSIR - ADDENDUM TO SCOPING REPORT
Page 8

Scoping and Environmental Impact Assessment for the proposed Development of a 75 MW Solar Photovoltaic Facility (KENHARDT PV 1) on the remaining extent of Onder Rugzeer Farm 168, north-east of Kenhardt, Northern Cape Province

Scoping and Environmental Impact Assessment for the proposed Development of a 75 MW Solar Photovoltaic Facility (KENHARDT PV 1) on the remaining extent of Onder Rugzeer Farm 168, north-east of Kenhardt, Northern Cape Province

Impact Pathway	Nature of the Potential Impact/Risk	Alternative Site	Status	Phase (Construction, Operation and Decommissioning)	Spatial Extent	Duration	Consequence	Probability	Significance of Impact/Risk (Without Mitigation)	Reversibility	Irreplacability	Can the Impact/Risk be Avoided?	Can the Impact/Risk be Mitigated/Managed?	Potential Mitigation Measures	Significance of Residual Impact/Risk (With Mitigation)	Ranking of Significance of Residual Impact/Risk (With Mitigation)
	housing	Kenhardt PV 1b (Alternative)	Negative	Construction, Operations and Decommissioning Phases	Local	Medium-term	Substantial	Very Likely	Moderate	No	Moderate	No	Yes	<ul style="list-style-type: none"> Develop and implement a Workforce Recruitment Plan. Reserve employment, where practical, for local residents. Develop and implement a Stakeholder Engagement Plan. 	Low	4
Labour required for project development and operation	Increased employment opportunities	Kenhardt PV 1 (Preferred)	Positive	Construction, Operations and Decommissioning Phases	Local	Medium-term	Severe	Very Likely	High (positive)	Partially	Low	Not Applicable (Positive Impact)	Not Applicable (Positive Impact)	<ul style="list-style-type: none"> Develop and implement a Workforce Recruitment Policy 	Very High (positive)	1
		Kenhardt PV 1b (Alternative)	Positive	Construction, Operations and Decommissioning Phases	Local	Medium-term	Severe	Very Likely	High (positive)	Partially	Low	Not Applicable (Positive Impact)	Not Applicable (Positive Impact)	<ul style="list-style-type: none"> Develop and implement a Workforce Recruitment Policy 	Very High (positive)	1
Potential water use for panel cleaning and maintenance	Impact on the stressed regional water resource	Kenhardt PV 1 (Preferred)	Negative	Operations Phase	Local	Long-term	Slight	Unlikely	Very Low	Partially (water re-use and recycling)	High	No	Yes	<ul style="list-style-type: none"> Utilise the boreholes as per the recommended sustainable yields and avoid over abstraction of any one borehole. Monitor the borehole water levels and abstraction volumes. 	Very Low	5
		Kenhardt PV 1b (Alternative)	Negative	Operations Phase	Local	Long-term	Slight	Unlikely	Very Low	Partially (water re-use and recycling)	High	No	Yes	<ul style="list-style-type: none"> Utilise the boreholes as per the recommended sustainable yields and avoid over abstraction of any one borehole. Monitor the borehole water levels and abstraction volumes. 	Very Low	5
Agriculture																
Clearing of land for project construction	Loss of agricultural land	Kenhardt PV 1 (Preferred)	Negative	Construction Phase	Site	Long-term	Slight	Very Likely	Very Low	Yes	Low	No	Yes	<ul style="list-style-type: none"> Limit the development footprint to the area strictly required for optimal operations. Limit unnecessary disturbance outside of the proposed project area. 	Very Low	5
		Kenhardt PV 1b (Alternative)	Negative	Construction Phase	Site	Long-term	Slight	Very Likely	Very Low	Yes	Low	No	Yes	<ul style="list-style-type: none"> Limit the development footprint to the area strictly required for optimal operations. Limit unnecessary disturbance outside of the proposed project area. 	Very Low	5
Economic																
Diversification of land use to include renewable energy together with agriculture and other economic revenues	Increased land use income	Kenhardt PV 1 (Preferred)	Positive	Operations Phase	Site	Long-term	Severe	Very Likely	High (positive)	Partially	Not applicable	Not Applicable (Positive Impact)	Not Applicable (Positive Impact)	<ul style="list-style-type: none"> Ensure proper maintenance of the facility to ensure optimal operations during the operational phase and to ensure that the proposed facility operates within its design capacity to deliver as the market requires. 	Very High (positive)	1
		Kenhardt PV 1b (Alternative)	Positive	Operations Phase	Site	Long-term	Severe	Very Likely	High (positive)	Partially	Not applicable	Not Applicable (Positive Impact)	Not Applicable (Positive Impact)	<ul style="list-style-type: none"> Ensure proper maintenance of the facility to ensure optimal operations during the operational phase and to ensure that the proposed facility operates within its design capacity to deliver as the market requires. 	Very High (positive)	1
Project expenditure (including direct capital investment, and compulsory social investment)	Investment and growth in local economy	Kenhardt PV 1 (Preferred)	Positive	Construction, Operations and Decommissioning Phases	Regional	Long-term	Severe	Very Likely	High (positive)	Partially	Not applicable	Not Applicable (Positive Impact)	Not Applicable (Positive Impact)	<ul style="list-style-type: none"> Encourage and focus the implementation of Corporate Social Investment on a local scale. 	Very High (positive)	1
		Kenhardt PV 1b (Alternative)	Positive	Construction, Operations and Decommissioning Phases	Regional	Long-term	Severe	Very Likely	High (positive)	Partially	Not applicable	Not Applicable (Positive Impact)	Not Applicable (Positive Impact)	<ul style="list-style-type: none"> Encourage and focus the implementation of Corporate Social Investment on a local scale. 	Very High (positive)	1

Copyright 2015 © CSIR - ADDENDUM TO SCOPING REPORT
Page 9

Scoping and Environmental Impact Assessment for the proposed Development of a 75 MW Solar Photovoltaic Facility (KENHARDT PV 1) on the remaining extent of Onder Rugzeer Farm 168, north-east of Kenhardt, Northern Cape Province

Impact Pathway	Nature of the Potential Impact/Risk	Alternative Site	Status	Phase (Construction, Operation and Decommissioning)	Spatial Extent	Duration	Consequence	Probability	Significance of Impact/Risk (Without Mitigation)	Reversibility	Irreplacability	Can the Impact/Risk be Avoided?	Can the Impact/Risk be Mitigated/Managed?	Potential Mitigation Measures	Significance of Residual Impact/Risk (With Mitigation)	Ranking of Significance of Residual Impact/Risk (With Mitigation)
Development of the proposed facility on prime land	Decreased property values	Kenhardt PV 1 (Preferred)	Negative	Construction, Operations and Decommissioning Phases	Site	Long-term	Substantial	Very Likely	Moderate	Yes	Not applicable	No	Yes	<ul style="list-style-type: none"> Ensure proper maintenance of the facility to ensure optimal operations during the operational phase to enhance the significance of the impact. 	Moderate	3
		Kenhardt PV 1b (Alternative)	Negative	Construction, Operations and Decommissioning Phases	Site	Long-term	Substantial	Very Likely	Moderate	Yes	Not applicable	No	Yes	<ul style="list-style-type: none"> Ensure proper maintenance of the facility to ensure optimal operations during the operational phase to enhance the significance of the impact. 	Moderate	3
Heritage																
Development of the proposed facility in the presence of sensitive heritage resources	Disturbance, damage or destruction of fossils at surface or beneath the ground	Kenhardt PV 1 (Preferred)	Negative	Construction Phase	Site	Permanent	Slight	Likely	Very Low	No	Low	No	Yes	<ul style="list-style-type: none"> Monitor all deeper (> 1m) excavations into sedimentary rocks for fossil material. Fossil finds made during the construction phase should be safeguarded and reported to SAHRA for possible recording and sampling by a professional palaeontologist. 	Very Low	5
		Kenhardt PV 1b (Alternative)	Negative	Construction Phase	Site	Permanent	Slight	Likely	Very Low	No	Low	No	Yes	<ul style="list-style-type: none"> Monitor all deeper (> 1m) excavations into sedimentary rocks for fossil material. Fossil finds made during the construction phase should be safeguarded and reported to SAHRA for possible recording and sampling by a professional palaeontologist. 	Very Low	5
	Destruction of heritage resources (including archaeological material and built environment)	Kenhardt PV 1 (Preferred)	Negative	Construction Phase	Site	Permanent	Moderate	Likely	Low	No	High	No	Yes	<ul style="list-style-type: none"> Heritage material found during the construction phase should be safeguarded and reported to SAHRA for possible recording and sampling by a professional archaeologist. 	Low	4
		Kenhardt PV 1b (Alternative)	Negative	Construction Phase	Site	Permanent	Moderate	Likely	Low	No	High	No	Yes	<ul style="list-style-type: none"> Heritage material found during the construction phase should be safeguarded and reported to SAHRA for possible recording and sampling by a professional archaeologist. 	Low	4
Visual																
Visual intrusion of the project during construction, operation and decommissioning (including night lighting)	Transformed visual landscape	Kenhardt PV 1 (Preferred)	Negative	Construction, Operations and Decommissioning Phases	Regional	Medium Term for Construction and Decommissioning Phase, Long-term for Operational Phase	Substantial	Likely	Moderate	Yes	Low	No	Yes	<ul style="list-style-type: none"> During the construction phase, undertake vegetation removal in a systematic, sequential manner, in order to avoid bare soil for long periods. During the operational phase, painted structures should be maintained. 	Low	4
		Kenhardt PV 1b (Alternative)	Negative	Construction, Operations and Decommissioning Phases	Regional	Medium Term for Construction and Decommissioning Phase, Long-term for Operational Phase	Substantial	Likely	Moderate	Yes	Low	No	Yes	<ul style="list-style-type: none"> During the construction phase, undertake vegetation removal in a systematic, sequential manner, in order to avoid bare soil for long periods. During the operational phase, painted structures should be maintained. 	Low	4

Copyright 2015 © CSIR - ADDENDUM TO SCOPING REPORT
Page 10

4. CONCLUSION

Based on the above assessment, the preferred site for the project on the Remaining Extent of the Onder Rugzeer Farm 168 is the **Kenhardt PV 1** site. Whilst the impact significance ratings do not differ between the preferred and alternative sites, the preferred site will be selected for assessment in the EIA Phase based on the following:

- The alternative Kenhardt PV 1b site is located too far south from the Eskom Nieuwehoop Substation, which therefore significantly reduces the financial viability of the proposed project as additional costs are required for longer transmission lines. Longer power lines may also result in additional environmental impacts. Therefore, the closer the site is to the Eskom Nieuwehoop Substation will reduce potential economic and environmental impacts, and improve the feasibility of the proposed project.
- The alternative site is located closer to the landowner's residence, therefore it would be better to locate the proposed PV facility a greater distance from the farm house (i.e. at the preferred site) to enable a certain level of privacy.
- The alternative site lies closer to the main public road (i.e. R383), resulting in safety concerns, higher visual intrusion on the sense of place and increased risk of theft during the construction and operational phases.

Furthermore, as noted above, layout alternatives for the project within the preferred site will be determined following the input from the various specialist studies to be undertaken as part of the EIA Phase (the Terms of Reference for these studies are included in Chapter 8 of the Scoping Report). The studies will aim to identify various environmental sensitivities present on the preferred sites that should be avoided, which will be taken into account during the determination of the proposed layout of the PV facility.

5. REFERENCES

Intergovernmental Panel on Climate Change (IPCC). 2014. Climate Change 2014: Impacts, Adaptation, and Vulnerability. Part A: Global and Sectoral Aspects. Contribution of Working Group II to the Fifth Assessment Report of the Intergovernmental Panel on Climate Change [Field, C.B., V.R. Barros, D.J. Dokken, K.J. Mach, M.D. Mastrandrea, T.E. Bilir, M. Chatterjee, K.L. Ebi, Y.O. Estrada, R.C. Genova, B. Girma, E.S. Kissel, A.N. Levy, S. MacCracken, P.R. Mastrandrea, and L.L. White (eds.)]. Cambridge: Cambridge University Press.

Comment and Registration Form sent with Email 3 on 6 October 2015

BASIC ASSESSMENT AND SCOPING AND ENVIRONMENTAL IMPACT ASSESSMENT (EIA) FOR THE PROPOSED DEVELOPMENT OF THREE SOLAR PHOTOVOLTAIC FACILITIES AND ASSOCIATED ELECTRICAL INFRASTRUCTURE NORTH-EAST OF KENHARDT, NORTHERN CAPE PROVINCE (KENHARDT PV 1, KENHARDT PV 2, KENHARDT PV 3, KENHARDT PV 1 – TRANSMISSION LINE, KENHARDT PV 2 – TRANSMISSION LINE, AND KENHARDT PV 3 – TRANSMISSION LINE)

RELEASE OF ADDENDUM TO THE SCOPING REPORTS FOR KENHARDT PV 1, KENHARDT PV 2, KENHARDT PV 3

CSIR REFERENCE: EMS0102/SCATEC/2015

Project Applicant: Scatec Solar SA 330 (PTY) Ltd, Scatec Solar SA 350 (PTY) Ltd, and Scatec Solar SA 370 (PTY) Ltd

COMMENT AND REGISTRATION FORM

6 October 2015

Name:	Telephone:
Organisation:	Fax:
Designation:	Email:
Physical address:	Postal address:

Please indicate if you would like to register as an Interested and Affected Party (I&AP) for the proposed projects. Registration is required in order to receive further correspondence during the Basic Assessment and Scoping and EIA Processes. Please tick the appropriate box.

YES
NO

Please indicate if you have any interest (business, financial, personal or other) in the proposed projects and/or the Applications for Environmental Authorisation:

Please describe any issues or concerns you may have regarding the proposed projects, which you think should be considered during the Basic Assessment and Scoping and EIA Processes.

Please provide details of any other individuals or organisations that should be registered as I&APs:

Please complete this Comment and Registration Form by 5 November 2015 and submit it to:

Rohaida Abed
CSIR
Postal Address: P. O. Box 17001, Congella, Durban, 4013
Tel: 031 242 2300
Fax: 031 261 2500
E-mail: RAbed@csir.co.za
Project Website: <http://www.csir.co.za/eia/ScatecSolarPV/>



Proof of Correspondence with DEA (Courier Waybills and Receipt of Hard Copy and CD copy of the Addendum to the Scoping Report, sent with a Cover Letter and Comment and Registration Form)



[English](#) [Contact Center](#) [Country Profile](#) [DHL Global](#)

Track DHL Express Shipments

Here's the fastest way to check the status of your shipment. No need to call Customer Service – our online results give you real-time, detailed progress as your shipment speeds through the DHL network.

Result Summary

Waybill: 1592493383
Signed for by: MOROTOLA
Get Signature Proof of Delivery

Wednesday, October 07, 2015 at 09:15
Origin Service Area:
DURBAN - GLENWOOD - SOUTH AFRICA
Destination Service Area:
PRETORIA - PRETORIA - SOUTH AFRICA

1 Piece

Wednesday, October 07, 2015		Location	Time	Piece
9	Delivered - Signed for by : MOROTOLA	PRETORIA	09:15	1 Piece
8	With delivery courier	PRETORIA - SOUTH AFRICA	07:29	1 Piece
7	Arrived at Delivery Facility in PRETORIA - SOUTH AFRICA	PRETORIA - SOUTH AFRICA	06:02	1 Piece
6	Departed Facility in JOHANNESBURG - SOUTH AFRICA	JOHANNESBURG - SOUTH AFRICA	05:22	1 Piece
5	Processed at JOHANNESBURG - SOUTH AFRICA	JOHANNESBURG - SOUTH AFRICA	05:20	1 Piece
4	Arrived at Sort Facility JOHANNESBURG - SOUTH AFRICA	JOHANNESBURG - SOUTH AFRICA	03:59	1 Piece
Tuesday, October 06, 2015		Location	Time	Piece
3	Departed Facility in DURBAN - SOUTH AFRICA	DURBAN - SOUTH AFRICA	19:52	1 Piece
2	Processed at DURBAN - SOUTH AFRICA	DURBAN - SOUTH AFRICA	19:52	1 Piece
1	Shipment picked up	DURBAN - SOUTH AFRICA	16:56	1 Piece

If you would prefer to speak to someone personally about the location of your shipment, please contact DHL Express Customer Service.

[Terms & Conditions](#)
[Tracking FAQs](#)

Deutsche Post DHL Group



[English](#) [Contact Center](#) [Country Profile](#) [DHL Global](#)

Track DHL Express Shipments

Here's the fastest way to check the status of your shipment. No need to call Customer Service – our online results give you real-time, detailed progress as your shipment speeds through the DHL network.

Result Summary

Waybill: 1592516166
Signed for by: MOROTOLA
Get Signature Proof of Delivery

Wednesday, October 07, 2015 at 09:15
Origin Service Area:
DURBAN - GLENWOOD - SOUTH AFRICA
Destination Service Area:
PRETORIA - PRETORIA - SOUTH AFRICA

1 Piece

Wednesday, October 07, 2015		Location	Time	Piece
9	Delivered - Signed for by : MOROTOLA	PRETORIA	09:15	1 Piece
8	With delivery courier	PRETORIA - SOUTH AFRICA	07:29	1 Piece
7	Arrived at Delivery Facility in PRETORIA - SOUTH AFRICA	PRETORIA - SOUTH AFRICA	06:02	1 Piece
6	Departed Facility in JOHANNESBURG - SOUTH AFRICA	JOHANNESBURG - SOUTH AFRICA	05:22	1 Piece
5	Processed at JOHANNESBURG - SOUTH AFRICA	JOHANNESBURG - SOUTH AFRICA	05:20	1 Piece
4	Arrived at Sort Facility JOHANNESBURG - SOUTH AFRICA	JOHANNESBURG - SOUTH AFRICA	03:59	1 Piece
Tuesday, October 06, 2015		Location	Time	Piece
3	Departed Facility in DURBAN - SOUTH AFRICA	DURBAN - SOUTH AFRICA	19:52	1 Piece
2	Processed at DURBAN - SOUTH AFRICA	DURBAN - SOUTH AFRICA	19:52	1 Piece
1	Shipment picked up	DURBAN - SOUTH AFRICA	16:56	1 Piece

If you would prefer to speak to someone personally about the location of your shipment, please contact DHL Express Customer Service.

[Terms & Conditions](#)
[Tracking FAQs](#)

Deutsche Post DHL Group



English Contact Center Country Profile DHL Global

Track DHL Express Shipments

Here's the fastest way to check the status of your shipment. No need to call Customer Service – our online results give you real-time, detailed progress as your shipment speeds through the DHL network.

Result Summary

Waybill: 1592535066	Wednesday, October 07, 2015 at 09:15	1 Piece
Signed for by: MOROTOLA	Origin Service Area: DURBAN - GLENWOOD - SOUTH AFRICA	
Get Signature Proof of Delivery	Destination Service Area: PRETORIA - PRETORIA - SOUTH AFRICA	

Wednesday, October 07, 2015		Location	Time	Piece
9	Delivered - Signed for by : MOROTOLA	PRETORIA	09:15	1 Piece
8	With delivery courier	PRETORIA - SOUTH AFRICA	07:29	1 Piece
7	Arrived at Delivery Facility in PRETORIA - SOUTH AFRICA	PRETORIA - SOUTH AFRICA	06:02	1 Piece
6	Departed Facility in JOHANNESBURG - SOUTH AFRICA	JOHANNESBURG - SOUTH AFRICA	05:22	1 Piece
5	Processed at JOHANNESBURG - SOUTH AFRICA	JOHANNESBURG - SOUTH AFRICA	05:20	1 Piece
4	Arrived at Sort Facility JOHANNESBURG - SOUTH AFRICA	JOHANNESBURG - SOUTH AFRICA	03:59	1 Piece
Tuesday, October 06, 2015		Location	Time	Piece
3	Departed Facility in DURBAN - SOUTH AFRICA	DURBAN - SOUTH AFRICA	19:52	1 Piece
2	Processed at DURBAN - SOUTH AFRICA	DURBAN - SOUTH AFRICA	19:52	1 Piece
1	Shipment picked up	DURBAN - SOUTH AFRICA	16:56	1 Piece

If you would prefer to speak to someone personally about the location of your shipment, please contact DHL Express Customer Service.

[Terms & Conditions](#)
[Tracking FAQs](#)



Follow-up Reminder Email sent to I&APs and Stakeholders on 26 October 2015 during the 30-day review of the Scoping Report and Addendum

From: Rohaida Abed
To: Abed, Rohaida
BC Clive.Stephenson@transnet.net; CloeteS@dws.gov.za; GeerinJH@eskom.co.za; Gilbert.Nortier@transnet.net; HaarhL@eskom.co.za; JacolineMa@daff.gov.za; Laurie, Surina; LeaskK@eskom.co.za; MRabothata@environment.gov.za; Marina.Lourens@transnet.net; MashuduMa@daff.gov.za; Mayvyn.Bhana@transnet.net; MeiM@dwa.gov.za; MelanieM@L2B.co.za; ThokoB@daff.gov.za; WyngaaJO@eskom.co.za; aditeme@agri.ncape.gov.za; admin@grasslands.org.za; advocacy@birdlife.org.za; ameliastrauss2@gmail.com; andre.vanniekerk10@gmail.com; annelizac@nda.agric.za; atiplady@ska.ac.za; boozahunter@yahoo.com; claude@veroniva.co.za; ernest.connan@donco.co.za; fpr@bodr.gov.za; hendri@aheadtrading.co.za; jdbhenrohn@gmail.com; jhjs@webmail.co.za; karen@mulilo.com; klawrence@trpw.ncape.gov.za; kraaines@mweb.co.za; l.ntsolo@sanbi.org.za; marcyroxnpc@gmail.com; messop@environment.gov.za; mitchell.hodgson@scatecsolar.com; mm@kaigarib.gov.za; mmathews@ncpg.gov.za; mndzilili@ncpg.gov.za; monica.lepheane@labour.gov.za; ncagric@worldonline.co.za; nhlakad@daff.gov.za; nyaphi@ncpg.gov.za; ontvangs@agrink.co.za; peter.buys@nersa.org.za; ratha.timothy@gmail.com; rwarie@ncpg.gov.za; sb@siyanda.gov.za; sdelafontaine@gmail.com; sharon@nocci.co.za; smbanjwa@ncpg.gov.za; straussdj@orientis.co.za; strohl@caa.co.za; teresascheepers@vodamail.co.za; townsendmorgan029@gmail.com; waltjc@nra.co.za; wep@ewt.org.za
Date: 26/10/2015 14:09
Subject: Re: Release of Addendum to Scoping Reports - Solar PV Facilities and Associated Electrical Infrastructure, Northern Cape

Dear Stakeholders and Interested and Affected Parties

The email correspondence sent on 23 September 2015 regarding the release of the Scoping Reports for the Kenhardt PV 1, Kenhardt PV 2 and Kenhardt PV 3 projects, as well as the email correspondence sent on 6 October 2015 (as shown below) regarding the release of the addendum to the aforementioned Scoping Reports, have reference.

This is a reminder that the comment period for the Scoping Reports and addendum closes on 27 October 2015 and 5 November 2015 respectively.

As noted in the email correspondence sent on 23 September 2015 and 6 October 2015, the reports available for comment can be accessed from the project website: <http://www.csir.co.za/eia/ScatecSolarPV/>

Thank you and kind regards,

Rohaida Abed
CSIR - Environmental Management Services
P. O. Box 17001, Congella, Durban, 4013
Tel: 031 242 2300
Fax: 031 261 2509
Email: RAbed@csir.co.za

>>> Rohaida Abed 06/10/2015 16:25 >>>

Dear Stakeholders and Interested and Affected Parties

NOTICE OF RELEASE OF AN ADDENDUM TO THE SCOPING REPORTS FOR THE PROPOSED DEVELOPMENT OF THREE SOLAR PHOTOVOLTAIC (PV) FACILITIES (REFERRED TO AS KENHARDT PV 1, KENHARDT PV 2, AND KENHARDT PV 3) ON THE REMAINING EXTENT OF ONDER RUGZEER FARM 168, NORTH-EAST OF KENHARDT, NORTHERN CAPE PROVINCE

Competent Authority: National Department of Environmental Affairs

CSIR REFERENCE: EMS0102/SCATEC/2015

This e-mail correspondence serves to inform you of the release of an Addendum to the Scoping Reports for the three proposed 75 Megawatt (MW) Solar Photovoltaic (PV) power generation facilities, located on the remaining extent of Onder Rugzeer Farm 168, approximately 80 km south of Upington and 30 km north-east of Kenhardt within the !Kheis Local Municipality, Northern Cape Province. The proposed 75 MW Solar PV projects are referred to as: Kenhardt PV 1, Kenhardt PV 2 and Kenhardt PV 3 respectively. The Project Applicant is Scatec Solar SA 330 (PTY) Ltd for Kenhardt PV 1, Scatec Solar SA 350 (PTY) Ltd for Kenhardt PV 2 and Scatec Solar SA 370 (PTY) Ltd for Kenhardt PV 3.

As you are aware, in terms of the National Environmental Management Act (Act 107 of 1998, as amended) (NEMA) and the 2014 NEMA Environmental Impact Assessment (EIA) Regulations promulgated in Government Gazette 38282 and Government Notice (GN) R982, R983, R984 and R985 on 8 December 2014, a full Scoping and EIA Process is required for the construction of the three Solar PV facilities. A separate Basic Assessment Process will be undertaken for the development of the proposed transmission lines, associated electrical infrastructure and connection to the Eskom Nieuwehoop Substation (which is currently being constructed) on the remaining extent of Portion 3 of Gemsbok Bult Farm 120. The CSIR has been appointed by the Project Applicant to undertake the separate requisite Basic Assessment, and Scoping and EIA Processes for the proposed projects.

As a registered Interested and Affected Party (I&AP) on the project database, you were notified on 23 September 2015 via email and registered mail of the release of the Scoping Reports for the Kenhardt PV 1, Kenhardt PV 2 and Kenhardt PV 3 projects for a 30-day review period, which extends from 25 September 2015 to 27 October 2015.

However, a pre-application meeting was held with the National Department of Environmental Affairs (DEA) on 17 September 2015 to discuss the proposed projects and requirements for the Basic Assessment, and Scoping and EIA Phases. The CSIR compiled notes of the pre-application meeting and submitted it to the DEA on 23 September 2015 for review and acceptance. Due to the fact that no significant issues were raised during the pre-application meeting that was not addressed in the Scoping Reports for the proposed projects, the Scoping Reports were sent out for public comment for 30 days as noted above.

Subsequent to this, the DEA provided comments on the meeting notes and approval thereof via email on 1 October 2015. As part of the comments received on the meeting notes, the DEA recommended that specialist studies should be included with the Scoping Report, which needs to be site specific (in terms of the applicable alternatives that have been considered in the Scoping Phase). As such, the CSIR has compiled an addendum to the Scoping Report for the Kenhardt PV 1, Kenhardt PV 2 and Kenhardt PV 3 projects in order to provide the additional information, as per the DEA's request. It should be noted that the CSIR project team has undertaken the assessment of alternatives based on desktop literature, previous experience of working on Solar PV facilities and the specialist studies undertaken for the proposed Nieuwehoop Solar Development located adjacent to this proposed project.

It is important to note that the Addendums do not present any new information that has not been used in the compilation of the Scoping Reports but serves to provide the DEA and I&APs with a more detailed assessment of how the preferred site location was determined.

In line with the above, as a registered I&AP on the project database, you are hereby notified of the release of the Addendum to the Scoping Reports for the Kenhardt PV 1, Kenhardt PV 2 and Kenhardt PV 3 projects to all registered I&APs and stakeholders for a 30-day review period, which will extend from **6 October 2015 to 5 November 2015**.

Please find attached the following:

- Kenhardt PV 1 Addendum to the Scoping Report;
- Kenhardt PV 2 Addendum to the Scoping Report;
- Kenhardt PV 3 Addendum to the Scoping Report; and a
- Comment and Registration Form to facilitate the commenting process.

The above-mentioned project information can be accessed at the following website:
<http://www.csir.co.za/eia/ScatecSolarPV/>

Kindly ensure that all comments are submitted to the CSIR Project Manager (details provided below) by **5 November 2015**.

Thank you and kind regards,

Rohaida Abed
CSIR - Environmental Management Services
P. O. Box 17001, Congella, Durban, 4013
Tel: 031 242 2300
Fax: 031 261 2509
Email: RAbed@csir.co.za























Proof of Delivery of the Reminder Email sent to all I&APs on 26 October 2015

Page 1 of 3

Message Id: 562E17F4.9A5 : 179 : 65115
 Subject: Re: Release of Addendum to Scoping Reports - Solar PV Facilities and Associated Electrical Infrastructure, Northern Cape
 Created By: RAbed@eslr.co.za
 Scheduled Date:
 Creation Date: 26/10/2015 14:09
 From: Rohalda Abed

Recipients:

Recipient	Action	Date & Time	Comment
agrincape.gov.za	Transferred	26/10/2015 14:09	
BC: aditeme@agrincape.gov.za(aditeme@agrincape.gov.za)	Delivered	26/10/2015 14:12	
agrlnk.co.za	Transferred	26/10/2015 14:09	
BC: onbvangs@agrlnk.co.za(onbvangs@agrlnk.co.za)	Delivered	26/10/2015 14:27	
aheadtrading.co.za	Transferred	26/10/2015 14:09	
BC: hendri@aheadtrading.co.za(hendri@aheadtrading.co.za)	Delivered	26/10/2015 14:13	
birdlife.org.za	Transferred	26/10/2015 14:09	
BC: advocacy@birdlife.org.za(advocacy@birdlife.org.za)	Delivered	26/10/2015 14:12	
bodr.gov.za	Transferred	26/10/2015 14:09	
BC: fpr@bodr.gov.za(fpr@bodr.gov.za)	Undeliverable	26/10/2015 14:12	
caa.co.za	Transferred	26/10/2015 14:09	
BC: strohl@caa.co.za(strohl@caa.co.za)	Delivered	26/10/2015 14:14	
daff.gov.za	Transferred	26/10/2015 14:09	
BC: JacquelineMa@daff.gov.za(JacolineMa@daff.gov.za)	Delivered	26/10/2015 14:15	
BC: MashuduMa@daff.gov.za(MashuduMa@daff.gov.za)	Delivered	26/10/2015 14:15	
BC: nhlakad@daff.gov.za(nhlakad@daff.gov.za)	Delivered	26/10/2015 14:15	
BC: ThokoB@daff.gov.za(ThokoB@daff.gov.za)	Delivered	26/10/2015 14:15	
donco.co.za	Transferred	26/10/2015 14:09	
BC: ernest.connan@donco.co.za(ernest.connan@donco.co.za)	Delivered	26/10/2015 14:14	
dwa.gov.za	Transferred	26/10/2015 14:09	
BC: MelM@dwa.gov.za(MelM@dwa.gov.za)	Delivered	26/10/2015 14:14	
dws.gov.za	Transferred	26/10/2015 14:09	
BC: CloeteS@dws.gov.za(CloeteS@dws.gov.za)	Delivered	26/10/2015 14:14	
environment.gov.za	Transferred	26/10/2015 14:09	
BC: messop@environment.gov.za(messop@environment.gov.za)	Delivered	26/10/2015 14:14	
BC: MRabothata@environment.gov.za(MRabothata@environment.gov.za)	Delivered	26/10/2015 14:14	
eskom.co.za	Transferred	26/10/2015 14:09	
BC: GeertJH@eskom.co.za(GeertJH@eskom.co.za)	Delivered	26/10/2015 14:14	
BC: HaamL@eskom.co.za(HaamL@eskom.co.za)	Delivered	26/10/2015 14:14	
BC: LeaskK@eskom.co.za(LeaskK@eskom.co.za)	Delivered	26/10/2015 14:14	
BC: WymgaaJ@eskom.co.za(WymgaaJ@eskom.co.za)	Delivered	26/10/2015 14:14	
ewt.org.za	Transferred	26/10/2015 14:09	
BC: wep@ewt.org.za(wep@ewt.org.za)	Delivered	26/10/2015 14:28	
gmail.com	Transferred	26/10/2015 14:09	
BC: amelastraus2@gmail.com(ameilastraus2@gmail.com)	Delivered	26/10/2015 14:15	
BC: andre.vanniekerk10@gmail.com(andre.vanniekerk10@gmail.com)	Delivered	26/10/2015 14:15	
BC: jdbhenrohn@gmail.com(jdbhenrohn@gmail.com)	Delivered	26/10/2015 14:15	
BC: marcyroxpc@gmail.com(marcyroxpc@gmail.com)	Delivered	26/10/2015 14:15	
BC: ratha.limothy@gmail.com(ratha.limothy@gmail.com)	Delivered	26/10/2015 14:15	
BC: sdelafontaine@gmail.com(sdelafontaine@gmail.com)	Delivered	26/10/2015 14:15	
BC: townsendmorgan029@gmail.com(townsendmorgan029@gmail.com)	Delivered	26/10/2015 14:15	
grasslands.org.za	Transferred	26/10/2015 14:09	
BC: admin@grasslands.org.za(admin@grasslands.org.za)	Delivered	26/10/2015 14:14	
kalgarib.gov.za	Transferred	26/10/2015 14:09	
BC: mm@kalgarib.gov.za(mm@kalgarib.gov.za)			
L2B.co.za	Transferred	26/10/2015 14:09	
BC: MelanieM@L2B.co.za(MelanieM@L2B.co.za)	Delivered	26/10/2015 14:14	

 labour.gov.za	Transferred	25/10/2015 14:09	
BC: monica.lepheane@labour.gov.za(monica.lepheane@labour.gov.za)	Delivered	25/10/2015 14:13	
 mullo.com	Transferred	25/10/2015 14:09	
BC: karen@mullo.com(karen@mullo.com)	Delivered	25/10/2015 14:13	
 mweb.co.za	Transferred	25/10/2015 14:09	
BC: kraalines@mweb.co.za(kraalines@mweb.co.za)	Delivered	25/10/2015 14:13	
 ncpg.gov.za	Transferred	25/10/2015 14:09	
BC: mmatthews@ncpg.gov.za(mmatthews@ncpg.gov.za)	Delivered	25/10/2015 14:15	
BC: mndzili@ncpg.gov.za(mndzili@ncpg.gov.za)	Delivered	25/10/2015 14:15	
BC: nyaphi@ncpg.gov.za(nyaphi@ncpg.gov.za)	Delivered	25/10/2015 14:15	
BC: rwarie@ncpg.gov.za(rwarie@ncpg.gov.za)	Delivered	25/10/2015 14:15	
BC: smbanjwa@ncpg.gov.za(smbanjwa@ncpg.gov.za)	Delivered	25/10/2015 14:15	
 nda.agric.za	Transferred	25/10/2015 14:09	
BC: annelzaco@nda.agric.za(annelzaco@nda.agric.za)	Delivered	25/10/2015 14:11	
 nersa.org.za	Transferred	25/10/2015 14:09	
BC: peter.buys@nersa.org.za(peter.buys@nersa.org.za)	Delivered	25/10/2015 14:17	
 nocci.co.za	Transferred	25/10/2015 14:09	
BC: sharon@nocci.co.za(sharon@nocci.co.za)			
 nra.co.za	Transferred	25/10/2015 14:09	
BC: walt@nra.co.za(walt@nra.co.za)	Delivered	25/10/2015 14:11	
 orientis.co.za	Transferred	25/10/2015 14:09	
BC: straussj@orientis.co.za(straussj@orientis.co.za)	Delivered	25/10/2015 14:11	
 POBOX1.DURBAN	Delivered	25/10/2015 14:09	
To: Rohaida Abedi(RAbedi@csir.co.za)	Read	25/10/2015 14:09	
 POBOX1.STELLBOS	Delivered	25/10/2015 14:09	
BC: Surina Laurie(SLaurie@csir.co.za)	Third-Party Downloaded Read	25/10/2015 14:09 25/10/2015 14:23	
 sanbi.org.za	Transferred	25/10/2015 14:09	
BC: Inbiso@sanbi.org.za(Inbiso@sanbi.org.za)	Undeliverable	25/10/2015 14:10	
 scatecsolar.com	Transferred	25/10/2015 14:09	
BC: mitchell.hodgson@scatecsolar.com(mitchell.hodgson@scatecsolar.com)			
 slyanda.gov.za	Transferred	25/10/2015 14:09	
BC: sb@slyanda.gov.za(sb@slyanda.gov.za)			
 ska.ac.za	Transferred	25/10/2015 14:09	
BC: atipiady@ska.ac.za(atipiady@ska.ac.za)	Delivered	25/10/2015 14:10	
 transnet.net	Transferred	25/10/2015 14:09	
BC: Clive.Stephenson@transnet.net(Clive.Stephenson@transnet.net)	Delivered	25/10/2015 14:11	
 transnet.net	Transferred	25/10/2015 14:09	
BC: Gilbert.Nortier@transnet.net(Gilbert.Nortier@transnet.net)	Delivered	25/10/2015 14:11	
BC: Marina.Lourens@transnet.net(Marina.Lourens@transnet.net)	Delivered	25/10/2015 14:11	
BC: Mayvyn.Bhana@transnet.net(Mayvyn.Bhana@transnet.net)	Delivered	25/10/2015 14:11	
 tpw.ncape.gov.za	Transferred	25/10/2015 14:09	
BC: kiawrence@tpw.ncape.gov.za(kiawrence@tpw.ncape.gov.za)	Undeliverable	25/10/2015 14:10	
 veroniva.co.za	Transferred	25/10/2015 14:09	
BC: claude@veroniva.co.za(claude@veroniva.co.za)	Delivered	25/10/2015 14:10	
 vodamail.co.za	Transferred	25/10/2015 14:09	
BC: teresascheepers@vodamail.co.za(teresascheepers@vodamail.co.za)	Delivered	25/10/2015 14:12	2.0.0 recipients expanded
 webmail.co.za	Transferred	25/10/2015 14:09	
BC: jhs@webmail.co.za(jhs@webmail.co.za)	Transferred	25/10/2015 14:40	2.0.0 message relayed
 worldonline.co.za	Transferred	25/10/2015 14:09	
BC: ncagric@worldonline.co.za(ncagric@worldonline.co.za)	Delivered	25/10/2015 14:14	
 yahoo.com	Transferred	25/10/2015 14:09	
BC: boozahunter@yahoo.com(boozahunter@yahoo.com)	Delivered	25/10/2015 14:11	

Post Office	Delivered	Route
agri.ncape.gov.za		agri.ncape.gov.za
agrlnk.co.za		agrlnk.co.za
aheadtrading.co.za		aheadtrading.co.za
birdlife.org.za		birdlife.org.za
bodr.gov.za		bodr.gov.za
caa.co.za		caa.co.za
daff.gov.za		daff.gov.za
donco.co.za		donco.co.za
dwa.gov.za		dwa.gov.za
dws.gov.za		dws.gov.za
environment.gov.za		environment.gov.za
eskom.co.za		eskom.co.za
ewt.org.za		ewt.org.za
gmail.com		gmail.com
grasslands.org.za		grasslands.org.za
kalgarib.gov.za		kalgarib.gov.za
LAB.co.za		LAB.co.za
labour.gov.za		labour.gov.za
muflo.com		muflo.com
mweb.co.za		mweb.co.za
nccpg.gov.za		nccpg.gov.za
nda.agric.za		nda.agric.za
nersa.org.za		nersa.org.za
noccl.co.za		noccl.co.za
nra.co.za		nra.co.za
orientis.co.za		orientis.co.za
POBOX1.DURBAN	26/10/2015 14:09	csir.co.za
POBOX1.STELLBOS	26/10/2015 14:09	csir.co.za
sanbi.org.za		sanbi.org.za
scalecsolar.com		scalecsolar.com
siyanda.gov.za		siyanda.gov.za
ska.ac.za		ska.ac.za
transnet.net		transnet.net
transnet.net		transnet.net
tpw.ncape.gov.za		tpw.ncape.gov.za
veroniva.co.za		veroniva.co.za
vodamail.co.za		vodamail.co.za
webmail.co.za		webmail.co.za
worldonline.co.za		worldonline.co.za
yahoo.com		yahoo.com

File	Size	Date & Time
MESSAGE	8896	26/10/2015 14:09
TEXT.htm	19347	26/10/2015 14:09

Options
 Auto Delete: No
 Concealed Subject: No
 Expiration Date: None
 Notify Recipients: Yes
 Priority: Standard
 Reply requested by: None
 Security: Standard
 To Be Delivered: Immediate

Record Id
 Record Id: 562E3414.DURBAN.POB0X1.100.1155D37.1.D5E4.1
 Common Record Id: 562E3414.DURBAN.POB0X1.200.2000093.1.3306F.1

Response and Follow-up Emails sent to I&APs and Stakeholders during the 30-day review of the Scoping Report and Addendum

Rohaida Abed - RE: Release of Scoping Reports - Solar PV Facilities and Associated Electrical Infrastructure, Northern Cape

From: Rohaida Abed
To: SLD, Marina Lourens Transnet Freight Rail
Date: 22/10/2015 17:06
Subject: RE: Release of Scoping Reports - Solar PV Facilities and Associated Electrical Infrastructure, Northern Cape
CC: Gilbert.Nortier@transnet.net
Attachments: Kenhardt PV1.pdf; Kenhardt PV2.pdf; Kenhardt PV3.pdf

Dear Marina

I trust that you are well. As requested, please find attached three separate maps showing the TFR access road and the proposed project area. As noted in the trailing email, the Scoping Reports are available on the project website: <http://www.csir.co.za/eia/ScatecSolarPV/>

Thanks and kind regards,
Rohaida

>>> "Marina Lourens Transnet Freight Rail SLD" <Marina.Lourens@transnet.net> 25/09/2015 07:42
>>>

Please send us three different drawings as this is 3 separate applications

From: Gilbert Nortier Transnet Freight Rail PLZ
Sent: 24 September 2015 06:03 PM
To: Marina Lourens Transnet Freight Rail SLD
Subject: FW: Release of Scoping Reports - Solar PV Facilities and Associated Electrical Infrastructure, Northern Cape

Hi Marina

3 separate applications, please request drawings indicating TFR assets

Thanks

Gilbert



G.G. Nortier DEM (IOL)
 (022) 703 3521 083 407 7924
 (022) 703 3494 Gilbert.Nortier@transnet.net

Scoping and Environmental Impact Assessment for the proposed Development of a 75 MW Solar Photovoltaic Facility (KENHARDT PV 1) on the remaining extent of Onder Rugzeer Farm 168, north-east of Kenhardt, Northern Cape Province

From: Surina Laurie
To: Rohaida Abed
Date: 28/10/2015 10:13
Subject: Fwd: Re: DEA Reference number

FYI

>>> "LToolsBernado" <ltoolsbernado@ncpg.gov.za> 28/10/2015 08:39 >>>

Thank You

Regards
Luzane

>>> "Surina Laurie" <SLaurie@csir.co.za> 10/27/2015 10:16 AM >>>

Dear Luzane

We finally received it, please see attached.

Regards,

Surina

Surina Laurie (Pr. Sci. Nat. Environmental Science)
Senior Environmental Assessment Practitioner
CSIR - Environmental Management Services
11 Jan Celliers Street, Stellenbosch
PO Box 320, Stellenbosch, 7599

Tel: 021 888 2490
Cell: 082 468 0962
Fax: 021 888 2693
Email: slaurie@csir.co.za

>>> Surina Laurie 14/10/2015 08:40 >>>

Dear Luzane

We still have not received it, I will send it to you, once received.

Regards

Surina

Surina Laurie (Pri. Sci. Nat. Environmental Science)
Senior Environmental Assessment Practitioner
CSIR - Environmental Management Services
11 Jan Celliers Street, Stellenbosch
PO Box 320, Stellenbosch, 7599

Tel: 021 888 2490
Cell: 082 468 0962
Fax: 021 888 2693
Email: slaurie@csir.co.za

>>> "LToolsBernado" <ltoolsbernado@ncpg.gov.za> 12/10/2015 08:21 >>>

Dear Ms Laurie

Regarding our telephonic conversation on the 06th October 2015, The Dept of Environment and Nature Conservation is still waiting for the DEA Ref number of the following project Description

Scoping and Environmental Impact Assessment for the proposed Development of a 75MW Solar Photovoltaic Facility (KENHARDT PV 1) on the remaining extent of Onder Rugzeer Farm 168, north-east of Kenhardt, Northern Cape Province.

Please do send the DEA Ref Number as we need to Acknowledge the document.

Kind Regards
Luzane Tools-Bernado
EIA: Administration

Scoping and Environmental Impact Assessment for the proposed Development of a 75 MW Solar Photovoltaic Facility (KENHARDT PV 1) on the remaining extent of Onder Rugzeer Farm 168, north-east of Kenhardt, Northern Cape Province

From: Rohaida Abed
To: (UPN), Mei Melinda
CC: Shaun, Cloete
Date: 30/10/2015 13:10
Subject: Re: FW: Hard Copies: Notice of BA and EIA Process - Solar PV Facilities and Associated Electrical Infrastructure, Northern Cape
Attachments: Globeflight_2714273929.pdf

Dear Melinda

I trust that you are well. I refer to the email below sent on 22 October 2015. Please note that hard copies and CD copies of the Scoping Reports were delivered to your offices (at the physical address noted below) on 1 October 2015 via courier (please see attached waybill). Please confirm if you have received the documents and if the DWS has any comments.

Thank you and kind regards,
Rohaida

>>> Rohaida Abed 22/10/2015 17:10 >>>
Dear Melinda

I trust that you are well. Please note that hard copies and CD copies of the Scoping Reports were delivered to your offices (at the physical address noted below) on 1 October 2015 via courier. Please confirm if you have received the documents and if the DWS has any comments.

Thank you and kind regards,
Rohaida

>>> "Mei Melinda (UPN)" <MeiM@dws.gov.za> 29/09/2015 14:25 >>>

Good Day Mr. Abed

Your notice received with regards to Basic Assessment; Scoping and Environmental Impact Assessment for the Proposed Development of the three Solar Photovoltaic Facilities and Associated Electrical Infrastructure; North-East of Kenhardt; Northern Cape is of reference. DWS requires you to forward hard copies of the above mentioned project to either of the following address:

Physical Address:
Department Of Water and Sanitation
Louisvale Road Upington
8801
OR

Postal Address:
Department Of Water and Sanitation
Private Bag X 5912
Upington
8800

Your co-operation and assistance is highly appreciated.

With kind regards,

Melinda Mei
Water Quality Management: Orange Proto-CMA
Tel: 054 338 5836
Fax: 054 334 0205

From: Mei Melinda (UPN)
Sent: 04 August 2015 01:39 PM
To: 'Rohaida Abed'
Cc: Cloete Shaun
Subject: Hard Copies: Notice of BA and EIA Process - Solar PV Facilities and Associated Electrical Infrastructure, Northern Cape
Importance: High

Good morning Mr. Abed

Your notice received with regards to Basic Assessment; Scoping and Environmental Impact Assessment for the Proposed Development of the three Solar Photovoltaic Facilities and Associated Electrical Infrastructure; North-East of Kenhardt; Northern Cape is of reference.

DWS requires you to forward hard copies of the above mentioned project to either of the following address:

Scoping and Environmental Impact Assessment for the proposed Development of a 75 MW Solar Photovoltaic Facility (KENHARDT PV 1) on the remaining extent of Onder Rugzeer Farm 168, north-east of Kenhardt, Northern Cape Province

Physical Address:
Department Of Water and Sanitation
Louisvale Road Upington
8801

OR

Postal Address:
Department Of Water and Sanitation
Private Bag X 5912
Upington
8800

Your co-operation and assistance is highly appreciated.

With kind regards,

Melinda Mei
Senior Administration Clerk
Water Quality Management: Lower Orange Water Management Area
Tel: 054 338 5836
Fax: 054 334 0205
Mail: MeiM@dwa.gov.za

From: Rohaida Abed [mailto:RAbed@csir.co.za]
Sent: 29 July 2015 04:01 PM
To: Rohaida Abed
Subject: Notice of BA and EIA Process - Solar PV Facilities and Associated Electrical Infrastructure, Northern Cape

Dear Stakeholders and Interested and Affected Parties

NOTICE OF BASIC ASSESSMENT AND SCOPING AND ENVIRONMENTAL IMPACT ASSESSMENT FOR THE PROPOSED DEVELOPMENT OF THREE SOLAR PHOTOVOLTAIC FACILITIES AND ASSOCIATED ELECTRICAL INFRASTRUCTURE NORTH-EAST OF KENHARDT, NORTHERN CAPE PROVINCE

Competent Authority: National Department of Environmental Affairs

CSIR Reference: EMS0102/SCATEC/2015

This e-mail correspondence serves to inform you of the initiation of a Basic Assessment (BA) Process and Scoping and Environmental Impact Assessment (EIA) Process for the above-mentioned proposed project, located approximately 80 km south of Upington and 30 km north-east of Kenhardt within the !Kheis Local Municipality, Northern Cape Province. The Project Applicant is Scatec Solar SA 163 (PTY) Ltd (hereinafter referred to as Scatec Solar). The CSIR has been appointed by Scatec Solar to undertake the required BA Process, and Scoping and EIA Process.

A full Scoping and EIA Process is required for the development of three 75 Megawatt (MW) Solar Photovoltaic (PV) power generation facilities on the remaining extent of Onder Rugzeer Farm 168. A separate BA Process is also required and will be undertaken for the development of three transmission lines and the connection points to the Eskom Nieuwehoop Substation (which is currently being constructed) on the remaining extent of Portion 3 of Gensbok Bult Farm 120.

The proposed 75 MW Solar PV facilities and transmission lines are located within the same geographical area and constitute the same type of activity; hence an integrated Public Participation Process will be undertaken. However, separate Applications for Environmental Authorisation will be lodged with the National Department of Environmental Affairs (DEA) for each proposed 75 MW Solar PV facility and transmission line. Furthermore, separate BA, Scoping and EIA Reports will be compiled for each project, which will be referred to as:

Scoping and EIA Processes: Proposed 75 MW Solar PV Facilities	BA Processes: Proposed 132 kV Transmission Lines
- Kenhardt PV 1	- Kenhardt PV 1 – Transmission Line
- Kenhardt PV 2	- Kenhardt PV 2 – Transmission Line
- Kenhardt PV 3	- Kenhardt PV 3 – Transmission Line

The proposed projects are being assessed in terms of the National Environmental Management Act (Act 107 of 1998), as amended (NEMA), and the NEMA EIA Regulations, published in Government Notice (GN) R982, R983, R984 and R985 on 8 December 2014.

Please find attached the following:
- Background Information Document (BID);
- Letter 1 to Interested & Affected Parties (I&APs); and
- Comment and Registration Form.

The BID, which provides an overview of the proposed project, is being released to Stakeholders and I&APs for a 30-day comment period extending from **30 July 2015** to **31 August 2015**.

Hard copies of the above-mentioned documents have also been sent to those of you for which postal addresses are available. In addition, the above-mentioned project information can be accessed at the following website: <http://www.csir.co.za/eia/ScatecSolarPV/>

Kindly ensure that all comments are submitted to the CSIR Project Manager (details provided below) by **31 August 2015**.

Thank you and kind regards,

Rohaida Abed

CSIR - Environmental Management Services
P. O. Box 17001, Congella, Durban, 4013
Tel: 031 242 2300
Fax: 031 261 2509
Email: RAbed@csir.co.za

Beste Belanghebbende en Geïnteresseerde Party

GESAMENTLIKE KENNISGEWING VAN BASIESE EN OMGEWINGSIMPAKEVALUERINGSPROSESSE VIR DIE VOORGESTELDE ONTWIKKELING VAN DRIE SONKRAGAANLEGTE EN ELEKTRIESE INFRASTRUKTUUR NOORD-OOS VAN KENHARDT, NOORD- KAAP PROVINSIE

Bevoegde Owerheid: Die Nasionale Departement van Omgewingsake

WNNR/CSIR verwysingsnommer: EMS0102/SCATEC/2015

Hierdie e-pos korrespondensie se doel is om u in kennis te stel van die Basiese evaluerings- en Bestek en Omgewingsimpakevalueringproses vir die bogenoemde projekte, wat 80 km suid van Upington en 30 km noord-oos van Kenhardt in die !Kheis munisipaliteit voorgestel word. Die Aansoeker vir die projek is Scatec Solar SA 163 (PTY) Ltd ("Scatec Solar"). Die WNNR is aangestel deur Scatec Solar om die Basiese evaluerings- en Bestek en Omgewingsimpakevalueringproses vir die bogenoemde projekte uit te voer.

'n Bestek en Omgewingsimpakevalueringproses word vereis vir elk van die drie 75 MW Fotovoltaïese (PV) sonkragfasiliteite wat op die plaas Restant van Onder Rugzeer 168 voorgestel word. Aparte Basiese evalueringprosesse word ook vereis vir die voorgestelde 132 kV kraglyne en die konneksiepunte aan die Eskom Nieuwehoop Substasie (wat tans gebou word) op die plaas Restant van Gedeelte 3 van Gembok Bult 120.

Aangesien die sonkragprojekte en die voorgestelde elektriese infrastruktuur in dieselfde geografiese area gebou gaan word en dieselfde tipe projekte is, word dit voorgestel dat 'n geïntegreerde Publieke Deelname Proses gedoen gaan word. Aparte aansoeke gaan by die Nasionale Departement van Omgewingsake ingedien word vir die verskillende projekte en aparte verslae sal ook vir elke projek saamgestel en uitgestuur word. Die projekte sal na verwys word as:

Bestek en Omgewingsimpakevalueringproses: Voorgestelde drie 75 MW PV sonkragprojekte	Basiese evalueringprosesse: Voorgestelde drie 132 kV kraglyne
- Kenhardt PV 1	- Kenhardt PV 1 – Transmission Line
- Kenhardt PV 2	- Kenhardt PV 2 – Transmission Line
- Kenhardt PV 3	- Kenhardt PV 3 – Transmission Line

Die voorgestelde projekte sal ge-evalueer word volgens die Nasionale Omgewingsbeheer Wet, 1998 (Wet No 107 van 1998) (NEMA) en die Omgewingsimpakstudie (OIS) Regulasies soos gepubliseer in Staatskennisgewing R982 in Staatskoerant No 38282 van 08 Desember 2014.

Vind asseblief aangeheg die volgende:

- Beskrywing van die projek (word na verwys as die "BID")
- Brief aan die Belanghebbende en Geïnteresseerde Partye (B&GP'e)
- Kommentaar en Registrasievorm

Die BID, wat dien as agtergrond van die projek, bevat 'n beskrywing van die projek, die gelyste aktiwiteite en is vir 30-dae beskikbaar vir oorsig en kommentaar (**30 Julie 2015 - 31 Augustus 2015**). 'n Harde kopie van die bogenoemde dokumente is ook gestuur aan diegene vir wie ons posadresse het. Inligting van die projek is ook beskikbaar op die projekwebtuiste: <http://www.csir.co.za/eia/ScatecSolarPV/>.

Ons versoek graag dat alle kommentaar aan die WNNR Projekbestuurder (kontakbesonderhede onder aangedui) teen **31 Augustus 2015** verskaf word.

By voorbaat dankie,

Rohaida Abed

CSIR - Environmental Management Services
Posbus 17001, Congella, Durban, 4013
Tel: 031 242 2300
Faks: 031 261 2509
E-pos: RAbed@csir.co.za

From: Rohaida Abed
To: (WR), Nicole Abrahams
CC: Dekockr@nra.co.za
Date: 30/10/2015 13:52
Subject: Re: EIA: THREE SOLAR PV FACILITIES AND ASSOCIATED ELECTRICAL INFRASTRUCTURE NORTH EAST OF KENHARDT, NC
Attachments: Kenhardt PV3.pdf; Kenhardt PV2.pdf; Kenhardt PV1.pdf

Dear Nicole

Thank you for email regarding the proposed Kenhardt PV 1, Kenhardt PV 2 and Kenhardt PV 3 projects. We will add you the project database as requested.

As requested, please find attached locality plans for the Kenhardt PV 1, Kenhardt PV 2 and Kenhardt PV 3 projects.

On 4 September 2015, we also received an email from Ms. Rene de Kock stating the following:

"Please note that this solar development will not impact on a national road, therefore SANRAL has no jurisdiction and have no further comment with regard to the Solar Facility. Should any service, e.g. power line and/or water pipe will be situated within 60m from the national road or will cross the national road application should be made to SANRAL for approval in terms of the National Roads Act."

As noted in Chapter 6 of the Scoping Report, a general Traffic Impact Statement (which will include management measures for road maintenance) will be prepared by the EAP, which will provide recommendations for inclusion in the EMP (during the EIA Report Phase). The same approach was followed by the CSIR for the proposed Nieuwehoop Solar EIA Project which is currently at the decision-making stage of the EIA.

Please confirm if SANRAL has any further comments on the Scoping Report and Addendum (as sent on 6 October 2015 via email). Please note that all project information is available on the project website (<http://www.csir.co.za/>/eia/ScatecSolarPV/>). The comment period closes on 5 November 2015.

Kind Regards,
Rohaida

CSIR - Environmental Management Services
P. O. Box 17001, Congella, Durban, 4013
Tel: 031 242 2300
Fax: 031 261 2509
Email: RAbed@csir.co.za

>>> "Nicole Abrahams (WR)" <AbrahamsN@nra.co.za> 14/10/2015 09:24 >>>

Good day Ms Rohaida Abed

I would herewith like to register as an IAP for the above listed project. May I also request a locality plan please. I would like to know if there is a transport plan available for this project yet.

Regards



Ms Nicole Abrahams
Environmental Coordinator
Tel: [+27 21 957 4602](tel:+27219574602)
Fax: [+27 21 910 1699](tel:+27219101699)
Email: Abrahamsn@nra.co.za

Reg.No.
1998/009584/30



Sanral
Western Region
1 Havenga Street, Oakdale, 7530
Private Bag X19, Bellville, 7535
www.sanral.co.za
SANRAL Fraud Hotline: [0800204558](tel:0800204558)

Scoping and Environmental Impact Assessment for the proposed Development of a 75 MW Solar Photovoltaic Facility (KENHARDT PV 1) on the remaining extent of Onder Rugzeer Farm 168, north-east of Kenhardt, Northern Cape Province

From: Rohaida Abed
To: Matlakala, Gloria
Date: 30/10/2015 14:12
Subject: Re: Proposed developments solar project @ Kenhart PV 3
Attachments: Comment and Response Form_Scatec Solar_NC_FINAL_061015.pdf; Comment and Response Form_Scatec Solar_NC.pdf; Scatec Solar PV1_SR_SUMMARY.pdf; Scatec Solar PV2_SR_SUMMARY.pdf; Scatec Solar PV3_SR_SUMMARY.pdf

Dear Gloria

Thank you for your email. We will add you the database for the proposed Kenhardt PV 1, Kenhardt PV 2 and Kenhardt PV 3 projects, and you will receive future correspondence in terms of the Basic Assessment, EIA and Public Participation Processes.

Please see attached as requested, a comment and registration form (for the Scoping Report and Addendum), as well as the Executive Summaries to the Scoping Report. The comment period closes on 5 November 2015.

Please confirm if you have any further comments on the Scoping Reports and addendum.

Please note that all project information is available on the project website: <http://www.csir.co.za/eia/ScatecSolarPV/>

Kind Regards,
Rohaida

CSIR - Environmental Management Services
P. O. Box 17001, Congella, Durban, 4013
Tel: 031 242 2300
Fax: 031 261 2509
Email: RAbed@csir.co.za

>>> Gloria Matlakala <gloria.tlaky@gmail.com> 26/10/2015 18:43 >>>

Good day Mr Abed

Can you please sent me the registration form to register my company as an I & AP under your database and I'm asking Mr Abed that in future I want to be informed and attend the meetings for the developments you brings to us

For enquiry please sent me emails, or contacts me: 072 056 2833 or 071 984 6106

Hope you will find this in order

Kind regards
Gloria (Khies Municipality)

From: Rohaida Abed
To: atiplady@ska.ac.za
CC: temonama@ska.ac.za
Date: 23/10/2015 09:23
Subject: Fwd: Release of Scoping Reports - Solar PV Facilities and Associated Electrical Infrastructure, Northern Cape
Attachments: A Tiplady_SKA_Email 1_020915_Attachment.pdf

Dear Dr. Tiplady

I trust that you are well. I refer to the email sent below on 23 September 2015 regarding the release of the Kenhardt PV 1, Kenhardt PV 2 and Kenhardt PV3 Scoping Reports, as well as the email sent on 6 October 2015 with an addendum to the Scoping Reports.

Thank you for the attached comments sent by the SKA on 2 September 2015 on the Background Information Document for the proposed project. The attached correspondence states that "*as a result of the medium to high risk associated with the PV facilities, the SKA project office recommends that further EMI and RFI detailed studies be conducted as significant mitigation measures would be required to lower the risk of detrimental impact to an acceptable level*".

We would appreciate if you could provide additional information regarding the scope and Terms of Reference for the required EMI and RFI studies.

Thank you for your assistance with this.

Kind Regards,
Rohaida

>>> Rohaida Abed 23/09/2015 15:29 >>>

NOTICE OF RELEASE OF SCOPING REPORTS FOR THE PROPOSED DEVELOPMENT OF THREE SOLAR PHOTOVOLTAIC (PV) FACILITIES (REFERRED TO AS KENHARDT PV 1, KENHARDT PV 2, AND KENHARDT PV 3) ON THE REMAINING EXTENT OF ONDER RUGZEER FARM 168, NORTH-EAST OF KENHARDT, NORTHERN CAPE PROVINCE

Competent Authority: National Department of Environmental Affairs

CSIR REFERENCE: EMS0102/Scatec/2015

This e-mail correspondence serves to inform you of the release of Scoping Reports for the development of three 75 Megawatt (MW) Solar Photovoltaic (PV) power generation facilities, located on the remaining extent of Onder Rugzeer Farm 168, approximately 80 km south of Upington and 30 km north-east of Kenhardt within the !Kheis Local Municipality, Northern Cape Province. The proposed 75 MW Solar PV projects are referred to as: Kenhardt PV 1, Kenhardt PV 2 and Kenhardt PV 3 respectively. The Project Applicant is Scatec Solar SA 330 (PTY) Ltd for Kenhardt PV 1, Scatec Solar SA 350 (PTY) Ltd for Kenhardt PV 2 and Scatec Solar SA 370 (PTY) Ltd for Kenhardt PV 3.

In terms of the National Environmental Management Act (Act 107 of 1998, as amended) (NEMA) and the 2014 NEMA Environmental Impact Assessment (EIA) Regulations promulgated in Government Gazette 38282 and Government Notice (GN) R982, R983, R984 and R985 on 8 December 2014, a full Scoping and EIA Process is required for the construction of the three Solar PV facilities. A separate Basic Assessment Process will be undertaken for the development of the proposed transmission lines, associated electrical infrastructure and connection to the Eskom Nieuwehoop Substation (which is currently being constructed) on the remaining extent of Portion 3 of Gembok Bult Farm 120. The CSIR has been appointed by the Project Applicant to undertake the separate requisite Basic Assessment, and Scoping and EIA Processes for the proposed projects.

The proposed 75 MW Solar PV facilities are located within the same geographical area and constitute the same type of activity; hence an integrated Public Participation Process will be undertaken. However, separate Applications for Environmental Authorisation are currently being lodged with the National Department of Environmental Affairs (DEA) for each proposed 75 MW Solar PV facility and will be lodged for each Basic Assessment project. Furthermore, separate Basic Assessment, Scoping and EIA Reports will be compiled for each project.

In line with the above, as a registered Interested and Affected Party (I&AP) on the project database, you are hereby notified of the release of the Scoping Reports for the Kenhardt PV 1, Kenhardt PV 2 and Kenhardt PV 3 projects for a 30-day review period, which will extend from **25 September 2015** to **27 October 2015**.

Please find attached the following:

- Executive Summary of each Scoping Report;
- Letter 2 to I&APs; and
- Comment and Registration Form.

Hard copies of the Scoping Reports are available for public viewing at the Kenhardt Library (in Park Street) and the Groblershoop Library (at 97 Oranje Street).

In addition, the above-mentioned project information can be accessed at the following website: <http://www.csir.co.za/eia/ScatecSolarPV/>

Kindly ensure that all comments are submitted to the CSIR Project Manager (details provided below) by **27 October 2015**.

Thank you and kind regards,

Rohaida Abed

CSIR - Environmental Management Services
P. O. Box 17001, Congella, Durban, 4013
Tel: 031 242 2300
Fax: 031 261 2509
Email: RAbed@csir.co.za

From: Rohaida Abed
To: atiplady@ska.ac.za
CC: temonama@ska.ac.za
Date: 27/10/2015 16:51
Subject: Re: Fwd: Release of Scoping Reports - Solar PV Facilities and Associated Electrical Infrastructure, Northern Cape

Dear Dr. Tiplady

I refer to the email trail below in relation to the proposed Kenhardt PV projects. We would appreciate if you could provide additional information regarding the scope and Terms of Reference for the required EMI and RFI studies.

Thank you for your assistance with this.

Kind Regards,
Rohaida

>>> Rohaida Abed 23/10/2015 09:23 >>>

Dear Dr. Tiplady

I trust that you are well. I refer to the email sent below on 23 September 2015 regarding the release of the Kenhardt PV 1, Kenhardt PV 2 and Kenhardt PV3 Scoping Reports, as well as the email sent on 6 October 2015 with an addendum to the Scoping Reports.

Thank you for the attached comments sent by the SKA on 2 September 2015 on the Background Information Document for the proposed project. The attached correspondence states that "as a result of the medium to high risk associated with the PV facilities, the SKA project office recommends that further EMI and RFI detailed studies be conducted as significant mitigation measures would be required to lower the risk of detrimental impact to an acceptable level".

We would appreciate if you could provide additional information regarding the scope and Terms of Reference for the required EMI and RFI studies.

Thank you for your assistance with this.

Kind Regards,
Rohaida

>>> Rohaida Abed 23/09/2015 15:29 >>>

NOTICE OF RELEASE OF SCOPING REPORTS FOR THE PROPOSED DEVELOPMENT OF THREE SOLAR PHOTOVOLTAIC (PV) FACILITIES (REFERRED TO AS KENHARDT PV 1, KENHARDT PV 2, AND KENHARDT PV 3) ON THE REMAINING EXTENT OF ONDER RUGZEER FARM 168, NORTH-EAST OF KENHARDT, NORTHERN CAPE PROVINCE

Competent Authority: National Department of Environmental Affairs

CSIR REFERENCE: EMS0102/Scatec/2015

This e-mail correspondence serves to inform you of the release of Scoping Reports for the development of three 75 Megawatt (MW) Solar Photovoltaic (PV) power generation facilities, located on the remaining extent of Onder Rugzeer Farm 168, approximately 80 km south of Upington and 30 km north-east of Kenhardt within the !Kheis Local Municipality, Northern Cape Province. The proposed 75 MW Solar PV projects are referred to as: Kenhardt PV 1, Kenhardt PV 2 and Kenhardt PV 3 respectively. The Project Applicant is Scatec Solar SA 330 (PTY) Ltd for Kenhardt PV 1, Scatec Solar SA 350 (PTY) Ltd for Kenhardt PV 2 and Scatec Solar SA 370 (PTY) Ltd for Kenhardt PV 3.

In terms of the National Environmental Management Act (Act 107 of 1998, as amended) (NEMA) and the 2014 NEMA Environmental Impact Assessment (EIA) Regulations promulgated in Government Gazette 38282 and Government Notice (GN) R982, R983, R984 and R985 on 8 December 2014, a full Scoping and EIA Process is required for the construction of the three Solar PV facilities. A separate Basic Assessment Process will be undertaken for the development of the proposed transmission lines, associated electrical infrastructure and connection to the Eskom Nieuwehoop Substation (which is currently being constructed) on the remaining extent of Portion 3 of Gembok Bult Farm 120. The CSIR has been appointed by the Project Applicant to undertake the separate requisite Basic Assessment, and Scoping and EIA Processes for the proposed projects.

The proposed 75 MW Solar PV facilities are located within the same geographical area and constitute the same type of activity; hence an integrated Public Participation Process will be undertaken. However, separate Applications for Environmental Authorisation are currently being lodged with the National Department of Environmental Affairs (DEA) for each proposed 75 MW Solar PV facility and will be lodged for each Basic Assessment project. Furthermore, separate Basic Assessment, Scoping and EIA Reports will be compiled for each project.

In line with the above, as a registered Interested and Affected Party (I&AP) on the project database, you are hereby notified of the release of the Scoping Reports for the Kenhardt PV 1, Kenhardt PV 2 and Kenhardt PV 3 projects for a 30-day review period, which will extend from **25 September 2015 to 27 October 2015**.

Please find attached the following:
- Executive Summary of each Scoping Report;
- Letter 2 to I&APs; and
- Comment and Registration Form.

Hard copies of the Scoping Reports are available for public viewing at the Kenhardt Library (in Park Street) and the Groblershoop Library (at 97 Oranje Street).

In addition, the above-mentioned project information can be accessed at the following website:
<http://www.csir.co.za/eia/ScatecSolarPV/>

Kindly ensure that all comments are submitted to the CSIR Project Manager (details provided below) by **27 October 2015**.

Thank you and kind regards,

Rohaida Abed

CSIR - Environmental Management Services
P. O. Box 17001, Congella, Durban, 4013
Tel: 031 242 2300
Fax: 031 261 2509
Email: RAbed@csir.co.za

From: Rohaida Abed
To: Tiplady, Adrian
CC: temonama@ska.ac.za
Date: 29/10/2015 09:23
Subject: Re: Fwd: Release of Scoping Reports - Solar PV Facilities and Associated Electrical Infrastructure, Northern Cape

Dear Adrian

Thank you very much for your response. We would appreciate if you could kindly send us the contact details for the EMI specialists based in Pretoria that you suggest in the email below.

Kind Regards,
Rohaida

>>> Adrian Tiplady <atiplady@ska.ac.za> 29/10/2015 07:51 >>>
> Hi Rohaida,

In summary, a detailed EMI and RFI survey would need to be undertaken to characterise the expected radio emissions from the facility. Once this has been conducted, radio frequency propagation modelling would need to be undertaken to determine the quantitative impact the proposed facility would have on the SKA.

The relevant developer would need to contract EMI specialists to undertake these studies. I can suggest a group based in Pretoria, who have undertaken similar studies.

Regards,

Adrian

On 27/10/2015 4:51 PM, Rohaida Abed wrote:

Dear Dr. Tiplady

I refer to the email trail below in relation to the proposed Kenhardt PV projects. We would appreciate if you could provide additional information regarding the scope and Terms of Reference for the required EMI and RFI studies.

Thank you for your assistance with this.

Kind Regards,
Rohaida

>>> Rohaida Abed 23/10/2015 09:23 >>>

Dear Dr. Tiplady

I trust that you are well. I refer to the email sent below on 23 September 2015 regarding the release of the Kenhardt PV 1, Kenhardt PV 2 and Kenhardt PV3 Scoping Reports, as well as the email sent on 6 October 2015 with an addendum to the Scoping Reports.

Thank you for the attached comments sent by the SKA on 2 September 2015 on the Background Information Document for the proposed project. The attached correspondence states that "*as a result of the medium to high risk associated with the PV facilities, the SKA project office recommends that further EMI and RFI detailed studies be conducted as significant mitigation measures would be required to lower the risk of detrimental impact to an acceptable level*".

We would appreciate if you could provide additional information regarding the scope and Terms of Reference for the required EMI and RFI studies.

Thank you for your assistance with this.

Kind Regards,
Rohaida

Scoping and Environmental Impact Assessment for the proposed Development of a 75 MW Solar Photovoltaic Facility (KENHARDT PV 1) on the remaining extent of Onder Rugzeer Farm 168, north-east of Kenhardt, Northern Cape Province

From: Rohaida Abed
To: Tiplady, Adrian
CC: temonama@ska.ac.za
Date: 29/10/2015 16:13
Subject: Re: Fwd: Release of Scoping Reports - Solar PV Facilities and Associated Electrical Infrastructure, Northern Cape

Dear Adrian

Thank you very much for these contact details. I have forwarded them to the Project Applicant.

Please could you also confirm if the SKA has any comments on the Scoping Report and Addendum for the proposed projects.

Thank you and kind regards,
Rohaida

>>> Adrian Tiplady <atiplady@ska.ac.za> 29/10/2015 12:10 >>>
> Hi Rohaida,

ITC Services
callie@itc-services.com

Regards,

Adrian

On 29/10/2015 9:23 AM, Rohaida Abed wrote:

Dear Adrian

Thank you very much for your response. We would appreciate if you could kindly send us the contact details for the EMI specialists based in Pretoria that you suggest in the email below.

Kind Regards,
Rohaida

From: Rohaida Abed
To: Tiplady, Adrian
CC: temonama@ska.ac.za
Date: 30/10/2015 14:39
Subject: Re: Fwd: Release of Scoping Reports - Solar PV Facilities and Associated Electrical Infrastructure, Northern Cape

Dear Adrian

Thank you for your reply and for confirming that your comments sent via email on 2 September 2015 (during the Project Initiation Phase) are still applicable, and no further comments on the Scoping Reports will be provided at this stage.

As noted in the Scoping Reports, the requested Electro Magnetic Interference and Radio Frequency Interference Studies will be undertaken by the project applicant and will be included in the EIA Reports (during the EIA Phase). The SKA will accordingly receive a copy of the EIA Reports for the proposed Kenhardt PV 1, Kenhardt PV 2 and Kenhardt PV 3 projects, for comment.

Thank you and kind regards,
Rohaida

>>> Adrian Tiplady <atiplady@ska.ac.za> 30/10/2015 09:22 >>>
> Hi Rohaida,

I would like to confirm that our letter applies to all potential facilities of the same nature located at this site, and future requests for comments on this and other facilities. Once we have been able to assess and analyse appropriate measurement reports, we will issue a further comment.

Regards,

Adrian

On 29/10/2015 4:13 PM, Rohaida Abed wrote:

Dear Adrian

Thank you very much for these contact details. I have forwarded them to the Project Applicant.

Scoping and Environmental Impact Assessment for the proposed Development of a 75 MW Solar Photovoltaic Facility (KENHARDT PV 1) on the remaining extent of Onder Rugzeer Farm 168, north-east of Kenhardt, Northern Cape Province

Please could you also confirm if the SKA has any comments on the Scoping Report and Addendum for the proposed projects.

Thank you and kind regards,
Rohaida

Copies and Proof of Correspondence Sent to I&APs for Notification of the Submission of the Scoping Report to DEA for Decision-Making

Email sent to I&APs on 11 November 2015

From: Rohaida Abed
To: Abed, Rohaida
BC aditeme@agri.ncape.gov.za; admin@grasslands.org.za; advocacy@birdlife.org.za; ameliastrauss2@gmail.com; andre.vanniekerk10@gmail.com; annelizac@nda.agric.za; atiplady@ska.ac.za; boozahunter@yahoo.com; claude@veroniva.co.za; Clive.Stephenson@transnet.net; CloeteS@dws.gov.za; ernest.connan@donco.co.za; fpr@bodr.gov.za; GeerinJH@eskom.co.za; Gilbert.Nortier@transnet.net; HaarhL@eskom.co.za; hendri@aheadtrading.co.za; JacolineMa@daff.gov.za; jdbhenrohn@gmail.com; jhjs@webmail.co.za; karen@mulilo.com; klawrence@trpw.ncape.gov.za; kraaines@mweb.co.za; l.ntsolo@sanbi.org.za; LeaskK@eskom.co.za; marcyroxnpc@gmail.com; Marina.Lourens@transnet.net; MashuduMa@daff.gov.za; Mayvyn.Bhana@transnet.net; MeiM@dwa.gov.za; MelanieM@L2B.co.za; messop@environment.gov.za; mitchell.hodgson@scatecsolar.com; mm@kaigarib.gov.za; mmathews@ncpg.gov.za; mndzilili@ncpg.gov.za; monica.lepheane@labour.gov.za; MRabothata@environment.gov.za; ncagric@worldonline.co.za; nhlakad@daff.gov.za; nyaphi@ncpg.gov.za; ontvangs@agrink.co.za; peter.buys@nersa.org.za; ratha.timothy@gmail.com; rwarie@ncpg.gov.za; sb@siyanda.gov.za; sdelafontaine@gmail.com; sharon@nocci.co.za; smbanjwa@ncpg.gov.za; straussdj@orientis.co.za; strohl@caa.co.za; teresascheepers@vodamail.co.za; ThokoB@daff.gov.za; townsendmorgan029@gmail.com; waltjc@nra.co.za; wep@ewt.org.za; WyngaaJO@eskom.co.za; ltoolsbernado@ncpg.gov.za; gloria.tlaky@gmail.com; clarkem@kaigarib.gov.za; SchwartzC@dws.gov.za; AbrahamsN@nra.co.za; rredelstorff@sahra.org.za; elsabe.dtec@gmail.com; Laurie, Surina; ptiger@ncpg.gov.za
Date: 11/11/2015 15:35
Subject: Submission of Scoping Reports to the National DEA - Solar PV Facilities and Associated Electrical Infrastructure, Northern Cape

Dear Stakeholders and Interested and Affected Parties

Notice of submission of the scoping reportS to the competent authority for the Proposed development of three Solar Photovoltaic (PV) Facilities (Referred to as kenhardt pv 1, kenhardt pv 2, and kenhardt pv 3) on the remaining extent of Onder Rugzeer Farm 168, north-east of Kenhardt, Northern Cape Province

Competent Authority: National Department of Environmental Affairs

csir reference: EMS0102/Scatec/2015

This e-mail correspondence serves to inform you of the submission of the Scoping Reports for the abovementioned proposed projects to the National Department of Environmental Affairs (DEA) for decision-making in terms of Regulation 22 of the 2014 National Environmental Management Act (Act 107 of 1998, as amended) (NEMA) Environmental Impact Assessment (EIA) Regulations. The Project Applicant is intending to develop three 75 Megawatt (MW) Solar Photovoltaic (PV) power generation facilities, located on the remaining extent of Onder Rugzeer Farm 168, approximately 80 km south of Upington and 30 km north-east of Kenhardt within the !Kheis Local Municipality, Northern Cape Province. The proposed 75 MW Solar PV projects are referred to as: Kenhardt PV 1, Kenhardt PV 2 and Kenhardt PV 3 respectively. The Project Applicant is Scatec Solar SA 330 (PTY) Ltd for Kenhardt PV 1, Scatec Solar SA 350 (PTY) Ltd for Kenhardt PV 2 and Scatec Solar SA 370 (PTY) Ltd for Kenhardt PV 3.

As a registered Interested and Affected Party (I&AP) on the project database, you were notified on 23 September 2015 via email and registered mail of the release of the Scoping Reports for the Kenhardt PV 1, Kenhardt PV 2 and Kenhardt PV 3 projects for a 30-day review period, which extended from 25 September 2015 to 27 October 2015. You were further informed on 6 October 2015 via email of the release of the Addendum to the Scoping Reports for the Kenhardt PV 1, Kenhardt PV 2 and Kenhardt PV 3 projects to all registered I&APs and stakeholders for an additional 30-day review period, which extended from 6 October 2015 to 5 November 2015.

The comments received from stakeholders during the abovementioned 30-day review of both the Scoping Reports and Addendums have been incorporated into the finalised Scoping Reports (where required), as well as the Issues and Responses Trail (i.e. Chapter 7 of the finalised Scoping Reports). As noted above, the finalised

Scoping Reports are currently being submitted to the National DEA, in accordance with Regulation 21 (1) of the 2014 NEMA EIA Regulations, for decision-making (i.e. acceptance or rejection) in terms of Regulation 22 of the 2014 NEMA EIA Regulations. If the Scoping Reports are approved by the National DEA, this approval will mark the end of the Scoping Phase after which the EIA Process moves into the impact assessment and reporting phase.

For information purposes, the finalised Scoping Reports for the Kenhardt PV 1, Kenhardt PV 2 and Kenhardt PV 3 projects have been placed on the project website:<http://www.csir.co.za/eia/ScatecSolarPV/>

Thank you and kind regards,

Rohaida Abed
CSIR - Environmental Management Services
P. O. Box 17001, Congella, Durban, 4013
Tel: 031 242 2300
Fax: 031 261 2509
Email: RAbed@csir.co.za

Proof of Delivery of Email sent to all I&APs on 11 November 2015

Message Id: 56434400.EBB : 179 : 65115
 Subject: Submission of Scoping Reports to the National DEA - Solar PV Facilities and Associated Electrical Infrastructure, Northern Cape
 Created By: RAbed@esir.co.za
 Scheduled Date: 11/11/2015 15:35
 Creation Date: 11/11/2015 15:35
 From: Rohaida Abed

Recipient	Action	Date & Time	Comment
agri.ncape.gov.za	Transferred	11/11/2015 15:35	
BC: adlerne@agri.ncape.gov.za(adlerne@agri.ncape.gov.za)	Delivered	11/11/2015 15:53	
agrlink.co.za	Transferred	11/11/2015 15:35	
BC: ontvangs@agrlink.co.za(ontvangs@agrlink.co.za)	Delivered	11/11/2015 16:09	
aheadtrading.co.za	Transferred	11/11/2015 15:35	
BC: hendri@aheadtrading.co.za(hendri@aheadtrading.co.za)	Delivered	11/11/2015 15:53	
birdlife.org.za	Transferred	11/11/2015 15:35	
BC: advocacy@birdlife.org.za(advocacy@birdlife.org.za)	Delivered	11/11/2015 15:53	
boodr.gov.za	Transferred	11/11/2015 15:35	
BC: frj@boodr.gov.za(frj@boodr.gov.za)	Undeliverable	11/11/2015 15:53	
caa.co.za	Transferred	11/11/2015 15:35	
BC: stroh@caa.co.za(stroh@caa.co.za)	Delivered	11/11/2015 15:36	
daff.gov.za	Transferred	11/11/2015 15:35	
BC: JacolineMa@daff.gov.za(JacolineMa@daff.gov.za)	Delivered	11/11/2015 15:41	
BC: MashuduA@daff.gov.za(MashuduA@daff.gov.za)	Delivered	11/11/2015 15:41	
BC: nhlakad@daff.gov.za(nhlakad@daff.gov.za)	Delivered	11/11/2015 15:41	
BC: ThokoB@daff.gov.za(ThokoB@daff.gov.za)	Delivered	11/11/2015 15:41	
donco.co.za	Transferred	11/11/2015 15:35	
BC: ernest.connan@donco.co.za(ernest.connan@donco.co.za)	Delivered	11/11/2015 15:36	
dwa.gov.za	Transferred	11/11/2015 15:35	
BC: MeilM@dwa.gov.za(MeilM@dwa.gov.za)	Delivered	11/11/2015 15:36	
dws.gov.za	Transferred	11/11/2015 15:35	
BC: CloeteS@dws.gov.za(CloeteS@dws.gov.za)	Delivered	11/11/2015 15:40	
BC: SchwartzC@dws.gov.za(SchwartzC@dws.gov.za)	Delivered	11/11/2015 15:40	
environment.gov.za	Transferred	11/11/2015 15:35	
BC: messop@environment.gov.za(messop@environment.gov.za)	Delivered	11/11/2015 15:36	
BC: MRabothata@environment.gov.za(MRabothata@environment.gov.za)	Delivered	11/11/2015 15:36	
eskom.co.za	Transferred	11/11/2015 15:35	
BC: GeerinJH@eskom.co.za(GeerinJH@eskom.co.za)	Delivered	11/11/2015 15:40	
BC: HaarHJ@eskom.co.za(HaarHJ@eskom.co.za)	Delivered	11/11/2015 15:40	
BC: LessakK@eskom.co.za(LessakK@eskom.co.za)	Delivered	11/11/2015 15:40	
BC: WymgaaJO@eskom.co.za(WymgaaJO@eskom.co.za)	Delivered	11/11/2015 15:40	
ewt.org.za	Transferred	11/11/2015 15:35	
BC: wep@ewt.org.za(wep@ewt.org.za)	Delivered	11/11/2015 15:53	
gmail.com	Transferred	11/11/2015 15:35	
BC: amelasthaus2@gmail.com(amelasthaus2@gmail.com)	Delivered	11/11/2015 15:36	
BC: andre.vanniekerk10@gmail.com(andre.vanniekerk10@gmail.com)	Delivered	11/11/2015 15:36	
BC: eisabe.dlec@gmail.com(eisabe.dlec@gmail.com)	Delivered	11/11/2015 15:36	
BC: gloria.fakj@gmail.com(gloria.fakj@gmail.com)	Delivered	11/11/2015 15:36	
BC: jobhenrohm@gmail.com(jobhenrohm@gmail.com)	Delivered	11/11/2015 15:36	
BC: marcyroampc@gmail.com(marcyroampc@gmail.com)	Delivered	11/11/2015 15:36	
BC: ratha.fmotry@gmail.com(ratha.fmotry@gmail.com)	Delivered	11/11/2015 15:36	
BC: sdelafontaine@gmail.com(sdelafontaine@gmail.com)	Delivered	11/11/2015 15:36	
BC: townsendmorgan029@gmail.com(townsendmorgan029@gmail.com)	Delivered	11/11/2015 15:36	
grasslands.org.za	Transferred	11/11/2015 15:35	
BC: admin@grasslands.org.za(admin@grasslands.org.za)	Delivered	11/11/2015 15:36	
kaizerb.gov.za	Transferred	11/11/2015 15:35	

file:///C:/Users/RAbed/AppData/Local/Temp/XPgrpwise/5643602DDURBANPOBO... 12/11/2015

BC: clarkem@kaigarib.gov.za (clarkem@kaigarib.gov.za)		
BC: mm@kaigarib.gov.za (mm@kaigarib.gov.za)		
L2B.co.za	Transferred	11/11/2015 15:35
BC: MelanieM@L2B.co.za (MelanieM@L2B.co.za)	Delivered	11/11/2015 15:36
labour.gov.za	Transferred	11/11/2015 15:35
BC: monica.lepheane@labour.gov.za (monica.lepheane@labour.gov.za)	Delivered	11/11/2015 15:39
mullo.com	Transferred	11/11/2015 15:35
BC: karen@mullo.com (karen@mullo.com)	Delivered	11/11/2015 15:36
mweb.co.za	Transferred	11/11/2015 15:35
BC: kraalines@mweb.co.za (kraalines@mweb.co.za)	Delivered	11/11/2015 15:36
ncpg.gov.za	Transferred	11/11/2015 15:35
BC: tootsbermado@ncpg.gov.za (tootsbermado@ncpg.gov.za)	Delivered	11/11/2015 15:36
BC: mmathews@ncpg.gov.za (mmathews@ncpg.gov.za)	Delivered	11/11/2015 15:36
BC: mndzili@ncpg.gov.za (mndzili@ncpg.gov.za)	Delivered	11/11/2015 15:36
BC: nyaphi@ncpg.gov.za (nyaphi@ncpg.gov.za)	Delivered	11/11/2015 15:36
BC: pliger@ncpg.gov.za (pliger@ncpg.gov.za)	Delivered	11/11/2015 15:36
BC: nwarie@ncpg.gov.za (nwarie@ncpg.gov.za)	Delivered	11/11/2015 15:36
BC: smbaniwa@ncpg.gov.za (smbaniwa@ncpg.gov.za)	Delivered	11/11/2015 15:36
nda.agric.za	Transferred	11/11/2015 15:35
BC: annelizac@nda.agric.za (annelizac@nda.agric.za)	Delivered	11/11/2015 15:39
nersa.org.za	Transferred	11/11/2015 15:35
BC: peter.buys@nersa.org.za (peter.buys@nersa.org.za)	Delivered	11/11/2015 15:44
noccl.co.za	Transferred	11/11/2015 15:35
BC: sharon@noccl.co.za (sharon@noccl.co.za)		
nra.co.za	Transferred	11/11/2015 15:35
BC: AbrahamsN@nra.co.za (AbrahamsN@nra.co.za)	Delivered	11/11/2015 15:36
POBOX1.DURBAN	Delivered	11/11/2015 15:35
To: Rohaida Abed (RAbed@csir.co.za)	Read	11/11/2015 15:35
POBOX1.STELLBOS	Delivered	11/11/2015 15:35
BC: Gurina Laurie (GLaurie@csir.co.za)	Third-Party Downloaded Read	11/11/2015 15:35 11/11/2015 15:35
nra.co.za	Transferred	11/11/2015 15:35
BC: waitc@nra.co.za (waitc@nra.co.za)	Delivered	11/11/2015 15:36
orientis.co.za	Transferred	11/11/2015 15:35
BC: straussd@orientis.co.za (straussd@orientis.co.za)	Delivered	11/11/2015 15:39
sahra.org.za	Transferred	11/11/2015 15:35
BC: medelstorf@sahra.org.za (medelstorf@sahra.org.za)	Delivered	11/11/2015 15:40
sanbi.org.za	Transferred	11/11/2015 15:35
BC: lntsolio@sanbi.org.za (lntsolio@sanbi.org.za)	Undeliverable	11/11/2015 15:38
scatecsolar.com	Transferred	11/11/2015 15:35
BC: mitchell.hodgson@scatecsolar.com (mitchell.hodgson@scatecsolar.com)		
siyanda.gov.za	Transferred	11/11/2015 15:35
BC: sb@siyanda.gov.za (sb@siyanda.gov.za)		
ska.ac.za	Transferred	11/11/2015 15:35
BC: atipady@ska.ac.za (atipady@ska.ac.za)	Delivered	11/11/2015 15:39
transnet.net	Transferred	11/11/2015 15:35
BC: Clive.Stephenson@transnet.net (Clive.Stephenson@transnet.net)	Delivered	11/11/2015 15:40
BC: Gilbert.Nortier@transnet.net (Gilbert.Nortier@transnet.net)	Delivered	11/11/2015 15:40
BC: Marina.Lourens@transnet.net (Marina.Lourens@transnet.net)	Delivered	11/11/2015 15:40
BC: Mayvyn.Bhana@transnet.net (Mayvyn.Bhana@transnet.net)	Delivered	11/11/2015 15:40
trpw.ncape.gov.za	Transferred	11/11/2015 15:35
BC: klawrence@trpw.ncape.gov.za (klawrence@trpw.ncape.gov.za)	Undeliverable	11/11/2015 15:39
veroniva.co.za	Transferred	11/11/2015 15:35

file:///C:/Users/RAbed/AppData/Local/Temp/XPgipwise/5643602DDURBANPOBO... 12/11/2015

BC: claude@veroniva.co.za; claude@veroniva.co.za)	Delivered	11/11/2015 15:39
vodamail.co.za	Transferred	11/11/2015 15:35
BC: teresascheepers@vodamail.co.za; teresascheepers@vodamail.co.za)	Delivered	11/11/2015 15:42 2.0.0 recipients expanded
webmail.co.za	Transferred	11/11/2015 15:35
BC: jhs@webmail.co.za; jhs@webmail.co.za)	Transferred	11/11/2015 16:13 2.0.0 message relayed
worldonline.co.za	Transferred	11/11/2015 15:35
BC: ncagric@worldonline.co.za; ncagric@worldonline.co.za)	Delivered	11/11/2015 15:38
yahoo.com	Transferred	11/11/2015 15:35
BC: boozahunter@yahoo.com; boozahunter@yahoo.com)	Delivered	11/11/2015 15:36

Post Offices

Post Office	Delivered	Route
agri.ncape.gov.za		agri.ncape.gov.za
agrlnk.co.za		agrlnk.co.za
aheadtrading.co.za		aheadtrading.co.za
birdlife.org.za		birdlife.org.za
bodr.gov.za		bodr.gov.za
caa.co.za		caa.co.za
daff.gov.za		daff.gov.za
donco.co.za		donco.co.za
dwa.gov.za		dwa.gov.za
dws.gov.za		dws.gov.za
environment.gov.za		environment.gov.za
eskom.co.za		eskom.co.za
ewt.org.za		ewt.org.za
gmail.com		gmail.com
grasslands.org.za		grasslands.org.za
kgarib.gov.za		kgarib.gov.za
L2B.co.za		L2B.co.za
labour.gov.za		labour.gov.za
mullio.com		mullio.com
mweb.co.za		mweb.co.za
ncpg.gov.za		ncpg.gov.za
nda.agric.za		nda.agric.za
nersa.org.za		nersa.org.za
noccl.co.za		noccl.co.za
nra.co.za		nra.co.za
orientis.co.za		orientis.co.za
POBOX1.DURBAN	11/11/2015 15:35	csir.co.za
POBOX1.STELLBOS	11/11/2015 15:35	csir.co.za
sahra.org.za		sahra.org.za
sanbi.org.za		sanbi.org.za
scalecsolar.com		scalecsolar.com
siyanda.gov.za		siyanda.gov.za
sks.ac.za		sks.ac.za
transnet.net		transnet.net
tpw.ncape.gov.za		tpw.ncape.gov.za
veroniva.co.za		veroniva.co.za
vodamail.co.za		vodamail.co.za
webmail.co.za		webmail.co.za
worldonline.co.za		worldonline.co.za
yahoo.com		yahoo.com

Files

File	Size	Date & Time
MESSAGE	5 KB (5730 Bytes)	11/11/2015 15:35
TEXT.htm	9 KB (9658 Bytes)	11/11/2015 15:35

Options

Auto Delete:	No
Concealed Subject:	No
Expiration Date:	None

file:///C:/Users/RAbed/AppData/Local/Temp/XPgipwise/5643602DDURBANPOBO... 12/11/2015

Notify Recipients: Yes
Priority: Standard
Reply Requested By: None
Security: Standard
To Be Delivered: Immediate

Record Id

Record Id: 5643602D.DURBAN.POBOX1.100.1356D37.1.DA03.1
Common Record Id: 5643602D.DURBAN.POBOX1.200.20000B3.1.346D6.1

file:///C:/Users/RAbed/AppData/Local/Temp/XPgipwise/5643602DDURBANPOBO... 12/11/2015

Proof of Correspondence with DEA (Courier Waybills for submission of finalised Scoping Report)

Tracking, Track Parcels, Packages, Shipments | DHL Express Tracking

Page 1 of 1



English Contact Center Country Profile DHL Global

Track DHL Express Shipments

Here's the fastest way to check the status of your shipment. No need to call Customer Service – our online results give you real-time, detailed progress as your shipment speeds through the DHL network.

Result Summary

Waybill: 4536848702
Signed for by: RINA
Get Signature Proof of Delivery

Thursday, November 12, 2015 at 09:11 1 Piece
Origin Service Area:
 DURBAN - GLENWOOD - SOUTH AFRICA
Destination Service Area:
 PRETORIA - PRETORIA - SOUTH AFRICA

Thursday, November 12, 2015		Location	Time	Piece
9	Delivered - Signed for by : RINA	PRETORIA	09:11	1 Piece
8	With delivery courier	PRETORIA - SOUTH AFRICA	07:36	1 Piece
7	Arrived at Delivery Facility in PRETORIA - SOUTH AFRICA	PRETORIA - SOUTH AFRICA	05:33	1 Piece
6	Departed Facility in JOHANNESBURG - SOUTH AFRICA	JOHANNESBURG - SOUTH AFRICA	05:13	1 Piece
5	Processed at JOHANNESBURG - SOUTH AFRICA	JOHANNESBURG - SOUTH AFRICA	05:11	1 Piece
4	Arrived at Sort Facility JOHANNESBURG - SOUTH AFRICA	JOHANNESBURG - SOUTH AFRICA	03:54	1 Piece
Wednesday, November 11, 2015		Location	Time	Piece
3	Departed Facility in DURBAN - SOUTH AFRICA	DURBAN - SOUTH AFRICA	19:25	1 Piece
2	Processed at DURBAN - SOUTH AFRICA	DURBAN - SOUTH AFRICA	19:25	1 Piece
1	Shipment picked up	DURBAN - SOUTH AFRICA	16:23	1 Piece

If you would prefer to speak to someone personally about the location of your shipment, please [contact DHL Express Customer Service](#).

[Terms & Conditions](#)
[Tracking FAQs](#)



EIA REPORT

APPENDIX F:

Copy of Site Notice Board and Proof of Placement

Scoping and Environmental Impact Assessment for the Proposed Development of a 75 MW Solar Photovoltaic Facility (KENHARDT PV 1) on the remaining extent of Onder Rugzeer Farm 168, north-east of Kenhardt, Northern Cape Province

Site Notice Board - English

JOINT NOTICE OF BASIC ASSESSMENT AND SCOPING AND ENVIRONMENTAL IMPACT ASSESSMENT PROCESSES

PROPOSED DEVELOPMENT OF THREE SOLAR PHOTOVOLTAIC FACILITIES AND ASSOCIATED ELECTRICAL INFRASTRUCTURE NORTH-EAST OF KENHARDT, NORTHERN CAPE PROVINCE

CSIR REFERENCE: EMS0102/SCATEC/2015

Notice is hereby given in terms of Regulation 41 of the Environmental Impact Assessment (EIA) Regulations published in Government Notice (GN) R982 in Government Gazette 38262 of 8 December 2014, under Section 24(4)(a) of the National Environmental Management Act (Act 107 of 1998, as amended) (NEMA), that Scatec Solar SA 163 (PTY) Ltd are proposing to develop three 75 Megawatt (MW) Solar Photovoltaic (PV) facilities and associated electrical infrastructure (132 kV transmission lines for each 75 MW facility), on the remaining extent of Onder Rugzeer Farm 168 and the connection points to the substation on the remaining extent of Portion 3 of Gembok Bult Farm 120. The proposed projects are located 30 km north-east of Kenhardt. Each 75 MW Solar PV facility proposed will cover an approximate area of 200 hectares (ha) and will be constructed adjacent to each other (with a collective footprint of approximately 600 ha and a combined power generation capacity of 225 MW). The proposed projects will entail the construction of the solar field, buildings, electrical infrastructure, internal access roads, and associated infrastructure and structures.

A full Scoping and EIA Process is required for the construction of the three Solar PV facilities. A separate Basic Assessment Process is also required and will be undertaken for the development of the proposed transmission lines. The CSIR has been appointed by Scatec Solar SA 163 (PTY) Ltd to undertake the required Basic Assessment and Scoping and EIA Processes for the proposed projects. The need for a Basic Assessment and Scoping and EIA is triggered by the following potential listed activities listed in GN R983 and GN R984:

Process	Government Notice	Listed Activity Number
Basic Assessment Processes	GN R983 - 8 December 2014	Activity 11 (i)
Scoping and EIA Processes	GN R983 - 8 December 2014	Activity 9 (i) and (ii); Activity 12 (x) and (xii); Activity 19 (i); Activity 24 (ii) and Activity 28 (ii)
	GN R984 - 8 December 2014	Activity 1 and Activity 15.

Since the proposed 75 MW Solar PV facilities are located within the same geographical area and constitute the same type of activity, an integrated Public Participation Process will be undertaken for the proposed projects. However, separate Applications for Environmental Authorisation (EA) will be lodged with the Competent Authority (i.e. the National Department of Environmental Affairs (DEA)) for each proposed 75 MW Solar PV facility and transmission line, which will be referred to as Kenhardt PV 1, Kenhardt PV 2, Kenhardt PV 3, Kenhardt PV 1 – Transmission Line, Kenhardt PV 2 – Transmission Line, and Kenhardt PV 3 – Transmission Line. Separate reports (i.e. Basic Assessment and Scoping and EIA Reports) will be compiled for each project.

To ensure that you are included on the project register as an Interested and Affected Party (I&AP), as well as to raise any issues and concerns for inclusion in the Basic Assessment and Scoping Reports, you are kindly requested to register your interest in the projects and submit any comments you may have to the CSIR (at the details indicated below). Available project information can be accessed at the following website: <http://www.csir.co.za/eia/ScatecSolarPV/>.

The Background Information Document is currently available for a 30-day commenting period (03 August 2015 - 04 September 2015).

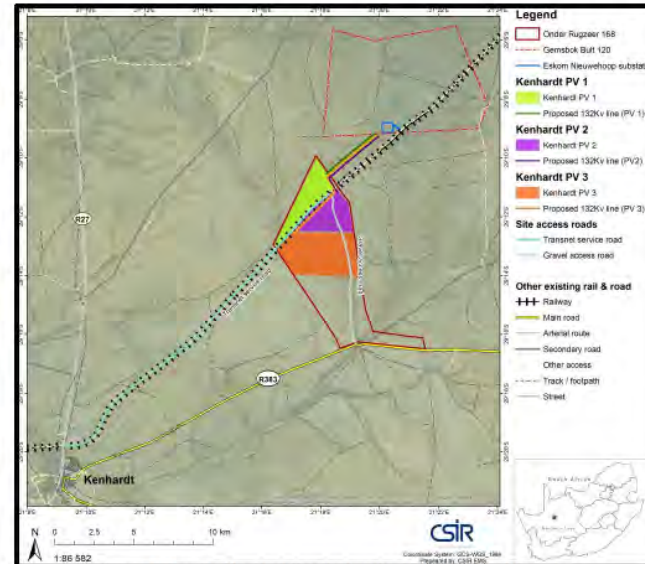

Figure 1: Locality Map depicting the location of the Proposed Projects



To obtain further information or to register as Interested and Affected Party (I&AP), please contact:
 CSIR
 Rohaida Abed
 P. O. Box 17001, Congella, Durban, 4013
 Phone: 031 242 2300
 Fax: 031 261 2509
 Email: R.Abed@csir.co.za

Site Notice Board - Afrikaans

GESAMENTLIKE KENNISGEWING VAN BASIESE EN OMGEWINGSIMPAKEVALUERINGSPROSESSE

VOORGESTELDE ONTWIKKELING VAN DRIE SONKRAGANLEGTE EN ELEKTRIESE INFRASTRUKTUUR NOORD-OOS VAN KENHARDT, NOORD-KAAP PROVINSIE

CSIR VERWYSING: EMS0102/SCATEC/2015

Hiermee word kennis gegee, in terme van Regulasie 41 van die Omgewingsimpakstudie (OIS) Regulasies soos gepubliseer in Staatskennisgewing R982 in Staatskoerant No 38282 van 08 Desember 2015, onder Seksie 24(4)(a) van die Nasionale Omgewingsbeheer Wet, 1998 (Wet No 107 van 1998) (NEMA), dat Scatec Solar SA 163 (Pty) Ltd van voornemens is om drie Fotovoltaïese (PV) sonkragfasiliteite, elk met 'n opwekkingskapasiteit van 75 MW en elektriese infrastruktuur (132 kV kraglyn vir elke 75 MW sonkrag fasiliteit) te installeer op die Restant van Onder Rugzeer 168 en die konneksiepunten na die substasie op die Restant van Gedeelte 3 van Gembok Bult 120. Die voorgestelde projekte is 30 km noord-oos van Kenhardt geleë. Elke projek gaan ongeveer 200 hektaar (ha) beslaan en sal langs mekaar gebou word. Elke projek gaan, onder andere, sonpanele, geboue, elektriese infrastruktuur, en toeganspaaië bestaan.

Elke sonkragprojek vereis dat 'n Bestekopname and Omgewingsimpakevalueringsproses onderneem word. Aparte Basiese evalueringsprosesse sal ook gedoen word vir die voorgestelde 132 kV kraglyne. Die WNNR (CSIR) is aangestel deur Scatec Solar 163 (Pty) Ltd om die evalueringsprosesse uit te voer. Die prosesse word benodig omdat die volgende gelyste aktiwiteite van toepassing is op die projekte:

Proses	Staatskennisgewing	Gelyste aktiwiteit nommer
Basiese evaluering	GN R983 - 8 Desember 2014	Aktiwiteit 11 (i)
Bestekopname en Omgewingsimpakevaluering	GN R983 - 8 Desember 2014	Aktiwiteit 9 (i) and (ii); Aktiwiteit 12 (x) and (xii); Aktiwiteit 19 (i); Aktiwiteit 24 (ii) and Aktiwiteit 28 (ii)
	GN R984 - 8 Desember 2014	Aktiwiteit 1 and Aktiwiteit 15.

Aangesien die sonkragprojekte en die voorgestelde elektriese infrastruktuur in dieselfde geografiese area gebou gaan word and dieselfde tipe projekte is, word dit voorgestel dat 'n geïntegreerde Publieke Deelname Proses gedoen gaan word. Aparte aansoeke gaan by die Nasionale Departement van Omgewingsake ingedien word vir die verskillende projekte en sal na verwys word in die volgende formaat: Kenhardt PV 1, Kenhardt PV 2, Kenhardt PV 3, Kenhardt PV 1 – Transmission Line, Kenhardt PV 2 – Transmission Line, and Kenhardt PV 3 – Transmission Line. Aparte verslae sal ook vir elke projek saamgestel en uitgestuur word.

Om te verseker dat u vir die projekte as 'n Belangstellende en Geaffekteerde Party (B&GP) geregistreer word of om enige kwessie uit te lig wat u met die projekte het, word u vriendelik versoek om te registreer vir die projekte en u kommentaar aan WNNR se verteenwoordiger (inligting hieronder) te stuur. Verdere inligting sal ook deur die loop van die projek op die projek se webtuiste beskikbaar wees: <http://www.csir.co.za/eia/ScatecSolarPV/>.

'n Dokument wat verdere inligting oor die projek verskaf is vir 30 dae beskikbaar vir besigtiging en kommentaar (03 Augustus 2015 - 04 September 2015).



Om meer inligting te bekom of om te registreer as Geïnteresseerde en Belanghebbende Party (G&BP), kontak asseblief:
CSIR
 Rohaida Abed
 Posbus 17001, Congella, Durban, 4013
 Telefoon: 031 242 2300
 Faks: 031 261 2509
 E-pos: RAbed@csir.co.za

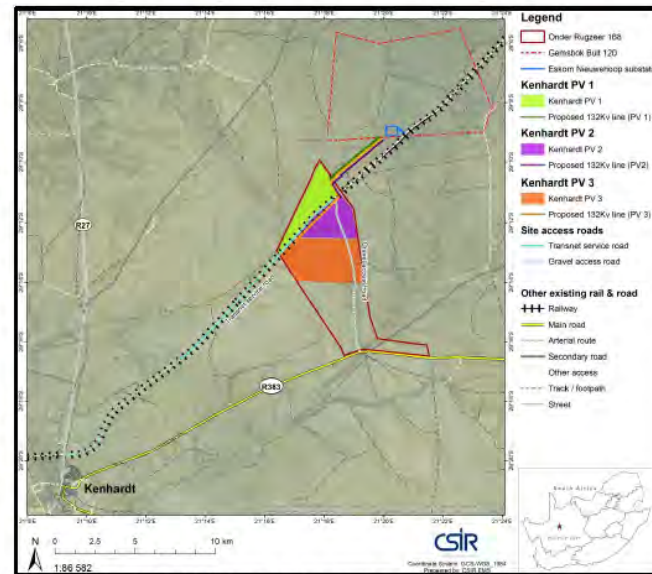

Figuur 1: Terrein Kaart wat die ligging van die voorgestelde projekte aandui

Proof of Placement of Site Notice Boards: 3 August 2015



Site Notice Board (Afrikaans) placed at the entrance to the Transnet Service Road, which serves as one of the access routes to the (preferred and alternative) project sites.

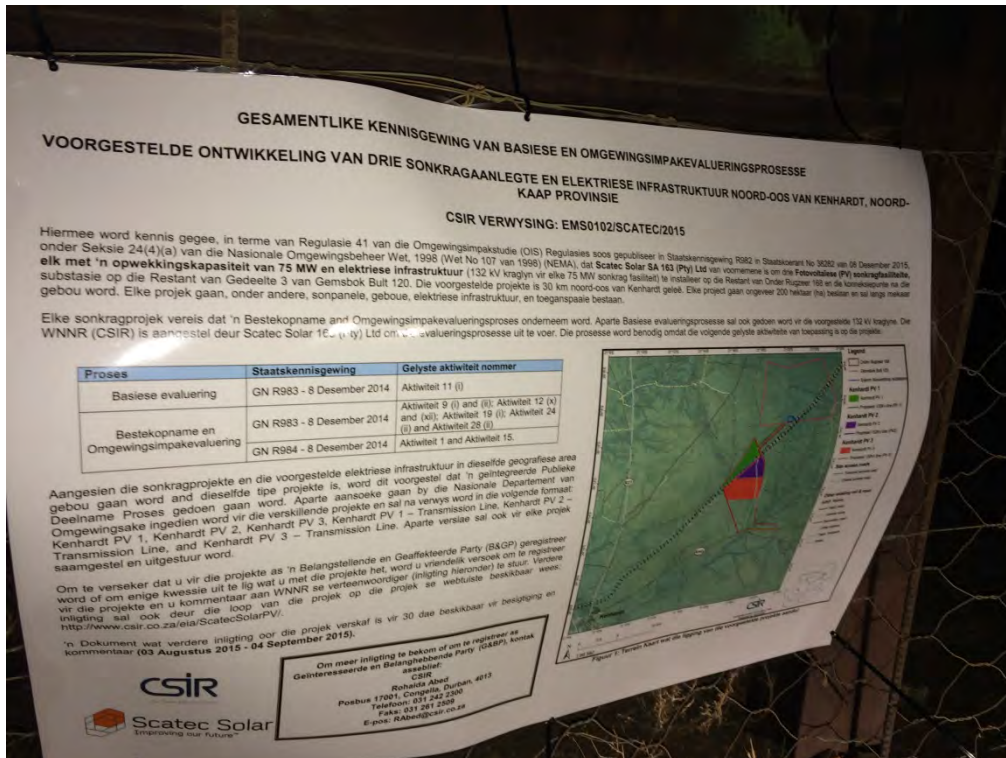

Close up image of the Site Notice Board (Afrikaans) placed at the entrance to the Transnet Service Road, which serves as one of the access routes to the (preferred and alternative) project sites.

Scoping and Environmental Impact Assessment for the proposed Development of a 75 MW Solar Photovoltaic Facility (KENHARDT PV 1) on the remaining extent of Onder Rugzeer Farm 168, north-east of Kenhardt, Northern Cape Province

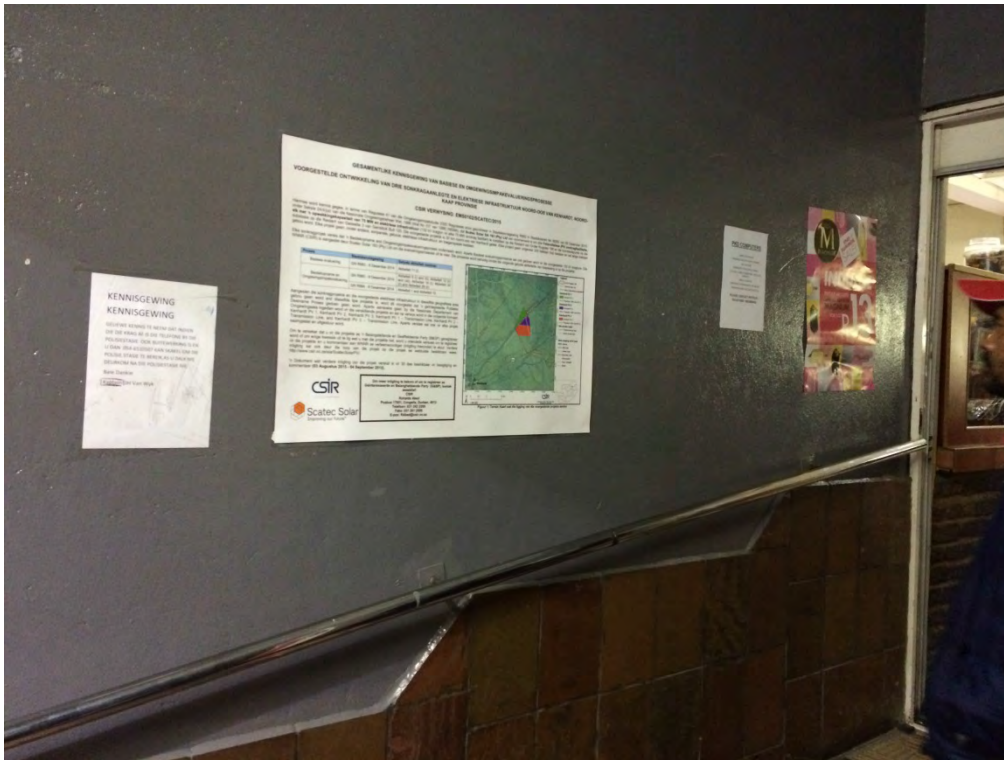

Site Notice Board (Afrikaans) placed at the Kenhardt Petrol Station.

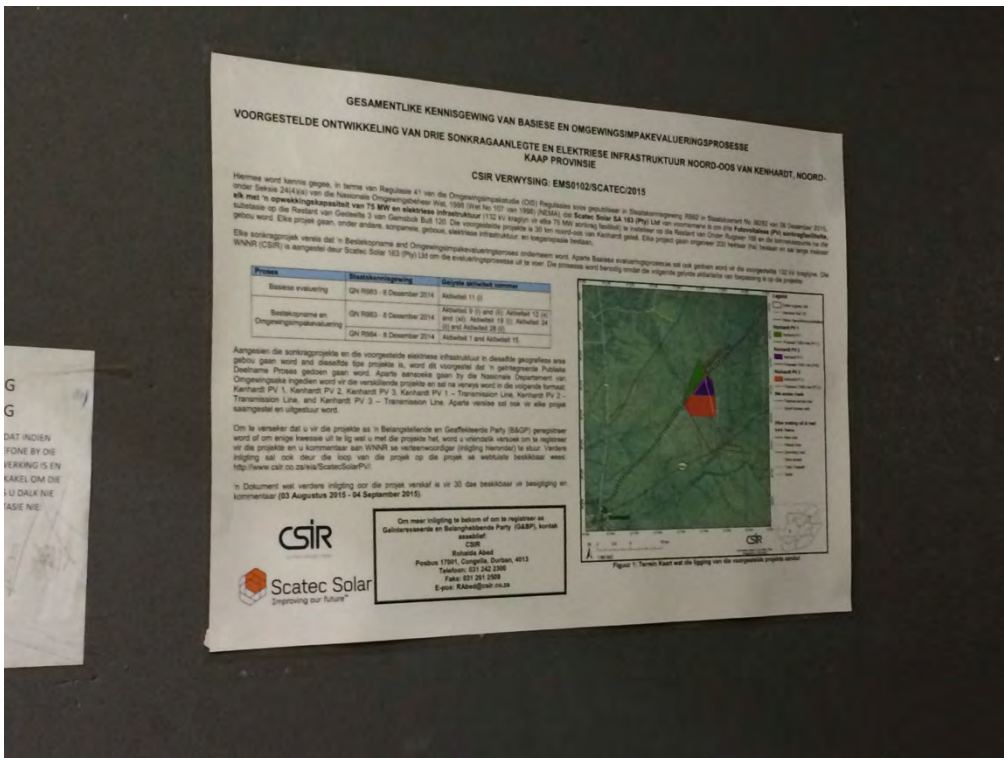

Close up image of the Site Notice Board (Afrikaans) placed at the Kenhardt Petrol Station.



Site Notice Board (English) placed at the Kai !Garib Municipality Offices in Kenhardt.

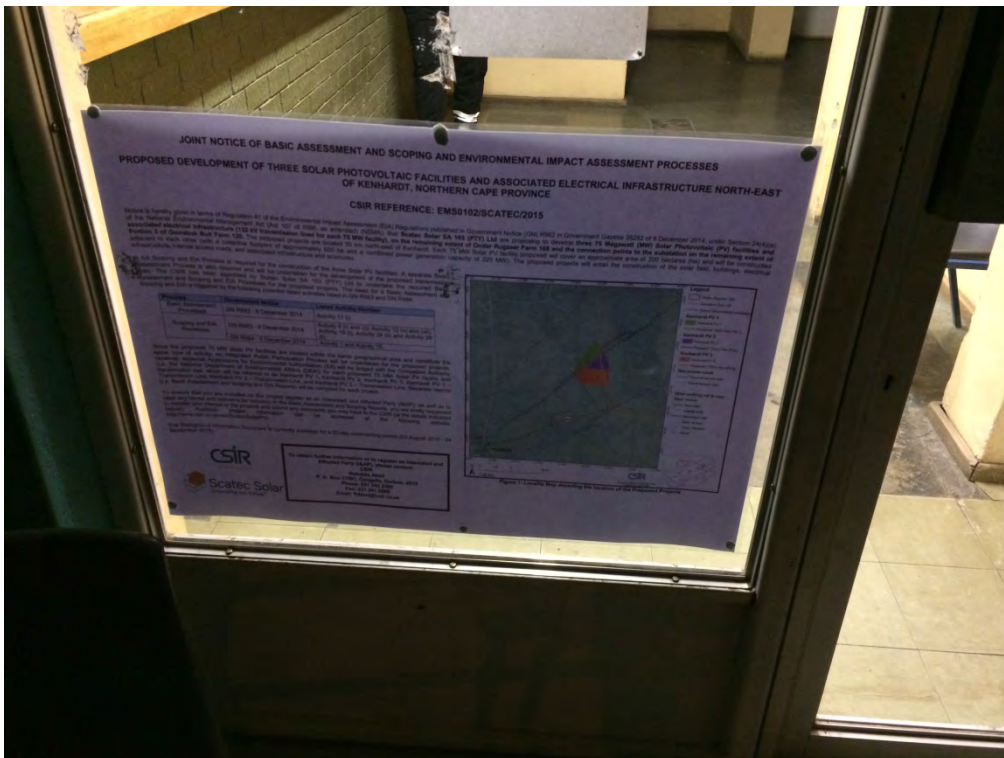

Close up image of the Site Notice Board (English) placed at the Kai !Garib Municipality Offices in Kenhardt.

Proof of Placement of Site Notice Boards: 10 September 2015



Site Notice Board (English) placed at the entrance to the Unnamed Farm Road, which serves as one of the access routes to the (preferred and alternative) project sites.

EIA REPORT

APPENDIX G:

Copies of Correspondence from
I&APs during the Scoping Phase

Scoping and Environmental Impact Assessment for the Proposed Development of a 75 MW Solar Photovoltaic Facility (KENHARDT PV 1) on the remaining extent of Onder Rugzeer Farm 168, north-east of Kenhardt, Northern Cape Province

Copies of Correspondence from I&APs during the Project Initiation Phase

From: Samantha De la Fontaine <sdelafontaine@gmail.com>
To: <RAbed@csir.co.za>
CC: Elsabe Swart <elsabe.dtec@gmail.com>
Date: 29/07/2015 13:37
Subject: I&AP: Three proposed solar PV facilities NE of Kenhardt

Dear Rohaida

Kindly register me as an I&AP for the proposed development with CSIR
Reference: EMS0102/SCATEC/2015.

Kind regards

Samantha

Samantha De la Fontaine
District Ecologist (Candidate Scientist)

Northern Cape Department of Environment and Nature Conservation
Provincial Building (First Floor)

Corner of Rivier & Nelson Mandela Road
Upington
8800

E-mail: sdelafontaine@gmail.com <sdelafontaine@gmail.com>

From: "Karen Low" <karen@mulilo.com>
To: "'Rohaida Abed'" <RAbed@csir.co.za>
Date: 30/07/2015 09:27
Subject: RE: Notice of BA and EIA Process - Solar PV Facilities and Associated Electrical Infrastructure, Northern Cape
Attachments: SBIZHUB10815073009220.pdf

Dear Rohaida,

Attached please find the completed comment and registration form.

Regards,

Karen

Karen Low (*Pri. Sci. Nat.*)

Environmental Manager



Tel: +27 21 934 5278 **Fax:** +27 21 935 0505 **Email:** karen@mulilo.com

Physical: 303c Execujet Business Centre Tower Road Cape Town International Airport South Africa 7525

Postal: PO Box 50 Cape Town International Airport South Africa 7525

From: Rohaida Abed [mailto:RAbed@csir.co.za]
Sent: 29 July 2015 4:01 pm
To: Rohaida Abed <RAbed@csir.co.za>
Subject: Notice of BA and EIA Process - Solar PV Facilities and Associated Electrical Infrastructure, Northern Cape

Dear Stakeholders and Interested and Affected Parties

NOTICE OF BASIC ASSESSMENT AND SCOPING AND ENVIRONMENTAL IMPACT ASSESSMENT FOR THE PROPOSED DEVELOPMENT OF THREE SOLAR PHOTOVOLTAIC FACILITIES AND ASSOCIATED ELECTRICAL INFRASTRUCTURE NORTH-EAST OF KENHARDT, NORTHERN CAPE PROVINCE

Competent Authority: National Department of Environmental Affairs

CSIR Reference: EMS0102/SCATEC/2015

This e-mail correspondence serves to inform you of the initiation of a Basic Assessment (BA) Process and Scoping and Environmental Impact Assessment (EIA) Process for the above-mentioned proposed project, located approximately 80 km south of Upington and 30 km north-east of Kenhardt within the !Kheis Local Municipality, Northern Cape Province. The Project Applicant is Scatec Solar SA 163 (PTY) Ltd (hereinafter referred to as Scatec Solar). The CSIR has been appointed by Scatec Solar to undertake the required BA Process, and Scoping and EIA Process.

A full Scoping and EIA Process is required for the development of three 75 Megawatt (MW) Solar Photovoltaic (PV) power generation facilities on the remaining extent of Onder Rugzeer Farm 168. A separate BA Process is also required and will be undertaken for the development of three transmission lines and the connection points to the Eskom Nieuwehoop Substation (which is currently being constructed) on the remaining extent of Portion 3 of Gemsbok Bult Farm 120.

The proposed 75 MW Solar PV facilities and transmission lines are located within the same geographical area and constitute the same type of activity; hence an integrated Public Participation Process will be undertaken. However, separate Applications for Environmental Authorisation will be lodged with the National Department of Environmental Affairs (DEA) for each proposed 75 MW Solar PV facility and transmission line. Furthermore, separate BA, Scoping and EIA Reports will be compiled for each project, which will be referred to as:

Scoping and EIA Processes: Proposed 75 MW Solar PV Facilities	BA Processes: Proposed 132 kV Transmission Lines
- Kenhardt PV 1	- Kenhardt PV 1 – Transmission Line
- Kenhardt PV 2	- Kenhardt PV 2 – Transmission Line
- Kenhardt PV 3	- Kenhardt PV 3 – Transmission Line

The proposed projects are being assessed in terms of the National Environmental Management Act (Act 107 of 1998), as amended (NEMA), and the NEMA EIA Regulations, published in Government Notice (GN) R982, R983, R984 and R985 on 8 December 2014.

Please find attached the following:

- Background Information Document (BID);
- Letter 1 to Interested & Affected Parties (I&APs); and
- Comment and Registration Form.

The BID, which provides an overview of the proposed project, is being released to Stakeholders and I&APs for a 30-day comment period extending from **30 July 2015** to **31 August 2015**.

Hard copies of the above-mentioned documents have also been sent to those of you for which postal addresses are available.

In addition, the above-mentioned project information can be accessed at the following website: <http://www.csir.co.za/eia/ScatecSolarPV/>

Kindly ensure that all comments are submitted to the CSIR Project Manager (details provided below) by **31 August 2015**.

Thank you and kind regards,

Rohaida Abed

CSIR - Environmental Management Services
P. O. Box 17001, Congella, Durban, 4013
Tel: 031 242 2300
Fax: 031 261 2509
Email: RAbed@csir.co.za

Beste Belanghebbende en Geïnteresseerde Party

GESAMENTLIKE KENNISGEWING VAN BASIESE EN OMGEWINGSIMPAKEVALUERINGSPROSESSE VIR DIE VOORGESTELDE ONTWIKKELING VAN DRIE SONKRAGAAANLEGTE EN ELEKTRIESE INFRASTRUKTUUR NOORD-OOS VAN KENHARDT, NOORD- KAAP PROVINSIE

Bevoegde Owerheid: Die Nasionale Departement van Omgewingsake

WNNR/CSIR verwysingsnommer: EMS0102/SCATEC/2015

Hierdie e-pos korrespondensie se doel is om u in kennis te stel van die Basiese evaluerings- en Bestek en Omgewingsimpakevalueringproses vir die bogenoemde projekte, wat 80 km suid van Upington en 30 km noord-oos van Kenhardt in die !Kheis munisipaliteit voorgestel word. Die Aansoeker vir die projek is Scatec Solar SA 163 (PTY) Ltd ("Scatec Solar"). Die WNNR is aangestel deur Scatec Solar om die Basiese evaluerings- en Bestek en Omgewingsimpakevalueringproses vir die bogenoemde projekte uit te voer.

'n Bestek en Omgewingsimpakevalueringproses word vereis vir elk van die drie 75 MW Fotovoltaiese (PV) sonkragfasiliteite wat op die plaas Restant van Onder Rugzeer 168 voorgestel word. Aparte Basiese evalueringprosesse word ook vereis vir die voorgestelde 132 kV kraglyne en die konneksiepunte aan die Eskom Nieuwehoop Substasie (wat tans gebou word) op die plaas Restant van Gedeelte 3 van Gembok Bult 120.

Aangesien die sonkragprojekte en die voorgestelde elektriese infrastruktuur in dieselfde geografiese area gebou gaan word en dieselfde tipe projekte is, word dit voorgestel dat 'n geïntegreerde Publieke Deelname Proses gedoen gaan word. Aparte aansoeke gaan by die Nasionale Departement van Omgewingsake ingedien word vir die verskillende projekte en aparte verslae sal ook vir elke projek saamgestel en uitgestuur word. Die projekte sal na verwys word as:

Bestek en Omgewingsimpakevalueringproses: Voorgestelde drie 75 MW PV sonkragprojekte	Basiese evalueringprosesse: Voorgestelde drie 132 kV kraglyne
- Kenhardt PV 1	- Kenhardt PV 1 – Transmission Line
- Kenhardt PV 2	- Kenhardt PV 2 – Transmission Line
- Kenhardt PV 3	- Kenhardt PV 3 – Transmission Line

Die voorgestelde projekte sal ge-evalueer word volgens die Nasionale Omgewingsbeheer Wet, 1998 (Wet No 107 van 1998) (NEMA) en die Omgewingsimpakstudie (OIS) Regulasies soos gepubliseer in Staatskenningsgewing R982 in Staatskoerant No 38282 van 08 Desember 2014.

Vind asseblief aangeheg die volgende:

- Beskrywing van die projek (word na verwys as die "BID")
- Brief aan die Belanghebbende en Geïnteresseerde Partye (B&GP'e)
- Kommentaar en Registrasievorm

Die BID, wat dien as agtergrond van die projek, bevat 'n beskrywing van die projek, die gelyste aktiwiteite en is vir 30-dae beskikbaar vir oorsig en kommentaar (**30 Julie 2015 - 31 Augustus 2015**). 'n Harde kopie van die bogenoemde dokumente is ook gestuur aan diegene vir wie ons posadresse het. Inligting van die projek is ook beskikbaar op die projekwebtuiste: <http://www.csir.co.za/eia/ScatecSolarPV/>.

Ons versoek graag dat alle kommentaar aan die WNNR Projekbestuurder (kontakbesonderhede onder aangedui) teen **31 Augustus 2015** verskaf word.

By voorbaat dankie,

Rohaida Abed

CSIR - Environmental Management Services
Posbus 17001, Congella, Durban, 4013
Tel: 031 242 2300
Faks: 031 261 2509
E-pos: RAbed@csir.co.za

From: "Melanie Miles" <MelanieM@L2B.co.za>
To: <RAbed@csir.co.za>
Date: 03/08/2015 10:25
Subject: Proposed Development of Three Solar Photovoltaic Facilities and Associated Electrical Infrastructure

Good Morning,

Your company is currently conducting an Environmental Impact Assessment for the Proposed Development of Three Solar Photovoltaic Facilities and Associated Electrical Infrastructure North East of Kenhardt. Please could you forward me the BID for this application and register me as a Interested & Affected party?

Thanking you in anticipation of a favourable response.

Kindest Regards,

Melanie Miles
Content Researcher
MelanieM@L2B.co.za

Leads 2 Business (www.L2B.co.za)

0860836337 or 0860 TENDER
Fax: 033 343 5882

From: "Mei Melinda (UPN)" <MeiM@dws.gov.za>
To: Rohaida Abed <RAbed@csir.co.za>
CC: Cloete Shaun <CloeteS@dws.gov.za>
Date: 04/08/2015 13:48
Subject: Hard Copies: Notice of BA and EIA Process - Solar PV Facilities and Associated Electrical Infrastructure, Northern Cape

Good morning Mr. Abed

Your notice received with regards to Basic Assessment; Scoping and Environmental Impact Assessment for the Proposed Development of the three Solar Photovoltaic Facilities and Associated Electrical Infrastructure; North-East of Kenhardt; Northern Cape is of reference.

DWS requires you to forward hard copies of the above mentioned project to either of the following address:

Physical Address:
Department Of Water and Sanitation
Louisvale Road Upington
8801

OR

Postal Address:
Department Of Water and Sanitation
Private Bag X 5912
Upington
8800

Your co-operation and assistance is highly appreciated.

With kind regards,

Melinda Mei
Senior Administration Clerk
Water Quality Management: Lower Orange Water Management Area
Tel: 054 338 5836
Fax: 054 334 0205
Mail: MeiM@dwa.gov.za



From: Rohaida Abed [mailto:RAbed@csir.co.za]
Sent: 29 July 2015 4:01 pm
To: Rohaida Abed <RAbed@csir.co.za>
Subject: Notice of BA and EIA Process - Solar PV Facilities and Associated Electrical Infrastructure, Northern Cape

Dear Stakeholders and Interested and Affected Parties

NOTICE OF BASIC ASSESSMENT AND SCOPING AND ENVIRONMENTAL IMPACT ASSESSMENT FOR THE PROPOSED DEVELOPMENT OF THREE SOLAR PHOTOVOLTAIC FACILITIES AND ASSOCIATED ELECTRICAL INFRASTRUCTURE NORTH-EAST OF KENHARDT, NORTHERN CAPE PROVINCE

Competent Authority: National Department of Environmental Affairs

CSIR Reference: EMS0102/SCATEC/2015

This e-mail correspondence serves to inform you of the initiation of a Basic Assessment (BA) Process and Scoping and Environmental Impact Assessment (EIA) Process for the above-mentioned proposed project, located approximately 80 km south of Upington and 30 km north-east of Kenhardt within the !Kheis Local Municipality, Northern Cape Province. The Project Applicant is Scatec Solar SA 163 (PTY) Ltd (hereinafter referred to as Scatec Solar). The CSIR has been appointed by Scatec Solar to undertake the required BA Process, and Scoping and EIA Process.

A full Scoping and EIA Process is required for the development of three 75 Megawatt (MW) Solar Photovoltaic (PV) power generation facilities on the remaining extent of Onder Rugzeer Farm 168. A separate BA Process is also required and will be undertaken for the development of three transmission lines and the connection points to the Eskom Nieuwehoop Substation (which is currently being constructed) on the remaining extent of Portion 3 of Gemsbok Bult Farm 120.

Scoping and Environmental Impact Assessment for the proposed Development of a 75 MW Solar Photovoltaic Facility (KENHARDT PV 1) on the remaining extent of Onder Rugzeer Farm 168, north-east of Kenhardt, Northern Cape Province

The proposed 75 MW Solar PV facilities and transmission lines are located within the same geographical area and constitute the same type of activity; hence an integrated Public Participation Process will be undertaken. However, separate Applications for Environmental Authorisation will be lodged with the National Department of Environmental Affairs (DEA) for each proposed 75 MW Solar PV facility and transmission line. Furthermore, separate BA, Scoping and EIA Reports will be compiled for each project, which will be referred to as:

Scoping and EIA Processes: Proposed 75 MW Solar PV Facilities	BA Processes: Proposed 132 kV Transmission Lines
- Kenhardt PV 1	- Kenhardt PV 1 – Transmission Line
- Kenhardt PV 2	- Kenhardt PV 2 – Transmission Line
- Kenhardt PV 3	- Kenhardt PV 3 – Transmission Line

The proposed projects are being assessed in terms of the National Environmental Management Act (Act 107 of 1998), as amended (NEMA), and the NEMA EIA Regulations, published in Government Notice (GN) R982, R983, R984 and R985 on 8 December 2014.

Please find attached the following:

- Background Information Document (BID);
- Letter 1 to Interested & Affected Parties (I&APs); and
- Comment and Registration Form.

The BID, which provides an overview of the proposed project, is being released to Stakeholders and I&APs for a 30-day comment period extending from **30 July 2015** to **31 August 2015**.

Hard copies of the above-mentioned documents have also been sent to those of you for which postal addresses are available.

In addition, the above-mentioned project information can be accessed at the following website: <http://www.csir.co.za/eia/ScatecSolarPV/>

Kindly ensure that all comments are submitted to the CSIR Project Manager (details provided below) by **31 August 2015**.

Thank you and kind regards,

Rohaida Abed

CSIR - Environmental Management Services
P. O. Box 17001, Congella, Durban, 4013
Tel: 031 242 2300
Fax: 031 261 2509
Email: RAbed@csir.co.za

Beste Belanghebbende en Geïnteresseerde Party

GESAMENTLIKE KENNISGEWING VAN BASIESE EN OMGEWINGSIMPAKEVALUERINGSPROSESSE VIR DIE VOORGESTELDE ONTWIKKELING VAN DRIE SONKRAGAAANLEGTE EN ELEKTRIESE INFRASTRUKTUUR NOORD-OOS VAN KENHARDT, NOORD- KAAP PROVINSIE

Bevoegde Owerheid: Die Nasionale Departement van Omgewingsake

WNNR/CSIR verwysingsnommer: EMS0102/SCATEC/2015

Hierdie e-pos korrespondensie se doel is om u in kennis te stel van die Basiese evaluerings- en Bestek en Omgewingsimpakevalueringproses vir die bogenoemde projekte, wat 80 km suid van Upington en 30 km noord-oos van Kenhardt in die !Kheis munisipaliteit voorgestel word. Die Aansoeker vir die projek is Scatec Solar SA 163 (PTY) Ltd ("Scatec Solar"). Die WNNR is aangestel deur Scatec Solar om die Basiese evaluerings- en Bestek en Omgewingsimpakevalueringproses vir die bogenoemde projekte uit te voer.

'n Bestek en Omgewingsimpakevalueringproses word vereis vir elk van die drie 75 MW Fotovoltaïese (PV) sonkragfasiliteite wat op die plaas Restant van Onder Rugzeer 168 voorgestel word. Aparte Basiese evalueringprosesse word ook vereis vir die voorgestelde 132 kV kraglyne en die konneksiepunte aan die Eskom Nieuwehoop Substasie (wat tans gebou word) op die plaas Restant van Gedeelte 3 van Gembok Bult 120.

Aangesien die sonkragprojekte en die voorgestelde elektriese infrastruktuur in dieselfde geografiese area gebou gaan word en dieselfde tipe projekte is, word dit voorgestel dat 'n geïntegreerde Publieke Deelname Proses gedoen gaan word. Aparte aansoeke gaan by die Nasionale Departement van Omgewingsake ingedien word vir die verskillende projekte en aparte verslae sal ook vir elke projek saamgestel en uitgestuur word. Die projekte sal na verwys word as:

Bestek en Omgewingsimpakevalueringproses: Voorgestelde drie 75 MW PV sonkragprojekte	Basiese evalueringprosesse: Voorgestelde drie 132 kV kraglyne
- Kenhardt PV 1	- Kenhardt PV 1 – Transmission Line
- Kenhardt PV 2	- Kenhardt PV 2 – Transmission Line

Bestek en Omgewingsimpakevalueringproses: Voorgestelde drie 75 MW PV sonkragprojekte	Basiese evalueringprosesse: Voorgestelde drie 132 kV kraglyne
- Kenhardt PV 3	- Kenhardt PV 3 – Transmission Line

Die voorgestelde projekte sal ge-evalueer word volgens die Nasionale Omgewingsbeheer Wet, 1998 (Wet No 107 van 1998) (NEMA) en die Omgewingsimpakstudie (OIS) Regulasies soos gepubliseer in Staatskennisgewing R982 in Staatskoerant No 38282 van 08 Desember 2014.

Vind asseblief aangeheg die volgende:

- Beskrywing van die projek (word na verwys as die "BID")
- Brief aan die Belanghebbende en Geïnteresseerde Partye (B&GP'e)
- Kommentaar en Registrasievorm

Die BID, wat dien as agtergrond van die projek, bevat 'n beskrywing van die projek, die gelyste aktiwiteite en is vir 30-dae beskikbaar vir oorsig en kommentaar (**30 Julie 2015 - 31 Augustus 2015**). 'n Harde kopie van die bogenoemde dokumente is ook gestuur aan diegene vir wie ons posadresse het. Inligting van die projek is ook beskikbaar op die projekwebtuiste: <http://www.csir.co.za/eia/ScatecSolarPV/>.

Ons versoek graag dat alle kommentaar aan die WNNR Projekbestuurder (kontakbesonderhede onder aangedui) teen **31 Augustus 2015** verskaf word.

By voorbaat dankie,

Rohaida Abed

CSIR - Environmental Management Services
Posbus 17001, Congella, Durban, 4013
Tel: 031 242 2300
Faks: 031 261 2509
E-pos: RAbed@csir.co.za

Scoping and Environmental Impact Assessment for the proposed Development of a 75 MW Solar Photovoltaic Facility (KENHARDT PV 1) on the remaining extent of Onder Rugzeer Farm 168, north-east of Kenhardt, Northern Cape Province

From: "Marina Lourens Transnet Freight Rail SLD" <Marina.Lourens@transnet.net>
To: "RAbed@csir.co.za" <RAbed@csir.co.za>
Date: 19/08/2015 15:54
Subject: NOTICE OF BA and EIA Process - Solar PV Facilities and Associated Electrical Infrastructure, Northern Cape
Attachments: 2773_001.pdf

Letter regarding issued/concerns



19 August 2015

Rohaida Abed
CSIR
P.O. BOX 17001
Congella
DURBAN
4013

Gilbert Nortier
Depot Engineering Manager
Private Bag X11
Vredenburg
7380

Dear Rohaida

RE: ISSUES/CONCERNS TO PROPOSED DEVELOPMENT OF THREE SOLAR PHOTOVOLTAIC FACILITIES AND ASSOCIATED ELECTRICAL INFRASTRUCTURE NORTH-EAST OF KENHARDT, NORTHERN CAPE PROVINCE

Your e-mail of 29 July 2015 refers.

The following immediate concerns are:

Possible glare from the solar panels which may influence the Train Drivers and staff travel on the TFR service road.

Future concerns:

During construction, planned access routes to the facilities that might influence TFR (Dust on High Voltage Electrical Equipment).

The location of the High Voltage transmission lines.

Level crossing requirements (High risk of accidents).

During maintenance same issues as above.

Regards

GILBERT NORTIER
DEM

Transnet SOC Ltd	Carlton Centre	P.O. Box 72501
Registration Number	150 Commissioner	Parkview, Johannesburg
1990/000900/30	Street	South Africa, 2122
	Johannesburg	T +27 11 308 3001
	2001	F +27 11 308 2638

Directors: LC Mabaso (Chairperson) B Molefe* (Group Chief Executive) Y Forbes GJ Mahalela PEB Matheka N Moolo ZA Nagdee VM Nkonyane
MR Seleke SD Shane BG Stagman PG Williams A Sigh* (Group Chief Financial Officer)

*Executive

Group Company Secretary: ANC Ceiba

www.transnet.net

Scoping and Environmental Impact Assessment for the proposed Development of a 75 MW Solar Photovoltaic Facility (KENHARDT PV 1) on the remaining extent of Onder Rugzeer Farm 168, north-east of Kenhardt, Northern Cape Province

From: <jdbhenrohn@gmail.com>
To: <RABed@csir.co.za>
Date: 25/08/2015 08:41
Subject: CSIR REF EMS0102/SCATEC/2015

Good morning Rohaida
I want to register for the facility because I support the project.

John de Bruin - Henrohn Security
Sent from my Nokia phone

From: Adrian Tiplady <atiplady@ska.ac.za>
To: Rohaida Abed <RABed@csir.co.za>
CC: Tshegofatso Monama <temonama@ska.ac.za>
Date: 02/09/2015 11:44
Subject: Re: Notice of BA and EIA Process - Solar PV Facilities and Associated Electrical Infrastructure, Northern Cape
Attachments: Letter reg Establishment of Kenhardt 3PV CSIR.pdf

Dear Rohaida,

Please find attached comment.

Regards,

Adrian

On 29/07/2015 4:01 PM, Rohaida Abed wrote:

Dear Stakeholders and Interested and Affected Parties

NOTICE OF BASIC ASSESSMENT AND SCOPING AND ENVIRONMENTAL IMPACT ASSESSMENT FOR THE PROPOSED DEVELOPMENT OF THREE SOLAR PHOTOVOLTAIC FACILITIES AND ASSOCIATED ELECTRICAL INFRASTRUCTURE NORTH-EAST OF KENHARDT, NORTHERN CAPE PROVINCE

Competent Authority: National Department of Environmental Affairs

CSIR Reference: EMS0102/SCATEC/2015

This e-mail correspondence serves to inform you of the initiation of a Basic Assessment (BA) Process and Scoping and Environmental Impact Assessment (EIA) Process for the above-mentioned proposed project, located approximately 80 km south of Upington and 30 km north-east of Kenhardt within the !Kheis Local Municipality, Northern Cape Province. The Project Applicant is Scatec Solar SA 163 (PTY) Ltd (hereinafter referred to as Scatec Solar). The CSIR has been appointed by Scatec Solar to undertake the required BA Process, and Scoping and EIA Process.

A full Scoping and EIA Process is required for the development of three 75 Megawatt (MW) Solar Photovoltaic (PV) power generation facilities on the remaining extent of Onder Rugzeer Farm 168. A separate BA Process is also required and will be undertaken for the development of three transmission lines and the connection points to the Eskom Nieuwehoop Substation (which is currently being constructed) on the remaining extent of Portion 3 of Gemsbok Bult Farm 120.

The proposed 75 MW Solar PV facilities and transmission lines are located within the same geographical area and constitute the same type of activity; hence an integrated Public Participation Process will be undertaken. However, separate Applications for Environmental Authorisation will be lodged with the National Department of Environmental Affairs (DEA) for each proposed 75 MW Solar PV facility and transmission line. Furthermore, separate BA, Scoping and EIA Reports will be compiled for each project, which will be referred to as:

Scoping and EIA Processes: Proposed 75 MW Solar PV Facilities	BA Processes: Proposed 132 kV Transmission Lines
- Kenhardt PV 1	- Kenhardt PV 1 – Transmission Line
- Kenhardt PV 2	- Kenhardt PV 2 – Transmission Line
- Kenhardt PV 3	- Kenhardt PV 3 – Transmission Line

The proposed projects are being assessed in terms of the National Environmental Management Act (Act 107 of 1998), as amended (NEMA), and the NEMA EIA Regulations, published in Government Notice (GN) R982, R983, R984 and R985 on 8 December 2014.

Please find attached the following:
- Background Information Document (BID);
- Letter 1 to Interested & Affected Parties (I&APs); and
- Comment and Registration Form.

The BID, which provides an overview of the proposed project, is being released to Stakeholders and I&APs for a 30-day comment period extending from **30 July 2015 to 31 August 2015**.

Hard copies of the above-mentioned documents have also been sent to those of you for which postal addresses are available.

In addition, the above-mentioned project information can be accessed at the following website: <http://www.csir.co.za/eia/ScatecSolarPV/>

Kindly ensure that all comments are submitted to the CSIR Project Manager (details provided below) by **31 August 2015**.

Thank you and kind regards,

Rohaida Abed

CSIR - Environmental Management Services
P. O. Box 17001, Congella, Durban, 4013
Tel: 031 242 2300
Fax: 031 261 2509
Email: RAbed@csir.co.za

Beste Belanghebbende en Geïnteresseerde Party

GESAMENTLIKE KENNISGEWING VAN BASIESE EN OMGEWINGSIMPAKEVALUERINGSPROSESSE VIR DIE VOORGESTELDE ONTWIKKELING VAN DRIE SONKRAGAAANLEGTE EN ELEKTRIESE INFRASTRUKTUUR NOORD-OOS VAN KENHARDT, NOORD- KAAP PROVINSIE

Bevoegde Owerheid: Die Nasionale Departement van Omgewingsake

WNNR/CSIR verwysingsnommer: EMS0102/SCATEC/2015

Hierdie e-pos korrespondensie se doel is om u in kennis te stel van die Basiese evaluerings- en Bestek en Omgewingsimpakevalueringproses vir die bogenoemde projekte, wat 80 km suid van Upington en 30 km noord-oos van Kenhardt in die !Kheis munisipaliteit voorgestel word. Die Aansoeker vir die projek is Scatec Solar SA 163 (PTY) Ltd ("Scatec Solar"). Die WNNR is aangestel deur Scatec Solar om die Basiese evaluerings- en Bestek en Omgewingsimpakevalueringproses vir die bogenoemde projekte uit te voer.

'n Bestek en Omgewingsimpakevalueringproses word vereis vir elk van die drie 75 MW Fotovoltaïese (PV) sonkragfasiliteite wat op die plaas Restant van Onder Rugzeer 168 voorgestel word. Aparte Basiese evalueringprosesse word ook vereis vir die voorgestelde 132 kV kraglyne en die konneksiepunte aan die Eskom Nieuwehoop Substasie (wat tans gebou word) op die plaas Restant van Gedeelte 3 van Gembok Bult 120.

Aangesien die sonkragprojekte en die voorgestelde elektriese infrastruktuur in dieselfde geografiese area gebou gaan word en dieselfde tipe projekte is, word dit voorgestel dat 'n geïntegreerde Publieke Deelname Proses gedoen gaan word. Aparte aansoeke gaan by die Nasionale Departement van Omgewingsake ingedien word vir die verskillende projekte en aparte verslae sal ook vir elke projek saamgestel en uitgestuur word. Die projekte sal na verwys word as:

Bestek en Omgewingsimpakevalueringproses: Voorgestelde drie 75 MW PV sonkragprojekte	Basiese evalueringprosesse: Voorgestelde drie 132 kV kraglyne
- Kenhardt PV 1	- Kenhardt PV 1 – Transmission Line
- Kenhardt PV 2	- Kenhardt PV 2 – Transmission Line
- Kenhardt PV 3	- Kenhardt PV 3 – Transmission Line

Die voorgestelde projekte sal ge-evalueer word volgens die Nasionale Omgewingsbeheer Wet, 1998 (Wet No 107 van 1998) (NEMA) en die Omgewingsimpakstudie (OIS) Regulasies soos gepubliseer in Staatskennisgewing R982 in Staatskoerant No 38282 van 08 Desember 2014.

Vind asseblief aangeheg die volgende:

- Beskrywing van die projek (word na verwys as die "BID")
- Brief aan die Belanghebbende en Geïnteresseerde Partye (B&GP'e)
- Kommentaar en Registrasievorm

Die BID, wat dien as agtergrond van die projek, bevat 'n beskrywing van die projek, die gelyste aktiwiteite en is vir 30-dae beskikbaar vir oorsig en kommentaar (**30 Julie 2015 - 31 Augustus 2015**). 'n Harde kopie van die bogenoemde dokumente is ook gestuur aan diegene vir wie ons posadresse het. Inligting van die projek is ook beskikbaar op die projekwebtuiste: <http://www.csir.co.za/eia/ScatecSolarPV/>.

Ons versoek graag dat alle kommentaar aan die WNNR Projekbestuurder (kontakbesonderhede onder aangedui) teen **31 Augustus 2015** verskaf word.

By voorbaat dankie,
Rohaida Abed

CSIR - Environmental Management Services
Posbus 17001, Congella, Durban, 4013
Tel: 031 242 2300
Faks: 031 261 2509
E-pos: RAbed@csir.co.za



17 Baker Street
Rosebank
Johannesburg
South Africa
2195

Tel: +27 (0) 11 442 2434
Fak: +27 (0) 11 442 2454
Email: atprod@ska.ac.za

Rohaida Abed
CSIR-Environmental Management Services
P. O. Box 17001
Congella
Durban
4013

E-mail: RAbed@csir.co.za

Date: 17 August 2015

Dear Rohaida,

Re: DEVELOPMENT OF THREE SOLAR PHOTOVOLTAIC FACILITIES AND ASSOCIATED ELECTRICAL INFRASTRUCTURE NORTH-EAST OF KENHARDT, NORTHERN CAPE PROVINCE (CSIR REFERENCE: EMS0102/SCATEC/2015)

This letter is in response to your email request, to provide an assessment on the potential development of three solar PV electricity generation facilities in the Northern Cape Province and the risk they may pose on the Square Kilometre Array Project.

A high level risk assessment has been conducted at the South African SKA Project Office to determine the potential impact of such facilities on the Square Kilometre Array. This letter serves to confirm the outcomes of the risk assessment, and proposals for any future investigations associated with this facility.

- I. The location of the proposed facility has been provided in the background information document compiled by CSIR ,
- II. The nearest SKA station has been identified as SKA Station ID 2362, at approximately 20 km from the proposed installation;
- III. Based on distance to the nearest SKA station, and the information currently available on the detailed design of the PV installations, these facilities poses a medium to high risk of detrimental impact on the SKA;
- IV. Any transmitters that are to be established, or have been established, at the site for the purposes of voice and data communication will be required to comply with the relevant AGA regulations concerning the restriction of use of the radio frequency spectrum that applies in the area concerned;
- V. As a result of the medium to high risk associated with the PV facilities, The SKA project office recommends that further EMI and RFI detailed studies be conducted as significant mitigation measures would be required to lower the risk of detrimental impact to an acceptable level. The South African SKA



SOUTH AFRICA SQUARE KILOMETRE ARRAY
SKA South Africa Project Office





Project Office would like to be kept informed of progress with this project, and reserves the right to further risk assessments at a later stage.

This technical advice is provided by the South African SKA Project Office on the basis of the protection requirements of the SKA in South Africa, and does not constitute legal approval of the renewable energy projects in terms of the Astronomy Geographic Advantage Act, the Management Authority, and its regulations or declarations.

Regards,

A handwritten signature in black ink, appearing to read 'Adrian Tiplady'.

Dr. Adrian Tiplady
Head: Strategy
SKA South Africa
Tel: 011 442 2434
Fax: 011 442 2454
atiplady@ska.ac.za



SOUTH AFRICA SQUARE KILOMETRE ARRAY
SKA South Africa Project Office



Scoping and Environmental Impact Assessment for the proposed Development of a 75 MW Solar Photovoltaic Facility (KENHARDT PV 1) on the remaining extent of Onder Rugzeer Farm 168, north-east of Kenhardt, Northern Cape Province

From: René de Kock (WR) <Dekockr@nra.co.za>
To: "RAbed@csir.co.za" <RAbed@csir.co.za>
CC: "Nicole Abrahams (WR)" <AbrahamsN@nra.co.za>, "Colene Runkel (WR)" <Runkelc@nra.co.za>
Date: 04/09/2015 16:09
Subject: FW: Notice of BA and EIA Process - Solar PV Facilities and Associated Electrical Infrastructure, Northern Cape

Dear Rohaida Abed

Thank you for your letter dated 29 July 2015, send to Mr van der Walt.
Please note that this solar development will not impact on a national road, therefore SANRAL has no jurisdiction and have no further comment with regard to the Solar Facility.

Should any service, e.g. power line and/or water pipe will be situated within 60m from the national road or will cross the national road application should be made to SANRAL for approval in terms of the National Roads Act.

Kind regards



Ms René de Kock

Statutory Control
Tel: +27 21 957 4607
Fax: +21 946 1630
Cell:
Email: Dekockr@nra.co.za



Western Region
1 Havenga Street Oakdale Bellville
Private Bag X19
www.nra.co.za
SANRAL Fraud Hotline: 0800204558

From: Kobus van der Walt (WR)
Sent: 31 July 2015 01:58 PM
To: René de Kock (WR) <Dekockr@nra.co.za<mailto:Dekockr@nra.co.za>>
Cc: Colene Runkel (WR) <Runkelc@nra.co.za<mailto:Runkelc@nra.co.za>>
Subject: FW: Notice of BA and EIA Process - Solar PV Facilities and Associated Electrical Infrastructure, Northern Cape

fyi

From: Rohaida Abed [mailto:RAbed@csir.co.za]
Sent: 29 July 2015 04:01 PM
To: Rohaida Abed
Subject: Notice of BA and EIA Process - Solar PV Facilities and Associated Electrical Infrastructure, Northern Cape

Dear Stakeholders and Interested and Affected Parties

NOTICE OF BASIC ASSESSMENT AND SCOPING AND ENVIRONMENTAL IMPACT ASSESSMENT FOR THE PROPOSED DEVELOPMENT OF THREE SOLAR PHOTOVOLTAIC FACILITIES AND ASSOCIATED ELECTRICAL INFRASTRUCTURE NORTH-EAST OF KENHARDT, NORTHERN CAPE PROVINCE

Competent Authority: National Department of Environmental Affairs

CSIR Reference: EMS0102/SCATEC/2015

This e-mail correspondence serves to inform you of the initiation of a Basic Assessment (BA) Process and Scoping and Environmental Impact Assessment (EIA) Process for the above-mentioned proposed project, located approximately 80 km south of Upington and 30 km north-east of Kenhardt within the !Kheis Local Municipality, Northern Cape Province. The Project Applicant is Scatec Solar SA 163 (PTY) Ltd (hereinafter referred to as Scatec Solar). The CSIR has been appointed by Scatec Solar to undertake the required BA Process, and Scoping and EIA Process.

A full Scoping and EIA Process is required for the development of three 75 Megawatt (MW) Solar Photovoltaic (PV) power generation facilities on the remaining extent of Onder Rugzeer Farm 168. A separate BA Process is also required and will be undertaken for the development of three transmission lines and the connection points to the Eskom Nieuwehoop Substation (which is currently being constructed) on the remaining extent of Portion 3 of Gembok Bult Farm 120.

The proposed 75 MW Solar PV facilities and transmission lines are located within the same geographical area and constitute the same type of activity; hence an integrated Public Participation Process will be undertaken. However, separate Applications for Environmental Authorisation will be lodged with the National Department of Environmental Affairs (DEA) for each proposed 75 MW Solar PV facility and transmission line. Furthermore, separate BA, Scoping and EIA Reports will be compiled for each project, which will be referred to as:

Scoping and EIA Processes: Proposed 75 MW Solar PV Facilities	BA Processes: Proposed 132 kV Transmission Lines
- Kenhardt PV 1	- Kenhardt PV 1 – Transmission Line
- Kenhardt PV 2	- Kenhardt PV 2 – Transmission Line
- Kenhardt PV 3	- Kenhardt PV 3 – Transmission Line

The proposed projects are being assessed in terms of the National Environmental Management Act (Act 107 of 1998), as amended (NEMA), and the NEMA EIA Regulations, published in Government Notice (GN) R982, R983, R984 and R985 on 8 December 2014.

Please find attached the following:

- Background Information Document (BID);
- Letter 1 to Interested & Affected Parties (I&APs); and
- Comment and Registration Form.

The BID, which provides an overview of the proposed project, is being released to Stakeholders and I&APs for a 30-day comment period extending from **30 July 2015 to 31 August 2015**.

Hard copies of the above-mentioned documents have also been sent to those of you for which postal addresses are available.

In addition, the above-mentioned project information can be accessed at the following website: <http://www.csir.co.za/eia/ScatecSolarPV/>

Kindly ensure that all comments are submitted to the CSIR Project Manager (details provided below) by **31 August 2015**.

Thank you and kind regards,

Rohaida Abed

CSIR - Environmental Management Services
P. O. Box 17001, Congella, Durban, 4013
Tel: 031 242 2300
Fax: 031 261 2509
Email: RAbed@csir.co.za

Beste Belanghebbende en Geïnteresseerde Party

GESAMENTLIKE KENNISGEWING VAN BASIESE EN OMGEWINGSIMPAKEVALUERINGSPROSESSE VIR DIE VOORGESTELDE ONTWIKKELING VAN DRIE SONKRAGAAANLEGTE EN ELEKTRIESE INFRASTRUKTUUR NOORD-OOS VAN KENHARDT, NOORD- KAAP PROVINSIE

Bevoegde Owerheid: Die Nasionale Departement van Omgewingsake

WNNR/CSIR verwysingsnommer: EMS0102/SCATEC/2015

Hierdie e-pos korrespondensie se doel is om u in kennis te stel van die Basiese evaluerings- en Bestek en Omgewingsimpakevalueringproses vir die bogenoemde projekte, wat 80 km suid van Upington en 30 km noord-oos van Kenhardt in die !Kheis munisipaliteit voorgestel word. Die Aansoeker vir die projek is Scatec Solar SA 163 (PTY) Ltd ("Scatec Solar"). Die WNNR is aangestel deur Scatec Solar om die Basiese evaluerings- en Bestek en Omgewingsimpakevalueringproses vir die bogenoemde projekte uit te voer.

'n Bestek en Omgewingsimpakevalueringproses word vereis vir elk van die drie 75 MW Fotovoltaïese (PV) sonkragfasiliteite wat op die plaas Restant van Onder Rugzeer 168 voorgestel word. Aparte Basiese evalueringprosesse word ook vereis vir die voorgestelde 132 kV kraglyne en die konneksiepunte aan die Eskom Nieuwehoop Substasie (wat tans gebou word) op die plaas Restant van Gedeelte 3 van Gembok Bult 120.

Aangesien die sonkragprojekte en die voorgestelde elektriese infrastruktuur in dieselfde geografiese area gebou gaan word en dieselfde tipe projekte is, word dit voorgestel dat 'n geïntegreerde Publieke Deelname Proses gedoen gaan word. Aparte aansoeke gaan by die Nasionale Departement van Omgewingsake ingedien word vir die verskillende projekte en aparte verslae sal ook vir elke projek saamgestel en uitgestuur word. Die projekte sal na verwys word as:

Bestek en Omgewingsimpakevalueringproses: Voorgestelde drie 75 MW PV sonkragprojekte	Basiese evalueringprosesse: Voorgestelde drie 132 kV kraglyne
- Kenhardt PV 1 - Kenhardt PV 2 - Kenhardt PV 3	- Kenhardt PV 1 – Transmission Line - Kenhardt PV 2 – Transmission Line - Kenhardt PV 3 – Transmission Line

Die voorgestelde projekte sal ge-evalueer word volgens die Nasionale Omgewingsbeheer Wet, 1998 (Wet No 107 van 1998) (NEMA) en die Omgewingsimpakstudie (OIS) Regulasies soos gepubliseer in Staatskennisgewing R982 in Staatskoerant No 38282 van 08 Desember 2014.

Vind asseblief aangeheg die volgende:

- Beskrywing van die projek (word na verwys as die "BID")
- Brief aan die Belanghebbende en Geïnteresseerde Partye (B&GP'e)
- Kommentaar en Registrasievorm

Die BID, wat dien as agtergrond van die projek, bevat 'n beskrywing van die projek, die gelyste aktiwiteite en is vir 30-dae beskikbaar vir oorsig en kommentaar (**30 Julie 2015 - 31 Augustus 2015**). 'n Harde kopie van die bogenoemde dokumente is ook gestuur aan diegene vir wie ons posadresse het. Inligting van die projek is ook beskikbaar op die projekwebtuiste: <http://www.csir.co.za/eia/ScatecSolarPV/>.

Ons versoek graag dat alle kommentaar aan die WNNR Projekbestuurder (kontakbesonderhede onder aangedui) teen **31 Augustus 2015** verskaf word.

By voorbaat dankie,

Rohaida Abed

CSIR - Environmental Management Services
Posbus 17001, Congella, Durban, 4013
Tel: 031 242 2300
Faks: 031 261 2509
E-pos: RAbed@csir.co.za

Copies of Correspondence from I&APs during the 30-day Review of the Scoping Report

Scoping and EIA for the Proposed Development of a 75 MW Solar Photovoltaic Facility north-east of Kenhardt, Northern Cape Province (Kenhardt PV 1)
Our Ref:



Enquiries: Ragna Redelstorff
Tel: +27 (0)21 202 8651
Email: rredelstorff@sahra.org.za
CaseID: 8204

Date: Tuesday September 22, 2015

Page No: 1

Letter

In terms of Section of the National Heritage Resources Act (Act 25 of 1999)

Attention: Scatec Solar SA 163 (PTY) Ltd

Scatec Solar SA 163 (PTY) Ltd is proposing to develop three 75 Megawatt (MW) Solar Photovoltaic (PV) power generation facilities and associated electrical infrastructure (132 kV transmission lines for each 75 MW facility) on the remaining extent of Onder Rugzeer Farm 168 and the connection points to the substation on the remaining extent of Portion 3 of Gemsbok Bult Farm 120. A separate full Scoping and EIA Process will be undertaken for each proposed 75 MW Solar PV facility. A separate BA Process will be undertaken for each transmission line. An integrated Public Participation Process will be undertaken for the proposed projects. Separate Applications for Environmental Authorisation will be submitted for each proposed 75 MW Solar PV facility and transmission line. Separate BA, Scoping and EIA Reports will be compiled for each project. This specific application will entail the construction of the proposed 75 MW facility and will be referred to as Kenhardt PV1. The proposed project will take place approximately 80 km south of Upington and 30 km north-east of Kenhardt within the Northern Cape Province.

The proposed project entails the construction of a solar photovoltaic (PV) facility and associated infrastructure on the remaining extent of the Farm Onder Rugzeer No 168 and connection points to the substation on the remaining extent of Portion 3 of the Farm Gemsbok Bull No 120, located approximately 30 km northeast of Kenhardt, Northern Cape Province. This project is part of a larger project comprising a total of three solar facilities (called Kenhardt PV1, 2 and 3).

In terms of the National Heritage Resources Act, no 25 of 1999, heritage resources, including archaeological or palaeontological sites over 100 years old, graves older than 60 years, structures older than 60 years are protected. They may not be disturbed without a permit from the relevant heritage resources authority. This means that prior to development it is incumbent on the developer to ensure that a Heritage Impact Assessment is done. This must include the archaeological component (Phase 1) and any other applicable heritage components. Appropriate (Phase 2) mitigation, which involves recording, sampling and dating sites that are to be destroyed, must be done as required.

The quickest process to follow for the archaeological component is to contract an accredited specialist (see the web site of the Association of Southern African Professional Archaeologists www.asapa.org.za) to provide a Phase 1 Archaeological Impact Assessment Report. This must be done before any large development takes place.

The Phase 1 Impact Assessment Report will identify the archaeological sites and assess their significance. It should also make recommendations (as indicated in section 38) about the process to be followed. For example, there may need to be a mitigation phase (Phase 2) where the specialist will collect or excavate



The South African Heritage Resources Agency

Street Address: 111 Harrington Street, Cape Town 8000 * Postal Address: PO Box 4637, Cape Town 8000
* Tel: +27 21 462 4502 * Fax: +27 21 462 4509 * Web: <http://www.sahra.org.za>

Scoping and EIA for the Proposed Development of a 75 MW Solar Photovoltaic Facility north-east of Kenhardt, Northern Cape Province (Kenhardt PV 1)

Our Ref:

Enquiries: Ragna Redelstorff
Tel: +27 (0)21 202 8651
Email: rredelstorff@sahra.org.za
CaseID: 8204

Date: Tuesday September 22, 2015

Page No: 2



material and date the site. At the end of the process the heritage authority may give permission for destruction of the sites.

The PalaeoSensitivity Map on SAHRIS (<http://www.sahra.org.za/sahris/map/palaeo>) indicates moderate palaeontological sensitivity for the proposed area. Therefore, the SAHRA Archaeology, Palaeontology and Meteorites Unit requires a desktop Palaeontological Impact Assessment to be undertaken to assess whether or not the development will impact upon palaeontological resources - or at least a letter of exemption from a Palaeontologist is needed to indicate that this is unnecessary. If the area is deemed sensitive, a full Phase 1 Palaeontological Impact Assessment will be required and if necessary a Phase 2 rescue operation might be necessary.

Any other heritage resources that may be impacted such as built structures over 60 years old, sites of cultural significance associated with oral histories, burial grounds and graves, graves of victims of conflict, and cultural landscapes or viewsapes must also be assessed.

Should you have any further queries, please contact the designated official using the case number quoted above in the case header.

Yours faithfully



Ragna Redelstorff
Heritage Officer
South African Heritage Resources Agency



Phillip Hine
SAHRA Head Archaeologist (Acting)
South African Heritage Resources Agency

ADMIN:

Direct URL to case: <http://www.sahra.org.za/node/319828>



The South African Heritage Resources Agency
Street Address: 111 Harrington Street, Cape Town 8000 * Postal Address: PO Box 4637, Cape Town 8000
* Tel: +27 21 462 4602 * Fax: +27 21 462 4509 * Web: <http://www.sahra.org.za>

Scoping and EIA for the Proposed Development of a 75 MW Solar Photovoltaic Facility north-east of Kenhardt, Northern Cape Province (Kenhardt PV 1)
Our Ref:



an agency of the
Department of Arts and Culture

Enquiries: Ragna Redelstorff
Tel: +27 (0)21 202 8651
Email: rredelstorff@sahra.org.za
CaseID: 8204

Date: Tuesday September 22, 2015

Page No: 3

(DEA, Ref:)

Terms & Conditions:

1. This approval does not exonerate the applicant from obtaining local authority approval or any other necessary approval for proposed work.
2. If any heritage resources, including graves or human remains, are encountered they must be reported to SAHRA immediately.
3. SAHRA reserves the right to request additional information as required.



The South African Heritage Resources Agency

Street Address: 111 Harrington Street, Cape Town 8000 * Postal Address: PO Box 4637, Cape Town 8000
* Tel: +27 21 462 4602 * Fax: +27 21 462 4509 * Web: <http://www.sahra.org.za>

Rohaida Abed - RE: Release of Scoping Reports - Solar PV Facilities and Associated Electrical Infrastructure, Northern Cape

From: Rohaida Abed
To: SLD, Marina Lourens Transnet Freight Rail
Date: 22/10/2015 17:06
Subject: RE: Release of Scoping Reports - Solar PV Facilities and Associated Electrical Infrastructure, Northern Cape
CC: Gilbert.Nortier@transnet.net
Attachments: Kenhardt PV1.pdf; Kenhardt PV2.pdf; Kenhardt PV3.pdf

Dear Marina

I trust that you are well. As requested, please find attached three separate maps showing the TFR access road and the proposed project area. As noted in the trailing email, the Scoping Reports are available on the project website: <http://www.csir.co.za/eia/ScatecSolarPV/>

Thanks and kind regards,
Rohaida

>>> "Marina Lourens Transnet Freight Rail SLD" <Marina.Lourens@transnet.net> 25/09/2015 07:42
>>>

Please send us three different drawings as this is 3 separate applications

From: Gilbert Nortier Transnet Freight Rail PLZ
Sent: 24 September 2015 06:03 PM
To: Marina Lourens Transnet Freight Rail SLD
Subject: FW: Release of Scoping Reports - Solar PV Facilities and Associated Electrical Infrastructure, Northern Cape

Hi Marina

3 separate applications, please request drawings indicating TFR assets

Thanks

Gilbert



G.G. Nortier DEM (IOL)
 (022) 703 3521 083 407 7924
 (022) 703 3494 Gilbert.Nortier@transnet.net

Rohaida Abed - FW: Hard Copies: Notice of BA and EIA Process - Solar PV Facilities and Associated Electrical Infrastructure, Northern Cape

From: "Mei Melinda (UPN)" <MeiM@dws.gov.za>
To: Rohaida Abed <RAbed@csir.co.za>
Date: 29/09/2015 14:37
Subject: FW: Hard Copies: Notice of BA and EIA Process - Solar PV Facilities and Associated Electrical Infrastructure, Northern Cape
CC: Cloete Sham <CloeteS@dws.gov.za>

Good Day Mr. Abed

Your notice received with regards to Basic Assessment; Scoping and Environmental Impact Assessment for the Proposed Development of the three Solar Photovoltaic Facilities and Associated Electrical Infrastructure; North-East of Kenhardt; Northern Cape is of reference. DWS requires you to forward hard copies of the above mentioned project to either of the following address:

Physical Address:

Department Of Water and Sanitation

Louisvale Road Upington

8801

OR

Postal Address:

Department Of Water and Sanitation

Private Bag X 5912

Upington

8800

Your co-operation and assistance is highly appreciated

With kind regards,

Melinda Mei
Water Quality Management: Orange Proto-CMA
Tel: [054 338 5836](tel:0543385836)
Fax: [054 334 0205](tel:0543340205)



Scoping and Environmental Impact Assessment for the proposed Development of a 75 MW Solar Photovoltaic Facility (KENHARDT PV 1) on the remaining extent of Onder Rugzeer Farm 168, north-east of Kenhardt, Northern Cape Province

From: Mei Melinda (UPN)
Sent: 04 August 2015 01:39 PM
To: 'Rohaida Abed'
Cc: Cloete Shaun
Subject: Hard Copies: Notice of BA and EIA Process - Solar PV Facilities and Associated Electrical Infrastructure, Northern Cape
Importance: High

Good morning Mr. Abed

Your notice received with regards to Basic Assessment: Scoping and Environmental Impact Assessment for the Proposed Development of the three Solar Photovoltaic Facilities and Associated Electrical Infrastructure: North-East of Kenhardt: Northern Cape is of reference.

DWS requires you to forward hard copies of the above mentioned project to either of the following address:

Physical Address:

Department Of Water and Sanitation

Louisvale Road Upington

8801

OR

Postal Address:

Department Of Water and Sanitation

Private Bag X 5912

Upington

8800

Your co-operation and assistance is highly appreciated.

With kind regards,

Melinda Mei
Senior Administration Clerk
Water Quality Management: Lower Orange Water Management Area
Tel: [054 338 5836](tel:0543385836)
Fax: [054 334 0205](tel:0543340205)
Mail: MeiM@dwa.gov.za



Scoping and Environmental Impact Assessment for the proposed Development of a 75 MW Solar Photovoltaic Facility (KENHARDT PV 1) on the remaining extent of Onder Rugzeer Farm 168, north-east of Kenhardt, Northern Cape Province

From: John Geeringh <GeerinJH@eskom.co.za>
To: Rohaida Abed <RAbed@csir.co.za>
Date: 29/09/2015 17:29
Subject: RE: Release of Scoping Reports - Solar PV Facilities and Associated Electrical Infrastructure, Northern Cape
Attachments: Eskom requirements for work in or near Eskom servitudes SOLAR (3).doc; Renewable Energy Generation PlantSetbacks to Eskom Infrastructure - Signed.pdf

Please find attached Eskom requirements for renewable infrastructure development at or near Eskom infrastructure.

Regards

John Geeringh (Pr Sci Nat)
Senior Consultant Environmental Management

Eskom GC: Land Development
Megawatt Park
D1Y39
P O Box 1091
Johannesburg
2000

Tel: 011 516 7233
Fax: 086 661 4064
Cell: 083 632 7663

From: Rohaida Abed [mailto:RAbed@csir.co.za]
Sent: 23 September 2015 03:29 PM
To: Rohaida Abed
Subject: Release of Scoping Reports - Solar PV Facilities and Associated Electrical Infrastructure, Northern Cape

NOTICE OF RELEASE OF SCOPING REPORTS FOR THE PROPOSED DEVELOPMENT OF THREE SOLAR PHOTOVOLTAIC (PV) FACILITIES (REFERRED TO AS KENHARDT PV 1, KENHARDT PV 2, AND KENHARDT PV 3) ON THE REMAINING EXTENT OF ONDER RUGZEER FARM 168, NORTH-EAST OF KENHARDT, NORTHERN CAPE PROVINCE

Competent Authority: National Department of Environmental Affairs

CSIR REFERENCE: EMS0102/Scatec/2015

This e-mail correspondence serves to inform you of the release of Scoping Reports for the development of three 75 Megawatt (MW) Solar Photovoltaic (PV) power generation facilities, located on the remaining extent of Onder Rugzeer Farm 168, approximately 80 km south of Upington and 30 km north-east of Kenhardt within the !Kheis Local Municipality, Northern Cape Province. The proposed 75 MW Solar PV projects are referred to as: Kenhardt PV 1, Kenhardt PV 2 and Kenhardt PV 3 respectively. The Project Applicant is Scatec Solar SA 330 (PTY) Ltd for Kenhardt PV 1, Scatec Solar SA 350 (PTY) Ltd for Kenhardt PV 2 and Scatec Solar SA 370 (PTY) Ltd for Kenhardt PV 3.

In terms of the National Environmental Management Act (Act 107 of 1998, as amended) (NEMA) and the 2014 NEMA Environmental Impact Assessment (EIA) Regulations promulgated in Government Gazette 38282 and Government Notice (GN) R982, R983, R984 and R985 on 8 December 2014, a full Scoping and EIA Process is required for the construction of the three Solar PV facilities. A separate Basic Assessment Process will be undertaken for the development of the proposed transmission lines, associated electrical infrastructure and connection to the Eskom Nieuwehoop Substation (which is currently being constructed) on the remaining extent of Portion 3 of Gembok Bult Farm 120. The CSIR has been appointed by the Project Applicant to undertake the separate requisite Basic Assessment, and Scoping and EIA Processes for the proposed projects.

The proposed 75 MW Solar PV facilities are located within the same geographical area and constitute the same type of activity; hence an integrated Public Participation Process will be undertaken. However, separate Applications for Environmental Authorisation are currently being lodged with the National Department of Environmental Affairs (DEA) for each proposed 75 MW Solar PV facility and will be lodged for each Basic Assessment project. Furthermore, separate Basic Assessment, Scoping and EIA Reports will be compiled for each project.

In line with the above, as a registered Interested and Affected Party (I&AP) on the project database, you are hereby notified of the release of the Scoping Reports for the Kenhardt PV 1, Kenhardt PV 2 and Kenhardt PV 3 projects for a 30-day review period, which will extend from **25 September 2015** to **27 October 2015**.

Please find attached the following:
- Executive Summary of each Scoping Report;
- Letter 2 to I&APs; and
- Comment and Registration Form.

Hard copies of the Scoping Reports are available for public viewing at the Kenhardt Library (in Park Street) and the Groblershoop Library (at 97 Oranje Street).

In addition, the above-mentioned project information can be accessed at the following website: <http://www.csir.co.za/eia/ScatecSolarPV/>

Kindly ensure that all comments are submitted to the CSIR Project Manager (details provided below) by **27 October 2015**.

Thank you and kind regards,

Rohaida Abed

CSIR - Environmental Management Services
P. O. Box 17001, Congella, Durban, 4013
Tel: 031 242 2300
Fax: 031 261 2509
Email: RAbed@csir.co.za

Eskom requirements for work in or near Eskom servitudes.

1. Eskom's rights and services must be acknowledged and respected at all times.
2. Eskom shall at all times retain unobstructed access to and egress from its servitudes.
3. Eskom's consent does not relieve the developer from obtaining the necessary statutory, land owner or municipal approvals.
4. Any cost incurred by Eskom as a result of non-compliance to any relevant environmental legislation will be charged to the developer.
5. If Eskom has to incur any expenditure in order to comply with statutory clearances or other regulations as a result of the developer's activities or because of the presence of his equipment or installation within the servitude restriction area, the developer shall pay such costs to Eskom on demand.
6. The use of explosives of any type within 500 metres of Eskom's services shall only occur with Eskom's previous written permission. If such permission is granted the developer must give at least fourteen working days prior notice of the commencement of blasting. This allows time for arrangements to be made for supervision and/or precautionary instructions to be issued in terms of the blasting process. It is advisable to make application separately in this regard.
7. Changes in ground level may not infringe statutory ground to conductor clearances or statutory visibility clearances. After any changes in ground level, the surface shall be rehabilitated and stabilised so as to prevent erosion. The measures taken shall be to Eskom's satisfaction.
8. Eskom shall not be liable for the death of or injury to any person or for the loss of or damage to any property whether as a result of the encroachment or of the use of the servitude area by the developer, his/her agent, contractors, employees, successors in title, and assignees. The developer indemnifies Eskom against loss, claims or damages including claims pertaining to consequential damages by third parties and whether as a result of damage to or interruption of or interference with Eskom's services or apparatus or otherwise. Eskom will not be held responsible for damage to the developer's equipment.

9. No mechanical equipment, including mechanical excavators or high lifting machinery, shall be used in the vicinity of Eskom's apparatus and/or services, without prior written permission having been granted by Eskom. If such permission is granted the developer must give at least seven working days' notice prior to the commencement of work. This allows time for arrangements to be made for supervision and/or precautionary instructions to be issued by the relevant Eskom Manager
Note: Where and electrical outage is required, at least fourteen work days are required to arrange it.
10. Eskom's rights and duties in the servitude shall be accepted as having prior right at all times and shall not be obstructed or interfered with.
11. Under no circumstances shall rubble, earth or other material be dumped within the servitude restriction area. The developer shall maintain the area concerned to Eskom's satisfaction. The developer shall be liable to Eskom for the cost of any remedial action which has to be carried out by Eskom.
12. The clearances between Eskom's live electrical equipment and the proposed construction work shall be observed as stipulated by *Regulation 15 of the Electrical Machinery Regulations of the Occupational Health and Safety Act, 1993 (Act 85 of 1993)*.
13. Equipment shall be regarded electrically live and therefore dangerous at all times.
14. In spite of the restrictions stipulated by Regulation 15 of the Electrical Machinery Regulations of the Occupational Health and Safety Act, 1993 (Act 85 of 1993), as an additional safety precaution, Eskom will not approve the erection of houses, or structures occupied or frequented by human beings, under the power lines or within the servitude restriction area.
15. Eskom may stipulate any additional requirements to highlight any possible exposure to Customers or Public to coming into contact or be exposed to any dangers of Eskom plant.
16. It is required of the developer to familiarise himself with all safety hazards related to Electrical plant.
17. Any third party servitudes encroaching on Eskom servitudes shall be registered against Eskom's title deed at the developer's own cost. If such a servitude is brought into being, its existence should be endorsed on the Eskom servitude deed concerned, while the third party's servitude deed must also include the rights of the affected Eskom servitude.

John Geeringh (Pr Sci Nat)

Senior Consultant Environmental Management

Eskom GC: Land Development

 Eskom	SCOT	Technology
---	-------------	-------------------

Title: **Renewable Energy Generation Plant Setbacks to Eskom Infrastructure** Unique Identifier: **240-65559775**

Alternative Reference Number: **N/A**

Area of Applicability: **Power Line Engineering**

Documentation Type: **Guideline**

Revision: **0**

Total Pages: **8**

Next Review Date: **N/A**

Disclosure Classification: **CONTROLLED DISCLOSURE**

Compiled by



J W Chetty
Mechanical Engineer

Date: 20/02/2014

Approved by



V Naidoo
Chief Engineer (Lines)

Date: 24/02/2014

Authorised by

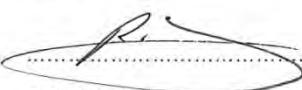

R A Vajeth
Acting Snr Manager (Lines)

Date: 27/2/2014

Supported by SCOT/SC



R Vajeth
SCOT/SC/ Chairperson

Date: 27/2/2014

PCM Reference: 240-65132732 **LINE ENGINEERING SERVICES**

SCOT Study Committee Number/Name : **OVERHEAD LINES**

Wind Turbine Eskom Setbacks

Unique Identifier: 240-65559775

Revision: 0

Page: 2 of 9

CONTENTS

	Page
EXECUTIVE SUMMARY	3
1. INTRODUCTION	4
2. SUPPORTING CLAUSES	4
2.1 SCOPE	4
2.1.1 Purpose.....	4
2.1.2 Applicability	5
2.2 NORMATIVE/INFORMATIVE REFERENCES	5
2.2.1 Normative.....	5
2.2.2 Informative	5
2.3 DEFINITIONS	5
2.3.1 Disclosure Classification.....	6
2.4 ABBREVIATIONS	6
2.5 ROLES AND RESPONSIBILITIES	6
2.6 PROCESS FOR MONITORING	6
2.7 RELATED/SUPPORTING DOCUMENTS	6
3. DOCUMENT CONTENT	6
3.1 INTERNATIONAL SETBACK COMPARISON	6
3.2 ESKOM APPROACH FOR WIND FARMS	7
4. AUTHORISATION	8
5. REVISIONS	8
6. DEVELOPMENT TEAM	9

FIGURES

Figure 1: Horizontal Axis Wind Turbine	8
--	---

CONTROLLED DISCLOSURE

When downloaded from the EDMS, this document is uncontrolled and the responsibility rests with the user to ensure it is in line with the authorised version on the system.

Wind Turbine Eskom Setbacks

Unique Identifier: **240-65559775**

Revision: **0**

Page: **3 of 9**

EXECUTIVE SUMMARY

In recent decades, the use of wind turbines, concentrated solar plants and photovoltaic plants have been on the increase as it serves as an abundant source of energy. This document specifies setbacks for wind turbines and the reasons for these setbacks from infrastructure as well as setbacks for concentrated solar plants and photovoltaic plants. Setbacks for wind turbines employed in other countries were compared and a general setback to be used by Eskom was suggested for use with wind turbines and other renewable energy generation plants.

CONTROLLED DISCLOSURE

When downloaded from the EDMS, this document is uncontrolled and the responsibility rests with the user to ensure it is in line with the authorised version on the system.

Wind Turbine Eskom Setbacks

Unique Identifier: 240-65559775

Revision: 0

Page: 4 of 9

1. INTRODUCTION

During the last few decades, a large amount of wind turbines have been installed in wind farms to accommodate for the large demand of energy and depleting fossil fuels. Wind is one of the most abundant sources of renewable energy. Wind turbines harness the energy of this renewable resource for integration in electricity networks. The extraction of wind energy is its primary function and thus the aerodynamics of the wind turbine is important. There are many different types of wind turbines which will all exhibit different wind flow characteristics. The most common wind turbine used commercially is the Horizontal Axis Wind Turbine. Wind flow characteristics of this turbine are important to analyse as it may have an effect on surrounding infrastructure.

Wind turbines also cause large turbulence downwind that may affect existing infrastructure. Debris or parts of the turbine blade, in the case of a failure, may be tossed behind the turbine and may lead to damage of infrastructure in the wake path.

This document outlines the minimum distances that need to be introduced between a wind turbine and Eskom infrastructure to ensure that debris and / or turbulence would not negatively impact on the infrastructure.

Safety distances of wind turbines from other structures as implemented by other countries were also considered and the reasons for their selection were noted.

Concentrated solar plants and photovoltaic plants setbacks away from substations were also to be considered to prevent restricting possible power line access routes to the substation.

2. SUPPORTING CLAUSES

2.1 SCOPE

This document provides guidance on the safe distance that a wind turbine should be located from any Eskom power line or substation. The document specifies setback distances for transmission lines (220 kV to 765 kV), distribution lines (6.6 kV to 132 kV) and all Eskom substations. Setbacks for concentrated solar plants and photovoltaic plants are also specified away from substations.

2.1.1 Purpose

Setbacks for wind turbines and power lines / substations are required for various reasons. These include possible catastrophic failure of the turbine blade that may release fragments and which may be thrown onto nearby power lines that may result in damage with associated unplanned outages. Turbulence behind the turbine may affect helicopter flight during routine Eskom live line maintenance and

CONTROLLED DISCLOSURE

When downloaded from the EDMS, this document is uncontrolled and the responsibility rests with the user to ensure it is in line with the authorised version on the system.

Wind Turbine Eskom Setbacks

Unique Identifier: **240-65559775**

Revision: **0**

Page: **5 of 9**

inspections that may lead to safety risk of the aircraft / personnel. Concentrated solar plants and photovoltaic plants setback away from substations were required to prevent substations from being boxed in by these renewable generation plants limiting line route access to the substations.

2.1.2 Applicability

This document is applicable to the siting of all new and existing wind turbines, concentrated solar plants and photovoltaic plants near power lines and substations.

2.2 NORMATIVE/INFORMATIVE REFERENCES

2.2.1 Normative

1. <http://www.envir.ee/orb.aw/class=file/action=preview/id=1170403/Hiiumaa+turbulence+impact+EMD.pdf>.
2. <http://www.energy.ca.gov/2005publications/CEC-500-2005-184/CEC-500-2005-184.PDF>
3. <http://www.adamscountywind.com/Revised%20Site/Windmills/Adams%20County%20Ordinance/Adams%20County%20Wind%20Ord.htm>
4. http://www.dsireusa.org/incentives/incentive.cfm?Incentive_Code=PA11R&RE=1&EE=1
5. <http://www.wind-watch.org/documents/european-setbacks-minimum-distance-between-wind-turbines-and-habitations/>
6. <http://www.publications.parliament.uk/pa/ld201011/ldbills/017/11017.1-i.html>
7. http://www.caw.ca/assets/pdf/Turbine_Safety_Report.pdf
8. Rogers J, Slegers N, Costello M. (2011) A method for defining wind turbine setback standards. Wind energy 10.1002/we.468

2.2.2 Informative

None

2.3 DEFINITIONS

Definition	Description
Setback	The minimum distance between a wind turbine and boundary line/dwelling/road/infrastructure/servitude etc.
Flicker	Effect caused when rotating wind turbine blades periodically cast shadows
Tip Height	The total height of the wind turbine ie. Hub height plus half rotor diameter (see Figure 1)

CONTROLLED DISCLOSURE

When downloaded from the EDMS, this document is uncontrolled and the responsibility rests with the user to ensure it is in line with the authorised version on the system.

Wind Turbine Eskom Setbacks

Unique Identifier: 240-65559775

Revision: 0

Page: 6 of 9

2.3.1 Disclosure Classification

Controlled disclosure: controlled disclosure to external parties (either enforced by law, or discretionary).

2.4 ABBREVIATIONS

Abbreviation	Description
None	

2.5 ROLES AND RESPONSIBILITIES

All personnel involved in the positioning wind turbines, concentrated solar plants and photovoltaic plants near power lines/substations must follow the setbacks outlined in this guideline.

2.6 PROCESS FOR MONITORING

Approval by Eskom in writing.

2.7 RELATED/SUPPORTING DOCUMENTS

None

3. DOCUMENT CONTENT

3.1 INTERNATIONAL SETBACK COMPARISON

Wind Turbine setbacks employed by various countries were considered. It was found that setbacks were determined for various reasons that include noise, flicker, turbine blade failure and wind effects. The distances (setbacks) varied based on these factors and were influenced by the type of infrastructure

Wind turbine setbacks varied for roads, power lines, dwellings, buildings and property and it was noted that the largest setbacks were employed for reasons of noise and flicker related issues [1-7]. Very few countries specified setbacks for power lines.

The literature survey [1-7], yielded information about studies and experiments were conducted to determine the distance that a broken fragment from a wind turbine might be thrown. Even though of low probability of hitting a power line [5.0×10^{-5}]^[8], the distances recorded were significant [750m]^[8]

Setbacks were thus introduced to prevent any damage to Eskom infrastructure.

CONTROLLED DISCLOSURE

When downloaded from the EDMS, this document is uncontrolled and the responsibility rests with the user to ensure it is in line with the authorised version on the system

Wind Turbine Eskom Setbacks

Unique Identifier: **240-65559775**

Revision: **0**

Page: **7 of 9**

Wind turbines may also cause changes in wind patterns with turbulent effects behind the hub. These factors dictate the wind turbine setbacks specified in this document.

Concentrated solar plants and photovoltaic plants also can limit access into the substation for power lines of all voltages. A setback distance must therefore be employed to prevent the substation from being boxed in by these generation plants. These setback distances are specified in this document.

3.2 ESKOM REQUIRED SETBACKS

- Eskom requires a setback distance of 3 times the tip height of the wind turbine from the edge of the closest Eskom servitude (including vacant servitudes) for transmission lines.
- Eskom requires a setback distance of 1 times the tip height of the wind turbine from the edge of the closest Eskom servitude (including vacant servitudes) for distribution Lines.
- Eskom must be informed of any proposed wind turbine, concentrated solar plants and photovoltaic activity within a 5 km radius of a substation. No wind turbine structure shall be built within a 2 km radius of the closest point of the substation. Where concentrated solar plants and photovoltaic structures fall within a 2 km radius of the closest point of a substation, Eskom should be informed in writing during the planning phase of the construction of such plant or structure.
- Applicants must show that Eskom radio telecommunication systems (mainly microwave systems) will not be affected in any way by wind turbines.

CONTROLLED DISCLOSURE

When downloaded from the EDMS, this document is uncontrolled and the responsibility rests with the user to ensure it is in line with the authorised version on the system.

Wind Turbine Eskom Setbacks

Unique Identifier: 240-65559775

Revision: 0

Page: 8 of 9

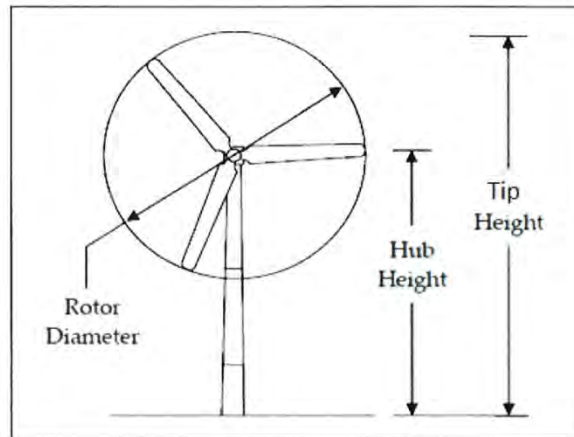

Figure 1: Horizontal Axis Wind Turbine ^[2]

4. AUTHORISATION

This document has been seen and accepted by:

Name & Surname	Designation
V Naidoo	Chief Engineer
Dr P H Pretorius	Electrical Specialist
J Geeringh	Snr Consultant Environ Mngt
B Haridass	Snr Consultant Engineer
R A Vajeth	Acting Snr Manager (Lines)

5. REVISIONS

Date	Rev.	Compiler	Remarks
November 2013	0	J W Chetty	First Publication - No renewable energy generation plant setback specification in existence

CONTROLLED DISCLOSURE

When downloaded from the EDMS, this document is uncontrolled and the responsibility rests with the user to ensure it is in line with the authorised version on the system.

Wind Turbine Eskom Setbacks

Unique Identifier: 240-65559775

Revision: 0

Page: 9 of 9

6. DEVELOPMENT TEAM

The following people were involved in the development of this document:

Jonathan W Chetty (Mechanical Engineer)

Vivendhra Naidoo (Chief Engineer)

Dr Pieter H Pretorius (Electrical Specialist)

John Geeringh (Snr Consultant Environ Mngt)

Bharat Haridass (Snr Consultant Engineer)

Riaz A Vajeth (Acting Snr Manager (Lines))

CONTROLLED DISCLOSURE

When downloaded from the EDMS, this document is uncontrolled and the responsibility rests with the user to ensure it is in line with the authorised version on the system

Rohaida Abed - Agriculture acknowledgement

From: "HettieB" <HettieB@daff.gov.za>
To: <RAbed@csir.co.za>
Date: 06/10/2015 16:43
Subject: Agriculture acknowledgement
Attachments: Agriculture acknowledgement.pdf



agriculture,
forestry & fisheries

Department
Agriculture, forestry & fisheries
REPUBLIC OF SOUTH AFRICA

Directorate Land Use and Soil Management, Private Bag x120, Gezina Pretoria, 0031
Delpen Building, c/o Annie Botha & Union Streets, Riviera

From: Director: Land Use and Soil Management
Tel: (012) 319 7634 , Fax: (012) 329 5938 | e-mail: nhlakad@daff.gov.za

CSIR
PO Box 17001
Congella
Durban 4013

6 October 2015

Dear Sir/Madam

This serves as a notice of receipt and confirms that your application has been captured in our electronic AgriLand tracking and management system. It is strongly recommended that you use the on-line AgriLand application facility in future.

Detail of your application as captured:

Application type: Scoping Reports: Three Solar Photovoltaic Facilities
Your reference number:
Property Description: **Onder Rugzeer 168**
Dated: **25 September 2015**

Please use the following reference number in all enquiries:

AgriLand reference number: 2015_10_0050

Enquiries can be made to the above postal, fax or e-mail address.

Yours sincerely,

HJ Buys
pp DIRECTOR: LAND USE AND SOIL MANAGEMENT

<http://www.agis.agric.za/agriland>

Rohaida Abed - EIA: THREE SOLAR PV FACILITIES AND ASSOCIATED ELECTRICAL INFRASTRUCTURE NORTH EAST OF KENHARDT, NC

From: "Nicole Abrahams (WR)" <AbrahamsN@nra.co.za>
To: "RABed@csir.co.za" <RABed@csir.co.za>
Date: 14/10/2015 09:54
Subject: EIA: THREE SOLAR PV FACILITIES AND ASSOCIATED ELECTRICAL INFRASTRUCTURE NORTH EAST OF KENHARDT, NC
CC: René de Kock (WR) <Dekockr@nra.co.za>

Good day Ms Rohaida Abed

I would herewith like to register as an IAP for the above listed project. May I also request a locality plan please. I would like to know if there is a transport plan available for this project yet.

Regards



Ms Nicole Abrahams
Environmental Coordinator
Tel: +27 21 957 4602
Fax: +27 21 910 1699
Email: Abrahamsn@nra.co.za

Reg.No.
1998/009584/30



Sanral
Western Region
1 Havenga Street, Oakdale, 7530
Private Bag X19, Bellville, 7535
www.sanral.co.za
SANRAL Fraud Hotline: 0800204558

Rohaida Abed - Proposed developments solar project @ Kenhart PV 3

From: Gloria Matlakala <gloria.tlaky@gmail.com>
To: <RABed@csir.co.za>
Date: 26/10/2015 18:43
Subject: Proposed developments solar project @ Kenhart PV 3

Good day Mr Abed

Can you please sent me the registration form to register my company as an I & AP under your database and

I'm asking Mr Abed that in future I want to be informed and attend the meetings for the developments you brings to us

For enquiry please sent me emails, or contacts me: [072 056 2833](tel:0720562833) or [071 984 6106](tel:0719846106)

Hope you will find this in order

Kind regards
Gloria (Khies Municipality)

Scoping and Environmental Impact Assessment for the proposed Development of a 75 MW Solar Photovoltaic Facility (KENHARDT PV 1) on the remaining extent of Onder Rugzeer Farm 168, north-east of Kenhardt, Northern Cape Province

From: Surina Laurie
To: Rohaida Abed
Date: 28/10/2015 10:13
Subject: Fwd: Re: DEA Reference number

FYI

>>> "LToolsBernado" <ltoolsbernado@ncpg.gov.za> 28/10/2015 08:39 >>>

Thank You

Regards
Luzane

>>> "Surina Laurie" <SLaurie@csir.co.za> 10/27/2015 10:16 AM >>>

Dear Luzane

We finally received it, please see attached.

Regards,

Surina

Surina Laurie (Pr. Sci. Nat. Environmental Science)
Senior Environmental Assessment Practitioner
CSIR - Environmental Management Services
11 Jan Celliers Street, Stellenbosch
PO Box 320, Stellenbosch, 7599

Tel: 021 888 2490
Cell: 082 468 0962
Fax: 021 888 2693
Email: slaurie@csir.co.za

>>> Surina Laurie 14/10/2015 08:40 >>>

Dear Luzane

We still have not received it, I will send it to you, once received.

Regards

Surina

Surina Laurie (Pri. Sci. Nat. Environmental Science)
Senior Environmental Assessment Practitioner
CSIR - Environmental Management Services
11 Jan Celliers Street, Stellenbosch
PO Box 320, Stellenbosch, 7599

Tel: 021 888 2490
Cell: 082 468 0962
Fax: 021 888 2693
Email: slaurie@csir.co.za

>>> "LToolsBernado" <ltoolsbernado@ncpg.gov.za> 12/10/2015 08:21 >>>

Dear Ms Laurie

Regarding our telephonic conversation on the 06th October 2015, The Dept of Environment and Nature Conservation is still waiting for the DEA Ref number of the following project Description

Scoping and Environmental Impact Assessment for the proposed Development of a 75MW Solar Photovoltaic Facility (KENHARDT PV 1) on the remaining extent of Onder Rugzeer Farm 168, north-east of Kenhardt, Northern Cape Province.

Please do send the DEA Ref Number as we need to Acknowledge the document.

Kind Regards
Luzane Tools-Bernado
EIA: Administration

Rohaida Abed - Re: Fwd: Release of Scoping Reports - Solar PV Facilities and Associated Electrical Infrastructure, Northern Cape

From: Adrian Tiplady <atiplady@ska.ac.za>
To: Rohaida Abed <RAbed@csir.co.za>
Date: 29/10/2015 07:52
Subject: Re: Fwd: Release of Scoping Reports - Solar PV Facilities and Associated Electrical Infrastructure, Northern Cape
CC: <temonama@ska.ac.za>

Hi Rohaida,

In summary, a detailed EMI and RFI survey would need to be undertaken to characterise the expected radio emissions from the facility. Once this has been conducted, radio frequency propagation modelling would need to be undertaken to determine the quantitative impact the proposed facility would have on the SKA.

The relevant developer would need to contract EMI specialists to undertake these studies. I can suggest a group based in Pretoria, who have undertaken similar studies.

Regards,

Adrian

On 27/10/2015 4:51 PM, Rohaida Abed wrote:

Dear Dr. Tiplady

I refer to the email trail below in relation to the proposed Kenhardt PV projects. We would appreciate if you could provide additional information regarding the scope and Terms of Reference for the required EMI and RFI studies.

Thank you for your assistance with this.

Kind Regards,

Rohaida

>>> Rohaida Abed 23/10/2015 09:23 >>>

Dear Dr. Tiplady

I trust that you are well. I refer to the email sent below on 23 September 2015 regarding the release of the Kenhardt PV 1, Kenhardt PV 2 and Kenhardt PV3 Scoping Reports, as well as the email sent on 6 October 2015 with an addendum to the Scoping Reports.

Thank you for the attached comments sent by the SKA on 2 September 2015 on the Background Information Document for the proposed project. The attached correspondence states that "*as a result of the medium to high risk associated with the PV facilities, the SKA project office recommends that further EMI and RFI detailed studies be conducted as significant mitigation measures would be required to lower the risk of detrimental impact to an acceptable level*".

We would appreciate if you could provide additional information regarding the scope and Terms of Reference for the required EMI and RFI studies.

Thank you for your assistance with this.

Kind Regards,

Rohaida

>>> Rohaida Abed 23/09/2015 15:29 >>>

Dear Stakeholders and Interested and Affected Parties

NOTICE OF RELEASE OF SCOPING REPORTS FOR THE PROPOSED DEVELOPMENT OF THREE SOLAR PHOTOVOLTAIC (PV) FACILITIES (REFERRED TO AS KENHARDT PV 1, KENHARDT PV 2, AND KENHARDT PV 3) ON THE REMAINING EXTENT OF ONDER RUGZEER FARM 168, NORTH-EAST OF KENHARDT, NORTHERN CAPE PROVINCE

Competent Authority: National Department of Environmental Affairs

CSIR REFERENCE: EMS0102/SCATEC/2015

This e-mail correspondence serves to inform you of the release of Scoping Reports for the development of three 75 Megawatt (MW) Solar Photovoltaic (PV) power generation facilities, located on the remaining extent of Onder Rugzeer Farm 168, approximately 80 km south of Upington and 30 km north-east of Kenhardt within the IKheis Local Municipality, Northern Cape Province. The proposed 75 MW Solar PV projects are referred to as: Kenhardt PV 1, Kenhardt PV 2 and Kenhardt PV 3 respectively. The Project Applicant is Scatec Solar SA 330 (PTY) Ltd for Kenhardt PV 1, Scatec Solar SA 350 (PTY) Ltd for Kenhardt PV 2 and Scatec Solar SA 370 (PTY) Ltd for Kenhardt PV 3.

Scoping and Environmental Impact Assessment for the proposed Development of a 75 MW Solar Photovoltaic Facility (KENHARDT PV 1) on the remaining extent of Onder Rugzeer Farm 168, north-east of Kenhardt, Northern Cape Province

In terms of the National Environmental Management Act (Act 107 of 1998, as amended) (NEMA) and the 2014 NEMA Environmental Impact Assessment (EIA) Regulations promulgated in Government Gazette 38282 and Government Notice (GN) R982, R983, R984 and R985 on 8 December 2014, a full Scoping and EIA Process is required for the construction of the three Solar PV facilities. A separate Basic Assessment Process will be undertaken for the development of the proposed transmission lines, associated electrical infrastructure and connection to the Eskom Nieuwehoop Substation (which is currently being constructed) on the remaining extent of Portion 3 of Gembok Bult Farm 120. The CSIR has been appointed by the Project Applicant to undertake the separate requisite Basic Assessment, and Scoping and EIA Processes for the proposed projects.

The proposed 75 MW Solar PV facilities are located within the same geographical area and constitute the same type of activity; hence an integrated Public Participation Process will be undertaken. However, separate Applications for Environmental Authorisation are currently being lodged with the National Department of Environmental Affairs (DEA) for each proposed 75 MW Solar PV facility and will be lodged for each Basic Assessment project. Furthermore, separate Basic Assessment, Scoping and EIA Reports will be compiled for each project.

In line with the above, as a registered Interested and Affected Party (I&AP) on the project database, you are hereby notified of the release of the Scoping Reports for the Kenhardt PV 1, Kenhardt PV 2 and Kenhardt PV 3 projects for a 30-day review period, which will extend from **25 September 2015** to **27 October 2015**.

Please find attached the following:

- Executive Summary of each Scoping Report;
- Letter 2 to I&APs; and
- Comment and Registration Form.

Hard copies of the Scoping Reports are available for public viewing at the Kenhardt Library (in Park Street) and the Groblershoop Library (at 97 Oranje Street).

In addition, the above-mentioned project information can be accessed at the following website:

<http://www.csir.co.za/eia/ScatecSolarPV/>

Kindly ensure that all comments are submitted to the CSIR Project Manager (details provided below) by **27 October 2015**.

Thank you and kind regards,

Rohaida Abed

CSIR - Environmental Management Services

P. O. Box 17001, Congella, Durban, 4013

Tel: [031 242 2300](tel:0312422300)

Fax: [031 261 2509](tel:0312612509)

Email: RAbed@csir.co.za

--

Dr. Adrian Tiplady
SKA South Africa
Johannesburg
[+27 11 442 2434](tel:+27114422434)
[+27 72 372 0134](tel:+27723720134)
www.ska.ac.za

Rohaida Abed - Re: Fwd: Release of Scoping Reports - Solar PV Facilities and Associated Electrical Infrastructure, Northern Cape

From: Adrian Tiplady <atiplady@ska.ac.za>
To: Rohaida Abed <RAbed@csir.co.za>
Date: 29/10/2015 12:11
Subject: Re: Fwd: Release of Scoping Reports - Solar PV Facilities and Associated Electrical Infrastructure, Northern Cape
CC: <temonama@ska.ac.za>

Hi Rohaida,

ITC Services
callie@itc-services.com

Regards,

Adrian

On 29/10/2015 9:23 AM, Rohaida Abed wrote:

Dear Adrian

Thank you very much for your response. We would appreciate if you could kindly send us the contact details for the EMI specialists based in Pretoria that you suggest in the email below.

Kind Regards,
Rohaida

>>> Adrian Tiplady <atiplady@ska.ac.za> 29/10/2015 07:51 >>>
> Hi Rohaida,

In summary, a detailed EMI and RFI survey would need to be undertaken to characterise the expected radio emissions from the facility. Once this has been conducted, radio frequency propagation modelling would need to be undertaken to determine the quantitative impact the proposed facility would have on the SKA.

The relevant developer would need to contract EMI specialists to undertake these studies. I can suggest a group based in Pretoria, who have undertaken similar studies.

Regards,

Adrian

Rohaida Abed - Re: Fwd: Release of Scoping Reports - Solar PV Facilities and Associated Electrical Infrastructure, Northern Cape

From: Adrian Tiplady <atiplady@ska.ac.za>
To: Rohaida Abed <RAbed@csir.co.za>
Date: 29/10/2015 18:51
Subject: Re: Fwd: Release of Scoping Reports - Solar PV Facilities and Associated Electrical Infrastructure, Northern Cape
CC: <temonama@ska.ac.za>

Hi Rohaida,

I will confirm tomorrow - however, I suspect our comments will be no different from what we have already submitted. Should we send no further comments, please treat our previous comments as still valid as we have not received any evidence of studies having been conducted.

Unless I have missed something?

Regards,

Adrian

On 29/10/2015 4:13 PM, Rohaida Abed wrote:

Dear Adrian
Thank you very much for these contact details. I have forwarded them to the Project Applicant.

Please could you also confirm if the SKA has any comments on the Scoping Report and Addendum for the proposed projects.
Thank you and kind regards,
Rohaida

>>> Adrian Tiplady <atiplady@ska.ac.za> 29/10/2015 12:10 >>>
> Hi Rohaida,

ITC Services
callie@itc-services.com

Regards,

Adrian

Rohaida Abed - Re: Fwd: Release of Scoping Reports - Solar PV Facilities and Associated Electrical Infrastructure, Northern Cape

From: Adrian Tiplady <atiplady@ska.ac.za>
To: Rohaida Abed <RAbed@csir.co.za>
Date: 30/10/2015 09:23
Subject: Re: Fwd: Release of Scoping Reports - Solar PV Facilities and Associated Electrical Infrastructure, Northern Cape
CC: <temonama@ska.ac.za>

Hi Rohaida,

I would like to confirm that our letter applies to all potential facilities of the same nature located at this site, and future requests for comments on this and other facilities. Once we have been able to assess and analyse appropriate measurement reports, we will issue a further comment.

Regards,

Adrian

On 29/10/2015 4:13 PM, Rohaida Abed wrote:

Dear Adrian
Thank you very much for these contact details. I have forwarded them to the Project Applicant.

Please could you also confirm if the SKA has any comments on the Scoping Report and Addendum for the proposed projects.
Thank you and kind regards,
Rohaida

>>> Adrian Tiplady <atiplady@ska.ac.za> 29/10/2015 12:10 >>>
> Hi Rohaida,

ITC Services
callie@itc-services.com

Regards,

Adrian

Rohaida Abed - Re: Proposed developments solar project @ Kenhart PV 3

From: Gloria Matlakala <gloria.flaky@gmail.com>
To: Rohaida Abed <RAbed@csir.co.za>
Date: 30/10/2015 14:30
Subject: Re: Proposed developments solar project @ Kenhart PV 3

Good day

Thank you very much to update me on the above mentioned correspondence

Kind regards
Glo

Rohaida Abed - RE: EIA: THREE SOLAR PV FACILITIES AND ASSOCIATED ELECTRICAL INFRASTRUCTURE NORTH EAST OF KENHARDT, NC

From: "Nicole Abrahams (WR)" <AbrahamsN@nra.co.za>
To: "Rohaida Abed" <RAbed@csir.co.za>
Date: 30/10/2015 15:48
Subject: RE: EIA: THREE SOLAR PV FACILITIES AND ASSOCIATED ELECTRICAL INFRASTRUCTURE NORTH EAST OF KENHARDT, NC
CC: René de Kock (WR) <Dekockr@nra.co.za>

Good day Rohaida

Thank you for the locality plans. If any transport plan will be developed then you should forward that to me please.

Regards
Nicole

From: Rohaida Abed [RAbed@csir.co.za]
Sent: 30 October 2015 01:53 PM
To: Nicole Abrahams (WR) <AbrahamsN@nra.co.za>
Cc: René de Kock (WR) <Dekockr@nra.co.za>
Subject: Re: EIA: THREE SOLAR PV FACILITIES AND ASSOCIATED ELECTRICAL INFRASTRUCTURE NORTH EAST OF KENHARDT, NC

Dear Nicole

Thank you for email regarding the proposed Kenhardt PV 1, Kenhardt PV 2 and Kenhardt PV 3 projects. We will add you the project database as requested.

As requested, please find attached locality plans for the Kenhardt PV 1, Kenhardt PV 2 and Kenhardt PV 3 projects.

On 4 September 2015, we also received an email from Ms. Rene de Kock stating the following:

"Please note that this solar development will not impact on a national road, therefore SANRAL has no jurisdiction and have no further comment with regard to the Solar Facility. Should any service, e.g. power line and/or water pipe will be situated within 60m from the national road or will cross the national road application should be made to SANRAL for approval in terms of the National Roads Act."

As noted in Chapter 6 of the Scoping Report, a general Traffic Impact Statement (which will include management measures for road maintenance) will be prepared by the EAP, which will provide recommendations for inclusion in the EMPr (during the EIA Report Phase). The same approach was followed by the CSIR for the proposed Nieuwehoop Solar EIA Project which is currently at the decision-making stage of the EIA.

Please confirm if SANRAL has any further comments on the Scoping Report and Addendum (as sent on 6 October 2015 via email). Please note that all project information is available on the project website (<http://www.csir.co.za/>/eia/ScatecSolarPV>). The comment period closes on 5 November 2015.

Kind Regards,
Rohaida

CSIR - Environmental Management Services
P. O. Box 17001, Congella, Durban, 4013
Tel: [031 242 2300](tel:0312422300)
Fax: [031 261 2509](tel:0312612509)
Email: RAbed@csir.co.za

>>> "Nicole Abrahams (WR)" <AbrahamsN@nra.co.za> 14/10/2015 09:24 >>>
Good day Ms Rohaida Abed

I would herewith like to register as an IAP for the above listed project. May I also request a locality plan please. I would like to know if there is a transport plan available for this project yet.

Regards



Reg. No.
1998/009584/30



Ms Nicole Abrahams
Environmental Coordinator
Tel: +27 21 957 4602
Fax: +27 21 910 1699
Email: Abrahamsn@nra.co.za

Sanral
Western Region
1 Havenga Street, Oakdale, 7530
Private Bag X19, Bellville, 7535
www.sanral.co.za
SANRAL Fraud Hotline: [0800204558](tel:0800204558)

Rohaida Abed - Comments: Kenhard Pv 1,2 &3

From: "Schwartz Chantel (UPN)" <SchwartzC@dws.gov.za>
To: "RAbed@csir.co.za" <RAbed@csir.co.za>
Date: 03/11/2015 09:59
Subject: Comments: Kenhard Pv 1.2 &3
Attachments: Kenhardt PV.pdf

Good Day Sir/Madam

Please find attached a copy of the comments by the Department of Water and Sanitation. The original will be sent to you via registered mail.

Please feel free to contact this department should you have any queries.

Kind regards,
Chantel

Ms Chantel Schwartz
Department of Water and Sanitation
Orange Proto-CMA
Tel: (054) 338- 5836
Fax: (054) 334-0205



From: upnscan@dwa.gov.za [upnscan@dwa.gov.za]
Sent: 03 November 2015 03:50 AM
To: Schwartz Chantel (UPN)
Subject: Message from KM_C454e

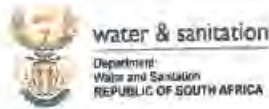

water & sanitation
Department
Water and Sanitation
REPUBLIC OF SOUTH AFRICA

Northern Cape Region
Lower Orange Water Management Area
Private Bag X5912, Upington, 8800
Tel: (054) 338-5800, Fax: (054) 334-0205, www.dwa.gov.za

F ☒ 054 334 0205
E ☒ SchwartzC@dws.gov.za

☒ C.Schwartz
☒ 054 338 5800
☒ By Registered Mail

CSIR
P O Box 17001
Congella, Durban
4013
South Africa

Attention: Claude Bosman

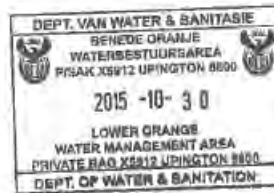

SCOPING AND ENVIRONMENTAL IMPACT ASSESSMENT REPORT FOR THE PROPOSED DEVELOPMENT OF THREE SOLAR PHOTOVOLTAIC FACILITIES (REFERRED TO AS KENHARDT PV 1, KENHARDT PV 2 AND KENHARDT PV 3) ON THE REMAINING EXTENT OF ONDER RUGZEER FARM 168, NORTH-EAST OF KENHARDT, NORTHERN CAPE PROVINCE

The Department of Water & Sanitation (DWS) hereby acknowledges receipt of your scoping and environmental impact assessment for the proposed development of Three Solar Photovoltaic Facilities (Referred to As Kenhardt Pv 1, Kenhardt Pv 2 And Kenhardt Pv 3) on the remaining extent of Onder Rugzeer Farm 168, North-East Of Kenhardt, Northern Cape Province. The department has reviewed the document and the comments are as follows:

- Please note that no development should take place within 100m horizontal distance from a water course or within 1:100 year flood line. Operation and storage of equipment within the riparian zone must be limited as far as possible.
- All sewage, grey and wash water, as well as any waste generated during the construction phase of the facilities will be collected, contained and disposed of at the permitted and / or licensed facilities of the Local Authority. Please note that proof of the agreement between the applicant and the concerned Local Authority must be submitted to this Department.
- Any spillage of any hazardous materials including diesel that may occur during construction and operation must be dealt with and reported immediately to this Department.

- Storm water must be diverted from the construction works and roads and must be managed in such a manner as to disperse runoff and to prevent the concentration of storm water flow. Where necessary, works must be constructed to attenuate the velocity of the storm water discharge and to protect the banks of the watercourse.
- Please note that no taking of water or storing of water from the water resource shall be lawful without a water use authorisation.

Due to the high number of renewable energy projects that are taking part in the Department of Energy [DOE] bidding process, this Department [DWS] will only process applications for water use authorisations received from developers who have attained preferred bidder status.

Developers who wish to submit applications for water use authorisations may however proceed to do so, with the understanding that their applications will be processed as soon as we have confirmation of their status with the DOE.

Attached to this letter is annexure 1 that details information, which must be submitted as part of the application for water use authorisation.

Yours sincerely,

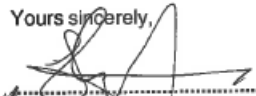
.....
CEO (ACTING): ORANGE PROTO-CMA
DATE: 30/10/2015

Scoping and Environmental Impact Assessment for the proposed Development of a 75 MW Solar Photovoltaic Facility (KENHARDT PV 1) on the remaining extent of Onder Rugzeer Farm 168, north-east of Kenhardt, Northern Cape Province

Annexure 1	
INFORMATION TO BE SUBMITTED AS PART OF WATER USE LICENSE APPLICATIONS	
Application Forms	Part 1 Application Forms Supplementary Forms
Property Details	Title Deed(s) of Property(ies) Letter of Consent of Land Owner Lease Agreement (where applicant is not the registered owner of the property)
Legal Entity	Certified Copy of Identity Document/Company Registration Certificate
BBBEE (Information submitted as part of NERSA/National Treasury bid will suffice)	Social and Labour Plan (Job Creation/Social Investment) Proof of BEE Status <u>Copy of Share Certificates</u> Details of HDI Partners/Beneficiaries
Other Regulatory Requirements	Copy of Environmental Impact Assessment Report Copy of Environmental Authorization (Record of Decision) Copy of NERSA Licence/Proof of Bid Allocated by National Treasury Viability/feasibility reports
Water Resource Technical Report	Water requirements and availability Water balance Design drawings Water use efficiency Integrated water and waste management plan (pollution control; emergency preparedness, etc.) Section 27 NWA Motivation

From: Elsabe Swart <elsabe.dtec@gmail.com>
To: bryan fisher <croninroad@gmail.com>, BFisher <bfisher@ncpg.gov.za>, Nanine van Olmen Phillips <nvanolmen@ncpg.gov.za>, Nanine <naninevanolmen@live.nl>, <RAbed@csir.co.za> <oriba.denc@gmail.com>, Jacoline Mans <JacolineMa@daff.gov.za>
CC:
Date: 05/11/2015 11:26
Subject: Renewable Energy: 3x PV facilities, Kenhardt district
Attachments: Scoping_Three Solar PV Facility near Kenhardt_CSIR_Sdlf.pdf

Dear Abed

The following proposed developments have reference:

Kenhardt PV 1: CSIR/CAS/EMS/ER/2015/0007/B

Kenhardt PV 2: CSIR/CAS/EMS/ER/2015/0008/B

Kenhardt PV 3: CSIR/CAS/EMS/ER/2015/0009/B

Please refer to attached comments.

Regards
 Elsabe
 --
 E SWART
 DEPUTY DIRECTOR: RESEARCH AND DEVELOPMENT SUPPORT
 Pr.Sci.Nat.

Department of Environment and Nature Conservation
 Private Bag X6102
 Kimberley
 8300
 Tel. 053 - 807 7430/48
 Fax 053 - 831 3530
 Mobile 082 4582954
 elsabe.dtec@gmail.com



the denc

Department:
Environment & Nature Conservation
NORTHERN CAPE PROVINCE
REPUBLIC OF SOUTH AFRICA

0

Private Bag X6102, Kimberley, 8300, Meflife Towers, T-Floor, Tel: 053 807 7300, Fax: 053 807 7328

Enquiries :
Dipatisilo :
Navrae :
Imbuzo :
Samantha De la Fontaine

Date :
Letsha :
Datum :
Umhla :
22 October 2015

Reference :
Tshupelo :
Venwysing :
Isalathiso :
Kenhardt PV 1: CSIR/CAS/EMS/ER/2015/0007/B
Kenhardt PV 2: CSIR/CAS/EMS/ER/2015/0008/B
Kenhardt PV 3: CSIR/CAS/EMS/ER/2015/0009/B

ATTENTION:

MS G. BOTHA: HEAD OF DEPARTMENT: DEPARTMENT ENVIRONMENT & NATURE CONSERVATION

MS. N. VAN OLMEN: DIRECTOR: POLICY, PLANNING & COORDINATION

MS E. SWART: DEPUTY DIRECTOR: RESEARCH & DEVELOPMENT SUPPORT

RE: SCOPING REPORT: PROPOSED DEVELOPMENT OF THREE 75MW SOLAR PHOTOVOLTAIC FACILITIES AND ASSOCIATED ELECTRICAL INFRASTRUCTURE (KENHARDT PV 1 – 3) ON THE REMAINING EXTENT OF ONDER RUGZEER FARM 168, NORTH-EAST OF KENHARDT, NORTHERN CAPE PROVINCE

Kindly note: Due date for submission of comments for this phase of the proposed development is **27 October 2015**. A copy of the recommendations to be submitted to Rohaida Abed at RAbed@csir.co.za.

Background:

Scatec Solar SA 163 (PTY) Ltd, which consists of various subsidiary companies, is proposing to construct a renewable energy (RE) project consisting of three (3) photovoltaic (PV) facilities north-east of Kenhardt. The proposed project will have a collective footprint of 750 hectare with a combined power generation capacity of 225 MW (individual capacity of 75 MW each) and will be located on one property. Each of the three RE facilities are said to have a 132 kV transmission line to be connected to the Eskom Nieuwehoop Substation that is currently under construction.

Three separate Scoping / Environmental Impact Assessment (EIA) reports and Basic Assessment studies for the three PV facilities and their respective transmission lines will be submitted to the Department of Environmental Affairs for separate Environmental Authorisation (EA) applications with an integrated Public Participation Process.

Table 1. A summary of the three planned PV facilities. Scatec Solar SA 163 (PTY) Ltd consists of various subsidiary companies of which three of these will serve as the Project Applicant for one of each proposed PV facility near Kenhardt (taken from the CSIR's Information Letter to the respective I&APs).

Project Reference	Project Applicant	Generation Capacity	Project Footprint	Available Development Area
Kenhardt PV 1	Scatec Solar SA 330 (PTY) Ltd	75 MW	250 ha	450 ha
Kenhardt PV 2	Scatec Solar SA 350 (PTY) Ltd	75 MW	250 ha	540 ha
Kenhardt PV 3	Scatec Solar SA 370 (PTY) Ltd	75 MW	250 ha	1000 ha

The farm where these three PV facilities and their respective transmission lines are proposed is the following: the remaining extent of Boven Rugzeer No. 168 (i.e. all three facilities on one property). The Eskom Nieuwehoop substation is currently being constructed on an adjacent farm, i.e. Portion 3 of the Farm Gemsbok Bult No. 120. To note: the projects are proposed on farms currently owned by a third party and the properties will be leased from the land-owner for the entire lifespan of the project

Scoping and Environmental Impact Assessment for the proposed Development of a 75 MW Solar Photovoltaic Facility (KENHARDT PV 1) on the remaining extent of Onder Rugzeer Farm 168, north-east of Kenhardt, Northern Cape Province

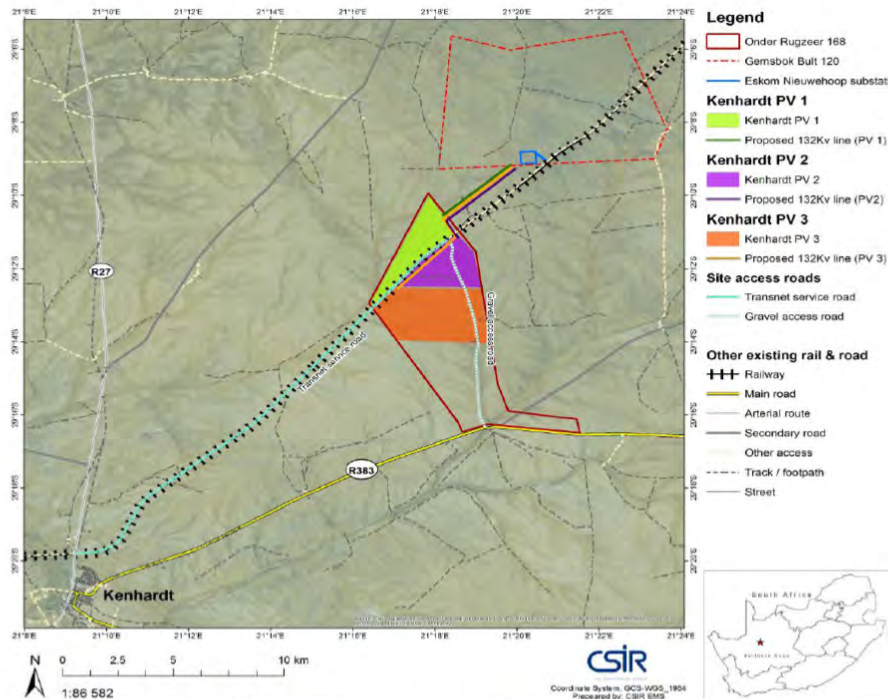

Figure 1. The proposed Three Solar PV developments near Kenhardt. The Eskom Nieuwehoop substation is currently being constructed north-east of the proposed development. The CSIR is also the EAP for a proposed Seven Solar PV Project on the farms just north of the current proposed development. The Seven Solar PV project will cover an area of 1 400 ha.

Herewith comments on the proposed development:

1. It should be noted that the areas where the proposed developments are to be constructed have been historically poorly surveyed, hence extrapolations from desktop studies for specialist's studies will give an incomplete representation of the biodiversity within the area (refer to Figure 2).
2. Large *Aloe dichotoma* populations are known to occur in the region. The species is protected under the Northern Cape Nature Conservation Act (Act 9 of 2009) and at present there is a moratorium in place in the Northern Cape on the removal of *A. dichotoma* from the wild due to historic trade related pressures on populations (Proclamation No 968, 1 April 2005). Hence, trees may not be removed until the moratorium is lifted. All trees within the development or close proximity thereof should be mapped and information provided with the EIA documents.
3. The proposed development do not form part of the Strategic Environmental Assessment (SEA) for Eskom's electricity grid upgrades and roll-outs as it falls outside one of the corridors identified by Eskom (i.e. the Western Corridor; one of the five identified corridors; refer to Figure 3). Comprehensive field surveys (within appropriate seasons) should thus be done for this specific area; it didn't form part of Eskom's assessment and the former project's surveys can thus not be used as baseline studies.
4. The proposed area does not fall within or close to an Important Bird Area (IBA), yet it does resort within a region of grids classified as being sensitive to Wind Farm facilities (refer to Figure 4). The darker the pendent the more sensitive the specific area is to Wind Farm facilities. Closer scrutiny regarding bird studies is thus a prerequisite due to possible impacts of birds on grid infrastructure as by implication local or regional migratory species that move around in response to surface water availability may be at risk from infrastructure collisions. It is also critical to point out that bird data for this area is based on the South African Bird Atlas Project 1 (SABAP1); data published in 1997 and recorded at a much broader scale than the SABAP2 data survey. Evidently, one can conclude that data for this area is outdated. This is specifically highlighted as a point of concern as each of the three PV projects will be separately linked to the Eskom grid through its own set of powerlines.
5. The development is proposed for an area that falls within the Bushmanland Arid Grassland, one of the most extensive vegetation types within the Northern Cape (Mucina and Rutherford, 2006). This

vegetation types is poorly conserved in formal protected areas and extensive areas have been historically overgrazed. As a result, large areas are currently degraded and drainage lines have been modified as a result of anthropogenic impacts. As a result of the extent of the area, impact would most likely be on landscape connectivity as the site is in close proximity of drainage lines and wetlands (refer to Figure 5).

6. It is advisable that RE facilities are not proposed for areas that favour local faunal diversity (e.g. endorheic pans, dry river washes, rocky outcrops, etc.).
- 6.1 The Northern Cape is water scarce province, hence any form of sustained water, has the potential to stimulate vegetative growth and attract faunal species.
- 6.2 Above-mentioned areas should be noted as sensitive areas during the EIA phase.
7. The disturbance of soil and indigenous vegetation can initiate the prolific growth of invasive alien plants (IAPs). The latter should be avoided by all means as it has detrimental impacts on indigenous faunal and floral species, as well as underground water resources. A proper IAP management plan must thus be factored into the EIA phase (as part of the EMP). Please consult the National Environment Management: Biodiversity Act's (Act No. 10 of 2004) Regulations on Alien and Invasive Species as promulgated on 1 August 2014.
8. Once the proponent decides on a project name, the latter should be made explicit. If the project name should change during the EIA phase of the project, this should be thoroughly communicated with all I&APs. It has come to light that RE project names continuously change for various reasons and confusion is then caused by the interchangeable use of the various project names for a single project.
9. It is advised that the consultants for this project liaise with the Forestry branch of the Department of Agriculture, Forestry and Fisheries (DAFF) if trees protected under the National Forest Act (Act No. 84 of 1998) are to be impacted by the proposed development.
10. If the proposed PV developments triggers biodiversity offsets under the DAFF due to the number of protected trees to be removed, this should be communicated with the DENC (contact Ms E. Swart at elsabe.dtec@gmail.com).

11. Information regarding the probability of a site-visit to be conducted by officials from DEA / DAFF should be communicated with the DENC. This is to ensure cooperative governance, liaison and to enable a collaborative site-visit to be conducted.

Conclusion and recommendations:

The proposed development is supported provided that the recommendations in this document are incorporated:

A. Specialist's studies:

- A thorough baseline survey of the grids 2921AB and 2921AD should be conducted during the EIA phase with at least the following biotic specialists: Ornithologist, Mammologist, Herpetologist (including amphibians) and Botanist.
 - Surveys for both the faunal and floral specialist reports should be done during the most optimum period for this area i.e. mid-summer to autumn, after the rains and during the growth season when maximum biota can be expected.
 - This should be done in order to give a good representation of the ecology in the area.
 - Due to the extreme variability in time and space of rainfall events, even a once-off survey within the rainy season will not provide a representative picture of the ecology of the area.
 - The number of plants of conservation concern (e.g. *Aloe dichotoma*, *Aloe spp.*, *Trichocaulon spp.*, *Hoodia spp.*, *Boscia spp.* etc. under the Northern Cape Nature Conservation Act No. 9 of 2009 and National Environmental Management: Biodiversity Act No. 10 of 2004, etc.) that may be directly affected by the development must be estimated during the EIA phase.
 - Large *Aloe dichotoma* [NCNCA protected spp.] populations are known to occur in the region and any populations in close proximity to the planned facilities must be mapped.

B. Bird Monitoring:

- Bird monitoring programmes should form part of the Environmental Management Programme.
 - Monitoring of birds over a full seasonal period (12 months) is supported.

- This will help to support a comparative lack of data on bird species in the study area from the SABAP database.
 - The information will also provide data on bird flight paths, risk of collision in specific areas, habitat niches etc.
 - An extensive monitoring area across the study area (i.e. non-resident species) is advised to comprehensively account for the movement of species.
 - Appropriate bird deterrent devices must be placed around the facility to lessen the impact caused by collision of avifauna with the development infrastructure (Hernandez *et al.*, 2014, Kagan *et al.*, 2014).
 - All Power lines should be clearly marked with bird flappers / markers.
 - Bird marker devices must be put on the earth wires (live wires) of the power line as oppose to the conductors [Bird Flight Divertor (BFD) as oppose to other bird marker devices are suggested (Anderson, 2001)].
 - Relevant Birdlife SA protocols should be consulted to conduct the EIA assessment for birds (Guide to Access Avian Data for Environmental Impact Assessment Reports, Retief *et al.* 2013; BirdLife South Africa / Endangered Wildlife Trust best practice guidelines for avian monitoring and impact mitigation at proposed wind energy development sites in southern Africa, Jenkins *et al.* 2012). Although the Jenkins and others guideline refers specifically to Wind farms, many of the principles apply for a thorough assessment. The electricity grid infrastructure especially remains a significant risk for bird collisions.
 - Potential impacts on water fowl such as flamingos, ducks and geese as well as large Terrestrial Birds such as bustards and korhaan as well as raptors must be investigated. Potential impacts must speak to the Renewable Energy technologies and infrastructure as well electricity grid infrastructure.
 - BirdLifeSA must be informed as I&AP to provide comment on the development.
 - SKA must be consulted as I&AP to provide comment on the development.
 - SAEON Arid Node must be informed as I&AP to provide comment on the development.
- C. Ecology and landscape connectivity:**
- The proponent should include in the EIA an environmental sensitivity map indicating environmental sensitive areas and features identified during the EIA process and map combining the final layout

plan overlain on the environmental sensitivity map. This map should be adequate in size to determine the extent of the development and to identify all aspects adequately as indicated on the maps. No-Go areas should be clearly identified.

- The final layout of the proposed developments (all 3 phases) and its constituents should be designed in such a manner as to enhance ecological value to fauna and flora within the area and to avoid pressures associated with surrounding farmland i.e. natural areas for greening and designing to support ecological corridors and landscape connectivity are strongly encouraged.
- The actual footprint for all activities related to the whole project (all Solar Park facilities) must be calculated to determine the total natural vegetation land cover transformation and loss. The collective and residual impact of all developments will be assessed also during permit applications. If the collective impact is assessed early enough the developer can better manage his risks and costs as he/she would know in advance whether a biodiversity offset is triggered also under DENC.
- If electrification of the property as security measure is considered, possible electrocution damage to small mammals such as pangolin and tortoises should be taken into consideration.
- Existing roads must be used as far as possible.
- The EIA should indicate how the Social-Agricultural-Conservation dynamic will change in terms of land use. Will the properties on which the developments occur still be actively farmed or will they become dormant or effectively be converted into conservation land with minimal land use management. Will problem animal control still occur as in standard practice in small livestock farming? How will fencing infrastructure change around the properties which has a bearing on problem animal control, but also on wildlife movement and landscape connectivity.
- The application must also be reviewed in the context of cumulative impacts of all RE developments in the region.

D. Environmental Management Programme:

- Training and awareness on the illegal poaching and removal of succulents (e.g. *Hoodia gordonii*, *Euphorbia spp.*) and the protected quiver tree, *Aloe dichotoma*.
- The EIA must address how risk of alien plant infestation by predominantly *Prosopis* will be addressed, since the region is known to be under threat from infestation.
- A proper invasive alien management plan should be written into the EMP. The area should be kept clear of invasive alien species; active management is a prerequisite.

- Bird deterrent devices to lessen the impact caused by collision of avifauna with development infrastructure.
- Possible electrocution of small mammals should be taken into account if electric fences are considered as a security measure.
- Free movement of small mammals if the development property is to be fenced.
- Rehabilitation plans must be provided as to how post construction rehabilitation will be approached as well as operational phase control measures for protecting equipment, for example cutting / scraping / herbicide applications underneath solar panels.

We hope you find these recommendations in order and do not hesitate to contact the Research and Development Support Unit of the DENC if there are any uncertainties.

Yours sincerely



SAMANTHA DE LA FONTAINE
District Ecologist (Candidate Scientist)
Date: 22/10/2015

Recommendations supported / ~~Recommendations not supported~~



E. SWART
Deputy Director: Research & Development Support
Date: 5/11/2015

Cc. Bryan Fischer, Ordain Riba (EO: Impact Management, Upington), Jacoline Mans (Chief Forester: DAFF)

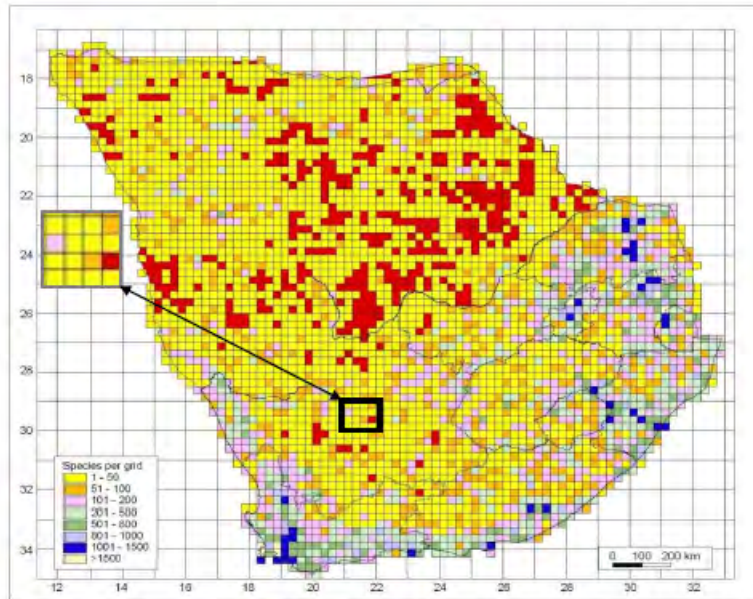

Figure 2. South African National Biodiversity Institute's (SANBI) PRECIS database (2013) indicating the number of plant specimens collected for specific Quarter Degree Grid Squares (QDGS). The proposed development falls within QDGS indicative of a very low species count (i.e. 1 – 50 species sampled per grid). Red squares denote zero specimens.

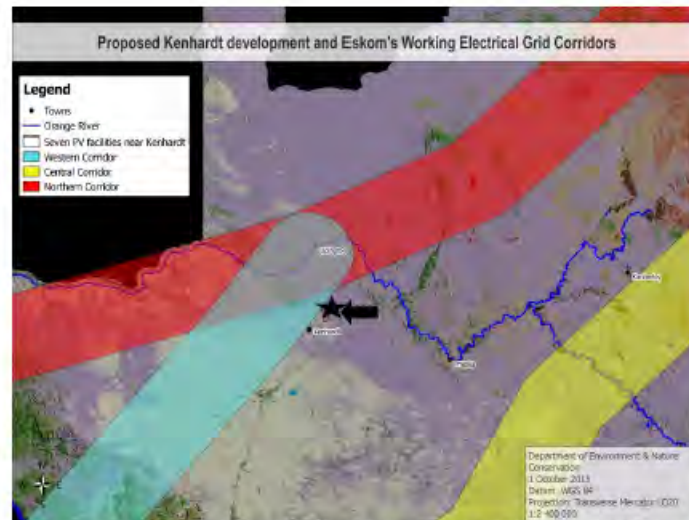

Figure 3. Strategic Environmental Assessment (SEA) for ESKOM's electricity grid upgrades and roll-outs (Feb 2014) in relation to the proposed development (black arrow) near Kenhardt. The proposed development falls outside one of the corridors identified by ESKOM (i.e. the Western Corridor; one of the five identified corridors), hence, it didn't form part of Eskom's assessment.

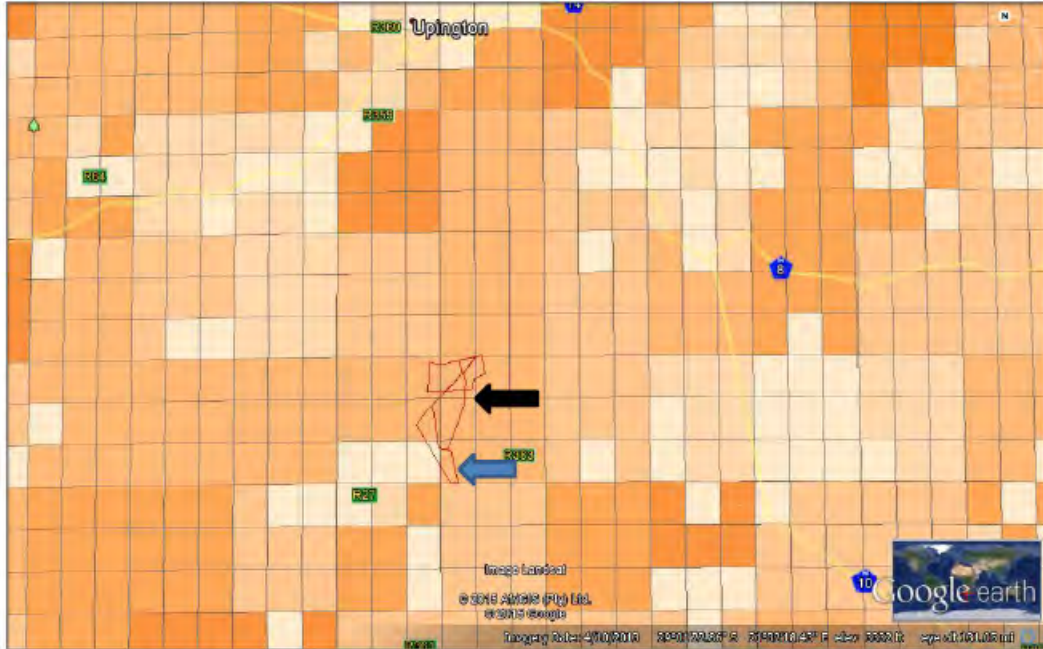

Figure 4. The three Solar PV facility (blue arrow) is proposed for an area classified as being sensitive to Wind Farm facilities. The darker the pentent the more sensitive the specific area is to Wind Farm facilities. Though the proposed development is not a Wind Farm facility it poses significant risks to birds through collision with grid infrastructure as each of the three facilities will have its own transmission lines connecting to the Eskom Nieuwehoop grid station north east of the proposed development. A seven Solar PV facility (black arrow) is proposed north east of the proposed three Solar PV facility, each also having its own transmission line.

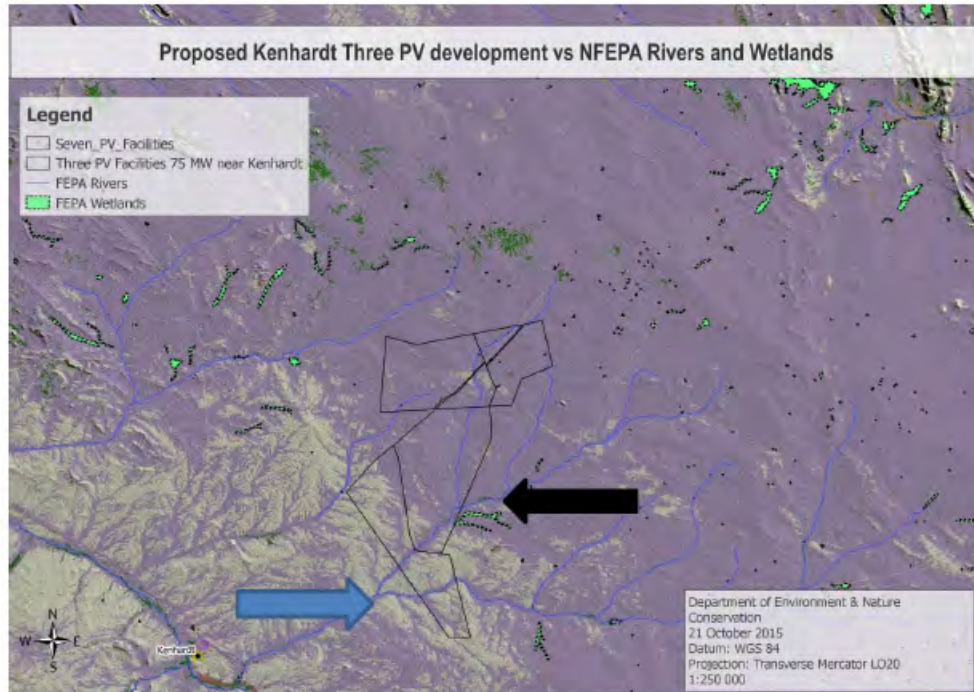

Figure 5. Several landscape scale connections through drainage lines are evident within the area in question. The two proposed facilities i.e. the Three Solar PV (blue arrow) and Seven Solar PV (black arrow) are to be located in close proximity of drainage lines and wetlands.

References

Anderson, M. D. 2001. *The effectiveness of two different marking devices to reduce large terrestrial bird collisions with overhead electricity cables in the eastern Karoo, South Africa*. Draft report to Eskom Resources and Strategy Division. Johannesburg. South Africa.

Hernandez, R. R., Easter, S. B., Murphy-Mariscal, M. L., Maestre, F. T., Tavassoli M., Allen, E. B., Barrows, C.W., Belnap, J., Ochoa-Hueso, R., Ravi S., and M. F. Allen. 2014. Environmental impacts of utility-scale solar energy. *Renewable and Sustainable Energy Reviews* 29:766-779

Jenkins, A.R., van Rooyen, C.S., Smallie, J.J., Harrison, J.A., Diamond M. & Smit, H.A. 2012. BirdLife South Africa / Endangered Wildlife Trust best practice guidelines for avian monitoring and impact mitigation at proposed wind energy development sites in southern Africa.

Kagan, R. A., Viner, T. C., Trail, P. W., and E. O. Espinoza. 2014. *Avian Mortality at Solar Energy Facilities in Southern California: A Preliminary Analysis*. National Fish and Wildlife Forensics Laboratory, USA. Available online at: <http://alternativeenergy.procon.org/sourcefiles/avian-mortality-solar-energy-ivanpah-apr-2014.pdf>.

Mucina, L. & Rutherford, M.C. (eds). 2006. *The vegetation of South Africa, Lesotho and Swaziland*. Strelitzia 19. South African National Biodiversity Institute, Pretoria.

Retief, E.F., Diamond, M., Anderson, M.D., Smit, H.A., Jenkins, A. & Brooks, M. 2012. *Avian Wind Farm Sensitivity Map for South Africa: Criteria and Procedures Used*. Birdlife South Africa & Endangered Wildlife Trust Wildlife and Energy Programme.

Scoping and Environmental Impact Assessment for the proposed Development of a 75 MW Solar Photovoltaic Facility (KENHARDT PV 1) on the remaining extent of Onder Rugzeer Farm 168, north-east of Kenhardt, Northern Cape Province

From: JacolineMa <JacolineMa@daff.gov.za>
To: Elsabe Swart <elsabe.dtec@gmail.com>, bryan fisher <croninroad@gmail.com>, BFisher <bfisher@ncpg.gov.za>, Nanine van Olmen Phillips <nvanolmen@ncpg.gov.za>, Nanine <naninevanolmen@live.nl>, "RAbed@csir.co.za" <RAbed@csir.co.za>
CC: "oriba.denc@gmail.com" <oriba.denc@gmail.com>
Date: 05/11/2015 14:55
Subject: RE: Renewable Energy: 3x PV facilities, Kenhardt district

Noted, thank you.

Jacoline Mans
Designation: Chief Forester (NFARegulation)
Directorate: Forestry Management (Other Regions) Northern Cape
Department of Agriculture, Forestry and Fisheries
Tel: 054 338 5909
Fax: 054 334 0030
Web: www.daff.gov.za<<http://www.daff.gov.za>>
E-mail: JacolineMa@daff.gov.za<<mailto:JacolineMa@daff.gov.za>>

From: Elsabe Swart [<mailto:elsabe.dtec@gmail.com>]
Sent: 05 November 2015 11:25 AM
To: bryan fisher; BFisher; Nanine van Olmen Phillips; Nanine; RAbed@csir.co.za
Cc: oriba.denc@gmail.com; JacolineMa
Subject: Renewable Energy: 3x PV facilities, Kenhardt district

Dear Abed

The following proposed developments have reference:

Kenhardt PV 1: CSIR/CAS/EMS/ER/2015/0007/B

Kenhardt PV 2: CSIR/CAS/EMS/ER/2015/0008/B

Kenhardt PV 3: CSIR/CAS/EMS/ER/2015/0009/B

Please refer to attached comments.

Regards
Elsabe
--
E SWART
DEPUTY DIRECTOR: RESEARCH AND DEVELOPMENT SUPPORT
Pr.Sci.Nat.

Department of Environment and Nature Conservation
Private Bag X6102
Kimberley
8300
Tel. 053 - 807 7430/48
Fax 053 - 831 3530
Mobile 082 4582954
elsabe.dtec@gmail.com<<mailto:elsabe.dtec@gmail.com>>



environmental affairs

Department:
Environmental Affairs
REPUBLIC OF SOUTH AFRICA

Private Bag X 447 - PRETORIA - 0001- Environment House - 473 Steve Biko, Arcadia- PRETORIA
Tel (+ 27 12) 399 9372

DEA Reference: 14/12/16/3/3/2/837

Enquiries: Mr Herman Alberts

Telephone: (012) 399 9371 E-mail: HALberts@henvironment.gov.za

Ms Surina Laurie
CSIR
PO Box 320
STELLENBOSCH
7599

Telephone Number: (021) 888 2490
Email Address: SLaurie@csir.co.za

PER E-MAIL / MAIL

Dear Ms Laurie

COMMENTS ON THE DRAFT SCOPING REPORT FOR THE PROPOSED DEVELOPMENT OF A 75 MW SOLAR PHOTOVOLTAIC FACILITY (KENHARDT PV 1) ON THE REMAINING EXTENT OF ONDER RUGZEER FARM 168, NORTH-EAST OF KENHARDT, NORTHERN CAPE PROVINCE

The draft Scoping Report (SR) dated October 2015 and received by this Department on 02 October 2015, and the acknowledgement letter of the SR issued by this Department on 23 October 2015 refer.

This Department has the following comments on the abovementioned application:

- i. Please ensure that all relevant listed activities are applied for, are specific and that it can be linked to the development activity or infrastructure as described in the project description.
- ii. If the activities applied for in the application form differ from those mentioned in the final SR, an amended application form must be submitted. Please note that the Department's application form template has been amended and can be downloaded from the following link <https://www.environment.gov.za/documents/forms>.
- iii. Please ensure that all issues raised and comments received during the circulation of the SR from registered I&APs and organs of state which have jurisdiction (including this Department's Biodiversity Section) in respect of the proposed activity are adequately addressed in the Final SR.
- iv. Proof of correspondence with the various stakeholders must be included in the Final SR. Should you be unable to obtain comments, proof should be submitted to the Department of the attempts that were made to obtain comments. The Public Participation Process must be conducted in terms of Regulation 39, 40 41, 42, 43 & 44 of the EIA Regulations 2014.
- v. Specialist studies must be submitted to the Department with the Final SR.
- vi. Comments from SKA SA must be included in the Final SR.
- vii. Please provide a description of any identified alternatives for the proposed activity that are feasible and reasonable, including the advantages and disadvantages that the proposed activity or alternatives will have on the environment and on the community that may be affected by the activity as per Appendix 2 of GN R.982 of 2014. Alternatively, you should submit written proof of an investigation and motivation if no reasonable or feasible alternatives exist in terms of Appendix 2.
- viii. In accordance with Appendix 2 of the EIA Regulations 2014, the details of—

- (i) the EAP who prepared the report; and
 - (ii) the expertise of the EAP to carry out Scoping and Environmental Impact assessment procedures; must be submitted.
- ix. You are further reminded that the final SR to be submitted to this Department must comply with all the requirements in terms of the scope of assessment and content of Scoping reports in accordance with Appendix 2 and Regulation 21(1) of the EIA Regulations, 2014.
- x. Further note that in terms of Regulation 45 of the EIA Regulations 2014, this application will lapse if the applicant fails to meet any of the timeframes prescribed in terms of these Regulations, unless an extension has been granted in terms of Regulation 3(7).

You are hereby reminded of Section 24F of the National Environmental Management Act, Act No 107 of 1998, as amended, that no activity may commence prior to an environmental authorisation being granted by the Department.

Yours faithfully



Mr Sabelo Malaza

**Chief Director: Integrated Environmental Authorisations
Department of Environmental Affairs**

Signed by: Mr Coenrad Agenbach

Designation: Deputy Director: Strategic Infrastructure Developments

Date: 29/10/2015

cc:	Mitchell Hodgson	Scatec Solar SA 330 (Pty) Ltd	Email: Mitchell.hodgson@scatecsolar.com
	A Yahphi	NC DENC	Email: nyaphi@ncpg.gov.za