

Disclaimer

The information contained in this communication from the sender is confidential. It is intended solely for use by the recipient and others authorized to receive it. If you are not the recipient, you are hereby notified that any disclosure, copying, distribution or taking action in relation of the contents of this information is strictly prohibited and may be unlawful.

This email has been scanned for viruses and malware, and automatically archived by **Mimecast SA (Pty) Ltd**, an innovator in Software as a Service (SaaS) for business. **Mimecast Unified Email Management ??? (UEM)** offers email continuity, security, archiving and compliance with all current legislation. To find out more, [contact Mimecast](#).

--

Stephan Jacobs

From: Seoka Lekota <SLekota@environment.gov.za>
Sent: Monday, July 10, 2017 3:09 PM
To: sivist_PPP
Cc: Andrea Gibb; 'rebecca.thomas@mainstreamrp.com'; 'Nicolene Venter'; Stephan Jacobs; Stanley Tshitwamulomoni
Subject: RE: Four Proposed Mainstream Wind Farms near Loeriesfontein: DEA Reference Numbers

Good Day

Please note that request for comments should be send to us via registered mail and addressed to Directorate: Biodiversity Conservation and not to me directly since this might cause a delay in responding to your comments. It should be further noted that request for Biodiversity comments send via email would not be considered until an official registered mail with a hard copy or CD is received by the Directorate.

Hope the above is in order.

Regards

*Mr. Seoka Lekota [Pr.Sci.Nat.]
Department of Environmental Affairs
Directorate: Biodiversity Consaervation
Private Bag X447
PRETORIA
0001*

*Tel: +27(0)12 399 9573
E-mail: slekota@environment.gov.za*

From: sivist_PPP [mailto:sivist_ppp@sivist.co.za]
Sent: 23 June 2017 01:21 PM
Cc: Andrea Gibb; 'rebecca.thomas@mainstreamrp.com'; 'Nicolene Venter'; Stephan Jacobs
Subject: Four Proposed Mainstream Wind Farms near Loeriesfontein: DEA Reference Numbers

******* Please note that this email was sent from a NO REPLY email address. Please do not reply to this address as it is an unmonitored email account.*******

Dear Stakeholders

Kindly note that the Department of Environmental Affairs (DEA) have allocated the following reference numbers to the four proposed wind farms near Loeriesfontein:

- Hartebeest Leegte Wind Farm – (DEA Ref No: 14/12/16/3/3/2/1015)
- Ithemba Wind Farm – (DEA Ref No: 14/12/16/3/3/2/1016)
- Graskoppies Wind Farm – (DEA Ref No: 14/12/16/3/3/2/1017)
- Xha! Boom Wind Farm – (DEA Ref No: 14/12/16/3/3/2/1018)

Kind Regards

Geagte Belanghebbendes

Neem asseblief kennis dat die Departement van Omgewingsake (DO) die volgende verwysingsnommers toegewys het aan die vier beoogde windplase naby Loeriesfontein:

- Hartebeest Leegte Windplaas – (DO Verw. No.: 14/12/16/3/3/2/1015)
- Ithemba Windplaas – (DO Verw. No.: 14/12/16/3/3/2/1016)
- Graskoppies Windplaas – (DO Verw. No.: 14/12/16/3/3/2/1017)
- Xha! Boom Windplaas – (DO Verw. No.: 14/12/16/3/3/2/1018)

Vriendelike groete

Andrea Gibb
Senior Manager
SiVEST Environmental Division





SIVEST



SIVEST is a Level 3 BBBEE Contributor

Direct +27 11 798 0638 Tel +27 11 798 0600 fax +27 11 803 7272
email andreag@sivest.co.za website www.sivest.co.za

Consulting Engineers - Project Managers - Environmental Consultants - Town and Regional Planners
Durban - Johannesburg - Pietermaritzburg - Richards Bay - Ladysmith - Cape Town - Harare (Zimbabwe)

From: sivest_PPP

Sent: 19 June 2017 03:54 PM

Cc: Andrea Gibb <AndreaG@sivest.co.za>; Stephan Jacobs <StephanJ@sivest.co.za>;
'rebecca.thomas@mainstreamrp.com' <rebecca.thomas@mainstreamrp.com>

Subject: Four Proposed Wind Farms near Loeriesfontein: Revised BID

******* Please note that this email was sent from a NO REPLY email address. Please do not reply to this address as it is an unmonitored email account.*******

Dear Interested and/or Affected Party

ENVIRONMENTAL IMPACT ASSESSMENTS (EIAs) FOR THE PROPOSED DEVELOPMENT OF FOUR (4) WIND FARMS AND BASIC ASSESSMENTS (BAs) FOR THE ASSOCIATED GRID CONNECTION NEAR LOERIESFONTEIN, NORTHERN CAPE PROVINCE

- **Graskoppies Wind Farm – (DEA Ref No: To be announced)**
- **Xha! Boom Wind Farm – (DEA Ref No: To be announced)**
- **Hartebeest Leegte Wind Farm – (DEA Ref No: To be announced)**
- **Ithemba Wind Farm – (DEA Ref No: To be announced)**
- **Graskoppies Grid Connection – (DEA Ref No: To be announced)**
- **Xha! Boom Grid Connection – (DEA Ref No: To be announced)**
- **Hartebeest Leegte Grid Connection – (DEA Ref No: To be announced)**
- **Ithemba Grid Connection – (DEA Ref No: To be announced)**

Please note that SIVEST SA (Pty) Ltd was appointed by South Africa Mainstream Renewable Power Developments (Pty) Ltd as the Environmental Assessment Practitioner (EAP) for the above mentioned projects. In October 2016, all interested and/or affected parties (I&APs) were invited to participate in the Environmental Impact Assessment (EIA) processes for the wind farm developments and the Basic Assessment (BA) processes for the associated grid connections and were sent a Background Information Document (BID). Since this communication there have been some changes to the proposed developments which include the following;

- The addition of a new power line assessment corridor;
- A change in the generation capacity of the wind farms; and
- A change in the maximum hub height and rotor diameter.

As such, the BID has been updated based on the above changes and is attached for your perusal.

Kindly note that the Draft Scoping Reports (DSRs) will be available for public comment in June 2017 and you will be notified accordingly.

Kind Regards

Geagte Belangstellende en/of Geaffekteerde Party

OMGEWINGSIMPAAKEVALUERINGS (OIE's) VIR DIE BEOOGDE ONTWIKKELING VAN VIER (4) WINDPLASE EN BASIESE EVALUERINGS (BE's) VIR DIE GEPAAARDGAANDE ROOSTERKONNEKSIES NABY LOERIESFONTEIN, NOORD-KAAPPROVINSIE

- **Graskoppies Windplaas – (DO Verw. No.: Moet nog aangekondig word)**
- **Xha! Boom Windplaas – (DO Verw. No.: Moet nog aangekondig word)**
- **Hartebeest Leegte Windplaas – (DO Verw. No.: Moet nog aangekondig word)**
- **Ithemba Windplaas – (DO Verw. No.: Moet nog aangekondig word)**
- **Graskoppies Roosterkonneksie – (DO Verw. No.: Moet nog aangekondig word)**
- **Xha! Boom Roosterkonneksie – (DO Verw. No.: Moet nog aangekondig word)**
- **Hartebeest Leegte Roosterkonneksie – (DO Verw. No.: Moet nog aangekondig word)**
- **Ithemba Roosterkonneksie – (DO Verw. No.: Moet nog aangekondig word)**

Neem asseblief kennis dat South Africa Mainstream Renewable Power Developments (Edms.) Bpk. vir SiVEST SA (Edms.) Bpk. aangestel het as die Omgewingsevalueringpraktisyn (OEP) vir die bogenoemde projekte. In Oktober 2016 is alle belangstellende en/of geaffekteerde partye (B&GP's) genooi om deel te neem aan die Omgewingsimpakevalueringprosesse (OIE-prosesse) vir die windplaasontwikkelings en die Basiese Evalueringprosesse (BE-prosesse) vir die gepaardgaande roosterkonneksies en 'n Agtergrondinligtingsdokument (AID) is aan hulle gestuur. Sedert hierdie skrywe was daar sekere veranderinge aan die beoogde ontwikkelings wat die volgende insluit:

- Die byvoeging van 'n nuwe kraglynkorridor vir evaluering;
- 'n verandering aan die opwekkingsvermoë van die windplase; en
- 'n verandering aan die maksimum naafhoogte en rotordeursnee.

Die AID is dienooreenkomstig bygewerk op grond van die bogenoemde veranderinge en aangeheg vir u insae.

Let asseblief daarop dat die Konsep Bestekopnameverslae (KBV's) in Junie 2017 beskikbaar sal wees vir openbare kommentaar en u sal dienooreenkomstig verwittig word.

Vriendelike groete

Kind Regards,

Andrea Gibb (*B.Sc. Landscape Architecture; B.Sc.(Hons) Environmental Management*)
Environmental Practitioner and Visual Specialist
SiVEST Environmental Division

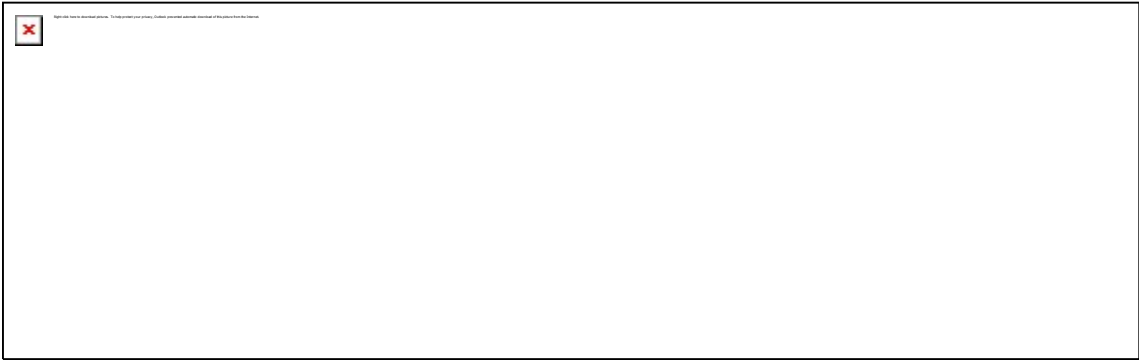



SIVEST



SIVEST is a Level 3 BBBEE Contributor

Direct +27 11 798 0638 **Tel** +27 11 798 0600 **fax** +27 11 803 7272
email andreag@sivest.co.za **website** www.sivest.co.za

Consulting Engineers - Project Managers - Environmental Consultants - Town and Regional Planners
Durban - Johannesburg - Pietermaritzburg - Richards Bay - Ladysmith - Cape Town - Harare (Zimbabwe)

Disclaimer

The information contained in this communication from the sender is confidential. It is intended solely for use by the recipient and others authorized to receive it. If you are not the recipient, you are hereby notified that any disclosure, copying, distribution or taking action in relation of the contents of this information is strictly prohibited and may be unlawful.

This email has been scanned for viruses and malware, and automatically archived by **Mimecast SA (Pty) Ltd**, an innovator in Software as a Service (SaaS) for business. **Mimecast Unified Email Management ??? (UEM)** offers email continuity, security, archiving and compliance with all current legislation. To find out more, [contact Mimecast](#).

Please consider the environment before you print this email. Only print if it is essential. A message from the Department of Environmental Affairs.

Please consider the environment before you print this email. Only print if it is essential. A message from the Department of Environmental Affairs.

This message and any attachments transmitted with it are intended solely for the addressee(s) and may be legally privileged and/or confidential. If you have received this message in error please destroy it and notify the sender. Any unauthorized usage, disclosure, alteration or dissemination is prohibited. The Department of Environmental Affairs accepts no responsibility for any loss whether it be direct, indirect or consequential, arising from information made available and actions resulting there from. The views and opinions expressed in this e-mail message may not necessarily be those of Management.

Shaun Taylor

From: sivest_PPP
Sent: Thursday, 12 October 2017 4:26 PM
Cc: Shaun Taylor; Andrea Gibb; 'Nicolene Venter'
Subject: LEEUWBURG WIND FARMS, NORTHERN CAPE PROVINCE

******* Please note that this email was sent from a NO REPLY email address. Please do not reply to this address as it is an unmonitored email account.*******

Dear Interest and Affected Party

We would like to take this opportunity to inform you that the Department of Environmental Affairs has accepted the Final Scoping Report and approved the Plan of Study for the Environmental Impact Phase of the above mentioned project.

Attached is the English and Afrikaans EIA Newsletter and Site Layout Map for your information.

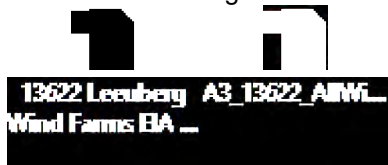

Best Regards
Shaun Taylor

.....

Geagte Belanghebbendes

Ons wil graag hierdie geleentheid gebruik om u in kennis te stel dat die Departement van Omgewingsake die Finale Omvangsbepalingsverslag aanvaar het en die Studieplan vir die Omgewingsimpakfase van die bogenoemde projek goedgekeur het.

Vind asseblief aangeheg die Engelse en Afrikaanse OIE-nuusbrief en 'n webwerf uitlegkaart vir u inligting.



Die uwe
Shaun Taylor
MSc (Aquatic Health)
Environmental Scientist
SiVEST Environmental Division



SiVEST is a Level 3 BBBEE Contributor

Direct +27 11 798 0691 Tel +27 11 798 0600 fax +27 11 803 7272
email shaunt@sivest.co.za website www.sivest.co.za



Consulting Engineers - Project Managers - Environmental Consultants - Town and Regional Planners
Durban - Johannesburg - Pietermaritzburg - Richards Bay - Ladysmith - Port Louis (Mauritius)

Andrea Gibb

From: Andrea Gibb
Sent: Thursday, 22 June 2017 9:41 AM
To: 'Natasha Higgitt'
Cc: Stephan Jacobs; rebecca.thomas@mainstreamrp.com
Subject: RE: Four Proposed Mainstream Wind Farms near Loeriesfontein: DSR Comment Period Starting

Hi Natasha

Thank you for your email. We will create four separate cases on SAHRIS and upload the DSRs and Heritage Assessments accordingly.

Kind Regards
Andrea Gibb
Senior Manager
SiVEST Environmental Division



SiVEST is a Level 3 BBBEE Contributor

Direct +27 11 798 0638 Tel +27 11 798 0600 fax +27 11 803 7272 cell +27 72 587 6525
email andrea@sivest.co.za website www.sivest.co.za



Consulting Engineers - Project Managers - Environmental Consultants - Town and Regional Planners
Durban - Johannesburg - Pietermaritzburg - Richards Bay - Ladysmith - Cape Town - Harare (Zimbabwe)

From: Natasha Higgitt [mailto:nhiggitt@sahra.org.za]
Sent: Thursday, 22 June 2017 8:55 AM
To: Andrea Gibb
Cc: Stephan Jacobs; rebecca.thomas@mainstreamrp.com
Subject: Re: Four Proposed Mainstream Wind Farms near Loeriesfontein: DSR Comment Period Starting

Good morning,

Thank you for notifying SAHRA of the proposed developments. Please note that SAHRA does not accept hardcopy, emailed, posted or website links as official submissions. Please create an application on the South African Heritage Resources Information System (SAHRIS) and upload all documents to the application. Once all documents have been uploaded, please change the status of the case from DRAFT to SUBMITTED and inform me, referencing the Case ID number.

Kind Regards,

Natasha Higgitt
Heritage Officer: Archaeology, Palaeontology and Meteorites Unit

South African Heritage Resources Agency
- A nation united through heritage -

T: +27 21 462 4502 | F: +27 21 462 4509 | C: +27 82 507 0378
E: nhiggitt@sahra.org.za | 111 Harrington Street | Cape Town

www.sahra.org.za

Natasha Higgitt

Heritage Officer: Archaeology, Palaeontology and Meteorites Unit

South African Heritage Resources Agency

- A nation united through heritage -

T: +27 21 462 4502 | C: +27 82 507 0378 | F: +27 21 462 4509

E: nhiggitt@sahra.org.za | 111 Harrington Street | Cape Town | 8001

www.sahra.org.za



an agency of the
Department of Arts and Culture

*OUR VALUES: Accountability, Teamwork & co-operation, Respect, Transparency,
Service Excellency, Integrity & Ethics, Professionalism, Accessibility, Communication & Trust.*

From: "sivest_PPP" <sivest_ppp@sivest.co.za>

Cc: "Andrea Gibb" <AndreaG@sivest.co.za>, "Stephan Jacobs" <StephanJ@sivest.co.za>, "rebecca.thomas@mainstreamrp.com" <rebecca.thomas@mainstreamrp.com>

Sent: Wednesday, 21 June, 2017 4:27:39 PM

Subject: Four Proposed Mainstream Wind Farms near Loeriesfontein: DSR Comment Period Starting

******* Please note that this email was sent from a NO REPLY email address. Please do not reply to this address as it is an unmonitored email account.*******

Dear Interested and/or Affected Party

ENVIRONMENTAL IMPACT ASSESSMENTS (EIAs) FOR THE PROPOSED DEVELOPMENT OF FOUR (4) WIND FARMS NEAR LOERIESFONTEIN, NORTHERN CAPE PROVINCE

- **Graskoppies Wind Farm – (DEA Ref No: To be announced)**
- **Xha! Boom Wind Farm – (DEA Ref No: To be announced)**
- **Hartebeest Leegte Wind Farm – (DEA Ref No: To be announced)**
- **Ithemba Wind Farm – (DEA Ref No: To be announced)**

SiVEST SA (Pty) Ltd was previously appointed by South Africa Mainstream Renewable Power Developments (Pty) Ltd as the Environmental Assessment Practitioner (EAP) for the above mentioned projects.

We would like to take this opportunity to inform you that, in accordance with the National Environmental Management Act (NEMA) (as amended), the Draft Scoping Reports (DSRs) for the above mentioned wind farm projects will be available for public comment and review as from **Wednesday 21 June 2017 to Friday 21 July 2017** (end of business day. Should you wish to receive an electronic copy of the DSRs (on CD) please forward your request in writing to us. Hard copies of the DSRs can be reviewed at the following public place:

VENUE

STREET ADDRESS

HOURS

CONTACT NO

The report is also available on SiVEST's website: <http://www.sivest.co.za/>, click on 'Downloads' then browse to the folder '13622 Mainstream Wind Farms'.

Attached is an English and Afrikaans letter notifying of the review period.

Kind Regards,

Andrea Gibb (B.Sc. Landscape Architecture; B.Sc.(Hons) Environmental Management)
Environmental Practitioner and Visual Specialist
SiVEST Environmental Division



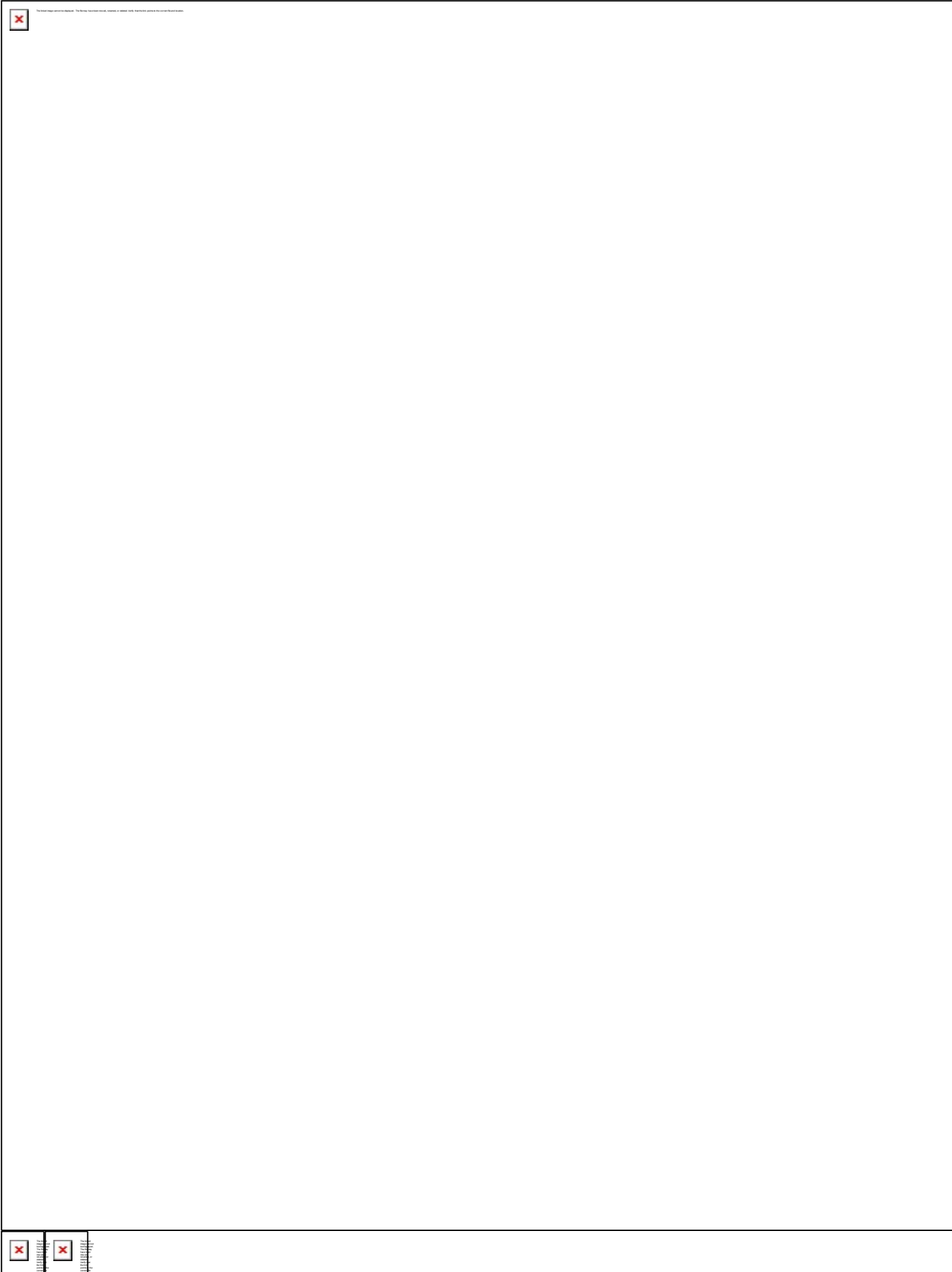

SIVEST is a Level 3 BBBEE Contributor

Direct +27 11 798 0638 **Tel** +27 11 798 0600 **fax** +27 11 803 7272
email andreaq@sivest.co.za **website** www.sivest.co.za

Consulting Engineers - Project Managers - Environmental Consultants - Town and Regional Planners
Durban - Johannesburg - Pietermaritzburg - Richards Bay - Ladysmith - Cape Town - Harare (Zimbabwe)

Disclaimer

The information contained in this communication from the sender is confidential. It is intended solely for use by the recipient and others authorized to receive it. If you are not the recipient, you are hereby notified that any disclosure, copying, distribution or taking action in relation of the contents of this information is strictly prohibited and may be unlawful.

This email has been scanned for viruses and malware, and automatically archived by **Mimecast SA (Pty) Ltd**, an innovator in Software as a Service (SaaS) for business. **Mimecast Unified Email Management ??? (UEM)** offers email continuity, security, archiving and compliance with all current legislation. To find out more, [contact Mimecast](#).

This electronic communication and its content(s) are subject to a disclaimer which can be accessed here: <http://mail.sahra.org.za/disclaimer.html>

BREAK THE CORRUPTION CHAIN
REPORT FRAUD & CORRUPTION: 0800 701 701



an agency of the
Department of Arts and Culture



Stephan Jacobs

From: Seoka Lekota <SLekota@environment.gov.za>
Sent: Monday, July 10, 2017 3:14 PM
To: sivist_PPP
Cc: Andrea Gibb; Stephan Jacobs; 'rebecca.thomas@mainstreamrp.com'; Stanley Tshitwamulomoni
Subject: RE: Four Proposed Mainstream Wind Farms near Loeriesfontein: DSR Comment Period Starting

Good Day

Please note that request for comments should be send to us via registered mail and addressed to Directorate: Biodiversity Conservation and not to me directly since this might cause a delay in responding to your comments. It should be further noted that request for Biodiversity comments send via email would not be considered until an official registered mail with a hard copy or CD is received by the Directorate.

Hope the above is in order.

Regards

*Mr. Seoka Lekota [Pr.Sci.Nat.]
Department of Environmental Affairs
Directorate: Biodiversity Consaervation
Private Bag X447
PRETORIA
0001*

*Tel: +27(0)12 399 9573
E-mail: slekota@environment.gov.za*

From: sivist_PPP [mailto:sivist_ppp@sivist.co.za]
Sent: 21 June 2017 04:28 PM
Cc: Andrea Gibb; Stephan Jacobs; 'rebecca.thomas@mainstreamrp.com'
Subject: Four Proposed Mainstream Wind Farms near Loeriesfontein: DSR Comment Period Starting

******* Please note that this email was sent from a NO REPLY email address. Please do not reply to this address as it is an unmonitored email account.*******

Dear Interested and/or Affected Party

ENVIRONMENTAL IMPACT ASSESSMENTS (EIAs) FOR THE PROPOSED DEVELOPMENT OF FOUR (4) WIND FARMS NEAR LOERIESFONTEIN, NORTHERN CAPE PROVINCE

- Graskoppies Wind Farm – (DEA Ref No: To be announced)
- Xha! Boom Wind Farm – (DEA Ref No: To be announced)
- Hartebeest Leegte Wind Farm – (DEA Ref No: To be announced)
- Ithemba Wind Farm – (DEA Ref No: To be announced)

SiVEST SA (Pty) Ltd was previously appointed by South Africa Mainstream Renewable Power Developments (Pty) Ltd as the Environmental Assessment Practitioner (EAP) for the above mentioned projects.

We would like to take this opportunity to inform you that, in accordance with the National Environmental Management Act (NEMA) (as amended), the Draft Scoping Reports (DSRs) for the above mentioned wind farm projects will be available for public comment and review as from **Wednesday 21 June 2017 to Friday 21 July 2017** (end of business day. Should you wish to receive an electronic copy of the DSRs (on CD) please forward your request in writing to us. Hard copies of the DSRs can be reviewed at the following public place:

VENUE	STREET ADDRESS	HOURS	CONTACT NO
Loeriesfontein Library	Main Street, Loeriesfontein	Mondays- Fridays 14h00 – 17h00	027 662 8607

The report is also available on SiVEST's website: <http://www.sivest.co.za/>, click on 'Downloads' then browse to the folder '13622 Mainstream Wind Farms.

Attached is an English and Afrikaans letter notifying of the review period.

Kind Regards,

Andrea Gibb (B.Sc. Landscape Architecture; B.Sc.(Hons) Environmental Management)
Environmental Practitioner and Visual Specialist
SiVEST Environmental Division





SIVEST



SIVEST is a Level 3 BBBEE Contributor

Direct +27 11 798 0638 **Tel** +27 11 798 0600 **fax** +27 11 803 7272
email andreag@sivest.co.za **website** www.sivest.co.za

Consulting Engineers - Project Managers - Environmental Consultants - Town and Regional Planners
Durban - Johannesburg - Pietermaritzburg - Richards Bay - Ladysmith - Cape Town - Harare (Zimbabwe)

Disclaimer

The information contained in this communication from the sender is confidential. It is intended solely for use by the recipient and others authorized to receive it. If you are not the recipient, you are hereby notified that any disclosure, copying, distribution or taking action in relation of the contents of this information is strictly prohibited and may be unlawful.

This email has been scanned for viruses and malware, and automatically archived by **Mimecast SA (Pty) Ltd**, an innovator in Software as a Service (SaaS) for business. **Mimecast Unified Email Management ??? (UEM)** offers email continuity, security, archiving and compliance with all current legislation. To find out more, [contact Mimecast](#).

Please consider the environment before you print this email. Only print if it is essential. A message from the Department of Environmental Affairs.

Please consider the environment before you print this email. Only print if it is essential. A message from the Department of Environmental Affairs.

This message and any attachments transmitted with it are intended solely for the addressee(s) and may be legally privileged and/or confidential. If you have received this message in error please destroy it and notify the sender. Any unauthorized usage, disclosure, alteration or dissemination is prohibited. The Department of Environmental Affairs accepts no responsibility for any loss whether it be direct, indirect or consequential, arising from information made available and actions resulting there from. The views and opinions expressed in this e-mail message may not necessarily be those of Management.

Stephan Jacobs

From: Andrea Gibb
Sent: Friday, September 22, 2017 10:54 PM
To: Lucia Rodrigues
Cc: Stephan Jacobs; Shaun Taylor
Subject: RE: Four Proposed Mainstream Wind Farms near Loeriesfontein: DSR Comment Period Starting

Good day Lucia

You will certainly be notified once the Draft Environmental Impact Assessment Reports (DEIARs) are available for review and comment.

Kindly note that any comments received before such time will still be taken into account and included in the issues trail.

Kind Regards
Andrea Gibb
Senior Manager
SiVEST Environmental Division



SiVEST is a Level 3 BBBEE Contributor

Direct +27 11 798 0638 **Tel** +27 11 798 0600 **fax** +27 11 803 7272 **cell** +27 72 587 6525
email andrea@sivest.co.za **website** www.sivest.co.za



Consulting Engineers - Project Managers - Environmental Consultants - Town and Regional Planners
Durban - Johannesburg - Pietermaritzburg - Richards Bay - Port Louis (Mauritius)

From: Lucia Rodrigues [<mailto:signet@webafrica.org.za>]
Sent: Thursday, 21 September 2017 9:34 AM
To: Andrea Gibb
Subject: RE: Four Proposed Mainstream Wind Farms near Loeriesfontein: DSR Comment Period Starting

Thanks Andrea.

So I assume I just need to wait until the next report is available for public comment for which I will receive a notification?

From: Andrea Gibb [<mailto:AndreaG@sivest.co.za>]
Sent: 17 September 2017 10:18 PM
To: Lucia Rodrigues
Cc: Stephan Jacobs; Hlengiwe Ntuli
Subject: RE: Four Proposed Mainstream Wind Farms near Loeriesfontein: DSR Comment Period Starting

Good day Lucia

Thank you for contacting us.

We will ensure that you are registered as an Interested and Affected Party for the proposed wind farm projects near Loeriesfontein.

Kind Regards
Andrea Gibb
Senior Manager
SiVEST Environmental Division



SiVEST is a Level 3 BBBEE Contributor

Direct +27 11 798 0638 **Tel** +27 11 798 0600 **fax** +27 11 803 7272 **cell** +27 72 587 6525
email andrea@sivest.co.za **website** www.sivest.co.za

Consulting Engineers - Project Managers - Environmental Consultants - Town and Regional Planners
Durban - Johannesburg - Pietermaritzburg - Richards Bay - Port Louis (Mauritius)

From: Lucia Rodrigues [<mailto:signet@webafrica.org.za>]
Sent: Sunday, 17 September 2017 4:59 PM
To: Andrea Gibb
Subject: Four Proposed Mainstream Wind Farms near Loeriesfontein: DSR Comment Period Starting

Hello Andrea,
Is it possible for me to register as an interested and affected party for these proposed developments please?
Regards,
Lucia Rodrigues
Western Cape Black Eagle Project

From: sivest_PPP [mailto:sivest_ppp@sivest.co.za]
Sent: 21 June 2017 04:28 PM
Cc: Andrea Gibb <AndreaG@sivest.co.za>; Stephan Jacobs <StephanJ@sivest.co.za>;
'rebecca.thomas@mainstreamrp.com' <rebecca.thomas@mainstreamrp.com>
Subject: Four Proposed Mainstream Wind Farms near Loeriesfontein: DSR Comment Period Starting

***** Please note that this email was sent from a NO REPLY email address. Please do not reply to this address as it is an unmonitored email account.*****

Dear Interested and/or Affected Party

ENVIRONMENTAL IMPACT ASSESSMENTS (EIAs) FOR THE PROPOSED DEVELOPMENT OF FOUR (4) WIND FARMS NEAR LOERIESFONTEIN, NORTHERN CAPE PROVINCE

- Graskoppies Wind Farm – (DEA Ref No: To be announced)
- Xha! Boom Wind Farm – (DEA Ref No: To be announced)
- Hartebeest Leegte Wind Farm – (DEA Ref No: To be announced)

· Ithemba Wind Farm – (DEA Ref No: To be announced)

SiVEST SA (Pty) Ltd was previously appointed by South Africa Mainstream Renewable Power Developments (Pty) Ltd as the Environmental Assessment Practitioner (EAP) for the above mentioned projects.

We would like to take this opportunity to inform you that, in accordance with the National Environmental Management Act (NEMA) (as amended), the Draft Scoping Reports (DSRs) for the above mentioned wind farm projects will be available for public comment and review as from Wednesday 21 June 2017 to Friday 21 July 2017 (end of business day). Should you wish to receive an electronic copy of the DSRs (on CD) please forward your request in writing to us. Hard copies of the DSRs can be reviewed at the following public place:

VENUE

STREET ADDRESS

HOURS

CONTACT NO

Loeriesfontein Library

Main Street, Loeriesfontein

Mondays- Fridays

14h00 – 17h00

027 662 8607

The report is also available on SiVEST's website: <http://www.sivest.co.za/>, click on 'Downloads' then browse to the folder '13622 Mainstream Wind Farms'.

Attached is an English and Afrikaans letter notifying of the review period.

Kind Regards,

Andrea Gibb (B.Sc. Landscape Architecture; B.Sc.(Hons) Environmental Management) Environmental Practitioner and Visual Specialist SiVEST Environmental Division

[Image removed by sender.]

[Image removed by sender.]

[\[cid:image005.png@01D0A392.3DF01000\]](#)[\[cid:92A20490812C8847805843F00BF7DB58@sivest.co.za\]](#)

SiVEST is a Level 3 BBBEE Contributor

Direct +27 11 798 0638 Tel +27 11 798 0600 fax +27 11 803 7272
email andreas@sivest.co.za<<mailto:andreas@sivest.co.za>> website
www.sivest.co.za<<http://www.sivest.co.za/>>

Consulting Engineers - Project Managers - Environmental Consultants - Town and Regional Planners Durban - Johannesburg - Pietermaritzburg - Richards Bay - Ladysmith - Cape Town - Harare (Zimbabwe)

Disclaimer

The information contained in this communication from the sender is confidential. It is intended solely for use by the recipient and others authorized to receive it. If you are not the recipient, you are hereby notified that any disclosure, copying, distribution or taking action in relation of the contents of this information is strictly prohibited and may be unlawful.

This email has been scanned for viruses and malware, and automatically archived by Mimecast SA (Pty) Ltd, an innovator in Software as a Service (SaaS) for business. Mimecast Unified Email Management ??? (UEM) offers email continuity, security, archiving and compliance with all current legislation. To find out more, contact Mimecast<<http://www.mimecast.co.za/uem>>.

Disclaimer

The information contained in this communication from the sender is confidential. It is intended solely for use by the recipient and others authorized to receive it. If you are not the recipient, you are hereby notified that any disclosure, copying, distribution or taking action in relation of the contents of this information is strictly prohibited and may be unlawful.

This email has been scanned for viruses and malware, and automatically archived by **Mimecast SA (Pty) Ltd**, an innovator in Software as a Service (SaaS) for business. **Mimecast Unified Email Management ??? (UEM)** offers email continuity, security, archiving and compliance with all current legislation. To find out more, [contact Mimecast](#).

Andrea Gibb

From: Andrea Gibb
Sent: Monday, 13 February 2017 12:58 PM
To: 'Naude, Ono, Vodacom South Africa'
Cc: Stephan Jacobs
Subject: RE: Turbine coordinates for site near Loeriesfontein Leeuberg ,
Attachments: 20170111-CH-Graskoppies-141MW-47T-AW3.0-150-7x3RD (220deg)-BAv3_Points.kmz; 20170111-CH-Hartebeesleegte-141MW-47T-AW3.0-150-7x3RD (220deg)-BAv3_Poin....kmz; 20170111-CH-lthemba-141MW-47T-AW3.0-150-7x3RD (220deg)-BAv3_Points.kmz; 20170111-CH-Xhaboom-141MW-47T-AW3.0-150-7x3RD (220deg)-BAv3_Points.kmz

Hi Ono

Thank you for your email. Attached are the turbine locations that will be assessed in the EIA phase of the project.

Kind Regards

Andrea Gibb (B.Sc. Landscape Architecture; B.Sc.(Hons) Environmental Management)

Environmental Practitioner and Visual Specialist

SiVEST Environmental Division



SiVEST is a Level 3 BBBEE Contributor

Direct +27 11 798 0638 **Tel** +27 11 798 0600 **fax** +27 11 803 7272 **cell** +27 72 587 6525
email andrea@sivest.co.za **website** www.sivest.co.za



Consulting Engineers - Project Managers - Environmental Consultants - Town and Regional Planners
Durban - Johannesburg - Pietermaritzburg - Richards Bay - Ladysmith - Cape Town - Harare (Zimbabwe)

From: Naude, Ono, Vodacom South Africa [mailto:ono.naude@vodacom.co.za]
Sent: Friday, 10 February 2017 12:33 PM
To: Andrea Gibb <AndreaG@sivest.co.za>
Subject: Turbine coordinates for site near Loeriesfontein Leeuberg ,

Hi Andrea, I am from Vodacom and would like to know if you can forward me the turbine coordinates for these site so I can check is there are any risks to our communication systems in the area . I believe there should be no issue , but I need to check.

Thank you

Ono Naude

This e-mail is classified C2 - Vodacom Restricted - Information to be used inside Vodacom but it may be shared with authorised partners.

“This e-mail is sent on the Terms and Conditions that can be accessed by Clicking on this link <https://webmail.vodacom.co.za/tc/default.html> ”

Stephan Jacobs

From: Seoka Lekota <SLekota@environment.gov.za>
Sent: Monday, July 10, 2017 3:14 PM
To: sivist_PPP; Andrea Gibb; Stephan Jacobs; 'rebecca.thomas@mainstreamrp.com'
Cc: 'Lizell Stroh'; 'Brian Fisher'; 'Moses Mahunonyane'; 'Ester Makungo'; 'Ntsundeni Ravhogoni'; 'Patrick Lenyibi'; 'Simon Gear'; MMatlala Rabothata; 'Heleen van den Heever'; 'Amanda Bester'; 'Nicole Abrahams'; 'Simphiwe Masilela'; 'Johanna Morobane'; 'Hettie Buys'; 'Paul Avenant'; 'Madyo Sindisile'; 'Johan Koegelenberg'; 'Thulani Mthombeni'; 'Gert Steenkamp'; 'Adriaan Tiplady'; 'Natasha Higgitt'; 'Jaco Roelofse'; 'Jacoline Mans'; 'Sam Fiff'; 'Morgan Griffiths'; 'Henning Myburg'; 'John Geeringh'; 'Lourens Leeuwner'; 'Candice Spammer'; 'ceo@birdlife.org.za'; 'kmothomi@ncpg.gov.za'; 'leflourd@dws.gov.za'; 'municipalmanager@hantam.gov.za'; 'munman@khaima.gov.za'; 'commonage@khaima.gov.za'; 'Jannie Loubser'; 'Madyo Sindisile'
Subject: RE: Four Proposed Mainstream Wind Farms near Loeriesfontein: DSRs Available for Review

Good Day

Please note that request for comments should be send to us via registered mail and addressed to Directorate: Biodiversity Conservation and not to me directly since this might cause a delay in responding to your comments. It should be further noted that request for Biodiversity comments send via email would not be considered until an official registered mail with a hard copy or CD is received by the Directorate.

Hope the above is in order.

Regards

*Mr. Seoka Lekota [Pr.Sci.Nat.]
Department of Environmental Affairs
Directorate: Biodiversity Consaervation
Private Bag X447
PRETORIA
0001*

Tel: +27(0)12 399 9573

E-mail: slekota@environment.gov.za

From: sivist_PPP [mailto:sivist_ppp@sivest.co.za]

Sent: 21 June 2017 04:42 PM

To: Andrea Gibb; Stephan Jacobs; 'rebecca.thomas@mainstreamrp.com'

Cc: 'Lizell Stroh'; 'Brian Fisher'; 'Moses Mahunonyane'; 'Ester Makungo'; 'Ntsundeni Ravhogoni'; 'Patrick Lenyibi'; 'Simon Gear'; Seoka Lekota; MMatlala Rabothata; 'Heleen van den Heever'; 'Amanda Bester'; 'Nicole Abrahams'; 'Simphiwe Masilela'; 'Johanna Morobane'; 'Hettie Buys'; 'Paul Avenant'; 'Madyo Sindisile'; 'Johan Koegelenberg'; 'Thulani Mthombeni'; 'Gert Steenkamp'; 'Adriaan Tiplady'; 'Natasha Higgitt'; 'Jaco Roelofse'; 'Jacoline Mans'; 'Sam Fiff'; 'Morgan Griffiths'; 'Henning Myburg'; 'John Geeringh'; 'Lourens Leeuwner'; 'Candice Spammer'; 'ceo@birdlife.org.za'; 'kmothomi@ncpg.gov.za'; 'leflourd@dws.gov.za'; 'municipalmanager@hantam.gov.za'; 'munman@khaima.gov.za';

'commonage@khaima.gov.za'; 'Jannie Loubser'; 'Madyo Sindisile'

Subject: Four Proposed Mainstream Wind Farms near Loeriesfontein: DSRs Available for Review

******* Please note that this email was sent from a NO REPLY email address. Please do not reply to this address as it is an unmonitored email account.*******

Dear Stakeholder,

ENVIRONMENTAL IMPACT ASSESSMENTS (EIAs) FOR THE PROPOSED DEVELOPMENT OF FOUR (4) WIND FARMS NEAR LOERIESFONTEIN, NORTHERN CAPE PROVINCE

- **Graskoppies Wind Farm – (DEA Ref No: To be announced)**
- **Xha! Boom Wind Farm – (DEA Ref No: To be announced)**
- **Hartebeest Leegte Wind Farm – (DEA Ref No: To be announced)**
- **Ithemba Wind Farm – (DEA Ref No: To be announced)**

SiVEST is in the process of undertaking the Environmental Impact Assessments (EIAs) for the proposed development of the above mentioned four (4) Mainstream Wind Farms near Loeriesfontein in the Northern Cape.

We would like to take this opportunity to inform you that, in accordance with the National Environmental Management Act (NEMA) (as amended), the Draft Scoping Reports (DSRs) will be made available for public comment and review as from **Wednesday 21 June 2017 to Friday 21 July 2017** (before end of business day).

The DSRs as well as the accompanying appendices are available online (<http://www.sivest.co.za/> click on 'Downloads' and navigate to '13622 Mainstream Wind Farms') and an electronic copy (on CD) has been posted to you. We kindly request that you submit your comments to Public Participation Office at the below details, on or before **Friday 21 July 2017** (before end of business day). SiVEST will forward any comments received after the public comment and review period directly to the relevant case officer at the Department of Environmental Affairs (DEA). Should you have any questions or queries please do not hesitate to contact us at:

Stephan Jacobs

PO BOX 2921, Rivonia, 2128

Tel – (011) 798 0600

Fax – (011) 803 7272

Email – stephanj@sivest.co.za

Kind Regards,

Andrea Gibb (*B.Sc. Landscape Architecture; B.Sc.(Hons) Environmental Management*)

Environmental Practitioner and Visual Specialist

SiVEST Environmental Division

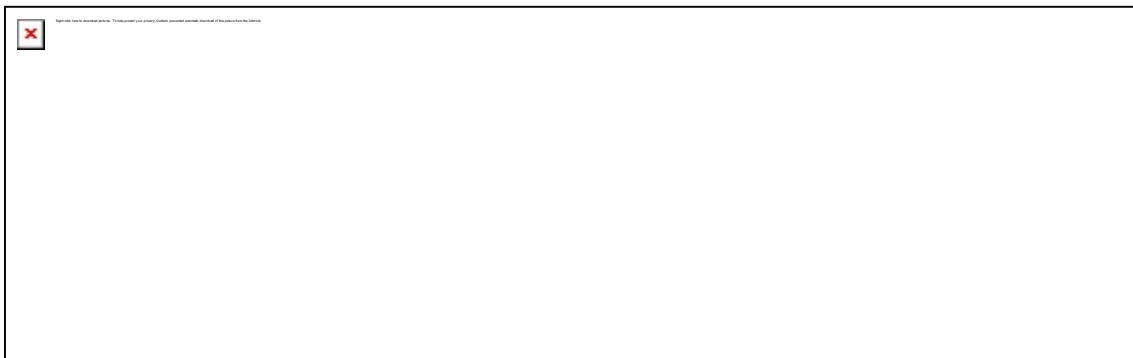



SIVEST



SIVEST is a Level 3 BBBEE Contributor

Direct +27 11 798 0638 **Tel** +27 11 798 0600 **fax** +27 11 803 7272
email andreag@sivest.co.za **website** www.sivest.co.za

Consulting Engineers - Project Managers - Environmental Consultants - Town and Regional Planners
Durban - Johannesburg - Pietermaritzburg - Richards Bay - Ladysmith - Cape Town - Harare (Zimbabwe)

Disclaimer

The information contained in this communication from the sender is confidential. It is intended solely for use by the recipient and others authorized to receive it. If you are not the recipient, you are hereby notified that any disclosure, copying, distribution or taking action in relation of the contents of this information is strictly prohibited and may be unlawful.

This email has been scanned for viruses and malware, and automatically archived by **Mimecast SA (Pty) Ltd**, an innovator in Software as a Service (SaaS) for business. **Mimecast Unified Email Management ??? (UEM)** offers email continuity, security, archiving and compliance with all current legislation. To find out more, [contact Mimecast](#).

Please consider the environment before you print this email. Only print if it is essential. A message from the Department of Environmental Affairs.

Please consider the environment before you print this email. Only print if it is essential. A message from the Department of Environmental Affairs.

This message and any attachments transmitted with it are intended solely for the addressee(s) and may be legally privileged and/or confidential. If you have received this message in error please destroy it and notify the sender. Any unauthorized usage, disclosure, alteration or dissemination is prohibited. The Department of Environmental Affairs accepts no responsibility for any loss whether it be direct, indirect or consequential, arising from information made available and actions resulting there from. The views and opinions expressed in this e-mail message may not necessarily be those of Management.

Stephan Jacobs

From: sivest_PPP
Sent: Friday, August 4, 2017 2:16 PM
Cc: Andrea Gibb; Stephan Jacobs; Hlengiwe Ntuli; 'Nicolene Venter'; 'rebecca.thomas@mainstreamrp.com'
Subject: Four Proposed Mainstream Wind Farms near Loeriesfontein: FSR Comment Period Starting

******* Please note that this email was sent from a NO REPLY email address. Please do not reply to this address as it is an unmonitored email account.*******

Dear Interested and/or Affected Party

ENVIRONMENTAL IMPACT ASSESSMENTS (EIAs) FOR THE PROPOSED DEVELOPMENT OF FOUR (4) WIND FARMS NEAR LOERIESFONTEIN, NORTHERN CAPE PROVINCE

- **Graskoppies Wind Farm – (DEA Ref No: 14/12/16/3/3/2/1017)**
- **Xha! Boom Wind Farm – (DEA Ref No: 14/12/16/3/3/2/1018)**
- **Hartebeest Leegte Wind Farm – (DEA Ref No: 14/12/16/3/3/2/1015)**
- **Ithemba Wind Farm – (DEA Ref No: 14/12/16/3/3/2/1016)**

• SUBMISSION OF FINAL SCOPING REPORTS TO DEPARTMENT OF ENVIRONMENTAL AFFAIRS

Following the public comment and review period of the Draft Scoping Reports (DSRs) for the above-mentioned projects from Wednesday the 21st of June 2017 to Friday the 21st of July 2017 (end of business day) the DSRs were updated, taking into consideration the issues and concerns raised by stakeholders, and the Final Scoping Reports (FSRs) were submitted to the Department of Environmental Affairs (DEA) on Friday the 4th of August 2017.

The reports are available on SiVEST's website: <http://www.sivest.co.za/>, click on 'Downloads' then browse to the folder '*13622 Mainstream Wind Farms*'.

Should you wish to receive an electronic copy of the FSRs (on CD) please forward your request in writing to us. Comments can be submitted as follows:

Hlengiwe Ntuli or Stephan Jacobs

PO Box 2921, RIVONIA, 2128

Phone: (011) 798 0600

E-mail: hlengiw@zivest.co.za / stephanj@zivest.co.za

Fax: (011) 803 7272

We would like to thank you for your active and meaningful contribution to the EIA and Public Participation Process.

Kind Regards,

Onderwerp: Vier voorgestelde Mianstream Windplase naby Loeriesfontein: FBV Komentaar Periode Begin

Geagte Belangstellende en/of Geaffekteerde Party

OMGEWINGSIMPAKEVALUERINGS (OIE's) VIR DIE BEOOGDE ONTWIKKELING VAN VIER (4) WINDPLASE NABY LOERIESFONTEIN, NOORD-KAAPROVINSIE

- **Graskoppies Windplaas – (DO Verw. No.: 14/12/16/3/3/2/1017)**

- **Xha! Boom Windplaas – (DO Verw. No.: 14/12/16/3/3/2/1018)**
- **Hartebeest Leegte Windplaas – (DO Verw. No.: 14/12/16/3/3/2/1015)**
- **Ithemba Windplaas – (DO Verw. No.: 14/12/16/3/3/2/1016)**

• **INDIENING VAN DIE FINALE BESTEKOPNAMEVERSLAE BY DIE DEPARTEMENT VAN OMGEWINGSAKE**

Na aanleiding van die kommentaar deur die openbare oorsigtydperk van die Konsep Bestekopnameverslae vir die bogenoemde projekte van Woensdag 21 Junie 2017 tot Vrydag 21 Julie 2017 (teen sluitingstyd) was die Konsep Bestekopnameverslae bygewerk en gefinaliseer, met inagneming van die kwessies en kommentaar wat deur belanghebbendes opgewek was, en die Finale Bestekopnameverslae was op Vrydag 04 Augustus 2017 aan die Departement van Omgewingsake (DO) ingedien vir oorweging.

Die verslae is ook beskikbaar op SiVEST se webwerf: <http://www.sivest.co.za/>, klik op 'Downloads' en soek dan vir die vouer '13622 Mainstream Wind Farms'.

As u 'n elektroniese kopie van die Finale Bestekopnameverslae (op CD) wil ontvang, moet u dit asseblief skriftelik by ons versoek. Kommentaar kan soos volg ingedien word:

Hlengiwe Ntuli of Stephan Jacobs

Posbus 2921, RIVONIA, 2128

Telefoon: 011 798 0600

E-pos: hlengiwen@sivest.co.za / stephanj@sivest.co.za

Faks: 011 803 7272

Ons dank u byvoorbaat vir u aktiewe en betekenisvolle bydrae tot die OIE's en die Openbare Deelnameproses.

Vriendelike groete

Kind Regards

Andrea Gibb

Senior Manager

SiVEST Environmental Division



SiVEST is a Level 3 BBBEE Contributor

Direct +27 11 798 0638 **Tel** +27 11 798 0600 **fax** +27 11 803 7272

email andreag@sivest.co.za **website** www.sivest.co.za



Consulting Engineers - Project Managers - Environmental Consultants - Town and Regional Planners
 Durban - Johannesburg - Pietermaritzburg - Richards Bay - Ladysmith - Cape Town - Harare (Zimbabwe)

Andrea Gibb

From: Nicolene Venter <nicolene@imaginativeafrica.co.za>
Sent: Tuesday, October 18, 2016 3:45 PM
To: admin2@hantam.gov.za
Cc: Andrea Gibb
Subject: EIAs: Proposed four (4) Leeuwborg Wind Farms and BAs for associated Power Lines and Substations near Loeriesfontein, Northern Cape Province

Importance: High

Dear Riana,

Thank you for taking my call this afternoon – it was good to hear your voice again!

SiVEST has been appointed by South Africa Mainstream Renewable Power Developments (Pty) Ltd (hereafter referred to as Mainstream), the developer, as the independent Environmental Assessment Practitioner (EAP) to undertake the required Environmental Impact Assessment (EIA) processes for the four (4) proposed wind farm developments and the Basic Assessment processes for the four (4) proposed grid connection developments. Each of the four (4) wind farm developments' grid connection consist currently of three (3) options.

The four (4) wind farm developments being proposed are:

- Graskoppies Wind Farm (140MW), located on the Farms:
 - Graskoppies No 176, Ptn 2 (western portion of property); and
 - Hartebeest Leegte No 216, Ptn 1 (western portion of property)
- Itemba Wind Farm (140MW)
 - Graskoppies No 176, Ptn 2 (eastern portion of property); and
 - Hartebeest Leegte No 216, Ptn 1 (eastern portion of property)
- !Xha Boom Wind Farm (140MW), located on the Farm:
 - George Vley No 217, Ptn 2
- Hartebeesleegte Wind Farm (140MW), located on the Farm:
 - Hartebeest Leegte No 216, Remainder

An electronic copy of the Background Information Document will be forwarded to you as soon as it is available.

Riana, as discussed, I would like to secure a date and time with Hantam Local Municipality Official for an informal information meeting and proposing the following dates and time:

- Wednesday, 26 October 2016 at 14h00
or
- Thursday, 27 October 2016 at 09h00

at Hantam Local Municipality's Offices in Calvinia or should the Officials be at the time in Loeriesfontein, we can meet at Hantam Local Municipality's Satellite Office in Loeriesfontein.

The Officials that we discussed to whom I need to introduce the project to are:

- Mr Rodger Swarts, Mayor
- Mr Riaan van Wyk, Acting Municipal Manager
- Mr Tsegewe, Manager: Infrastructure

It would be appreciated if a confirmed date and time can be communicated to me as soon as possible as I need to secure meeting times with the landowners of the propose development sites and the grid corridors.

Looking forward to hear from you.

Kind regards,

Nicolene Venter
Public Participation and Stakeholder Engagement Practitioner
Imaginative Africa (Pty) Ltd
PO Box 61164
PIERRE VAN RYNEVELD, 0157

Tel.: 012 662 2843 / **Cell:** 083 377 9112 / **E-mail:** nicolene@imaginativeafrica.co.za



Please, consider our environment. Before printing this e-mail ask yourself: "Do I need a hard copy?"

Stephan Jacobs

From: Seoka Lekota <SLekota@environment.gov.za>
Sent: Monday, July 10, 2017 3:17 PM
To: sivist_PPP
Cc: Andrea Gibb; Stephan Jacobs; 'rebecca.thomas@mainstreamrp.com'; Stanley Tshitwamulomoni
Subject: RE: Four Proposed Wind Farms near Loeriesfontein: Revised BID

Good Day

Please note that request for comments should be send to us via registered mail and addressed to Directorate: Biodiversity Conservation and not to me directly since this might cause a delay in responding to your comments. It should be further noted that request for Biodiversity comments send via email would not be considered until an official registered mail with a hard copy or CD is received by the Directorate.

Hope the above is in order.

Regards

*Mr. Seoka Lekota [Pr.Sci.Nat.]
Department of Environmental Affairs
Directorate: Biodiversity Consaervation
Private Bag X447
PRETORIA
0001*

*Tel: +27(0)12 399 9573
E-mail: slekota@environment.gov.za*

From: sivist_PPP [mailto:sivist_ppp@sivist.co.za]
Sent: 19 June 2017 03:54 PM
Cc: Andrea Gibb; Stephan Jacobs; 'rebecca.thomas@mainstreamrp.com'
Subject: Four Proposed Wind Farms near Loeriesfontein: Revised BID

******* Please note that this email was sent from a NO REPLY email address. Please do not reply to this address as it is an unmonitored email account.*******

Dear Interested and/or Affected Party

ENVIRONMENTAL IMPACT ASSESSMENTS (EIAs) FOR THE PROPOSED DEVELOPMENT OF FOUR (4) WIND FARMS AND BASIC ASSESSMENTS (BAs) FOR THE ASSOCIATED GRID CONNECTION NEAR LOERIESFONTEIN, NORTHERN CAPE PROVINCE

- **Graskoppies Wind Farm – (DEA Ref No: To be announced)**
- **Xha! Boom Wind Farm – (DEA Ref No: To be announced)**
- **Hartebeest Leegte Wind Farm – (DEA Ref No: To be announced)**
- **Ithemba Wind Farm – (DEA Ref No: To be announced)**
- **Graskoppies Grid Connection – (DEA Ref No: To be announced)**
- **Xha! Boom Grid Connection – (DEA Ref No: To be announced)**

- **Hartebeest Leegte Grid Connection – (DEA Ref No: To be announced)**
- **Ithemba Grid Connection – (DEA Ref No: To be announced)**

Please note that SiVEST SA (Pty) Ltd was appointed by South Africa Mainstream Renewable Power Developments (Pty) Ltd as the Environmental Assessment Practitioner (EAP) for the above mentioned projects. In October 2016, all interested and/or affected parties (I&APs) were invited to participate in the Environmental Impact Assessment (EIA) processes for the wind farm developments and the Basic Assessment (BA) processes for the associated grid connections and were sent a Background Information Document (BID). Since this communication there have been some changes to the proposed developments which include the following;

- The addition of a new power line assessment corridor;
- A change in the generation capacity of the wind farms; and
- A change in the maximum hub height and rotor diameter.

As such, the BID has been updated based on the above changes and is attached for your perusal.

Kindly note that the Draft Scoping Reports (DSRs) will be available for public comment in June 2017 and you will be notified accordingly.

Kind Regards

Geagte Belangstellende en/of Geaffekteerde Party

OMGEWINGSIMPAAKEVALUERINGS (OIE's) VIR DIE BEOOGDE ONTWIKKELING VAN VIER (4) WINDPLASE EN BASIESE EVALUERINGS (BE's) VIR DIE GEPAAARDGAANDE ROOSTERKONNEKSIES NABY LOERIESFONTEIN, NOORD-KAAPPROVINSIE

- **Graskoppies Windplaas – (DO Verw. No.: Moet nog aangekondig word)**
- **Xha! Boom Windplaas – (DO Verw. No.: Moet nog aangekondig word)**
- **Hartebeest Leegte Windplaas – (DO Verw. No.: Moet nog aangekondig word)**
- **Ithemba Windplaas – (DO Verw. No.: Moet nog aangekondig word)**
- **Graskoppies Roosterkonneksie – (DO Verw. No.: Moet nog aangekondig word)**
- **Xha! Boom Roosterkonneksie – (DO Verw. No.: Moet nog aangekondig word)**
- **Hartebeest Leegte Roosterkonneksie – (DO Verw. No.: Moet nog aangekondig word)**
- **Ithemba Roosterkonneksie – (DO Verw. No.: Moet nog aangekondig word)**

Neem asseblief kennis dat South Africa Mainstream Renewable Power Developments (Edms.) Bpk. vir SiVEST SA (Edms.) Bpk. aangestel het as die Omgewingsevalueringspraktisyn (OEP) vir die bogenoemde projekte. In Oktober 2016 is alle belangstellende en/of geaffekteerde partye (B&GP's) genooi om deel te neem aan die Omgewingsimpakevalueringsprosesse (OIE-prosesse) vir die windplaasontwikkelings en die Basiese Evalueeringsprosesse (BE-prosesse) vir die gepaardgaande roosterkonneksies en 'n Agtergrondinligtingsdokument (AID) is aan hulle gestuur. Sedert hierdie skrywe was daar sekere veranderinge aan die beoogde ontwikkelings wat die volgende insluit:

- Die byvoeging van 'n nuwe kraglynkorridor vir evaluering;
- 'n verandering aan die opwekkingsvermoë van die windplase; en
- 'n verandering aan die maksimum naafhoogte en rotordeursnee.

Die AID is dienooreenkomstig bygewerk op grond van die bogenoemde veranderinge en aangeheg vir u insae.

Let asseblief daarop dat die Konsep Bestekopnameverslae (KBV's) in Junie 2017 beskikbaar sal wees vir openbare kommentaar en u sal dienooreenkomstig verwittig word.

Vriendelike groete

Kind Regards,

Andrea Gibb (*B.Sc. Landscape Architecture; B.Sc.(Hons) Environmental Management*)
Environmental Practitioner and Visual Specialist
SiVEST Environmental Division

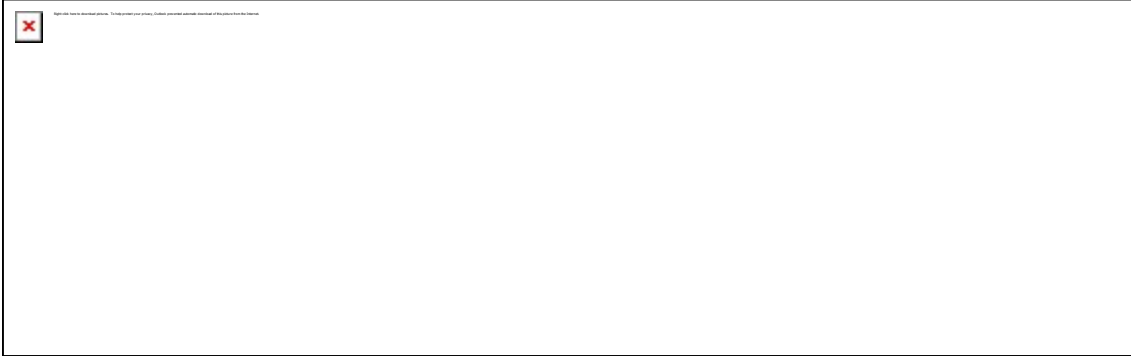



SIVEST



SIVEST is a Level 3 BBBEE Contributor

Direct +27 11 798 0638 **Tel** +27 11 798 0600 **fax** +27 11 803 7272
email andreag@sivest.co.za **website** www.sivest.co.za

Consulting Engineers - Project Managers - Environmental Consultants - Town and Regional Planners
Durban - Johannesburg - Pietermaritzburg - Richards Bay - Ladysmith - Cape Town - Harare (Zimbabwe)

Disclaimer

The information contained in this communication from the sender is confidential. It is intended solely for use by the recipient and others authorized to receive it. If you are not the recipient, you are hereby notified that any disclosure, copying, distribution or taking action in relation of the contents of this information is strictly prohibited and may be unlawful.

This email has been scanned for viruses and malware, and automatically archived by **Mimecast SA (Pty) Ltd**, an innovator in Software as a Service (SaaS) for business. **Mimecast Unified Email Management ??? (UEM)** offers email continuity, security, archiving and compliance with all current legislation. To find out more, [contact Mimecast](#).

Please consider the environment before you print this email. Only print if it is essential. A message from the Department of Environmental Affairs.

Please consider the environment before you print this email. Only print if it is essential. A message from the Department of Environmental Affairs.

This message and any attachments transmitted with it are intended solely for the addressee(s) and may be legally privileged and/or confidential. If you have received this message in error please destroy it and notify the sender. Any unauthorized usage, disclosure, alteration or dissemination is prohibited. The Department of Environmental Affairs accepts no responsibility for any loss whether it be direct, indirect or consequential, arising from information made available and actions resulting there from. The views and opinions expressed in this e-mail message may not necessarily be those of Management.

Andrea Gibb

From: Andrea Gibb
Sent: Tuesday, 18 July 2017 1:57 PM
To: 'Stephnie Kot'
Cc: Stephan Jacobs
Subject: RE: Four Proposed Mainstream Wind Farms near Loeriesfontein: DSR Comment Period Starting

Hi Stephanie

Unfortunately as part of our quality management protocol we have to make use of our website, however we will upload a combined DSR for each of the wind farm projects which will include all of the appendices. This should be available on our website from tomorrow.

Kind Regards
Andrea Gibb
Senior Manager
SiVEST Environmental Division



SiVEST is a Level 3 BBBEE Contributor

Direct +27 11 798 0638 **Tel** +27 11 798 0600 **fax** +27 11 803 7272 **cell** +27 72 587 6525
email andreag@sivest.co.za **website** www.sivest.co.za



Consulting Engineers - Project Managers - Environmental Consultants - Town and Regional Planners
Durban - Johannesburg - Pietermaritzburg - Richards Bay - Ladysmith - Cape Town - Harare (Zimbabwe)

From: Stephnie Kot [mailto:stephnie.kot@aced.co.za]
Sent: Tuesday, 11 July 2017 12:14 PM
To: Andrea Gibb
Cc: Stephan Jacobs
Subject: FW: Four Proposed Mainstream Wind Farms near Loeriesfontein: DSR Comment Period Starting

Good day Andrea,

I hope you are well.

With regards to the below notification, can you advise if it would be possible to obtain a copy of the DSRs (inclusive of all appendices) via Dropbox? I am able to access the reports on the SiVest website, however it is not possible to easily download the entire report – instead each file has to be downloaded individually. While reviewing a DSR, once tends to jump between the DSR itself and the various Appendices – but having to download each individual file you wish to view becomes quite time consuming.

Please let me know if you would be able to provide a copy of the reports via Dropbox?

Many thanks.

Kind Regards,

Stephnie Kot

Email: stephnie.kot@aced.co.za

Tel: 021 670 1423

Cell: 083 318 3982

From: sivest_PPP [mailto:sivest_ppp@sivest.co.za]

Sent: 21 June 2017 04:28 PM

Cc: Andrea Gibb <AndreaG@sivest.co.za>; Stephan Jacobs <StephanJ@sivest.co.za>; 'rebecca.thomas@mainstreamrp.com' <rebecca.thomas@mainstreamrp.com>

Subject: Four Proposed Mainstream Wind Farms near Loeriesfontein: DSR Comment Period Starting

******* Please note that this email was sent from a NO REPLY email address. Please do not reply to this address as it is an unmonitored email account.*******

Dear Interested and/or Affected Party

ENVIRONMENTAL IMPACT ASSESSMENTS (EIAs) FOR THE PROPOSED DEVELOPMENT OF FOUR (4) WIND FARMS NEAR LOERIESFONTEIN, NORTHERN CAPE PROVINCE

- **Graskoppies Wind Farm – (DEA Ref No: To be announced)**
- **Xha! Boom Wind Farm – (DEA Ref No: To be announced)**
- **Hartebeest Leegte Wind Farm – (DEA Ref No: To be announced)**
- **Ithemba Wind Farm – (DEA Ref No: To be announced)**

SiVEST SA (Pty) Ltd was previously appointed by South Africa Mainstream Renewable Power Developments (Pty) Ltd as the Environmental Assessment Practitioner (EAP) for the above mentioned projects.

We would like to take this opportunity to inform you that, in accordance with the National Environmental Management Act (NEMA) (as amended), the Draft Scoping Reports (DSRs) for the above mentioned wind farm projects will be available for public comment and review as from **Wednesday 21 June 2017 to Friday 21 July 2017** (end of business day. Should you wish to receive an electronic copy of the DSRs (on CD) please forward your request in writing to us. Hard copies of the DSRs can be reviewed at the following public place:

VENUE	STREET ADDRESS	HOURS	CONTACT NO
Loeriesfontein Library	Main Street, Loeriesfontein	Mondays- Fridays 14h00 – 17h00	027 662 8607

The report is also available on SiVEST’s website: <http://www.sivest.co.za/>, click on ‘Downloads’ then browse to the folder ‘13622 Mainstream Wind Farms.

Attached is an English and Afrikaans letter notifying of the review period.

Kind Regards,

Andrea Gibb (B.Sc. Landscape Architecture; B.Sc.(Hons) Environmental Management)
Environmental Practitioner and Visual Specialist
SiVEST Environmental Division



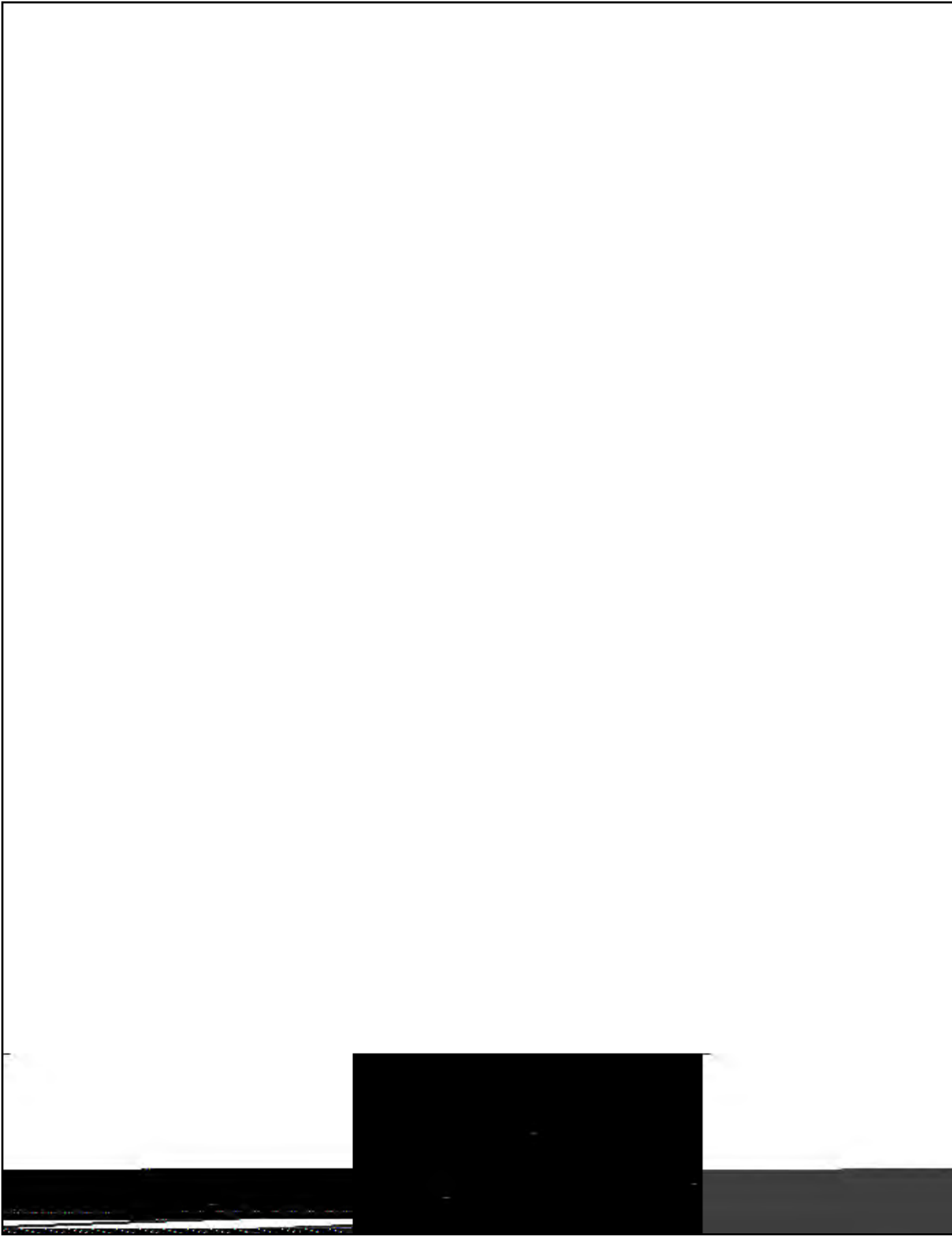

SIVEST is a Level 3 BBBEE Contributor

Direct +27 11 798 0638 **Tel** +27 11 798 0600 **fax** +27 11 803 7272

email andreaq@sivest.co.za website www.sivest.co.za

Consulting Engineers - Project Managers - Environmental Consultants - Town and Regional Planners
Durban - Johannesburg - Pietermaritzburg - Richards Bay - Ladysmith - Cape Town - Harare (Zimbabwe)

Disclaimer

The information contained in this communication from the sender is confidential. It is intended solely for use by the recipient and others authorized to receive it. If you are not the recipient, you are hereby notified that any disclosure, copying, distribution or taking action in relation of the contents of this information is strictly prohibited and may be unlawful.

This email has been scanned for viruses and malware, and automatically archived by **Mimecast SA (Pty) Ltd**, an innovator in Software as a Service (SaaS) for business. **Mimecast Unified Email Management ??? (UEM)** offers email continuity, security, archiving and compliance with all current legislation. To find out more, [contact Mimecast](#).

Mainstream Renewable Power South African
4th floor Mariendahl House
Newlands on Main
Corner Main and Campground Roads
Claremont 7735, Cape Town, South Africa
PO Box 45063

09 March 2017

Attention: Mrs. Rebecca Thomas

Dear Madam

RE: PROPOSED ESTABLISHMENT OF LEEUWBERG SUIT WIND ENERGY FACILITY

1. The above matter refers.
2. We wish to advise that Sentech SOC Ltd (“Sentech”) has received an application from Mainstream Renewable Power South Africa (“the applicant”), which plans to construct one Wind Turbine Generator (WTG) farms as described in annexure 1 hereto, at the Leeuwberg Suite Wind Turbine Generator (WTG) farms, hereafter referred to as “the site”, in accordance with the provisions of Section 29(1) (b) of the Electronic Communications Act no. 36 of 2005 (“the Act”).
3. Sentech has analysed the information provided by the applicant in accordance with the provisions of Section 29(1) (c) of the Act, and specifically the location of the site and confirm that there would be limited degradation of Sentech transmitted Terrestrial UHF/VHF Television (TV), and/or FM radio services in the planned deployment area, as indicated in annexure 1.
4. Sentech hereby grants the applicant approval to proceed with the construction of its energy project at the site subject to the following terms and conditions:
 - 4.1 Due to the fact that the findings made by Sentech are based on simulations and calculated on a theoretical model, using available data and assumptions where no data

was provided, such findings may change at any time should any further information be made available to or come to Sentech's attention;

- 4.2 At any time after the approval, and during construction of the project, should any radio transmissions be affected by construction activities, Sentech will give the applicant 7 (seven) day's written notice to remove the cause of the interference.
- 4.3 Under no circumstances whatsoever will Sentech be liable to the applicant or any third party for any damages, loss or costs, of any nature whatsoever or howsoever arising, suffered as a consequence of the aforementioned request and the applicant fully indemnify Sentech ;
- 4.4 Sentech prior written consent must first be obtained before any construction activities underneath, along, across or within close proximity to Sentech infrastructure can begin and shall comply with the applicable Sentech guidelines relating to clearances between equipment and the proposed construction activity. Furthermore, the applicant shall clearly adhere to, and ensure all installations shall be fully compliant with the Occupational Health and Safety Act No. 85 of 1993.
5. This approval is further subject to the submitted applications boundaries or structures listed in annexure 1 hereto, the materials used, as well as the size and positioning of structures declared in the application. If the services of Sentech or its clients is in any way compromised by a deviation or change of this submission, the applicant shall be liable for all costs to re-establish, or relocate the services, and under no circumstances whatsoever will Sentech be liable to the applicant or any other third party for any damages, loss or costs, of any nature whatsoever or howsoever arising, suffered as a consequence.
6. This approval is valid and applicable between Sentech and the applicant only. It does not include any approval for any of the other electronic communication operators which have current co-sharing agreements to utilise Sentech's radio masts.
7. Any additions, amendments, additional structures to be built, or any change to the energy farm boundaries, will require a new application to Sentech.
8. The validity of this approval is for a period of 12 (twelve) months. If construction of the designed project commences after the expiry of the twelve month period, the application must be re-submitted to Sentech for further evaluation and approval.

9. This approval does not imply any rights of access whatsoever to Sentech property or use of Sentech's access roads for construction or maintenance of the design project. Separate permission must be obtained from Sentech in this regard. Furthermore, Sentech reserves the right to claim damages in terms of Section 29 of the Act, for any loss or damages sustained as a result of damages to any of Sentech's electronic broadcast and communications infrastructure.
10. The applicant shall, in carrying out any work or project, take all the necessary precautions for the safety of Sentech's employees, contractors, representatives and its property, including the radio transmitters and links on or near the site against damages as a result of construction of the applicant's energy project.
11. The applicant shall be liable for all and any direct and/or indirect, and/or consequential damages or injury that may be caused by the applicant, its contractors, subcontractors, employees, agents or representatives to any employee, contractor, representative or property of Sentech including radio network transmitters and/or links or land which may have been disturbed shall be restored to the same condition in which it was before commencement of the construction of the energy project.
12. In no event will Sentech, its employees, contractors, or representatives be liable to the applicant or any third party whatsoever for special, collateral, exemplary, direct, indirect, incidental, consequential or any other damages of any nature whatsoever or howsoever arising (including without limitation, loss of goodwill, loss of profits or revenues, loss of savings, loss of use, interruptions or noisiness, or injury) whether or not such damages or injury occurred prior or subsequent to, or are alleged as a result of any Sentech radio network approved and/or not approved in terms of this letter, even if Sentech has been advised of the possibility of such damages or injury.

All Sentech rights are fully reserved.

Regards



Mr Serame Motlhake

Manager: Broadcast Planning

Date: 08/03/2017

ANNEXURE 1

The planned Leeuwsberg Suite WTG's are close (between 108km and 117km) to the Garies and Calvinia transmitters respectively. These WTG's will consist of a total amount of 188 WTG's.

WTG interference calculations and predictions which included 188 planned WTG's were completed successfully. The interference calculations and predictions indicated that the WTG's will have the potential to cause limited interferences on the existing VHF TV broadcast services.

The only analogue service that might be affected which is SABC 2 within the Garies (C30) and Calvinia (C21) transmitter stations coverage area. Digital UHF TV service that might be affected is Mux1 within the Garies (C30) and Calvinia (C21) transmitter stations coverage area.

Conclusion on the results and findings of the planned 188 total amount of WTG's in Leeuwsberg suite can be summarised as follows:

1. Potential interferences on analogue and Digital VHF/UHF TV coverage will not affect the quality of viewer services in the surrounding areas.
2. Potential interference on digital UHF TV coverage will not affect the quality of viewer services in the services in the surrounding areas
3. None of the existing analogue or DTT RBR broadcast feeds in the above mentioned areas will be affected;
4. No interference on FM services will be experienced;
5. None of the existing FM RBR feeds broadcast feeds in the area will be affected;

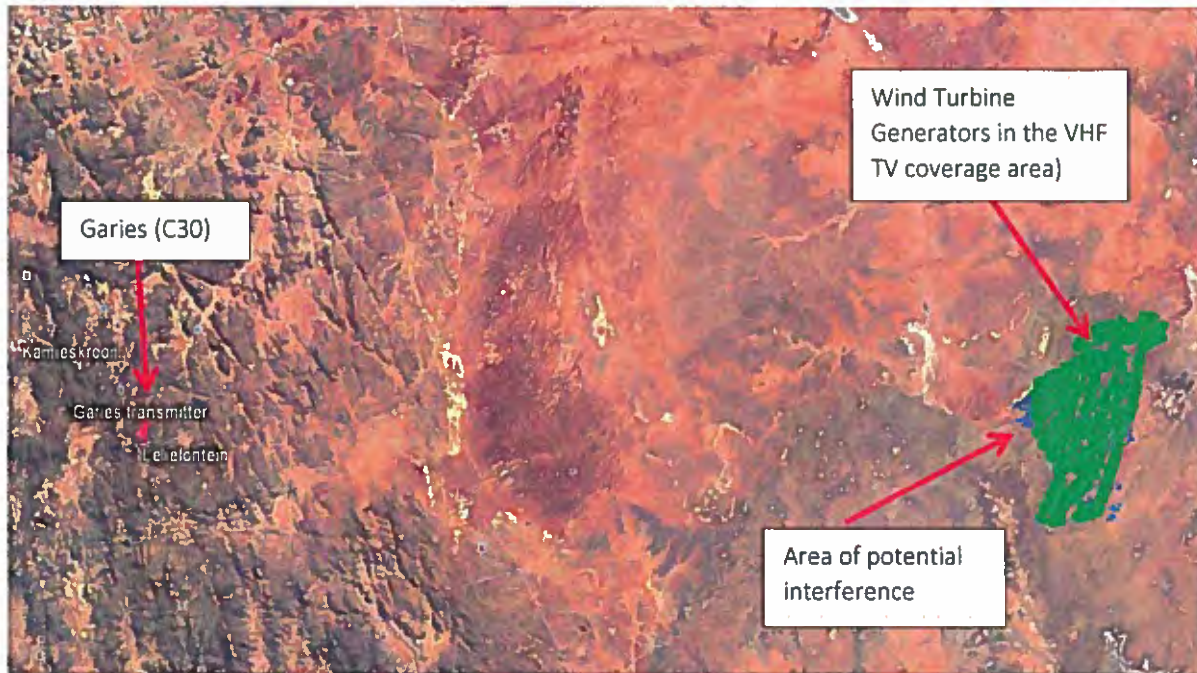

Map 1: Map indicating the affected area (blue) caused by 188 WTG's (Leeuweburg suite) on Garies Transmitter Site (C30) VHF /UHF TV transmitter SABC 2 and DTT Mux 1 area. (Google Earth Map)

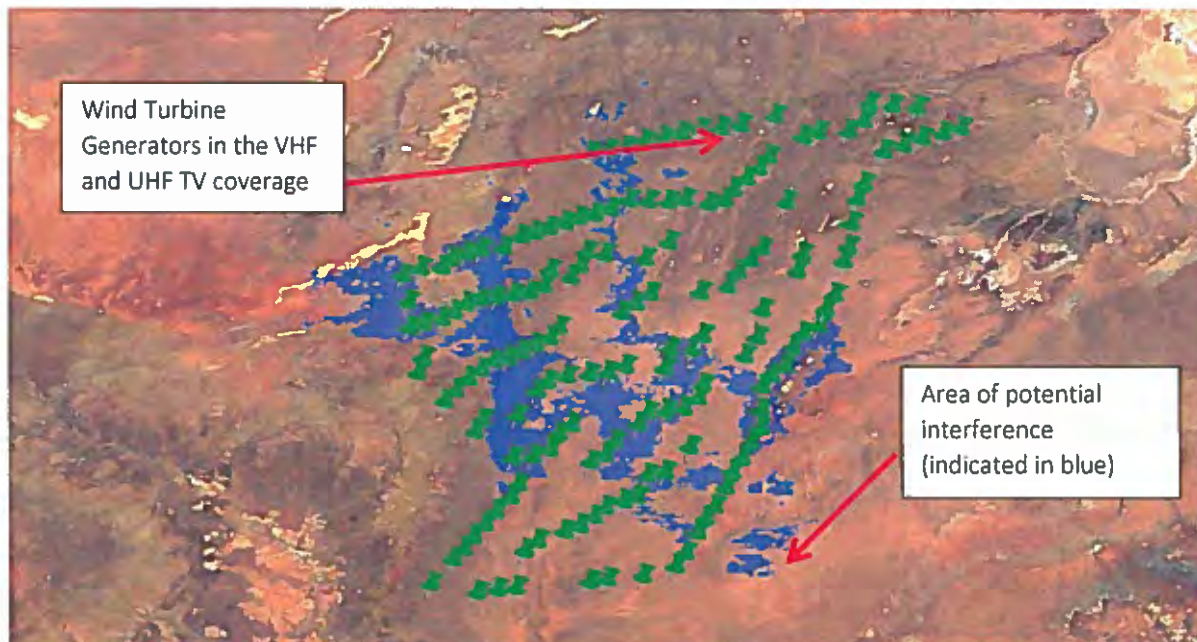

Map 2: Map indicating the affected area (blue) caused by 188 WTG's (Leeuweburg suite) on Garies Transmitter Site (C30) VHF /UHF TV transmitter SABC 2 and DTT Mux 1 area. (Google Earth Map)

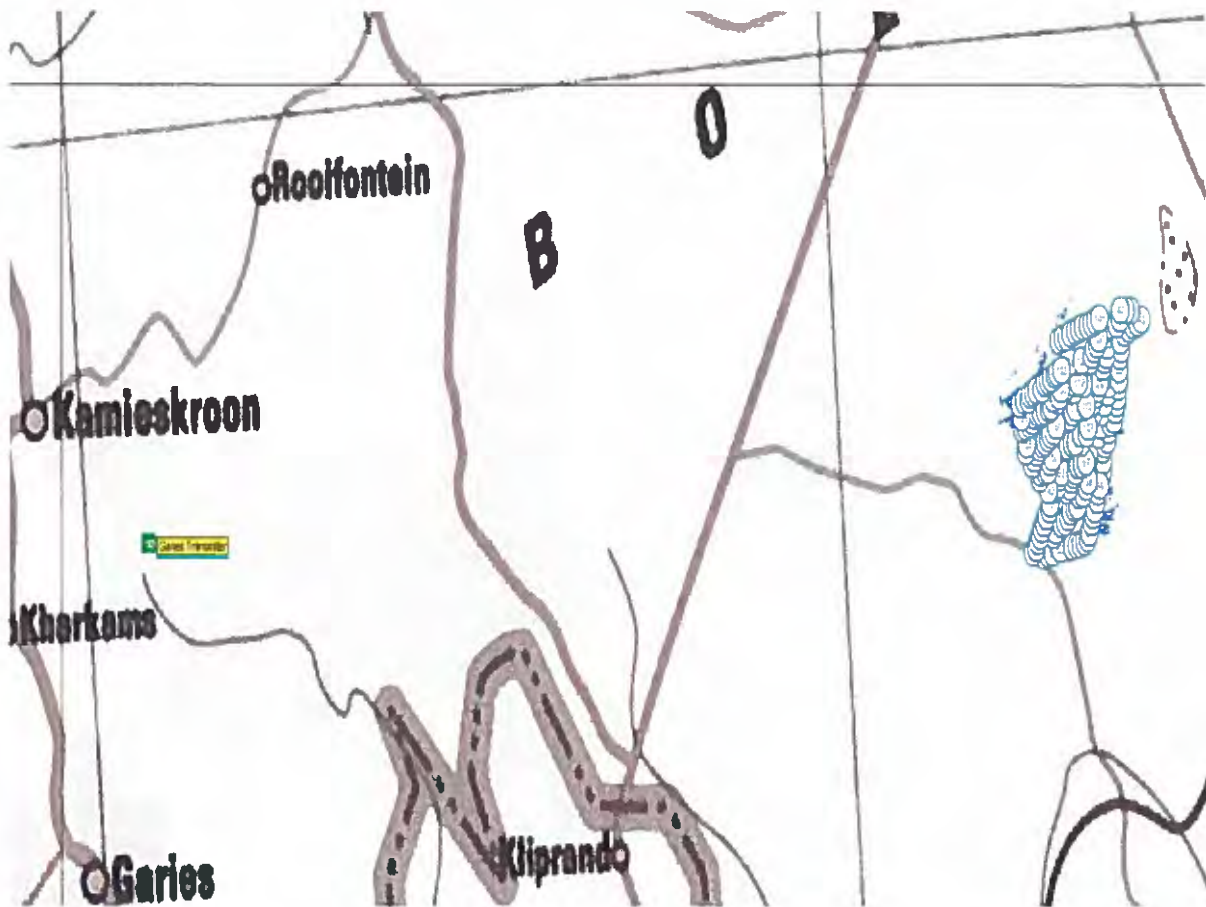

Map 3: Map indicating the affected area (blue) caused by 188 WTG's (Leeuwborg suite) Garies Transmitter Site (C30) VHF /UHF TV transmitter SABC 2 and DTT Mux 1 area. (ICS Map)



OFFICE OF THE REGIONAL LAND CLAIMS COMMISSIONER: NORTHERN CAPE

Hyesco Arcade, 4-8 Old Main Road, Kimberley, 8300 | PO Box 2458, Kimberley, 8300

Tel: (053) 807 5700 | Fax: (053) 831 6501

Enquiries: Refilwe Sekwati

To: South African Mainstream Renewable Power Developments (Pty) Ltd

PO BOX 45063

CLAREMONT

7735

LAND CLAIMS ENQUIRY:

1. **PORTION 2 OF THE FARM GEORGS VLEY NO. 127, SITUATE IN THE HANTAM MUNICIPALITY, DIVISION CALVINIA, NORTHERN CAPE.**
2. **REMAINDER OF THE FARM HARTEBEEST LEEGTE NO. 216 SITUATED IN THE CALVINIA DIVISIONAL COUNCIL, DIVISION CALVINIA, NORTHERN CAPE.**
3. **PORTION 1 OF THE FARM HARTEBEEST LEEGTE NO. 216, SITUATED IN THE CALVINIA DIVISIONAL COUNCIL, DIVISION CALVINIA, NORTHERN CAPE.**
4. **PORTION 2 OF THE FARM GRAS KOPPIES NO. 176, SITUATED IN THE CALVINIA DIVISIONAL COUNCIL, DIVISION CALVINIA, NORTHERN CAPE**

We refer to your letter dated: 18 October 2016

We confirm that as of the date of this letter no land claims appear on our database in respect of the Property. This includes the database for claims lodged by 31 December 1998; and those lodged between 1 July 2014 and 27 July 2016 in terms of the Restitution of Land Rights Amendment Act, 2014

Whilst the Commission takes reasonable care to ensure the accuracy of the information it provides, there are various factors that are beyond the Commission's control, particularly relating to claims that have lodged but not yet been gazetted such as:

1. Some Claimants referred to properties they claim dispossession of rights in land against using historical property descriptions which may not match the current property description; and
2. Some Claimants provided the geographic descriptions of the land they claim without mentioning the particular actual property description they claim dispossession of rights in land against.

The Commission therefore does not accept any liability whatsoever if through the process of further investigation of claims it is found that there is in fact a land claim in respect of the above property.

If you are aware of any change in the description of the above property after 19 June 1913 kindly supply us with such description so as to enable us to do a further search.

Yours faithfully

A handwritten signature in black ink, appearing to read 'Refilwe Sekwati', written over a dotted line.

REFILWE SEKWATI

Communication Division

REGIONAL LAND CLAIMS COMMISSION: NORTHERN CAPE

DATE: 12/01/17



Andrea Gibb

From: Tshgofatso Monama <temonama@ska.ac.za>
Sent: Wednesday, 05 July 2017 11:13 AM
To: Andrea Gibb
Cc: Stephan Jacobs
Subject: RE: Four Proposed Wind Farms near Loeriesfontein: Revised BID

Received, thank you.

On 05 Jul 2017 11:05, "Andrea Gibb" <AndreaG@sivest.co.za> wrote:

Dear Tshego

As per your request, please find attached the latest kml which shows the layouts that will be assessed in the EIA phase for each of the proposed wind farm developments.

Kind Regards

Andrea Gibb

Senior Manager

SiVEST Environmental Division



SiVEST is a Level 3 BBBEE Contributor

Direct [+27 11 798 0638](tel:+27117980638) **Tel** [+27 11 798 0600](tel:+27117980600) **fax** [+27 11 803 7272](tel:+27118037272) **cell** [+27 72 587 6525](tel:+27725876525)

email andrea@sivest.co.za **website** www.sivest.co.za

Consulting Engineers - Project Managers - Environmental Consultants - Town and Regional Planners

Durban - Johannesburg - Pietermaritzburg - Richards Bay - Ladysmith - Cape Town - Harare (Zimbabwe)

From: Tshegofatso Monama [mailto:temonama@ska.ac.za]
Sent: Wednesday, 05 July 2017 10:10 AM
To: Andrea Gibb; Stephan Jacobs
Subject: Fwd: Four Proposed Wind Farms near Loeriesfontein: Revised BID

Dear Andrea,

Kindly forward me the KML/KMZ or shapefiles of the proposed wind farm development.

Regards,

Tshego

----- Forwarded message -----

From: Adrian Tiplady <atiplady@ska.ac.za>
Date: Tue, Jul 4, 2017 at 9:51 PM
Subject: Fwd: Four Proposed Wind Farms near Loeriesfontein: Revised BID
To: Tshegofatso Monama <temonama@ska.ac.za>

----- Forwarded Message -----

Subject: Four Proposed Wind Farms near Loeriesfontein: Revised BID
Date: Mon, 19 Jun 2017 13:54:29 +0000
From: sivist_PPP <sivist_ppp@sivest.co.za>
CC: Andrea Gibb <AndreaG@sivest.co.za>, Stephan Jacobs <StephanJ@sivest.co.za>, 'rebecca.thomas@mainstreamrp.com' <rebecca.thomas@mainstreamrp.com>

******* Please note that this email was sent from a NO REPLY email address. Please do not reply to this address as it is an unmonitored email account.*******

Dear Interested and/or Affected Party

ENVIRONMENTAL IMPACT ASSESSMENTS (EIAs) FOR THE PROPOSED DEVELOPMENT OF FOUR (4) WIND FARMS AND BASIC ASSESSMENTS (BAs) FOR THE ASSOCIATED GRID CONNECTION NEAR LOERIESFONTEIN, NORTHERN CAPE PROVINCE

- **Graskoppies Wind Farm – (DEA Ref No: To be announced)**
- **Xha! Boom Wind Farm – (DEA Ref No: To be announced)**
- **Hartebeest Leegte Wind Farm – (DEA Ref No: To be announced)**
- **Ithemba Wind Farm – (DEA Ref No: To be announced)**
- **Graskoppies Grid Connection – (DEA Ref No: To be announced)**
- **Xha! Boom Grid Connection – (DEA Ref No: To be announced)**
- **Hartebeest Leegte Grid Connection – (DEA Ref No: To be announced)**
- **Ithemba Grid Connection – (DEA Ref No: To be announced)**

Please note that SiVEST SA (Pty) Ltd was appointed by South Africa Mainstream Renewable Power Developments (Pty) Ltd as the Environmental Assessment Practitioner (EAP) for the above mentioned projects. In October 2016, all interested and/or affected parties (I&APs) were invited to participate in the Environmental Impact Assessment (EIA) processes for the wind farm developments and the Basic Assessment (BA) processes for the associated grid connections and were sent a Background Information Document (BID). Since this communication there have been some changes to the proposed developments which include the following;

- The addition of a new power line assessment corridor;
- A change in the generation capacity of the wind farms; and
- A change in the maximum hub height and rotor diameter.

As such, the BID has been updated based on the above changes and is attached for your perusal.

Kindly note that the Draft Scoping Reports (DSRs) will be available for public comment in June 2017 and you will be notified accordingly.

Kind Regards

Geagte Belangstellende en/of Geaffekteerde Party

OMGEWINGSIMPAKEVALUERINGS (OIE's) VIR DIE BEOOGDE ONTWIKKELING VAN VIER (4) WINDPLASE EN BASIESE EVALUERINGS (BE's) VIR DIE GEPAARDGAANDE ROOSTERKONNEKSIES NABY LOERIESFONTEIN, NOORD-KAAPROVINSIE

- **Graskoppies Windplaas – (DO Verw. No.: Moet nog aangekondig word)**
- **Xha! Boom Windplaas – (DO Verw. No.: Moet nog aangekondig word)**
- **Hartebeest Leegte Windplaas – (DO Verw. No.: Moet nog aangekondig word)**
- **Ithemba Windplaas – (DO Verw. No.: Moet nog aangekondig word)**
- **Graskoppies Roosterkonneksie – (DO Verw. No.: Moet nog aangekondig word)**
- **Xha! Boom Roosterkonneksie – (DO Verw. No.: Moet nog aangekondig word)**
- **Hartebeest Leegte Roosterkonneksie – (DO Verw. No.: Moet nog aangekondig word)**
- **Ithemba Roosterkonneksie – (DO Verw. No.: Moet nog aangekondig word)**

Neem asseblief kennis dat South Africa Mainstream Renewable Power Developments (Edms.) Bpk. vir SIVEST SA (Edms.) Bpk. aangestel het as die Omgewingsevalueringspraktisyn (OEP) vir die bogenoemde projekte. In Oktober 2016 is alle belangstellende en/of geaffekteerde partye (B&GP's) genooi om deel te neem aan die Omgewingsimpakevalueringsprosesse (OIE-prosesse) vir die windplaasontwikkelings en die Basiese Evalueringsprosesse (BE-prosesse) vir die gepaardgaande roosterkonneksies en 'n Agtergrondinligtingsdokument (AID) is aan hulle gestuur. Sedert hierdie skrywe was daar sekere veranderinge aan die beoogde ontwikkelings wat die volgende insluit:

- Die byvoeging van 'n nuwe kraglynkorridor vir evaluering;
- 'n verandering aan die opwekkingsvermoë van die windplase; en
- 'n verandering aan die maksimum naafhoogte en rotordeursnee.

Die AID is dienooreenkomstig bygewerk op grond van die bogenoemde veranderinge en aangeheg vir u insae.

Let asseblief daarop dat die Konsep Bestekopnameverslae (KBV's) in Junie 2017 beskikbaar sal wees vir openbare kommentaar en u sal dienooreenkomstig verwittig word.

Vriendelike groete

Kind Regards,

Andrea Gibb (*B.Sc. Landscape Architecture; B.Sc.(Hons) Environmental Management*)

Environmental Practitioner and Visual Specialist

SiVEST Environmental Division



SiVEST is a Level 3 BBBEE Contributor

Direct [+27 11 798 0638](tel:+27117980638) **Tel** [+27 11 798 0600](tel:+27117980600) **fax** [+27 11 803 7272](tel:+27118037272)

email

andrag@sivest.co.za

website www.sivest.co.za

Consulting Engineers - Project Managers - Environmental Consultants - Town and Regional Planners

Durban - Johannesburg - Pietermaritzburg - Richards Bay - Ladysmith - Cape Town - Harare (Zimbabwe)

Disclaimer

The information contained in this communication from the sender is confidential. It is intended solely for use by the recipient and others authorized to receive it. If you are not the recipient, you are hereby notified that any disclosure, copying, distribution or taking action in relation of the contents of this information is strictly prohibited and may be unlawful.

This email has been scanned for viruses and malware, and automatically archived by **Mimecast SA (Pty) Ltd**, an innovator in Software as a Service (SaaS) for business. **Mimecast Unified Email Management ??? (UEM)** offers email continuity, security, archiving and compliance with all current legislation. To find out more, [contact Mimecast](#).

--

Disclaimer

The information contained in this communication from the sender is confidential. It is intended solely for use by the recipient and others authorized to receive it. If you are not the recipient, you are hereby notified that any disclosure, copying, distribution or taking action in relation of the contents of this information is strictly prohibited and may be unlawful.

This email has been scanned for viruses and malware, and automatically archived by **Mimecast SA (Pty) Ltd**, an innovator in Software as a Service (SaaS) for business. **Mimecast Unified Email Management ??? (UEM)** offers email continuity, security, archiving and compliance with all current legislation. To find out more, [contact Mimecast](#).

Andrea Gibb

From: Tshegofatso Monama <temonama@ska.ac.za>
Sent: Wednesday, 05 July 2017 10:10 AM
To: Andrea Gibb; Stephan Jacobs
Subject: Fwd: Four Proposed Wind Farms near Loeriesfontein: Revised BID
Attachments: 13622 LEEUWBERG JUN 2017.pdf; 13622 LEEUWBERG JUN 2017 AFR.PDF; 13622 Mainstream Wind Farm Updates Notification Ver1 19 June 2017 AG (Af....pdf; 13622 Mainstream Wind Farm Updates Notification Ver1 19 June 2017 AG.PDF

Dear Andrea,

Kindly forward me the KML/KMZ or shapefiles of the proposed wind farm development.

Regards,
Tshego

----- Forwarded message -----

From: Adrian Tiplady <atiplady@ska.ac.za>
Date: Tue, Jul 4, 2017 at 9:51 PM
Subject: Fwd: Four Proposed Wind Farms near Loeriesfontein: Revised BID
To: Tshegofatso Monama <temonama@ska.ac.za>

----- Forwarded Message -----

Subject: Four Proposed Wind Farms near Loeriesfontein: Revised BID
Date: Mon, 19 Jun 2017 13:54:29 +0000
From: sivist_PPP <sivist_ppp@sivest.co.za>
CC: Andrea Gibb <AndreaG@sivest.co.za>, Stephan Jacobs <StephanJ@sivest.co.za>, 'rebecca.thomas@mainstreamrp.com' <rebecca.thomas@mainstreamrp.com>

******* Please note that this email was sent from a NO REPLY email address. Please do not reply to this address as it is an unmonitored email account.*******

Dear Interested and/or Affected Party

ENVIRONMENTAL IMPACT ASSESSMENTS (EIAs) FOR THE PROPOSED DEVELOPMENT OF FOUR (4) WIND FARMS AND BASIC ASSESSMENTS (BAs) FOR THE ASSOCIATED GRID CONNECTION NEAR LOERIESFONTEIN, NORTHERN CAPE PROVINCE

- Graskoppies Wind Farm – (DEA Ref No: To be announced)
- Xha! Boom Wind Farm – (DEA Ref No: To be announced)
- Hartebeest Leegte Wind Farm – (DEA Ref No: To be announced)
- Ithemba Wind Farm – (DEA Ref No: To be announced)
- Graskoppies Grid Connection – (DEA Ref No: To be announced)
- Xha! Boom Grid Connection – (DEA Ref No: To be announced)

- **Hartebeest Leegte Grid Connection – (DEA Ref No: To be announced)**
- **Ithemba Grid Connection – (DEA Ref No: To be announced)**

Please note that SiVEST SA (Pty) Ltd was appointed by South Africa Mainstream Renewable Power Developments (Pty) Ltd as the Environmental Assessment Practitioner (EAP) for the above mentioned projects. In October 2016, all interested and/or affected parties (I&APs) were invited to participate in the Environmental Impact Assessment (EIA) processes for the wind farm developments and the Basic Assessment (BA) processes for the associated grid connections and were sent a Background Information Document (BID). Since this communication there have been some changes to the proposed developments which include the following;

- The addition of a new power line assessment corridor;
- A change in the generation capacity of the wind farms; and
- A change in the maximum hub height and rotor diameter.

As such, the BID has been updated based on the above changes and is attached for your perusal.

Kindly note that the Draft Scoping Reports (DSRs) will be available for public comment in June 2017 and you will be notified accordingly.

Kind Regards

Geagte Belangstellende en/of Geaffekteerde Party

OMGEWINGSIMPAKEVALUERINGS (OIE's) VIR DIE BEOOGDE ONTWIKKELING VAN VIER (4) WINDPLASE EN BASIESE EVALUERINGS (BE's) VIR DIE GEPAAARDGAANDE ROOSTERKONNEKSIES NABY LOERIESFONTEIN, NOORD-KAAPPROVINSIE

- **Graskoppies Windplaas – (DO Verw. No.: Moet nog aangekondig word)**
- **Xha! Boom Windplaas – (DO Verw. No.: Moet nog aangekondig word)**
- **Hartebeest Leegte Windplaas – (DO Verw. No.: Moet nog aangekondig word)**
- **Ithemba Windplaas – (DO Verw. No.: Moet nog aangekondig word)**
- **Graskoppies Roosterkonneksie – (DO Verw. No.: Moet nog aangekondig word)**
- **Xha! Boom Roosterkonneksie – (DO Verw. No.: Moet nog aangekondig word)**
- **Hartebeest Leegte Roosterkonneksie – (DO Verw. No.: Moet nog aangekondig word)**
- **Ithemba Roosterkonneksie – (DO Verw. No.: Moet nog aangekondig word)**

Neem asseblief kennis dat South Africa Mainstream Renewable Power Developments (Edms.) Bpk. vir SiVEST SA (Edms.) Bpk. aangestel het as die Omgewingsevalueringspraktisyn (OEP) vir die bogenoemde projekte. In Oktober 2016 is alle belangstellende en/of geaffekteerde partye (B&GP's) genooi om deel te neem aan die Omgewingsimpakevalueringsprosesse (OIE-prosesse) vir die windplaasontwikkelings en die Basiese Evalueeringsprosesse (BE-prosesse) vir die gepaardgaande roosterkonneksies en 'n Agtergrondinligtingsdokument (AID) is aan hulle gestuur. Sedert hierdie skrywe was daar sekere veranderinge aan die beoogde ontwikkelings wat die volgende insluit:

- Die byvoeging van 'n nuwe kraglynkorridor vir evaluering;
- 'n verandering aan die opwekkingsvermoë van die windplase; en
- 'n verandering aan die maksimum naafhoogte en rotordeursnee.

Die AID is dienooreenkomstig bygewerk op grond van die bogenoemde veranderinge en aangeheg vir u insae.

Let asseblief daarop dat die Konsep Bestekopnameverslae (KBV's) in Junie 2017 beskikbaar sal wees vir openbare kommentaar en u sal dienooreenkomstig verwittig word.

Vriendelike groete

Kind Regards,

Andrea Gibb (*B.Sc. Landscape Architecture; B.Sc.(Hons) Environmental Management*)
Environmental Practitioner and Visual Specialist
SiVEST Environmental Division



SiVEST is a Level 3 BBBEE Contributor

Direct [+27 11 798 0638](tel:+27117980638) **Tel** [+27 11 798 0600](tel:+27117980600) **fax** [+27 11 803 7272](tel:+27118037272)
email

andrea@sivest.co.za

website www.sivest.co.za

Consulting Engineers - Project Managers - Environmental Consultants - Town and Regional Planners
Durban - Johannesburg - Pietermaritzburg - Richards Bay - Ladysmith - Cape Town - Harare (Zimbabwe)

Disclaimer

The information contained in this communication from the sender is confidential. It is intended solely for use by the recipient and others authorized to receive it. If you are not the recipient, you are hereby notified that any disclosure, copying, distribution or taking action in relation of the contents of this information is strictly prohibited and may be unlawful.

This email has been scanned for viruses and malware, and automatically archived by **Mimecast SA (Pty) Ltd**, an innovator in Software as a Service (SaaS) for business. **Mimecast Unified Email Management ??? (UEM)** offers email continuity, security, archiving and compliance with all current legislation. To find out more, [contact Mimecast](#).

--

Andrea Gibb

From: Natasha Higgitt <niggitt@sahra.org.za>
Sent: Monday, 19 June 2017 4:07 PM
To: Andrea Gibb
Cc: Stephan Jacobs; rebecca.thomas@mainstreamrp.com
Subject: Re: Four Proposed Wind Farms near Loeriesfontein: Revised BID

Categories: Leeuwberg

Good afternoon,

Thank you for notifying SAHRA of the proposed developments. Please note that SAHRA does not accept hardcopy, emailed, posted or website links as official submissions. Please create an application on the South African Heritage Resources Information System (SAHRIS) and upload all documents to the application. Once all documents have been uploaded, please change the status of the case from DRAFT to SUBMITTED and inform me, referencing the Case ID number.

Kind Regards,

Natasha Higgitt
Heritage Officer: Archaeology, Palaeontology and Meteorites Unit

South African Heritage Resources Agency
- A nation united through heritage -

T: +27 21 462 4502 | F: +27 21 462 4509 | C: +27 82 507 0378
E: niggitt@sahra.org.za | 111 Harrington Street | Cape Town

www.sahra.org.za

Natasha Higgitt
Heritage Officer: Archaeology, Palaeontology and Meteorites Unit

South African Heritage Resources Agency
- A nation united through heritage -

T: +27 21 462 4502 | C: +27 82 507 0378 | F: +27 21 462 4509
E: niggitt@sahra.org.za | 111 Harrington Street | Cape Town | 8001

www.sahra.org.za



From: "sivest_PPP" <sivest_ppp@sivest.co.za>
Cc: "Andrea Gibb" <AndreaG@sivest.co.za>, "Stephan Jacobs" <StephanJ@sivest.co.za>, "rebecca.thomas@mainstreamrp.com" <rebecca.thomas@mainstreamrp.com>
Sent: Monday, 19 June, 2017 3:54:29 PM
Subject: Four Proposed Wind Farms near Loeriesfontein: Revised BID

******* Please note that this email was sent from a NO REPLY email address. Please do not reply to this address as it is an unmonitored email account.*******

Dear Interested and/or Affected Party

ENVIRONMENTAL IMPACT ASSESSMENTS (EIAs) FOR THE PROPOSED DEVELOPMENT OF FOUR (4) WIND FARMS AND BASIC ASSESSMENTS (BAs) FOR THE ASSOCIATED GRID CONNECTION NEAR LOERIESFONTEIN, NORTHERN CAPE PROVINCE

- **Graskoppies Wind Farm – (DEA Ref No: To be announced)**
- **Xha! Boom Wind Farm – (DEA Ref No: To be announced)**
- **Hartebeest Leegte Wind Farm – (DEA Ref No: To be announced)**
- **Ithemba Wind Farm – (DEA Ref No: To be announced)**
- **Graskoppies Grid Connection – (DEA Ref No: To be announced)**
- **Xha! Boom Grid Connection – (DEA Ref No: To be announced)**
- **Hartebeest Leegte Grid Connection – (DEA Ref No: To be announced)**
- **Ithemba Grid Connection – (DEA Ref No: To be announced)**

Please note that SiVEST SA (Pty) Ltd was appointed by South Africa Mainstream Renewable Power Developments (Pty) Ltd as the Environmental Assessment Practitioner (EAP) for the above mentioned projects. In October 2016, all interested and/or affected parties (I&APs) were invited to participate in the Environmental Impact Assessment (EIA) processes for the wind farm developments and the Basic Assessment (BA) processes for the associated grid connections and were sent a Background Information Document (BID). Since this communication there have been some changes to the proposed developments which include the following;

- The addition of a new power line assessment corridor;
- A change in the generation capacity of the wind farms; and
- A change in the maximum hub height and rotor diameter.

As such, the BID has been updated based on the above changes and is attached for your perusal.

Kindly note that the Draft Scoping Reports (DSRs) will be available for public comment in June 2017 and you will be notified accordingly.

Kind Regards

Geagte Belangstellende en/of Geaffekteerde Party

OMGEWINGSIMPAAKEVALUERINGS (OIE's) VIR DIE BEOOGDE ONTWIKKELING VAN VIER (4) WINDPLASE EN BASIESE EVALUERINGS (BE's) VIR DIE GEPAARDGAANDE ROOSTERKONNEKSIES NABY LOERIESFONTEIN, NOORD-KAAPPROVINSIE

- **Graskoppies Windplaas – (DO Verw. No.: Moet nog aangekondig word)**
- **Xha! Boom Windplaas – (DO Verw. No.: Moet nog aangekondig word)**
- **Hartebeest Leegte Windplaas – (DO Verw. No.: Moet nog aangekondig word)**
- **Ithemba Windplaas – (DO Verw. No.: Moet nog aangekondig word)**
- **Graskoppies Roosterkonneksie – (DO Verw. No.: Moet nog aangekondig word)**
- **Xha! Boom Roosterkonneksie – (DO Verw. No.: Moet nog aangekondig word)**
- **Hartebeest Leegte Roosterkonneksie – (DO Verw. No.: Moet nog aangekondig word)**
- **Ithemba Roosterkonneksie – (DO Verw. No.: Moet nog aangekondig word)**

Neem asseblief kennis dat South Africa Mainstream Renewable Power Developments (Edms.) Bpk. vir SiVEST SA (Edms.) Bpk. aangestel het as die Omgewingsevalueringspraktisyn (OEP) vir die bogenoemde projekte. In Oktober 2016 is alle belangstellende en/of geaffekteerde partye (B&GP's) genooi om deel te neem aan die Omgewingsimpakevalueringsprosesse (OIE-prosesse) vir die windplaasontwikkelings en die Basiese Evalueringsprosesse (BE-prosesse) vir die gepaardgaande roosterkonneksies en 'n Agtergrondinligtingsdokument (AID) is aan hulle gestuur. Sedert hierdie skrywe was daar sekere veranderinge aan die beoogde ontwikkelings wat die volgende insluit:

- Die byvoeging van 'n nuwe kraglynkorridor vir evaluering;
- 'n verandering aan die opwekkingsvermoë van die windplase; en
- 'n verandering aan die maksimum naafhoogte en rotordeursnee.

Die AID is dienooreenkomstig bygewerk op grond van die bogenoemde veranderinge en aangeheg vir u insae.

Let asseblief daarop dat die Konsep Bestekopnameverslae (KBV's) in Junie 2017 beskikbaar sal wees vir openbare kommentaar en u sal dienooreenkomstig verwittig word.

Vriendelike groete

Kind Regards,

Andrea Gibb (*B.Sc. Landscape Architecture; B.Sc.(Hons) Environmental Management*)
Environmental Practitioner and Visual Specialist
SiVEST Environmental Division



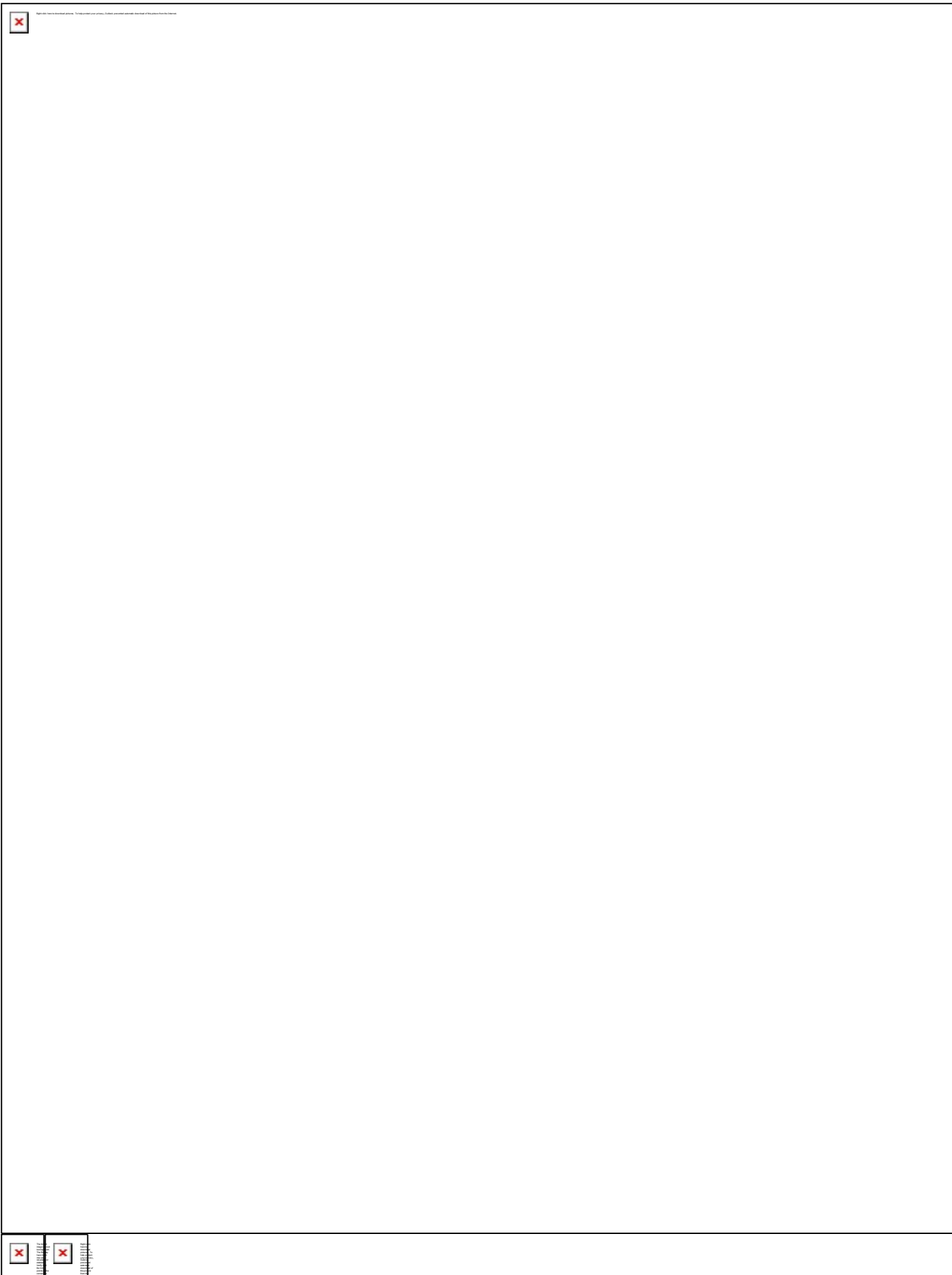

SIVEST is a Level 3 BBBEE Contributor

Direct +27 11 798 0638 **Tel** +27 11 798 0600 **fax** +27 11 803 7272
email andrea@sivest.co.za **website** www.sivest.co.za

Consulting Engineers - Project Managers - Environmental Consultants - Town and Regional Planners
Durban - Johannesburg - Pietermaritzburg - Richards Bay - Ladysmith - Cape Town - Harare (Zimbabwe)

Disclaimer

The information contained in this communication from the sender is confidential. It is intended solely for use by the recipient and others authorized to receive it. If you are not the recipient, you are hereby notified that any disclosure, copying, distribution or taking action in relation of the contents of this information is strictly prohibited and may be unlawful.

This email has been scanned for viruses and malware, and automatically archived by **Mimecast SA (Pty) Ltd**, an innovator in Software as a Service (SaaS) for business. **Mimecast Unified Email Management ??? (UEM)** offers email continuity, security, archiving and compliance with all current legislation. To find out more, [contact Mimecast](#).

This electronic communication and its content(s) are subject to a disclaimer which can be accessed here: <http://mail.sahra.org.za/disclaimer.html>



16 February 2017

Directors of South Africa Mainstream Renewable Power Developments (Pty) Ltd
4th Floor, Mariendahl House
Newlands on Main
Corner Main and Campgrounds Road
Claremont
Cape Town
7708

Attention: Directors of South Africa Mainstream Renewable Power Developments (Pty) Ltd

**PROPOSED ESTABLISHMENT OF THE NEW GRASKOPPIES 140MW WIND ENERGY FACILITY
SITUATED 115 KM WEST OF BRANDVLEI IN THE NORTHERN CAPE PROVINCE**

Directors

Your letter of 10 February 2017 refers.

Vodacom (Pty) Ltd has no objection to South Africa Mainstream Renewable Power Developments (Pty) Ltd establishing the Graskoppies 140MW wind energy facility at the following locations:

- Portion 1 of Farm Hartebeest Leegte no. 216,
- Portion 2 of the Farm Gras Koppies no. 176,

which are all situated 115 km west of Brandvlei in the Northern Cape Province.

Yours sincerely



Hennie Barnard
Property Manager
Vodacom Central Region

Vodacom (Pty) Ltd
082 Vodacom Lane, Off Nobel Street, Brandwag, Bloemfontein, 9301
P.O. Box 100958, Brandhof, 9324

Phone +27 (0)82 271 1400
Fax +27 (0)82 271 1430

vodacom.co.za

This document was created with Win2PDF available at <http://www.win2pdf.com>.
The unregistered version of Win2PDF is for evaluation or non-commercial use only.
This page will not be added after purchasing Win2PDF.



61 Oak Avenue, Highveld,
Techno Park, Centurion 0157,
Private Bag X881, Pretoria, Gauteng, 0001
T: +27 12 311 2012
C: +27 81 428 6729
M: LeonardS@openserve.co.za

2017/02/20

South Africa Mainstream Renewable Power Developments (Pty) Ltd
PO Box 45063
Claremont
7735

RE: APPLICATION FOR APPROVAL OF GRASKOPPIES WIND FARM FACILITY

Dear Raymond Takuba

The above matter refers.

Kindly take note that Telkom SA SOC Ltd ("Telkom") has received an application from South Africa Mainstream Renewable Power Developments (Pty) Ltd, hereafter referred to as THE APPLICANT, who wishes to construct a WIND FARM named GRASKOPPIES with boundaries defined in annexure 1, hereafter referred to as THE SITE, in accordance with the provisions of Section 29(1) (b) of Electronic Communications Act no. 36 of 2005 ("the Act").

Telkom has analysed the information provided by the Applicant in accordance with the provisions of Section 29(1)(c) of the Act, and specifically the location of the site. Telkom SA hereby grants the Applicant the approval to proceed with the construction of its energy project at the site subject to the following terms and conditions:

- Take note that the findings made by Telkom are based on simulation and calculated on a theoretical model, using available data and assumptions where no data was provided. Therefore, such findings may change at any time should any further information be made available to or come to Telkom's attention.
- At any time after the approval, and during construction of the project, should any radio transmissions be affected by construction activities, Telkom will give the Applicant 30 (thirty) days' written notice to minimise or reduce and/or remove the cause of the interference. Under no circumstances will Telkom be liable to the Applicant or any other third party for any damages, of any nature whatsoever, suffered as a consequence of the aforementioned request.

- Construction activities underneath, along, across or within close proximity to Telkom infrastructure must comply to the applicable Telkom guidelines relating to clearances between equipment and the proposed construction activity. Furthermore, the Applicant must strictly adhere to and all installations must be fully compliant with the Occupational Health and Safety Act, 1993 (Act 85 of 1993).
- This approval is further subject to the submitted application's boundaries or structures listed in annexure 1 below, the materials used as well as the size and positioning of structures declared in the application. If any radio system is compromised by a deviation of this submission and the deviation cannot be reversed, the Applicant shall be liable for the cost to re-establish or relocate the service and under no circumstances will Telkom be liable to the Applicant or any other third party for any damages, of any nature whatsoever, suffered as a consequence.
- This approval is valid and applicable to and between Telkom and the Applicant. It does not include approval by other electronic communication operators that have a co-sharing agreement for use on Telkom radio masts.
- Any additions, amendments, additional structures to be built or change to the energy farm boundaries will require a fresh application to Telkom.
- The validity of this approval is for a period of 12 (twelve) months. If construction of the designed project commences after the expiry of the twelve month period, the application must be re-submitted to Telkom for evaluation and approval.
- This approval does not imply any right of access to Telkom property or use of Telkom's access roads for construction or maintenance of the design project. Permission must be obtained from Telkom in this regard. Furthermore Telkom reserves the right to claim damages in terms of Section 108 of the Post Office Act No. 44 of 1958, for any loss sustained as a result of damage to our electronic communications infrastructure.
- the Applicant shall, in the carrying out of any work or project take all necessary precautions for the safety of Telkom's employees, contractors, representatives and its property including the radio links on or near the Site against damages as result of construction of the Applicant's energy project. the Applicant shall be liable for all and any direct and / or indirect, and / or consequential damages or injury that may be caused by the Applicant, its contractors, subcontractors, employees or representatives to any employee, contractor, representative or property of Telkom including radio links or land which may have been disturbed.
- Any work in connection with the construction of the Applicant's energy project shall be carried out by the Applicant, in such a way as to avoid any possible loss or inconvenience to the Telkom, its customers or the public, and on completion of such work, any property of Telkom, including radio links or land which may have been disturbed shall be restored to the same condition which it was in before commencement of the construction of energy project.
- In no event will Telkom, its employees, contractors, subcontractors or representatives be liable to the Applicant or anyone else for special, collateral, exemplary, direct, indirect, incidental, consequential or any other damages (including without limitation, loss of goodwill, loss of profits or revenues, loss of savings, loss of use, interruptions of business, and claims of the Applicant or injury) whether or not such damages or injury occurred prior or subsequent to, or are alleged as a result of any Telkom radio links approved and/or not approved in terms of this letter or as result of delict, even if Telkom SA has been advised of the possibility of such damages or injury.

We trust you find the above in order.

A handwritten signature in black ink, consisting of a stylized initial 'L' followed by a long horizontal stroke.

Regards,
Leonard Shaw Pr. Tech (Eng.)
Senior Manager
Access Master Plans

Annexure 1

Only the points submitted in the application that outlines the outer boundary for the farm were used to see if any radio link crossed over or nearby the energy farm. Telkom has no radio system that will be affected by turbines built in the proposed project area.

The points listed below are recorded in decimal degree on the WGS84 datum. If any dispute arises with respect to the position of these points then the Chief Directorate National Geo-spatial Information trigonometrical system will be used to verify them. The points below form an enclosed area if read in sequence, with the first and last points in the list enclosing the approved area.

Point	Longitude X	Latitude Y
1	19.298160	-30.254118
2	19.277670	-30.326084
3	19.290713	-30.326746
4	19.342621	-30.348900
5	19.368391	-30.296308
6	19.379579	-30.240162
7	19.409124	-30.229288
8	19.401894	-30.217844
9	19.370962	-30.215015
10	19.286149	-30.233860
1	19.298160	-30.254118

List end

Andrea Gibb

From: Natasha Higgitt <niggitt@sahra.org.za>
Sent: Thursday, 22 June 2017 8:55 AM
To: Andrea Gibb
Cc: Stephan Jacobs; rebecca.thomas@mainstreamrp.com
Subject: Re: Four Proposed Mainstream Wind Farms near Loeriesfontein: DSR Comment Period Starting

Good morning,

Thank you for notifying SAHRA of the proposed developments. Please note that SAHRA does not accept hardcopy, emailed, posted or website links as official submissions. Please create an application on the South African Heritage Resources Information System (SAHRIS) and upload all documents to the application. Once all documents have been uploaded, please change the status of the case from DRAFT to SUBMITTED and inform me, referencing the Case ID number.

Kind Regards,

Natasha Higgitt
Heritage Officer: Archaeology, Palaeontology and Meteorites Unit

South African Heritage Resources Agency
- A nation united through heritage -

T: +27 21 462 4502 | F: +27 21 462 4509 | C: +27 82 507 0378
E: niggitt@sahra.org.za | 111 Harrington Street | Cape Town

www.sahra.org.za

Natasha Higgitt
Heritage Officer: Archaeology, Palaeontology and Meteorites Unit

South African Heritage Resources Agency
- A nation united through heritage -

T: +27 21 462 4502 | C: +27 82 507 0378 | F: +27 21 462 4509
E: niggitt@sahra.org.za | 111 Harrington Street | Cape Town | 8001

www.sahra.org.za



From: "sivest_PPP" <sivest_ppp@sivest.co.za>
Cc: "Andrea Gibb" <AndreaG@sivest.co.za>, "Stephan Jacobs" <StephanJ@sivest.co.za>, "rebecca.thomas@mainstreamrp.com" <rebecca.thomas@mainstreamrp.com>
Sent: Wednesday, 21 June, 2017 4:27:39 PM
Subject: Four Proposed Mainstream Wind Farms near Loeriesfontein: DSR Comment Period Starting

******* Please note that this email was sent from a NO REPLY email address. Please do not reply to this address as it is an unmonitored email account.*******

Dear Interested and/or Affected Party

ENVIRONMENTAL IMPACT ASSESSMENTS (EIAs) FOR THE PROPOSED DEVELOPMENT OF FOUR (4) WIND FARMS NEAR LOERIESFONTEIN, NORTHERN CAPE PROVINCE

- Graskoppies Wind Farm – (DEA Ref No: To be announced)
- Xha! Boom Wind Farm – (DEA Ref No: To be announced)
- Hartebeest Leegte Wind Farm – (DEA Ref No: To be announced)
- Ithemba Wind Farm – (DEA Ref No: To be announced)

SiVEST SA (Pty) Ltd was previously appointed by South Africa Mainstream Renewable Power Developments (Pty) Ltd as the Environmental Assessment Practitioner (EAP) for the above mentioned projects.

We would like to take this opportunity to inform you that, in accordance with the National Environmental Management Act (NEMA) (as amended), the Draft Scoping Reports (DSRs) for the above mentioned wind farm projects will be available for public comment and review as from **Wednesday 21 June 2017 to Friday 21 July 2017** (end of business day). Should you wish to receive an electronic copy of the DSRs (on CD) please forward your request in writing to us. Hard copies of the DSRs can be reviewed at the following public place:

VENUE	STREET ADDRESS	HOURS	CONTACT NO
Loeriesfontein Library	Main Street, Loeriesfontein	Mondays- Fridays 14h00 – 17h00	027 662 8607

The report is also available on SiVEST’s website: <http://www.sivest.co.za/>, click on ‘Downloads’ then browse to the folder ‘13622 Mainstream Wind Farms’.

Attached is an English and Afrikaans letter notifying of the review period.

Kind Regards,

Andrea Gibb (B.Sc. Landscape Architecture; B.Sc.(Hons) Environmental Management)
Environmental Practitioner and Visual Specialist
SiVEST Environmental Division

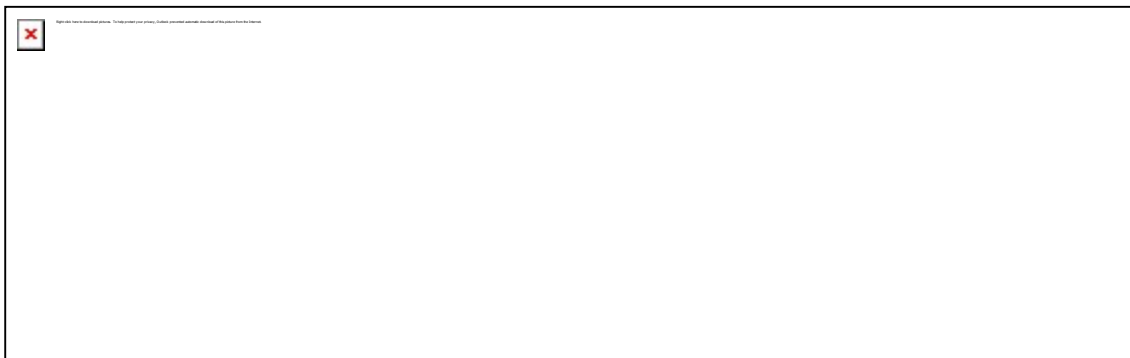

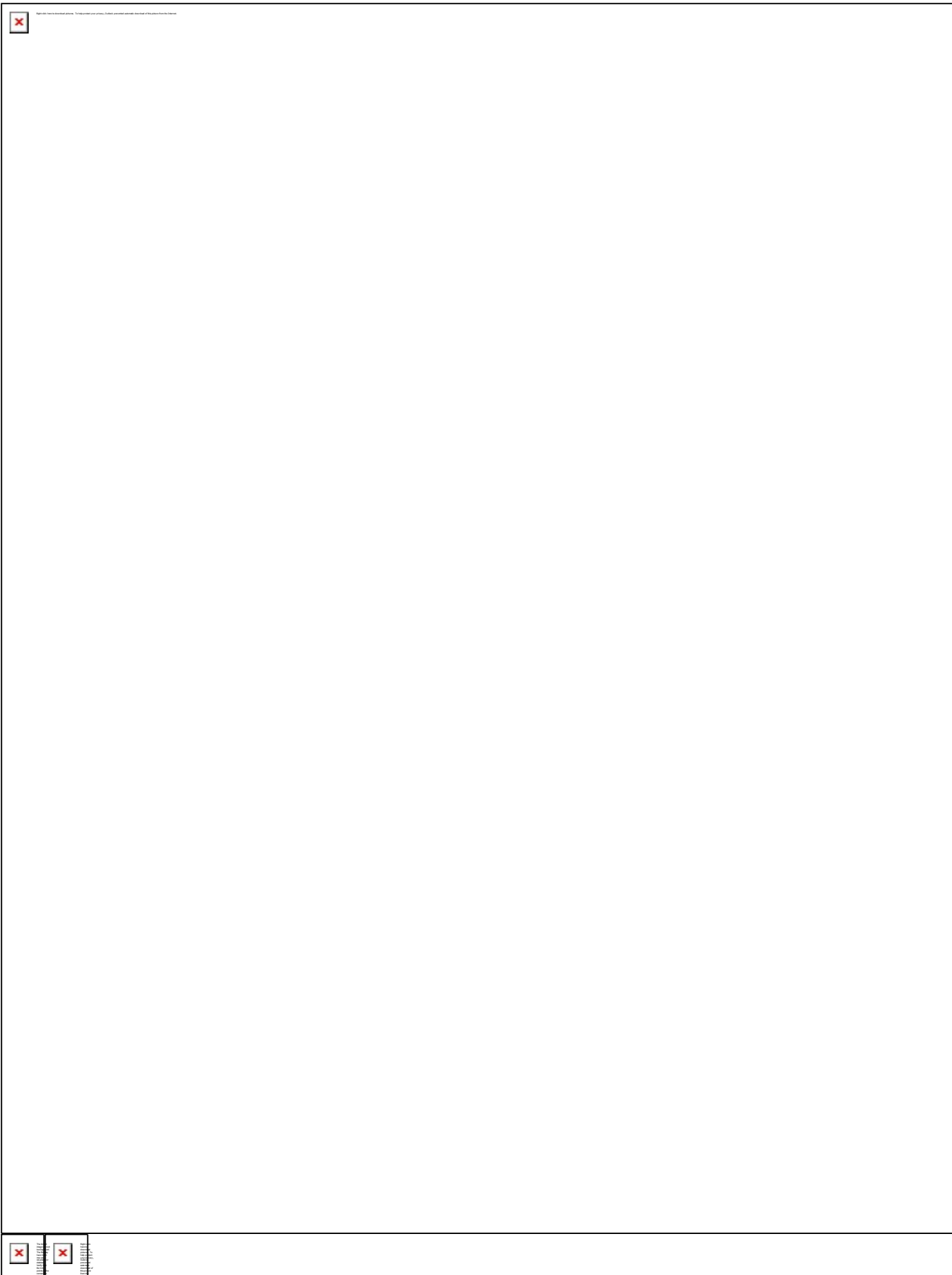

SIVEST is a Level 3 BBBEE Contributor

Direct +27 11 798 0638 **Tel** +27 11 798 0600 **fax** +27 11 803 7272
email andreaq@sivest.co.za **website** www.sivest.co.za

Consulting Engineers - Project Managers - Environmental Consultants - Town and Regional Planners
Durban - Johannesburg - Pietermaritzburg - Richards Bay - Ladysmith - Cape Town - Harare (Zimbabwe)

Disclaimer

The information contained in this communication from the sender is confidential. It is intended solely for use by the recipient and others authorized to receive it. If you are not the recipient, you are hereby notified that any disclosure, copying, distribution or taking action in relation of the contents of this information is strictly prohibited and may be unlawful.

This email has been scanned for viruses and malware, and automatically archived by **Mimecast SA (Pty) Ltd**, an innovator in Software as a Service (SaaS) for business. **Mimecast Unified Email Management ??? (UEM)** offers email continuity, security, archiving and compliance with all current legislation. To find out more, [contact Mimecast](#).

This electronic communication and its content(s) are subject to a disclaimer which can be accessed here: <http://mail.sahra.org.za/disclaimer.html>



Andrea Gibb

From: Naude, Ono, Vodacom South Africa <ono.naude@vodacom.co.za>
Sent: Wednesday, 15 February 2017 6:16 PM
To: Andrea Gibb
Cc: Stephan Jacobs
Subject: RE: Turbine coordinates for site near Loeriesfontein Leeuberg ,

Categories: Leeuwberg

Hi Andrea , thanks . These turbines are not close to any of my sites so we should not have any issues .
Regards
Ono

From: Andrea Gibb [mailto:AndreaG@sivest.co.za]
Sent: 13 February 2017 12:58 PM
To: Naude, Ono, Vodacom South Africa
Cc: Stephan Jacobs
Subject: RE: Turbine coordinates for site near Loeriesfontein Leeuberg ,

Hi Ono

Thank you for your email. Attached are the turbine locations that will be assessed in the EIA phase of the project.

Kind Regards

Andrea Gibb (B.Sc. Landscape Architecture; B.Sc.(Hons) Environmental Management)

Environmental Practitioner and Visual Specialist

SiVEST Environmental Division



SiVEST is a Level 3 BBBEE Contributor

Direct +27 11 798 0638 **Tel** +27 11 798 0600 **fax** +27 11 803 7272 **cell** +27 72 587 6525
email andreag@sivest.co.za **website** www.sivest.co.za

Consulting Engineers - Project Managers - Environmental Consultants - Town and Regional Planners
Durban - Johannesburg - Pietermaritzburg - Richards Bay - Ladysmith - Cape Town - Harare (Zimbabwe)

From: Naude, Ono, Vodacom South Africa [mailto:ono.naude@vodacom.co.za]
Sent: Friday, 10 February 2017 12:33 PM
To: Andrea Gibb <AndreaG@sivest.co.za>
Subject: Turbine coordinates for site near Loeriesfontein Leeuberg ,

Hi Andrea, I am from Vodacom and would like to know if you can forward me the turbine coordinates for these site so I can check if there are any risks to our communication systems in the area . I believe there should be no issue , but I need to check.

Thank you

Ono Naude

This e-mail is classified C2 - Vodacom Restricted - Information to be used inside Vodacom but it may be shared with authorised partners.

“This e-mail is sent on the Terms and Conditions that can be accessed by Clicking on this link <https://webmail.vodacom.co.za/tc/default.html> ”

Disclaimer

The information contained in this communication from the sender is confidential. It is intended solely for use by the recipient and others authorized to receive it. If you are not the recipient, you are hereby notified that any disclosure, copying, distribution or taking action in relation of the contents of this information is strictly prohibited and may be unlawful.

This email has been scanned for viruses and malware, and automatically archived by **Mimecast SA (Pty) Ltd**, an innovator in Software as a Service (SaaS) for business. **Mimecast Unified Email Management ??? (UEM)** offers email continuity, security, archiving and compliance with all current legislation. To find out more, [contact Mimecast](#).

◆ This e-mail is sent on the Terms and Conditions that can be accessed by Clicking on this link <https://webmail.vodacom.co.za/tc/default.html> ”

Andrea Gibb

From: Naude, Ono, Vodacom South Africa <ono.naude@vodacom.co.za>
Sent: Friday, 10 February 2017 12:33 PM
To: Andrea Gibb
Subject: Turbine coordinates for site near Loeriesfontein Leeuberg ,

Categories: Leeuwborg

Hi Andrea, I am form Vodacom and would like to know if you can forward me the turbine coordinates for these site so I can check is there are any risks to our communication systems in the area . I believe there should be no issue , but I need to check.

Thank you

Ono Naude

This e-mail is classified C2 - Vodacom Restricted - Information to be used inside Vodacom but it may be shared with authorised partners.

“This e-mail is sent on the Terms and Conditions that can be accessed by Clicking on this link <https://webmail.vodacom.co.za/tc/default.html> ”

Andrea Gibb

From: Natasha Higgitt <niggitt@sahra.org.za>
Sent: Friday, 10 February 2017 8:16 AM
To: Andrea Gibb
Cc: Nicolene Venter; Veronique Evans; Stephan Jacobs
Subject: Re: Four Proposed Wind Farms near Loeriesfontein: EIA Commencing

Good morning,

Thank you for notifying SAHRA of the proposed development. Please note that SAHRA does not accept hardcopy, posted, emailed or website links as official submissions. Please create an application on the South African Heritage Information System (SAHRIS) and follow the step by step instructions on the SAHRIS homepage (<http://sahra.org.za/sahris/>). Please upload all documents to the case and once this is completed, change the status of the case to SUBMITTED. Please inform me when this is done and reference the Case ID number in the email.

Kind Regards,

Natasha Higgitt
Heritage Officer: Archaeology, Palaeontology and Meteorites Unit

South African Heritage Resources Agency
- A nation united through heritage -

T: +27 21 462 4502 | F: +27 21 462 4509
E: niggitt@sahra.org.za | 111 Harrington Street | Cape Town

www.sahra.org.za

Natasha Higgitt
Heritage Officer: Archaeology, Palaeontology and Meteorites Unit

South African Heritage Resources Agency
- A nation united through heritage -

T: +27 21 462 4502 | C: +27 82 507 0378 | F: +27 21 462 4509
E: niggitt@sahra.org.za | 111 Harrington Street | Cape Town | 8001

www.sahra.org.za



From: "sivest_PPP" <sivest_ppp@sivest.co.za>
Cc: "Andrea Gibb" <AndreaG@sivest.co.za>, "Nicolene Venter" <nicolene@imaginativeafrica.co.za>, "Veronique Evans" <VeroniqueE@sivest.co.za>, "Stephan Jacobs" <StephanJ@sivest.co.za>
Sent: Thursday, 9 February, 2017 3:51:21 PM
Subject: Four Proposed Wind Farms near Loeriesfontein: EIA Commencing

***** Please note that this email was sent from a NO REPLY email address. Please do not reply to this address as it is an unmonitored email account. *****

Dear Stakeholder

ENVIRONMENTAL IMPACT ASSESSMENTS (EIAs) FOR THE PROPOSED DEVELOPMENT

OF FOUR (4) WIND FARMS AND BASIC ASSESSMENTS (BAs) FOR THE ASSOCIATED GRID CONNECTION NEAR LOERIESFONTEIN, NORTHERN CAPE PROVINCE (DEA REFERENCE NUMBERS TO BE ANNOUNCED)

Please note that SiVEST SA (Pty) Ltd has been appointed as the independent Environmental Assessment Practitioner (EAP) by South Africa Mainstream Renewable Power Developments (Pty) Ltd to conduct the EIA processes for the proposed development of four (4) Wind Farms and the BA processes for the four (4) associated grid connections. The proposed projects are located in the Northern Cape Province near Loeriesfontein and are referred to as: Graskoppies Wind Farm, Xha! Boom Wind farm, Hartebeest Leegte Wind Farm, Ithemba Wind Farm, Graskoppies Grid Connection, Xha! Boom Grid Connection, Hartebeest Leegte Grid Connection and Ithemba Grid Connection.

Attached, for your attention are; the Background Information Document (BID), Invitation Letter and Registration and Comment Form for the proposed project. The documents are provided in English and Afrikaans for your convenience.

Kind Regards,

Andrea Gibb (B.Sc. Landscape Architecture; B.Sc.(Hons) Environmental Management)
Environmental Practitioner and Visual Specialist
SiVEST Environmental Division

SiVEST is a Level 3 BBBEE Contributor

Direct +27 11 798 0638 Tel +27 11 798 0600 fax +27 11 803 7272
email andreag@sivest.co.za website www.sivest.co.za

Consulting Engineers - Project Managers - Environmental Consultants - Town and Regional Planners
Durban - Johannesburg - Pietermaritzburg - Richards Bay - Ladysmith - Cape Town - Harare (Zimbabwe)

Disclaimer

The information contained in this communication from the sender is confidential. It is intended solely for use by the recipient and others authorized to receive it. If you are not the recipient, you are hereby notified that any disclosure, copying, distribution or taking action in relation of the contents of this information is strictly prohibited and may be unlawful.

This email has been scanned for viruses and malware, and automatically archived by **Mimecast SA (Pty) Ltd**, an innovator in Software as a Service (SaaS) for business. **Mimecast Unified Email Management ??? (UEM)** offers email continuity, security, archiving and compliance with all current legislation. To find out more, [contact Mimecast](#).

This electronic communication and its content(s) are subject to a disclaimer which can be accessed here: <http://mail.sahra.org.za/disclaimer.html>





Square Kilometre Array (SKA) SA

www.ska.ac.za



Mercia Grimbeek
Development Manager
South Africa Mainstream Renewable Power Developments (Pty) Ltd
PO Box 45063
Claremont
7735

E-mail: Mercia.Grimbeek@mainstreamrp.com

Date: 18 November 2016

Dear Mercia,

RE: DEVELOPMENT OF FOUR 140MW WIND ENERGY FACILITIES (GRASKOPPIES, HARTEBEEST LEEGTE, XHA! BOOM & ITEMBA) LOCATED IN THE NORTHERN CAPE PROVINCE.

This letter is in response to your email request, to provide an assessment on the potential development of four wind electricity generation facilities in the Northern Cape Province and the risk they may pose on the Square Kilometre Array Project.

A high level risk assessment has been conducted at the South African SKA Project Office to determine the potential impact of such facilities on the Square Kilometre Array. This letter serves to confirm the outcomes of the risk assessment and proposals for any future investigations associated with this facility.

- I. The location of the wind facilities was provided in the form of a Google Earth shapefiles.
- II. The nearest SKA stations has been identified as Rem-Opt-7, it is located approximately 50 km from the proposed location of wind facilities;
- III. Based on distance to the nearest SKA station, and the information currently available on the detailed design of the wind farms, a single facility electricity generation facility would pose a low to medium risk of detrimental impact on the SKA. However, multiple facilities, as is the case for this application, as well as taking into account the number of facilities already located, or to be constructed, in the area would result in an increase in the risk (to at least a medium to high risk) of detrimental impact on the SKA as a result of the integrated impact;

www.ska.ac.za

📍 3rd Floor, The Park, Park Road,
Pinelands 7405, South Africa
☎ +27 (0)21 506 7300
📠 +27 (0)21 506 7375

📍 17 Baker Street, Rosebank
Johannesburg, South Africa
☎ +27 (0)11 442 2434
📠 +27 (0)11 442 2454

📍 Karoo Support Base
📍 P.O. Box 69
Carnarvon, 8925
☎ +27 (0) 21 506 7300



Square Kilometre Array (SKA) SA

www.ska.ac.za



- IV. Any transmitters that are to be established, or have been established, at the site for the purposes of voice and data communication will be required to comply with the relevant AGA regulations concerning the restriction of use of the radio frequency spectrum that applies in the area concerned;
- V. As a result of the **medium to high risk** associated with the wind facilities, the SKA project office recommends that further EMI and RFI detailed studies be conducted as significant mitigation measures may be required to lower the risk of detrimental impact to an acceptable level. The South African SKA Project Office would like to be kept informed of progress with this project, and reserves the right to further risk assessments at a later stage.

This technical advice is provided by the South African SKA Project Office on the basis of the protection requirements of the SKA in South Africa, and does not constitute legal approval of the renewable energy projects in terms of the Astronomy Geographic Advantage Act, the Management Authority, and its regulations or declarations.

Regards,

Dr. Adrian Tiplady
Head: Strategy & Business Systems
SKA South Africa
Tel: 011 442 2434
Fax: 011 442 2454
atiplady@ska.ac.za

www.ska.ac.za

📍 3rd Floor, The Park, Park Road,
Pinelands 7405, South Africa
☎ +27 (0)21 506 7300
📠 +27 (0)21 506 7375

📍 17 Baker Street, Rosebank
Johannesburg, South Africa
☎ +27 (0)11 442 2434
📠 +27 (0)11 442 2454

📍 Karoo Support Base
📠 P.O. Box 69
Carnarvon, 8925
☎ +27 (0) 21 506 7300

	<p style="text-align: center;">SCOT</p>	<p style="text-align: center;">Technology</p>
---	--	--

Title: **Renewable Energy Generation Plant Setbacks to Eskom Infrastructure** Unique Identifier: **240-65559775**

Alternative Reference Number: **N/A**

Area of Applicability: **Power Line Engineering**

Documentation Type: **Guideline**

Revision: **0**

Total Pages: **8**

Next Review Date: **N/A**

Disclosure Classification: **CONTROLLED DISCLOSURE**

Compiled by



J W Chetty
Mechanical Engineer

Date: 20/02/2014

Approved by



V Naidoo
Chief Engineer (Lines)

Date: 24/02/2014

Authorised by

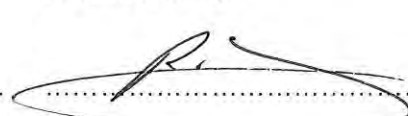

R A Vajeth
Acting Snr Manager (Lines)

Date: 27/2/2014

Supported by SCOT/SC



R Vajeth
SCOT/SC/ Chairperson

Date: 27/2/2014

PCM Reference: 240-65132732 **LINE ENGINEERING SERVICES**

SCOT Study Committee Number/Name : **OVERHEAD LINES**

CONTENTS

	Page
EXECUTIVE SUMMARY	3
1. INTRODUCTION.....	4
2. SUPPORTING CLAUSES	4
2.1 SCOPE	4
2.1.1 Purpose.....	4
2.1.2 Applicability	5
2.2 NORMATIVE/INFORMATIVE REFERENCES	5
2.2.1 Normative.....	5
2.2.2 Informative	5
2.3 DEFINITIONS	5
2.3.1 Disclosure Classification.....	6
2.4 ABBREVIATIONS	6
2.5 ROLES AND RESPONSIBILITIES	6
2.6 PROCESS FOR MONITORING	6
2.7 RELATED/SUPPORTING DOCUMENTS	6
3. DOCUMENT CONTENT	6
3.1 INTERNATIONAL SETBACK COMPARISON	6
3.2 ESKOM APPROACH FOR WIND FARMS.....	7
4. AUTHORISATION	8
5. REVISIONS.....	8
6. DEVELOPMENT TEAM	9

FIGURES

Figure 1: Horizontal Axis Wind Turbine	8
--	---

CONTROLLED DISCLOSURE

When downloaded from the EDMS, this document is uncontrolled and the responsibility rests with the user to ensure it is in line with the authorised version on the system.

EXECUTIVE SUMMARY

In recent decades, the use of wind turbines, concentrated solar plants and photovoltaic plants have been on the increase as it serves as an abundant source of energy. This document specifies setbacks for wind turbines and the reasons for these setbacks from infrastructure as well as setbacks for concentrated solar plants and photovoltaic plants. Setbacks for wind turbines employed in other countries were compared and a general setback to be used by Eskom was suggested for use with wind turbines and other renewable energy generation plants.

CONTROLLED DISCLOSURE

When downloaded from the EDMS, this document is uncontrolled and the responsibility rests with the user to ensure it is in line with the authorised version on the system.

1. INTRODUCTION

During the last few decades, a large amount of wind turbines have been installed in wind farms to accommodate for the large demand of energy and depleting fossil fuels. Wind is one of the most abundant sources of renewable energy. Wind turbines harness the energy of this renewable resource for integration in electricity networks. The extraction of wind energy is its primary function and thus the aerodynamics of the wind turbine is important. There are many different types of wind turbines which will all exhibit different wind flow characteristics. The most common wind turbine used commercially is the Horizontal Axis Wind Turbine. Wind flow characteristics of this turbine are important to analyse as it may have an effect on surrounding infrastructure.

Wind turbines also cause large turbulence downwind that may affect existing infrastructure. Debris or parts of the turbine blade, in the case of a failure, may be tossed behind the turbine and may lead to damage of infrastructure in the wake path.

This document outlines the minimum distances that need to be introduced between a wind turbine and Eskom infrastructure to ensure that debris and / or turbulence would not negatively impact on the infrastructure.

Safety distances of wind turbines from other structures as implemented by other countries were also considered and the reasons for their selection were noted.

Concentrated solar plants and photovoltaic plants setbacks away from substations were also to be considered to prevent restricting possible power line access routes to the substation.

2. SUPPORTING CLAUSES

2.1 SCOPE

This document provides guidance on the safe distance that a wind turbine should be located from any Eskom power line or substation. The document specifies setback distances for transmission lines (220 kV to 765 kV), distribution lines (6.6 kV to 132 kV) and all Eskom substations. Setbacks for concentrated solar plants and photovoltaic plants are also specified away from substations.

2.1.1 Purpose

Setbacks for wind turbines and power lines / substations are required for various reasons. These include possible catastrophic failure of the turbine blade that may release fragments and which may be thrown onto nearby power lines that may result in damage with associated unplanned outages. Turbulence behind the turbine may affect helicopter flight during routine Eskom live line maintenance and

CONTROLLED DISCLOSURE

When downloaded from the EDMS, this document is uncontrolled and the responsibility rests with the user to ensure it is in line with the authorised version on the system.

inspections that may lead to safety risk of the aircraft / personnel. Concentrated solar plants and photovoltaic plants setback away from substations were required to prevent substations from being boxed in by these renewable generation plants limiting line route access to the substations.

2.1.2 Applicability

This document is applicable to the siting of all new and existing wind turbines, concentrated solar plants and photovoltaic plants near power lines and substations.

2.2 NORMATIVE/INFORMATIVE REFERENCES

2.2.1 Normative

1. <http://www.envir.ee/orb.aw/class=file/action=preview/id=1170403/Hiiumaa+turbulence+impact+EMD.pdf>.
2. <http://www.energy.ca.gov/2005publications/CEC-500-2005-184/CEC-500-2005-184.PDF>
3. <http://www.adamscountywind.com/Revised%20Site/Windmills/Adams%20County%20Ordinance/Adams%20County%20Wind%20Ord.htm>
4. http://www.dsireusa.org/incentives/incentive.cfm?Incentive_Code=PA11R&RE=1&EE=1
5. <http://www.wind-watch.org/documents/european-setbacks-minimum-distance-between-wind-turbines-and-habitations/>
6. <http://www.publications.parliament.uk/pa/ld201011/ldbills/017/11017.1-i.html>
7. http://www.caw.ca/assets/pdf/Turbine_Safety_Report.pdf
8. Rogers J, Slegers N, Costello M. (2011) A method for defining wind turbine setback standards. Wind energy 10.1002/we.468

2.2.2 Informative

None

2.3 DEFINITIONS

Definition	Description
Setback	The minimum distance between a wind turbine and boundary line/dwelling/road/infrastructure/servitude etc.
Flicker	Effect caused when rotating wind turbine blades periodically cast shadows
Tip Height	The total height of the wind turbine ie. Hub height plus half rotor diameter (see Figure1)

CONTROLLED DISCLOSURE

When downloaded from the EDMS, this document is uncontrolled and the responsibility rests with the user to ensure it is in line with the authorised version on the system.

2.3.1 Disclosure Classification

Controlled disclosure: controlled disclosure to external parties (either enforced by law, or discretionary).

2.4 ABBREVIATIONS

Abbreviation	Description
None	

2.5 ROLES AND RESPONSIBILITIES

All personnel involved in the positioning wind turbines, concentrated solar plants and photovoltaic plants near power lines/substations must follow the setbacks outlined in this guideline.

2.6 PROCESS FOR MONITORING

Approval by Eskom in writing.

2.7 RELATED/SUPPORTING DOCUMENTS

None

3. DOCUMENT CONTENT

3.1 INTERNATIONAL SETBACK COMPARISON

Wind Turbine setbacks employed by various countries were considered. It was found that setbacks were determined for various reasons that include noise, flicker, turbine blade failure and wind effects. The distances (setbacks) varied based on these factors and were influenced by the type of infrastructure

Wind turbine setbacks varied for roads, power lines, dwellings, buildings and property and it was noted that the largest setbacks were employed for reasons of noise and flicker related issues [1-7]. Very few countries specified setbacks for power lines.

The literature survey [1-7], yielded information about studies and experiments were conducted to determine the distance that a broken fragment from a wind turbine might be thrown. Even though of low probability of hitting a power line [5.0×10^{-5}]^[8], the distances recorded were significant [750m]^[8]

Setbacks were thus introduced to prevent any damage to Eskom infrastructure.

CONTROLLED DISCLOSURE

When downloaded from the EDMS, this document is uncontrolled and the responsibility rests with the user to ensure it is in line with the authorised version on the system.

Wind turbines may also cause changes in wind patterns with turbulent effects behind the hub. These factors dictate the wind turbine setbacks specified in this document.

Concentrated solar plants and photovoltaic plants also can limit access into the substation for power lines of all voltages. A setback distance must therefore be employed to prevent the substation from being boxed in by these generation plants. These setback distances are specified in this document.

3.2 ESKOM REQUIRED SETBACKS

- Eskom requires a setback distance of 3 times the tip height of the wind turbine from the edge of the closest Eskom servitude (including vacant servitudes) for transmission lines.
- Eskom requires a setback distance of 1 times the tip height of the wind turbine from the edge of the closest Eskom servitude (including vacant servitudes) for distribution Lines.
- Eskom must be informed of any proposed wind turbine, concentrated solar plants and photovoltaic activity within a 5 km radius of a substation. No wind turbine structure shall be built within a 2 km radius of the closest point of the substation. Where concentrated solar plants and photovoltaic structures fall within a 2 km radius of the closest point of a substation, Eskom should be informed in writing during the planning phase of the construction of such plant or structure.
- Applicants must show that Eskom radio telecommunication systems (mainly microwave systems) will not be affected in any way by wind turbines.

CONTROLLED DISCLOSURE

When downloaded from the EDMS, this document is uncontrolled and the responsibility rests with the user to ensure it is in line with the authorised version on the system.

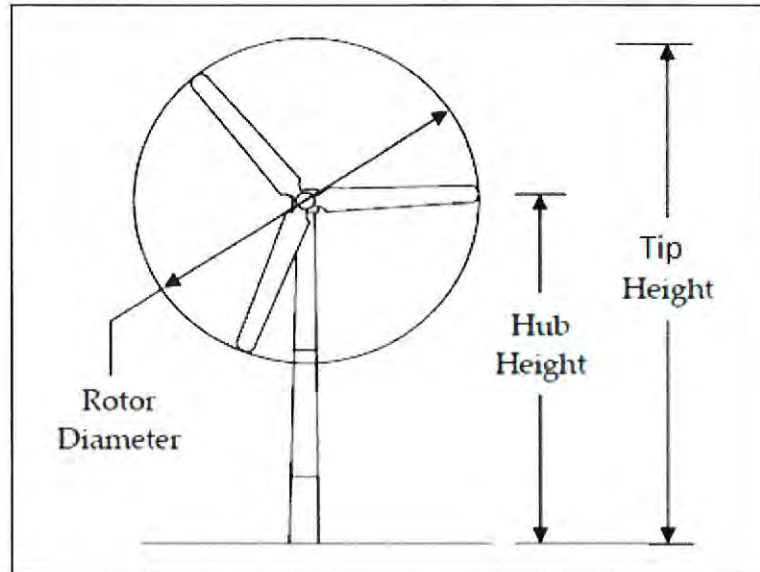

Figure 1: Horizontal Axis Wind Turbine ^[2]

4. AUTHORISATION

This document has been seen and accepted by:

Name & Surname	Designation
V Naidoo	Chief Engineer
Dr P H Pretorius	Electrical Specialist
J Geeringh	Snr Consultant Environ Mngt
B Haridass	Snr Consultant Engineer
R A Vajeth	Acting Snr Manager (Lines)

5. REVISIONS

Date	Rev.	Compiler	Remarks
November 2013	0	J W Chetty	First Publication - No renewable energy generation plant setback specification in existence

CONTROLLED DISCLOSURE

When downloaded from the EDMS, this document is uncontrolled and the responsibility rests with the user to ensure it is in line with the authorised version on the system.

6. DEVELOPMENT TEAM

The following people were involved in the development of this document:

Jonathan W Chetty (Mechanical Engineer)

Vivendhra Naidoo (Chief Engineer)

Dr Pieter H Pretorius (Electrical Specialist)

John Geeringh (Snr Consultant Environ Mngt)

Bharat Haridass (Snr Consultant Engineer)

Riaz A Vajeth (Acting Snr Manager (Lines))

CONTROLLED DISCLOSURE

When downloaded from the EDMS, this document is uncontrolled and the responsibility rests with the user to ensure it is in line with the authorised version on the system.

ENVIRONMENTAL IMPACT ASSESSMENT (EIA) AND ENVIRONMENTAL MANAGEMENT PROGRAMME (EMPr)

COMMENTS AND RESPONSES REPORT – DRAFT ENVIRONMENTAL IMPACT ASSESSMENT REPORT

PROPOSED CONSTRUCTION OF THE GRASKOPPIES WIND FARM NEAR LOERIESFONTEIN, NORTHERN CAPE PROVINCE

SUMMARY OF ENVIRONMENTAL ISSUES/CONCERNS AND SUGGESTIONS RAISED BY INTERESTED AND/OR AFFECTED PARTIES (I&APS)

August 2017 – October 2017

Stakeholders who contributed issues ranging across all sectors of society are recorded in this Comments and Responses Report (C&RR). Full record of every issue raised is available from the public participation office and is also included in **Appendix 7E** of the Draft Environmental Impact Assessment Report (DEIAR). Similar issues raised have been grouped together. The name, affiliation and date of the commentator are also indicated. Technical comments made by the project team are not included in the C&RR.

INDEX TO ISSUES IN THIS TABLE

1 STAKEHOLDER / I&AP RELATED COMMENTS/ ISSUES 3

ABBREVIATIONS

BA	Basic Assessment
DEIAR	Draft Environmental Impact Assessment Report
DSR	Draft Scoping Report
EIA	Environmental Impact Assessment
EMI	Electromagnetic Interference
FEIAR	Final Environmental Impact Assessment Report
FSR	Final Scoping Report
I&AP	Interested and/or Affected Party
ITC	Interference Testing and Consultancy Services
MW	Megawatt
RFI	Radio Frequency Interference
SAHRA	South African Heritage Resources Agency
SAHRIS	South African Heritage Information System
SKA	Square Kilometre Array
VIA	Visual Impact Assessment
WEF	Wind Energy Facility
WTG	Wind Turbine Generators
WUL	Water Use License

Issue/Comment	Raised By	Response
1 STAKEHOLDER / I&AP RELATED COMMENTS/ ISSUES		
1.1 Project Related Comments/Issues		
<p>It was stated that the EAP can contact DWS once they are ready to proceed with the application for the Water Use License (WUL) or General Authorisation (GA). In addition, it was stated that a meeting and site inspection will be required for start.</p>	<p style="text-align: center;">Khutjo Sekwaila Department of Water and Sanitation (DWS) Northern Cape Region Email: 08 August 2017</p>	<p>The comments from DWS were noted. The applicant will ensure that DWS is contacted by the appointed consultant once the WUL application is ready to proceed. A site meeting and site inspection will be arranged with DWS once Mainstream are ready to proceed with the application for the WUL. All correspondence undertaken with DWS is included in Appendix 7D of the DEIAr. Stephan Jacobs, SiVEST</p>
<p>A letter was provided in response to SiVEST's email request to provide an assessment on the potential development of four wind energy facilities and the risk they may pose on the Square Kilometre Array (SKA) Project.</p> <p>It was stated that a high level risk assessment has been conducted at the South African SKA Project Office to determine the potential impact of such facilities on the Square Kilometre Array (SKA). This letter serves to confirm the outcomes of the risk assessment, and proposals for any future investigations associated with these facility.</p> <p>i. The location of the proposed facilities has provided in Google Earth Shapefiles. The nearest SKA station is Rem-Opt-7 located at a distance of approximately 45km from proposed wind farms location; ii. Based on distances to the nearest SKA stations, and the information currently available on the detailed design of wind</p>	<p style="text-align: center;">Dr. Adrian Tiplady General Manager: Strategy & Business Process SKA South Africa Email: 23 August 2017</p>	<p>The comments / recommendations / requests from SKA were duly noted and requests will be adhered to accordingly by the applicant. It should be noted that initial detailed EMI and RFI specialist studies have been undertaken and are included in Appendix 9C of the DEIAr. The EMI and RFI studies were based on the currently available worst case scenario turbines. Due to technology improvements a different turbine may be used for the proposed development. Therefore more accurate EMI and RFI studies will be undertaken when a final turbine has been selected and the layout finalised. Prior to construction a new path loss and risk assessment will also be undertaken based on a final layout, using a worst case scenario turbine and approved by the SKA before any turbines are installed on the proposed site. A letter from ICT confirming this has been included in Appendix 9C of the DEIAr. It should be noted that these studies can only be undertaken once Mainstream have selected a final turbine and have undertaken the final modelling. As such, it is</p>

Issue/Comment	Raised By	Response
1 STAKEHOLDER / I&AP RELATED COMMENTS/ ISSUES		
<p>installations, these facility poses a medium to high risk of detrimental impact on the SKA;</p> <p>iii. Any transmitters that are to be established, or have been established, at the site for the purposes of voice and data communication will be required to comply with the relevant AGA regulations concerning the restriction of use of the radio frequency spectrum that applies in the area concerned. The establishment of such transmitter infrastructure will result in a high risk to the SKA;</p> <p>iv. As a result of the medium to high risk associated with these facilities. The SKA project office recommends that further EMI and RFI detailed studies be conducted as significant mitigation measures would be required to lower the risk of detrimental impact to an acceptable level.</p> <p>v. The South African SKA Project Office would like to be kept informed of progress with this project, and reserves the right to further risk assessments at a later stage.</p> <p>It was noted that this technical advice was provided by the South African SKA Project Office on the basis of the protection requirements of the SKA in South Africa, and does not constitute legal approval of the renewable energy projects in terms of the Astronomy Geographic Advantage Act, the Management Authority, and its regulations or declarations.</p>		<p>recommended that the DEA include a condition that final modelling and EMI and RFI studies be undertaken once the final turbine has been chosen. Mainstream will continue to engage with SKA accordingly throughout this process. In addition, SKA have been included on the project database and will receive all notifications regarding the EIA process.</p> <p>All correspondence undertaken with SKA SA is included in Appendix 7D. Stephan Jacobs, SiVEST</p>

Issue/Comment	Raised By	Response
1 STAKEHOLDER / I&AP RELATED COMMENTS/ ISSUES		
<p>The EAP was asked to ensure that the documents related to the Graskoppies FSR are uploaded to the relevant SAHRIS Case application. It was requested that the EAP inform Mrs. Higgitt when these documents have been re-uploaded so that she may attend to the cases.</p>	<p>Natasha Higgitt Heritage Officer: Archaeology, Palaeontology and Meteorites Unit SAHRA Email: 04 August 2017</p>	<p>All documents related to the Graskoppies FSR were uploaded to the relevant SAHRIS Case application (Case ID number: 11250) in SAHRIS as requested. In addition, Mrs. Higgitt was sent an email in order to inform her that these documents were uploaded as requested. All correspondence undertaken with SAHRA is included in Appendix 7D in the DEIAr. Stephan Jacobs, SiVEST</p>
<p>It was requested that the EAP ensure that the DSR for the Graskoppies case is re-uploaded to SAHRIS. It was stated that Mrs. Higgitt had issued comments where she referenced these reports, therefore they should not have been removed.</p>	<p>Natasha Higgitt Heritage Officer: Archaeology, Palaeontology and Meteorites Unit SAHRA Email: 01 September 2017</p>	<p>SiVEST thanked Mrs. Higgitt / SAHRA for their comment and re-uploaded the Graskoppies Wind Farm (Case ID number: 11250) DSR to SAHRIS as requested. SiVEST informed Mrs. Higgitt / SAHRA once these had been re-uploaded to SAHRIS. All correspondence undertaken with SAHRA is included in Appendix 7D of the DEIAr. Stephan Jacobs, SiVEST</p>
<p>The EAP was informed that SAHRA awaits the HIA as requested for in the SAHRA Interim Comment on the case.</p>	<p>Natasha Higgitt Heritage Officer: Archaeology, Palaeontology and Meteorites Unit SAHRA Email: 08 September 2017</p>	<p>The HIA report was updated according to the SAHRA Interim Comment on the case and was subsequently uploaded to SAHRIS as requested. The updated HIA report is included in Appendix 6H in the DEIAr. Stephan Jacobs, SiVEST</p>
1.2 Communication Related Comments/Issues		
<p>SANBI requested to be de-registered as an I&AP for the Environmental Impact Assessment (EIA) processes being undertaken for the four (4) proposed wind farms (Graskoppies, Hartebeest Leegte, Ithemba and Xha! Boom), as well as their associated grid connections.</p>	<p>Kensani Mangena Project Officer: Municipal Support SANBI Email: 06 September 2017</p>	<p>SiVEST thanked SANBI for their response / comment and informed them that this was received and noted. SiVEST subsequently removed SANBI as an I&AP for these projects as requested. Stephan Jacobs, SiVEST</p>

**ENVIRONMENTAL IMPACT ASSESSMENTS (EIAs) AND ENVIRONMENTAL MANAGEMENT PROGRAMMES (EMPrs)
FOR THE PROPOSED DEVELOPMENT OF FOUR (4) WIND FARMS NEAR LOERIESFONTEIN, NORTHERN CAPE
PROVINCE**

Draft Environmental Impact Assessment Report (DEIAR) I&AP Database

November 2016

First Name	Last Name	Company
Nicole	Abrahams	SANRAL
Koos	Alexander	Hantam Local Municipality
Tania	Anderson	WESSA: Northern Cape
Lerato	April	Department of Energy
Paul	Avenant	Department of Agriculture, Forestry & Fisheries
Quentin	Aylward	Cell C
M	Bartlett	Northern Cape Department of Agriculture, Land Reform and Rural Development
Amanda	Bester	Telkom SOC Ltd
Irene	Bezuidenhout	BioTherm Energy
Corne	Botha	MTN Telecoms
Lambert	Brand	Plaas: Georgs Vley 217, Remainder
Madeleinne	Brandt	Namakwa District Municipality
Hein	Burden	Portion 2 of the Farm Georgs Vley No. 127
Marie	Burden	Portion 2 of the Farm Georgs Vley No. 127
Erica	Burg	Telkom SOC Ltd
Thoko	Buthelezi	Dept of Agriculture, Forestry & Fisheries
Thoko	Buthelezi	Dept of Agriculture, Forestry & Fisheries
Hettie	Buys	Department of Agriculture, Forestry and Fisheries
Aubrey	Classen	Hantam LM
Shaun	Cloete	Department of Water and Sanitation
Chris	Coetzee	South African Astronomical Observatory
Andre	de Villiers	Andreas Ricus Trust
Henry	de Wee	Hantam Local Municipality
Jaco	Don	Plaas: Georgs Vley No. 127 (Voorman)
Brian	Dreyer	Neotel
Charl	Du Plessis	Hantam Local Municipality
Joshua	Engelbrecht	Cell C
Bennie	Engelbrecht	Hantam Local Municipality
Margaret	Esau	Hantam Local Municipality
Patrick	Farmer	Hantam Local Municipality
Belinda	Farmer	Hantam Local Municipality
Sam	Fiff	Transnet Freight Rail (Jhb)
Brian	Fisher	Dept of Environment and Nature Conservation
Colin	Fordham	Cape Nature Conservation
Chris	Fortuin	Namakwa District Municipality
Nico	Fourie	Department of Roads & Public Works: Northern Cape Province
Simon	Gear	Birdlife South Africa
John	Geeringh	Eskom Holdings SOC Ltd
Andrea	Gibb	SiVEST
Bradley	Gibbons	EWT: African Crane Conservation Programme
Marianne	Golding	Endangered Wildlife Trust
Geraldene	Gous	Hantam Local Municipality
Morgan	Griffiths	WESSA: National
W	Grobler	Department of Water & Sanitation
Michelle	Hartslief	South African Weather Service
Ambrose	Hector	Eskom Holdings SOC Ltd
Natasha	Higgitt	South African Heritage Resources Agency
Obakeng	Isaacs	KHAI-MA LOCAL MUNICIPALITY

Charl	Jooste	Solar Capital
P	Josop	Khai-Ma Local Municipality
Mere	Kgampe	Department of Science and Technology
Johan	Koegelenberg	SENTECH
Stephnie	Kot	Infrastructure Asset Management (IAM)
Theunis	Kotze	Portion 2 of Karree Doorn No 214
Hercule	Le Roux	MTN Telecoms
Tsholo	Leburu	Northern Cape Provincial Department
Lourens	Leeuwner	EWT
Seoka	Lekota	Department of Environmental Affairs
Eddie	Lennox	Eskom Holdings SOC Ltd
Patrick	Lenyibi	DEPARTMENT OF SPORT, ARTS & CULTURE
Aaron	Lephalo	Solar Power Plant Construction
Deidre	Lesch	WWF
Bertram	Leukes	Hantam Local Municipality
Ben	Liebenberg	
Braam	Lintvelt	Plaas: Aan de Karee Doornpan
Riana	Lock	Hantam Plaaslike Munisipaliteit
Frans / gys	Lombard	Plaas: Karree Doorn No 214, Ptn 1
Jannie	Loubser	Namakwa District Municipality
Albie	Louw	Plaas: Hartebeest Leegte 216, Ptn 1
Hermanus	Louw	Portion 1 of the Farm Hartebeest Leegte No. 216
Nico	Louw	Portion 2 of the Farm Gras Koppies No. 176
Alwyn	Louw	
Dave	Lucas	Eskom Holdings SOC Ltd
Kate	MacEwan	South African Bat Assessment Association
Moses	Mahunonyane	Department of Water & Sanitation
Ester	Makungo	Department of Water & Sanitation
Jacoline	Mans	Department of Agriculture, Forestry & Fisheries
Mashudu	Marubini	DAFF Provincial Department
Simpfiwe	Masilela	Air Traffic Navigation Services
Pheladi	Masipa	Department of Energy
Rochelle	McPherson	Eskom Holdings SOC Ltd
Elias	Mohapi	Solar Power Plant Construction
Ishmael	Mokhati	Solar Power Plant Construction
Johanna	Morobane	Air Traffic Navigation Services
Lungile	Motsisi	Eskom Holdings SOC Ltd
Thulani	Mthombeni	NC Dept of Environment and Nature Conservation
George	Muller	Hantam Local Municipality
Serah Masala	Muobeleni	DAFF
Henning	Myburg	Agri SA: Northern Cape
Ono	Naude	Vodacom
Onwabile	Ndzumo	NC Dept of Environment and Nature Conservation
Koosie	Nel	Potriion 1 of Graskoppies 176
Hermanus	Nel	Remainder of the Farm Hartebeest Leegte No. 216
Joseph	Nhlapo	SENTECH
Jasper	Nieuwoudt	Deparment of Mineral Resources
David	Ockhuys	
Gizella	Opperman	Hantam Local Municipality
Richwell	Phale	Solar Power Plant Construction
Mmatlala	Rabothata	Department of Environmental Affairs
Samantha	Ralston-Paton	Bird Life South Africa
Ntsundeni	Ravhogoni	Department of Mineral Resources (DMR)
Nicole	Reddy	WWF-SA
Harry	Roberts	SA CAA
Lucia	Rodrigues	Western Cape Black Eagle Project

Jaco	Roelofse	NC Department of Roads & Public Works
Rosey	Sekese	Dept of Telecommunications and Postal Service
Kwena Khutjo	Sekwaila	Department of Water and Sanitation
Madyo	Sindisile	Namakwa District Municipality
Henri	Smit	Plaas: Zuur Fontein 224, Ptn 1
Immanuel	Smith	Namakwa District Municipality
Candice	Spammer	Telkom SOC Ltd
Hennie	Spannenberg	Plaas: Nabasiep 219, Remainder & Ptn 1 Kapteins Kraal 222
Gert	Steenkamp	DAFF: Regional Northern Cape
Jeany	Steenkamp	Hantam Local Municipality
Hermina	Steenkamp	Hantam Plaaslike Munisipaliteit
Gert	Steenkamp	NC Department of Agriculture, Land Reform and Rural Development
Frik	Sterkse	Hantam Plaaslike Munisipaliteit
Lizell	Stroh	SA Civil Aviation Authority
Shaun	Swanepoel	Eskom Holdings SOC Ltd
Roger	Swartz	Hantam Local Municipality
Adriaan	Tiplady	Square Kilometre Array
Heleen	van den Heever	Telkom SOC Ltd
Christo	van der Merwe	Plaas: Zuur Fontein 224, Ptn 2
Francois	van der Merwe	Remainder of Sous 226
Gert	van der Walt	Vodacom
Deon	Van der Westhuizen	Plaas: Klein Rooiberg
Kokkie	van der Westhuizen	Plaas: Zuur Fontein 224
Herman	van Heerden	Portion 5 of the farm Klein Rooiberg No. 227
Hentie	van Jaarsveld	Agri SA: Loeriesfontein Landbouvereniging
Riaan	Van Wyk	Hantam Local Municipality
NJ	Van Zyl	Agri SA: Loeriesfontein Landbouvereniging
Hannes	Van Zyl	Agri SA: Loeriesfontein Landbouvereniging
Abraham	van Zyl	Plaas: Blaauw Pan 175, Remainder
Albertus	Van Zyl	PTN 3 Farm GIFKOP116
Paul	Venter	MTN Telecoms
Charles	Versfeld	Plaas: Buchufontein 184, Remainder
Fred	Versfeld	Remainder Farm Buchu Fontein 184
Noel	Viljoen	Hantam Local Municipality
Ronelle	Visagie	EWT
Jonathan	Visagie	Telkom SOC Ltd
Ted	Williams	South African Astronomical Observatory
Justine	Wyngaardt	Eskom Holdings SOC Ltd
Megan		Sustainable Energy Africa
		De Beers Consolidated Mines (Pty) Ltd
		Sustainable Energy & Climate Change Project

LANDOWNER CONSENT FORM

ENVIRONMENTAL IMPACT ASSESSMENT (EIA) FOR THE PROPOSED DEVELOPMENT OF THE GRASKOPPIES WIND FARM NEAR LOERIESFONTEIN, NORTHERN CAPE PROVINCE

Property Details:	Portion 1 of the Farm Hartebeest Leegte No 216
Registered Title Deed Owner	HERMANUS ALBERTUS LOUW
Full name(s) & Surname of Owner/Occupier/Legal Representative of land:	HERMANUS ALBERTUS LOUW
Identification Number:	5710025060087
Postal Address:	Postbus 50 Loeriesfontein 8185
Telephone Number:	027 5011 045
Fax Number:	—
Cell Phone Number:	083 236 8911
E-mail Address:	J taaboshok @ g mail. com
SIGNATURE	

LANDOWNER CONSENT FORM

ENVIRONMENTAL IMPACT ASSESSMENT (EIA) FOR THE PROPOSED DEVELOPMENT OF THE GRASKOPPIES WIND FARM NEAR LOERIESFONTEIN, NORTHERN CAPE PROVINCE

Property Details:	Portion 2 of the Farm Graskoppies No 176
Registered Title Deed Owner	
Full name(s) & Surname of Owner/Occupier/Legal Representative of land:	Nicolaas Hendrik Louw
Identification Number:	690125 5154 083
Postal Address:	Postbus 184 Loeriesfontein 8185
Telephone Number:	027 6629800
Fax Number:	
Cell Phone Number:	082 7747315
E-mail Address:	lounic@vodamail.co.za
SIGNATURE	

ENVIRONMENTAL IMPACT ASSESSMENTS (EIAs) FOR THE PROPOSED DEVELOPMENT OF FOUR (4) WIND FARMS AND BASIC ASSESSMENTS (BAs) FOR THE ASSOCIATED GRID CONNECTION NEAR LOERIESFONTEIN, NORTHERN CAPE PROVINCE

DISTRIBUTION OF THE WIND FARM DRAFT ENVIRONMENTAL IMPACT ASSESSMENT REPORT (DEIAR) TO ORGANS OF STATE FOR COMMENT

TITLE	SURNAME	NAME	POSITION	POSTAL ADDRESS	EMAIL ADDRESS
HANTAM LOCAL MUNICIPALITY					
Mr	Van Wyk	Riaan		Private Bag X14 CALVINIA 8190	municipalmanager@hantam.gov.za socialdev1@hantam.gov.za
KHAI-MA LOCAL MUNICIPALITY					
Mr	Isaacs	Obakeng	Municipal Manager	PO Box 108 Pofadder 8890	munman@khaima.gov.za
Mr	Josop	P	Land Use Officer	PO Box 108 Pofadder 8890	commonage@khaima.gov.za
NAMAKWA DISTRICT MUNICIPALITY					
Mr	Loubser	Jannie	Manager: Planning	Private Bag X20 SPRINGBOK 8240	janniel@namakwa-dm.gov.za
DEPARTMENT OF ENVIRONMENTAL AFFAIRS BIODIVERSITY					
Mr	Lekota	Seoka		Private Bag X447 Pretoria 0001	slekota@environment.gov.za
Mr	Rabothata	Mmatlala		Private Bag X447 Pretoria 0001	slekotamrabothata@environment.gov.za
AGRI SA-NORTHERN CAPE					
Mr	Myburg	Henning	General Manager	PO Box 1094 KIMBERLEY 8300	henning@agrink.co.za
DEPARTMENT OF WATER AND SANITATION					
Ms	Makungo	Ester	Environmental Officer	Private Bag X6101 KIMBERLEY 8300	makungoe@dws.gov.za
Mr	Mahunonyane	Moses	Director: Institutional Establishment	Private Bag X6101 KIMBERLEY 8300	MahunonyaneM@dws.gov.za
SOUTH AFRICAN NATIONAL BIODIVERSITY INSTITUTE (SANBI)					
REQUESTED TO BE REMOVED AS AN I&AP					
NORTHERN CAPE DEPARTMENT OF AGRICULTURE, LAND REFORM & RURAL DEVELOPMENT					
Mr	Steenkamp	Gert		P.O.Box 65 CALVINIA 8190	gsteenkamp@ncpg.gov.za
DEPARTMENT OF AGRICULTURE, FORESTRY AND FISHERIES					

ENVIRONMENTAL IMPACT ASSESSMENTS (EIAs) FOR THE PROPOSED DEVELOPMENT OF FOUR (4) WIND FARMS AND BASIC ASSESSMENTS (BAs) FOR THE ASSOCIATED GRID CONNECTION NEAR LOERIESFONTEIN, NORTHERN CAPE PROVINCE

DISTRIBUTION OF THE WIND FARM DRAFT ENVIRONMENTAL IMPACT ASSESSMENT REPORT (DEIAR) TO ORGANS OF STATE FOR COMMENT

TITLE	SURNAME	NAME	POSITION	POSTAL ADDRESS	EMAIL ADDRESS
Provincial Department					
Mrs	Collett	Anneliza		Private Bag X120 PRETORIA 0001	ThokoB@nda.agric.za
Ms	Buthelezi	Thoko	Directorate Land Use and Soil	Private Bag X120 PRETORIA 0001	ThokoB@nda.agric.za
DEPARTMENT OF MINERAL RESOURCES (DMR)					
Mr	Muila	Vincent		Private Bag x6093 KIMBERLEY 8300	
Mr	Sekepane	Rasibe		Private Bag x6093 KIMBERLEY 8300	
NORTHERN CAPE DEPT OF ENVIRONMENT AND NATURE CONSERVATION					
Mr	Fisher	Brian	Director Environmental Impact Management	Private Bag X86102 KIMBERLEY 8300	bfisher@ncpg.gov.za
NORTHERN CAPE DEPT OF SPORT, ARTS & CULTURE: Heritage Resources Unit					
Mr	Lenyibi	Patrick	Manager: Heritage Resources	Private Bag X5004 KIMBERLEY 8300	plenyibi@ncpg.gov.za
SANRAL - WESTERN REGION					
Ms	Abrahams	Nicole	Environmental Coordinator	Private Bag X19 BELLVILLE 7535	abrahamsn@nra.co.za
NORTHERN CAPE DEPARTMENT OF ROADS AND PUBLIC WORKS					
Mr	Roelofse	Jaco	Director: Planning & Design	PO Box 3132 Kimberley 8300	roelofse.j@vodamail.co.za
SAHRA: HEAD OFFICE					
Ms	Higgitt	Natasha	Heritage Officer: Northern Cape	PO Box 4637 CAPE TOWN 8000	nhiggitt@sahra.org.za
ESKOM					
Mr	Geeringh	John	Chief Planner	PO Box 1091 JOHANNESBURG 2000	GeerinJH@eskom.co.za
SQUARE KILOMETRE ARRAY					
Dr	Tiplady	Adriaan	Manager: Site Categorisation	PO Box 522 SAXONWOLD 2132	atiplady@ska.ac.za
SA CIVIL AVIATION AUTHORITY (SA CAA)					

ENVIRONMENTAL IMPACT ASSESSMENTS (EIAs) FOR THE PROPOSED DEVELOPMENT OF FOUR (4) WIND FARMS AND BASIC ASSESSMENTS (BAs) FOR THE ASSOCIATED GRID CONNECTION NEAR LOERIESFONTEIN, NORTHERN CAPE PROVINCE

DISTRIBUTION OF THE WIND FARM DRAFT ENVIRONMENTAL IMPACT ASSESSMENT REPORT (DEIAR) TO ORGANS OF STATE FOR COMMENT

TITLE	SURNAME	NAME	POSITION	POSTAL ADDRESS	EMAIL ADDRESS
Ms	Stoh	Lizell	Obstacle Specialist	Private Bag X73 HALFWAY HOUSE 1685	strohl@caa.co.za
AIR TRAFFIC AND NAVIGATION SERVICES (ATNS)					
Ms	Morobane	Johanna	Manager: Corporate Sustainability and Environment	Private Bag X15 KEMPTON PARK 1620	JohannaM@atns.co.za
Ms	Masilela	Simphiwe	Obstacle Evaluator	Private Bag X15 KEMPTON PARK 1620	SimphiweM@atns.co.za
TRANSNET FREIGHT RAIL					
Mr	Fiff	Sam	Environmental Manager: Freight Rail	PO Box 255 BLOEMFONTEIN 9300	sam.fiff@transnet.net

ENVIRONMENTAL IMPACT ASSESSMENTS (EIAs) FOR THE PROPOSED DEVELOPMENT OF FOUR (4) WIND FARMS AND BASIC ASSESSMENTS (BAs) FOR THE ASSOCIATED GRID CONNECTION NEAR LOERIESFONTEIN, NORTHERN CAPE PROVINCE

DISTRIBUTION OF THE WIND FARM DRAFT ENVIRONMENTAL IMPACT ASSESSMENT REPORT (DEIAR) TO ORGANS OF STATE FOR COMMENT

TITLE	SURNAME	NAME	POSITION	POSTAL ADDRESS	EMAIL ADDRESS
SENTECH					
Mr	Koegelenberg	Johan	Renewable Projects	Private Bag X06 Honeydew 2040	koegelenbergj@sentech.co.za
TELKOM					
Ms	Spammer	Candice	Western Cape Region	Private Bag X20700 BLOEMFONTEIN 9300	SpammerC1@telkom.co.za
Mr	Bester	Amanda	Wayleave Officer	Private Bag X20700 BLOEMFONTEIN 9300	WayleaCR@telkom.co.za BesterAD@telkom.co.za
Ms	van den Heever	Heleen	Ops Manager Central Region	Private Bag X20700 BLOEMFONTEIN 9300	vdheevhd@telkom.co.za
ENDANGERED WILDLIFE TRUST					
Mr	Leeuwner	Lourens	Renewable Energy Project Manager	Private Bag X11, Modderfontein, 1609, Johannesburg	lourensl@ewt.org.za
Ms	Golding	Marianne	Administrator	Private Bag X11, Modderfontein, 1609, Johannesburg	
WESSA					
Mr	Griffiths	Morgan	Environmental Governance Programme Manager	PO Box 12444, Centrahil, Port Elizabeth, 6006, South Africa	morgan.griffiths@wessa.co.za
BIRDLIFE SOUTH AFRICA					
Ms	Stevens	Candice	Policy Manager	PO Box 515 RANDBURG 2125	advocacy@birdlife.org.za
Ms	Ralston	Samantha		PO Box 515 RANDBURG 2125	
South African Astronomical Observatory					
Prof	Ted	Williams	Director	PO Box 9 OBSERVATORY 1935	williams@sao.ac.za
Mr	Chris	Coetzee	Technical Operations Manager Sutherland Site	PO Box 25 SUTHERLAND 6920	chris@salt.ac.za