



Interference Testing and Consultancy Services (Pty) Ltd

ITC SERVICES (PTY) LTD Reg 88/02032/07
 Plot 44 Kameeldrift East, Pretoria
 Private Bag X13 Lynn East 0039
 Republic of South Africa
 Tel (012) 808 1730 Int + 27 12 808 1730
 Fax (012) 808 1733

**PATH LOSS AND RISK
 ASSESSMENT REPORT FOR
 GRASKOPPIES BASED ON THE
 EMISSION CONTROL PLAN FOR
 THE ACCIONA
 AW125 TH100A WTG**

DOCUMENT NUMBER : CP 7152_2/16

REVISION : 0.5

DATE : 05 January 2017

MASTER : MASTER

CONFIGURATION CONTROL

PARTIES INVOLVED			
AUTHORITY	NAME	SIGNATURE	DATE
Client Mainstream (Pty) Ltd			
ITC SERVICES Prepared By	C Fouché		
ITC SERVICES Reviewed By	JJ Joubert		

DISTRIBUTION LIST		
COPY NO	NAME	ORGANISATION
MASTER		
1	CONFIGURATION LIBRARY	ITC SERVICES

HISTORY SHEET				
REV	DATE	AUTHOR	PAGES AFFECTED	CHANGE PROPOSAL
1.0	18/12/2016	CFH Fouche	All	N/A

MAGNETIC ARCHIVE INFORMATION	
DIRECTORY	FILE NAME
C:\Users\Admin\Documents\Projects\ Renewable energy and SKA\Mainstream\Graskoppies\	Graskoppies 0.5

LIST OF EFFECTIVE PAGES								CONFIGURATION CONTROL
PAGE	REV	PAGE	REV	PAGE	REV	PAGE	REV	
1	1.0							
2	1.0							
3	1.0							
4	1.0							
5	1.0							
6	1.0							
7	1.0							
8	1.0							
9	1.0							
10	1.0							
11	1.0							
12	1.0							
13	1.0							
14	1.0							

ACRONYMS AND ABBREVIATIONS

AC	Alternating Current
AM	Amplitude Modulation
CAL	Calibration
CCW	Counter Clockwise
CM	Common Mode
E-Fields	Electric Fields
EM	Electro Magnetic
EMC	Electromagnetic Compatibility
EMI	Electromagnetic Interference
Eq	Equation
EUT	Equipment Under Test
Fr	Resonant frequency
H- Fields	Magnetic Fields
IEEE	Institute of Electrical and Electronic Engineers
MIL-STD	Military Standard
PSU	Power Supply Unit
R&S	Rohde and Schwarz
RF	Radio Frequency
SE	Shielding Effectiveness
SELDS	Shielded Enclosure Leak Detection System
SKA	Square Kilometer Array

TABLE OF CONTENTS

1. INTRODUCTION 6

2. SCOPE 6

2.1 INTENT 6

3. ASSESSMENT METHODOLOGY 6

4. REFERENCES 6

4.1 REFERENCED DOCUMENTS 6

4.2 GENERAL REFERENCE MATERIAL 7

5. SYSTEM ARCHITECTURE 7

5.1 BASIC INFORMATION..... 7

5.2 TURBINE STRUCTURE & LAYOUT..... 7

5.3 SITE WIDE COMMUNICATIONS 8

6. EMC REQUIREMENTS..... 9

7. EMC ANALYSIS 9

7.1 SITE LOCATION 9

 7.1.1 Area Map 9

 7.1.2 Local Map 10

 7.1.3 Distance Table 10

 7.1.4 Elevation Maps 11

7.2 PATH LOSS CALCULATIONS 12

7.3 MITIGATION REQUIRED 13

 7.3.1 Path Loss comparison 13

 7.3.2 Conclusion 13

7.4 TESTS AT THE NEW SITE 14

7.5 FINAL SITE TESTS 14

TABLE OF TABLES

Table 1: Graskoppies layout distance from SKA infrastructure..... 10
Table 2: Path loss input data 12
Table 3: Path loss comparison between sites 13

TABLE OF FIGURES

Figure 1: High level block diagram 7
Figure 2: Turbine components 8
Figure 3: WTG 1 to Rem Opt 7 11
Figure 4: WTG 41 to SKA 2377 11

1. INTRODUCTION

An area 75km north of Loeriesfontein in the Northern Cape Province, has been identified for the Graskoppies Windfarm Facility (Graskoppies) development by South Africa Mainstream Renewable Power Developments (Pty) Ltd (Mainstream).

The SKA is a stakeholder listed in the Interested and Affected parties of the EIA phase of the proposed project. In order to determine whether the planned windfarm development could have any influence on the SKA, Mainstream requested a risk evaluation of the planned development to SKA activities.

The frequency band of concern for SKA mid-band is 200MHz to 20GHz. This assessment does not consider any potential telecommunication services or networks that are to be established as part of the operational plan.

This risk assessment assumes the use of 47 Acciona AW 125 TH100A turbines within the Graskoppies development and will be compared to known radiated emission data from the AW125 TH100A Acciona WTG as presented in the Acciona Control Plan [5].

2. SCOPE

The Acciona AW 125 TH 100A is the model within the AW 3000 platform that will be evaluated for this project. This assessment will be updated based on additional measurement results and design information as it becomes available.

2.1 INTENT

The intent of this evaluation is to ensure that the Graskoppies facility poses a low risk of detrimental impact on the SKA by using known radiated emission amplitudes of the Acciona AW3000/125 TH100 50Hz wind turbine. Specific mitigation measures to be implemented on the AW3000/125 TH100 50Hz wind turbine in order to achieve 40 dB of attenuation has been reviewed and agreed by SKA South Africa as described in [5].

3. ASSESSMENT METHODOLOGY

- i. Confirm windfarm location with Mainstream.
- ii. Confirm nearest SKA dish installation area with SKA.
- iii. Confirm system architecture with Mainstream or turbine supplier.
- iv. Plot line of sight graphs using the hub height and 15m for the SKA dish between the SKA dish and nearest wind turbine generator (WTG).
- v. Perform path loss calculations using the Irregular Terrain Model between the WTG and SKA dish.
- vi. Use the Acciona AW3000/125 TH100 radiated emission data and subtract the total path loss to confirm the result is less than the specified level at the SKA dish installation location.
- vii. If the result from point vi above exceeds the specified level, additional mitigation is required.

4. REFERENCES

4.1 REFERENCED DOCUMENTS

[1]	No.R 90. Government Gazette 10 February 2012 (35007).	Regulations on Radio Astronomy Protection Levels in Astronomy Advantage Areas Declared for the Purposes of Radio Astronomy
[2]	NIE 49577REM.001	Measurements according to client protocol " Emission Test Procedure for the AW TH100A WTG"
[3]	DG200233 Rev G	AW3000 Earthing and Lightning protection Systems; Acciona Windpower
[4]	INP125 Rev A	Windfarm Communications – Garob / Copperton: Acciona Windpower
[5]	CP 6902/16 Rev 2.0	Emission Control Plan for the AW125 TH100A WTG
[6]	CP 7099/16 Rev 1.0	Path Loss and Risk Assessment Report for Teekloof based on the Emission Control Plan for the Acciona AW125 TH100A WTG

4.2 GENERAL REFERENCE MATERIAL

- EMC Analysis Methods and Computational Models, Frederick M. Tesche, Michel V. Ianoz, Torbjörn Karlson, Wiley Interscience, 1997
- Noise reduction techniques in electronic systems, Second edition, Henry W. Ott, Wiley Interscience Publications, 1998
- Electromagnetic Compatibility - Principles and Applications, Second Edition, David A. Weston, Marcel Dekker Inc, 2000

5. SYSTEM ARCHITECTURE

5.1 BASIC INFORMATION

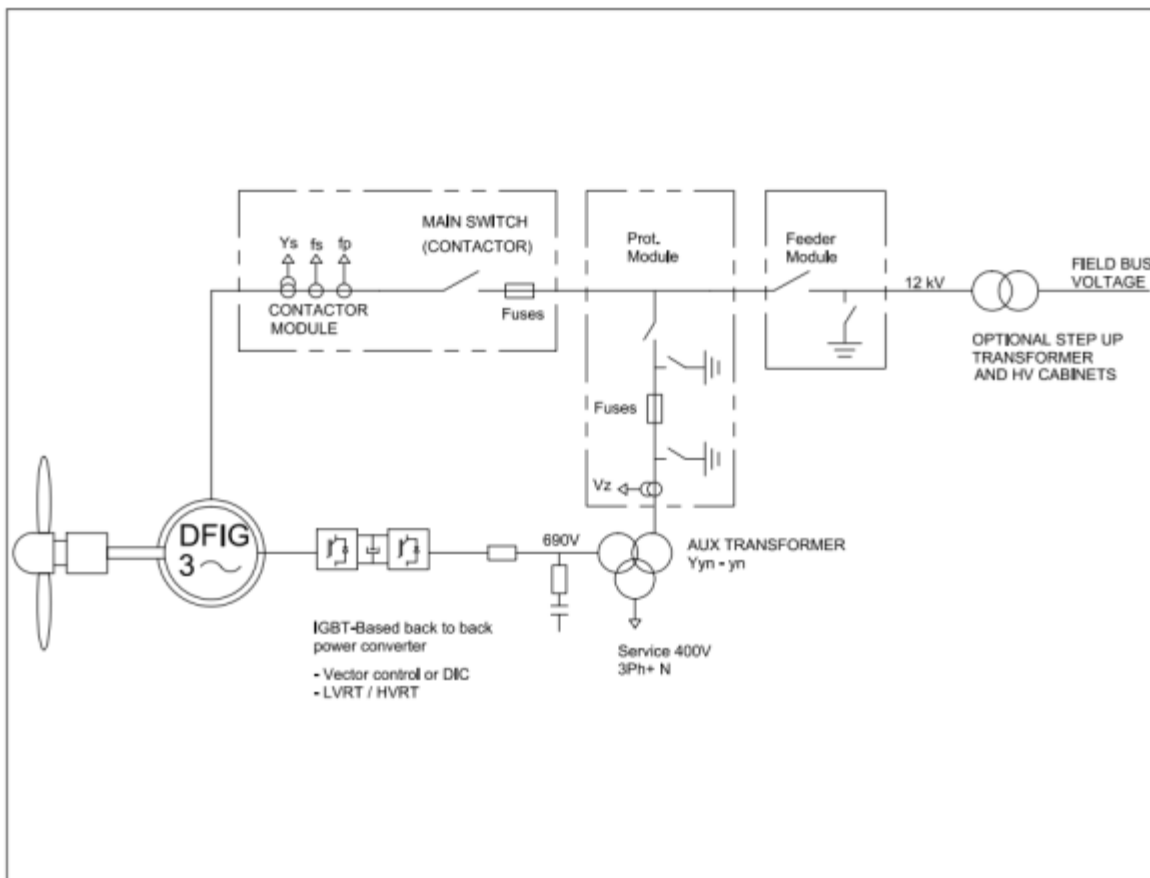

Figure 1: High level block diagram

5.2 TURBINE STRUCTURE & LAYOUT

The turbine configuration evaluated as part of this document consists of a base, a 100m concrete tower and a nacelle on top as shown in Figure 2. A hub height of 150m was used during the calculations as requested by Mainstream.

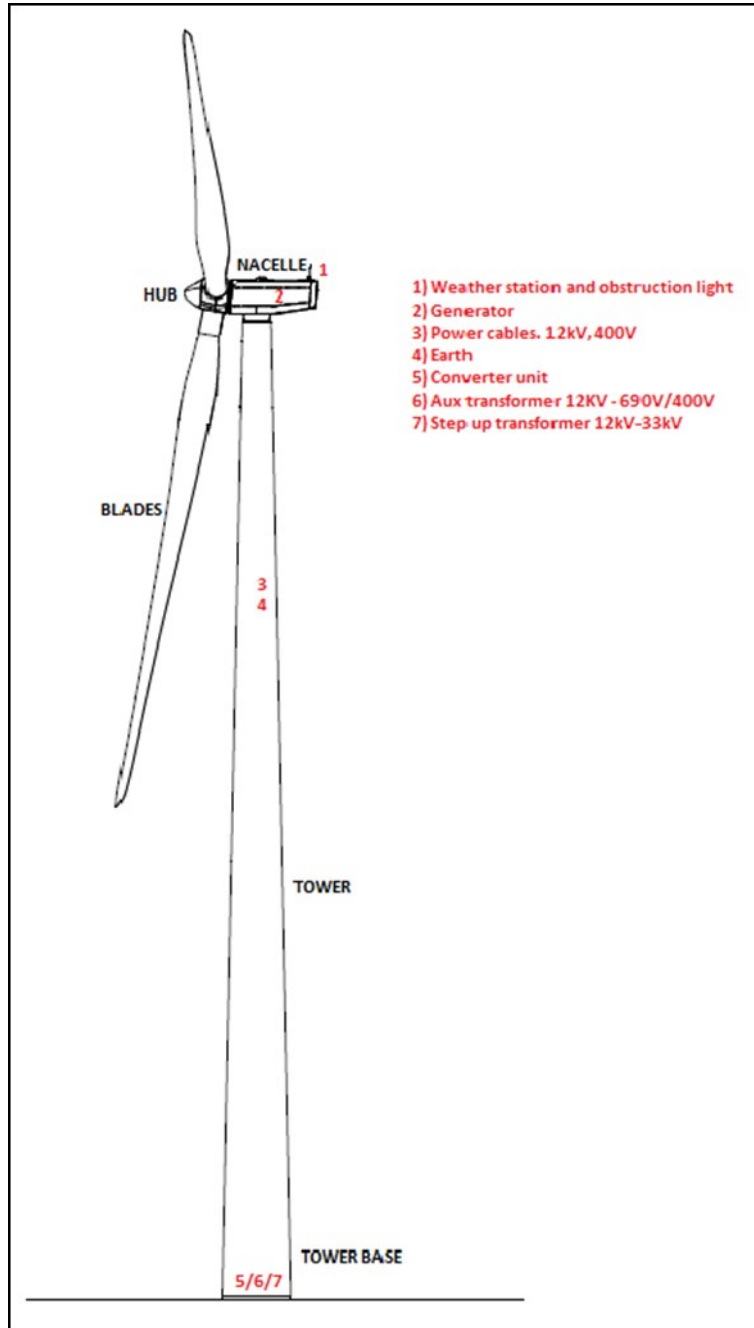

Figure 2: Turbine components

5.3 SITE WIDE COMMUNICATIONS

The communication among the wind turbines, the met masts and wind turbines and the substation will always be through an Ethernet optical fiber network as described in INP125-A.

6. EMC REQUIREMENTS

The current Emission Control Plan for the AW125 TH100A WTG [5] provides for a 40dB reduction in radiated emissions to ensure the cumulative emission level of previously assessed wind farms where the Acciona AW 125 TH100A WTG will be used is within the requirements of SKA. This requirement is based on measurements on the Acciona AW 125 TH100A WTG at the Gouda facility in South Africa and Barosoain windfarm, Navarra, Spain.

7. EMC ANALYSIS

7.1 SITE LOCATION

7.1.1 Area Map

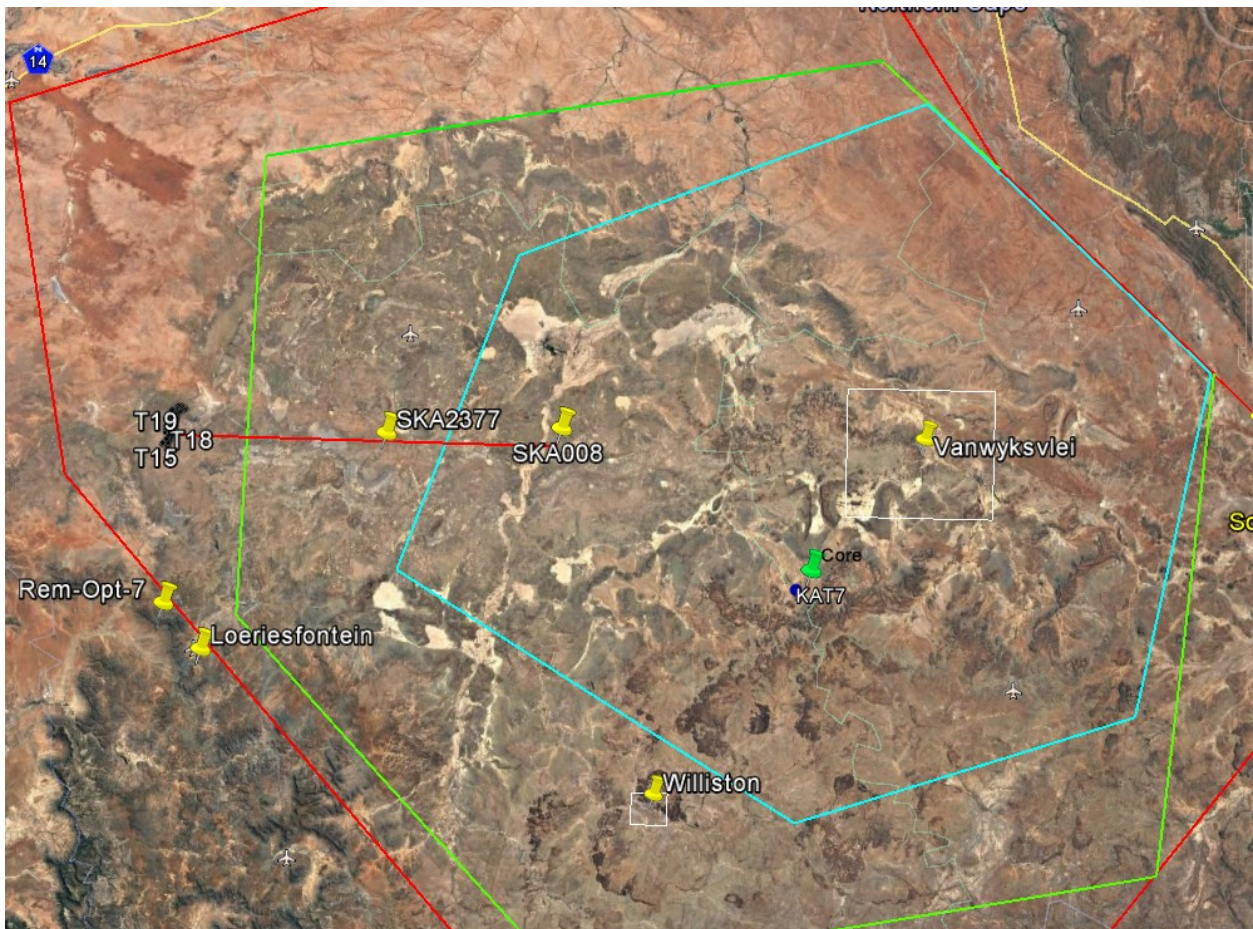

Picture 1: Area map showing Graskoppies locations relative to SKA

Two WTG locations (WTG 1 and WTG 41) and two SKA installations (Rem Opt 7 and SKA 2377) were used for the evaluation.

7.1.2 Local Map



Picture 2: Local map showing nearest two SKA Locations

7.1.3 Distance Table

	Graskoppies WTG 1	Graskoppies WTG 41
SKA Rem Opt 7	53.3km	66.5km
SKA ID 2377	68.0km	63.7km
MeerKAT (Core)	206.0km	204km

Table 1: Graskoppies layout distance from SKA infrastructure

7.1.4 Elevation Maps

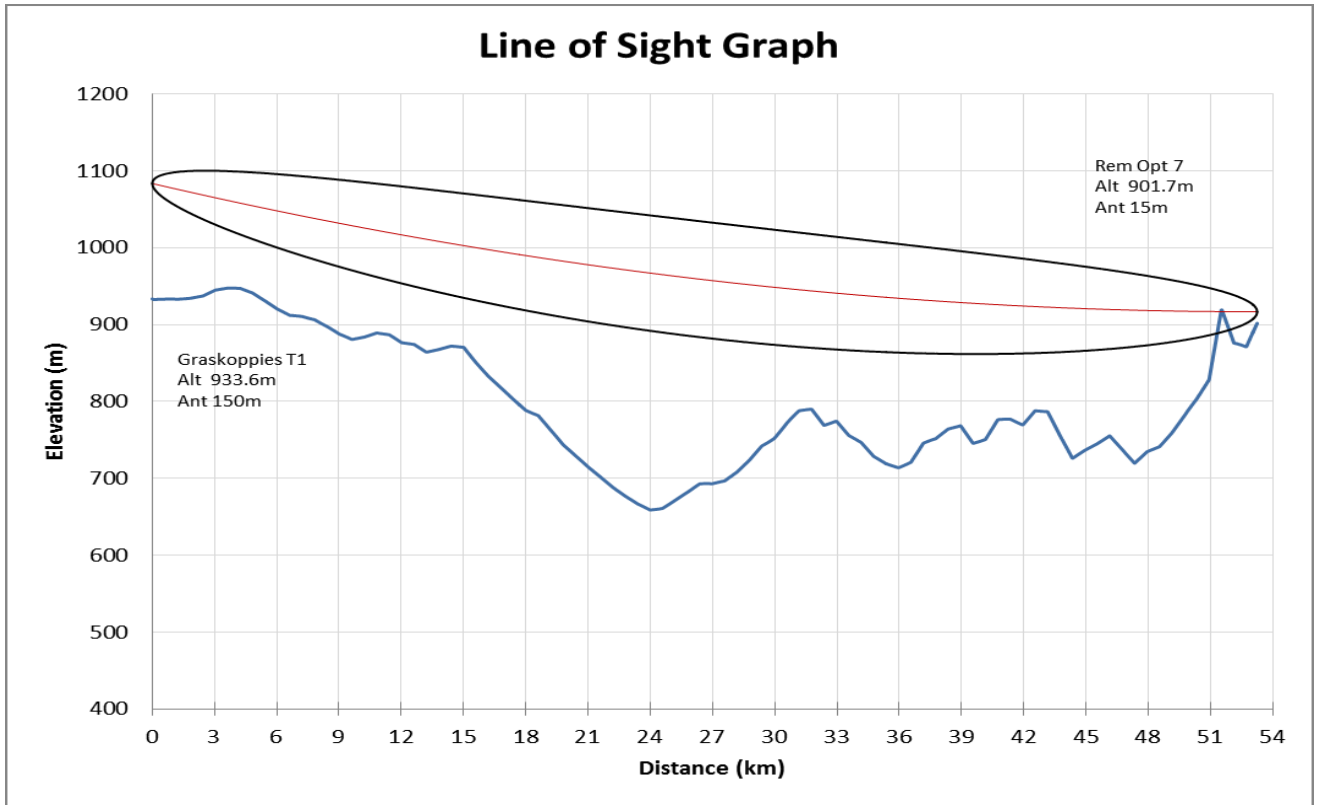

Figure 3: WTG 1 to Rem Opt 7

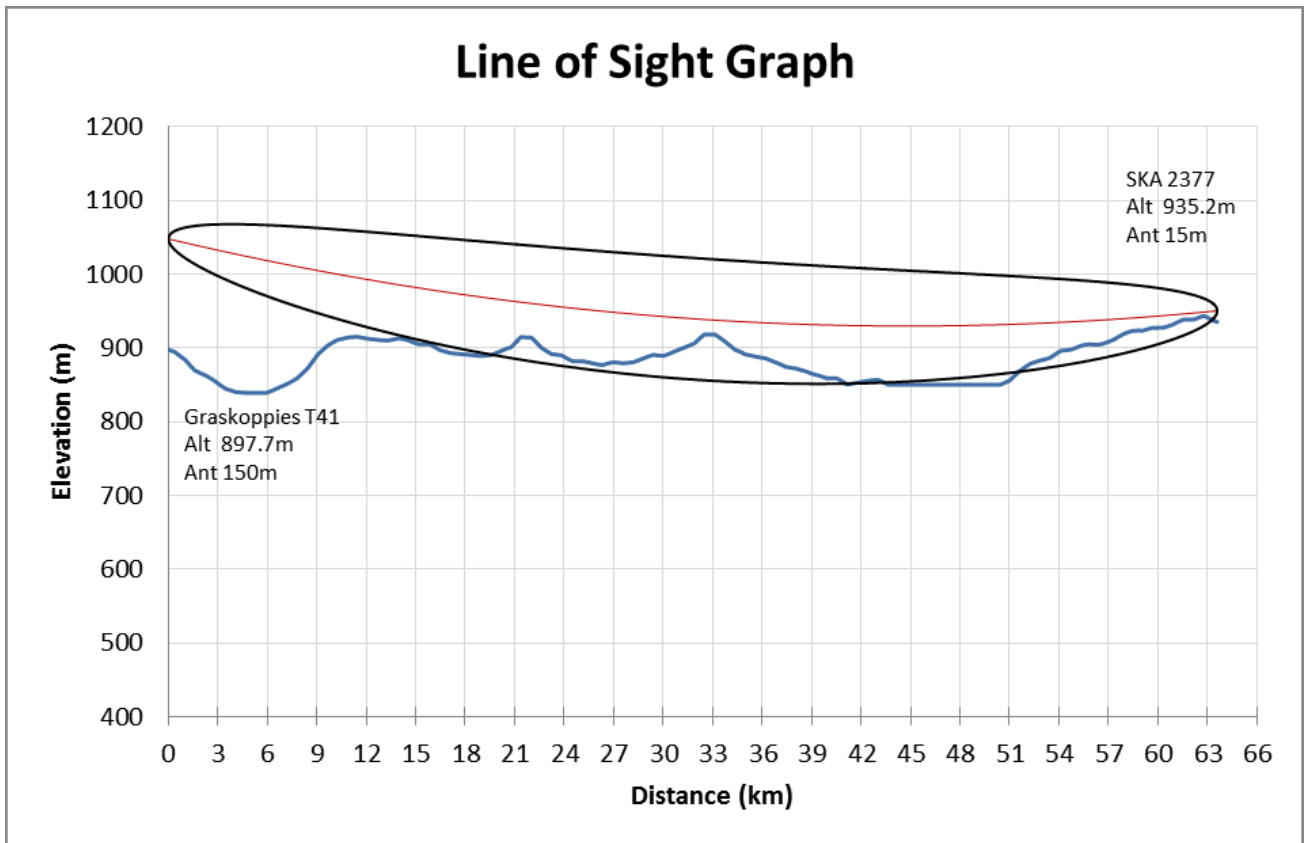

Figure 4: WTG 41 to SKA 2377

7.2 PATH LOSS CALCULATIONS

The path loss was calculated using the parameters as specified in Table 2: Path loss input data.

Parameter	Description	Quantity	Comment
Source/ Victim separation distance	SKA 2377 to WTG 41	63.5km	Line of sight
Source/ Victim separation distance	Rem Opt 7 to WTG 1	53.2km	Non line of sight
Frequency	Frequencies assessed	100MHz, 300MHz, 500MHz, 1000MHz, 3000MHz, 6000MHz	Free space loss increases with frequency.
SARAS	Protection level	$\text{dBm/Hz} = -17.2708 \log_{10}(f) - 192.0714$ for $f < 2\text{GHz}$	Government Gazette 10 February 2012
Location	WTG 1	Lat: -30.3440982793° Lon: 19.3405668479°	Waypoint received from Mainstream
Location	WTG 41	Lat: -30.2296490751° Lon: 19.3980976928°	Waypoint received from Mainstream
Location	SKA 2377	Lat: -30.340201° Lon: 20.047739°	Waypoint received from SKA SA (Pty) Ltd
Location	Rem Opt 7	Lat: -30.822164° Lon: 19.311400°	Waypoint received from SKA SA (Pty) Ltd
TX height	Nacelle	150m	Height of nacelle eqp
	Base	2m	Height of base eqp
RX height	All SKA receivers	15m	Height used for SKA receive horn

Table 2: Path loss input data

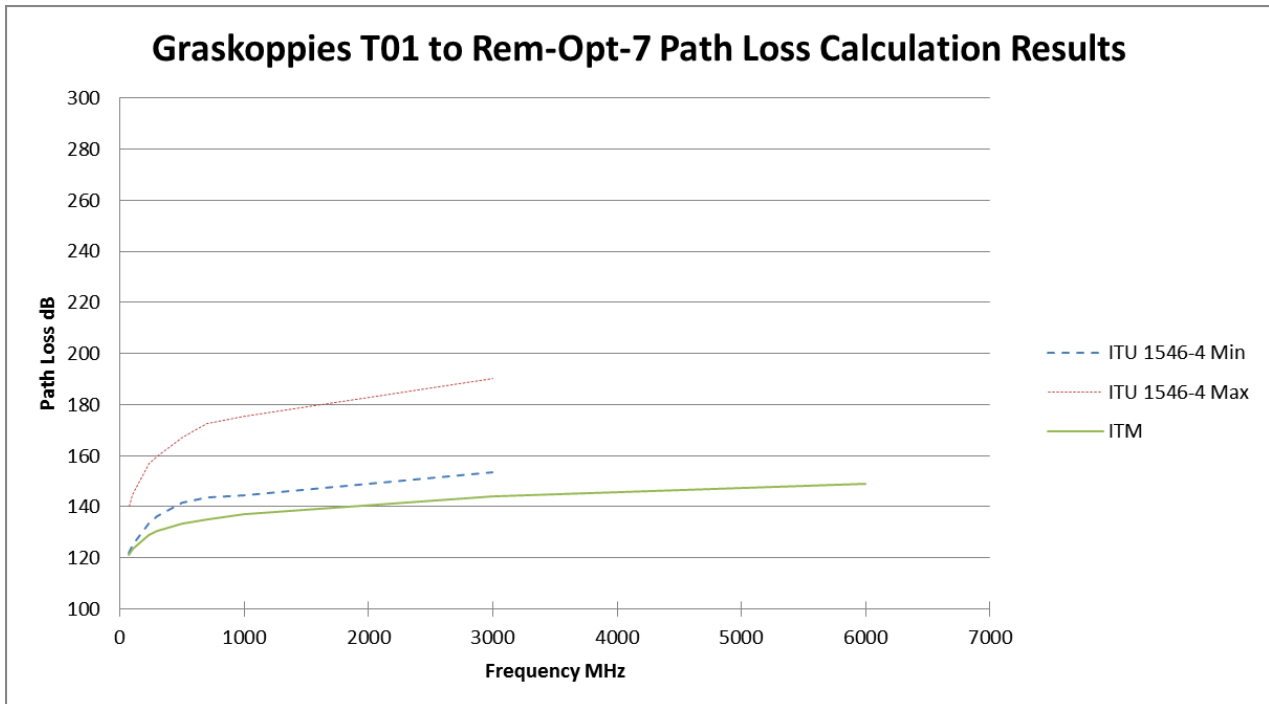

Graph 1: WTG 1 (150m height) to SKA Rem Opt 7 Path Loss Calculation result

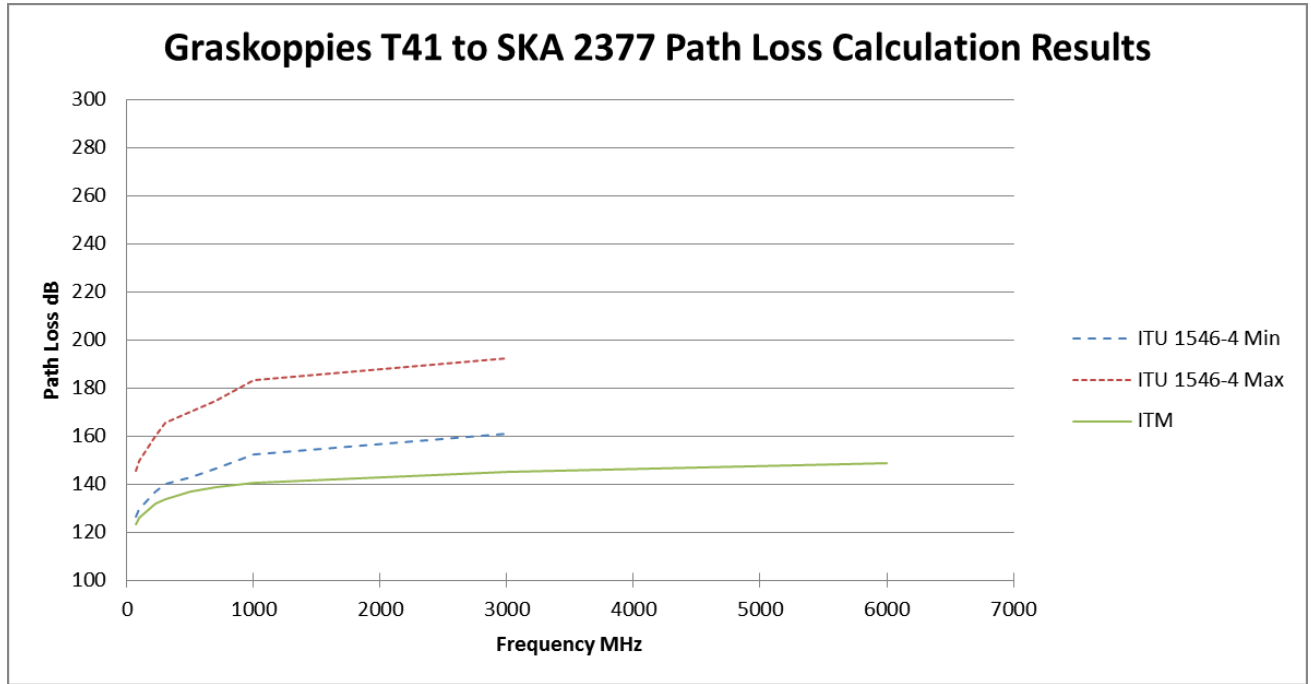

Graph 2: WTG 41 (150m) to SKA 2377 Path Loss Calculation result

Graph 1 and Graph 2 show path loss calculations for the nacelle equipment emissions at 150m hub height.

SPLAT! (Signal Propagation, Loss And Terrain) analysis and Radio Mobile Deluxe was used to calculate the ITM path loss values. Both are based on the Longley –Rice Irregular Terrain Model and Irregular Terrain With Obstruction Model. The digital elevation model resolution data used was 3-arc –seconds.

The ITU 1546-4 was calculated with Monte Carlo based ITU 1546-4 path loss software to obtain a minimum and maximum path loss values.

A standard factor of $10 \log_{10} N$, where N = the number of turbines (16.7dB for 47 turbines) to account for cumulative emissions should also be applied.

7.3 MITIGATION REQUIRED

7.3.1 Path Loss comparison

The ITM path loss calculation results of the four sites where the AW 125 TH100A Acciona turbines with modifications as described in the Garob EMC Control Plan [5] to mitigate radiated emissions is shown below:

Frequency [MHz]	Garob (19.65km) [dB]	Copperton (38.18km) [dB]	Aletta (46.25km) [dB]	Graskoppies (53.2km) [dB]
100	109.85	120.7	119.7	123.4
300	Not available	127.7	121.0	130.4
500	113.08	130.5	124.1	133.3
700	Not available	132.2	130.1	135.1
1000	124.65	133.8	141.7	137.0

Table 3: Path loss comparison between sites

7.3.2 Conclusion

Due to natural terrain barriers and the 53.2km distance between Graskoppies and Rem-opt 7, the closest SKA unit, no degradation of performance is expected when the mitigated AW 125 TH100A Acciona turbines are installed. This shown by the 20dB higher path loss for Graskoppies compared to Garob in Table 3

7.4 TESTS AT THE NEW SITE

To verify overall windfarm emissions, ambient measurements should be done at the new site before construction starts. Tests points should be carefully selected based on test equipment sensitivity with the objective to observe the increase in ambient emissions as construction progresses.

7.5 FINAL SITE TESTS

Final site tests will be done on completion of the project to confirm the radiated emission levels. Although not anticipated, proper mitigation measures on identified emitters will be studied and implemented if final test shows emissions exceeding the SKA threshold.



Interference Testing And Consultancy Services (Pty) Ltd

Company Registration number 88/002032/07

Plot 44, Kameeldrift East, 0035, Pretoria

Tel: + 27 (0)12 808 1730

Fax: + 27 (0)12 808 1733

Private Bag X13

LYNN EAST

0039

Republic of South Africa

EVALUATION REPORT

SUBJECT / TEST METHOD / STANDARDS : **CUMULATIVE EFFECT OF LEEUWBERG AND ADJACENT WINDFARMS**

CLIENT / APPLICANT : **MAINSTREAM RENEWABLE POWER**

SITE EVALUATED : **Leeuwborg**

REPORT NUMBER : **R 7152/16**

REVISION : **0.5**

DATE ISSUED : **13/01/2017**

COPY : **Master**

CONFIGURATION CONTROL

**ORIGINAL ONLY
IF THIS NOTE
IS IN RED INK**

This test report was prepared by :

Name: CFH Fouché
Title: Technical Director

This test report was reviewed by :

Name: JJ Joubert
Title: Senior EMC Test Engineer

DISTRIBUTION LIST		
COPY NO	NAME	ORGANISATION
MASTER	CONFIGURATION LIBRARY	Mainstream Renewable Power
1	CONFIGURATION LIBRARY	ITC SERVICES

HISTORY SHEET				
REV	DATE	AUTHOR	PAGES AFFECTED	CHANGE PROPOSAL
1.0	13/01/2017	C Fouche	All	N/A

MAGNETIC ARCHIVE INFORMATION	
DIRECTORY	FILE NAME
C:\Users\Admin\Documents\Projects\ Renewable energy and SKA\Mainstream\	Cumulative effect

LIST OF EFFECTIVE PAGES								CONFIGURATION CONTROL
PAGE	REV	PAGE	REV	PAGE	REV	PAGE	REV	
1	1.0	9	1.0					
2	1.0	10	1.0					
3	1.0	11	1.0					
4	1.0	12	1.0					
5	1.0							
6	1.0							
7	1.0							
8	1.0							

CLIENT INFORMATION	
Name	
Address:	

ACRONYMS AND ABBREVIATIONS

AMN	Artificial Mains Network
AVE	Average
CDN	Coupling/ Decoupling Network
CSIR	Council for Scientific and Industrial Research
E-Fields	Electric Fields
EFT	Electrical Fast Transients
EMC	Electromagnetic Compatibility
EMI	Electromagnetic Interference
ESD	Electrostatic Discharge
EUT	Equipment Under Test
H	Horizontal
HCP	Horizontal Coupling Plane
NIST	National Institute of Science and Technology
NMISA	National Metrology Institute of South Africa
OATS	Open Area Test Site
PC	Personal Computer
QP	Quasi-Peak
RF	Radio Frequency
SANAS	South African National Accreditation System
V	Vertical
VCP	Vertical Coupling Plane

TABLE OF CONTENTS

1. INTRODUCTION	6
2. AREA OF INTEREST	6
3. CALCULATION INFORMATION	7
4. DATA COMPARISONS	7
4.1 NTIA TM-89-139	8
4.2 ITU-R P.372-13: RADIO NOISE	8
4.3 MEASURED URBAN, SUBURBAN, AIRPORT AND RURAL AMBIENT EMISSIONS	9
4.4 MOBILE COMMUNICATION RADIO BASE STATIONS	10
5. CONCLUSION	11
6. REFERENCES	12

LIST OF TABLES

Table 1: Windfarm capacity and number of turbines7

1. INTRODUCTION

The Karoo area is ideally suited for the installation and commissioning of renewable energy projects, but is also host to the Department of Science and Technology’s SKA radio telescope project. Due to the sensitivity of the telescope receivers, there is a risk that unintentional emissions from the systems and associated equipment associated with renewable energy projects will desensitize or saturate the SKA receivers resulting in interference to celestial observations and/or data loss. Such interference is typically referred to as ‘Radio Frequency Interference’ (or ‘RFI’).

2. AREA OF INTEREST

Figure 1: Windfarm areas considered for REM OPT 7 evaluation

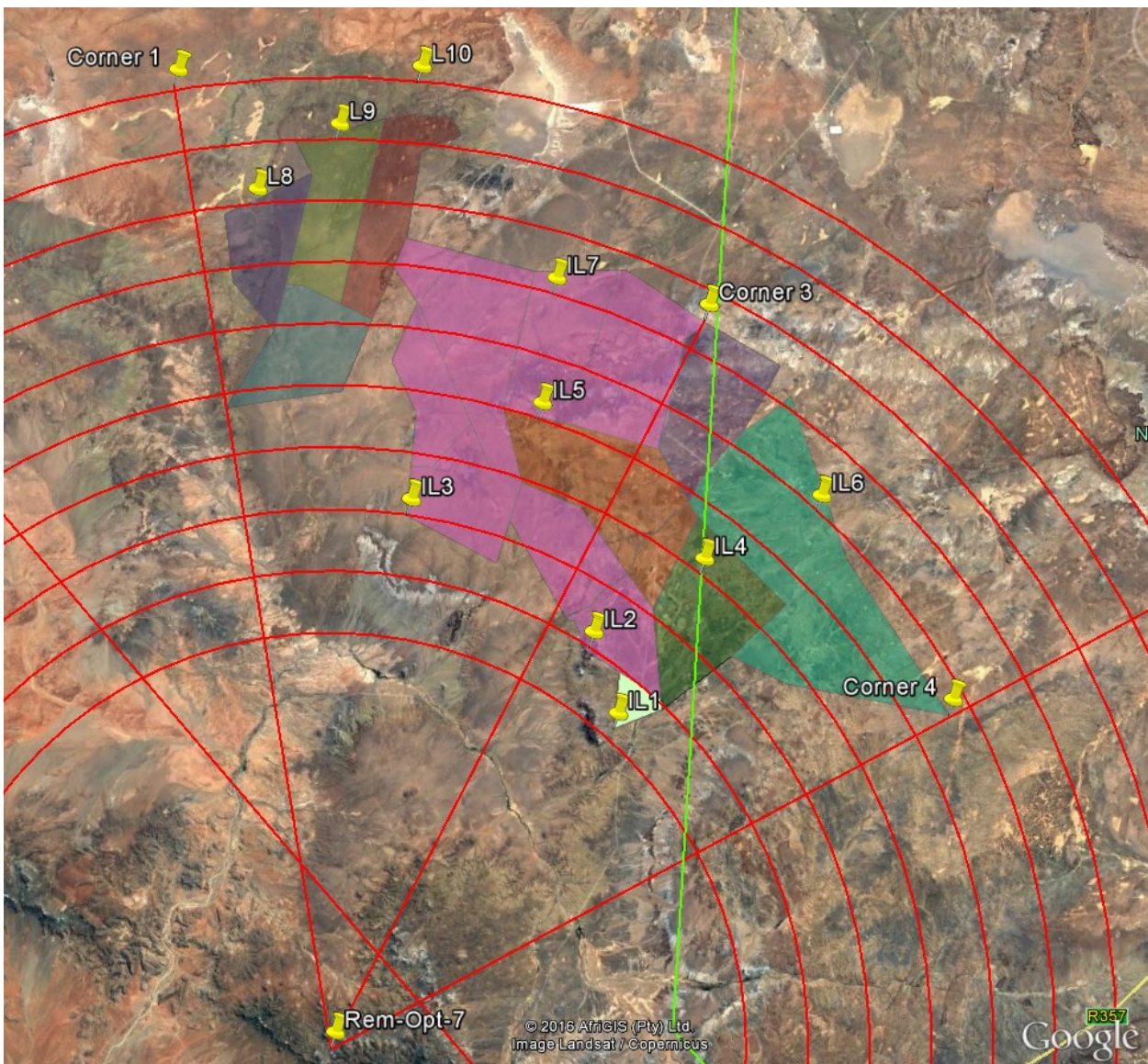

Figure 2: Windfarm areas considered for SKA ID 2377 evaluation

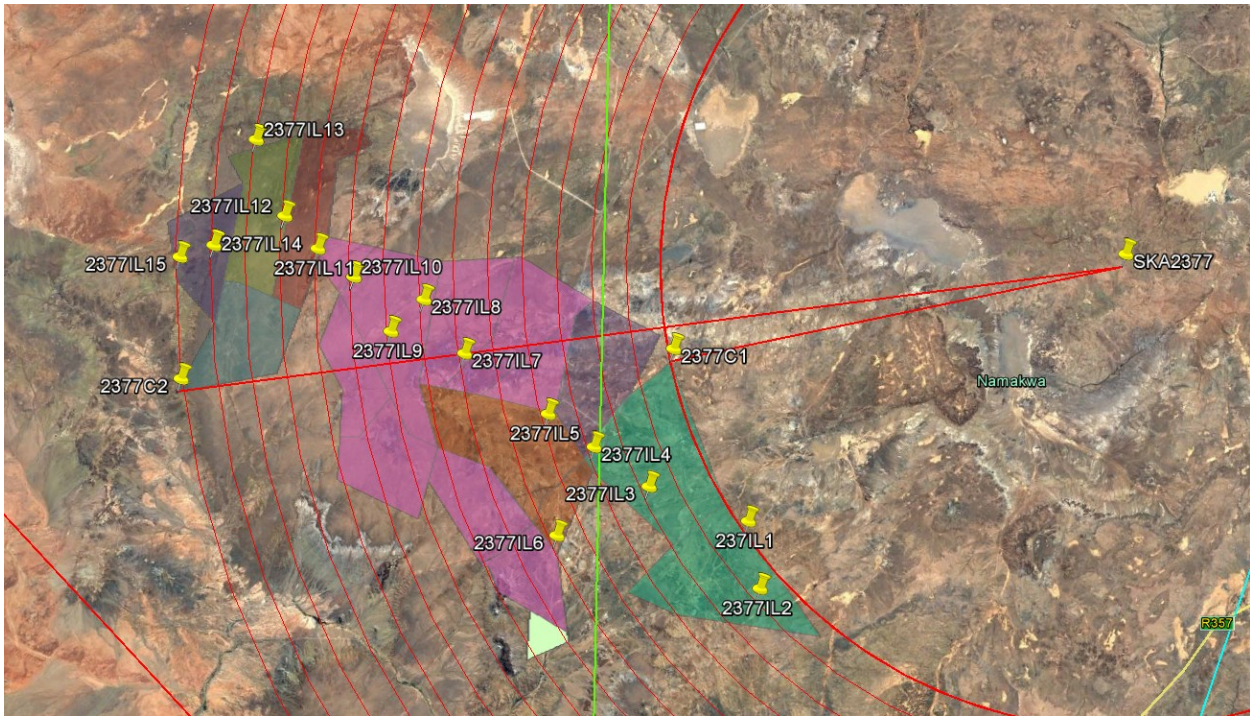

Table 1: Windfarm capacity and number of turbines

Development	Current status of EIA/development	Capacity	No. Turbines
Dwarsrug Wind Farm	Environmental Authorisation issued	140MW	70
Khobab Wind Farm	Environmental Authorisation issued/Approved under RE IPPPP	140MW	61
Loeriesfontein 2 Wind Farm	Environmental Authorisation issued/Approved under RE IPPPP	140MW	61
ACED Kokerboom 1 Wind Farm	EIA ongoing	240MW	60
ACED Kokerboom 2 Wind Farm	EIA ongoing	240MW	60
Graskoppies Wind Farm	EIA ongoing	140MW	47
Hartebeest Leegte	EIA ongoing	140MW	47
Ithemba Wind Farm	EIA ongoing	140MW	47
!Xha Boom Wind Farm	EIA ongoing	140MW	47

3. CALCULATION INFORMATION

A total of 500 mitigated Acciona model AW 125/3000 turbines with a 150m hub height was used for the NTIA TM-89-139 calculations with an inner ring of 30km and outer ring of 70km. This resulted in 10 rings with a spacing of 4.44km between rings.

Path loss was calculated with SPLAT! at 500MHz. Where the software reported parameters that were out of range, the ITU-R Recommendation P.452-15 model as contained in SEAMCAT was used.

4. DATA COMPARISONS

The following factors have an impact on cumulative emissions:

- Number of emitters (emitter density)
- Path loss due to distance and topography

To avoid tedious path loss calculations for 500 emitters and the exact location of each emitter not being known, the NTIA TM-89-139 [2] “Rings” method was used to calculate the expected cumulative amplitude. The

source amplitude of all emitters was assumed to be Acciona mitigated. The levels as described in [1]. Path loss was calculated for each of the rings at the calculated distance from the receiver.

The following definitions apply to Business areas (City), Residential areas, Rural areas and quiet rural areas:

Business areas: any area where the predominant usage throughout the area is for any type of business eg. stores, offices, industrial parks, large shopping centers, main streets or highways etc.

Residential areas (urban or suburban): any area used predominantly for single or multiple dwellings with a density of at least two single family units per 4046 square meter (1 acre) and no large or busy highways.

Rural areas: primarily agricultural or similar purpose with no more than one dwelling per 20234 square meter (5 acres).

The statistical cumulative figure of $10 \cdot \log N$ where N = number of emitters is an overly conservative approach when the emitter number is >63 units. (18dB).

4.1 NTIA TM-89-139 [2]

The 500MHz calculation for the REM Opt 7 location showed an expected increase of 17.9dB when comparing one emitter to 500 emitters and 18.3dB for the SKA ID 2377 location.

4.2 ITU-R P.372-13: RADIO NOISE

When comparing the City (high emitter density) with residential and rural data from ITU-R P.372-13 *Table 3: Outdoor man-made noise measurements in Europe (2006-2007)*, the median noise figure increase for the City environment compared with the residential environment is shown in Figure 3 below. The City median noise figure compared with the residential noise figure as measured in Japan (2009-2011) is also included. Added to Figure 3 is the Hag et al model [3] that is in line with the measured values presented.

Figure 3: Man-made noise measured results (ITU-R P.372-13 Table 3 and Table 4, Hagn eq 8 and 9)

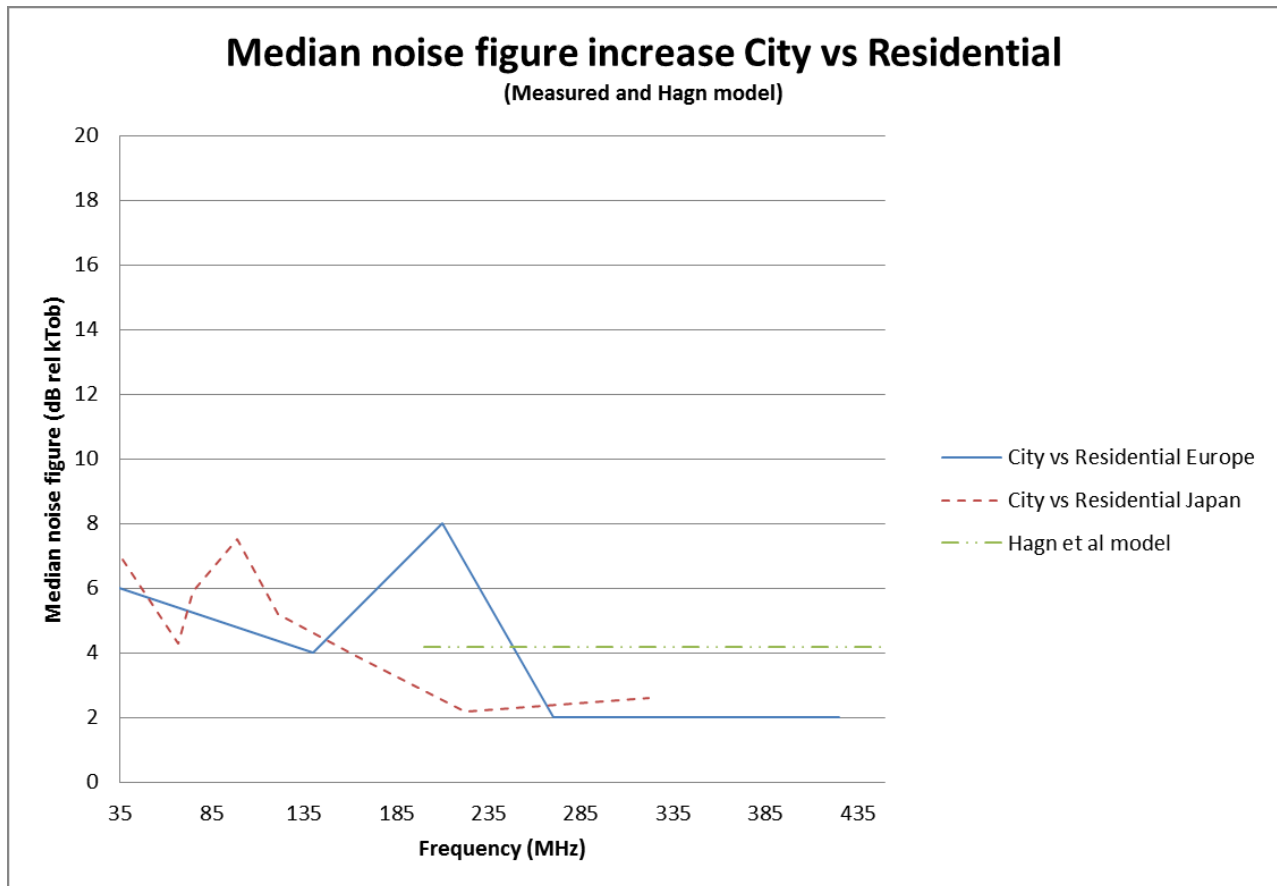

4.3 MEASURED URBAN, SUBURBAN, AIRPORT AND RURAL AMBIENT EMISSIONS

The emitter density in rural areas is much lower than the urban environment. The urban environment ambient level are the highest as expected, however the increase in the measured bands is <10dB for both vertical and horizontal polarisation as shown in [4]

Figure 4: Measured ambient data comparison – Horizontal polarisation

Figure 38 compares the ambient noise levels of each of the sites from an environmental perspective. (The radial axis represents the measured frequency band. The circular axis represents the ambient noise level.)

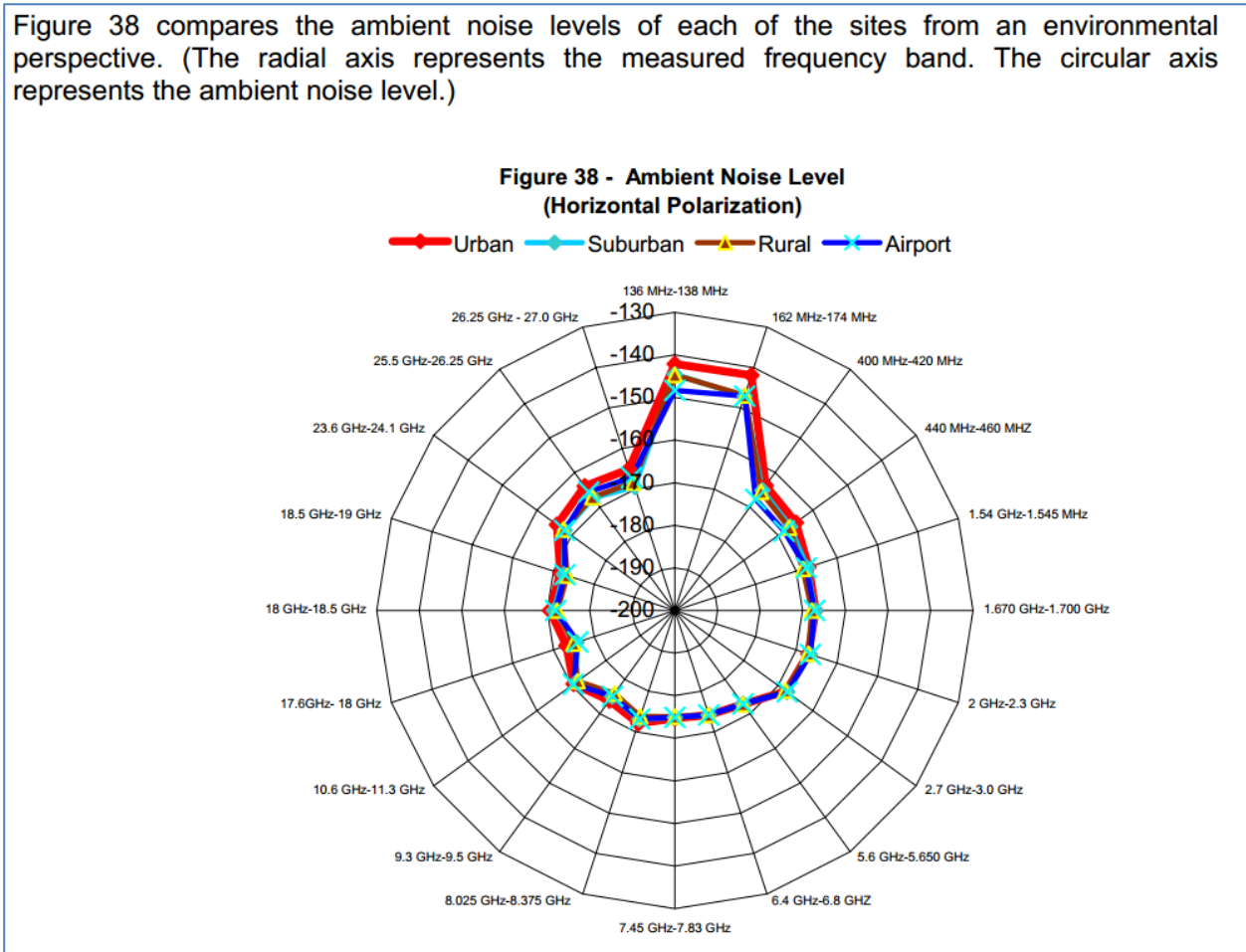

Source: CBS/SG-RFC 2005/Doc. 5(1) WORLD METEOROLOGICAL ORGANIZATION

Figure 5: Measured ambient data comparison – Vertical polarization

Figure 43 compares the ambient noise levels of each of the sites from an environmental perspective. (The radial axis represents the measured frequency band. The circular axis represents the ambient noise level.)

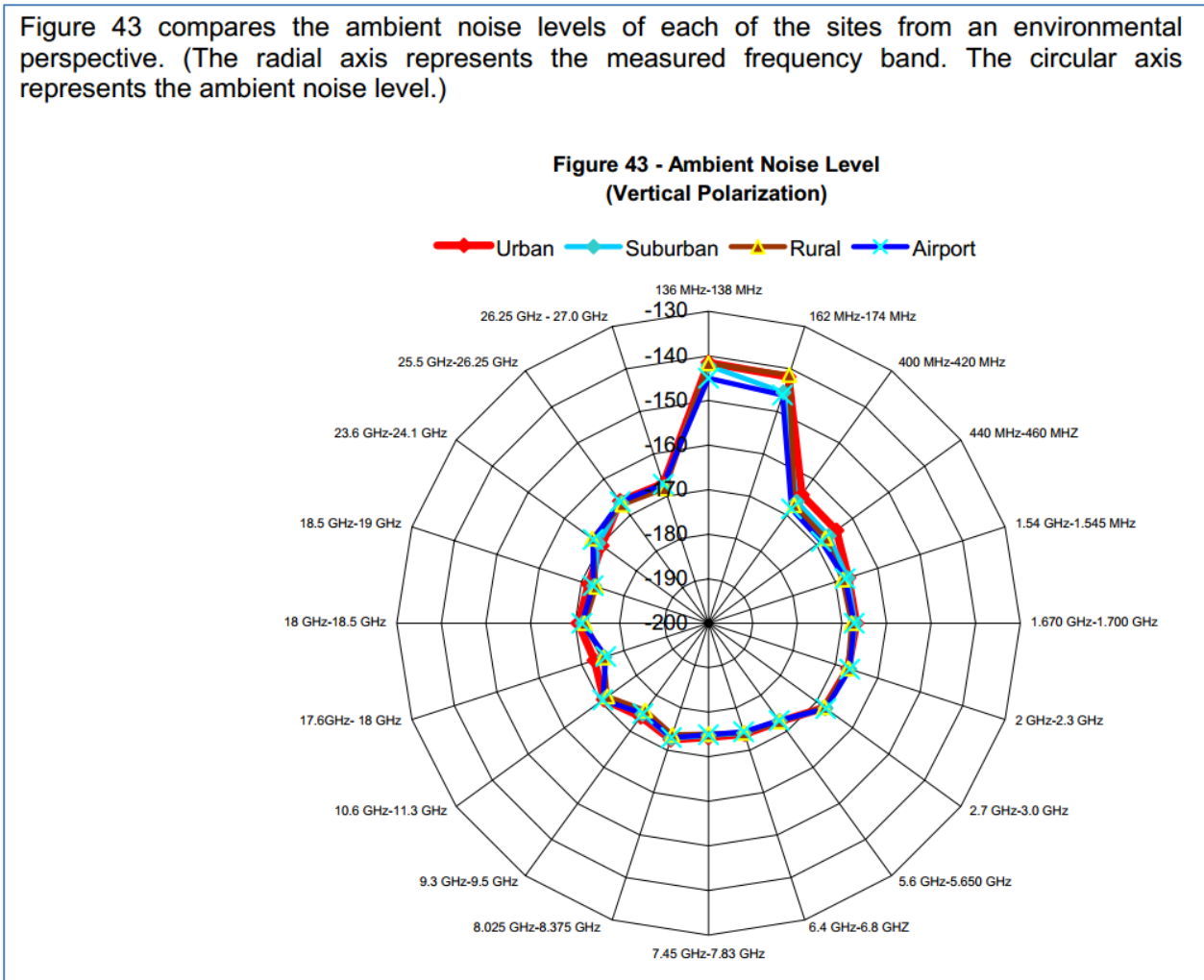

Source: CBS/SG-RFC 2005/Doc. 5(1) WORLD METEOROLOGICAL ORGANIZATION

4.4 MOBILE COMMUNICATION RADIO BASE STATIONS.

From “Comparative international analysis of radiofrequency exposure surveys of mobile communication radio base stations” it was noted that the installation of more base stations did not result in a marked increase in ambient RF levels as shown in Figure 6 below. Although often quoted when investigating cumulative effect of multiple sources, it cannot be used as a case study for wind turbine generators as the service quality that consumers expect requires certain signal strength and the signal strength is regulated by the service providers. This would be a driving factor from industry to maintain ambient levels. The base station density per square kilometer is also less than the WTG sites.

Figure 6: Comparison of ambient data for different years in different countries

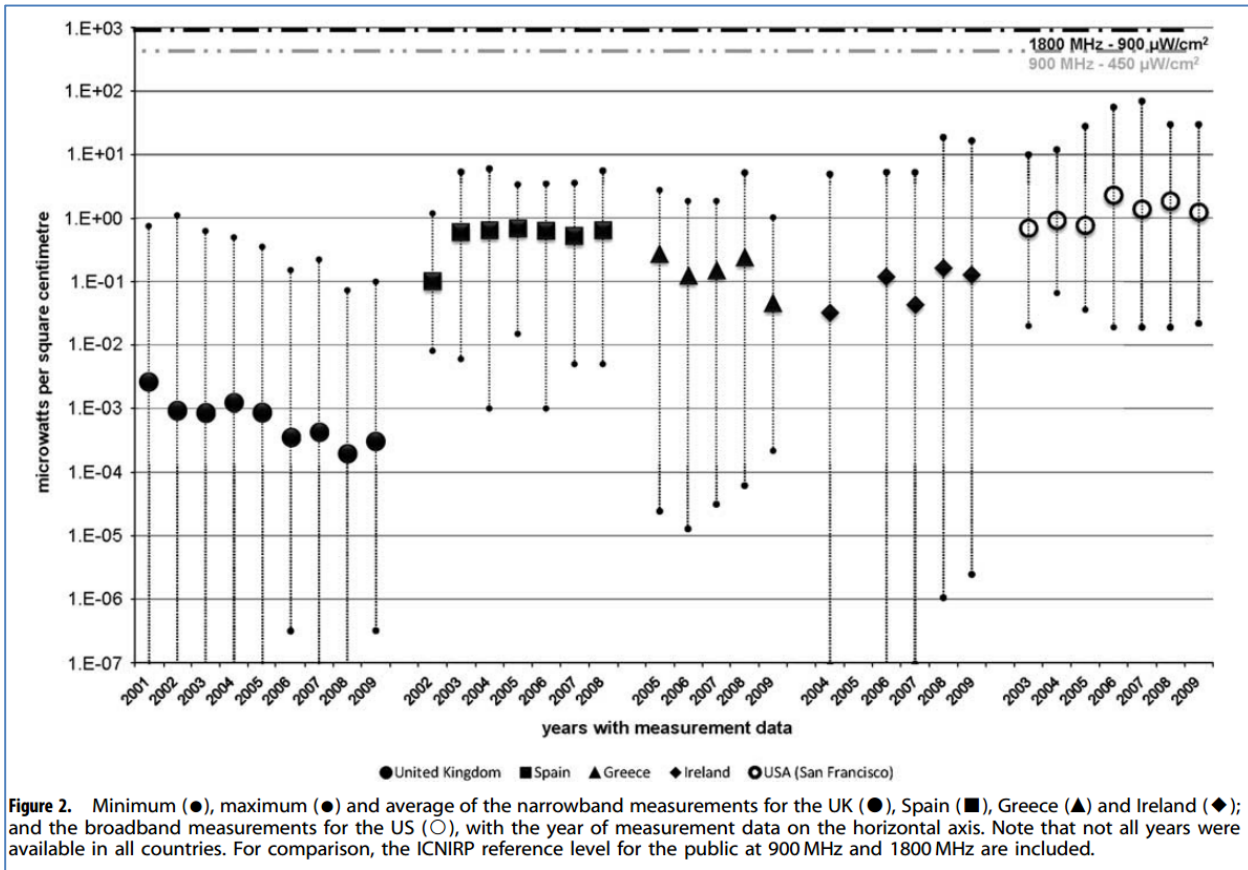

Figure 2. Minimum (●), maximum (●) and average of the narrowband measurements for the UK (●), Spain (■), Greece (▲) and Ireland (◆); and the broadband measurements for the US (○), with the year of measurement data on the horizontal axis. Note that not all years were available in all countries. For comparison, the ICNIRP reference level for the public at 900 MHz and 1800 MHz are included.

Source: Journal of Exposure Science and Environmental Epidemiology (2012), 304-315

5. CONCLUSION

- The NITIA TM-89-139 calculation of 17.9dB (REM OPT 7 location) and 18.4dB (SKA ID 2377 location) to be added to the emissions from a single unit to allow for the cumulative effect of 500 units appears to be conservative when compare to general man-made noise data (<10dB increase measured at various locations).
- The >60 degree beamwidth assumed during the NITIA TM-89-139 calculations will result in over estimation of the cumulative effect due to a higher number of emitters in the beamwidth.
- The 40dB mitigation is a border line figure when considering all the adjacent projects resulting in a relatively high emitter density

6. REFERENCES

- [1] ITC Services CP 1609/16: EMISSION CONTROL PLAN THE AW125 TH100A WTG
- [2] National Telecommunications and Information Administration NTIA TM-89-139: Single and aggregate emission level models for interference analysis
- [3] Naval Ocean System Centre: Techniques for estimating the effects of man-made radio noise on distributed military systems
- [4] World meteorological Organization: Results of Ambient RF environment and noise floor measurements taken in the U.S. in 2004 and 2005



To: Mainstream Renewable Power South Africa
4th Floor Mariendahl House
Newlands on Main
Main Road & Campground Roads
Claremont, Cape Town
7708

18 July 2017

RE: WIND TURBINE PERMUTATIONS

The risk of interference between wind turbines and the SKA radio telescope is primarily a function of the following factors:

- Radiated emission amplitude from turbine
- Turbine hub height
- Number of turbines
- Distance between turbine and SKA infrastructure
- Terrain between the turbine and the SKA infrastructure (line of sight or natural barriers between the installations)

The dB increase in the electromagnetic noise by increasing the number of turbines from 47 units to 70 units can be estimated with the standard $10 \times \log(N)$, where N is the number of turbines, formula as a reasonable assumption. Changing the number of turbines from 47 to 70 will therefore result in a 13.6dB increase in electromagnetic noise.

Increasing the turbine hub height could result in the nacelle being elevated above the natural terrain barriers that provided a shield between the turbine and the SKA infrastructure at a lower hub height. The change in interference risk profile will have to be re-evaluated if the nacelle height is different from the initial proposed height to verify the line of sight/ terrain shielding conditions.

Please do not hesitate to contact me should you need further information.

A handwritten signature in black ink, appearing to read 'Fouche', with a stylized flourish at the end.

CFH Fouche
Technical Director