

# **Appendix A**

## **ENGINEERING BOOKLET**

# Working for Wetlands: Examples of Interventions



*This page was left blank intentionally*

## Contents

<b>1</b>	<b>INTRODUCTION</b>	<b>2</b>
<b>2</b>	<b>PROCESS FOR SELECTION</b>	<b>2</b>
<b>3</b>	<b>TYPICAL INTERVENTIONS</b>	<b>3</b>
3.1	Weirs	3
3.1.1	Concrete weirs	3
3.1.2	Stone masonry weirs	3
3.1.3	Gabion weirs	3
3.2	Earthworks	4
3.2.1	Cut and fill	4
3.2.2	Earth berms	4
3.2.3	Earth plugs	4
3.2.4	Dam walls	4
3.2.5	Roads	4
3.3	Rock packs	4
3.3.1	Rock packs (in channel)	4
3.3.2	Rock packs (on slope)	5
3.4	Road crossings	5
3.5	Biodegradable or natural soil retention systems	5
3.5.1	Brush packs	5
3.5.2	Ecologs	5
3.5.3	MacMat-R	5
3.5.4	Geocells lining	6
3.5.5	Silt fence	6
3.6	Vegetation management	6
3.6.1	Revegetation	6
3.6.2	Alien invasive plant clearing	6
3.7	Alternative measures	6

*This page was left blank intentionally*

## 1 INTRODUCTION

Each year during a Phase 2 planning site visit, a team consisting of an Engineer, a Wetland Specialist, the Working for Wetlands Provincial Coordinator and an Environmental Assessment Practitioner (EAP) plan a series of interventions to rehabilitate a priority wetland. These interventions are selected in a methodological manner, to specifically use the knowledge of the catchment to address the identified wetland problems.

The purpose of this document is to provide an overview of the typical interventions that are designed for the Working for Wetlands Programme. The site-specific details and drawings of the proposed interventions for each planning year will be included in the project rehabilitation plans, which shall be approved by the Department of Environmental Affairs prior to any construction commencing.

## 2 PROCESS FOR SELECTION

The choice of the combination of the most appropriate interventions necessary to achieve a certain rehabilitation objective is a rigorous exercise, and the decision is informed by several criteria.

- **Environmental** – E.g. Hydrology, geology and soils, seasonal influences, vegetation and site-specific constraints;
- **Engineering** – E.g. Biophysical aspects, risk and liability, construction material selection;
- **Social** – E.g. Labour quota requirements, health and safety, availability of materials, skills levels and opportunity for skills development; and
- **Rehabilitation objective(s)** – E.g. Stabilisation of head-cuts and erosion gullies, elevation of water table, eco-services, biodiversity value, sediment trapping eradication of problem species (among others), etc.

From these criteria, the choice is then made to implement either a “hard” or “soft” intervention. Hard engineering intervention may include, for example:

- Earth berms or gabion systems to block artificial channels that drain water from or divert polluted water to the wetland;
- Concrete and gabion weirs to act as settling ponds, to reduce flow velocity or to re-disperse water across former wetland areas thereby re-establishing natural flow paths;
- Earth or gabion structure plugs to raise channel floors and reduce water velocity;
- Concrete or gabion structures to stabilise head-cut or other erosion and prevent gullies;
- Concrete and/or reno mattress strips as road crossings to address channels and erosion in wetlands from vehicles; and
- Gabion structures (mattresses, blankets or baskets) to provide a platform for the growth of desired wetland vegetation.

Soft engineering interventions are often used together with the hard engineering interventions and could include, for example:

- The use of biodegradable or natural soil retention systems such as eco-logs, MacMat-R plant plugs, grass or hay bales, and brush-packing techniques;
- The re-vegetation of stabilised areas with appropriate wetland and riparian plant species;
- Alien invasive plant clearing, which is an important part of wetland rehabilitation (this is supported by the Working for Water Programme).
- The fencing off of sensitive areas within the wetland to keep grazers out and to allow for the re-establishment of vegetation;



- In some instances, the use of appropriate fire management and burning regimes. The removal of undesirable plant and animal species; and

Typical interventions are further described in the following section, and typical engineering drawings are included in Appendix A1.

### 3 TYPICAL INTERVENTIONS

#### 3.1 Weirs

A dam-type structure placed across a watercourse. Weirs are used to address head-cut and/ or channel erosion by trapping sediment and raising the local water table to encourage overland flow (i.e. rewetting a wetland).

##### 3.1.1 Concrete weirs

Concrete is used to construct weirs in high energy areas, such as active headcuts. They are impermeable and effectively trap sediment as well as water, reducing the flow velocity. For this reason, they are also used to raise the local water table. Selection of this intervention depends on the availability of appropriate foundation material and the volume of water moving through the wetland catchment. The construction of concrete weirs also provides an opportunity for skills transfer and development.



##### 3.1.2 Stone masonry weirs

Stone masonry structures are built using an option similar to brickwork. Individual stones are used to build a solid structure using a mixture of cement and sand as the bonding mortar between them. The use of these, as any other hard structure, should be considered in cases where the desired outcomes require the strength of concrete, while at the same time a rougher finish to the surface of the structure or a more natural appearance is desired.



##### 3.1.3 Gabion weirs

Gabion weirs comprise packed stone or rock in wire baskets. The configuration of the gabion baskets can result in the structure performing a similar function to a concrete or stone masonry weir in trapping sediment and reducing flow-velocities. Although gabion basket is permeable and allows for a measure of water to pass through the structure. Vegetation and other biota can also establish in/around the habitat they create. The construction of gabion weirs is more labour intensive than concrete weirs and thus favoured where site conditions are suitable. Some negative aspects associated with gabions: rock is not always readily available, they are vulnerable to vandalism and corrosive elements in some waters; and trampling by cattle and humans (this can be alleviated by concrete capping the gabions).



## 3.2 Earthworks

Earthworks interventions are characterised by their use of earth (soil or rock) that is moved to form features that will restore natural overland flow. All earthworks have a high labour requirement for implementation and are a common intervention in the Working for Wetlands Programme.

### 3.2.1 Cut and fill

Cut and fill is applicable where earth can be moved from one place to another to make the ground more level and restore natural overland flow. An example is in areas which have been impacted by ridge/ furrow farming and involve cutting the “ridges” and filling the “furrows” wherever possible.

### 3.2.2 Earth berms

Earth berms are typically an earth mound used to divert or retain water flow. Berms can be specified across a road to prevent water channelling along the road, or can be used to divert polluted water away from a wetland. Existing berms can also be removed in areas already impacted by farming which have used berms to divert or contain water. Berms are usually considered suitable in low flow areas, but can be susceptible to cattle trampling if not properly vegetated or capped with rocks.



### 3.2.3 Earth plugs

Similar to earth berms (3.2.2), plugs are suitable for low flow areas and involve the plugging of channel floors to reduce the water velocity.



### 3.2.4 Dam walls

Earthen dam walls in areas used for farming can be removed / breached to restore natural flow along a channel.

### 3.2.5 Roads

Old roads can cause impacts within a wetland and can be removed to restore natural overland flow.

## 3.3 Rock packs

The packing of rocks within a channel or across a slope can dissipate energy, slow down water velocity and trap sediment. Rock packing is a labour-intensive practice which is favourable for employment purposes.

### 3.3.1 Rock packs (in channel)

Rock packs in channel are used as sediment traps which slow down flow velocities and prevent erosion in the upstream section of the channel. A filter material such as geofabric is typically incorporated into the rock pack to prevent fine material from moving through it.





### 3.3.2 Rock packs (on slope)

When placed on a slope, rock packs are used to slow run-off and trap sediment to enhance vegetation re-growth.

### 3.4 Road crossings

Road crossings can address deep tracks and numerous channels which form when vehicles travel through a frequently wet area or on a steep slope. These involve either concrete and/or reno mattress strips being laid down as tracks for the vehicles. Reno specifically allows for the flow of water across the tracks which is applicable specifically in low lying areas of a wetland.



### 3.5 Biodegradable or natural soil retention systems

Sometimes biodegradable or natural soil retention systems are used to serve as sediment traps. These allow natural vegetation to establish, and in doing so supports the stabilisation of an area.

#### 3.5.1 Brush packs

Brush packing involves the placing of branches and heavy vegetation on a relatively flat eroded surface to slow down water velocities which in turn promotes sedimentation and increased opportunity for vegetation to re-establish itself. The placing of thorny tree species, such as *Acacia*, also discourages animals from using the area as a pathway.



#### 3.5.2 Ecologs

Ecologs are tightly wrapped cylinders of fibre held together with mesh wire. The fibre is typically derived from coconuts and is bio-degradable. Ecologs are used to stabilise minor watercourses with a relatively minor change in level from the top to the bottom of the slope. They act as small sediment traps and allow natural vegetation to establish in the fibre.



#### 3.5.3 MacMat-R

MacMat-R is a mesh reinforced three-dimensional geomat that is applied for erosion control. The three-dimensional mesh structure traps sediment which in turn promotes the re-establishment of vegetation. MacMat-R is typically applied on a wet exposed face which has a gentle slope across it.



### 3.5.4 Geocells lining

The geocells are used for erosion control, soil stabilization and channel protection. This can be done using concrete or earth infill. The concrete infill is suitable for high inflow channels and earth infill is usually used on low inflow channels.



### 3.5.5 Silt fence

This intervention reduces and stops erosion in dongas with small catchment areas by means of cheap and easily constructed structure. The structure requires vertical posts to be knocked into the ground, followed by netting being draped across and tied firmly to the vertical posts.



## 3.6 Vegetation management

The presence of alien invasive plants, or lack of vegetation cover can have significant impacts on riparian areas as well as the flow of water instream.

### 3.6.1 Revegetation

Revegetation of degraded areas within wetlands using appropriate wetland and riparian plant species can improve the hydrological integrity of the system by stabilising soils and will re-establishing wetland habitat. For each site-specific intervention, the Wetland Specialist will recommend the measures required to revegetate the area (e.g. species, planting requirements, monitoring, etc.).

### 3.6.2 Alien invasive plant clearing

Alien invasive plants affect the ecological functioning of wetlands and therefore clearing is an important part of wetland rehabilitation. Clearing is undertaken in conjunction with the Working for Water Programme which also prioritise job creation and upliftment of local communities.



## 3.7 Alternative measures

In some previous occurrences, alternative measures that add value to the use of the wetland system have been included in the Working for Wetlands Programme, such as:

- Fencing;
- Boardwalks;
- Bird hides;
- Floating wetlands; and
- Fish ladders.

However, as these interventions are generally an exception rather than the rule, more information will be provided on them in the reports in which they are planned for.



# **WORKING FOR WETLANDS**

---

## **Guideline on Generic Intervention Structures for Wetland Rehabilitation Purposes**



# SOFT OPTIONS



DRAWING No.    SHEET No.    DRAWING DESCRIPTION

109664-STD-01	Sheet 1 of 6	LIST OF DETAILS
109664-STD-01	Sheet 2 of 6	ECOLOGS
109664-STD-01	Sheet 3 of 6	ROCK PACKS
109664-STD-01	Sheet 4 of 6	ROAD STRIPS
109664-STD-01	Sheet 5 of 6	BERMS
109664-STD-01	Sheet 6 of 6	MACMAT / MACMAT-R

**NOTES**

- AURECON ACCEPTS RESPONSIBILITY FOR THE ENGINEERING DESIGN TO THE EXTENT THAT THIS IS BASED ON AVAILABLE INFORMATION. THE AVAILABLE INFORMATION IS LIMITED TO WHAT COULD BE INTERPRETED DURING A SINGLE SITE VISIT OF NO LONGER THAN A FEW HOURS. NO GEOTECHNICAL, TOPOGRAPHICAL, GEOMORPHOLOGIC AND OTHER ENGINEERING RELATED SURVEYS HAVE BEEN UNDERTAKEN TO INFORM THE DESIGN. THIS IS NON-STANDARD ENGINEERING PRACTICE AND THEREFORE AURECON IS INDEMNIFIED BY THE CLIENT AND DOES NOT ACCEPT RESPONSIBILITY FOR THE ASSOCIATED RISK OF FAILURE FROM THE ABOVE LIMITATIONS OR ANY DAMAGES THAT MAY OCCUR.
- AURECON IS INDEMNIFIED AGAINST ANY ASSOCIATED DAMAGES AND ACCEPTS NO LIABILITY ASSOCIATED WITH THE CONSTRUCTION AND IMPLEMENTATION OF ENGINEERING INTERVENTIONS DUE TO AURECON HAVING LIMITED CONTACT WITH THE IMPLEMENTER DURING THE CONSTRUCTION PHASE RESULTING IN OUR INABILITY TO DILIGENTLY SUPERVISE AND ASSESS ANY PROGRESS.

**EARTHWORKS/ EARTH STRUCTURES:**

- ALL CUT AND FILL SLOPES TO BE NOT STEEPER THAN 1:4, UNLESS OTHERWISE SPECIFIED.
- ALL EXPOSED DISTURBED SURFACES TO BE REVEGETATED, UNLESS OTHERWISE SPECIFIED. 100mm OF TOP SOIL TO COVER BERM. REVEGETATION TO BE UNDERTAKEN AS PER EMP / REHAB PLAN.
- SOIL FOR BERMS AND BACKFILL TO BE COMPACTED IN 100mm LAYERS AT OPTIMUM WATER CONTENT

**DISPERSIVE SOILS:**  
(ONLY APPLICABLE IN AREAS WITH DISPERSIVE SOILS):

- IT IS CRITICAL TO ENSURE THAT THE FOUNDING SOIL NEVER DRIES OUT AND REMAINS AS UNDISTURBED AS POSSIBLE. THE BASE OF THE INTERVENTION SHOULD THEREFORE BE CONSTRUCTED AS SOON AS A PORTION OF EXCAVATION HAS BEEN FINISHED.
- FILL MATERIAL TO BE GOOD QUALITY, WELL-GRADED GRAVEL OR CLAY (NOT DISPERSIVE CLAY).
- ALL MATERIAL THAT IS EXCAVATED FROM THIS SITE AND RE-USED FOR BACKFILL SHALL BE WELL MIXED WITH 100kg OF LIME PER CUBIC METRE OF SOIL, AND PLACED AND COMPACTED AT OPTIMUM MOISTURE CONTENT.

NOTE: THESE DETAILS MAY BE ADJUSTED TO SUIT INDIVIDUAL SITE CONDITIONS



CLIENT	REV	DATE	REVISION DETAILS	APPROVED	SCALE	SIZE	PRELIMINARY	PROJECT	WORKING FOR WETLANDS
	A	29/10/2013	ISSUED FOR INFORMATION	D.TOWNSHEND	NOT TO SCALE	A4	NOT FOR CONSTRUCTION	TITLE	STANDARD DETAILS
					DRAWN		APPROVED	DESCRIPTION	LIST OF DETAILS
					A.MNYAKA		ENGINEER	DRAWING No.	109664 - STD-01
					DESIGNED		DATE		1 OF 6
					D.TOWNSHEND				REV
					VERIFIED				A
					F.NAGDI				

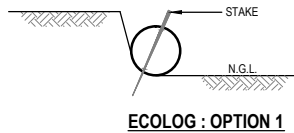

**ECOLOG : OPTION 1**

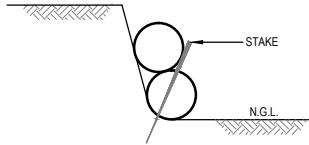

**ECOLOG : OPTION 2**

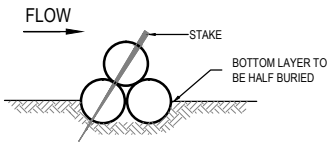

**ECOLOG : OPTION 3**

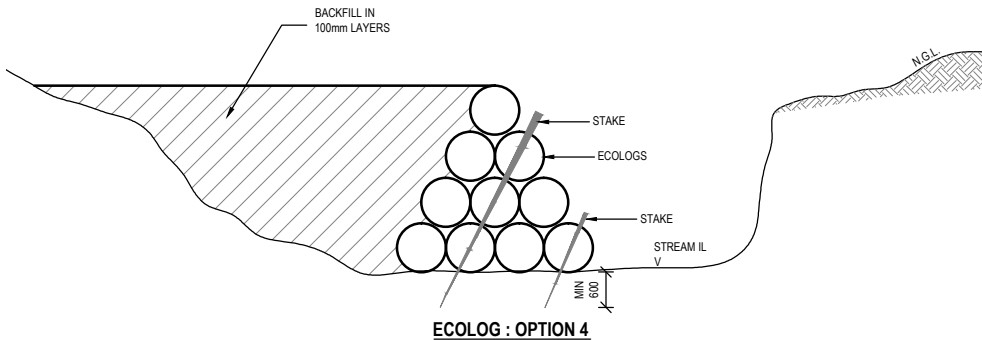

**ECOLOG : OPTION 4**

**NOTES**

- AURECON ACCEPTS RESPONSIBILITY FOR THE ENGINEERING DESIGN TO THE EXTENT THAT THIS IS BASED ON AVAILABLE INFORMATION. THE AVAILABLE INFORMATION IS LIMITED TO WHAT COULD BE INTERPRETED DURING A SINGLE SITE VISIT OF NO LONGER THAN A FEW HOURS. NO GEOTECHNICAL, TOPOGRAPHICAL, GEOMORPHOLOGIC AND OTHER ENGINEERING RELATED SURVEYS HAVE BEEN UNDERTAKEN TO INFORM THE DESIGN. THIS IS NON-STANDARD ENGINEERING PRACTICE AND THEREFORE AURECON IS INDEMNIFIED BY THE CLIENT AND DOES NOT ACCEPT RESPONSIBILITY FOR THE ASSOCIATED RISK OF FAILURE FROM THE ABOVE LIMITATIONS OR ANY DAMAGES THAT MAY OCCUR.
- AURECON IS INDEMNIFIED AGAINST ANY ASSOCIATED DAMAGES AND ACCEPTS NO LIABILITY ASSOCIATED WITH THE CONSTRUCTION AND IMPLEMENTATION OF ENGINEERING INTERVENTIONS DUE TO AURECON HAVING LIMITED CONTACT WITH THE IMPLEMENTER DURING THE CONSTRUCTION PHASE RESULTING IN OUR INABILITY TO DILIGENTLY SUPERVISE AND ASSESS ANY PROGRESS.

**EARTHWORKS/ EARTH STRUCTURES :**

- ALL CUT AND FILL SLOPES TO BE NOT STEEPER THAN 1:4, UNLESS OTHERWISE SPECIFIED.
- ALL EXPOSED DISTURBED SURFACES TO BE REVEGETATED, UNLESS OTHERWISE SPECIFIED. 100mm OF TOP SOIL TO COVER BERM. REVEGETATION TO BE UNDERTAKEN AS PER EMP / REHAB PLAN.
- SOIL FOR BERMS AND BACKFILL TO BE COMPACTED IN 100mm LAYERS AT OPTIMUM WATER CONTENT

**DISPERSIVE SOILS:**  
(ONLY APPLICABLE IN AREAS WITH DISPERSIVE SOILS):

- IT IS CRITICAL TO ENSURE THAT THE FOUNDING SOIL NEVER DRIES OUT AND REMAINS AS UNDISTURBED AS POSSIBLE. THE BASE OF THE INTERVENTION SHOULD THEREFORE BE CONSTRUCTED AS SOON AS A PORTION OF EXCAVATION HAS BEEN FINISHED.
- FILL MATERIAL TO BE GOOD QUALITY, WELL-GRADED GRAVEL OR CLAY (NOT DISPERSIVE CLAY).
- ALL MATERIAL THAT IS EXCAVATED FROM THIS SITE AND RE-USED FOR BACKFILL SHALL BE WELL MIXED WITH 100kg OF LIME PER CUBIC METRE OF SOIL, AND PLACED AND COMPACTED AT OPTIMUM MOISTURE CONTENT.

**ECOLOGS:**

- WOODEN PEGS USED TO ANCHOR ECOLOGS ARE TO BE NO LESS THAN 40mm DIA AND 1000mm IN LENGTH.
- PEGS SHOULD PROTRUDE NO LESS THAN 60mm FROM THE SOIL @ 1000 c/c.

**NOTE: THESE DETAILS MAY BE ADJUSTED TO SUIT INDIVIDUAL SITE CONDITIONS**

CLIENT	REV	DATE	REVISION DETAILS	APPROVED
Working for Wetlands	A	29/10/2013	ISSUED FOR INFORMATION	D.TOWNSHEND

SCALE	SIZE
NOT TO SCALE	A4
DRAWN	
A.MNYAKA	
DESIGNED	
D.TOWNSHEND	
VERIFIED	
F.NAGDI	

PRELIMINARY	DATE
NOT FOR CONSTRUCTION	
APPROVED	
ENGINEER	

PROJECT	TITLE	DESCRIPTION	DRAWING No.	REV
WORKING FOR WETLANDS	STANDARTD DETAILS	ECOLOGS	109664 - STD-01	A
			2 OF 6	

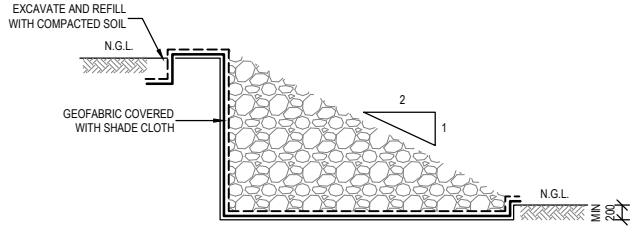

**ROCK PACK : OPTION 1**

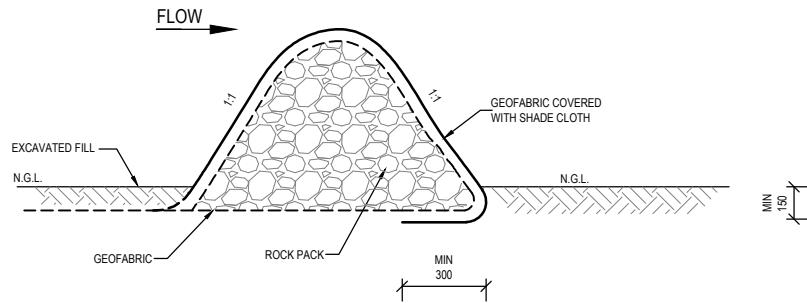

**ROCK PACK : OPTION 2**

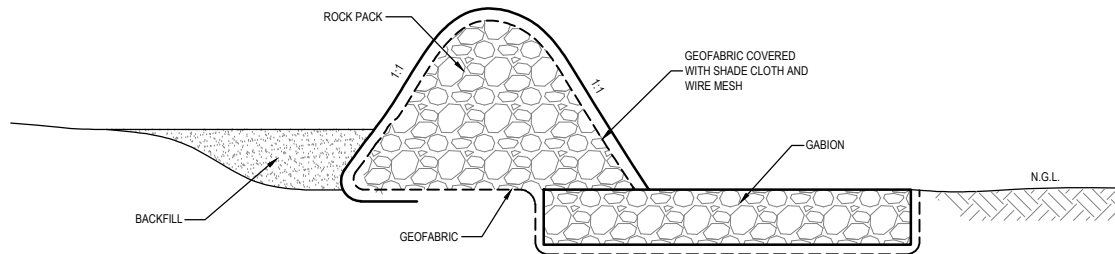

**ROCK PACK : OPTION 3**

**NOTE: THESE DETAILS MAY BE ADJUSTED TO SUIT INDIVIDUAL SITE CONDITIONS**

- NOTES**
- AURECON ACCEPTS RESPONSIBILITY FOR THE ENGINEERING DESIGN TO THE EXTENT THAT THIS IS BASED ON AVAILABLE INFORMATION. THE AVAILABLE INFORMATION IS LIMITED TO WHAT COULD BE INTERPRETED DURING A SINGLE SITE VISIT OF NO LONGER THAN A FEW HOURS. NO GEOTECHNICAL, TOPOGRAPHICAL, GEOMORPHOLOGIC AND OTHER ENGINEERING RELATED SURVEYS HAVE BEEN UNDERTAKEN TO INFORM THE DESIGN. THIS IS NON-STANDARD ENGINEERING PRACTICE AND THEREFORE AURECON IS INDEMNIFIED BY THE CLIENT AND DOES NOT ACCEPT RESPONSIBILITY FOR THE ASSOCIATED RISK OF FAILURE FROM THE ABOVE LIMITATIONS OR ANY DAMAGES THAT MAY OCCUR.
  - AURECON IS INDEMNIFIED AGAINST ANY ASSOCIATED DAMAGES AND ACCEPTS NO LIABILITY ASSOCIATED WITH THE CONSTRUCTION AND IMPLEMENTATION OF ENGINEERING INTERVENTIONS DUE TO AURECON HAVING LIMITED CONTACT WITH THE IMPLEMENTER DURING THE CONSTRUCTION PHASE RESULTING IN OUR INABILITY TO DILIGENTLY SUPERVISE AND ASSESS ANY PROGRESS.

- EARTHWORKS/ EARTH STRUCTURES:**
- ALL CUT AND FILL SLOPES TO BE NOT STEEPER THAN 1:4, UNLESS OTHERWISE SPECIFIED.
  - ALL EXPOSED DISTURBED SURFACES TO BE REVEGETATED, UNLESS OTHERWISE SPECIFIED. 100mm OF TOP SOIL TO COVER BERM. REVEGETATION TO BE UNDERTAKEN AS PER EMP / REHAB PLAN.
  - SOIL FOR BERMS AND BACKFILL TO BE COMPACTED IN 100mm LAYERS AT OPTIMUM WATER CONTENT

- DISPERSIVE SOILS:**  
(ONLY APPLICABLE IN AREAS WITH DISPERSIVE SOILS):
- IT IS CRITICAL TO ENSURE THAT THE FOUNDING SOIL NEVER DRIES OUT AND REMAINS AS UNDISTURBED AS POSSIBLE. THE BASE OF THE INTERVENTION SHOULD THEREFORE BE CONSTRUCTED AS SOON AS A PORTION OF EXCAVATION HAS BEEN FINISHED.
  - FILL MATERIAL TO BE GOOD QUALITY, WELL-GRADED GRAVEL OR CLAY (NOT DISPERSIVE CLAY).
  - ALL MATERIAL THAT IS EXCAVATED FROM THIS SITE AND RE-USED FOR BACKFILL SHALL BE WELL MIXED WITH 100kg OF LIME PER CUBIC METRE OF SOIL, AND PLACED AND COMPACTED AT OPTIMUM MOISTURE CONTENT.

- ROCK PACKS:**
- 100mm -200mm STONE TO BE USED IN ROCK PACKS
  - STONE MUST BE NON-FRILABLE AND INSOLUBLE, e.g. GRANITE, BASALT, LIMESTONE OR SANDSTONE
  - ROCK PACKS PLACED ACROSS A STREAM TO BE TIED MIN 1m INTO EACH BANK.

CLIENT	REV	DATE	REVISION DETAILS	APPROVED
Working for Wetlands	A	29/10/2013	ISSUED FOR INFORMATION	D.TOWNSHEND

SCALE	SIZE
NOT TO SCALE	A4
DRAWN	
A.MNYAKA	
DESIGNED	
D.TOWNSHEND	
VERIFIED	
F.NAGDI	

PRELIMINARY	DATE
NOT FOR CONSTRUCTION	
APPROVED	
ENGINEER	

PROJECT	TITLE	DESCRIPTION	DRAWING No.	REV
WORKING FOR WETLANDS	STANDARTD DETAILS	ROCK PACKS	109664 - STD-01	A
			3 OF 6	

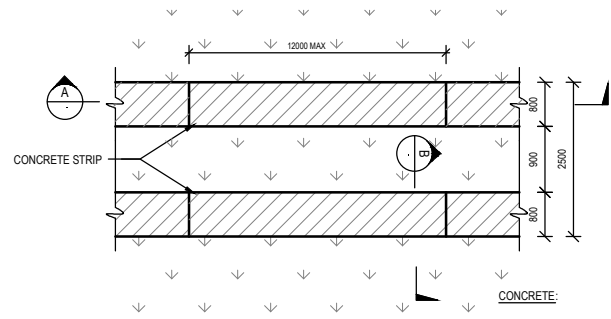

**PLAN OF CONCRETE STRIP**

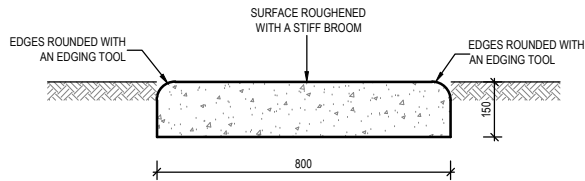

**SECTION B** (CONCRETE STRIP)  
1:20

- CONCRETE:**
- ALL BUTTRESS WEIR STRUCTURES TO USE MIN 20MPa CONCRETE MIX:  
1 BAG CEMENT  
95L SAND  
100L STONE  
27L WATER

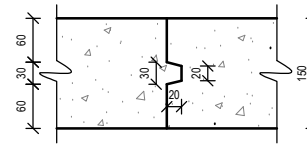

**DETAIL 1** (SCHEMATIC VIEW OF JOINT BETWEEN PANELS)  
1:10

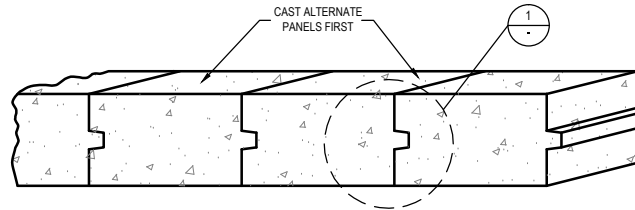

**SECTION A** (SCHEMATIC VIEW OF JOINT BETWEEN PANELS)  
1:10

**NOTE: THESE DETAILS MAY BE ADJUSTED TO SUIT INDIVIDUAL SITE CONDITIONS**

**NOTES**

- AURECON ACCEPTS RESPONSIBILITY FOR THE ENGINEERING DESIGN TO THE EXTENT THAT THIS IS BASED ON AVAILABLE INFORMATION. THE AVAILABLE INFORMATION IS LIMITED TO WHAT COULD BE INTERPRETED DURING A SINGLE SITE VISIT OF NO LONGER THAN A FEW HOURS. NO GEOTECHNICAL, TOPOGRAPHICAL, GEOMORPHOLOGIC AND OTHER ENGINEERING RELATED SURVEYS HAVE BEEN UNDERTAKEN TO INFORM THE DESIGN. THIS IS NON-STANDARD ENGINEERING PRACTICE AND THEREFORE AURECON IS INDEMNIFIED BY THE CLIENT AND DOES NOT ACCEPT RESPONSIBILITY FOR THE ASSOCIATED RISK OF FAILURE FROM THE ABOVE LIMITATIONS OR ANY DAMAGES THAT MAY OCCUR.
- AURECON IS INDEMNIFIED AGAINST ANY ASSOCIATED DAMAGES AND ACCEPTS NO LIABILITY ASSOCIATED WITH THE CONSTRUCTION AND IMPLEMENTATION OF ENGINEERING INTERVENTIONS DUE TO AURECON HAVING LIMITED CONTACT WITH THE IMPLEMENTER DURING THE CONSTRUCTION PHASE RESULTING IN OUR INABILITY TO DILIGENTLY SUPERVISE AND ASSESS ANY PROGRESS.

**EARTHWORKS/ EARTH STRUCTURES:**

- ALL CUT AND FILL SLOPES TO BE NOT STEEPER THAN 1:4, UNLESS OTHERWISE SPECIFIED.
- ALL EXPOSED DISTURBED SURFACES TO BE REVEGETATED, UNLESS OTHERWISE SPECIFIED. 100mm OF TOP SOIL TO COVER BERM. REVEGETATION TO BE UNDERTAKEN AS PER EMP / REHAB PLAN.
- SOIL FOR BERMS AND BACKFILL TO BE COMPACTED IN 100mm LAYERS AT OPTIMUM WATER CONTENT

**DISPERSIVE SOILS:**  
(ONLY APPLICABLE IN AREAS WITH DISPERSIVE SOILS):

- IT IS CRITICAL TO ENSURE THAT THE FOUNDING SOIL NEVER DRIES OUT AND REMAINS AS UNDISTURBED AS POSSIBLE. THE BASE OF THE INTERVENTION SHOULD THEREFORE BE CONSTRUCTED AS SOON AS A PORTION OF EXCAVATION HAS BEEN FINISHED.
- FILL MATERIAL TO BE GOOD QUALITY, WELL-GRADED GRAVEL OR CLAY (NOT DISPERSIVE CLAY).
- ALL MATERIAL THAT IS EXCAVATED FROM THIS SITE AND RE-USED FOR BACKFILL SHALL BE WELL MIXED WITH 100kg OF LIME PER CUBIC METRE OF SOIL, AND PLACED AND COMPACTED AT OPTIMUM MOISTURE CONTENT.

CLIENT	REV	DATE	REVISION DETAILS	APPROVED	SCALE	SIZE	PRELIMINARY	PROJECT	WORKING FOR WETLANDS
	A	29/10/2013	ISSUED FOR INFORMATION	D.TOWNSHEND	NOT TO SCALE	A4	NOT FOR CONSTRUCTION		
					DRAWN		APPROVED	TITLE	STANDARTD DETAILS
					A.MNYAKA		ENGINEER	DESCRIPTION	ROAD STRIPS
					DESIGNED		DATE	DRAWING No.	109664 - STD-01
					D.TOWNSHEND				4 OF 6
					VERIFIED				REV
					F.NAGDI				A



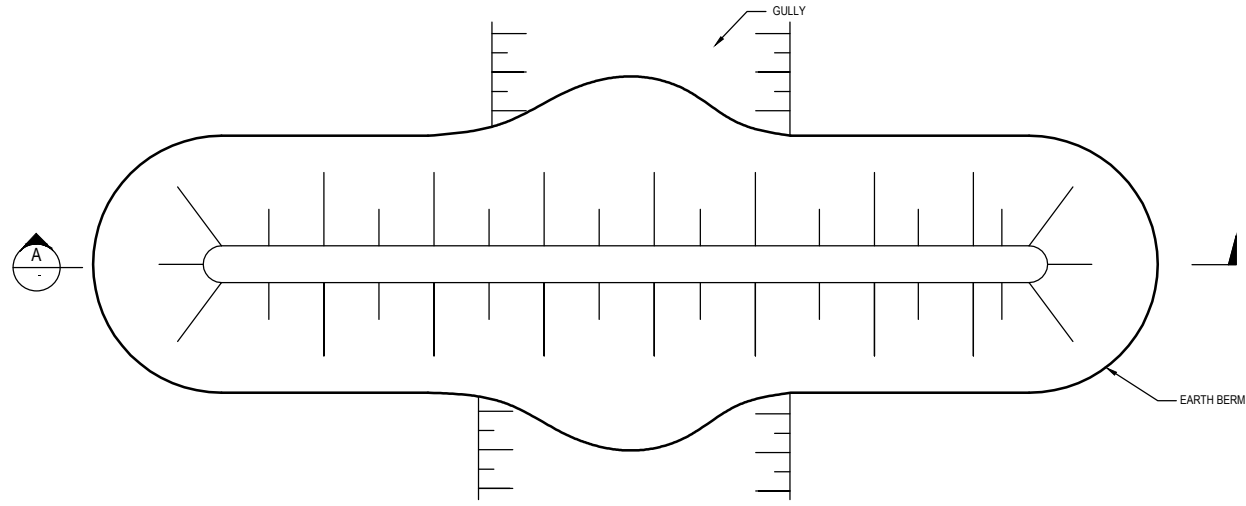

**TYPICAL PLAN VIEW OF BERM**

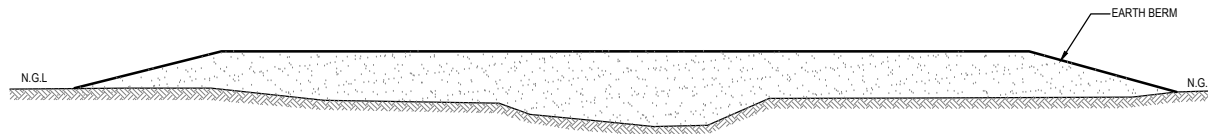

**LONG SECTION THROUGH BERM**

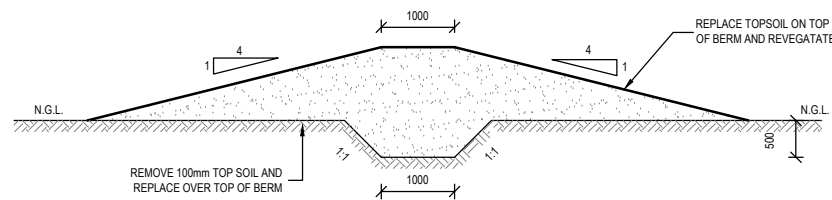

**TYPICAL CROSS SECTION THROUGH BERM**

**NOTE: THESE DETAILS MAY BE ADJUSTED TO SUIT INDIVIDUAL SITE CONDITIONS**

- NOTES**
- AURECON ACCEPTS RESPONSIBILITY FOR THE ENGINEERING DESIGN TO THE EXTENT THAT THIS IS BASED ON AVAILABLE INFORMATION. THE AVAILABLE INFORMATION IS LIMITED TO WHAT COULD BE INTERPRETED DURING A SINGLE SITE VISIT OF NO LONGER THAN A FEW HOURS. NO GEOTECHNICAL, TOPOGRAPHICAL, GEOMORPHOLOGIC AND OTHER ENGINEERING RELATED SURVEYS HAVE BEEN UNDERTAKEN TO INFORM THE DESIGN. THIS IS NON-STANDARD ENGINEERING PRACTICE AND THEREFORE AURECON IS INDEMNIFIED BY THE CLIENT AND DOES NOT ACCEPT RESPONSIBILITY FOR THE ASSOCIATED RISK OF FAILURE FROM THE ABOVE LIMITATIONS OR ANY DAMAGES THAT MAY OCCUR.
  - AURECON IS INDEMNIFIED AGAINST ANY ASSOCIATED DAMAGES AND ACCEPTS NO LIABILITY ASSOCIATED WITH THE CONSTRUCTION AND IMPLEMENTATION OF ENGINEERING INTERVENTIONS DUE TO AURECON HAVING LIMITED CONTACT WITH THE IMPLEMENTER DURING THE CONSTRUCTION PHASE RESULTING IN OUR INABILITY TO DILIGENTLY SUPERVISE AND ASSESS ANY PROGRESS.

- EARTHWORKS/ EARTH STRUCTURES:**
- ALL CUT AND FILL SLOPES TO BE NOT STEEPER THAN 1:4, UNLESS OTHERWISE SPECIFIED.
  - ALL EXPOSED DISTURBED SURFACES TO BE REVEGETATED, UNLESS OTHERWISE SPECIFIED. 100mm OF TOP SOIL TO COVER BERM. REVEGETATION TO BE UNDERTAKEN AS PER EMP / REHAB PLAN.
  - SOIL FOR BERMS AND BACKFILL TO BE COMPACTED IN 100mm LAYERS AT OPTIMUM WATER CONTENT

- DISPERSIVE SOILS:**  
(ONLY APPLICABLE IN AREAS WITH DISPERSIVE SOILS):
- IT IS CRITICAL TO ENSURE THAT THE FOUNDING SOIL NEVER DRIES OUT AND REMAINS AS UNDISTURBED AS POSSIBLE. THE BASE OF THE INTERVENTION SHOULD THEREFORE BE CONSTRUCTED AS SOON AS A PORTION OF EXCAVATION HAS BEEN FINISHED.
  - FILL MATERIAL TO BE GOOD QUALITY, WELL-GRADED GRAVEL OR CLAY (NOT DISPERSIVE CLAY).
  - ALL MATERIAL THAT IS EXCAVATED FROM THIS SITE AND RE-USED FOR BACKFILL SHALL BE WELL MIXED WITH 100kg OF LIME PER CUBIC METRE OF SOIL, AND PLACED AND COMPACTED AT OPTIMUM MOISTURE CONTENT.

CLIENT	REV	DATE	REVISION DETAILS	APPROVED	SCALE	SIZE	PRELIMINARY	PROJECT	WORKING FOR WETLANDS
	A	29/10/2013	ISSUED FOR INFORMATION	D.TOWNSHEND	NOT TO SCALE	A4	NOT FOR CONSTRUCTION		
					DRAWN		APPROVED	TITLE	STANDARTD DETAILS
					A.MNYAKA		ENGINEER	DESCRIPTION	BERMS
					DESIGNED		DATE	DRAWING No.	109664 - STD-01
					D.TOWNSHEND				5 OF 6
					VERIFIED				REV
					F.NAGDI				A





# HARD OPTIONS

**NOTE: CONFIGURATION AND DIMENSIONS OF STRUCTURE VARY ACCORDING TO SITE CONDITIONS**

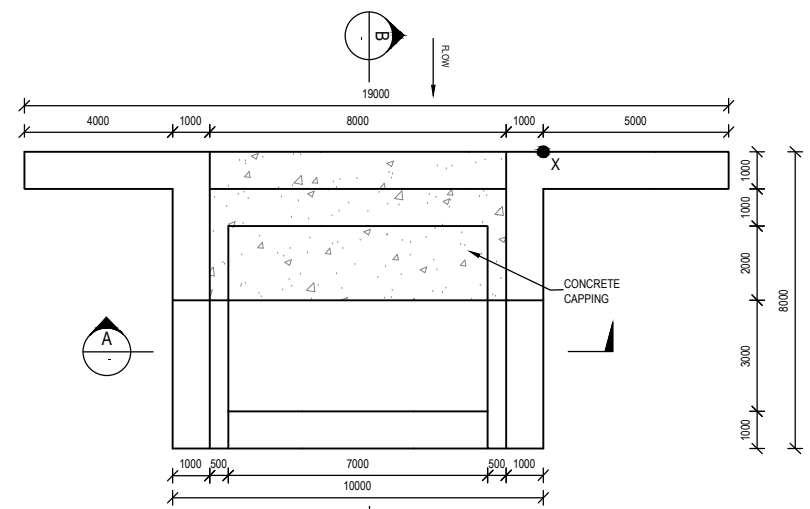

**LAYOUT**  
N.T.S.

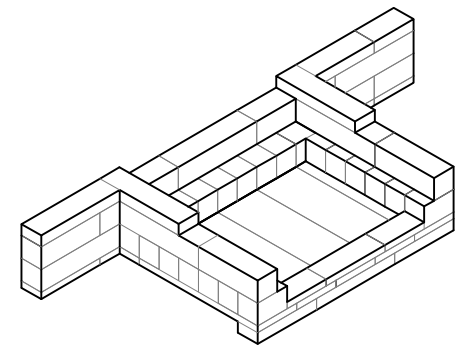

**3D VIEW**  
N.T.S.

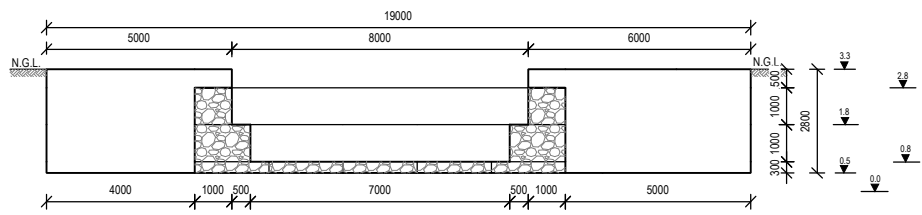

**SECTION A**  
N.T.S.

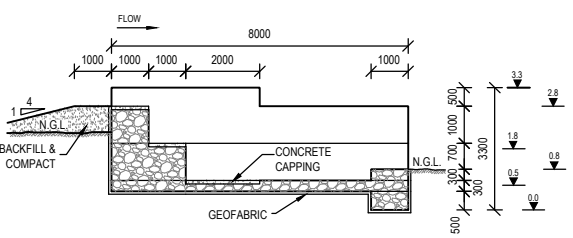

**SECTION B**  
N.T.S.

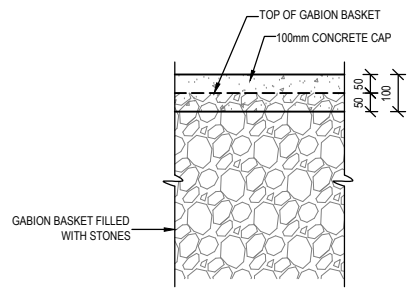

**CONCRETE CAPPING DETAIL**  
N.T.S.

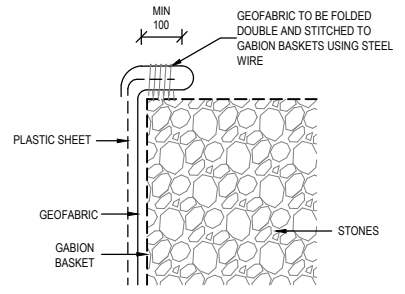

**GEOFABRIC AND PLASTIC STITCHING DETAIL**  
N.T.S.

**NOTES**

- AURECON ACCEPTS RESPONSIBILITY FOR THE ENGINEERING DESIGN TO THE EXTENT THAT THIS IS BASED ON AVAILABLE INFORMATION. THE AVAILABLE INFORMATION IS LIMITED TO WHAT COULD BE INTERPRETED DURING A SINGLE SITE VISIT OF NO LONGER THAN A FEW HOURS. NO GEOTECHNICAL, TOPOGRAPHICAL, GEOMORPHOLOGIC AND OTHER ENGINEERING RELATED SURVEYS HAVE BEEN UNDERTAKEN TO INFORM THE DESIGN. THIS IS NON-STANDARD ENGINEERING PRACTICE AND THEREFORE AURECON IS INDEMNIFIED BY THE CLIENT AND DOES NOT ACCEPT RESPONSIBILITY FOR THE ASSOCIATED RISK OF FAILURE FROM THE ABOVE LIMITATIONS OR ANY DAMAGES THAT MAY OCCUR.
- AURECON IS INDEMNIFIED AGAINST ANY ASSOCIATED DAMAGES AND ACCEPTS NO LIABILITY ASSOCIATED WITH THE CONSTRUCTION AND IMPLEMENTATION OF ENGINEERING INTERVENTIONS DUE TO AURECON HAVING LIMITED CONTACT WITH THE IMPLEMENTER DURING THE CONSTRUCTION PHASE RESULTING IN OUR INABILITY TO DILIGENTLY SUPERVISE AND ASSESS ANY PROGRESS.

**EARTHWORKS/ EARTH STRUCTURES :**

- ALL CUT AND FILL SLOPES TO BE NOT STEEPER THAN 1:4, UNLESS OTHERWISE SPECIFIED.
- ALL EXPOSED DISTURBED SURFACES TO BE REVEGETATED, UNLESS OTHERWISE SPECIFIED. 100mm OF TOP SOIL TO COVER BERM. REVEGETATION TO BE UNDERTAKEN AT SUITABLE TIMING OF YEAR TO IMPROVE CHANCES OF TAKING.
- SOIL FOR BERMS AND BACKFILL TO BE COMPACTED IN 100mm LAYERS AT OPTIMUM WATER CONTENT

**DISPERSIVE SOILS:**

(ONLY APPLICABLE IN AREAS WITH DISPERSIVE SOILS):

- IT IS CRITICAL TO ENSURE THAT THE FOUNDING SOIL NEVER DRIES OUT AND REMAINS AS UNDISTURBED AS POSSIBLE. THE BASE OF THE INTERVENTION SHOULD THEREFORE BE CONSTRUCTED AS SOON AS A PORTION OF EXCAVATION HAS BEEN FINISHED.
- FILL MATERIAL TO BE GOOD QUALITY, WELL-GRADED GRAVEL OR CLAY (NOT DISPERSIVE CLAY FOUND IN PARTS OF THE FLOOD PLAIN).
- ALL MATERIAL THAT IS EXCAVATED FROM THIS SITE AND RE-USED FOR BACKFILL SHALL BE WELL MIXED WITH 100kg OF LIME PER CUBIC METRE OF SOIL, AND PLACED AND COMPACTED AT OPTIMUM MOISTURE CONTENT.

**GABIIONS:**

- GABION BASKETS AND RENO MATTRESSES TO BE CONSTRUCTED OF DOUBLE TWISTED, HEXAGONAL, PVC COATED, GALVANISED WIRE MESH OF NOMINAL DIAMETER 80mm MESH, WITH 3.4mm o/d FRAME WIRE AND 2.7mm o/d MESH WIRE WITH PARTITIONS AT 1m CENTRES.
- GEOFABRIC TO BE NON-WOVEN, NOT LESS THAN 195g/m<sup>2</sup>, e.g. AG200.
- 100mm - 200mm STONE TO BE USED IN ALL GABIIONS AND RENO MATTRESSES. STONE FILL MUST BE NON-FRIABLE & INSOLUBLE e.g. GRANITE, BASALT, LIMESTONE OR SANDSTONE.
- ALL GABIIONS AND RENO MATTRESSES TO COMPLY WITH SANS-1200-DK.
- CONCRETE CAPPING TO BE MINIMUM 15MPa & MIX: 1 BAG CEMENT, 125L SAND, 120L STONE, 30L WATER
- GEOFABRIC TO BE INSERTED AT ALL SOIL/MESH INTERFACES UNLESS OTHERWISE SPECIFIED.
- GEOFABRIC TO HAVE WEEPHOLES PUNCHED THROUGH USING 10mm STEEL ROD AT APPROXIMATELY 4 HOLES/m<sup>2</sup>.
- 250µ PLASTIC SHEET TO BE USED ON THE UPSTREAM FACE OF ALL STRUCTURES UNLESS OTHERWISE SPECIFIED



CLIENT	REV	DATE	REVISION DETAILS	APPROVED	SCALE	SIZE
Working for Wetlands	A	06/11/2013	ISSUED FOR INFORMATION	D.TOWNSHEND	NOT TO SCALE	A4
					DRAWN	
					A.MNYAKA	
					DESIGNED	
					D.TOWNSHEND	
					VERIFIED	
					F.NAGDI	

PRELIMINARY NOT FOR CONSTRUCTION	
APPROVED	DATE
ENGINEER	

PROJECT	WORKING FOR WETLANDS
PROVINCE	
INTERVENTION DESCRIPTION	TYPICAL : GABION WEIR
DRAWING No.	109664 - STD - 20



