

## Organs of State Correspondence

Project announcement  
(Background Information Document)

13 July 2020

Dear Stakeholder and Interested and/or Affected Party,

## **DEVELOPMENT OF GEELSTERT 1 AND GEELSTERT 2 SOLAR PV FACILITIES AND GEELSTERT GRID CONNECTION, NEAR AGGENEYS, NORTHERN CAPE**

---

### **NOTICE OF BASIC ASSESSMENT AND PUBLIC PARTICIPATION PROCESS**

---

The development of two separate solar photovoltaic (PV) facilities, each with a contracted capacity of up to 125MW, and associated grid connection is proposed on a site located approximately 11km south-east of the town of Aggeneys in the Northern Cape Province. The two solar PV facilities are to be known as Geelstert 1 and Geelstert 2. The grid connection solution will be known as Geelstert Grid Connection. The projects are situated within the Khâi-Ma Local Municipality, in the greater Namakwa District Municipality.

The two solar PV facilities are located on the Remaining Extent of the Farm Bloemhoek 61 and will be connected to the Aggeneys Main Transmission Substation (MTS). The grid connection will include a collector substation and a double-circuit power line of up to 220kV. The grid connection will traverse six (6) properties which include:

Remaining Extent of the Farm Bloemhoek 61	Remaining Extent of the Farm Aggeneys 56
Portion 1 of the Farm Aggeneys 56	Portion 2 of the Farm Aggeneys 56
Portion 12 of the Farm Aggeneys 56	Portion 13 of the Farm Aggeneys 56

It is the Developer's intention to bid each solar PV facility under the Department of Mineral Resources and Energy's<sup>1</sup> Renewable Energy Independent Power Producer Procurement (REIPPP) Programme. The power generated from each solar PV facility will be sold to Eskom and fed into the national electricity grid through the proposed grid connection. The development of the solar PV facilities and the grid connection will assist with the achievement of the electricity goals as set out in the Integrated Resources Plan (IRP), 2019.

The study area is located within Zone 8 of the Renewable Energy Development Zones (REDZ) (also known as the Springbok REDZ).

---

<sup>1</sup> The Department of Mineral Resources and Energy is a merge between the Department of Mineral Resources (DMR) and the Department of Energy (DoE).

The applicant for each of the solar PV facilities will be a separate Special Purpose Vehicles (SPV). The applicant for Geelstert 1 is Geelstert Solar Facility 1, and the applicant for Geelstert 2 is Geelstert Solar Facility 2 (Pty) Ltd. The applicant for the Geelstert Grid Connection is ABO Wind renewable energies (Pty) Ltd. Three (3) separate Applications for Environmental Authorisation will be submitted to the Department of Environmental Affairs (DEA).

Infrastructure associated with each solar PV facility will include:

- » Solar PV panels.
- » Centralised inverter stations or string inverters.
- » Cabling between the panels, to be laid underground where practical.
- » An on-site facility substation to facilitate the connection between the solar PV facility and the Eskom electricity grid.
- » Site offices and maintenance buildings, including workshop areas for maintenance and storage.
- » Temporary laydown areas.
- » Internal access roads and fencing around the development area.

The Geelstert Grid Connection will be assessed within a grid connection corridor within which grid connection infrastructure will be developed. The grid connection will include a collector substation and an overhead power line with a capacity of up to 220kV, connecting the facilities to the Aggeneis MTS.

Site-specific studies and assessments will be undertaken through the BA processes in order to delineate areas of potential sensitivity within the study area. Once constraining factors have been determined, the layout of each solar PV facility and the grid connection can be planned to minimise social and environmental impacts through appropriate avoidance.

## **BASIC ASSESSMENT PROCESS**

As per the Environmental Impact Assessment Regulations, 2014, as amended, published in terms of Section 24(5) of the National Environmental Management Act (NEMA, Act No 107 of 1998), the proponents will require authorisation from the DEA (in consultation with Northern Cape Department of Environment and Nature Conservation (DENC)) for the development of the projects. In terms of Section 24(5) of NEMA, the EIA Regulations 2014 (as amended), the Government Notice (R114) and Listing Notices (GNR 327, GNR 325, and GNR 324), the three applications for EA are subject to the completion of Basic Assessment (BA) processes (Geelstert 1 and Geelstert 2 are located within the Springbok REDZ). Each application is required to be supported by comprehensive, independent environmental studies undertaken in accordance with the EIA Regulations, 2014 (as amended).

The proponent has appointed Savannah Environmental, as the independent environmental consultant, to undertake the BAs for the projects to identify and assess all potential environmental impacts associated with the projects and recommend appropriate mitigation measures in the Environmental Management Programme (EMPr) for each report. A combined BA and Public Participation Process will be conducted for the three (3) applications. As part of the environmental studies, Interested and Affected Parties (I&APs) will be actively involved through the public involvement process being undertaken by Savannah Environmental.

You and/or the organisation, which you represent, have been identified as an I&AP for the proposed projects as described above. A background information document, which provides further information on the BA process as well as the nature and extent of the proposed PV facilities and the grid connection, is attached to this letter and is also available for download from the Savannah

Environmental Website: <https://www.savannahsa.com/public-documents/energy-generation/geelstert-1-and-geelstert-2-solar-pv-facilities-and-associated-grid-connection/>.

## **PUBLIC INVOLVEMENT PROCESS**

The public participation (PP) process will be undertaken in accordance with the requirements of Regulations 39 to 44 of the Environmental Impact Assessment (EIA) Regulations, 2014, as amended, (GNR 326). The aim of the public participation process is primarily to ensure that:

- » information containing all relevant facts in respect of the proposed project is made available to potential stakeholders and I&APs
- » participation by I&APs is facilitated in such a manner that all potential stakeholders and I&APs are provided with a reasonable opportunity to comment on the proposed project; and
- » comments received from potential stakeholders and I&APs are recorded and incorporated into the EIA process.

The restrictions enforced in terms of Government Gazette 43096 which placed the country in a national state of disaster limiting the movement and gathering of people to curb the spread of the COVID-19 virus has placed some limitations on how public consultation can be conducted as part of a BA process. The consultation process for these projects has been designed considering these limitations, and the implementation is in line with our public participation plan (PP Plan), as approved by the DEA. Our PP Plan is in compliance with the Department of Environment, Forestry and Fisheries (DEFF) Directions issued on the 5<sup>th</sup> of June 2020. One of our approved consultation methods is for you to visit our online stakeholder engagement platform, register your interest in the project/s, and view project documentation: visit <https://www.savannahsa.com/public-documents/energy-generation/geelstert-1-and-geelstert-2-solar-pv-facilities-and-associated-grid-connection/>.

Alternative means of undertaking consultation have been designed to ensure that I&APs are afforded sufficient opportunity to raise comments on the project, predominately through an interactive web-based platform readily available and accessible to any person with interest in the project, enabling the public participation process to be undertaken in line with Regulations 41 to 44 of the EIA Regulations, 2014, as amended. This online stakeholder engagement platform allows the EAP to visually present details regarding the project and our consultation documentation, including project maps and plans, presentations and posters regarding the project, and reports available for review. The use of online tools enables stakeholders and I&APs to explore the project-specific content in their own time, and allows participation in the consultation process in a meaningful way. The online platform allows for instant feedback and comments to be submitted, in so doing saving time for the stakeholder and also giving the assurance that their comments have been submitted for inclusion in the project reporting.

The benefits of the online stakeholder engagement platform include:

- » Ability to create a dedicated project-specific online platform to enable easy access to project-related information.
- » Ability to reach a wider audience, allowing more widespread consultation for major infrastructure projects.
- » Allowing stakeholders and I&APs the opportunity to engage on a project without leaving their office or home.
- » Enabling stakeholders and I&APs to register their interest in a project (for inclusion on the project database), and automatically gaining access to comprehensive project documentation.
- » Enabling the EAP to maintain a complete database of I&APs through maintaining a record of persons accessing the online stakeholder consultation platform.
- » Enabling the EAP and stakeholders/I&APs to meet virtually.
- » Provides a resilient solution to a public consultation process.

Where I&APs do not have the applicable facilities or access to internet, provision has been made to include these I&APs in the consultation process by consulting with the Ward Councillor, the ward committee members, community representatives and local community forum members.

Should you have an interest in the project, please register yourself as an I&AP on our online stakeholder engagement platform (<https://www.savannahsa.com/public-documents/energy-generation/geelstert-1-and-geelstert-2-solar-pv-facilities-and-associated-grid-connection/>) or by completing and returning the attached stakeholder registration/comment form. By registering on the project database, you will be kept informed of the BA processes being undertaken for the projects and will be provided with an opportunity to provide comment and input.

Please do not hesitate to contact us should you require additional information and/or clarification regarding the project. Our team welcomes your participation and look forward to your involvement throughout this process.

Kind regards



**Nicolene Venter**

Public Participation and Social Consultant

Email: [publicprocess@savannahsa.com](mailto:publicprocess@savannahsa.com)

**Attached:** Background Information Document  
Registration and Comment Form

**BASIC ASSESSMENT AND PUBLIC PARTICIPATION PROCESS NOTIFICATION**  
**Distribution of BID and Registration & Comment Form to all OoS on project database**  
**(Appendix C2)**

**Nicolene Venter**

---

**From:** Ronald Baloyi <ronald@savannahsa.com>  
**Sent:** Monday, July 13, 2020 5:19 PM  
**To:** Steven Shibambu  
**Cc:** Nicolene Venter  
**Subject:** Geelstert PV1 & PV2: Notification of Basic Assessment Process  
**Attachments:** SE2738-Geelstert\_IAPNotification\_-\_FINAL\_.pdf; Geelstert\_English\_BID.pdf; Geelstert\_Afrikaans\_BID.pdf; SE2738-Geelstert\_PV1&PV2-RegForm\_FINAL.pdf

**GEELSTERT 1 AND GEELSTERT 2 SOLAR PV FACILITES AND GEELSTERT GRID CONNECTION, NEAR AGGENEYS,  
NORTHERN CAPE PROVINCE**

Dear Interested and Affected Parties,

The development of two separate solar photovoltaic (PV) facilities, each with a contracted capacity of up to 125MW, and associated grid connection is proposed on a site located approximately 11km south-east of the town of Aggeneys in the Northern Cape Province. The two solar PV facilities are to be known as Geelstert 1 and Geelstert 2. The grid connection solution will be known as Geelstert Grid Connection. The projects are situated within the Khâi-Ma Local Municipality, in the greater Namakwa District Municipality.

Please find attached the following documents which will provide you with additional information regarding these projects:

- Basic Assessment and Public Participation Process notification letter;
- Background Information Document; and
- Registration and Comment Form.

Please do not hesitate to contact us should you require additional information and/or clarification regarding the projects. Our team welcomes your participation and look forward to your involvement throughout this process.

Kind regards,

JULY 2020

**BASIC ASSESSMENT  
AND  
PUBLIC PARTICIPATION PROCESS**

**DEVELOPMENT OF  
GEELSTERT 1 AND GEELSTERT 2  
SOLAR PV FACILITIES AND  
ASSOCIATED GRID CONNECTION SOLUTION  
NEAR AGGENEYS, NORTHERN CAPE**

**savannah**  
environmental

**BACKGROUND INFORMATION DOCUMENT**





The development of two separate solar photovoltaic (PV) facilities of up to 125MW and associated infrastructure is proposed on a site located approximately 11km south-east of the town of Aggeneys in the Northern Cape Province. The two solar PV facilities are to be known as Geelstert 1 and Geelstert 2. The grid connection solution will be known as Geelstert Grid Connection. The projects are situated within the Khâi-Ma Local Municipality, in the greater Namakwa District Municipality.

The two solar PV facilities are located on the Remaining Extent of the Farm Bloemhoek 61. Both solar PV facilities will be connected to the grid by a single grid connection solution, which consists of a collector substation and a single-circuit power line of up to 220kV. The power line will connect the facilities to the national grid via the existing Aggeneys Main Transmission Substation (MTS) which is located 14.5km west of the study area. The development of the grid connection infrastructure will be assessed as part of a separate Basic Assessment process. The assessment of the grid connection infrastructure will consider a corridor with a width of up to 1km (extending to 2km at the Aggeneys MTS) and a length of up to 17.5km. The following six properties may be impacted by the development of the Geelstert grid connection solution:

Remaining Extent of the Farm Bloemhoek 61	Remaining Extent of the Farm Aggeneys 56
Portion 1 of the Farm Aggeneys 56	Portion 2 of the Farm Aggeneys 56
Portion 12 of the Farm Aggeneys 56	Portion 13 of the Farm Aggeneys 56

The study area is located within Zone 8 of the Renewable Energy Development Zones (REDZ) (also known as the Springbok REDZ), and within the Northern Transmission Corridor. As Geelstert 1 and Geelstert 2 are located within one of the eight REDZ areas, the projects are subject to a Basic Assessment (BA) process, as well as a shortened timeframe of 57 days for the processing of an Application for Environmental Authorisation. The grid connection solution will also be subject to a BA process and will be in-line with the timeframes in accordance with the EIA Regulations, 2014 (as amended).

The nature and extent of the three (3) projects is explored in more detail in this document. The public participation processes for the projects will be undertaken concurrently, providing the public with an opportunity to understand and comment on each of the projects. Each solar PV facility and the grid connection solution will be constructed as separate stand-alone projects, each with a separate project development company or Special Purpose Vehicle (SPV) as the Applicant for each project:

Project Name:	Applicant:	Capacity:
Geelstert 1 (solar PV facility)	Geelstert Solar Facility 1 (Pty) Ltd	Up to 125MW (contracted capacity)
Geelstert 2 (solar PV facility)	Geelstert Solar Facility 2 (Pty) Ltd	Up to 125MW (contracted capacity)
Geelstert Grid Connection	ABO Wind renewable energies (Pty) Ltd	Up to 220kV

It is the Developer's intention to bid each solar PV facility under the Department of Mineral Resources and Energy's (DMRE) Renewable Energy Independent Power Producer Procurement (REIPPP) Programme. The power generated from each solar PV facility is

intended to be sold to Eskom and fed into the national electricity grid. The development of the facilities and grid connection infrastructure will also assist with achieving the energy mix as set out in the Integrated Resources Plan (IRP).

### AIM OF THIS BACKGROUND INFORMATION DOCUMENT

- This document aims to provide you, as an interested and/or affected party (I&AP), with:
- » An overview of the proposed solar PV facilities, grid connection solution and associated infrastructure.
  - » An overview of the Basic Assessment (BA) processes and specialist studies being undertaken to assess the projects.
  - » Details of how you can become involved in the BA processes, receive information, or raise comments that may concern and/or interest you.

### OVERVIEW OF THE PROJECTS

In response to the growing electricity demand within South Africa, the need to promote renewable energy and sustainability within the Northern Cape Province, as well as the country's targets for renewable energy, the development of two solar PV facilities of up to 125MW is proposed within the Springbok REDZ. The development of the facilities will add new capacity and transmission infrastructure to the national electricity grid network. The development area for each solar PV facility will be ~550ha in extent. The development footprint of the facility will be located within the development area and will be designed to avoid sensitive environmental areas and features.

Infrastructure associated with each solar PV facility will include:

- » Solar PV panels.
- » Centralised inverter stations or string inverters.
- » Mounting structures to support the PV panels.
- » Cabling between the project components, to be laid underground where practical.
- » On-site inverters to convert the power from a direct current (DC) to an alternating current (AC).
- » An on-site facility substation to facilitate the connection between the solar PV facility and the Eskom electricity grid.
- » Site offices and maintenance buildings, including workshop areas for maintenance and storage.
- » Temporary laydown areas.
- » Internal access roads and fencing around the development area.

The grid connection will include a collector substation and an overhead power line with a capacity of up to 220kV connecting the facilities to the Aggeneys Main Transmission Substation (MTS).

Site-specific studies and assessments will be undertaken through the BA processes in order to delineate areas of potential sensitivity within the surrounding areas, the identified study area and grid connection corridor. Once constraining factors have been determined, the layout of the solar PV facilities and the grid connection solution can be planned to minimise social



and environmental impacts.

## MORE ABOUT SOLAR PV TECHNOLOGY

Solar energy facilities (such as those that utilise PV technology) use energy from the sun to generate electricity through a process known as the Photovoltaic Effect. This effect refers to photons of light colliding with electrons, and therefore placing the electrons into a higher state of energy to create electricity. The solar fields of Geelstert 1 and Geelstert 2 will comprise the following components:

### Photovoltaic Cells:

A photovoltaic (PV) cell is made of silicone that acts as a semiconductor used to produce the photovoltaic effect. PV cells are arranged in multiples/arrays and placed behind a protective glass sheet to form a PV panel. Each PV cell is positively charged on one side and negatively charged on the opposite side, with electrical conductors attached to either side to form a circuit. This circuit captures the released electrons in the form of an electric current (i.e. Direct Current (DC)).

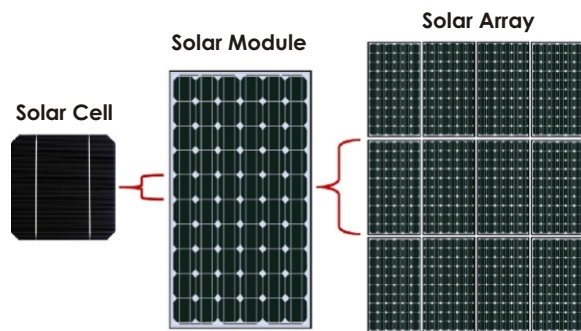

**Figure 1:** Overview of a PV cell, module and array/panel (Source: pveducation.com)

A solar PV module is made up of individual solar PV cells connected together, whereas a solar PV array is a system made up of a group of individual solar PV modules electrically wired together to form a much larger PV installation.

The PV panels will be fixed to support structures and will either utilise fixed/static support structures or alternatively, they can utilise single or double axis tracking support structures.

### Inverters:

Inverters are used to convert electricity produced by the PV cells from Direct Current (DC) into Alternating Current (AC) to enable the facility to be connected to the national electricity grid. Numerous inverters will be arranged in several arrays to collect and convert power produced by the facilities.

PV panels are designed to operate continuously for more than 20 years, mostly unattended and with low maintenance.

## ENVIRONMENTAL IMPACT ASSESSMENT PROCESS

In accordance with the EIA Regulations, 2014 (as amended) published in terms of Section 24(5) of the National Environmental Management Act (No. 107 of 1998) (NEMA), the applicants require Environmental Authorisation (EA) from the National Department of Environmental Affairs (DEA) in consultation with the Northern Cape Department of Environment and Nature Conservation (DENC) for the development of the proposed projects. In terms of Section 24(5) of NEMA, the EIA Regulations 2014 (as amended), the Government Notice (R114) and Listing Notices (GNR 327, GNR 325, and GNR 324), the three applications for EA are subject to the completion of Basic Assessment (BA) processes (Geelstert 1 and Geelstert 2 are located within the Springbok REDZ). Each application is required to be supported by comprehensive, independent environmental studies undertaken in accordance with the EIA Regulations, 2014 (as amended).

A BA is an effective planning and decision-making tool. It allows for potential environmental consequences resulting from a proposed activity to be identified and appropriately managed during the construction, operation, and decommissioning phases of development. It also provides an opportunity for the project applicant to be forewarned of potential environmental issues, and allows for the resolution of issue(s) identified and reported on as part of the BA process, as well as provides opportunity for dialogue with key stakeholders and Interested and Affected Parties (I&APs).

Savannah Environmental has been appointed as the independent environmental consultant responsible for managing the separate applications for EA and undertaking the supporting BA process required to identify and assess potential environmental impacts associated with the projects, as well as propose appropriate mitigation and management measures to be contained within the Environmental Management Programmes (EMPrs). Generic EMPrs in accordance with GNR435 will be compiled for the grid connection solution.

## WHAT ARE THE POTENTIAL ENVIRONMENTAL IMPACTS ASSOCIATED WITH THE PROPOSED PROJECTS?

The study area and the grid connection corridor will be assessed by independent environmental specialists to identify the potential for environmental impacts. Specialist studies that are proposed as part of the BA processes include the following:

- » Biodiversity - includes ecology, freshwater features, fauna and flora and assess the potential impact and the associated disturbance of vegetation on the biodiversity (including critical biodiversity areas and broad-scale processes).
- » Avifauna - includes an assessment of impacts on avifaunal habitats and sensitive features.
- » Soils, Land Use, and Agricultural Potential - includes land types and assesses the significance of loss of agricultural land and soil degradation and/or erosion.
- » Heritage (Archaeology and Palaeontology) - which includes archaeology and palaeontology and assesses the potential of disturbance to or destruction of heritage sites and fossils during the construction phase through excavation activities.
- » Visual - which includes the visual quality of the area and assesses the impact of the solar PV facilities and the grid connection solution on the aesthetics within the area.



- » Social - which assesses the positive and negative social impacts.

Specialist studies will be informed by existing information, previous experience in the area, field observations and input from the public participation process. As an I&AP, your input is considered as an important part of the process, and we urge you to become involved.

### PUBLIC PARTICIPATION PROCESS

The sharing of information forms the basis of the public participation process and offers I&APs the opportunity to become actively involved in the BA processes. Comments and inputs from I&APs are encouraged in order to ensure that potential impacts are considered throughout the BA processes.

The public participation process aims to ensure that:

- » Information containing all relevant facts in respect of the applications are made available to I&APs for review.
- » I&AP participation is facilitated in such a manner that they are provided with reasonable opportunity to comment on the proposed projects.
- » Adequate review periods are provided for I&APs to comment on the findings of the BA Reports.

In order to ensure effective participation, the public participation processes include the following:

- » Identifying I&APs, including affected and adjacent landowners and occupiers of land, and relevant Organs of State, and recording details within a database.
- » Notifying registered I&APs of the commencement of the BA processes and distributing the Background Information Document (BID).
- » Providing access to registered parties to an online stakeholder engagement platform, which centralises project information and stakeholder input in a single digital platform.
- » Providing an opportunity for I&APs to engage with the EIA project team.
- » Placing site notices at the affected property/ies.
- » Placing an advertisement in a local newspaper.
- » Notifying I&APs of the release of the BA Reports for a 30-day review and comment period.

### YOUR RESPONSIBILITIES AS AN I&AP

In terms of the EIA Regulations, 2014 (as amended) and the Public Participation Guidelines, 2014 your attention is drawn to your responsibilities as an I&AP:

- » In order to participate in the BA processes, you must register yourself on the I&AP database.
- » You must ensure that any comments regarding the proposed projects are submitted within the stipulated timeframes.
- » You are required to disclose any direct business, financial, personal, or other interest that you may have in the approval or refusal of the applications.

### HOW TO BECOME INVOLVED

1. By responding by phone, fax, or e-mail, to the invitation for your involvement.
2. By returning the reply form to the relevant contact person.
3. By engaging with the project team on the online stakeholder engagement platform during the BA processes.
4. By contacting the environmental consultant with queries or comments.
5. By reviewing and commenting on the BA Reports within the stipulated 30-day review and comment periods. Registered I&APs will automatically be notified of the release of the BA Reports for comment, and the closing dates by which comments must be received.

If you consider yourself an I&AP for the proposed projects, we urge you to make use of the opportunities created by the public participation process to provide comment, raise issues and concerns which affect and / or interest you, or request further information. Your input forms a key element of the BA processes.

By completing and submitting the accompanying reply form, you automatically register yourself as an I&AP for the proposed projects, and are ensured that your comments, concerns, or queries raised regarding the projects will be noted.

### COMMENTS AND QUERIES

**Direct all comments, queries, or responses to:**

**Ronald Baloyi**  
**Savannah Environmental (Pty) Ltd**  
 PO Box 148, Sunninghill, Johannesburg, 2157  
 Tel: 011 656 3237  
 Fax: 086 684 0547  
 E-mail: [publicprocess@savannahsa.com](mailto:publicprocess@savannahsa.com)

**To visit the online stakeholder engagement platform and view project documentation, visit**

[www.savannahSA.com](http://www.savannahSA.com)



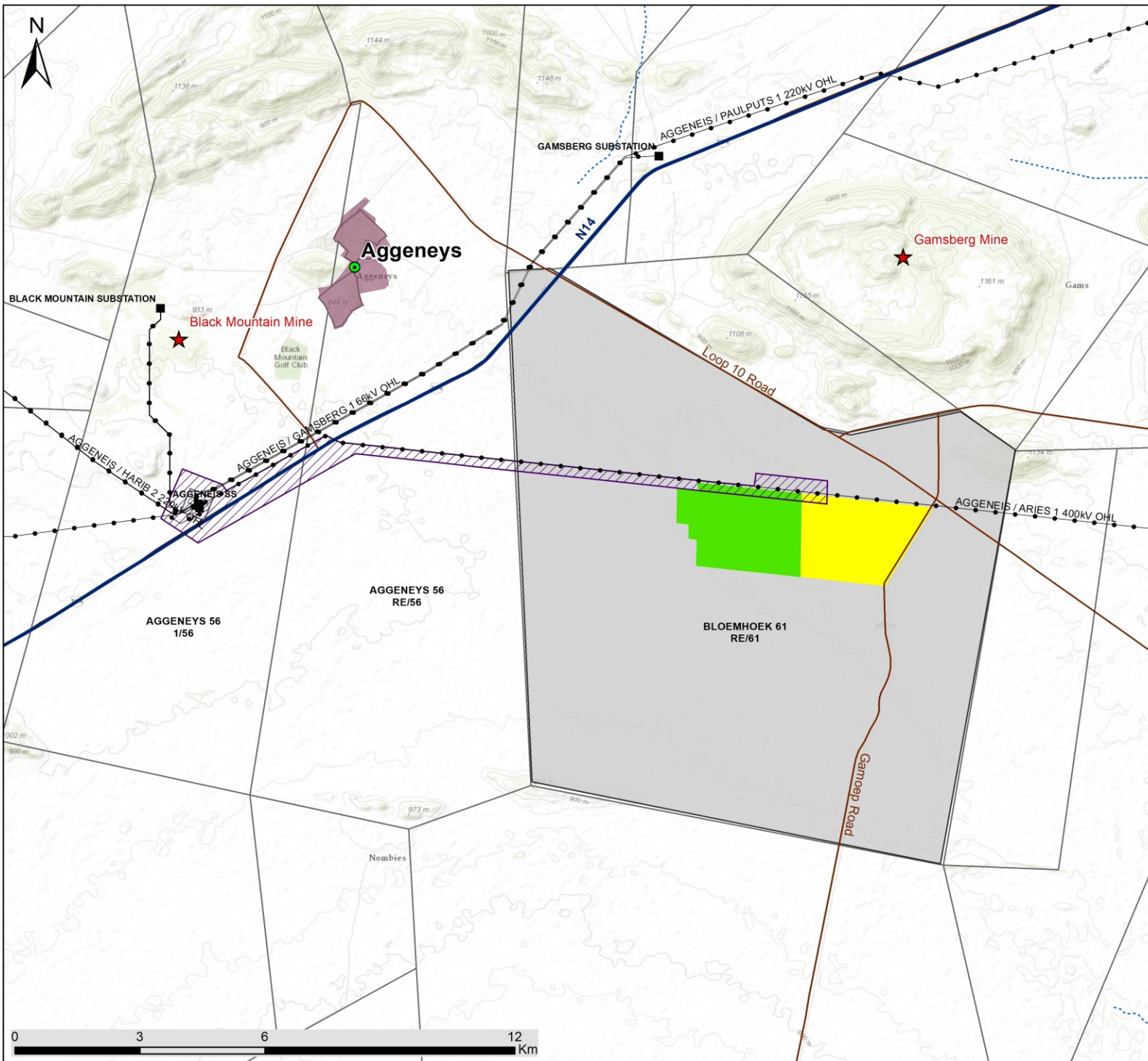

# Geelstert 1 and 2 Solar PV Facilities and Geelstert Grid Connection, Northern Cape

## Locality Map

### Legend

- Town
- ★ Mining Operations
- Eskom Substation
- Existing Power Line
- National Route
- Main Road
- Non-perennial River
- Residential Area
- Farm Portion
- Study Area
- Geelstert 1 (Development Area)
- Geelstert 2 (Development Area)
- Geelstert Grid Connection (Power Line Corridor)



Scale: 1:90 218  
 Projection: L019  
 Map Ref: Geelstert 1&2 PV - Locality Map - 13.05.2020

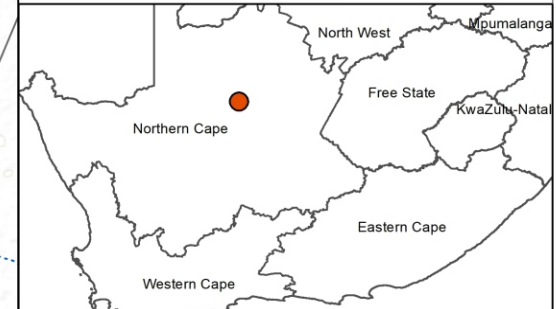

**BASIC ASSESSMENT AND PUBLIC PARTICIPATION PROCESS**

**GEELSTERK 1 AND GEELSTERT 2 SOLAR PV FACILITIES AND GEELSTERT GRID CONNECTION, NEAR  
UPINGTON, AGGENEYS CAPE PROVINCE**

**Registration & Comment Form**

July 2020

Return completed registration and comment form to: **Ronald Baloyi of Savannah Environmental**

**Phone:** 011 656 3237 / **Mobile (incl. 'please call me'):** 060 978 8396 / **Fax:** 086 684 0547

**E-mail:** publicprocess@savannahsa.com

**Postal Address:** PO Box 148, Sunninghill, 2157

**Your registration as an interested and/or affected party will be applicable for this project only and your contact details provided are protected by the PoPI Act of 2013**

**Please provide your complete contact details:**

Name & Surname:			
Organisation:			
Designation:			
Postal Address:			
Telephone:		Fax:	
Mobile:			
E-mail:			

**I would you like to register as an interested and affected party (I&AP) on the following project's database** (please tick the relevant box)

Geelstert 1 Solar PV	<input type="checkbox"/>	Geelstert 2 Soalr PV	<input type="checkbox"/>
----------------------	--------------------------	----------------------	--------------------------

**In terms of EIA Regulations, 2014, as amended, Regulation 43(1), you are required to register as an I&AP to receive further correspondence regarding the BA process for the projects and to disclose any direct business, financial, personal or other interest which you may have in the approval or refusal of the application** (add additional pages if necessary):

**Please list your comments regarding your project selection above** (add additional pages if necessary):

**Please provide contact details of any other persons who you regard as a potential interested or affected party:**

Name & Surname:	
Postal Address:	
Telephone:	
Mobile:	
E-mail:	

**SIEN KEERSY VIR AFRIKAANS**

JULIE 2020

BASIESE EVALUERING  
EN  
OPENBARE DEELNAMEPROSES

ONTWIKKELING VAN  
GEELSTERT 1 EN GEELSTERT 2  
FV-SONKRAGAAANLEGTE EN  
VERWANTE ROOSTERKONNEKSIE-OPLOSSING  
NABY AGGENEYS, NOORD-KAAP

savannah  
environmental

AGTERGRONDINLIGTINGSDOKUMENT



Die ontwikkeling van twee afsonderlike fotovoltaïese (FV) sonkragaanlegte van hoogstens 125MW en verwante infrastruktuur word beoog op 'n terrein sowat 11 km suidoos van die dorp Aggeneys in die Noord-Kaapprovinsie. Die twee FV-sonkragaanlegte sal Geelstert 1 en Geelstert 2 genoem word. Die roosterkonneksie-oplossing sal die Geelstert Roosterkonneksie genoem word. Die projekte is in die Khâi-Ma Plaaslike Munisipaliteit in die breër Namakwa Distriksmunisipaliteit en omstreke geleë.

Die twee FV-sonkragaanlegte is geleë op die Restant van die plaas Bloemhoek 61. Albei FV-sonkragaanlegte sal aan die hand van 'n enkele roosterkonneksie-oplossing, bestaande uit 'n kollektorsubstasie en 'n enkelkringkraglyn van hoogstens 220 kV, met die kragnet verbind word. Die kraglyn sal die aanlegte met die nasionale kragnet verbind aan die hand van die bestaande Aggeneis Hooftransmissiesubstasie (HTS) wat 14,5 km wes van die studiegebied geleë is. Die ontwikkeling van die roosterkonneksie-infrastruktuur sal as deel van 'n afsonderlike Basiese Evalueeringsproses geëvalueer word. Die evaluering van die roosterkonneksie-infrastruktuur sal oorweging skenk aan 'n korridor met 'n breedte van hoogstens 1 km (wat uitkring tot 2 km by die Aggeneis HTS) en 'n lengte van hoogstens 17,5 km. Die volgende ses eiendomme kan deur die ontwikkeling van die Geelstert Roosterkonneksie-oplossing geraak word:

Restant van die plaas Bloemhoek 61	Restant van die plaas Aggeneys 56
Gedeelte 1 van die plaas Aggeneys 56	Gedeelte 2 van die plaas Aggeneys 56
Gedeelte 12 van die plaas Aggeneys 56	Gedeelte 13 van die plaas Aggeneys 56

Die studiegebied is geleë in Sone 8 van die Hernubare Kragontwikkelingsones (REDZ) (ook bekend as die Springbok REDZ) en is in die Noordelike Transmissiekorridor. Aangesien Geelstert 1 en Geelstert 2 in een van die agt REDZ-gebiede geleë is, is die projekte onderhewig aan 'n Basiese Evalueeringsproses (BE), asook 'n verkorte tydsraamwerk van 57 dae vir die verwerking van 'n Aansoek om Omgewingsmagtiging. Die roosterkonneksie-oplossing sal ook onderhewig wees aan 'n BE-proses en sal in lyn wees met die tydsraamwerke ingevolge die OIE-regulasies, 2014 (soos gewysig).

Die aard en omvang van die drie (3) projekte word van naderby in hierdie dokument ondersoek. Die openbare deelnameprosesse vir die projekte sal gelyklopend onderneem word, wat aan die publiek 'n geleentheid sal bied om elk van die projekte te verstaan en daarop kommentaar te lewer. Elke FV-sonkragaanleg en die roosterkonneksie-oplossing sal as afsonderlike, losstaande projekte met 'n afsonderlike projek-ontwikkelingsmaatskappy, of Spesiedoelmedium (SDM) as die applikant vir elk van die projekte, opgerig word:

Projeknaam:	Applikant:	Vermoë:
Geelstert 1 (FV-sonkragaanleg)	Geelstert Solar Facility 1 (Edms.) Bpk.	Hoogstens 125MW (gekontraakteerde vermoë)
Geelstert 2 (FV-sonkragaanleg)	Geelstert Solar Facility 2 (Edms.) Bpk.	Hoogstens 125MW (gekontraakteerde vermoë)
Geelstert Roosterkonneksie	ABO Wind Renewable Energies (Edms.) Bpk.	Hoogstens 220 kV

Die ontwikkelaar is van voorneme om elke FV-sonkragaanleg aan te bied ingevolge die Departement van Minerale Hulpbronne en Energie (DMHE) se Verkrygingsprogram vir Onafhanklike Hernubare Kragproducente (REIPPP). Daar word beoog dat die krag wat by elke FV-sonkragaanleg opgewek sal word, aan Eskom verkoop en by die nasionale kragnet ingevoer sal word. Die ontwikkeling van die aanlegte en roosterkonneksie-infrastruktuur sal ook bydra om die kragmengsel, soos uiteengesit in die Geïntegreerde Hulpbronneplan (IRP), te verwesenlik.

### DOEL VAN HIERDIE AGTERGRONDINLIGTINGSDOKUMENT

Hierdie dokument stel dit ten doel om u, as 'n belangstellende en/of geaffekteerde party (B&GP), te voorsien van:

- » 'n oorsig van die beoogde FV-sonkragaanlegte, roosterkonneksie-oplossing en verwante infrastruktuur;
- » 'n oorsig van die Basiese Evalueeringsprosesse (BE) en spesialisstudies wat onderneem word om die projekte te evalueer;
- » besonderhede van hoe u by die BE-prosesse betrokke kan raak, inligting kan ontvang of kommentaar kan opper wat u dalk kan raak en/of vir u van belang kan wees.

### OORSIG VAN DIE PROJEKTE

In antwoord op die groeiende vraag na elektrisiteit in Suid-Afrika, die behoefte om hernubare krag en volhoubaarheid in die Noord-Kaapprovinsie te bevorder, asook die land se teikens vir hernubare krag, word die ontwikkeling van twee FV-sonkragaanlegte van hoogstens 125MW in die Springbok REDZ-gebied beoog. Die ontwikkeling van die aanlegte sal nuwe vermoë en transmissie-infrastruktuur by die nasionale kragnetwerk voeg. Die ontwikkelingsgebied vir elke FV-sonkragaanleg sal ~550 ha in omvang wees. Die aanleg se ontwikkelingsvoetspoor sal in die ontwikkelingsgebied geleë wees en sal ontwerp wees om sensitiewe omgewingsgebiede en landmerke te vermy.

Infrastruktuur wat met elk van die FV-sonkragaanlegte verband hou, sal insluit:

- » FV-sonkragpanele;
- » gesentraliseerde wisselrigterstasies of wisselrigterstringe;
- » monteerstrukture om die FV-panele te dra;
- » kables tussen die projekkomponente, wat ondergronds gelê sal word waar prakties moontlik;
- » interne wisselrigters om die krag van 'n gelykstroom (GS) om te sit is 'n wisselstroom (WS);
- » 'n interne aanlegsubstasie om die konneksie tussen die FV-sonkragaanleg en Eskom se kragnet te bewerkstellig;
- » terreinkantore en instandhoudingsgeboue, wat werkswinkelgebiede vir instandhouding en berging insluit;
- » tydelike opslagwerwe; en
- » interne toegangspaaie en 'n heining om die ontwikkelingsgebied.

Die roosterkonneksie sal 'n kollektorsubstasie en 'n oorhoofse kraglyn met 'n vermoë van hoogstens 220 kV insluit wat die aanlegte met die Aggeneis Hooftransmissiesubstasie (HTS) sal verbind.



Studies eie aan die terrein en evaluerings sal deur die BE-prosesse onderneem word ten einde potensieel sensitiewe gebiede in die omliggende gebiede, die geïdentifiseerde studiegebied en roosterkonneksiekorridor af te baken. Sodra beperkende faktore bepaal is, kan die uitleg van die FV-sonkragaanlegte en die roosterkonneksie-oplossing beplan word om maatskaplike en omgewingsimpakte tot die minimum te beperk.

## MEER OOR FV-SONKRAGTEGNOLOGIE

Sonkragaanlegte (soos dié wat FV-tegnologie gebruik), wend die son se energie aan om elektrisiteit op te wek deur 'n proses wat as die Fotovoltaïese Effek bekend staan. Hierdie effek verwys na ligfotone wat met elektrone bots, wat die elektrone gevolglik in 'n hoër staat van energie plaas om elektrisiteit voort te bring. Die sonselvelde van Geelstert 1 en Geelstert 2 sal uit die volgende komponente bestaan:

### Fotovoltaïese Selle:

'n Fotovoltaïese (FV) sel word van silikon gemaak wat as halfgeleier optree en gebruik word om die fotovoltaïese effek voort te bring. FV-selle word in veelvoude/reekse gerangskik en agter 'n beskermende glaspaneel geplaas om 'n FV-paneel te vorm. Elke FV-sel se een kant is positief en die teenoorgestelde kant negatief gelaaï, met elektriese geleiers wat aan beide kante aangebring is om 'n stroombaan te vorm. Hierdie stroombaan vang die vrygestelde elektrone vas in die vorm van 'n elektriese stroom (d.i. gelykstrom (GS)).

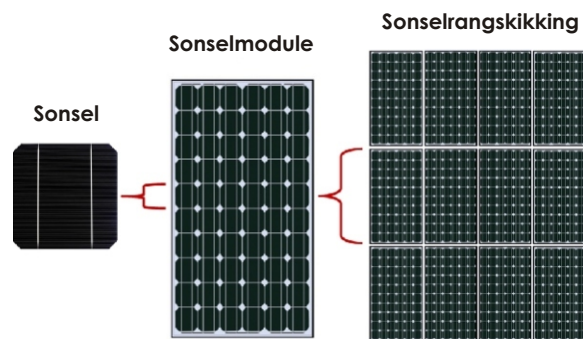

**Figuur 1:** Oorsig van 'n FV-sel, module en reeks/paneel (Bron: pveducation.com)

'n FV-sonpaneelmodule bestaan uit individuele FV-selle wat met mekaar verbind is, terwyl 'n FV-sonkragreeks 'n stelsel is wat bestaan uit 'n groep individuele FV-sonkragmodules wat elektries bedraad is om 'n veel groter FV-installasie te vorm.

Die FV-panele sal op steunstrukture aangebring word en hetsy vaste/stilstaande steunstrukture sal gebruik word, of andersins kan hulle enkel- of dubbelas naspoordersteunstrukture gebruik.

### Wisselrigters:

Wisselrigters word gebruik om elektrisiteit wat deur die FV-selle opgewek word van gelykstrom (GS) na wisselstroom (WS) om te sit sodat die aanleg met die nasionale kragnet

verbind kan word. Verskeie wisselrigters sal in verskeie reekse gerangskik word om krag wat deur die aanlegte opgewek word, te versamel en om te sit.

FV-panele is ontwerp om vir meer as 20 jaar ononderbroke, meestal onbeman en met min instandhouding in bedryf te staan.

## OMGEWINGSIMPAKEVALUERINGSPROSES

Ooreenkomstig die OIE-regulasies, 2014 (soos gewysig), wat kragtens Artikel 24(5) van die Nasionale Wet op Omgewingsbestuur (Wet 107 van 1998) (NEMA) gepubliseer is, benodig die applikante Omgewingsmagtiging (OM) van die Nasionale Departement van Omgewingsake (DO), in oorleg met die Noord-Kaapse Departement van Omgewingsake en Natuurbewaring (DENC), vir die ontwikkeling van die beoogde projekte. Ingevolge Artikel 24(5) van NEMA, die OIE-regulasies 2014 (soos gewysig), Staatskennisgewing R114 en Lyskennisgewings (Staatkennisgewing R327, R325 en R324), is die drie aansoeke om OM onderhewig aan die voltooiing van Basiese Evalueringsprosesse (BE's) (Geelstert 1 en Geelstert 2 is geleë in die Springbok REDZ). Elke aansoek moet gerugsteun word deur omvattende, onafhanklike omgewingstudies wat ingevolge die OIE-regulasies, 2014 (soos gewysig) onderneem word.

'n BE is 'n doeltreffende beplannings- en besluitnemingswerktuig. Dit bring mee dat potensieële omgewingsverwante gevolge wat voortspruit 'n beoogde aktiwiteit, geïdentifiseer en na behore tydens die oprigtings-, bedryfs- en uitbedryfstellingsfase van ontwikkeling bestuur word. Dit bied ook 'n geleentheid vir die projekapplikant om vooraf gewaarsku te wees van potensieële omgewingskwessies en maak voorsiening vir die oplossing van kwessies wat geïdentifiseer en as deel van die BE-proses oor verslag gedoen is, en bied ook die geleentheid vir dialoog tussen sleutelbelanghebbers en belangstellende en geïmpakteerde partye (B&GP's).

Savannah Environmental is aangestel as onafhanklike omgewingskonsultant wat verantwoordelik is vir die bestuur van die aparte aansoeke om OM en om die stuwende BE-proses te onderneem wat vereis word om alle potensieële omgewingsimpakte wat verband hou met die projekte te identifiseer en te evalueer, en om gepaste versagtings- en bestuursmaatreëls aan die hand te doen wat in die Omgewingsbestuursprogramme (OBPr'e) vervat moet word. Generiese OBPr'e ooreenkomstig Staatskennisgewing R435 sal vir die roosterkonneksie-oplossing opgestel word.

## WAT IS DIE POTENSIEËLE OMGEWINGSIMPAKTE WAT VERBAND HOU MET DIE BEOOGDE PROJEKTE?

Die studiegebied en die roosterkonneksiekorridor sal deur onafhanklike omgewingspesialiste geëvalueer word om die potensiaal vir omgewingsimpakte te identifiseer. Spesialisstudies wat as deel van die BE-prosesse beoog word, sluit die volgende in:

- » Biodiversiteit - wat ekologie, varswaterkenmerke, fauna en flora insluit en die potensieële impak en verwante versteuring van plantegroei op die biodiversiteit (insluitende kritiese biodiversiteitsgebiede en breëskaalprosesse) evalueer.
- » Avifauna - sluit 'n evaluering van impakte op avifaunahabitats en sensitiewe kenmerke in.
- » Grond, grondgebruik en landboupotensiaal – sluit grondsoorte in en evalueer die



wesentlikheid van verlies aan landbougrond en gronddegradasie en/of erosie.

- » Erfenis (argeologie en paleontologie) - wat argeologie en paleontologie insluit en die potensiele versteuring of vernietiging van erfenisterreine en fossiele tydens die konstruksiefase weens opgrawingsbedrywighede evalueer.
- » Visueel - wat die visuele gehalte van die gebied insluit en die impak van FV-sonkragaanlegte en die roosterkonneksie-oplossing op die estetika in die gebied evalueer.
- » Maatskaplik - wat die positiewe en negatiewe sosiale impakte evalueer.

Spesialisstudies sal toegelig word deur bestaande inligting, vorige ervaring in die gebied, veldwaarnemings en insette wat uit die openbare deelnameproses voortspruit. As 'n B&GP word u insette as 'n belangrike deel van die proses geag, en ons moedig u aan om betrokke te raak.

### OPENBARE DEELNAMEPROSES

Die deel van inligting vorm die grondslag van die openbare deelnameproses en bied B&GP's die geleentheid om aktief by die BE-prosesse betrokke te raak. Kommentaar en insette van B&GP's word aangemoedig ten einde te verseker dat oorweging aan potensiele impakte regdeur die BE-prosesse geskenk word.

Die openbare deelnameproses poog om te verseker dat:

- » inligting wat al die tersaaklike feite met betrekking tot die aansoeke bevat, aan B&GP's beskikbaar gestel word vir insae;
- » deelname deur B&GP's op so 'n wyse gefasiliteer word dat hulle 'n redelike geleentheid gegun word om kommentaar te lewer oor die beoogde projekte; en
- » voldoende insaetydperke aan B&GP's gebied word om kommentaar te lewer oor die bevindinge van die BE-verslae.

Ten einde doeltreffende deelname te verseker, sluit die openbare deelnameprosesse in:

- » die identifisering van B&GP's, insluitend geaffekteerde en naburige grondeienaars en -bewoners en tersaaklike staatsinstansies en die aantekening van besonderhede in 'n databasis;
- » die verwittiging van geregistreerde B&GP's van die aanvang van die BE-prosesse en die verspreiding van die Agtergrondinligtingsdokument (AID);
- » voorsiening van toegang aan geregistreerde partye tot 'n aanlyn skakelingsplatform vir belanghebbende, wat projekinligting en insette van belanghebbende in 'n enkele digitale platform sentraliseer;
- » om B&GP's 'n geleentheid te bied om met die OIE-projekspan te skakel;
- » die plasing van terreinkennisgewings by die geaffekteerde eiendom(me);
- » die plasing van 'n advertensie in 'n plaaslike koerant;
- » die verwittiging van B&GP's van die vrystelling van die BE-verslae vir 'n 30-dae openbare insae- en kommentaartydperk;

### U VERANTWOORDELIKHEDE AS 'N B&GP

Kragtens die OIE-regulasies, 2014 (soos gewysig) en die Openbare Deelnameriglyne, 2014,

word u aandag gevestig op u verantwoordelikhede as 'n B&GP:

- » Ten einde aan die BE-prosesse deel te neem, moet u uself op die B&GP-databasis registreer.
- » U moet toesien dat enige kommentaar met betrekking tot die beoogde projekte binne die gestipuleerde tydsraamwerke ingedien word.
- » U moet enige regstreekse sake-, finansiële-, persoonlike- of ander belang wat u dalk in die goedkeuring of weiering van die aansoeke kan hê, bekend maak.

### HOE OM BETROKKE TE RAAK

1. Deur telefonies, per faks of per e-pos te reageer op die uitnodiging vir u betrokkeheid.
2. Deur die antwoordvorm aan die tersaaklike kontakpersoon terug te besorg.
3. Deur skakeling met die projekspan op die aanlyn skakelingsplatform vir belanghebbende tydens die BE-prosesse.
4. Deur die omgewingskonsultant met navrae of kommentaar te kontak.
5. Deur oorsig oor en kommentaar op die BE-verslae te bied, en wel binne die gestipuleerde 30 dae insae- en kommentaartydperke. Geregistreerde B&GP's sal outomaties in kennis gestel word van die vrystelling van die BE-verslae vir kommentaar, asook van die sluitingsdatums waarteen kommentaar ontvang moet word.

As u uself as 'n B&GP vir die beoogde projekte ag, moedig ons u aan om gebruik te maak van die geleenthede wat geskep word deur die openbare deelnameproses om kommentaar te lewer of daardie kwessies en knelpunte te opper wat u raak en/of vir u van belang is of waaroor u meer inligting versoek. U inset vorm 'n belangrike deel van die BE-prosesse.

Deur die meegaande Antwoordvorm in te vul en aan ons terug te besorg, registreer u uself outomaties as 'n B&GP vir die beoogde projekte en verseker u dat kennis geneem sal word van die kommentaar, knelpunte of navrae wat u met betrekking tot die projekte opper.

### KOMMENTAAR EN NAVRAE

**Rig alle kommentaar, navrae of antwoorde aan:**

**Ronald Baloyi**

**Savannah Environmental (Edms) Bpk**

Posbus 148, Sunninghill, Johannesburg, 2157

Tel: 011 656 3237

Faks: 086 684 0547

E-pos: [publicprocess@savannahsa.com](mailto:publicprocess@savannahsa.com)

**Om die aanlynplatform as belanghebbende te besoek  
en projekdokumentasie te besigtig, besoek**

[www.savannahSA.com](http://www.savannahSA.com)

Kopiereg: Savannah Environmental

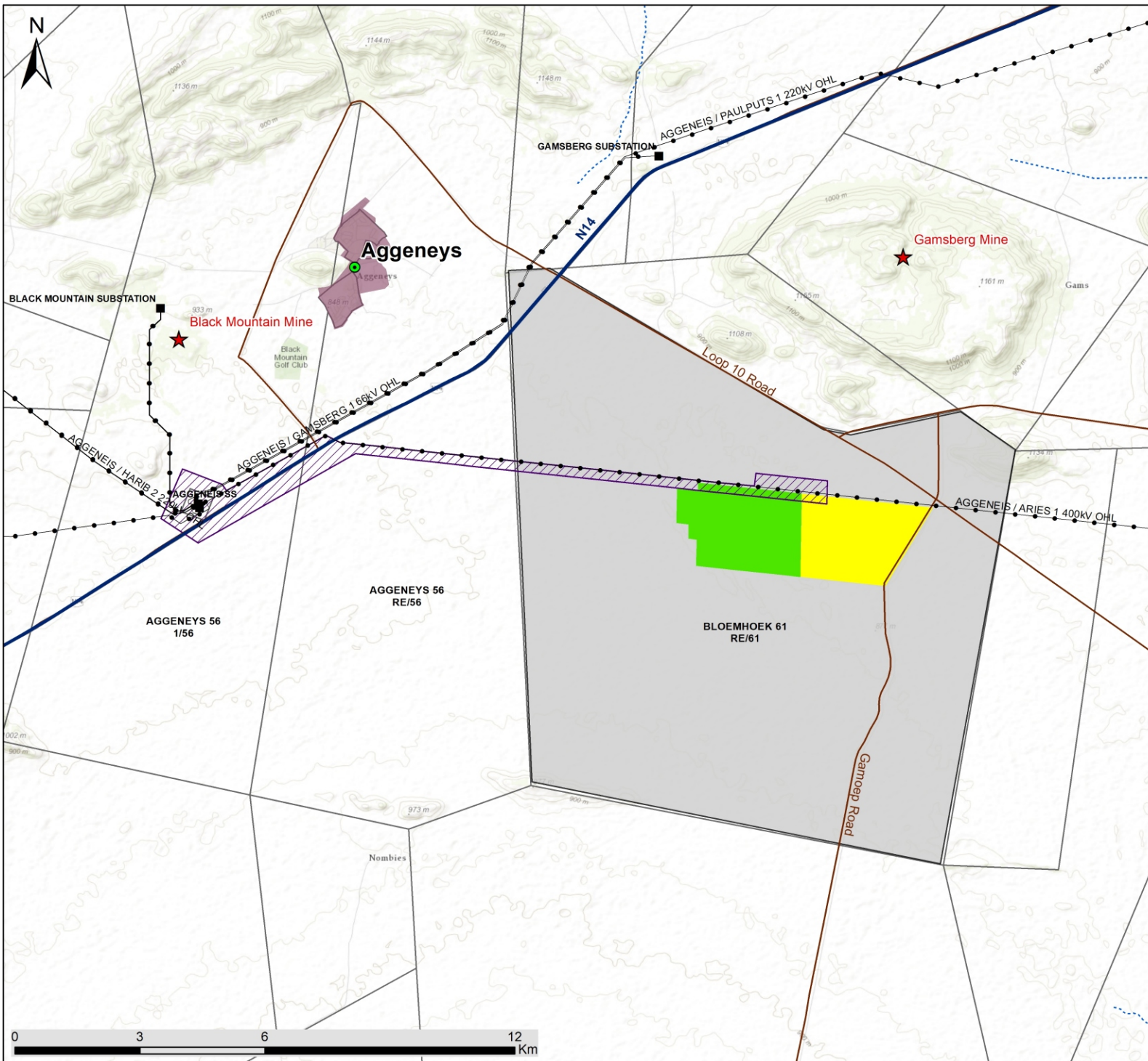

# Geelstert 1 and 2 Solar PV Facilities and Geelstert Grid Connection, Northern Cape

## Locality Map

### Legend

- Town
- ★ Mining Operations
- Eskom Substation
- Existing Power Line
- National Route
- Main Road
- - - Non-perennial River
- Residential Area
- Farm Portion
- Study Area
- Geelstert 1 (Development Area)
- Geelstert 2 (Development Area)
- Geelstert Grid Connection (Power Line Corridor)



Scale: 1:90 218  
 Projection: L019  
 Map Ref: Geelstert 1&2 PV - Locality Map - 13.05.2020

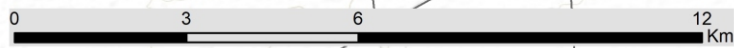
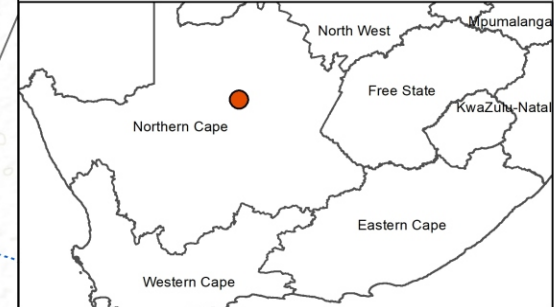

**BASIESE EVALUERING EN OPENBARE DEELNAMEPROSES**

**GEELSTERT 1 EN GEELSTERT 2 FV-SONKRAGAAANLEGTE EN  
VERWANTE ROOSTERKONNEKSIE-OPLOSSING NABY AGGENEYS, NOORD-KAAP PROVINSIE**

**Registrasie- en Kommentaarvorm**

Julie 2020

Stuur voltooide registrasie- en kommentaarvorm aan: **Ronald Baloyi** van **Savannah Environmental**

Foon: 011 656 3237 / Selfoon (ook 'please call me'): 060 978 8396 / Faks: 086 684 0547

E-pos: [publicprocess@savannahsa.com](mailto:publicprocess@savannahsa.com)

Posadres: **Posbus 148, Sunninghill, 2157**

**U registrasie as 'n belanghebbende en/of geaffekteerde party is slegs van toepassing tot hierdie projekte en die voorsiening van u kontakinligting is beskerm deur die Beskerming van Persoonlike Inligting Wet van 2013 (PoPI Act, 2013)**

**Verskaf asseblief u persoonlike kontak besonderhede:**

Naam & Van:		
Organisasie		
Amp- of Postitel		
Posadres:		
Telefoon:		Faks
Selfoon		
E-pos:		

**Stel u belang om te registreer as 'n belangstellende en/of geaffekteerde party (B&GP) op die volgende projekte se databases**

(merk asseblief toepaslike boks met 'n X)

Geestert 1 FV Sonkragaanleg		Geestert 2 FV Sonkragaanleg	
-----------------------------	--	-----------------------------	--

**In terme van die OIE Regulasies, 2014, soos gewysig, Regulasie 43(1), moet u as 'n B&BP registreer om verdere inligting rakende hierdie twee Basiese Evalueringsprojekte te ontvang en u moet ook u direkte besigheid, finansiële, persoonlike of ander belang wat u mag hê rakende in die goedkeuring of afkeuring van die aansoek, vermeld (gebruik addisionele bladsye indien nodig):**

--

**Lys u kommentaar rakende die projek per u keuse bo (gebruik addisionele bladsye indien nodig):**

--

**Verskaf bykomende kontak besonderhede van addisionele persoon/e wie u beskou as potensiële belangstellende en/of geaffekteerde partye**

Naam & Van:	
Posadres:	
Telefoon:	
Selfoon:	
E-pos:	

**SEE REVERSE SIDE FOR ENGLISH**

06 August 2020

Dear Stakeholders,

## DEVELOPMENT OF GEELSTERT 1 AND GEELSTERT 2 SOLAR PV FACILITIES AND GEELSTERT GRID CONNECTION, NEAR AGGENEYS, NORTHERN CAPE

### NOTICE OF BASIC ASSESSMENT AND PUBLIC PARTICIPATION PROCESS

The development of two separate solar photovoltaic (PV) facilities, each with a contracted capacity of up to 125MW, and associated grid connection is proposed on a site located approximately 11km south-east of the town of Aggeneys in the Northern Cape Province. The two solar PV facilities are to be known as Geelstert 1 and Geelstert 2. The grid connection solution will be known as Geelstert Grid Connection. The projects are situated within the Khâi-Ma Local Municipality, in the greater Namakwa District Municipality.

The two solar PV facilities are located on the Remaining Extent of the Farm Bloemhoek 61 and will be connected to the Aggeneis Main Transmission Substation (MTS). The grid connection will include a collector substation and a double-circuit power line of up to 220kV. The grid connection will traverse six (6) properties which include:

Remaining Extent of the Farm Bloemhoek 61	Remaining Extent of the Farm Aggeneys 56
Portion 1 of the Farm Aggeneys 56	Portion 2 of the Farm Aggeneys 56
Portion 12 of the Farm Aggeneys 56	Portion 13 of the Farm Aggeneys 56

It is the Developer's intention to bid each solar PV facility under the Department of Mineral Resources and Energy's<sup>1</sup> Renewable Energy Independent Power Producer Procurement (REIPPP) Programme. The power generated from each solar PV facility will be sold to Eskom and fed into the national electricity grid through the proposed grid connection. The development of the solar PV facilities and the grid connection will assist with the achievement of the electricity goals as set out in the Integrated Resources Plan (IRP), 2019.

The study area is located within Zone 8 of the Renewable Energy Development Zones (REDZ) (also known as the Springbok REDZ).

<sup>1</sup> The Department of Mineral Resources and Energy is a merge between the Department of Mineral Resources (DMR) and the Department of Energy (DoE).

The applicant for each of the solar PV facilities will be a separate Special Purpose Vehicles (SPV). The applicant for Geelstert 1 is Geelstert Solar Facility 1, and the applicant for Geelstert 2 is Geelstert Solar Facility 2 (Pty) Ltd. The applicant for the Geelstert Grid Connection is ABO Wind renewable energies (Pty) Ltd. Three (3) separate Applications for Environmental Authorisation will be submitted to the Department of Environmental Affairs (DEA).

Infrastructure associated with each solar PV facility will include:

- » Solar PV panels.
- » Centralised inverter stations or string inverters.
- » Cabling between the panels, to be laid underground where practical.
- » An on-site facility substation to facilitate the connection between the solar PV facility and the Eskom electricity grid.
- » Site offices and maintenance buildings, including workshop areas for maintenance and storage.
- » Temporary laydown areas.
- » Internal access roads and fencing around the development area.

The Geelstert Grid Connection will be assessed within a grid connection corridor within which grid connection infrastructure will be developed. The grid connection will include a collector substation and an overhead power line with a capacity of up to 220kV, connecting the facilities to the Aggeneis MTS.

Site-specific studies and assessments will be undertaken through the BA processes in order to delineate areas of potential sensitivity within the study area. Once constraining factors have been determined, the layout of each solar PV facility and the grid connection can be planned to minimise social and environmental impacts through appropriate avoidance.

## **BASIC ASSESSMENT PROCESS**

As per the Environmental Impact Assessment Regulations, 2014, as amended, published in terms of Section 24(5) of the National Environmental Management Act (NEMA, Act No 107 of 1998), the proponents will require authorisation from the DEA (in consultation with Northern Cape Department of Environment and Nature Conservation (DENC)) for the development of the projects. In terms of Section 24(5) of NEMA, the EIA Regulations 2014 (as amended), the Government Notice (R114) and Listing Notices (GNR 327, GNR 325, and GNR 324), the three applications for EA are subject to the completion of Basic Assessment (BA) processes (Geelstert 1 and Geelstert 2 are located within the Springbok REDZ). Each application is required to be supported by comprehensive, independent environmental studies undertaken in accordance with the EIA Regulations, 2014 (as amended).

The proponent has appointed Savannah Environmental, as the independent environmental consultant, to undertake the BAs for the projects to identify and assess all potential environmental impacts associated with the projects and recommend appropriate mitigation measures in the Environmental Management Programme (EMPr) for each report. A combined BA and Public Participation Process will be conducted for the three (3) applications. As part of the environmental studies, Interested and Affected Parties (I&APs) will be actively involved through the public involvement process being undertaken by Savannah Environmental.

The Department and/or organisation/company which you represent has been identified as a commenting authority for the proposed projects. In this regard, please can you provide us with the name and contact details of the relevant Official at your Department / Organisation / Company who we need to liaise with regarding these proposed projects. We believe that it would be the same Official at your Department / Organisation / Company who will be submitting written comments on the Basic Assessment Reports, when available for review and comment, as per the Environmental Impact Assessment Regulations, 2014, as amended, Regulations 3(4) and Regulation 19(1)(a).

## **PUBLIC INVOLVEMENT PROCESS**

The public participation (PP) process will be undertaken in accordance with the requirements of Regulations 39 to 44 of the Environmental Impact Assessment (EIA) Regulations, 2014, as amended, (GNR 326). The aim of the public participation process is primarily to ensure that:

- » information containing all relevant facts in respect of the proposed project is made available to potential stakeholders and I&APs
- » participation by I&APs is facilitated in such a manner that all potential stakeholders and I&APs are provided with a reasonable opportunity to comment on the proposed project; and
- » comments received from potential stakeholders and I&APs are recorded and incorporated into the EIA process.

The restrictions enforced in terms of Government Gazette 43096 which placed the country in a national state of disaster limiting the movement and gathering of people to curb the spread of the COVID-19 virus has placed some limitations on how public consultation can be conducted as part of a BA process. The consultation process for these projects has been designed considering these limitations, and the implementation is in line with our public participation plan (PP Plan), as approved by the DEA. Our PP Plan is in compliance with the Department of Environment, Forestry and Fisheries (DEFF) Directions issued on the 5<sup>th</sup> of June 2020. One of our approved consultation methods is for you to visit our online stakeholder engagement platform, register your interest in the project/s, and view project documentation: visit <https://www.savannahsa.com/public-documents/energy-generation/geelstert-1-and-geelstert-2-solar-pv-facilities-and-associated-grid-connection/>.

Alternative means of undertaking consultation have been designed to ensure that I&APs are afforded sufficient opportunity to raise comments on the project, predominately through an interactive web-based platform readily available and accessible to any person with interest in the project, enabling the public participation process to be undertaken in line with Regulations 41 to 44 of the EIA Regulations, 2014, as amended. This online stakeholder engagement platform allows the EAP to visually present details regarding the project and our consultation documentation, including project maps and plans, presentations and posters regarding the project, and reports available for review. The use of online tools enables stakeholders and I&APs to explore the project-specific content in their own time, and allows participation in the consultation process in a meaningful way. The online platform allows for instant feedback and comments to be submitted, in so doing saving time for the stakeholder and also giving the assurance that their comments have been submitted for inclusion in the project reporting.

The benefits of the online stakeholder engagement platform include:

- » Ability to create a dedicated project-specific online platform to enable easy access to project-related information.
- » Ability to reach a wider audience, allowing more widespread consultation for major infrastructure projects.
- » Allowing stakeholders and I&APs the opportunity to engage on a project without leaving their office or home.
- » Enabling stakeholders and I&APs to register their interest in a project (for inclusion on the project database), and automatically gaining access to comprehensive project documentation.
- » Enabling the EAP to maintain a complete database of I&APs through maintaining a record of persons accessing the online stakeholder consultation platform.
- » Enabling the EAP and stakeholders/I&APs to meet virtually.
- » Provides a resilient solution to a public consultation process.

Where I&APs do not have the applicable facilities or access to internet, provision has been made to include these I&APs in the consultation process by consulting with the Ward Councillor, the ward committee members, community representatives and local community forum members.

Should you have an interest in the project, please register yourself as an I&AP on our online stakeholder engagement platform (<https://www.savannahsa.com/public-documents/energy-generation/geelstert-1-and-geelstert-2-solar-pv-facilities-and-associated-grid-connection/>) or by completing and returning the attached stakeholder registration/comment form. By registering on the project database, you will be kept informed of the BA processes being undertaken for the projects and will be provided with an opportunity to provide comment and input.

Please do not hesitate to contact us should you require additional information and/or clarification regarding the project. Our team welcomes your participation and look forward to your involvement throughout this process.

Kind regards



**Nicolene Venter**

Public Participation and Social Consultant

Email: [publicprocess@savannahsa.com](mailto:publicprocess@savannahsa.com)

**Attached:** Background Information Document  
Registration and Comment Form

# GEELSTERT PV1 & PV2: Basic Assessment and Public Participation Process Notification



Savannah Public Process  
To: Ronald Balovi; Nicolene Venter  
Bcc

Reply Reply All Forward

Thu 2020/08/06 21:46

- SE2738-Geelstert BA Process Notification-OoS FINAL.pdf 262 KB
- Geelstert English BID.pdf 2 MB
- Geelstert Afrikaans BID.pdf 2 MB
- SE2738-Geelstert PV1&PV2-RegForm FINAL.pdf 102 KB

## GEELSTERT 1 AND GEELSTERT 2 SOLAR PV FACILITES AND GEELSTERT GRID CONNECTION, NEAR AGGENEYS, NORTHERN CAPE PROVINCE

Dear Stakeholders,

The development of two separate solar photovoltaic (PV) facilities, each with a contracted capacity of up to 125MW, and associated grid connection is proposed on a site located approximately 11km south-east of the town of Aggeneys in the Northern Cape Province. The two solar PV facilities are to be known as Geelstert 1 and Geelstert 2. The grid connection solution will be known as Geelstert Grid Connection. The projects are situated within the Khâi-Ma Local Municipality, in the greater Namakwa District Municipality.

Please find attached the following documents which will provide you with additional information regarding these projects:

- Basic Assessment and Public Participation Process notification letter;
- Background Information Document; and
- Registration and Comment Form.

Please do not hesitate to contact us should you require additional information and/or clarification regarding the projects. Our team welcomes your participation and look forward to your involvement throughout this process.

Kind Regards,

**Ronald Balovi**



SAHRIS

Website Uploads

# Geelstert 1

[Add new comment](#) [Subscribe to: This post](#) 3 reads

**CaseHeader** **LocationInfo** **Admin**

**Status:** SUBMITTED

**HeritageAuthority(s):** SAHRA

NBKB

**Case Type:** Section 38 (8) - Statutory Comment Required

**ProposalDescription:**

The development of two (2) separate solar photovoltaic (PV) facilities, each with a contracted capacity of up to 125MW. The facilities will be connected to the Aggeneis MTS via a collector substation and an overhead power line with capacity of up to 200kV.

**ApplicationDate:** Friday, July 31, 2020 - 16:28

**CaseID:** 15332



**Applicants:** Geelstert Solar Facility 1 (Pty) Ltd

**OtherReferences:**

Dept	CaseReference	DueDate	FinalDecision
DEA			

**ReferenceList:**

## AdditionalDocuments

1.  Geelstert English BID.pdf
2.  Geelstert Afrikaans BID.pdf

Savannah Environmental  
Website Uploads

## Geelstert 1 and Geelstert 2 Solar PV Facilities, and Geelstert Grid Connection

### Notice of Basic Assessment and Public Participation Process for the Geelstert 1 and Geelstert 2 Solar PV Facilities, and Geelstert Grid Connection near Aggeneys, Northern Cape Province

**Proposed Activity:** The development of two (2) separate solar photovoltaic (PV) facilities, each with a contracted capacity of up to 125MW. The facilities will be connected to the Aggeneys MTS via a collector substation and an overhead power line with a capacity of up to 220kV.

**Location:** ~11km south-east of Aggeneys within the Khâi-Ma Local Municipality and the Namakwa District Municipality. The projects fall within the Springbok Renewable Energy Development Zone (or REDZ 8) as well as the Northern Strategic Transmission Corridor.

Applicant:	Project Name:	Affected Property/ies:
Geelstert Solar Facility 1 (Pty) Ltd	Geelstert 1 (solar PV facility)	Remaining Extent of the Farm Bloemhoek 61
Geelstert Solar Facility 2 (Pty) Ltd	Geelstert 2 (solar PV facility)	Remaining Extent of the Farm Bloemhoek 61
ABO Wind renewable energies (Pty) Ltd	Geelstert Grid Connection	Remaining Extent of the Farm Bloemhoek 61 Remaining Extent of the Farm Aggeneys 56  Portion 1 of the Farm Aggeneys 56  Portion 2 of the Farm Aggeneys 56  Portion 12 of the Farm Aggeneys 56  Portion 13 of the Farm Aggeneys 56

The following infrastructure will be developed for the PV facilities and grid connection:

- Solar PV Panels;
- Centralised inverter stations or string inverters;
- Cabling between the panels, to be laid underground where practical;
- Main access roads and internal access roads within the PV panel array areas;
- Temporary laydown areas;
- Operation and Maintenance buildings.
- On-site facility substation;
- A collector substation and an overhead power line to connect the facilities to the Aggeneys Main Transmission Substation (MTS).

**Basic Assessment Process:** In terms of Sections 24 and 24D of the National Environmental Management Act (No 107 of 1998), as read with Government Notice R324 – R327, as amended, and GN R114 (February 2018), a Basic Assessment is required for each Solar PV Facility as well as the Grid Connection. Savannah Environmental is undertaking the required environmental assessment and public participation process for the projects. A separate application for each project has been lodged with the Department of Environmental Affairs (DEA) as the competent authority.

To obtain further information and register on the project database, please submit your name, contact information and interest in the project to:

**Nicolene Venter at Savannah Environmental**  
P.O. Box 148, Sunninghill, 2157

Tel: 011 656 3237

Fax: 086 684 0547

Email: [publicprocess@savannahsa.com](mailto:publicprocess@savannahsa.com)

Website: [www.savannahsa.com](http://www.savannahsa.com)

June 2020

Documents for public review are available for download.

[VIEW DOWNLOAD PAGE](#)

## Correspondence

ESKOM

## Ronald Baloyi

---

**From:** Savannah Public Process  
**Sent:** Wednesday, 19 August 2020 14:03  
**To:** John Geeringh  
**Cc:** Ronald Baloyi; Nicolene Venter  
**Subject:** GEELSTERT 1, GEELSTERT 2 and GEELSTERT GRID CONNECTION: Acknowledgement of comments received and KMZ files  
**Attachments:** Geelstert 1 Area.kmz; Geelstert 2 Area.kmz; Geelstert Grid\_Corridor.shp.kmz

Dear John,

Thank you for the attached information regarding Eskom's general requirements for developments at or near Eskom's servitudes and infrastructure.

These comments are capture in the C&RR and submitted to the clients for their attention.

As requested, please find attached the three (3) .KMZ files for Geelstert 1, Geelstert 2 and Geelstert Grid Connection.

Kind Regards,



t: +27 (0)11 656 3237  
f: +27 (0) 86 684 0547

Nicolene Venter  
**Public Process**

e: [Publicprocess@savannahsa.com](mailto:Publicprocess@savannahsa.com)  
c: +27 (0)60 978 8396

[SAWEA Award for Leading Environmental Consultant on Wind Projects in 2013 & 2015](#)

---

**From:**  
**Sent:** Wednesday, August 19, 2020 11:11 AM  
**To:** Savannah Public Process <[publicprocess@savannahsa.com](mailto:publicprocess@savannahsa.com)>; Ronald Baloyi <[Ronald@savannahsa.com](mailto:Ronald@savannahsa.com)>; Nicolene Venter <[nicolene@savannahsa.com](mailto:nicolene@savannahsa.com)>  
**Subject:** RE: GEELSTERT PV1 & PV2: Basic Assessment and Public Participation Process Notification

Please find attached Eskom general requirements for developments at or near Eskom servitudes and infrastructure. Please send me KMZ files of the affected properties, proposed layouts and proposed grid connections.

Kind regards

John Geeringh (Pr Sci Nat)(EAPASA)  
Senior Consultant Environmental Management  
Land and Rights  
Eskom Transmission Division  
Megawatt Park, D1Y42, Maxwell Drive, Sunninghill, Sandton.

---

**From:** Savannah Public Process [<mailto:publicprocess@savannahsa.com>]  
**Sent:** 06 August 2020 09:47 PM  
**To:** Ronald Baloyi; Nicolene Venter  
**Subject:** GEELSTERT PV1 & PV2: Basic Assessment and Public Participation Process Notification

**GEELSTERT 1 AND GEELSTERT 2 SOLAR PV FACILITES AND GEELSTERT GRID CONNECTION, NEAR AGGENEYS,  
NORTHERN CAPE PROVINCE**

Dear Stakeholders,

The development of two separate solar photovoltaic (PV) facilities, each with a contracted capacity of up to 125MW, and associated grid connection is proposed on a site located approximately 11km south-east of the town of Aggeneys in the Northern Cape Province. The two solar PV facilities are to be known as Geelstert 1 and Geelstert 2. The grid connection solution will be known as Geelstert Grid Connection. The projects are situated within the Khâi-Ma Local Municipality, in the greater Namakwa District Municipality.

Please find attached the following documents which will provide you with additional information regarding these projects:

- Basic Assessment and Public Participation Process notification letter;
- Background Information Document; and
- Registration and Comment Form.

Please do not hesitate to contact us should you require additional information and/or clarification regarding the projects. Our team welcomes your participation and look forward to your involvement throughout this process.

Kind Regards,



t: +27 (0)11 656 3237  
f: +27 (0) 86 684 0547

**Ronald Baloyi**  
Public Participation Co-ordinator and  
Administrator

e: [publicprocess@savannahsa.com](mailto:publicprocess@savannahsa.com)  
c: +27 (0)60 978 8396

SAWEA Award for Leading Environmental Consultant on Wind Projects in 2013 & 2015

NB: This Email and its contents are subject to the Eskom Holdings SOC Ltd EMAIL LEGAL NOTICE which can be viewed at [http://www.eskom.co.za/Pages/Email\\_Legal\\_Spam\\_Disclaimer.aspx](http://www.eskom.co.za/Pages/Email_Legal_Spam_Disclaimer.aspx)



	<b>SCOT</b>	<b>Technology</b>
---	-------------	-------------------

Title: **Renewable Energy Generation Plant Setbacks to Eskom Infrastructure** Unique Identifier: **240-65559775**

Alternative Reference Number: **N/A**

Area of Applicability: **Power Line Engineering**

Documentation Type: **Guideline**

Revision: **1**

Total Pages: **9**

Next Review Date: **N/A**

Disclosure Classification: **CONTROLLED DISCLOSURE**

**Compiled by**



**J W Chetty**  
**Mechanical Engineer**

Date: *23/11/2018*

**Approved by**



**B Ntshuntsha**  
**Chief Engineer (Lines)**

Date: *24/11/2018*

**Authorised by**



**R A Vajeth**  
**Snr Manager (Lines) and SCOT/SCI Chairperson**

Date: *16/11/2018*

## CONTENTS

	Page
<b>EXECUTIVE SUMMARY</b> .....	<b>3</b>
<b>1. INTRODUCTION</b> .....	<b>4</b>
<b>2. SUPPORTING CLAUSES</b> .....	<b>4</b>
2.1 SCOPE .....	4
2.1.1 Purpose .....	4
2.1.2 Applicability .....	5
2.2 NORMATIVE/INFORMATIVE REFERENCES .....	5
2.2.1 Normative .....	5
2.2.2 Informative .....	5
2.3 DEFINITIONS .....	5
2.3.1 Disclosure Classification .....	6
2.4 ABBREVIATIONS .....	6
2.5 ROLES AND RESPONSIBILITIES .....	6
2.6 PROCESS FOR MONITORING .....	6
2.7 RELATED/SUPPORTING DOCUMENTS .....	6
<b>3. DOCUMENT CONTENT</b> .....	<b>6</b>
3.1 INTERNATIONAL SETBACK COMPARISON .....	6
3.2 ESKOM APPROACH FOR WIND FARMS .....	7
<b>4. AUTHORISATION</b> .....	<b>8</b>
<b>5. REVISIONS</b> .....	<b>8</b>
<b>6. DEVELOPMENT TEAM</b> .....	<b>9</b>

## FIGURES

Figure 1: Horizontal Axis Wind Turbine .....	8
--	---

### CONTROLLED DISCLOSURE

When downloaded from the EDMS, this document is uncontrolled and the responsibility rests with the user to ensure it is in line with the authorised version on the system.

## **EXECUTIVE SUMMARY**

In recent decades, the use of wind turbines, concentrated solar plants and photovoltaic plants have been on the increase as it serves as an abundant source of energy. This document specifies setbacks for wind turbines and the reasons for these setbacks from infrastructure as well as setbacks for concentrated solar plants and photovoltaic plants. Setbacks for wind turbines employed in other countries were compared and a general setback to be used by Eskom was suggested for use with wind turbines and other renewable energy generation plants.

### **CONTROLLED DISCLOSURE**

When downloaded from the EDMS, this document is uncontrolled and the responsibility rests with the user to ensure it is in line with the authorised version on the system.

## **1. INTRODUCTION**

During the last few decades, a large amount of wind turbines have been installed in wind farms to accommodate for the large demand of energy and depleting fossil fuels. Wind is one of the most abundant sources of renewable energy. Wind turbines harness the energy of this renewable resource for integration in electricity networks. The extraction of wind energy is its primary function and thus the aerodynamics of the wind turbine is important. There are many different types of wind turbines which will all exhibit different wind flow characteristics. The most common wind turbine used commercially is the Horizontal Axis Wind Turbine. Wind flow characteristics of this turbine are important to analyse as it may have an effect on surrounding infrastructure.

Wind turbines also cause large turbulence downwind that may affect existing infrastructure. Debris or parts of the turbine blade, in the case of a failure, may be tossed behind the turbine and may lead to damage of infrastructure in the wake path.

This document outlines the minimum distances that need to be introduced between a wind turbine and Eskom infrastructure to ensure that debris and / or turbulence would not negatively impact on the infrastructure.

Safety distances of wind turbines from other structures as implemented by other countries were also considered and the reasons for their selection were noted.

Concentrated solar plants and photovoltaic plants setbacks away from substations were also to be considered to prevent restricting possible power line access routes to the substation.

## **2. SUPPORTING CLAUSES**

### **2.1 SCOPE**

This document provides guidance on the safe distance that a wind turbine should be located from any Eskom power line or substation. The document specifies setback distances for transmission lines (220 kV to 765 kV), distribution lines (6.6 kV to 132 kV) and all Eskom substations. Setbacks for concentrated solar plants and photovoltaic plants are also specified away from substations.

#### **2.1.1 Purpose**

Setbacks for wind turbines and power lines / substations are required for various reasons. These include possible catastrophic failure of the turbine blade that may release fragments and which may be thrown onto nearby power lines that may result in damage with associated unplanned outages. Turbulence behind the turbine may affect helicopter flight during routine Eskom live line maintenance and

### **CONTROLLED DISCLOSURE**

When downloaded from the EDMS, this document is uncontrolled and the responsibility rests with the user to ensure it is in line with the authorised version on the system.

inspections that may lead to safety risk of the aircraft / personnel. Concentrated solar plants and photovoltaic plants setback away from substations were required to prevent substations from being boxed in by these renewable generation plants limiting line route access to the substations.

### 2.1.2 Applicability

This document is applicable to the siting of all new and existing wind turbines, concentrated solar plants and photovoltaic plants near power lines and substations.

## 2.2 NORMATIVE/INFORMATIVE REFERENCES

### 2.2.1 Normative

1. <http://www.envir.ee/orb.aw/class=file/action=preview/id=1170403/Hiiumaa+turbulence+impact+EMD.pdf>.
2. <http://www.energy.ca.gov/2005publications/CEC-500-2005-184/CEC-500-2005-184.PDF>
3. <http://www.adamscountywind.com/Revised%20Site/Windmills/Adams%20County%20Ordinance/Adams%20County%20Wind%20Ord.htm>
4. [http://www.dsireusa.org/incentives/incentive.cfm?Incentive\\_Code=PA11R&RE=1&EE=1](http://www.dsireusa.org/incentives/incentive.cfm?Incentive_Code=PA11R&RE=1&EE=1)
5. <http://www.wind-watch.org/documents/european-setbacks-minimum-distance-between-wind-turbines-and-habitations/>
6. <http://www.publications.parliament.uk/pa/ld201011/ldbills/017/11017.1-i.html>
7. [http://www.caw.ca/assets/pdf/Turbine\\_Safety\\_Report.pdf](http://www.caw.ca/assets/pdf/Turbine_Safety_Report.pdf)
8. Rogers J, Slegers N, Costello M. (2011) A method for defining wind turbine setback standards. Wind energy 10.1002/we.468

### 2.2.2 Informative

None

## 2.3 DEFINITIONS

Definition	Description
Setback	The minimum distance between a wind turbine and boundary line/dwelling/road/infrastructure/servitude etc.
Flicker	Effect caused when rotating wind turbine blades periodically cast shadows
Tip Height	The total height of the wind turbine ie. Hub height plus half rotor diameter (see Figure1)

### CONTROLLED DISCLOSURE

When downloaded from the EDMS, this document is uncontrolled and the responsibility rests with the user to ensure it is in line with the authorised version on the system.

### 2.3.1 Disclosure Classification

**Controlled disclosure:** controlled disclosure to external parties (either enforced by law, or discretionary).

## 2.4 ABBREVIATIONS

Abbreviation	Description
None	

## 2.5 ROLES AND RESPONSIBILITIES

All personnel involved in the positioning wind turbines, concentrated solar plants and photovoltaic plants near power lines/substations must follow the setbacks outlined in this guideline.

## 2.6 PROCESS FOR MONITORING

Approval by Eskom in writing.

## 2.7 RELATED/SUPPORTING DOCUMENTS

None

## 3. DOCUMENT CONTENT

### 3.1 INTERNATIONAL SETBACK COMPARISON

Wind Turbine setbacks employed by various countries were considered. It was found that setbacks were determined for various reasons that include noise, flicker, turbine blade failure and wind effects. The distances (setbacks) varied based on these factors and were influenced by the type of infrastructure

Wind turbine setbacks varied for roads, power lines, dwellings, buildings and property and it was noted that the largest setbacks were employed for reasons of noise and flicker related issues [1-7]. Very few countries specified setbacks for power lines.

The literature survey [1-7], yielded information about studies and experiments were conducted to determine the distance that a broken fragment from a wind turbine might be thrown. Even though of low probability of hitting a power line [ $5.0 \times 10^{-5}$ ]<sup>[8]</sup>, the distances recorded were significant [750m]<sup>[8]</sup>

Setbacks were thus introduced to prevent any damage to Eskom infrastructure.

### CONTROLLED DISCLOSURE

When downloaded from the EDMS, this document is uncontrolled and the responsibility rests with the user to ensure it is in line with the authorised version on the system.

Wind turbines may also cause changes in wind patterns with turbulent effects behind the hub. These factors dictate the wind turbine setbacks specified in this document.

Concentrated solar plants and photovoltaic plants also can limit access into the substation for power lines of all voltages. A setback distance must therefore be employed to prevent the substation from being boxed in by these generation plants. These setback distances are specified in this document.

### **3.2 ESKOM REQUIRED SETBACKS**

A formal application must be sent to and accepted by Eskom if any of the below mentioned setback distances are infringed upon:

- Eskom requires a setback distance of 3 times the tip height of the wind turbine from the edge of the closest Eskom servitude (including vacant servitudes) for transmission lines (220kV to 765kV) and Substations.
- Eskom requires a setback distance of 1 times the tip height of the wind turbine from the edge of the closest Eskom servitude (including vacant servitudes) for distribution lines (66 kV to 132 kV) and Substations.
- An application must be sent to Eskom regarding any proposed wind turbine, concentrated solar plants and photovoltaic activity within a 5 km radius of a substation for Eskom to comment on the application.
- Where concentrated solar plants and photovoltaic structures fall within a 2 km radius of the closest point of a transmission or distribution substation (66kV to 765kV), Eskom should be applied to for approval in writing during the planning phase of such plant or structures.
- Applicants must not position any wind turbine in the line of site between and two Eskom Radio Telecommunication masts. It must be proven that Eskom radio telecommunication systems (mainly microwave systems) will not be affected in any way by wind turbines.
- If the position or size of any turbine changes and subsequently infringes on any of the above stated setbacks, an application must be sent through to Eskom as per the point mentioned above.

#### **CONTROLLED DISCLOSURE**

When downloaded from the EDMS, this document is uncontrolled and the responsibility rests with the user to ensure it is in line with the authorised version on the system.

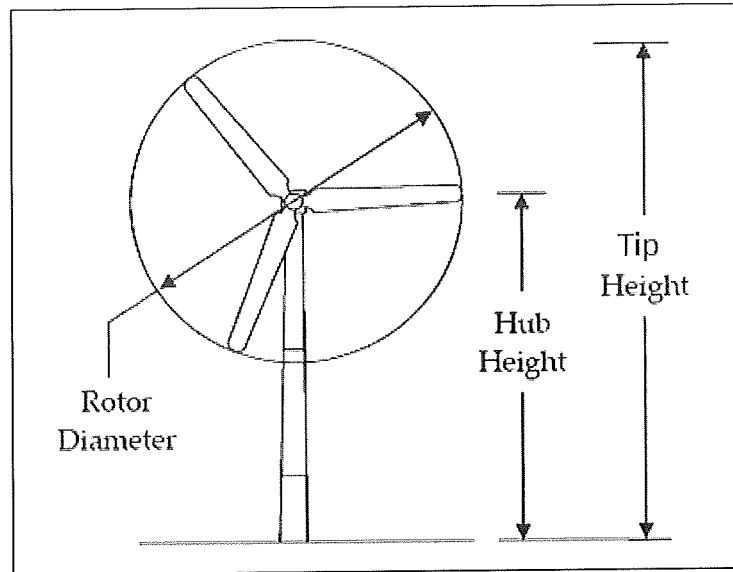

Figure 1: Horizontal Axis Wind Turbine <sup>[2]</sup>

**4. AUTHORISATION**

This document has been seen and accepted by:

Name & Surname	Designation
V Naidoo	Chief Engineer
Dr P H Pretorius	Electrical Specialist
J Geeringh	Snr Consultant Environ Mngt
B Haridass	Snr Consultant Engineer
R A Vajeth	Acting Snr Manager (Lines)

**5. REVISIONS**

Date	Rev.	Compiler	Remarks
November 2013	0	J W Chetty	First Publication - No renewable energy generation plant setback specification in existence
October 2018	1	JW Chetty	Modification to sub-section 3.2 to provide more clarity for application procedure

**CONTROLLED DISCLOSURE**

When downloaded from the EDMS, this document is uncontrolled and the responsibility rests with the user to ensure it is in line with the authorised version on the system.



## 6. DEVELOPMENT TEAM

The following people were involved in the development of this document:

Jonathan W Chetty (Mechanical Engineer)

Vivendhra Naidoo (Chief Engineer)

Dr Pieter H Pretorius (Electrical Specialist)

John Geeringh (Snr Consultant Environ Mngt)

Bharat Haridass (Snr Consultant Engineer)

Riaz A Vajeth (Acting Snr Manager (Lines))

### CONTROLLED DISCLOSURE

When downloaded from the EDMS, this document is uncontrolled and the responsibility rests with the user to ensure it is in line with the authorised version on the system.

Notification of availability of BAR for review and comment

19 August 2020

Dear Stakeholder and Interested and/or Affected Party,

## GEELSTERT 1 AND GEELSTERT 2 SOLAR PV FACILITIES AND GEELSTERT GRID CONNECTION NEAR AGGENEYS, NORTHERN CAPE PROVINCE

---

### NOTICE OF AVAILABILITY OF BASIC ASSESSMENT REPORTS FOR REVIEW AND COMMENTS

---

The development of two separate solar photovoltaic (PV) facilities, each with a contracted capacity of up to 125MW, and associated grid connection is proposed on a site located approximately 11km south-east of the town of Aggeneys in the Northern Cape Province. The two solar PV facilities are to be known as Geelstert 1 and Geelstert 2. The grid connection solution will be known as Geelstert Grid Connection. The projects are situated within the Khâi-Ma Local Municipality, in the greater Namakwa District Municipality.

The two solar PV facilities are located on the Remaining Extent of the Farm Bloemhoek 61 and will be connected to the Aggeneis Main Transmission Substation (MTS). The grid connection will include a collector substation and a double-circuit power line of up to 220kV. The grid connection will traverse six (6) properties which include:

Remaining Extent of the Farm Bloemhoek 61	Remaining Extent of the Farm Aggeneys 56
Remaining Extent of Portion 1 of the Farm Aggeneys 56	Portion 2 of the Farm Aggeneys 56
Portion 12 of the Farm Aggeneys 56	Portion 13 of the Farm Aggeneys 56

It is the Developer's intention to bid each solar PV facility under the Department of Mineral Resources and Energy's<sup>1</sup> Renewable Energy Independent Power Producer Procurement (REIPPP) Programme. The power generated from each solar PV facility will be sold to Eskom and fed into the national electricity grid through the proposed grid connection. The development of the solar PV facilities and the grid connection will assist with the achievement of the electricity goals as set out in the Integrated Resources Plan (IRP), 2019.

The study area is located within Zone 8 of the Renewable Energy Development Zones (REDZ) (also known as the Springbok REDZ).

<sup>1</sup> The Department of Mineral Resources and Energy is a merge between the Department of Mineral Resources (DMR) and the Department of Energy (DoE).

The applicant for each of the solar PV facilities will be a separate Special Purpose Vehicles (SPV). The applicant for Geelstert 1 is Geelstert Solar Facility 1 (Pty) Ltd, and the applicant for Geelstert 2 is Geelstert Solar Facility 2 (Pty) Ltd. The applicant for the Geelstert Grid Connection is ABO Wind renewable energies (Pty) Ltd. Three (3) separate Applications for Environmental Authorisation have been submitted to the Department of Environmental Affairs (DEA).

The notification of the development of two 125MW solar photovoltaic (PV) facilities and the associated grid connection distributed on 13 July 2020, has reference. The notification letter was accompanied by the Background Information Document (BID) which provided information regarding these Basic Assessment (BA) processes. If you have not received these documents, please inform us accordingly or we encourage you to visit our online stakeholder engagement platform at <https://www.savannahsa.com/public-documents/energy-generation/geelstert-1-and-geelstert-2-solar-pv-facilities-and-associated-grid-connection/> where the public documents for these three (3) projects are available for your perusal.

### **AVAILABILITY OF BASIC ASSESSMENT REPORTS FOR REVIEW AND COMMENT**

As a registered Interested and Affected Party (I&AP), you are hereby notified that the following three Basic Assessment Reports (BARs) are available for your review and comment from **Thursday, 20 August 2020** until **Monday, 21 September 2020**.

<b>Applicant name</b>	<b>Project/BA Report</b>
Geelstert Solar Facility 1 (Pty) Ltd	Geelstert 1
Geelstert Solar Facility 2 (Pty) Ltd	Geelstert 2
ABO Wind renewable energies (Pty) Ltd	Geelstert Grid Connection

The reports are available for downloading from our public participation platform at [www.savannahsa.com/public-documents/energy-generation/geelstert-1-and-geelstert-2-solar-pv-facilities-and-associated-grid-connection/](http://www.savannahsa.com/public-documents/energy-generation/geelstert-1-and-geelstert-2-solar-pv-facilities-and-associated-grid-connection/).

The restrictions enforced in terms of Government Gazette 43096 which placed the country in a national state of disaster limiting the movement and gathering of people to curb the spread of the COVID-19 virus has placed some limitations on making hard copies of the BARs available at public places such as libraries and municipal offices. As per our approved public participation plan submitted to the Department of Environmental Affairs (DEA), you can also request that an electronic copy of the BARs be sent to you via file transfer services such as WeTransfer or Dropbox.

Please submit your written comments on the BARs by **Monday, 21 September 2020** via our public participation portal (link provided above) or:

- » Telephone: 011 656 3237
- » Mobile: 060 978 8396
- » Fax: 086 684 0547
- » Post: PO Box 148, Sunninghill, 2157
- » E-mail: [publicprocess@savannahsa.com](mailto:publicprocess@savannahsa.com)

All comments can be addressed to Ronald Baloyi of Savannah Environmental.

All comments received during the 30-day review and comment period will be recorded and included in the Final BARs for submission to the DEA in line with Regulation 44 of the EIA Regulations, 2014, as amended (GN R326).

Please do not hesitate to contact us should you require additional information and/or clarification regarding the project. Our team welcomes your participation and look forward to your involvement throughout this process.

Kind regards

A handwritten signature in black ink, appearing to read 'Nicolene Venter', written in a cursive style.

**Nicolene Venter**

Public Participation and Social Consultant

Email: [publicprocess@savannahsa.com](mailto:publicprocess@savannahsa.com)

19 August 2020

Mr Nicol Jansen  
President: Agri Northern Cape

E-mail: [REDACTED]

Dear Mr Jansen

## GEELSTERT 1 AND GEELSTERT 2 SOLAR PV FACILITIES AND GEELSTERT GRID CONNECTION NEAR AGGENEYS, NORTHERN CAPE PROVINCE

### NOTICE OF AVAILABILITY OF BASIC ASSESSMENT REPORTS FOR REVIEW AND COMMENTS

The development of two separate solar photovoltaic (PV) facilities, each with a contracted capacity of up to 125MW, and associated grid connection is proposed on a site located approximately 11km south-east of the town of Aggeneys in the Northern Cape Province. The two solar PV facilities are to be known as Geelstert 1 and Geelstert 2. The grid connection solution will be known as Geelstert Grid Connection. The projects are situated within the Khâi-Ma Local Municipality, in the greater Namakwa District Municipality.

The two solar PV facilities are located on the Remaining Extent of the Farm Bloemhoek 61 and will be connected to the Aggeneys Main Transmission Substation (MTS). The grid connection will include a collector substation and a double-circuit power line of up to 220kV. The grid connection will traverse six (6) properties which include:

Remaining Extent of the Farm Bloemhoek 61	Remaining Extent of the Farm Aggeneys 56
Remaining Extent of Portion 1 of the Farm Aggeneys 56	Portion 2 of the Farm Aggeneys 56
Portion 12 of the Farm Aggeneys 56	Portion 13 of the Farm Aggeneys 56

It is the Developer's intention to bid each solar PV facility under the Department of Mineral Resources and Energy's<sup>1</sup> Renewable Energy Independent Power Producer Procurement (REIPPP) Programme. The power generated from each solar PV facility will be sold to Eskom and fed into the national electricity grid through the proposed grid connection. The development of the solar PV facilities and the grid connection will assist with the achievement of the electricity goals as set out in the Integrated Resources Plan (IRP), 2019.

<sup>1</sup> The Department of Mineral Resources and Energy is a merge between the Department of Mineral Resources (DMR) and the Department of Energy (DoE).

The study area is located within Zone 8 of the Renewable Energy Development Zones (REDZ) (also known as the Springbok REDZ).

The applicant for each of the solar PV facilities will be a separate Special Purpose Vehicles (SPV). The applicant for Geelstert 1 is Geelstert Solar Facility 1 (Pty) Ltd, and the applicant for Geelstert 2 is Geelstert Solar Facility 2 (Pty) Ltd. The applicant for the Geelstert Grid Connection is ABO Wind renewable energies (Pty) Ltd. Three (3) separate Applications for Environmental Authorisation have been submitted to the Department of Environmental Affairs (DEA).

The notification of the development of two 125MW solar photovoltaic (PV) facilities and the associated grid connection distributed on 13 July 2020, has reference. The notification letter was accompanied by the Background Information Document (BID) which provided information regarding these Basic Assessment (BA) processes. If you have not received these documents, please inform us accordingly or we encourage you to visit our online stakeholder engagement platform at [www.savannahsa.com/public-documents/energy-generation/geelstert-1-and-geelstert-2-solar-pv-facilities-and-associated-grid-connection/](http://www.savannahsa.com/public-documents/energy-generation/geelstert-1-and-geelstert-2-solar-pv-facilities-and-associated-grid-connection/) the public documents for these three (3) projects are available for your perusal.

#### **AVAILABILITY OF BASIC ASSESSMENT REPORTS FOR REVIEW AND COMMENT**

In terms of Regulation 43(2) of the EIA Regulations, 2014, as amended, this letter serves to inform you that the Basic Assessment Reports (BARs) are available for review and written comments. The BARs' review and comment period is from **Thursday, 20 August 2020 until Monday, 21 September 2020**.

<b>Applicant name</b>	<b>Project/BA Report</b>
Geelstert Solar Facility 1 (Pty) Ltd	Geelstert 1
Geelstert Solar Facility 2 (Pty) Ltd	Geelstert 2
ABO Wind renewable energies (Pty) Ltd	Geelstert Grid Connection

The reports are available for downloading from our public participation platform at [www.savannahsa.com/public-documents/energy-generation/geelstert-1-and-geelstert-2-solar-pv-facilities-and-associated-grid-connection/](http://www.savannahsa.com/public-documents/energy-generation/geelstert-1-and-geelstert-2-solar-pv-facilities-and-associated-grid-connection/)

The restrictions enforced in terms of Government Gazette 43096 which placed the country in a national state of disaster limiting the movement and gathering of people to curb the spread of the COVID-19 virus has placed some limitations on making hard copies of the BARs available at public places such as libraries and municipal offices. As per our approved public participation plan submitted to the Department of Environmental Affairs (DEA), you can also request that an electronic copy of the BARs be sent to you via file transfer services such as WeTransfer or Dropbox.

Please submit your written comments on the BARs by **Monday, 21 September 2020** via our public participation portal (link provided above) or:

- » Telephone: 011 656 3237
- » Mobile: 060 978 8396
- » Fax: 086 684 0547
- » Post: PO Box 148, Sunninghill, 2157
- » E-mail: [publicprocess@savannahsa.com](mailto:publicprocess@savannahsa.com)

All comments can be addressed to Ronald Baloyi of Savannah Environmental.

All comments received during the 30-day review and comment period will be recorded and included in the Final BARs for submission to the DEA in line with Regulation 44 of the EIA Regulations, 2014, as amended (GN R326).

Please do not hesitate to contact us should you require additional information and/or clarification regarding the project. Our team welcomes your participation and look forward to your involvement throughout this process.

Kind regards

A handwritten signature in black ink, appearing to read "Nicolene Venter". The signature is written in a cursive, flowing style.

**Nicolene Venter**

Public Participation and Social Consultant

Email: [publicprocess@savannahsa.com](mailto:publicprocess@savannahsa.com)



Jansen, Nicol - Agri Northern Cape



Date: 8/19/2020  
Time: 5:01 PM  
Creator: Ronald Baloyi Baloyi

Note

---

Subject: GEELSTERT 1 & 2 and GRID CONNECTION: Notification of the Availability of the Basic Assessment for review and comment

Body:

**GEELSTERT 1 AND GEELSTERT 2 SOLAR PV FACILITIES AND GEELSTERT GRID CONNECTION NEAR AGGENEYS, NORTHERN CAPE PROVINCE**

Dear Mr Jansen,

The development of two separate solar photovoltaic (PV) facilities, each with a contracted capacity of up to 125MW, and associated grid connection is proposed on a site located approximately 11km south-east of the town of Aggeneys in the Northern Cape Province. The two solar PV facilities are to be known as Geelstert 1 and Geelstert 2. The grid connection solution will be known as Geelstert Grid Connection. The projects are situated within the Khâi-Ma Local Municipality, in the greater Namakwa District Municipality.

As a registered Interested and Affected Party (I&AP), you are hereby notified that the following three Basic Assessment Reports (BARs) are available for your review and comment from Thursday, 20 August 2020 until Monday, 21 September 2020. The reports are available for download from our website / stakeholder engagement platform on the above-mentioned link.

The restrictions enforced in terms of the Government Gazette 43096 which placed the country in a national state of disaster limiting the movement and gathering of people to curb the spread of the COVID-19 virus has placed some limitations on making hard copies of the BARs at the public places such as Libraries. We invite you to visit our online stakeholder engagement platform at <https://www.savannahsa.com/public-documents/energy-generation/geelstert-1-and-geelstert-2-solar-pv-facilities-and-associated-grid-connection/>

Should you not be able to access our online stakeholder engagement platform to download the BARs, please refer to the attached letter for alternative means to obtain the BARs. The attached letter also provides further details regarding the availability of the BARs.

Kind regards,

--

A large black rectangular redaction box covering the sender's signature and name.

Please refer to the email saved in the Documents window.

19 August 2020

Ms Simphiwe Masilela  
Obstacle Evaluator  
Air Traffic and Navigation Services

E-mail:

Dear Ms Masilela,

## **GEELSTERT 1 AND GEELSTERT 2 SOLAR PV FACILITIES AND GEELSTERT GRID CONNECTION NEAR AGGENEYS, NORTHERN CAPE PROVINCE**

### **NOTICE OF AVAILABILITY OF BASIC ASSESSMENT REPORTS FOR REVIEW AND COMMENTS**

The development of two separate solar photovoltaic (PV) facilities, each with a contracted capacity of up to 125MW, and associated grid connection is proposed on a site located approximately 11km south-east of the town of Aggeneys in the Northern Cape Province. The two solar PV facilities are to be known as Geelstert 1 and Geelstert 2. The grid connection solution will be known as Geelstert Grid Connection. The projects are situated within the Khâi-Ma Local Municipality, in the greater Namakwa District Municipality.

The two solar PV facilities are located on the Remaining Extent of the Farm Bloemhoek 61 and will be connected to the Aggeneys Main Transmission Substation (MTS). The grid connection will include a collector substation and a double-circuit power line of up to 220kV. The grid connection will traverse six (6) properties which include:

Remaining Extent of the Farm Bloemhoek 61	Remaining Extent of the Farm Aggeneys 56
Remaining Extent of Portion 1 of the Farm Aggeneys 56	Portion 2 of the Farm Aggeneys 56
Portion 12 of the Farm Aggeneys 56	Portion 13 of the Farm Aggeneys 56

It is the Developer's intention to bid each solar PV facility under the Department of Mineral Resources and Energy's<sup>1</sup> Renewable Energy Independent Power Producer Procurement (REIPPP) Programme. The power generated from each solar PV facility will be sold to Eskom and fed into the national electricity grid through the proposed grid connection. The development of the solar PV facilities and the grid connection will assist with the achievement of the electricity goals as set out in the Integrated Resources Plan (IRP), 2019.

<sup>1</sup> The Department of Mineral Resources and Energy is a merge between the Department of Mineral Resources (DMR) and the Department of Energy (DoE).

The study area is located within Zone 8 of the Renewable Energy Development Zones (REDZ) (also known as the Springbok REDZ).

The applicant for each of the solar PV facilities will be a separate Special Purpose Vehicles (SPV). The applicant for Geelstert 1 is Geelstert Solar Facility 1 (Pty) Ltd, and the applicant for Geelstert 2 is Geelstert Solar Facility 2 (Pty) Ltd. The applicant for the Geelstert Grid Connection is ABO Wind renewable energies (Pty) Ltd. Three (3) separate Applications for Environmental Authorisation have been submitted to the Department of Environmental Affairs (DEA).

The notification of the development of two 125MW solar photovoltaic (PV) facilities and the associated grid connection distributed on 13 July 2020, has reference. The notification letter was accompanied by the Background Information Document (BID) which provided information regarding these Basic Assessment (BA) processes. If you have not received these documents, please inform us accordingly or we encourage you to visit our online stakeholder engagement platform at [www.savannahsa.com/public-documents/energy-generation/geelstert-1-and-geelstert-2-solar-pv-facilities-and-associated-grid-connection/](http://www.savannahsa.com/public-documents/energy-generation/geelstert-1-and-geelstert-2-solar-pv-facilities-and-associated-grid-connection/) the public documents for these three (3) projects are available for your perusal.

#### **AVAILABILITY OF BASIC ASSESSMENT REPORTS FOR REVIEW AND COMMENT**

In terms of Regulation 43(2) of the EIA Regulations, 2014, as amended, this letter serves to inform you that the Basic Assessment Reports (BARs) are available for review and written comments. The BARs' review and comment period is from **Thursday, 20 August 2020 until Monday, 21 September 2020**.

<b>Applicant name</b>	<b>Project/BA Report</b>
Geelstert Solar Facility 1 (Pty) Ltd	Geelstert 1
Geelstert Solar Facility 2 (Pty) Ltd	Geelstert 2
ABO Wind renewable energies (Pty) Ltd	Geelstert Grid Connection

The reports are available for downloading from our public participation platform at [www.savannahsa.com/public-documents/energy-generation/geelstert-1-and-geelstert-2-solar-pv-facilities-and-associated-grid-connection/](http://www.savannahsa.com/public-documents/energy-generation/geelstert-1-and-geelstert-2-solar-pv-facilities-and-associated-grid-connection/)

The restrictions enforced in terms of Government Gazette 43096 which placed the country in a national state of disaster limiting the movement and gathering of people to curb the spread of the COVID-19 virus has placed some limitations on making hard copies of the BARs available at public places such as libraries and municipal offices. As per our approved public participation plan submitted to the Department of Environmental Affairs (DEA), you can also request that an electronic copy of the BARs be sent to you via file transfer services such as WeTransfer or Dropbox.

Please submit your written comments on the BARs by **Monday, 21 September 2020** via our public participation portal (link provided above) or:

- » Telephone: 011 656 3237
- » Mobile: 060 978 8396
- » Fax: 086 684 0547
- » Post: PO Box 148, Sunninghill, 2157
- » E-mail: [publicprocess@savannahsa.com](mailto:publicprocess@savannahsa.com)

All comments can be addressed to Ronald Baloyi of Savannah Environmental.

All comments received during the 30-day review and comment period will be recorded and included in the Final BARs for submission to the DEA in line with Regulation 44 of the EIA Regulations, 2014, as amended (GN R326).

Please do not hesitate to contact us should you require additional information and/or clarification regarding the project. Our team welcomes your participation and look forward to your involvement throughout this process.

Kind regards

A handwritten signature in black ink, appearing to read "Nicolene Venter". The signature is written in a cursive, flowing style.

**Nicolene Venter**

Public Participation and Social Consultant

Email: [publicprocess@savannahsa.com](mailto:publicprocess@savannahsa.com)

**Masilela, Simphiwe - Air Traffic and Navigation Services (ATNS)**

Date: 8/19/2020  
Time: 5:10 PM  
Creator: Ronald Baloyi Baloyi

## Note

Subject: GEELSTERT 1 & 2 and GRID CONNECTION: Notification of the Availability of the Basic Assessment for review and comment

## Body:

**GEELSTERT 1 AND GEELSTERT 2 SOLAR PV FACILITIES AND GEELSTERT GRID CONNECTION NEAR AGGENEYS, NORTHERN CAPE PROVINCE**

Dear Mr Masilela,

The development of two separate solar photovoltaic (PV) facilities, each with a contracted capacity of up to 125MW, and associated grid connection is proposed on a site located approximately 11km south-east of the town of Aggeneys in the Northern Cape Province. The two solar PV facilities are to be known as Geelstert 1 and Geelstert 2. The grid connection solution will be known as Geelstert Grid Connection. The projects are situated within the Khâi-Ma Local Municipality, in the greater Namakwa District Municipality.

As a registered Interested and Affected Party (I&AP), you are hereby notified that the following three Basic Assessment Reports (BARs) are available for your review and comment from Thursday, 20 August 2020 until Monday, 21 September 2020. The reports are available for download from our website / stakeholder engagement platform on the above-mentioned link.

The restrictions enforced in terms of the Government Gazette 43096 which placed the country in a national state of disaster limiting the movement and gathering of people to curb the spread of the COVID-19 virus has placed some limitations on making hard copies of the BARs at the public places such as Libraries. We invite you to visit our online stakeholder engagement platform at <https://www.savannahsa.com/public-documents/energy-generation/geelstert-1-and-geelstert-2-solar-pv-facilities-and-associated-grid-connection/>

Should you not be able to access our online stakeholder engagement platform to download the BARs, please refer to the attached letter for alternative means to obtain the BARs. The attached letter also provides further details regarding the availability of the BARs.

Kind regards,

--

Please refer to the email saved in the Documents window.

19 August 2020

Ms Samantha Ralston-Paton  
Birds & Renewable Energy Manager  
BirdLife South Africa

E-mail: [REDACTED]

Dear Ms Ralston-Paton,

## **GEELSTERT 1 AND GEELSTERT 2 SOLAR PV FACILITIES AND GEELSTERT GRID CONNECTION NEAR AGGENEYS, NORTHERN CAPE PROVINCE**

---

### **NOTICE OF AVAILABILITY OF BASIC ASSESSMENT REPORTS FOR REVIEW AND COMMENTS**

---

The development of two separate solar photovoltaic (PV) facilities, each with a contracted capacity of up to 125MW, and associated grid connection is proposed on a site located approximately 11km south-east of the town of Aggeneys in the Northern Cape Province. The two solar PV facilities are to be known as Geelstert 1 and Geelstert 2. The grid connection solution will be known as Geelstert Grid Connection. The projects are situated within the Khâi-Ma Local Municipality, in the greater Namakwa District Municipality.

The two solar PV facilities are located on the Remaining Extent of the Farm Bloemhoek 61 and will be connected to the Aggeneys Main Transmission Substation (MTS). The grid connection will include a collector substation and a double-circuit power line of up to 220kV. The grid connection will traverse six (6) properties which include:

Remaining Extent of the Farm Bloemhoek 61	Remaining Extent of the Farm Aggeneys 56
Remaining Extent of Portion 1 of the Farm Aggeneys 56	Portion 2 of the Farm Aggeneys 56
Portion 12 of the Farm Aggeneys 56	Portion 13 of the Farm Aggeneys 56

It is the Developer's intention to bid each solar PV facility under the Department of Mineral Resources and Energy's<sup>1</sup> Renewable Energy Independent Power Producer Procurement (REIPPP) Programme. The power generated from each solar PV facility will be sold to Eskom and fed into the national electricity grid through the proposed grid connection. The development of the solar PV facilities and the grid connection will assist with the achievement of the electricity goals as set out in the Integrated Resources Plan (IRP), 2019.

<sup>1</sup> The Department of Mineral Resources and Energy is a merge between the Department of Mineral Resources (DMR) and the Department of Energy (DoE).

The study area is located within Zone 8 of the Renewable Energy Development Zones (REDZ) (also known as the Springbok REDZ).

The applicant for each of the solar PV facilities will be a separate Special Purpose Vehicles (SPV). The applicant for Geelstert 1 is Geelstert Solar Facility 1 (Pty) Ltd, and the applicant for Geelstert 2 is Geelstert Solar Facility 2 (Pty) Ltd. The applicant for the Geelstert Grid Connection is ABO Wind renewable energies (Pty) Ltd. Three (3) separate Applications for Environmental Authorisation have been submitted to the Department of Environmental Affairs (DEA).

The notification of the development of two 125MW solar photovoltaic (PV) facilities and the associated grid connection distributed on 13 July 2020, has reference. The notification letter was accompanied by the Background Information Document (BID) which provided information regarding these Basic Assessment (BA) processes. If you have not received these documents, please inform us accordingly or we encourage you to visit our online stakeholder engagement platform at [www.savannahsa.com/public-documents/energy-generation/geelstert-1-and-geelstert-2-solar-pv-facilities-and-associated-grid-connection/](http://www.savannahsa.com/public-documents/energy-generation/geelstert-1-and-geelstert-2-solar-pv-facilities-and-associated-grid-connection/) the public documents for these three (3) projects are available for your perusal.

#### **AVAILABILITY OF BASIC ASSESSMENT REPORTS FOR REVIEW AND COMMENT**

In terms of Regulation 43(2) of the EIA Regulations, 2014, as amended, this letter serves to inform you that the Basic Assessment Reports (BARs) are available for review and written comments. The BARs' review and comment period is from **Thursday, 20 August 2020 until Monday, 21 September 2020**.

<b>Applicant name</b>	<b>Project/BA Report</b>
Geelstert Solar Facility 1 (Pty) Ltd	Geelstert 1
Geelstert Solar Facility 2 (Pty) Ltd	Geelstert 2
ABO Wind renewable energies (Pty) Ltd	Geelstert Grid Connection

The reports are available for downloading from our public participation platform at [www.savannahsa.com/public-documents/energy-generation/geelstert-1-and-geelstert-2-solar-pv-facilities-and-associated-grid-connection/](http://www.savannahsa.com/public-documents/energy-generation/geelstert-1-and-geelstert-2-solar-pv-facilities-and-associated-grid-connection/)

The restrictions enforced in terms of Government Gazette 43096 which placed the country in a national state of disaster limiting the movement and gathering of people to curb the spread of the COVID-19 virus has placed some limitations on making hard copies of the BARs available at public places such as libraries and municipal offices. As per our approved public participation plan submitted to the Department of Environmental Affairs (DEA), you can also request that an electronic copy of the BARs be sent to you via file transfer services such as WeTransfer or Dropbox.

Please submit your written comments on the BARs by **Monday, 21 September 2020** via our public participation portal (link provided above) or:

- » Telephone: 011 656 3237
- » Mobile: 060 978 8396
- » Fax: 086 684 0547
- » Post: PO Box 148, Sunninghill, 2157
- » E-mail: [publicprocess@savannahsa.com](mailto:publicprocess@savannahsa.com)

All comments can be addressed to Ronald Baloyi of Savannah Environmental.

All comments received during the 30-day review and comment period will be recorded and included in the Final BARs for submission to the DEA in line with Regulation 44 of the EIA Regulations, 2014, as amended (GN R326).

Please do not hesitate to contact us should you require additional information and/or clarification regarding the project. Our team welcomes your participation and look forward to your involvement throughout this process.

Kind regards

A handwritten signature in black ink, appearing to read 'Nicolene Venter'.

**Nicolene Venter**

Public Participation and Social Consultant

Email: [publicprocess@savannahsa.com](mailto:publicprocess@savannahsa.com)



Ralston Paton, Samantha - BirdLife South Africa

Date: 8/19/2020  
Time: 5:16 PM  
Creator: Ronald Baloyi Baloyi

Note

---

Subject: GEELSTERT 1 & 2 and GRID CONNECTION: Notification of the Availability of the Basic Assessment for review and comment

Body:

**GEELSTERT 1 AND GEELSTERT 2 SOLAR PV FACILITIES AND GEELSTERT GRID CONNECTION NEAR AGGENEYS, NORTHERN CAPE PROVINCE**

Dear Ms Ralston-Pton,

The development of two separate solar photovoltaic (PV) facilities, each with a contracted capacity of up to 125MW, and associated grid connection is proposed on a site located approximately 11km south-east of the town of Aggeneys in the Northern Cape Province. The two solar PV facilities are to be known as Geelstert 1 and Geelstert 2. The grid connection solution will be known as Geelstert Grid Connection. The projects are situated within the Khâi-Ma Local Municipality, in the greater Namakwa District Municipality.

As a registered Interested and Affected Party (I&AP), you are hereby notified that the following three Basic Assessment Reports (BARs) are available for your review and comment from Thursday, 20 August 2020 until Monday, 21 September 2020. The reports are available for download from our website / stakeholder engagement platform on the above-mentioned link.

The restrictions enforced in terms of the Government Gazette 43096 which placed the country in a national state of disaster limiting the movement and gathering of people to curb the spread of the COVID-19 virus has placed some limitations on making hard copies of the BARs at the public places such as Libraries. We invite you to visit our online stakeholder engagement platform at <https://www.savannahsa.com/public-documents/energy-generation/geelstert-1-and-geelstert-2-solar-pv-facilities-and-associated-grid-connection/>

Should you not be able to access our online stakeholder engagement platform to download the BARs, please refer to the attached letter for alternative means to obtain the BARs. The attached letter also provides further details regarding the availability of the BARs.

Kind regards,

--

Please refer to the email saved in the Documents window.

19 August 2020

Ms Mashudu Marubini  
Ministerial Delegate  
Department of Agriculture, Forestry and Fisheries

and

Ms Thoko Buthelezi  
AgriLand Liaison Office  
Department of Agriculture, Forestry and Fisheries

E-mail: [REDACTED]

Dear Messrs Marubini and Buthelezi,

## GEELSTERT 1 AND GEELSTERT 2 SOLAR PV FACILITIES AND GEELSTERT GRID CONNECTION NEAR AGGENEYS, NORTHERN CAPE PROVINCE

### NOTICE OF AVAILABILITY OF BASIC ASSESSMENT REPORTS FOR REVIEW AND COMMENTS

The development of two separate solar photovoltaic (PV) facilities, each with a contracted capacity of up to 125MW, and associated grid connection is proposed on a site located approximately 11km south-east of the town of Aggeneys in the Northern Cape Province. The two solar PV facilities are to be known as Geelstert 1 and Geelstert 2. The grid connection solution will be known as Geelstert Grid Connection. The projects are situated within the Khâi-Ma Local Municipality, in the greater Namakwa District Municipality.

The two solar PV facilities are located on the Remaining Extent of the Farm Bloemhoek 61 and will be connected to the Aggeneis Main Transmission Substation (MTS). The grid connection will include a collector substation and a double-circuit power line of up to 220kV. The grid connection will traverse six (6) properties which include:

Remaining Extent of the Farm Bloemhoek 61	Remaining Extent of the Farm Aggeneys 56
Remaining Extent of Portion 1 of the Farm Aggeneys 56	Portion 2 of the Farm Aggeneys 56
Portion 12 of the Farm Aggeneys 56	Portion 13 of the Farm Aggeneys 56

It is the Developer's intention to bid each solar PV facility under the Department of Mineral Resources and Energy's<sup>1</sup> Renewable Energy Independent Power Producer Procurement (REIPPP) Programme. The power generated from each solar PV facility will be sold to Eskom and fed into the national electricity grid through the proposed grid connection. The development of the solar PV facilities and the grid connection will assist with the achievement of the electricity goals as set out in the Integrated Resources Plan (IRP), 2019.

The study area is located within Zone 8 of the Renewable Energy Development Zones (REDZ) (also known as the Springbok REDZ).

The applicant for each of the solar PV facilities will be a separate Special Purpose Vehicles (SPV). The applicant for Geelstert 1 is Geelstert Solar Facility 1 (Pty) Ltd, and the applicant for Geelstert 2 is Geelstert Solar Facility 2 (Pty) Ltd. The applicant for the Geelstert Grid Connection is ABO Wind renewable energies (Pty) Ltd. Three (3) separate Applications for Environmental Authorisation have been submitted to the Department of Environmental Affairs (DEA).

The notification of the development of two 125MW solar photovoltaic (PV) facilities and the associated grid connection distributed on 13 July 2020, has reference. The notification letter was accompanied by the Background Information Document (BID) which provided information regarding these Basic Assessment (BA) processes. If you have not received these documents, please inform us accordingly or we encourage you to visit our online stakeholder engagement platform at [www.savannahsa.com/public-documents/energy-generation/geelstert-1-and-geelstert-2-solar-pv-facilities-and-associated-grid-connection/](http://www.savannahsa.com/public-documents/energy-generation/geelstert-1-and-geelstert-2-solar-pv-facilities-and-associated-grid-connection/) the public documents for these three (3) projects are available for your perusal.

#### **AVAILABILITY OF BASIC ASSESSMENT REPORTS FOR REVIEW AND COMMENT**

In terms of Regulation 43(2) of the EIA Regulations, 2014, as amended, this letter serves to inform you that the Basic Assessment Reports (BARs) are available for review and written comments. The BARs' review and comment period is from **Thursday, 20 August 2020 until Monday, 21 September 2020**.

<b>Applicant name</b>	<b>Project/BA Report</b>
Geelstert Solar Facility 1 (Pty) Ltd	Geelstert 1
Geelstert Solar Facility 2 (Pty) Ltd	Geelstert 2
ABO Wind renewable energies (Pty) Ltd	Geelstert Grid Connection

The reports are available for downloading from our public participation platform at [www.savannahsa.com/public-documents/energy-generation/geelstert-1-and-geelstert-2-solar-pv-facilities-and-associated-grid-connection/](http://www.savannahsa.com/public-documents/energy-generation/geelstert-1-and-geelstert-2-solar-pv-facilities-and-associated-grid-connection/)

The restrictions enforced in terms of Government Gazette 43096 which placed the country in a national state of disaster limiting the movement and gathering of people to curb the spread of the COVID-19 virus has placed some limitations on making hard copies of the BARs available at public places such as libraries and municipal offices. As per our approved public participation plan submitted to the Department of Environmental Affairs (DEA), you can also request that an electronic copy of the BARs be sent to you via file transfer services such as WeTransfer or Dropbox.

---

<sup>1</sup> The Department of Mineral Resources and Energy is a merge between the Department of Mineral Resources (DMR) and the Department of Energy (DoE).

Please submit your written comments on the BARs by **Monday, 21 September 2020** via our public participation portal (link provided above) or:

- » Telephone: 011 656 3237
- » Mobile: 060 978 8396
- » Fax: 086 684 0547
- » Post: PO Box 148, Sunninghill, 2157
- » E-mail: [publicprocess@savannahsa.com](mailto:publicprocess@savannahsa.com)

All comments can be addressed to Ronald Baloyi of Savannah Environmental.

All comments received during the 30-day review and comment period will be recorded and included in the Final BARs for submission to the DEA in line with Regulation 44 of the EIA Regulations, 2014, as amended (GN R326).

Please do not hesitate to contact us should you require additional information and/or clarification regarding the project. Our team welcomes your participation and look forward to your involvement throughout this process.

Kind regards



**Nicolene Venter**

Public Participation and Social Consultant

Email: [publicprocess@savannahsa.com](mailto:publicprocess@savannahsa.com)

**Marubini, Mashudu - Department of Agriculture, Forestry & Fisheries**

Date: 8/19/2020  
Time: 5:18 PM  
Creator: Ronald Baloyi Baloyi

Note

---

Subject: GEELSTERT 1 & 2 and GRID CONNECTION: Notification of the Availability of the Basic Assessment for review and comment

Body:

**GEELSTERT 1 AND GEELSTERT 2 SOLAR PV FACILITIES AND GEELSTERT GRID CONNECTION NEAR AGGENEYS, NORTHERN CAPE PROVINCE**

Dear Messrs Marubini and Buthelezi,

The development of two separate solar photovoltaic (PV) facilities, each with a contracted capacity of up to 125MW, and associated grid connection is proposed on a site located approximately 11km south-east of the town of Aggeneys in the Northern Cape Province. The two solar PV facilities are to be known as Geelstert 1 and Geelstert 2. The grid connection solution will be known as Geelstert Grid Connection. The projects are situated within the Khâi-Ma Local Municipality, in the greater Namakwa District Municipality.

As a registered Interested and Affected Party (I&AP), you are hereby notified that the following three Basic Assessment Reports (BARs) are available for your review and comment from Thursday, 20 August 2020 until Monday, 21 September 2020. The reports are available for download from our website / stakeholder engagement platform on the above-mentioned link.

The restrictions enforced in terms of the Government Gazette 43096 which placed the country in a national state of disaster limiting the movement and gathering of people to curb the spread of the COVID-19 virus has placed some limitations on making hard copies of the BARs at the public places such as Libraries. We invite you to visit our online stakeholder engagement platform at <https://www.savannahsa.com/public-documents/energy-generation/geelstert-1-and-geelstert-2-solar-pv-facilities-and-associated-grid-connection/>

Should you not be able to access our online stakeholder engagement platform to download the BARs, please refer to the attached letter for alternative means to obtain the BARs. The attached letter also provides further details regarding the availability of the BARs.

Kind regards,

--

Please refer to the email saved in the Documents window.

19 August 2020

Mr Nozizwe Makgalemele  
Deputy Director General: Spatial Land Use and Management  
Department of Agriculture, Land Reform and Rural Development

E-mail: [REDACTED]

Dear Mr Makgalemele,

## **GEELSTERT 1 AND GEELSTERT 2 SOLAR PV FACILITIES AND GEELSTERT GRID CONNECTION NEAR AGGENEYS, NORTHERN CAPE PROVINCE**

### **NOTICE OF AVAILABILITY OF BASIC ASSESSMENT REPORTS FOR REVIEW AND COMMENTS**

The development of two separate solar photovoltaic (PV) facilities, each with a contracted capacity of up to 125MW, and associated grid connection is proposed on a site located approximately 11km south-east of the town of Aggeneys in the Northern Cape Province. The two solar PV facilities are to be known as Geelstert 1 and Geelstert 2. The grid connection solution will be known as Geelstert Grid Connection. The projects are situated within the Khâi-Ma Local Municipality, in the greater Namakwa District Municipality.

The two solar PV facilities are located on the Remaining Extent of the Farm Bloemhoek 61 and will be connected to the Aggeneys Main Transmission Substation (MTS). The grid connection will include a collector substation and a double-circuit power line of up to 220kV. The grid connection will traverse six (6) properties which include:

Remaining Extent of the Farm Bloemhoek 61	Remaining Extent of the Farm Aggeneys 56
Remaining Extent of Portion 1 of the Farm Aggeneys 56	Portion 2 of the Farm Aggeneys 56
Portion 12 of the Farm Aggeneys 56	Portion 13 of the Farm Aggeneys 56

It is the Developer's intention to bid each solar PV facility under the Department of Mineral Resources and Energy's<sup>1</sup> Renewable Energy Independent Power Producer Procurement (REIPPP) Programme. The power generated from each solar PV facility will be sold to Eskom and fed into the national electricity grid through the proposed grid connection. The development of the solar PV facilities and the grid connection will assist with the achievement of the electricity goals as set out in the Integrated Resources Plan (IRP), 2019.

<sup>1</sup> The Department of Mineral Resources and Energy is a merge between the Department of Mineral Resources (DMR) and the Department of Energy (DoE).

The study area is located within Zone 8 of the Renewable Energy Development Zones (REDZ) (also known as the Springbok REDZ).

The applicant for each of the solar PV facilities will be a separate Special Purpose Vehicles (SPV). The applicant for Geelstert 1 is Geelstert Solar Facility 1 (Pty) Ltd, and the applicant for Geelstert 2 is Geelstert Solar Facility 2 (Pty) Ltd. The applicant for the Geelstert Grid Connection is ABO Wind renewable energies (Pty) Ltd. Three (3) separate Applications for Environmental Authorisation have been submitted to the Department of Environmental Affairs (DEA).

The notification of the development of two 125MW solar photovoltaic (PV) facilities and the associated grid connection distributed on 13 July 2020, has reference. The notification letter was accompanied by the Background Information Document (BID) which provided information regarding these Basic Assessment (BA) processes. If you have not received these documents, please inform us accordingly or we encourage you to visit our online stakeholder engagement platform at [www.savannahsa.com/public-documents/energy-generation/geelstert-1-and-geelstert-2-solar-pv-facilities-and-associated-grid-connection/](http://www.savannahsa.com/public-documents/energy-generation/geelstert-1-and-geelstert-2-solar-pv-facilities-and-associated-grid-connection/) the public documents for these three (3) projects are available for your perusal.

#### **AVAILABILITY OF BASIC ASSESSMENT REPORTS FOR REVIEW AND COMMENT**

In terms of Regulation 43(2) of the EIA Regulations, 2014, as amended, this letter serves to inform you that the Basic Assessment Reports (BARs) are available for review and written comments. The BARs' review and comment period is from **Thursday, 20 August 2020 until Monday, 21 September 2020**.

<b>Applicant name</b>	<b>Project/BA Report</b>
Geelstert Solar Facility 1 (Pty) Ltd	Geelstert 1
Geelstert Solar Facility 2 (Pty) Ltd	Geelstert 2
ABO Wind renewable energies (Pty) Ltd	Geelstert Grid Connection

The reports are available for downloading from our public participation platform at [www.savannahsa.com/public-documents/energy-generation/geelstert-1-and-geelstert-2-solar-pv-facilities-and-associated-grid-connection/](http://www.savannahsa.com/public-documents/energy-generation/geelstert-1-and-geelstert-2-solar-pv-facilities-and-associated-grid-connection/)

The restrictions enforced in terms of Government Gazette 43096 which placed the country in a national state of disaster limiting the movement and gathering of people to curb the spread of the COVID-19 virus has placed some limitations on making hard copies of the BARs available at public places such as libraries and municipal offices. As per our approved public participation plan submitted to the Department of Environmental Affairs (DEA), you can also request that an electronic copy of the BARs be sent to you via file transfer services such as WeTransfer or Dropbox.

Please submit your written comments on the BARs by **Monday, 21 September 2020** via our public participation portal (link provided above) or:

- » Telephone: 011 656 3237
- » Mobile: 060 978 8396
- » Fax: 086 684 0547
- » Post: PO Box 148, Sunninghill, 2157
- » E-mail: [publicprocess@savannahsa.com](mailto:publicprocess@savannahsa.com)

All comments can be addressed to Ronald Baloyi of Savannah Environmental.

All comments received during the 30-day review and comment period will be recorded and included in the Final BARs for submission to the DEA in line with Regulation 44 of the EIA Regulations, 2014, as amended (GN R326).

Please do not hesitate to contact us should you require additional information and/or clarification regarding the project. Our team welcomes your participation and look forward to your involvement throughout this process.

Kind regards

A handwritten signature in black ink, appearing to read 'Nicolene Venter', written in a cursive style.

**Nicolene Venter**

Public Participation and Social Consultant

Email: [publicprocess@savannahsa.com](mailto:publicprocess@savannahsa.com)



**Makgalemele, Nozizwe - Department of Rural Development and Land Reform**

Date: 8/19/2020

Time: 5:20 PM

Creator: Ronald Baloyi Baloyi

## Note

Subject: GEELSTERT 1 & 2 and GRID CONNECTION: Notification of the Availability of the Basic Assessment for review and comment

## Body:

**GEELSTERT 1 AND GEELSTERT 2 SOLAR PV FACILITIES AND GEELSTERT GRID CONNECTION NEAR AGGENEYS, NORTHERN CAPE PROVINCE**

Dear Mr Makgalemele,

The development of two separate solar photovoltaic (PV) facilities, each with a contracted capacity of up to 125MW, and associated grid connection is proposed on a site located approximately 11km south-east of the town of Aggeneys in the Northern Cape Province. The two solar PV facilities are to be known as Geelstert 1 and Geelstert 2. The grid connection solution will be known as Geelstert Grid Connection. The projects are situated within the Khâi-Ma Local Municipality, in the greater Namakwa District Municipality.

As a registered Interested and Affected Party (I&AP), you are hereby notified that the following three Basic Assessment Reports (BARs) are available for your review and comment from Thursday, 20 August 2020 until Monday, 21 September 2020. The reports are available for download from our website / stakeholder engagement platform on the above-mentioned link.

The restrictions enforced in terms of the Government Gazette 43096 which placed the country in a national state of disaster limiting the movement and gathering of people to curb the spread of the COVID-19 virus has placed some limitations on making hard copies of the BARs at the public places such as Libraries. We invite you to visit our online stakeholder engagement platform at <https://www.savannahsa.com/public-documents/energy-generation/geelstert-1-and-geelstert-2-solar-pv-facilities-and-associated-grid-connection/>

Should you not be able to access our online stakeholder engagement platform to download the BARs, please refer to the attached letter for alternative means to obtain the BARs. The attached letter also provides further details regarding the availability of the BARs.

Kind regards,

--

Please refer to the email saved in the Documents window.

19 August 2020

Mr Stanley Tshitwamulomoni  
Director: Biodiversity Conservation  
Department of Environmental Affairs

E-mail: [REDACTED]

Dear Mr Tshitwamulomoni,

## GEELSTERT 1 AND GEELSTERT 2 SOLAR PV FACILITIES AND GEELSTERT GRID CONNECTION NEAR AGGENEYS, NORTHERN CAPE PROVINCE

### NOTICE OF AVAILABILITY OF BASIC ASSESSMENT REPORTS FOR REVIEW AND COMMENTS

The development of two separate solar photovoltaic (PV) facilities, each with a contracted capacity of up to 125MW, and associated grid connection is proposed on a site located approximately 11km south-east of the town of Aggeneys in the Northern Cape Province. The two solar PV facilities are to be known as Geelstert 1 and Geelstert 2. The grid connection solution will be known as Geelstert Grid Connection. The projects are situated within the Khâi-Ma Local Municipality, in the greater Namakwa District Municipality.

The two solar PV facilities are located on the Remaining Extent of the Farm Bloemhoek 61 and will be connected to the Aggeneis Main Transmission Substation (MTS). The grid connection will include a collector substation and a double-circuit power line of up to 220kV. The grid connection will traverse six (6) properties which include:

Remaining Extent of the Farm Bloemhoek 61	Remaining Extent of the Farm Aggeneys 56
Remaining Extent of Portion 1 of the Farm Aggeneys 56	Portion 2 of the Farm Aggeneys 56
Portion 12 of the Farm Aggeneys 56	Portion 13 of the Farm Aggeneys 56

It is the Developer's intention to bid each solar PV facility under the Department of Mineral Resources and Energy's<sup>1</sup> Renewable Energy Independent Power Producer Procurement (REIPPP) Programme. The power generated from each solar PV facility will be sold to Eskom and fed into the national electricity grid through the proposed grid connection. The development of the solar PV facilities and the grid connection will assist with the achievement of the electricity goals as set out in the Integrated Resources Plan (IRP), 2019.

<sup>1</sup> The Department of Mineral Resources and Energy is a merge between the Department of Mineral Resources (DMR) and the Department of Energy (DoE).

The study area is located within Zone 8 of the Renewable Energy Development Zones (REDZ) (also known as the Springbok REDZ).

The applicant for each of the solar PV facilities will be a separate Special Purpose Vehicles (SPV). The applicant for Geelstert 1 is Geelstert Solar Facility 1 (Pty) Ltd, and the applicant for Geelstert 2 is Geelstert Solar Facility 2 (Pty) Ltd. The applicant for the Geelstert Grid Connection is ABO Wind renewable energies (Pty) Ltd. Three (3) separate Applications for Environmental Authorisation have been submitted to the Department of Environmental Affairs (DEA).

The notification of the development of two 125MW solar photovoltaic (PV) facilities and the associated grid connection distributed on 13 July 2020, has reference. The notification letter was accompanied by the Background Information Document (BID) which provided information regarding these Basic Assessment (BA) processes. If you have not received these documents, please inform us accordingly or we encourage you to visit our online stakeholder engagement platform at [www.savannahsa.com/public-documents/energy-generation/geelstert-1-and-geelstert-2-solar-pv-facilities-and-associated-grid-connection/](http://www.savannahsa.com/public-documents/energy-generation/geelstert-1-and-geelstert-2-solar-pv-facilities-and-associated-grid-connection/) the public documents for these three (3) projects are available for your perusal.

#### **AVAILABILITY OF BASIC ASSESSMENT REPORTS FOR REVIEW AND COMMENT**

In terms of Regulation 43(2) of the EIA Regulations, 2014, as amended, this letter serves to inform you that the Basic Assessment Reports (BARs) are available for review and written comments. The BARs' review and comment period is from **Thursday, 20 August 2020 until Monday, 21 September 2020**.

<b>Applicant name</b>	<b>Project/BA Report</b>
Geelstert Solar Facility 1 (Pty) Ltd	Geelstert 1
Geelstert Solar Facility 2 (Pty) Ltd	Geelstert 2
ABO Wind renewable energies (Pty) Ltd	Geelstert Grid Connection

The reports are available for downloading from our public participation platform at [www.savannahsa.com/public-documents/energy-generation/geelstert-1-and-geelstert-2-solar-pv-facilities-and-associated-grid-connection/](http://www.savannahsa.com/public-documents/energy-generation/geelstert-1-and-geelstert-2-solar-pv-facilities-and-associated-grid-connection/)

The restrictions enforced in terms of Government Gazette 43096 which placed the country in a national state of disaster limiting the movement and gathering of people to curb the spread of the COVID-19 virus has placed some limitations on making hard copies of the BARs available at public places such as libraries and municipal offices. As per our approved public participation plan submitted to the Department of Environmental Affairs (DEA), you can also request that an electronic copy of the BARs be sent to you via file transfer services such as WeTransfer or Dropbox.

Please submit your written comments on the BARs by **Monday, 21 September 2020** via our public participation portal (link provided above) or:

- » Telephone: 011 656 3237
- » Mobile: 060 978 8396
- » Fax: 086 684 0547
- » Post: PO Box 148, Sunninghill, 2157
- » E-mail: [publicprocess@savannahsa.com](mailto:publicprocess@savannahsa.com)

All comments can be addressed to Ronald Baloyi of Savannah Environmental.

All comments received during the 30-day review and comment period will be recorded and included in the Final BARs for submission to the DEA in line with Regulation 44 of the EIA Regulations, 2014, as amended (GN R326).

Please do not hesitate to contact us should you require additional information and/or clarification regarding the project. Our team welcomes your participation and look forward to your involvement throughout this process.

Kind regards

A handwritten signature in black ink, appearing to read 'Nicolene Venter', written in a cursive style.

**Nicolene Venter**

Public Participation and Social Consultant

Email: [publicprocess@savannahsa.com](mailto:publicprocess@savannahsa.com)

**Tshitwamulomoni, Stanley - Department of Environmental Affairs**

Date: 8/19/2020  
Time: 5:22 PM  
Creator: Ronald Baloyi Baloyi

Note

---

Subject: GEELSTERT 1 & 2 and GRID CONNECTION: Notification of the Availability of the Basic Assessment for review and comment

Body:

**GEELSTERT 1 AND GEELSTERT 2 SOLAR PV FACILITIES AND GEELSTERT GRID CONNECTION NEAR AGGENEYS, NORTHERN CAPE PROVINCE**

Dear Mr Tshitwamulomoni,

The development of two separate solar photovoltaic (PV) facilities, each with a contracted capacity of up to 125MW, and associated grid connection is proposed on a site located approximately 11km south-east of the town of Aggeneys in the Northern Cape Province. The two solar PV facilities are to be known as Geelstert 1 and Geelstert 2. The grid connection solution will be known as Geelstert Grid Connection. The projects are situated within the Khâi-Ma Local Municipality, in the greater Namakwa District Municipality.

As a registered Interested and Affected Party (I&AP), you are hereby notified that the following three Basic Assessment Reports (BARs) are available for your review and comment from Thursday, 20 August 2020 until Monday, 21 September 2020. The reports are available for download from our website / stakeholder engagement platform on the above-mentioned link.

The restrictions enforced in terms of the Government Gazette 43096 which placed the country in a national state of disaster limiting the movement and gathering of people to curb the spread of the COVID-19 virus has placed some limitations on making hard copies of the BARs at the public places such as Libraries. We invite you to visit our online stakeholder engagement platform at <https://www.savannahsa.com/public-documents/energy-generation/geelstert-1-and-geelstert-2-solar-pv-facilities-and-associated-grid-connection/>

Should you not be able to access our online stakeholder engagement platform to download the BARs, please refer to the attached letter for alternative means to obtain the BARs. The attached letter also provides further details regarding the availability of the BARs.

Kind regards,

--

Please refer to the email saved in the Documents window.

19 August 2020

Ms Jacoline Mans  
Chief Forester: NFA Regulations  
Department of Environment, Forestry & Fisheries

E-mail: [REDACTED]

Dear Ms Mans,

## **GEELSTERT 1 AND GEELSTERT 2 SOLAR PV FACILITIES AND GEELSTERT GRID CONNECTION NEAR AGGENEYS, NORTHERN CAPE PROVINCE**

---

### **NOTICE OF AVAILABILITY OF BASIC ASSESSMENT REPORTS FOR REVIEW AND COMMENTS**

---

The development of two separate solar photovoltaic (PV) facilities, each with a contracted capacity of up to 125MW, and associated grid connection is proposed on a site located approximately 11km south-east of the town of Aggeneys in the Northern Cape Province. The two solar PV facilities are to be known as Geelstert 1 and Geelstert 2. The grid connection solution will be known as Geelstert Grid Connection. The projects are situated within the Khâi-Ma Local Municipality, in the greater Namakwa District Municipality.

The two solar PV facilities are located on the Remaining Extent of the Farm Bloemhoek 61 and will be connected to the Aggeneis Main Transmission Substation (MTS). The grid connection will include a collector substation and a double-circuit power line of up to 220kV. The grid connection will traverse six (6) properties which include:

Remaining Extent of the Farm Bloemhoek 61	Remaining Extent of the Farm Aggeneys 56
Remaining Extent of Portion 1 of the Farm Aggeneys 56	Portion 2 of the Farm Aggeneys 56
Portion 12 of the Farm Aggeneys 56	Portion 13 of the Farm Aggeneys 56

It is the Developer's intention to bid each solar PV facility under the Department of Mineral Resources and Energy's<sup>1</sup> Renewable Energy Independent Power Producer Procurement (REIPPP) Programme. The power generated from each solar PV facility will be sold to Eskom and fed into the national electricity grid through the proposed grid connection. The development of the solar PV facilities and the grid connection will assist with the achievement of the electricity goals as set out in the Integrated Resources Plan (IRP), 2019.

<sup>1</sup> The Department of Mineral Resources and Energy is a merge between the Department of Mineral Resources (DMR) and the Department of Energy (DoE).

The study area is located within Zone 8 of the Renewable Energy Development Zones (REDZ) (also known as the Springbok REDZ).

The applicant for each of the solar PV facilities will be a separate Special Purpose Vehicles (SPV). The applicant for Geelstert 1 is Geelstert Solar Facility 1 (Pty) Ltd, and the applicant for Geelstert 2 is Geelstert Solar Facility 2 (Pty) Ltd. The applicant for the Geelstert Grid Connection is ABO Wind renewable energies (Pty) Ltd. Three (3) separate Applications for Environmental Authorisation have been submitted to the Department of Environmental Affairs (DEA).

The notification of the development of two 125MW solar photovoltaic (PV) facilities and the associated grid connection distributed on 13 July 2020, has reference. The notification letter was accompanied by the Background Information Document (BID) which provided information regarding these Basic Assessment (BA) processes. If you have not received these documents, please inform us accordingly or we encourage you to visit our online stakeholder engagement platform at [www.savannahsa.com/public-documents/energy-generation/geelstert-1-and-geelstert-2-solar-pv-facilities-and-associated-grid-connection/](http://www.savannahsa.com/public-documents/energy-generation/geelstert-1-and-geelstert-2-solar-pv-facilities-and-associated-grid-connection/) the public documents for these three (3) projects are available for your perusal.

#### **AVAILABILITY OF BASIC ASSESSMENT REPORTS FOR REVIEW AND COMMENT**

In terms of Regulation 43(2) of the EIA Regulations, 2014, as amended, this letter serves to inform you that the Basic Assessment Reports (BARs) are available for review and written comments. The BARs' review and comment period is from **Thursday, 20 August 2020 until Monday, 21 September 2020**.

<b>Applicant name</b>	<b>Project/BA Report</b>
Geelstert Solar Facility 1 (Pty) Ltd	Geelstert 1
Geelstert Solar Facility 2 (Pty) Ltd	Geelstert 2
ABO Wind renewable energies (Pty) Ltd	Geelstert Grid Connection

The reports are available for downloading from our public participation platform at [www.savannahsa.com/public-documents/energy-generation/geelstert-1-and-geelstert-2-solar-pv-facilities-and-associated-grid-connection/](http://www.savannahsa.com/public-documents/energy-generation/geelstert-1-and-geelstert-2-solar-pv-facilities-and-associated-grid-connection/)

The restrictions enforced in terms of Government Gazette 43096 which placed the country in a national state of disaster limiting the movement and gathering of people to curb the spread of the COVID-19 virus has placed some limitations on making hard copies of the BARs available at public places such as libraries and municipal offices. As per our approved public participation plan submitted to the Department of Environmental Affairs (DEA), you can also request that an electronic copy of the BARs be sent to you via file transfer services such as WeTransfer or Dropbox.

Please submit your written comments on the BARs by **Monday, 21 September 2020** via our public participation portal (link provided above) or:

- » Telephone: 011 656 3237
- » Mobile: 060 978 8396
- » Fax: 086 684 0547
- » Post: PO Box 148, Sunninghill, 2157
- » E-mail: [publicprocess@savannahsa.com](mailto:publicprocess@savannahsa.com)

All comments can be addressed to Ronald Baloyi of Savannah Environmental.

All comments received during the 30-day review and comment period will be recorded and included in the Final BARs for submission to the DEA in line with Regulation 44 of the EIA Regulations, 2014, as amended (GN R326).

Please do not hesitate to contact us should you require additional information and/or clarification regarding the project. Our team welcomes your participation and look forward to your involvement throughout this process.

Kind regards

A handwritten signature in black ink, appearing to read "Nicolene Venter". The signature is written in a cursive, flowing style.

**Nicolene Venter**

Public Participation and Social Consultant

Email: [publicprocess@savannahsa.com](mailto:publicprocess@savannahsa.com)



Mans, Jacoline - Department of Agriculture, Forestry and Fisheries

Date: 8/19/2020  
Time: 5:26 PM  
Creator: Ronald Baloyi Baloyi

Note

Subject: GEELSTERT 1 & 2 and GRID CONNECTION: Notification of the Availability of the Basic Assessment for review and comment

Body:

GEELSTERT 1 AND GEELSTERT 2 SOLAR PV FACILITIES AND GEELSTERT GRID CONNECTION NEAR AGGENEYS, NORTHERN CAPE PROVINCE

Dear Ms Mans,

The development of two separate solar photovoltaic (PV) facilities, each with a contracted capacity of up to 125MW, and associated grid connection is proposed on a site located approximately 11km south-east of the town of Aggeneys in the Northern Cape Province. The two solar PV facilities are to be known as Geelstert 1 and Geelstert 2. The grid connection solution will be known as Geelstert Grid Connection. The projects are situated within the Khâi-Ma Local Municipality, in the greater Namakwa District Municipality.

As a registered Interested and Affected Party (I&AP), you are hereby notified that the following three Basic Assessment Reports (BARs) are available for your review and comment from Thursday, 20 August 2020 until Monday, 21 September 2020. The reports are available for download from our website / stakeholder engagement platform on the above-mentioned link.

The restrictions enforced in terms of the Government Gazette 43096 which placed the country in a national state of disaster limiting the movement and gathering of people to curb the spread of the COVID-19 virus has placed some limitations on making hard copies of the BARs at the public places such as Libraries. We invite you to visit our online stakeholder engagement platform at <https://www.savannahsa.com/public-documents/energy-generation/geelstert-1-and-geelstert-2-solar-pv-facilities-and-associated-grid-connection/>

Should you not be able to access our online stakeholder engagement platform to download the BARs, please refer to the attached letter for alternative means to obtain the BARs. The attached letter also provides further details regarding the availability of the BARs.

Kind regards,

--

Please refer to the email saved in the Documents window.

19 August 2020

Mr Mthetheleli Maphinda  
Regional Energy Director  
Department of Mineral Resources & Energy: Northern Cape Province

E-mail: [REDACTED]

Dear Mr Maphinda,

## **GEELSTERT 1 AND GEELSTERT 2 SOLAR PV FACILITIES AND GEELSTERT GRID CONNECTION NEAR AGGENEYS, NORTHERN CAPE PROVINCE**

### **NOTICE OF AVAILABILITY OF BASIC ASSESSMENT REPORTS FOR REVIEW AND COMMENTS**

The development of two separate solar photovoltaic (PV) facilities, each with a contracted capacity of up to 125MW, and associated grid connection is proposed on a site located approximately 11km south-east of the town of Aggeneys in the Northern Cape Province. The two solar PV facilities are to be known as Geelstert 1 and Geelstert 2. The grid connection solution will be known as Geelstert Grid Connection. The projects are situated within the Khâi-Ma Local Municipality, in the greater Namakwa District Municipality.

The two solar PV facilities are located on the Remaining Extent of the Farm Bloemhoek 61 and will be connected to the Aggeneis Main Transmission Substation (MTS). The grid connection will include a collector substation and a double-circuit power line of up to 220kV. The grid connection will traverse six (6) properties which include:

Remaining Extent of the Farm Bloemhoek 61	Remaining Extent of the Farm Aggeneys 56
Remaining Extent of Portion 1 of the Farm Aggeneys 56	Portion 2 of the Farm Aggeneys 56
Portion 12 of the Farm Aggeneys 56	Portion 13 of the Farm Aggeneys 56

It is the Developer's intention to bid each solar PV facility under the Department of Mineral Resources and Energy's<sup>1</sup> Renewable Energy Independent Power Producer Procurement (REIPPP) Programme. The power generated from each solar PV facility will be sold to Eskom and fed into the national electricity grid through the proposed grid connection. The development of the solar PV facilities and the grid connection will assist with the achievement of the electricity goals as set out in the Integrated Resources Plan (IRP), 2019.

<sup>1</sup> The Department of Mineral Resources and Energy is a merge between the Department of Mineral Resources (DMR) and the Department of Energy (DoE).

The study area is located within Zone 8 of the Renewable Energy Development Zones (REDZ) (also known as the Springbok REDZ).

The applicant for each of the solar PV facilities will be a separate Special Purpose Vehicles (SPV). The applicant for Geelstert 1 is Geelstert Solar Facility 1 (Pty) Ltd, and the applicant for Geelstert 2 is Geelstert Solar Facility 2 (Pty) Ltd. The applicant for the Geelstert Grid Connection is ABO Wind renewable energies (Pty) Ltd. Three (3) separate Applications for Environmental Authorisation have been submitted to the Department of Environmental Affairs (DEA).

The notification of the development of two 125MW solar photovoltaic (PV) facilities and the associated grid connection distributed on 13 July 2020, has reference. The notification letter was accompanied by the Background Information Document (BID) which provided information regarding these Basic Assessment (BA) processes. If you have not received these documents, please inform us accordingly or we encourage you to visit our online stakeholder engagement platform at [www.savannahsa.com/public-documents/energy-generation/geelstert-1-and-geelstert-2-solar-pv-facilities-and-associated-grid-connection/](http://www.savannahsa.com/public-documents/energy-generation/geelstert-1-and-geelstert-2-solar-pv-facilities-and-associated-grid-connection/) the public documents for these three (3) projects are available for your perusal.

#### **AVAILABILITY OF BASIC ASSESSMENT REPORTS FOR REVIEW AND COMMENT**

In terms of Regulation 43(2) of the EIA Regulations, 2014, as amended, this letter serves to inform you that the Basic Assessment Reports (BARs) are available for review and written comments. The BARs' review and comment period is from **Thursday, 20 August 2020 until Monday, 21 September 2020**.

<b>Applicant name</b>	<b>Project/BA Report</b>
Geelstert Solar Facility 1 (Pty) Ltd	Geelstert 1
Geelstert Solar Facility 2 (Pty) Ltd	Geelstert 2
ABO Wind renewable energies (Pty) Ltd	Geelstert Grid Connection

The reports are available for downloading from our public participation platform at [www.savannahsa.com/public-documents/energy-generation/geelstert-1-and-geelstert-2-solar-pv-facilities-and-associated-grid-connection/](http://www.savannahsa.com/public-documents/energy-generation/geelstert-1-and-geelstert-2-solar-pv-facilities-and-associated-grid-connection/)

The restrictions enforced in terms of Government Gazette 43096 which placed the country in a national state of disaster limiting the movement and gathering of people to curb the spread of the COVID-19 virus has placed some limitations on making hard copies of the BARs available at public places such as libraries and municipal offices. As per our approved public participation plan submitted to the Department of Environmental Affairs (DEA), you can also request that an electronic copy of the BARs be sent to you via file transfer services such as WeTransfer or Dropbox.

Please submit your written comments on the BARs by **Monday, 21 September 2020** via our public participation portal (link provided above) or:

- » Telephone: 011 656 3237
- » Mobile: 060 978 8396
- » Fax: 086 684 0547
- » Post: PO Box 148, Sunninghill, 2157
- » E-mail: [publicprocess@savannahsa.com](mailto:publicprocess@savannahsa.com)

All comments can be addressed to Ronald Baloyi of Savannah Environmental.

All comments received during the 30-day review and comment period will be recorded and included in the Final BARs for submission to the DEA in line with Regulation 44 of the EIA Regulations, 2014, as amended (GN R326).

Please do not hesitate to contact us should you require additional information and/or clarification regarding the project. Our team welcomes your participation and look forward to your involvement throughout this process.

Kind regards

A handwritten signature in black ink, appearing to read 'Nicolene Venter'.

**Nicolene Venter**

Public Participation and Social Consultant

Email: [publicprocess@savannahsa.com](mailto:publicprocess@savannahsa.com)

**Maphinda, Mthetheleli - Department of Mineral Resources and Energy**

Date: 8/19/2020  
Time: 5:28 PM  
Creator: Ronald Baloyi Baloyi

Note

---

Subject: GEELSTERT 1 & 2 and GRID CONNECTION: Notification of the Availability of the Basic Assessment for review and comment

Body:

**GEELSTERT 1 AND GEELSTERT 2 SOLAR PV FACILITIES AND GEELSTERT GRID CONNECTION NEAR AGGENEYS, NORTHERN CAPE PROVINCE**

Dear Mr Maphinda,

The development of two separate solar photovoltaic (PV) facilities, each with a contracted capacity of up to 125MW, and associated grid connection is proposed on a site located approximately 11km south-east of the town of Aggeneys in the Northern Cape Province. The two solar PV facilities are to be known as Geelstert 1 and Geelstert 2. The grid connection solution will be known as Geelstert Grid Connection. The projects are situated within the Khâi-Ma Local Municipality, in the greater Namakwa District Municipality.

As a registered Interested and Affected Party (I&AP), you are hereby notified that the following three Basic Assessment Reports (BARs) are available for your review and comment from Thursday, 20 August 2020 until Monday, 21 September 2020. The reports are available for download from our website / stakeholder engagement platform on the above-mentioned link.

The restrictions enforced in terms of the Government Gazette 43096 which placed the country in a national state of disaster limiting the movement and gathering of people to curb the spread of the COVID-19 virus has placed some limitations on making hard copies of the BARs at the public places such as Libraries. We invite you to visit our online stakeholder engagement platform at <https://www.savannahsa.com/public-documents/energy-generation/geelstert-1-and-geelstert-2-solar-pv-facilities-and-associated-grid-connection/>

Should you not be able to access our online stakeholder engagement platform to download the BARs, please refer to the attached letter for alternative means to obtain the BARs. The attached letter also provides further details regarding the availability of the BARs.

Kind regards,

--

Please refer to the email saved in the Documents window.

19 August 2020

Mr Pheladi Masipa  
Acting Project Manager: Renewable Energy Initiatives  
Department of Energy

E-mail: [REDACTED]

Dear Mr Masipa,

## **GEELSTERT 1 AND GEELSTERT 2 SOLAR PV FACILITIES AND GEELSTERT GRID CONNECTION NEAR AGGENEYS, NORTHERN CAPE PROVINCE**

### **NOTICE OF AVAILABILITY OF BASIC ASSESSMENT REPORTS FOR REVIEW AND COMMENTS**

The development of two separate solar photovoltaic (PV) facilities, each with a contracted capacity of up to 125MW, and associated grid connection is proposed on a site located approximately 11km south-east of the town of Aggeneys in the Northern Cape Province. The two solar PV facilities are to be known as Geelstert 1 and Geelstert 2. The grid connection solution will be known as Geelstert Grid Connection. The projects are situated within the Khâi-Ma Local Municipality, in the greater Namakwa District Municipality.

The two solar PV facilities are located on the Remaining Extent of the Farm Bloemhoek 61 and will be connected to the Aggeneys Main Transmission Substation (MTS). The grid connection will include a collector substation and a double-circuit power line of up to 220kV. The grid connection will traverse six (6) properties which include:

Remaining Extent of the Farm Bloemhoek 61	Remaining Extent of the Farm Aggeneys 56
Remaining Extent of Portion 1 of the Farm Aggeneys 56	Portion 2 of the Farm Aggeneys 56
Portion 12 of the Farm Aggeneys 56	Portion 13 of the Farm Aggeneys 56

It is the Developer's intention to bid each solar PV facility under the Department of Mineral Resources and Energy's<sup>1</sup> Renewable Energy Independent Power Producer Procurement (REIPPP) Programme. The power generated from each solar PV facility will be sold to Eskom and fed into the national electricity grid through the proposed grid connection. The development of the solar PV facilities and the grid connection will assist with the achievement of the electricity goals as set out in the Integrated Resources Plan (IRP), 2019.

<sup>1</sup> The Department of Mineral Resources and Energy is a merge between the Department of Mineral Resources (DMR) and the Department of Energy (DoE).

The study area is located within Zone 8 of the Renewable Energy Development Zones (REDZ) (also known as the Springbok REDZ).

The applicant for each of the solar PV facilities will be a separate Special Purpose Vehicles (SPV). The applicant for Geelstert 1 is Geelstert Solar Facility 1 (Pty) Ltd, and the applicant for Geelstert 2 is Geelstert Solar Facility 2 (Pty) Ltd. The applicant for the Geelstert Grid Connection is ABO Wind renewable energies (Pty) Ltd. Three (3) separate Applications for Environmental Authorisation have been submitted to the Department of Environmental Affairs (DEA).

The notification of the development of two 125MW solar photovoltaic (PV) facilities and the associated grid connection distributed on 13 July 2020, has reference. The notification letter was accompanied by the Background Information Document (BID) which provided information regarding these Basic Assessment (BA) processes. If you have not received these documents, please inform us accordingly or we encourage you to visit our online stakeholder engagement platform at [www.savannahsa.com/public-documents/energy-generation/geelstert-1-and-geelstert-2-solar-pv-facilities-and-associated-grid-connection/](http://www.savannahsa.com/public-documents/energy-generation/geelstert-1-and-geelstert-2-solar-pv-facilities-and-associated-grid-connection/) the public documents for these three (3) projects are available for your perusal.

#### **AVAILABILITY OF BASIC ASSESSMENT REPORTS FOR REVIEW AND COMMENT**

In terms of Regulation 43(2) of the EIA Regulations, 2014, as amended, this letter serves to inform you that the Basic Assessment Reports (BARs) are available for review and written comments. The BARs' review and comment period is from **Thursday, 20 August 2020 until Monday, 21 September 2020**.

<b>Applicant name</b>	<b>Project/BA Report</b>
Geelstert Solar Facility 1 (Pty) Ltd	Geelstert 1
Geelstert Solar Facility 2 (Pty) Ltd	Geelstert 2
ABO Wind renewable energies (Pty) Ltd	Geelstert Grid Connection

The reports are available for downloading from our public participation platform at [www.savannahsa.com/public-documents/energy-generation/geelstert-1-and-geelstert-2-solar-pv-facilities-and-associated-grid-connection/](http://www.savannahsa.com/public-documents/energy-generation/geelstert-1-and-geelstert-2-solar-pv-facilities-and-associated-grid-connection/)

The restrictions enforced in terms of Government Gazette 43096 which placed the country in a national state of disaster limiting the movement and gathering of people to curb the spread of the COVID-19 virus has placed some limitations on making hard copies of the BARs available at public places such as libraries and municipal offices. As per our approved public participation plan submitted to the Department of Environmental Affairs (DEA), you can also request that an electronic copy of the BARs be sent to you via file transfer services such as WeTransfer or Dropbox.

Please submit your written comments on the BARs by **Monday, 21 September 2020** via our public participation portal (link provided above) or:

- » Telephone: 011 656 3237
- » Mobile: 060 978 8396
- » Fax: 086 684 0547
- » Post: PO Box 148, Sunninghill, 2157
- » E-mail: [publicprocess@savannahsa.com](mailto:publicprocess@savannahsa.com)

All comments can be addressed to Ronald Baloyi of Savannah Environmental.

All comments received during the 30-day review and comment period will be recorded and included in the Final BARs for submission to the DEA in line with Regulation 44 of the EIA Regulations, 2014, as amended (GN R326).

Please do not hesitate to contact us should you require additional information and/or clarification regarding the project. Our team welcomes your participation and look forward to your involvement throughout this process.

Kind regards

A handwritten signature in black ink, appearing to read 'Nicolene Venter', written in a cursive style.

**Nicolene Venter**

Public Participation and Social Consultant

Email: [publicprocess@savannahsa.com](mailto:publicprocess@savannahsa.com)



Masipa, Pheladi - Department of Energy

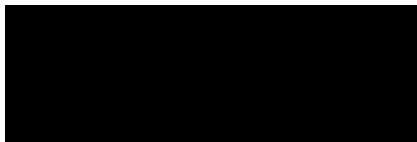

Date: 8/19/2020  
Time: 5:37 PM  
Creator: Ronald Baloyi Baloyi

Note

---

Subject: GEELSTERT 1 & 2 and GRID CONNECTION: Notification of the Availability of the Basic Assessment for review and comment

Body:

**GEELSTERT 1 AND GEELSTERT 2 SOLAR PV FACILITIES AND GEELSTERT GRID CONNECTION NEAR AGGENEYS, NORTHERN CAPE PROVINCE**

Dear Mr Masipa,

The development of two separate solar photovoltaic (PV) facilities, each with a contracted capacity of up to 125MW, and associated grid connection is proposed on a site located approximately 11km south-east of the town of Aggeneys in the Northern Cape Province. The two solar PV facilities are to be known as Geelstert 1 and Geelstert 2. The grid connection solution will be known as Geelstert Grid Connection. The projects are situated within the Khâi-Ma Local Municipality, in the greater Namakwa District Municipality.

As a registered Interested and Affected Party (I&AP), you are hereby notified that the following three Basic Assessment Reports (BARs) are available for your review and comment from Thursday, 20 August 2020 until Monday, 21 September 2020. The reports are available for download from our website / stakeholder engagement platform on the above-mentioned link.

The restrictions enforced in terms of the Government Gazette 43096 which placed the country in a national state of disaster limiting the movement and gathering of people to curb the spread of the COVID-19 virus has placed some limitations on making hard copies of the BARs at the public places such as Libraries. We invite you to visit our online stakeholder engagement platform at <https://www.savannahsa.com/public-documents/energy-generation/geelstert-1-and-geelstert-2-solar-pv-facilities-and-associated-grid-connection/>

Should you not be able to access our online stakeholder engagement platform to download the BARs, please refer to the attached letter for alternative means to obtain the BARs. The attached letter also provides further details regarding the availability of the BARs.

Kind regards,

--

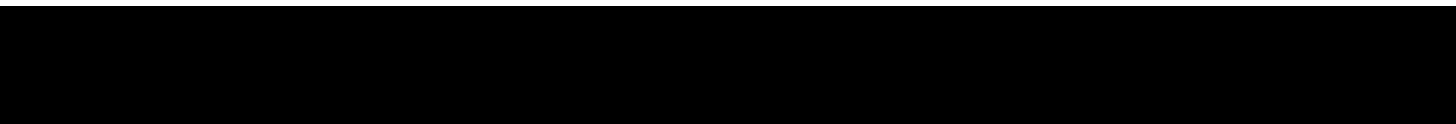

Please refer to the email saved in the Documents window.

19 August 2020

Ms Alexia Hlongwane  
Manager: Water Quality Management  
Lower Orange Water Management Area  
Department of Water & Sanitation  
Louisvale Road  
UPINGTON

**Per Courier**

Dear Ms Hlongwane,

**GEELSTERT 1 AND GEELSTERT 2 SOLAR PV FACILITIES AND GEELSTERT GRID  
CONNECTION NEAR AGGENEYS, NORTHERN CAPE PROVINCE**

**NOTICE OF AVAILABILITY OF BASIC ASSESSMENT REPORTS FOR REVIEW AND COMMENTS**

The development of two separate solar photovoltaic (PV) facilities, each with a contracted capacity of up to 125MW, and associated grid connection is proposed on a site located approximately 11km south-east of the town of Aggeneys in the Northern Cape Province. The two solar PV facilities are to be known as Geelstert 1 and Geelstert 2. The grid connection solution will be known as Geelstert Grid Connection. The projects are situated within the Khâi-Ma Local Municipality, in the greater Namakwa District Municipality.

The two solar PV facilities are located on the Remaining Extent of the Farm Bloemhoek 61 and will be connected to the Aggeneis Main Transmission Substation (MTS). The grid connection will include a collector substation and a double-circuit power line of up to 220kV. The grid connection will traverse six (6) properties which include:

Remaining Extent of the Farm Bloemhoek 61	Remaining Extent of the Farm Aggeneys 56
Remaining Extent of Portion 1 of the Farm Aggeneys 56	Portion 2 of the Farm Aggeneys 56
Portion 12 of the Farm Aggeneys 56	Portion 13 of the Farm Aggeneys 56

It is the Developer's intention to bid each solar PV facility under the Department of Mineral Resources and Energy's<sup>1</sup> Renewable Energy Independent Power Producer Procurement (REIPPP) Programme. The power generated from each solar PV facility will be sold to Eskom and fed into the national electricity grid through the proposed grid connection. The development of the solar PV facilities and the grid connection will assist with the achievement of the electricity goals as set out in the Integrated Resources Plan (IRP), 2019.

The study area is located within Zone 8 of the Renewable Energy Development Zones (REDZ) (also known as the Springbok REDZ).

The applicant for each of the solar PV facilities will be a separate Special Purpose Vehicles (SPV). The applicant for Geelstert 1 is Geelstert Solar Facility 1 (Pty) Ltd, and the applicant for Geelstert 2 is Geelstert Solar Facility 2 (Pty) Ltd. The applicant for the Geelstert Grid Connection is ABO Wind renewable energies (Pty) Ltd. Three (3) separate Applications for Environmental Authorisation have been submitted to the Department of Environmental Affairs (DEA).

The notification of the development of two 125MW solar photovoltaic (PV) facilities and the associated grid connection distributed on 13 July 2020, has reference. The notification letter was accompanied by the Background Information Document (BID) which provided information regarding these Basic Assessment (BA) processes. If you have not received these documents, please inform us accordingly or we encourage you to visit our online stakeholder engagement platform at [www.savannahsa.com/public-documents/energy-generation/geelstert-1-and-geelstert-2-solar-pv-facilities-and-associated-grid-connection/](http://www.savannahsa.com/public-documents/energy-generation/geelstert-1-and-geelstert-2-solar-pv-facilities-and-associated-grid-connection/) the public documents for these three (3) projects are available for your perusal.

#### **AVAILABILITY OF BASIC ASSESSMENT REPORTS FOR REVIEW AND COMMENT**

In terms of Regulation 43(2) of the EIA Regulations, 2014, as amended, this letter serves to inform you that the Basic Assessment Reports (BARs) are available for review and written comments. The BARs' review and comment period is from **Thursday, 20 August 2020 until Monday, 21 September 2020**.

<b>Applicant name</b>	<b>Project/BA Report</b>
Geelstert Solar Facility 1 (Pty) Ltd	Geelstert 1
Geelstert Solar Facility 2 (Pty) Ltd	Geelstert 2
ABO Wind renewable energies (Pty) Ltd	Geelstert Grid Connection

The reports are available for downloading from our public participation platform at [www.savannahsa.com/public-documents/energy-generation/geelstert-1-and-geelstert-2-solar-pv-facilities-and-associated-grid-connection/](http://www.savannahsa.com/public-documents/energy-generation/geelstert-1-and-geelstert-2-solar-pv-facilities-and-associated-grid-connection/)

The restrictions enforced in terms of Government Gazette 43096 which placed the country in a national state of disaster limiting the movement and gathering of people to curb the spread of the COVID-19 virus has placed some limitations on making hard copies of the BARs available at public places such as libraries and municipal offices. As per our approved public participation plan submitted to the Department of Environmental Affairs (DEA), you can also request that an electronic copy of the BARs be sent to you via file transfer services such as WeTransfer or Dropbox.

---

<sup>1</sup> The Department of Mineral Resources and Energy is a merge between the Department of Mineral Resources (DMR) and the Department of Energy (DoE).

Please submit your written comments on the BARs by **Monday, 21 September 2020** via our public participation portal (link provided above) or:

- » Telephone: 011 656 3237
- » Mobile: 060 978 8396
- » Fax: 086 684 0547
- » Post: PO Box 148, Sunninghill, 2157
- » E-mail: [publicprocess@savannahsa.com](mailto:publicprocess@savannahsa.com)

All comments can be addressed to Ronald Baloyi of Savannah Environmental.

All comments received during the 30-day review and comment period will be recorded and included in the Final BARs for submission to the DEA in line with Regulation 44 of the EIA Regulations, 2014, as amended (GN R326).

Please do not hesitate to contact us should you require additional information and/or clarification regarding the project. Our team welcomes your participation and look forward to your involvement throughout this process.

Kind regards



**Nicolene Venter**

Public Participation and Social Consultant

Email: [publicprocess@savannahsa.com](mailto:publicprocess@savannahsa.com)

**CC:** Mr Kobus Streuders: Acting Provincial Head, Department of Water and Sanitation  
([FranksL@dws.gov.za](mailto:FranksL@dws.gov.za))

19 August 2020

Mr Kobus Streuders  
Acting: Provincial Head  
Department of Water & Sanitation: Northern Cape Province

Per e-mail:



Dear Mr Streuders,

## **GEELSTERT 1 AND GEELSTERT 2 SOLAR PV FACILITIES AND GEELSTERT GRID CONNECTION NEAR AGGENEYS, NORTHERN CAPE PROVINCE**

---

### **NOTICE OF AVAILABILITY OF BASIC ASSESSMENT REPORTS FOR REVIEW AND COMMENTS**

---

The development of two separate solar photovoltaic (PV) facilities, each with a contracted capacity of up to 125MW, and associated grid connection is proposed on a site located approximately 11km south-east of the town of Aggeneys in the Northern Cape Province. The two solar PV facilities are to be known as Geelstert 1 and Geelstert 2. The grid connection solution will be known as Geelstert Grid Connection. The projects are situated within the Khâi-Ma Local Municipality, in the greater Namakwa District Municipality.

The two solar PV facilities are located on the Remaining Extent of the Farm Bloemhoek 61 and will be connected to the Aggeneys Main Transmission Substation (MTS). The grid connection will include a collector substation and a double-circuit power line of up to 220kV. The grid connection will traverse six (6) properties which include:

Remaining Extent of the Farm Bloemhoek 61	Remaining Extent of the Farm Aggeneys 56
Remaining Extent of Portion 1 of the Farm Aggeneys 56	Portion 2 of the Farm Aggeneys 56
Portion 12 of the Farm Aggeneys 56	Portion 13 of the Farm Aggeneys 56

It is the Developer's intention to bid each solar PV facility under the Department of Mineral Resources and Energy's<sup>1</sup> Renewable Energy Independent Power Producer Procurement (REIPPP) Programme. The power generated from each solar PV facility will be sold to Eskom and fed into the national electricity grid through the proposed grid connection. The development of the solar PV facilities and the grid connection will assist with the achievement of the electricity goals as set out in the Integrated Resources Plan (IRP), 2019.

<sup>1</sup> The Department of Mineral Resources and Energy is a merge between the Department of Mineral Resources (DMR) and the Department of Energy (DoE).

The study area is located within Zone 8 of the Renewable Energy Development Zones (REDZ) (also known as the Springbok REDZ).

The applicant for each of the solar PV facilities will be a separate Special Purpose Vehicles (SPV). The applicant for Geelstert 1 is Geelstert Solar Facility 1 (Pty) Ltd, and the applicant for Geelstert 2 is Geelstert Solar Facility 2 (Pty) Ltd. The applicant for the Geelstert Grid Connection is ABO Wind renewable energies (Pty) Ltd. Three (3) separate Applications for Environmental Authorisation have been submitted to the Department of Environmental Affairs (DEA).

The notification of the development of two 125MW solar photovoltaic (PV) facilities and the associated grid connection distributed on 13 July 2020, has reference. The notification letter was accompanied by the Background Information Document (BID) which provided information regarding these Basic Assessment (BA) processes. If you have not received these documents, please inform us accordingly or we encourage you to visit our online stakeholder engagement platform at [www.savannahsa.com/public-documents/energy-generation/geelstert-1-and-geelstert-2-solar-pv-facilities-and-associated-grid-connection/](http://www.savannahsa.com/public-documents/energy-generation/geelstert-1-and-geelstert-2-solar-pv-facilities-and-associated-grid-connection/) the public documents for these three (3) projects are available for your perusal.

#### **AVAILABILITY OF BASIC ASSESSMENT REPORTS FOR REVIEW AND COMMENT**

In terms of Regulation 43(2) of the EIA Regulations, 2014, as amended, this letter serves to inform you that the Basic Assessment Reports (BARs) are available for review and written comments. The BARs' review and comment period is from **Thursday, 20 August 2020 until Monday, 21 September 2020**.

<b>Applicant name</b>	<b>Project/BA Report</b>
Geelstert Solar Facility 1 (Pty) Ltd	Geelstert 1
Geelstert Solar Facility 2 (Pty) Ltd	Geelstert 2
ABO Wind renewable energies (Pty) Ltd	Geelstert Grid Connection

The reports are available for downloading from our public participation platform at [www.savannahsa.com/public-documents/energy-generation/geelstert-1-and-geelstert-2-solar-pv-facilities-and-associated-grid-connection/](http://www.savannahsa.com/public-documents/energy-generation/geelstert-1-and-geelstert-2-solar-pv-facilities-and-associated-grid-connection/)

The restrictions enforced in terms of Government Gazette 43096 which placed the country in a national state of disaster limiting the movement and gathering of people to curb the spread of the COVID-19 virus has placed some limitations on making hard copies of the BARs available at public places such as libraries and municipal offices. As per our approved public participation plan submitted to the Department of Environmental Affairs (DEA), you can also request that an electronic copy of the BARs be sent to you via file transfer services such as WeTransfer or Dropbox.

Please submit your written comments on the BARs by **Monday, 21 September 2020** via our public participation portal (link provided above) or:

- » Telephone: 011 656 3237
- » Mobile: 060 978 8396
- » Fax: 086 684 0547
- » Post: PO Box 148, Sunninghill, 2157
- » E-mail: [publicprocess@savannahsa.com](mailto:publicprocess@savannahsa.com)

All comments can be addressed to Ronald Baloyi of Savannah Environmental.

All comments received during the 30-day review and comment period will be recorded and included in the Final BARs for submission to the DEA in line with Regulation 44 of the EIA Regulations, 2014, as amended (GN R326).

Please do not hesitate to contact us should you require additional information and/or clarification regarding the project. Our team welcomes your participation and look forward to your involvement throughout this process.

Kind regards



**Nicolene Venter**

Public Participation and Social Consultant

Email: [publicprocess@savannahsa.com](mailto:publicprocess@savannahsa.com)

**CC:** Ms Alexia Hlongwane: Manager, Water Quality Management, Lower Orange Water Management Area ([lenganiA@dws.gov.za](mailto:lenganiA@dws.gov.za)).

**Streuders, Kobus - Department of Water and Sanitation**

Date: 8/19/2020  
Time: 5:40 PM  
Creator: Ronald Baloyi Baloyi

Note

---

Subject: GEELSTERT 1 & 2 and GRID CONNECTION: Notification of the Availability of the Basic Assessment for review and comment

Body:

**GEELSTERT 1 AND GEELSTERT 2 SOLAR PV FACILITIES AND GEELSTERT GRID CONNECTION NEAR AGGENEYS, NORTHERN CAPE PROVINCE**

Dear Mr Streuders,

The development of two separate solar photovoltaic (PV) facilities, each with a contracted capacity of up to 125MW, and associated grid connection is proposed on a site located approximately 11km south-east of the town of Aggeneys in the Northern Cape Province. The two solar PV facilities are to be known as Geelstert 1 and Geelstert 2. The grid connection solution will be known as Geelstert Grid Connection. The projects are situated within the Khâi-Ma Local Municipality, in the greater Namakwa District Municipality.

As a registered Interested and Affected Party (I&AP), you are hereby notified that the following three Basic Assessment Reports (BARs) are available for your review and comment from Thursday, 20 August 2020 until Monday, 21 September 2020. The reports are available for download from our website / stakeholder engagement platform on the above-mentioned link.

The restrictions enforced in terms of the Government Gazette 43096 which placed the country in a national state of disaster limiting the movement and gathering of people to curb the spread of the COVID-19 virus has placed some limitations on making hard copies of the BARs at the public places such as Libraries. We invite you to visit our online stakeholder engagement platform at <https://www.savannahsa.com/public-documents/energy-generation/geelstert-1-and-geelstert-2-solar-pv-facilities-and-associated-grid-connection/>

Should you not be able to access our online stakeholder engagement platform to download the BARs, please refer to the attached letter for alternative means to obtain the BARs. The attached letter also provides further details regarding the availability of the BARs.

Kind regards,

--

Please refer to the email saved in the Documents window.



19 August 2020

Mr John Geeringh  
Senior Environmental Advisor  
Eskom Holdings SOC Ltd

E-mail:

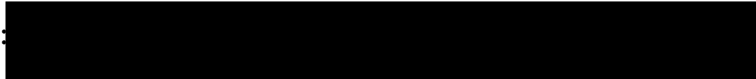

Dear Mr Geeringh,

## **GEELSTERT 1 AND GEELSTERT 2 SOLAR PV FACILITIES AND GEELSTERT GRID CONNECTION NEAR AGGENEYS, NORTHERN CAPE PROVINCE**

---

### **NOTICE OF AVAILABILITY OF BASIC ASSESSMENT REPORTS FOR REVIEW AND COMMENTS**

---

The development of two separate solar photovoltaic (PV) facilities, each with a contracted capacity of up to 125MW, and associated grid connection is proposed on a site located approximately 11km south-east of the town of Aggeneys in the Northern Cape Province. The two solar PV facilities are to be known as Geelstert 1 and Geelstert 2. The grid connection solution will be known as Geelstert Grid Connection. The projects are situated within the Khâi-Ma Local Municipality, in the greater Namakwa District Municipality.

The two solar PV facilities are located on the Remaining Extent of the Farm Bloemhoek 61 and will be connected to the Aggeneis Main Transmission Substation (MTS). The grid connection will include a collector substation and a double-circuit power line of up to 220kV. The grid connection will traverse six (6) properties which include:

Remaining Extent of the Farm Bloemhoek 61	Remaining Extent of the Farm Aggeneys 56
Remaining Extent of Portion 1 of the Farm Aggeneys 56	Portion 2 of the Farm Aggeneys 56
Portion 12 of the Farm Aggeneys 56	Portion 13 of the Farm Aggeneys 56

It is the Developer's intention to bid each solar PV facility under the Department of Mineral Resources and Energy's<sup>1</sup> Renewable Energy Independent Power Producer Procurement (REIPPP) Programme. The power generated from each solar PV facility will be sold to Eskom and fed into the national electricity grid through the proposed grid connection. The development of the solar PV facilities and the grid connection will assist with the achievement of the electricity goals as set out in the Integrated Resources Plan (IRP), 2019.

<sup>1</sup> The Department of Mineral Resources and Energy is a merge between the Department of Mineral Resources (DMR) and the Department of Energy (DoE).

The study area is located within Zone 8 of the Renewable Energy Development Zones (REDZ) (also known as the Springbok REDZ).

The applicant for each of the solar PV facilities will be a separate Special Purpose Vehicles (SPV). The applicant for Geelstert 1 is Geelstert Solar Facility 1 (Pty) Ltd, and the applicant for Geelstert 2 is Geelstert Solar Facility 2 (Pty) Ltd. The applicant for the Geelstert Grid Connection is ABO Wind renewable energies (Pty) Ltd. Three (3) separate Applications for Environmental Authorisation have been submitted to the Department of Environmental Affairs (DEA).

The notification of the development of two 125MW solar photovoltaic (PV) facilities and the associated grid connection distributed on 13 July 2020, has reference. The notification letter was accompanied by the Background Information Document (BID) which provided information regarding these Basic Assessment (BA) processes. If you have not received these documents, please inform us accordingly or we encourage you to visit our online stakeholder engagement platform at [www.savannahsa.com/public-documents/energy-generation/geelstert-1-and-geelstert-2-solar-pv-facilities-and-associated-grid-connection/](http://www.savannahsa.com/public-documents/energy-generation/geelstert-1-and-geelstert-2-solar-pv-facilities-and-associated-grid-connection/) the public documents for these three (3) projects are available for your perusal.

#### **AVAILABILITY OF BASIC ASSESSMENT REPORTS FOR REVIEW AND COMMENT**

In terms of Regulation 43(2) of the EIA Regulations, 2014, as amended, this letter serves to inform you that the Basic Assessment Reports (BARs) are available for review and written comments. The BARs' review and comment period is from **Thursday, 20 August 2020 until Monday, 21 September 2020**.

<b>Applicant name</b>	<b>Project/BA Report</b>
Geelstert Solar Facility 1 (Pty) Ltd	Geelstert 1
Geelstert Solar Facility 2 (Pty) Ltd	Geelstert 2
ABO Wind renewable energies (Pty) Ltd	Geelstert Grid Connection

The reports are available for downloading from our public participation platform at [www.savannahsa.com/public-documents/energy-generation/geelstert-1-and-geelstert-2-solar-pv-facilities-and-associated-grid-connection/](http://www.savannahsa.com/public-documents/energy-generation/geelstert-1-and-geelstert-2-solar-pv-facilities-and-associated-grid-connection/)

The restrictions enforced in terms of Government Gazette 43096 which placed the country in a national state of disaster limiting the movement and gathering of people to curb the spread of the COVID-19 virus has placed some limitations on making hard copies of the BARs available at public places such as libraries and municipal offices. As per our approved public participation plan submitted to the Department of Environmental Affairs (DEA), you can also request that an electronic copy of the BARs be sent to you via file transfer services such as WeTransfer or Dropbox.

Please submit your written comments on the BARs by **Monday, 21 September 2020** via our public participation portal (link provided above) or:

- » Telephone: 011 656 3237
- » Mobile: 060 978 8396
- » Fax: 086 684 0547
- » Post: PO Box 148, Sunninghill, 2157
- » E-mail: [publicprocess@savannahsa.com](mailto:publicprocess@savannahsa.com)

All comments can be addressed to Ronald Baloyi of Savannah Environmental.

All comments received during the 30-day review and comment period will be recorded and included in the Final BARs for submission to the DEA in line with Regulation 44 of the EIA Regulations, 2014, as amended (GN R326).

Please do not hesitate to contact us should you require additional information and/or clarification regarding the project. Our team welcomes your participation and look forward to your involvement throughout this process.

Kind regards



**Nicolene Venter**

Public Participation and Social Consultant

Email: [publicprocess@savannahsa.com](mailto:publicprocess@savannahsa.com)

**CC:** Ms Nondwe Khanye, Environmental Officer, Eskom Holdings SOC Ltd ( [REDACTED] )

Geeringh, John - Eskom Holdings SOC Ltd

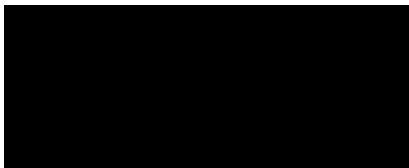

Date: 8/19/2020  
Time: 5:42 PM  
Creator: Ronald Baloyi Baloyi

Note

---

Subject: GEELSTERT 1 & 2 and GRID CONNECTION: Notification of the Availability of the Basic Assessment for review and comment

Body:

GEELSTERT 1 AND GEELSTERT 2 SOLAR PV FACILITIES AND GEELSTERT GRID CONNECTION NEAR AGGENEYS, NORTHERN CAPE PROVINCE

Dear Mr Geeringh,

The development of two separate solar photovoltaic (PV) facilities, each with a contracted capacity of up to 125MW, and associated grid connection is proposed on a site located approximately 11km south-east of the town of Aggeneys in the Northern Cape Province. The two solar PV facilities are to be known as Geelstert 1 and Geelstert 2. The grid connection solution will be known as Geelstert Grid Connection. The projects are situated within the Khâi-Ma Local Municipality, in the greater Namakwa District Municipality.

As a registered Interested and Affected Party (I&AP), you are hereby notified that the following three Basic Assessment Reports (BARs) are available for your review and comment from Thursday, 20 August 2020 until Monday, 21 September 2020. The reports are available for download from our website / stakeholder engagement platform on the above-mentioned link.

The restrictions enforced in terms of the Government Gazette 43096 which placed the country in a national state of disaster limiting the movement and gathering of people to curb the spread of the COVID-19 virus has placed some limitations on making hard copies of the BARs at the public places such as Libraries. We invite you to visit our online stakeholder engagement platform at <https://www.savannahsa.com/public-documents/energy-generation/geelstert-1-and-geelstert-2-solar-pv-facilities-and-associated-grid-connection/>

Should you not be able to access our online stakeholder engagement platform to download the BARs, please refer to the attached letter for alternative means to obtain the BARs. The attached letter also provides further details regarding the availability of the BARs.

Kind regards,

--



Please refer to the email saved in the Documents window.

19 August 2020

Ms Nondwe Khanye  
Environmental Officer  
Eskom Holdings SOC Ltd

E-mail: [REDACTED]

Dear Ms Khanye,

## **GEELSTERT 1 AND GEELSTERT 2 SOLAR PV FACILITIES AND GEELSTERT GRID CONNECTION NEAR AGGENEYS, NORTHERN CAPE PROVINCE**

---

### **NOTICE OF AVAILABILITY OF BASIC ASSESSMENT REPORTS FOR REVIEW AND COMMENTS**

---

The development of two separate solar photovoltaic (PV) facilities, each with a contracted capacity of up to 125MW, and associated grid connection is proposed on a site located approximately 11km south-east of the town of Aggeneys in the Northern Cape Province. The two solar PV facilities are to be known as Geelstert 1 and Geelstert 2. The grid connection solution will be known as Geelstert Grid Connection. The projects are situated within the Khâi-Ma Local Municipality, in the greater Namakwa District Municipality.

The two solar PV facilities are located on the Remaining Extent of the Farm Bloemhoek 61 and will be connected to the Aggeneys Main Transmission Substation (MTS). The grid connection will include a collector substation and a double-circuit power line of up to 220kV. The grid connection will traverse six (6) properties which include:

Remaining Extent of the Farm Bloemhoek 61	Remaining Extent of the Farm Aggeneys 56
Remaining Extent of Portion 1 of the Farm Aggeneys 56	Portion 2 of the Farm Aggeneys 56
Portion 12 of the Farm Aggeneys 56	Portion 13 of the Farm Aggeneys 56

It is the Developer's intention to bid each solar PV facility under the Department of Mineral Resources and Energy's<sup>1</sup> Renewable Energy Independent Power Producer Procurement (REIPPP) Programme. The power generated from each solar PV facility will be sold to Eskom and fed into the national electricity grid through the proposed grid connection. The development of the solar PV facilities and the grid connection will assist with the achievement of the electricity goals as set out in the Integrated Resources Plan (IRP), 2019.

<sup>1</sup> The Department of Mineral Resources and Energy is a merge between the Department of Mineral Resources (DMR) and the Department of Energy (DoE).

The study area is located within Zone 8 of the Renewable Energy Development Zones (REDZ) (also known as the Springbok REDZ).

The applicant for each of the solar PV facilities will be a separate Special Purpose Vehicles (SPV). The applicant for Geelstert 1 is Geelstert Solar Facility 1 (Pty) Ltd, and the applicant for Geelstert 2 is Geelstert Solar Facility 2 (Pty) Ltd. The applicant for the Geelstert Grid Connection is ABO Wind renewable energies (Pty) Ltd. Three (3) separate Applications for Environmental Authorisation have been submitted to the Department of Environmental Affairs (DEA).

The notification of the development of two 125MW solar photovoltaic (PV) facilities and the associated grid connection distributed on 13 July 2020, has reference. The notification letter was accompanied by the Background Information Document (BID) which provided information regarding these Basic Assessment (BA) processes. If you have not received these documents, please inform us accordingly or we encourage you to visit our online stakeholder engagement platform at [www.savannahsa.com/public-documents/energy-generation/geelstert-1-and-geelstert-2-solar-pv-facilities-and-associated-grid-connection/](http://www.savannahsa.com/public-documents/energy-generation/geelstert-1-and-geelstert-2-solar-pv-facilities-and-associated-grid-connection/) the public documents for these three (3) projects are available for your perusal.

#### **AVAILABILITY OF BASIC ASSESSMENT REPORTS FOR REVIEW AND COMMENT**

In terms of Regulation 43(2) of the EIA Regulations, 2014, as amended, this letter serves to inform you that the Basic Assessment Reports (BARs) are available for review and written comments. The BARs' review and comment period is from **Thursday, 20 August 2020 until Monday, 21 September 2020**.

<b>Applicant name</b>	<b>Project/BA Report</b>
Geelstert Solar Facility 1 (Pty) Ltd	Geelstert 1
Geelstert Solar Facility 2 (Pty) Ltd	Geelstert 2
ABO Wind renewable energies (Pty) Ltd	Geelstert Grid Connection

The reports are available for downloading from our public participation platform at [www.savannahsa.com/public-documents/energy-generation/geelstert-1-and-geelstert-2-solar-pv-facilities-and-associated-grid-connection/](http://www.savannahsa.com/public-documents/energy-generation/geelstert-1-and-geelstert-2-solar-pv-facilities-and-associated-grid-connection/)

The restrictions enforced in terms of Government Gazette 43096 which placed the country in a national state of disaster limiting the movement and gathering of people to curb the spread of the COVID-19 virus has placed some limitations on making hard copies of the BARs available at public places such as libraries and municipal offices. As per our approved public participation plan submitted to the Department of Environmental Affairs (DEA), you can also request that an electronic copy of the BARs be sent to you via file transfer services such as WeTransfer or Dropbox.

Please submit your written comments on the BARs by **Monday, 21 September 2020** via our public participation portal (link provided above) or:

- » Telephone: 011 656 3237
- » Mobile: 060 978 8396
- » Fax: 086 684 0547
- » Post: PO Box 148, Sunninghill, 2157
- » E-mail: [publicprocess@savannahsa.com](mailto:publicprocess@savannahsa.com)

All comments can be addressed to Ronald Baloyi of Savannah Environmental.

All comments received during the 30-day review and comment period will be recorded and included in the Final BARs for submission to the DEA in line with Regulation 44 of the EIA Regulations, 2014, as amended (GN R326).

Please do not hesitate to contact us should you require additional information and/or clarification regarding the project. Our team welcomes your participation and look forward to your involvement throughout this process.

Kind regards



**Nicolene Venter**

Public Participation and Social Consultant

Email: [publicprocess@savannahsa.com](mailto:publicprocess@savannahsa.com)

**CC:** Mr John Geeringh, Senior Environmental Adviser, Eskom Holdings SOC Ltd  
([john.geeringh@eskom.co.za](mailto:john.geeringh@eskom.co.za) / [geerinJH@eskom.co.za](mailto:geerinJH@eskom.co.za))

**Khanye, Nondwe - Eskom Holdings SOC Ltd**



Date: 8/19/2020  
Time: 5:44 PM  
Creator: Ronald Baloyi Baloyi

Note

---

Subject: GEELSTERT 1 & 2 and GRID CONNECTION: Notification of the Availability of the Basic Assessment for review and comment

Body:

**GEELSTERT 1 AND GEELSTERT 2 SOLAR PV FACILITIES AND GEELSTERT GRID CONNECTION NEAR AGGENEYS, NORTHERN CAPE PROVINCE**

Dear Ms Khanye,

The development of two separate solar photovoltaic (PV) facilities, each with a contracted capacity of up to 125MW, and associated grid connection is proposed on a site located approximately 11km south-east of the town of Aggeneys in the Northern Cape Province. The two solar PV facilities are to be known as Geelstert 1 and Geelstert 2. The grid connection solution will be known as Geelstert Grid Connection. The projects are situated within the Khâi-Ma Local Municipality, in the greater Namakwa District Municipality.

As a registered Interested and Affected Party (I&AP), you are hereby notified that the following three Basic Assessment Reports (BARs) are available for your review and comment from Thursday, 20 August 2020 until Monday, 21 September 2020. The reports are available for download from our website / stakeholder engagement platform on the above-mentioned link.

The restrictions enforced in terms of the Government Gazette 43096 which placed the country in a national state of disaster limiting the movement and gathering of people to curb the spread of the COVID-19 virus has placed some limitations on making hard copies of the BARs at the public places such as Libraries. We invite you to visit our online stakeholder engagement platform at <https://www.savannahsa.com/public-documents/energy-generation/geelstert-1-and-geelstert-2-solar-pv-facilities-and-associated-grid-connection/>

Should you not be able to access our online stakeholder engagement platform to download the BARs, please refer to the attached letter for alternative means to obtain the BARs. The attached letter also provides further details regarding the availability of the BARs.

Kind regards,

--



Please refer to the email saved in the Documents window.



19 August 2020

Mr Constance Hoogstad  
Programme Manager  
Endangered Wildlife Trust

E-mail

Dear Mr Hoogstad,

## GEELSTERT 1 AND GEELSTERT 2 SOLAR PV FACILITIES AND GEELSTERT GRID CONNECTION NEAR AGGENEYS, NORTHERN CAPE PROVINCE

### NOTICE OF AVAILABILITY OF BASIC ASSESSMENT REPORTS FOR REVIEW AND COMMENTS

The development of two separate solar photovoltaic (PV) facilities, each with a contracted capacity of up to 125MW, and associated grid connection is proposed on a site located approximately 11km south-east of the town of Aggeneys in the Northern Cape Province. The two solar PV facilities are to be known as Geelstert 1 and Geelstert 2. The grid connection solution will be known as Geelstert Grid Connection. The projects are situated within the Khâi-Ma Local Municipality, in the greater Namakwa District Municipality.

The two solar PV facilities are located on the Remaining Extent of the Farm Bloemhoek 61 and will be connected to the Aggeneys Main Transmission Substation (MTS). The grid connection will include a collector substation and a double-circuit power line of up to 220kV. The grid connection will traverse six (6) properties which include:

Remaining Extent of the Farm Bloemhoek 61	Remaining Extent of the Farm Aggeneys 56
Remaining Extent of Portion 1 of the Farm Aggeneys 56	Portion 2 of the Farm Aggeneys 56
Portion 12 of the Farm Aggeneys 56	Portion 13 of the Farm Aggeneys 56

It is the Developer's intention to bid each solar PV facility under the Department of Mineral Resources and Energy's<sup>1</sup> Renewable Energy Independent Power Producer Procurement (REIPPP) Programme. The power generated from each solar PV facility will be sold to Eskom and fed into the national electricity grid through the proposed grid connection. The development of the solar PV facilities and the grid connection will assist with the achievement of the electricity goals as set out in the Integrated Resources Plan (IRP), 2019.

<sup>1</sup> The Department of Mineral Resources and Energy is a merge between the Department of Mineral Resources (DMR) and the Department of Energy (DoE).

The study area is located within Zone 8 of the Renewable Energy Development Zones (REDZ) (also known as the Springbok REDZ).

The applicant for each of the solar PV facilities will be a separate Special Purpose Vehicles (SPV). The applicant for Geelstert 1 is Geelstert Solar Facility 1 (Pty) Ltd, and the applicant for Geelstert 2 is Geelstert Solar Facility 2 (Pty) Ltd. The applicant for the Geelstert Grid Connection is ABO Wind renewable energies (Pty) Ltd. Three (3) separate Applications for Environmental Authorisation have been submitted to the Department of Environmental Affairs (DEA).

The notification of the development of two 125MW solar photovoltaic (PV) facilities and the associated grid connection distributed on 13 July 2020, has reference. The notification letter was accompanied by the Background Information Document (BID) which provided information regarding these Basic Assessment (BA) processes. If you have not received these documents, please inform us accordingly or we encourage you to visit our online stakeholder engagement platform at [www.savannahsa.com/public-documents/energy-generation/geelstert-1-and-geelstert-2-solar-pv-facilities-and-associated-grid-connection/](http://www.savannahsa.com/public-documents/energy-generation/geelstert-1-and-geelstert-2-solar-pv-facilities-and-associated-grid-connection/) the public documents for these three (3) projects are available for your perusal.

#### **AVAILABILITY OF BASIC ASSESSMENT REPORTS FOR REVIEW AND COMMENT**

In terms of Regulation 43(2) of the EIA Regulations, 2014, as amended, this letter serves to inform you that the Basic Assessment Reports (BARs) are available for review and written comments. The BARs' review and comment period is from **Thursday, 20 August 2020 until Monday, 21 September 2020**.

<b>Applicant name</b>	<b>Project/BA Report</b>
Geelstert Solar Facility 1 (Pty) Ltd	Geelstert 1
Geelstert Solar Facility 2 (Pty) Ltd	Geelstert 2
ABO Wind renewable energies (Pty) Ltd	Geelstert Grid Connection

The reports are available for downloading from our public participation platform at [www.savannahsa.com/public-documents/energy-generation/geelstert-1-and-geelstert-2-solar-pv-facilities-and-associated-grid-connection/](http://www.savannahsa.com/public-documents/energy-generation/geelstert-1-and-geelstert-2-solar-pv-facilities-and-associated-grid-connection/)

The restrictions enforced in terms of Government Gazette 43096 which placed the country in a national state of disaster limiting the movement and gathering of people to curb the spread of the COVID-19 virus has placed some limitations on making hard copies of the BARs available at public places such as libraries and municipal offices. As per our approved public participation plan submitted to the Department of Environmental Affairs (DEA), you can also request that an electronic copy of the BARs be sent to you via file transfer services such as WeTransfer or Dropbox.

Please submit your written comments on the BARs by **Monday, 21 September 2020** via our public participation portal (link provided above) or:

- » Telephone: 011 656 3237
- » Mobile: 060 978 8396
- » Fax: 086 684 0547
- » Post: PO Box 148, Sunninghill, 2157
- » E-mail: [publicprocess@savannahsa.com](mailto:publicprocess@savannahsa.com)

All comments can be addressed to Ronald Baloyi of Savannah Environmental.

All comments received during the 30-day review and comment period will be recorded and included in the Final BARs for submission to the DEA in line with Regulation 44 of the EIA Regulations, 2014, as amended (GN R326).

Please do not hesitate to contact us should you require additional information and/or clarification regarding the project. Our team welcomes your participation and look forward to your involvement throughout this process.

Kind regards

A handwritten signature in black ink, appearing to read 'Nicolene Venter'.

**Nicolene Venter**

Public Participation and Social Consultant

Email: [publicprocess@savannahsa.com](mailto:publicprocess@savannahsa.com)

**Hoogstad, Constant - Endangered Wildlife Trust**

Date: 8/19/2020  
Time: 5:46 PM  
Creator: Ronald Baloyi Baloyi

## Note

Subject: GEELSTERT 1 & 2 and GRID CONNECTION: Notification of the Availability of the Basic Assessment for review and comment

## Body:

**GEELSTERT 1 AND GEELSTERT 2 SOLAR PV FACILITIES AND GEELSTERT GRID CONNECTION NEAR AGGENEYS, NORTHERN CAPE PROVINCE**

Dear Mr Hoogstad,

The development of two separate solar photovoltaic (PV) facilities, each with a contracted capacity of up to 125MW, and associated grid connection is proposed on a site located approximately 11km south-east of the town of Aggeneys in the Northern Cape Province. The two solar PV facilities are to be known as Geelstert 1 and Geelstert 2. The grid connection solution will be known as Geelstert Grid Connection. The projects are situated within the Khâi-Ma Local Municipality, in the greater Namakwa District Municipality.

As a registered Interested and Affected Party (I&AP), you are hereby notified that the following three Basic Assessment Reports (BARs) are available for your review and comment from Thursday, 20 August 2020 until Monday, 21 September 2020. The reports are available for download from our website / stakeholder engagement platform on the above-mentioned link.

The restrictions enforced in terms of the Government Gazette 43096 which placed the country in a national state of disaster limiting the movement and gathering of people to curb the spread of the COVID-19 virus has placed some limitations on making hard copies of the BARs at the public places such as Libraries. We invite you to visit our online stakeholder engagement platform at <https://www.savannahsa.com/public-documents/energy-generation/geelstert-1-and-geelstert-2-solar-pv-facilities-and-associated-grid-connection/>

Should you not be able to access our online stakeholder engagement platform to download the BARs, please refer to the attached letter for alternative means to obtain the BARs. The attached letter also provides further details regarding the availability of the BARs.

Kind regards,

--

An email has been sent to "Constant Hoogstad" <[REDACTED]>  
ronald@savannahsa.com;nicolene@savannahsa.com;"Ronald Baloyi Baloyi" <publicprocess@savannahsa.com>

Please refer to the email saved in the Documents window.

19 August 2020

Mr Obakeng Isaacs  
Municipal Manager  
Khâi-Ma Local Municipality

E-mail: [REDACTED]

Dear Mr Isaacs,

## GEELSTERT 1 AND GEELSTERT 2 SOLAR PV FACILITIES AND GEELSTERT GRID CONNECTION NEAR AGGENEYS, NORTHERN CAPE PROVINCE

### NOTICE OF AVAILABILITY OF BASIC ASSESSMENT REPORTS FOR REVIEW AND COMMENTS

The development of two separate solar photovoltaic (PV) facilities, each with a contracted capacity of up to 125MW, and associated grid connection is proposed on a site located approximately 11km south-east of the town of Aggeneys in the Northern Cape Province. The two solar PV facilities are to be known as Geelstert 1 and Geelstert 2. The grid connection solution will be known as Geelstert Grid Connection. The projects are situated within the Khâi-Ma Local Municipality, in the greater Namakwa District Municipality.

The two solar PV facilities are located on the Remaining Extent of the Farm Bloemhoek 61 and will be connected to the Aggeneis Main Transmission Substation (MTS). The grid connection will include a collector substation and a double-circuit power line of up to 220kV. The grid connection will traverse six (6) properties which include:

Remaining Extent of the Farm Bloemhoek 61	Remaining Extent of the Farm Aggeneys 56
Remaining Extent of Portion 1 of the Farm Aggeneys 56	Portion 2 of the Farm Aggeneys 56
Portion 12 of the Farm Aggeneys 56	Portion 13 of the Farm Aggeneys 56

It is the Developer's intention to bid each solar PV facility under the Department of Mineral Resources and Energy's<sup>1</sup> Renewable Energy Independent Power Producer Procurement (REIPPP) Programme. The power generated from each solar PV facility will be sold to Eskom and fed into the national electricity grid through the proposed grid connection. The development of the solar PV facilities and the grid connection will assist with the achievement of the electricity goals as set out in the Integrated Resources Plan (IRP), 2019.

<sup>1</sup> The Department of Mineral Resources and Energy is a merge between the Department of Mineral Resources (DMR) and the Department of Energy (DoE).

The study area is located within Zone 8 of the Renewable Energy Development Zones (REDZ) (also known as the Springbok REDZ).

The applicant for each of the solar PV facilities will be a separate Special Purpose Vehicles (SPV). The applicant for Geelstert 1 is Geelstert Solar Facility 1 (Pty) Ltd, and the applicant for Geelstert 2 is Geelstert Solar Facility 2 (Pty) Ltd. The applicant for the Geelstert Grid Connection is ABO Wind renewable energies (Pty) Ltd. Three (3) separate Applications for Environmental Authorisation have been submitted to the Department of Environmental Affairs (DEA).

The notification of the development of two 125MW solar photovoltaic (PV) facilities and the associated grid connection distributed on 13 July 2020, has reference. The notification letter was accompanied by the Background Information Document (BID) which provided information regarding these Basic Assessment (BA) processes. If you have not received these documents, please inform us accordingly or we encourage you to visit our online stakeholder engagement platform at [www.savannahsa.com/public-documents/energy-generation/geelstert-1-and-geelstert-2-solar-pv-facilities-and-associated-grid-connection/](http://www.savannahsa.com/public-documents/energy-generation/geelstert-1-and-geelstert-2-solar-pv-facilities-and-associated-grid-connection/) the public documents for these three (3) projects are available for your perusal.

#### **AVAILABILITY OF BASIC ASSESSMENT REPORTS FOR REVIEW AND COMMENT**

In terms of Regulation 43(2) of the EIA Regulations, 2014, as amended, this letter serves to inform you that the Basic Assessment Reports (BARs) are available for review and written comments. The BARs' review and comment period is from **Thursday, 20 August 2020 until Monday, 21 September 2020**.

<b>Applicant name</b>	<b>Project/BA Report</b>
Geelstert Solar Facility 1 (Pty) Ltd	Geelstert 1
Geelstert Solar Facility 2 (Pty) Ltd	Geelstert 2
ABO Wind renewable energies (Pty) Ltd	Geelstert Grid Connection

The reports are available for downloading from our public participation platform at [www.savannahsa.com/public-documents/energy-generation/geelstert-1-and-geelstert-2-solar-pv-facilities-and-associated-grid-connection/](http://www.savannahsa.com/public-documents/energy-generation/geelstert-1-and-geelstert-2-solar-pv-facilities-and-associated-grid-connection/)

The restrictions enforced in terms of Government Gazette 43096 which placed the country in a national state of disaster limiting the movement and gathering of people to curb the spread of the COVID-19 virus has placed some limitations on making hard copies of the BARs available at public places such as libraries and municipal offices. As per our approved public participation plan submitted to the Department of Environmental Affairs (DEA), you can also request that an electronic copy of the BARs be sent to you via file transfer services such as WeTransfer or Dropbox.

Please submit your written comments on the BARs by **Monday, 21 September 2020** via our public participation portal (link provided above) or:

- » Telephone: 011 656 3237
- » Mobile: 060 978 8396
- » Fax: 086 684 0547
- » Post: PO Box 148, Sunninghill, 2157
- » E-mail: [publicprocess@savannahsa.com](mailto:publicprocess@savannahsa.com)

All comments can be addressed to Ronald Baloyi of Savannah Environmental.

All comments received during the 30-day review and comment period will be recorded and included in the Final BARs for submission to the DEA in line with Regulation 44 of the EIA Regulations, 2014, as amended (GN R326).

Please do not hesitate to contact us should you require additional information and/or clarification regarding the project. Our team welcomes your participation and look forward to your involvement throughout this process.

Kind regards

A handwritten signature in black ink, appearing to read "Nicolene Venter". The signature is written in a cursive, flowing style.

**Nicolene Venter**

Public Participation and Social Consultant

Email: [publicprocess@savannahsa.com](mailto:publicprocess@savannahsa.com)

Isaacs, Obakeng - Khai Ma Local Municipality

Date: 8/19/2020  
Time: 6:22 PM  
Creator: Ronald Baloyi Baloyi

Note

---

Subject: GEELSTERT 1 & 2 and GRID CONNECTION: Notification of the Availability of the Basic Assessment for review and comment

Body:

**GEELSTERT 1 AND GEELSTERT 2 SOLAR PV FACILITIES AND GEELSTERT GRID CONNECTION NEAR AGGENEYS, NORTHERN CAPE PROVINCE**

Dear Obakeng Isaacs,

The development of two separate solar photovoltaic (PV) facilities, each with a contracted capacity of up to 125MW, and associated grid connection is proposed on a site located approximately 11km south-east of the town of Aggeneys in the Northern Cape Province. The two solar PV facilities are to be known as Geelstert 1 and Geelstert 2. The grid connection solution will be known as Geelstert Grid Connection. The projects are situated within the Khâi-Ma Local Municipality, in the greater Namakwa District Municipality.

As a registered Interested and Affected Party (I&AP), you are hereby notified that the following three Basic Assessment Reports (BARs) are available for your review and comment from Thursday, 20 August 2020 until Monday, 21 September 2020. The reports are available for download from our website / stakeholder engagement platform on the above-mentioned link.

The restrictions enforced in terms of the Government Gazette 43096 which placed the country in a national state of disaster limiting the movement and gathering of people to curb the spread of the COVID-19 virus has placed some limitations on making hard copies of the BARs at the public places such as Libraries. We invite you to visit our online stakeholder engagement platform at <https://www.savannahsa.com/public-documents/energy-generation/geelstert-1-and-geelstert-2-solar-pv-facilities-and-associated-grid-connection/>

Should you not be able to access our online stakeholder engagement platform to download the BARs, please refer to the attached letter for alternative means to obtain the BARs. The attached letter also provides further details regarding the availability of the BARs.

Kind regards,

--

An email has been sent to "Obakeng Isaacs" [REDACTED] nicolene@savannahsa.com;ronald@savannahsa.com;"Ronald Baloyi Baloyi" <publicprocess@savannahsa.com>

Please refer to the email saved in the Documents window.



19 August 2020

Mr Chris Fortuin  
Municipal Manager  
Namakwa District Municipality

E-mail: [REDACTED]

Dear Mr Fortuin,

## **GEELSTERT 1 AND GEELSTERT 2 SOLAR PV FACILITIES AND GEELSTERT GRID CONNECTION NEAR AGGENEYS, NORTHERN CAPE PROVINCE**

---

### **NOTICE OF AVAILABILITY OF BASIC ASSESSMENT REPORTS FOR REVIEW AND COMMENTS**

---

The development of two separate solar photovoltaic (PV) facilities, each with a contracted capacity of up to 125MW, and associated grid connection is proposed on a site located approximately 11km south-east of the town of Aggeneys in the Northern Cape Province. The two solar PV facilities are to be known as Geelstert 1 and Geelstert 2. The grid connection solution will be known as Geelstert Grid Connection. The projects are situated within the Khâi-Ma Local Municipality, in the greater Namakwa District Municipality.

The two solar PV facilities are located on the Remaining Extent of the Farm Bloemhoek 61 and will be connected to the Aggeneis Main Transmission Substation (MTS). The grid connection will include a collector substation and a double-circuit power line of up to 220kV. The grid connection will traverse six (6) properties which include:

Remaining Extent of the Farm Bloemhoek 61	Remaining Extent of the Farm Aggeneys 56
Remaining Extent of Portion 1 of the Farm Aggeneys 56	Portion 2 of the Farm Aggeneys 56
Portion 12 of the Farm Aggeneys 56	Portion 13 of the Farm Aggeneys 56

It is the Developer's intention to bid each solar PV facility under the Department of Mineral Resources and Energy's<sup>1</sup> Renewable Energy Independent Power Producer Procurement (REIPPP) Programme. The power generated from each solar PV facility will be sold to Eskom and fed into the national electricity grid through the proposed grid connection. The development of the solar PV facilities and the grid connection will assist with the achievement of the electricity goals as set out in the Integrated Resources Plan (IRP), 2019.

<sup>1</sup> The Department of Mineral Resources and Energy is a merge between the Department of Mineral Resources (DMR) and the Department of Energy (DoE).

The study area is located within Zone 8 of the Renewable Energy Development Zones (REDZ) (also known as the Springbok REDZ).

The applicant for each of the solar PV facilities will be a separate Special Purpose Vehicles (SPV). The applicant for Geelstert 1 is Geelstert Solar Facility 1 (Pty) Ltd, and the applicant for Geelstert 2 is Geelstert Solar Facility 2 (Pty) Ltd. The applicant for the Geelstert Grid Connection is ABO Wind renewable energies (Pty) Ltd. Three (3) separate Applications for Environmental Authorisation have been submitted to the Department of Environmental Affairs (DEA).

The notification of the development of two 125MW solar photovoltaic (PV) facilities and the associated grid connection distributed on 13 July 2020, has reference. The notification letter was accompanied by the Background Information Document (BID) which provided information regarding these Basic Assessment (BA) processes. If you have not received these documents, please inform us accordingly or we encourage you to visit our online stakeholder engagement platform at [www.savannahsa.com/public-documents/energy-generation/geelstert-1-and-geelstert-2-solar-pv-facilities-and-associated-grid-connection/](http://www.savannahsa.com/public-documents/energy-generation/geelstert-1-and-geelstert-2-solar-pv-facilities-and-associated-grid-connection/) the public documents for these three (3) projects are available for your perusal.

#### **AVAILABILITY OF BASIC ASSESSMENT REPORTS FOR REVIEW AND COMMENT**

In terms of Regulation 43(2) of the EIA Regulations, 2014, as amended, this letter serves to inform you that the Basic Assessment Reports (BARs) are available for review and written comments. The BARs' review and comment period is from **Thursday, 20 August 2020 until Monday, 21 September 2020**.

<b>Applicant name</b>	<b>Project/BA Report</b>
Geelstert Solar Facility 1 (Pty) Ltd	Geelstert 1
Geelstert Solar Facility 2 (Pty) Ltd	Geelstert 2
ABO Wind renewable energies (Pty) Ltd	Geelstert Grid Connection

The reports are available for downloading from our public participation platform at [www.savannahsa.com/public-documents/energy-generation/geelstert-1-and-geelstert-2-solar-pv-facilities-and-associated-grid-connection/](http://www.savannahsa.com/public-documents/energy-generation/geelstert-1-and-geelstert-2-solar-pv-facilities-and-associated-grid-connection/)

The restrictions enforced in terms of Government Gazette 43096 which placed the country in a national state of disaster limiting the movement and gathering of people to curb the spread of the COVID-19 virus has placed some limitations on making hard copies of the BARs available at public places such as libraries and municipal offices. As per our approved public participation plan submitted to the Department of Environmental Affairs (DEA), you can also request that an electronic copy of the BARs be sent to you via file transfer services such as WeTransfer or Dropbox.

Please submit your written comments on the BARs by **Monday, 21 September 2020** via our public participation portal (link provided above) or:

- » Telephone: 011 656 3237
- » Mobile: 060 978 8396
- » Fax: 086 684 0547
- » Post: PO Box 148, Sunninghill, 2157
- » E-mail: [publicprocess@savannahsa.com](mailto:publicprocess@savannahsa.com)

All comments can be addressed to Ronald Baloyi of Savannah Environmental.

All comments received during the 30-day review and comment period will be recorded and included in the Final BARs for submission to the DEA in line with Regulation 44 of the EIA Regulations, 2014, as amended (GN R326).

Please do not hesitate to contact us should you require additional information and/or clarification regarding the project. Our team welcomes your participation and look forward to your involvement throughout this process.

Kind regards

A handwritten signature in black ink, appearing to read 'Nicolene Venter', written in a cursive style.

**Nicolene Venter**

Public Participation and Social Consultant

Email: [publicprocess@savannahsa.com](mailto:publicprocess@savannahsa.com)

**Fortuin, Chris - Namakwa District Municipality**

Date: 8/19/2020  
Time: 6:27 PM  
Creator: Ronald Baloyi Baloyi

Note

---

Subject: GEELSTERT 1 & 2 and GRID CONNECTION: Notification of the Availability of the Basic Assessment for review and comment

Body:

**GEELSTERT 1 AND GEELSTERT 2 SOLAR PV FACILITIES AND GEELSTERT GRID CONNECTION NEAR AGGENEYS, NORTHERN CAPE PROVINCE**

Dear Mr Fortuin,

The development of two separate solar photovoltaic (PV) facilities, each with a contracted capacity of up to 125MW, and associated grid connection is proposed on a site located approximately 11km south-east of the town of Aggeneys in the Northern Cape Province. The two solar PV facilities are to be known as Geelstert 1 and Geelstert 2. The grid connection solution will be known as Geelstert Grid Connection. The projects are situated within the Khâi-Ma Local Municipality, in the greater Namakwa District Municipality.

As a registered Interested and Affected Party (I&AP), you are hereby notified that the following three Basic Assessment Reports (BARs) are available for your review and comment from Thursday, 20 August 2020 until Monday, 21 September 2020. The reports are available for download from our website / stakeholder engagement platform on the above-mentioned link.

The restrictions enforced in terms of the Government Gazette 43096 which placed the country in a national state of disaster limiting the movement and gathering of people to curb the spread of the COVID-19 virus has placed some limitations on making hard copies of the BARs at the public places such as Libraries. We invite you to visit our online stakeholder engagement platform at <https://www.savannahsa.com/public-documents/energy-generation/geelstert-1-and-geelstert-2-solar-pv-facilities-and-associated-grid-connection/>

Should you not be able to access our online stakeholder engagement platform to download the BARs, please refer to the attached letter for alternative means to obtain the BARs. The attached letter also provides further details regarding the availability of the BARs.

Kind regards,

--

An email has been sent to "Chris Fortuin" [REDACTED] nicolene@savannahsa.com;ronald@savannahsa.com;"Ronald Baloyi Baloyi" <publicprocess@savannahsa.com>

Please refer to the email saved in the Documents window.

19 August 2020

Mr Peter Cloete  
Production Scientist: Ecologist  
Northern Cape Department of Environment and Nature Conservation

Per e-mail: [REDACTED]

Dear Mr Cloete,

## **GEELSTERT 1 AND GEELSTERT 2 SOLAR PV FACILITIES AND GEELSTERT GRID CONNECTION NEAR AGGENEYS, NORTHERN CAPE PROVINCE**

---

### **NOTICE OF AVAILABILITY OF BASIC ASSESSMENT REPORTS FOR REVIEW AND COMMENTS**

---

The development of two separate solar photovoltaic (PV) facilities, each with a contracted capacity of up to 125MW, and associated grid connection is proposed on a site located approximately 11km south-east of the town of Aggeneys in the Northern Cape Province. The two solar PV facilities are to be known as Geelstert 1 and Geelstert 2. The grid connection solution will be known as Geelstert Grid Connection. The projects are situated within the Khâi-Ma Local Municipality, in the greater Namakwa District Municipality.

The two solar PV facilities are located on the Remaining Extent of the Farm Bloemhoek 61 and will be connected to the Aggeneys Main Transmission Substation (MTS). The grid connection will include a collector substation and a double-circuit power line of up to 220kV. The grid connection will traverse six (6) properties which include:

Remaining Extent of the Farm Bloemhoek 61	Remaining Extent of the Farm Aggeneys 56
Remaining Extent of Portion 1 of the Farm Aggeneys 56	Portion 2 of the Farm Aggeneys 56
Portion 12 of the Farm Aggeneys 56	Portion 13 of the Farm Aggeneys 56

It is the Developer's intention to bid each solar PV facility under the Department of Mineral Resources and Energy's<sup>1</sup> Renewable Energy Independent Power Producer Procurement (REIPPP) Programme. The power generated from each solar PV facility will be sold to Eskom and fed into the national electricity grid through the proposed grid connection. The development of the solar PV facilities and the grid connection will assist with the achievement of the electricity goals as set out in the Integrated Resources Plan (IRP), 2019.

<sup>1</sup> The Department of Mineral Resources and Energy is a merge between the Department of Mineral Resources (DMR) and the Department of Energy (DoE).

The study area is located within Zone 8 of the Renewable Energy Development Zones (REDZ) (also known as the Springbok REDZ).

The applicant for each of the solar PV facilities will be a separate Special Purpose Vehicles (SPV). The applicant for Geelstert 1 is Geelstert Solar Facility 1 (Pty) Ltd, and the applicant for Geelstert 2 is Geelstert Solar Facility 2 (Pty) Ltd. The applicant for the Geelstert Grid Connection is ABO Wind renewable energies (Pty) Ltd. Three (3) separate Applications for Environmental Authorisation have been submitted to the Department of Environmental Affairs (DEA).

The notification of the development of two 125MW solar photovoltaic (PV) facilities and the associated grid connection distributed on 13 July 2020, has reference. The notification letter was accompanied by the Background Information Document (BID) which provided information regarding these Basic Assessment (BA) processes. If you have not received these documents, please inform us accordingly or we encourage you to visit our online stakeholder engagement platform at [www.savannahsa.com/public-documents/energy-generation/geelstert-1-and-geelstert-2-solar-pv-facilities-and-associated-grid-connection/](http://www.savannahsa.com/public-documents/energy-generation/geelstert-1-and-geelstert-2-solar-pv-facilities-and-associated-grid-connection/) the public documents for these three (3) projects are available for your perusal.

#### **AVAILABILITY OF BASIC ASSESSMENT REPORTS FOR REVIEW AND COMMENT**

In terms of Regulation 43(2) of the EIA Regulations, 2014, as amended, this letter serves to inform you that the Basic Assessment Reports (BARs) are available for review and written comments. The BARs' review and comment period is from **Thursday, 20 August 2020 until Monday, 21 September 2020**.

<b>Applicant name</b>	<b>Project/BA Report</b>
Geelstert Solar Facility 1 (Pty) Ltd	Geelstert 1
Geelstert Solar Facility 2 (Pty) Ltd	Geelstert 2
ABO Wind renewable energies (Pty) Ltd	Geelstert Grid Connection

The reports are available for downloading from our public participation platform at [www.savannahsa.com/public-documents/energy-generation/geelstert-1-and-geelstert-2-solar-pv-facilities-and-associated-grid-connection/](http://www.savannahsa.com/public-documents/energy-generation/geelstert-1-and-geelstert-2-solar-pv-facilities-and-associated-grid-connection/)

The restrictions enforced in terms of Government Gazette 43096 which placed the country in a national state of disaster limiting the movement and gathering of people to curb the spread of the COVID-19 virus has placed some limitations on making hard copies of the BARs available at public places such as libraries and municipal offices. As per our approved public participation plan submitted to the Department of Environmental Affairs (DEA), you can also request that an electronic copy of the BARs be sent to you via file transfer services such as WeTransfer or Dropbox.

Please submit your written comments on the BARs by **Monday, 21 September 2020** via our public participation portal (link provided above) or:

- » Telephone: 011 656 3237
- » Mobile: 060 978 8396
- » Fax: 086 684 0547
- » Post: PO Box 148, Sunninghill, 2157
- » E-mail: [publicprocess@savannahsa.com](mailto:publicprocess@savannahsa.com)

All comments can be addressed to Ronald Baloyi of Savannah Environmental.

All comments received during the 30-day review and comment period will be recorded and included in the Final BARs for submission to the DEA in line with Regulation 44 of the EIA Regulations, 2014, as amended (GN R326).

Please do not hesitate to contact us should you require additional information and/or clarification regarding the project. Our team welcomes your participation and look forward to your involvement throughout this process.

Kind regards



**Nicolene Venter**

Public Participation and Social Consultant

Email: [publicprocess@savannahsa.com](mailto:publicprocess@savannahsa.com)

**CC:** Mr Bryan Fisher, Director: Environmental Quality Management, Northern Cape Department of Environment and Nature Conservation [REDACTED]  
Ms Dineo Moleko, Assistant Director: Impact Management, Northern Cape Department of Environment and Nature Conservation [REDACTED]

**Cloete, Peter - Northern Cape Department of Environment & Nature Conservation**

Date: 8/19/2020  
Time: 5:51 PM  
Creator: Ronald Baloyi Baloyi

Note

---

Subject: GEELSTERT 1 & 2 and GRID CONNECTION: Notification of the Availability of the Basic Assessment for review and comment

Body:

**GEELSTERT 1 AND GEELSTERT 2 SOLAR PV FACILITIES AND GEELSTERT GRID CONNECTION NEAR AGGENEYS, NORTHERN CAPE PROVINCE**

Dear Mr Cloete,

The development of two separate solar photovoltaic (PV) facilities, each with a contracted capacity of up to 125MW, and associated grid connection is proposed on a site located approximately 11km south-east of the town of Aggeneys in the Northern Cape Province. The two solar PV facilities are to be known as Geelstert 1 and Geelstert 2. The grid connection solution will be known as Geelstert Grid Connection. The projects are situated within the Khâi-Ma Local Municipality, in the greater Namakwa District Municipality.

As a registered Interested and Affected Party (I&AP), you are hereby notified that the following three Basic Assessment Reports (BARs) are available for your review and comment from Thursday, 20 August 2020 until Monday, 21 September 2020. The reports are available for download from our website / stakeholder engagement platform on the above-mentioned link.

The restrictions enforced in terms of the Government Gazette 43096 which placed the country in a national state of disaster limiting the movement and gathering of people to curb the spread of the COVID-19 virus has placed some limitations on making hard copies of the BARs at the public places such as Libraries. We invite you to visit our online stakeholder engagement platform at <https://www.savannahsa.com/public-documents/energy-generation/geelstert-1-and-geelstert-2-solar-pv-facilities-and-associated-grid-connection/>

Should you not be able to access our online stakeholder engagement platform to download the BARs, please refer to the attached letter for alternative means to obtain the BARs. The attached letter also provides further details regarding the availability of the BARs.

Kind regards,

--

An email has been sent to "Peter Cloete" [REDACTED] nicolene@savannahsa.com;ronald@savannahsa.com;"Ronald Baloyi Baloyi" <publicprocess@savannahsa.com>

Please refer to the email saved in the Documents window.



19 August 2020

Mr Bryan Fisher  
Director: Environmental Quality Management  
Department of Environmental and Nature Conservation

E-mail: [REDACTED]

Dear Mr Fisher,

## GEELSTERT 1 AND GEELSTERT 2 SOLAR PV FACILITIES AND GEELSTERT GRID CONNECTION NEAR AGGENEYS, NORTHERN CAPE PROVINCE

### NOTICE OF AVAILABILITY OF BASIC ASSESSMENT REPORTS FOR REVIEW AND COMMENTS

The development of two separate solar photovoltaic (PV) facilities, each with a contracted capacity of up to 125MW, and associated grid connection is proposed on a site located approximately 11km south-east of the town of Aggeneys in the Northern Cape Province. The two solar PV facilities are to be known as Geelstert 1 and Geelstert 2. The grid connection solution will be known as Geelstert Grid Connection. The projects are situated within the Khâi-Ma Local Municipality, in the greater Namakwa District Municipality.

The two solar PV facilities are located on the Remaining Extent of the Farm Bloemhoek 61 and will be connected to the Aggeneis Main Transmission Substation (MTS). The grid connection will include a collector substation and a double-circuit power line of up to 220kV. The grid connection will traverse six (6) properties which include:

Remaining Extent of the Farm Bloemhoek 61	Remaining Extent of the Farm Aggeneys 56
Remaining Extent of Portion 1 of the Farm Aggeneys 56	Portion 2 of the Farm Aggeneys 56
Portion 12 of the Farm Aggeneys 56	Portion 13 of the Farm Aggeneys 56

It is the Developer's intention to bid each solar PV facility under the Department of Mineral Resources and Energy's<sup>1</sup> Renewable Energy Independent Power Producer Procurement (REIPPP) Programme. The power generated from each solar PV facility will be sold to Eskom and fed into the national electricity grid through the proposed grid connection. The development of the solar PV facilities and the grid connection will assist with the achievement of the electricity goals as set out in the Integrated Resources Plan (IRP), 2019.

<sup>1</sup> The Department of Mineral Resources and Energy is a merge between the Department of Mineral Resources (DMR) and the Department of Energy (DoE).

The study area is located within Zone 8 of the Renewable Energy Development Zones (REDZ) (also known as the Springbok REDZ).

The applicant for each of the solar PV facilities will be a separate Special Purpose Vehicles (SPV). The applicant for Geelstert 1 is Geelstert Solar Facility 1 (Pty) Ltd, and the applicant for Geelstert 2 is Geelstert Solar Facility 2 (Pty) Ltd. The applicant for the Geelstert Grid Connection is ABO Wind renewable energies (Pty) Ltd. Three (3) separate Applications for Environmental Authorisation have been submitted to the Department of Environmental Affairs (DEA).

The notification of the development of two 125MW solar photovoltaic (PV) facilities and the associated grid connection distributed on 13 July 2020, has reference. The notification letter was accompanied by the Background Information Document (BID) which provided information regarding these Basic Assessment (BA) processes. If you have not received these documents, please inform us accordingly or we encourage you to visit our online stakeholder engagement platform at [www.savannahsa.com/public-documents/energy-generation/geelstert-1-and-geelstert-2-solar-pv-facilities-and-associated-grid-connection/](http://www.savannahsa.com/public-documents/energy-generation/geelstert-1-and-geelstert-2-solar-pv-facilities-and-associated-grid-connection/) the public documents for these three (3) projects are available for your perusal.

#### **AVAILABILITY OF BASIC ASSESSMENT REPORTS FOR REVIEW AND COMMENT**

In terms of Regulation 43(2) of the EIA Regulations, 2014, as amended, this letter serves to inform you that the Basic Assessment Reports (BARs) are available for review and written comments. The BARs' review and comment period is from **Thursday, 20 August 2020 until Monday, 21 September 2020**.

<b>Applicant name</b>	<b>Project/BA Report</b>
Geelstert Solar Facility 1 (Pty) Ltd	Geelstert 1
Geelstert Solar Facility 2 (Pty) Ltd	Geelstert 2
ABO Wind renewable energies (Pty) Ltd	Geelstert Grid Connection

The reports are available for downloading from our public participation platform at [www.savannahsa.com/public-documents/energy-generation/geelstert-1-and-geelstert-2-solar-pv-facilities-and-associated-grid-connection/](http://www.savannahsa.com/public-documents/energy-generation/geelstert-1-and-geelstert-2-solar-pv-facilities-and-associated-grid-connection/)

The restrictions enforced in terms of Government Gazette 43096 which placed the country in a national state of disaster limiting the movement and gathering of people to curb the spread of the COVID-19 virus has placed some limitations on making hard copies of the BARs available at public places such as libraries and municipal offices. As per our approved public participation plan submitted to the Department of Environmental Affairs (DEA), you can also request that an electronic copy of the BARs be sent to you via file transfer services such as WeTransfer or Dropbox.

Please submit your written comments on the BARs by **Monday, 21 September 2020** via our public participation portal (link provided above) or:

- » Telephone: 011 656 3237
- » Mobile: 060 978 8396
- » Fax: 086 684 0547
- » Post: PO Box 148, Sunninghill, 2157
- » E-mail: [publicprocess@savannahsa.com](mailto:publicprocess@savannahsa.com)

All comments can be addressed to Ronald Baloyi of Savannah Environmental.

All comments received during the 30-day review and comment period will be recorded and included in the Final BARs for submission to the DEA in line with Regulation 44 of the EIA Regulations, 2014, as amended (GN R326).

Please do not hesitate to contact us should you require additional information and/or clarification regarding the project. Our team welcomes your participation and look forward to your involvement throughout this process.

Kind regards



**Nicolene Venter**

Public Participation and Social Consultant

Email: [publicprocess@savannahsa.com](mailto:publicprocess@savannahsa.com)

**CC:** Ms Dineo Moleko, Assistant Director: Impact Management, Northern Cape Department of Environment and Nature Conservation [REDACTED]  
Mr Peter Cloete, Production Scientist: Ecologist, Northern Cape Department of Environment and Nature Conservation [REDACTED]

Fisher, Bryan - Northern Cape Department of Environment & Nature Conservation

Date: 8/19/2020  
Time: 5:53 PM  
Creator: Ronald Baloyi Baloyi

Note

---

Subject: GEELSTERT 1 & 2 and GRID CONNECTION: Notification of the Availability of the Basic Assessment for review and comment

Body:

**GEELSTERT 1 AND GEELSTERT 2 SOLAR PV FACILITIES AND GEELSTERT GRID CONNECTION NEAR AGGENEYS, NORTHERN CAPE PROVINCE**

Dear Mr Fisher,

The development of two separate solar photovoltaic (PV) facilities, each with a contracted capacity of up to 125MW, and associated grid connection is proposed on a site located approximately 11km south-east of the town of Aggeneys in the Northern Cape Province. The two solar PV facilities are to be known as Geelstert 1 and Geelstert 2. The grid connection solution will be known as Geelstert Grid Connection. The projects are situated within the Khâi-Ma Local Municipality, in the greater Namakwa District Municipality.

As a registered Interested and Affected Party (I&AP), you are hereby notified that the following three Basic Assessment Reports (BARs) are available for your review and comment from Thursday, 20 August 2020 until Monday, 21 September 2020. The reports are available for download from our website / stakeholder engagement platform on the above-mentioned link.

The restrictions enforced in terms of the Government Gazette 43096 which placed the country in a national state of disaster limiting the movement and gathering of people to curb the spread of the COVID-19 virus has placed some limitations on making hard copies of the BARs at the public places such as Libraries. We invite you to visit our online stakeholder engagement platform at <https://www.savannahsa.com/public-documents/energy-generation/geelstert-1-and-geelstert-2-solar-pv-facilities-and-associated-grid-connection/>

Should you not be able to access our online stakeholder engagement platform to download the BARs, please refer to the attached letter for alternative means to obtain the BARs. The attached letter also provides further details regarding the availability of the BARs.

Kind regards,

--

An email has been sent to "Bryan Fisher" [REDACTED]; nicolene@savannahsa.com;ronald@savannahsa.com;"Ronald Baloyi Baloyi" <publicprocess@savannahsa.com>

Please refer to the email saved in the Documents window.

19 August 2020

Ms Dineo Moleko  
Assistant Director: Impact Management  
Department of Environmental and Nature Conservation

E-mail: [REDACTED]

Dear Ms Moleko,

## **GEELSTERT 1 AND GEELSTERT 2 SOLAR PV FACILITIES AND GEELSTERT GRID CONNECTION NEAR AGGENEYS, NORTHERN CAPE PROVINCE**

---

### **NOTICE OF AVAILABILITY OF BASIC ASSESSMENT REPORTS FOR REVIEW AND COMMENTS**

---

The development of two separate solar photovoltaic (PV) facilities, each with a contracted capacity of up to 125MW, and associated grid connection is proposed on a site located approximately 11km south-east of the town of Aggeneys in the Northern Cape Province. The two solar PV facilities are to be known as Geelstert 1 and Geelstert 2. The grid connection solution will be known as Geelstert Grid Connection. The projects are situated within the Khâi-Ma Local Municipality, in the greater Namakwa District Municipality.

The two solar PV facilities are located on the Remaining Extent of the Farm Bloemhoek 61 and will be connected to the Aggeneys Main Transmission Substation (MTS). The grid connection will include a collector substation and a double-circuit power line of up to 220kV. The grid connection will traverse six (6) properties which include:

Remaining Extent of the Farm Bloemhoek 61	Remaining Extent of the Farm Aggeneys 56
Remaining Extent of Portion 1 of the Farm Aggeneys 56	Portion 2 of the Farm Aggeneys 56
Portion 12 of the Farm Aggeneys 56	Portion 13 of the Farm Aggeneys 56

It is the Developer's intention to bid each solar PV facility under the Department of Mineral Resources and Energy's<sup>1</sup> Renewable Energy Independent Power Producer Procurement (REIPPP) Programme. The power generated from each solar PV facility will be sold to Eskom and fed into the national electricity grid through the proposed grid connection. The development of the solar PV facilities and the grid connection will assist with the achievement of the electricity goals as set out in the Integrated Resources Plan (IRP), 2019.

<sup>1</sup> The Department of Mineral Resources and Energy is a merge between the Department of Mineral Resources (DMR) and the Department of Energy (DoE).

The study area is located within Zone 8 of the Renewable Energy Development Zones (REDZ) (also known as the Springbok REDZ).

The applicant for each of the solar PV facilities will be a separate Special Purpose Vehicles (SPV). The applicant for Geelstert 1 is Geelstert Solar Facility 1 (Pty) Ltd, and the applicant for Geelstert 2 is Geelstert Solar Facility 2 (Pty) Ltd. The applicant for the Geelstert Grid Connection is ABO Wind renewable energies (Pty) Ltd. Three (3) separate Applications for Environmental Authorisation have been submitted to the Department of Environmental Affairs (DEA).

The notification of the development of two 125MW solar photovoltaic (PV) facilities and the associated grid connection distributed on 13 July 2020, has reference. The notification letter was accompanied by the Background Information Document (BID) which provided information regarding these Basic Assessment (BA) processes. If you have not received these documents, please inform us accordingly or we encourage you to visit our online stakeholder engagement platform at [www.savannahsa.com/public-documents/energy-generation/geelstert-1-and-geelstert-2-solar-pv-facilities-and-associated-grid-connection/](http://www.savannahsa.com/public-documents/energy-generation/geelstert-1-and-geelstert-2-solar-pv-facilities-and-associated-grid-connection/) the public documents for these three (3) projects are available for your perusal.

#### **AVAILABILITY OF BASIC ASSESSMENT REPORTS FOR REVIEW AND COMMENT**

In terms of Regulation 43(2) of the EIA Regulations, 2014, as amended, this letter serves to inform you that the Basic Assessment Reports (BARs) are available for review and written comments. The BARs' review and comment period is from **Thursday, 20 August 2020 until Monday, 21 September 2020**.

<b>Applicant name</b>	<b>Project/BA Report</b>
Geelstert Solar Facility 1 (Pty) Ltd	Geelstert 1
Geelstert Solar Facility 2 (Pty) Ltd	Geelstert 2
ABO Wind renewable energies (Pty) Ltd	Geelstert Grid Connection

The reports are available for downloading from our public participation platform at [www.savannahsa.com/public-documents/energy-generation/geelstert-1-and-geelstert-2-solar-pv-facilities-and-associated-grid-connection/](http://www.savannahsa.com/public-documents/energy-generation/geelstert-1-and-geelstert-2-solar-pv-facilities-and-associated-grid-connection/)

The restrictions enforced in terms of Government Gazette 43096 which placed the country in a national state of disaster limiting the movement and gathering of people to curb the spread of the COVID-19 virus has placed some limitations on making hard copies of the BARs available at public places such as libraries and municipal offices. As per our approved public participation plan submitted to the Department of Environmental Affairs (DEA), you can also request that an electronic copy of the BARs be sent to you via file transfer services such as WeTransfer or Dropbox.

Please submit your written comments on the BARs by **Monday, 21 September 2020** via our public participation portal (link provided above) or:

- » Telephone: 011 656 3237
- » Mobile: 060 978 8396
- » Fax: 086 684 0547
- » Post: PO Box 148, Sunninghill, 2157
- » E-mail: [publicprocess@savannahsa.com](mailto:publicprocess@savannahsa.com)

All comments can be addressed to Ronald Baloyi of Savannah Environmental.

All comments received during the 30-day review and comment period will be recorded and included in the Final BARs for submission to the DEA in line with Regulation 44 of the EIA Regulations, 2014, as amended (GN R326).

Please do not hesitate to contact us should you require additional information and/or clarification regarding the project. Our team welcomes your participation and look forward to your involvement throughout this process.

Kind regards



**Nicolene Venter**

Public Participation and Social Consultant

Email: [publicprocess@savannahsa.com](mailto:publicprocess@savannahsa.com)

**CC:** Mr Bryan Fisher, Director: Environmental Quality Management, Northern Cape Department of Environment and Nature Conservation [REDACTED]  
Mr Peter Cloete, Production Scientist: Ecologist, Northern Cape Department of Environment and Nature Conservation [REDACTED]

**Moleko, Dineo - Northern Cape Department of Environment & Nature Conservation**

Date: 8/19/2020  
Time: 5:55 PM  
Creator: Ronald Baloyi Baloyi

## Note

Subject: GEELSTERT 1 & 2 and GRID CONNECTION: Notification of the Availability of the Basic Assessment for review and comment

## Body:

**GEELSTERT 1 AND GEELSTERT 2 SOLAR PV FACILITIES AND GEELSTERT GRID CONNECTION NEAR AGGENEYS, NORTHERN CAPE PROVINCE**

Dear Ms Moleko,

The development of two separate solar photovoltaic (PV) facilities, each with a contracted capacity of up to 125MW, and associated grid connection is proposed on a site located approximately 11km south-east of the town of Aggeneys in the Northern Cape Province. The two solar PV facilities are to be known as Geelstert 1 and Geelstert 2. The grid connection solution will be known as Geelstert Grid Connection. The projects are situated within the Khâi-Ma Local Municipality, in the greater Namakwa District Municipality.

As a registered Interested and Affected Party (I&AP), you are hereby notified that the following three Basic Assessment Reports (BARs) are available for your review and comment from Thursday, 20 August 2020 until Monday, 21 September 2020. The reports are available for download from our website / stakeholder engagement platform on the above-mentioned link.

The restrictions enforced in terms of the Government Gazette 43096 which placed the country in a national state of disaster limiting the movement and gathering of people to curb the spread of the COVID-19 virus has placed some limitations on making hard copies of the BARs at the public places such as Libraries. We invite you to visit our online stakeholder engagement platform at <https://www.savannahsa.com/public-documents/energy-generation/geelstert-1-and-geelstert-2-solar-pv-facilities-and-associated-grid-connection/>

Should you not be able to access our online stakeholder engagement platform to download the BARs, please refer to the attached letter for alternative means to obtain the BARs. The attached letter also provides further details regarding the availability of the BARs.

Kind regards,

--

An email has been sent to "Dineo Moleko" [REDACTED] nicolene@savannahsa.com;ronald@savannahsa.com;"Ronald Baloyi Baloyi" <publicprocess@savannahsa.com>

Please refer to the email saved in the Documents window.



19 August 2020

Mr Timothy Ratha  
Heritage Officer: Ngwao-Boswa Ya Kapa Bokone

E-mail: [REDACTED]

Dear Mr Ratha,

## **GEELSTERT 1 AND GEELSTERT 2 SOLAR PV FACILITIES AND GEELSTERT GRID CONNECTION NEAR AGGENEYS, NORTHERN CAPE PROVINCE**

---

### **NOTICE OF AVAILABILITY OF BASIC ASSESSMENT REPORTS FOR REVIEW AND COMMENTS**

---

The development of two separate solar photovoltaic (PV) facilities, each with a contracted capacity of up to 125MW, and associated grid connection is proposed on a site located approximately 11km south-east of the town of Aggeneys in the Northern Cape Province. The two solar PV facilities are to be known as Geelstert 1 and Geelstert 2. The grid connection solution will be known as Geelstert Grid Connection. The projects are situated within the Khâi-Ma Local Municipality, in the greater Namakwa District Municipality.

The two solar PV facilities are located on the Remaining Extent of the Farm Bloemhoek 61 and will be connected to the Aggeneis Main Transmission Substation (MTS). The grid connection will include a collector substation and a double-circuit power line of up to 220kV. The grid connection will traverse six (6) properties which include:

Remaining Extent of the Farm Bloemhoek 61	Remaining Extent of the Farm Aggeneys 56
Remaining Extent of Portion 1 of the Farm Aggeneys 56	Portion 2 of the Farm Aggeneys 56
Portion 12 of the Farm Aggeneys 56	Portion 13 of the Farm Aggeneys 56

It is the Developer's intention to bid each solar PV facility under the Department of Mineral Resources and Energy's<sup>1</sup> Renewable Energy Independent Power Producer Procurement (REIPPP) Programme. The power generated from each solar PV facility will be sold to Eskom and fed into the national electricity grid through the proposed grid connection. The development of the solar PV facilities and the grid connection will assist with the achievement of the electricity goals as set out in the Integrated Resources Plan (IRP), 2019.

<sup>1</sup> The Department of Mineral Resources and Energy is a merge between the Department of Mineral Resources (DMR) and the Department of Energy (DoE).

The study area is located within Zone 8 of the Renewable Energy Development Zones (REDZ) (also known as the Springbok REDZ).

The applicant for each of the solar PV facilities will be a separate Special Purpose Vehicles (SPV). The applicant for Geelstert 1 is Geelstert Solar Facility 1 (Pty) Ltd, and the applicant for Geelstert 2 is Geelstert Solar Facility 2 (Pty) Ltd. The applicant for the Geelstert Grid Connection is ABO Wind renewable energies (Pty) Ltd. Three (3) separate Applications for Environmental Authorisation have been submitted to the Department of Environmental Affairs (DEA).

The notification of the development of two 125MW solar photovoltaic (PV) facilities and the associated grid connection distributed on 13 July 2020, has reference. The notification letter was accompanied by the Background Information Document (BID) which provided information regarding these Basic Assessment (BA) processes. If you have not received these documents, please inform us accordingly or we encourage you to visit our online stakeholder engagement platform at [www.savannahsa.com/public-documents/energy-generation/geelstert-1-and-geelstert-2-solar-pv-facilities-and-associated-grid-connection/](http://www.savannahsa.com/public-documents/energy-generation/geelstert-1-and-geelstert-2-solar-pv-facilities-and-associated-grid-connection/) the public documents for these three (3) projects are available for your perusal.

#### **AVAILABILITY OF BASIC ASSESSMENT REPORTS FOR REVIEW AND COMMENT**

In terms of Regulation 43(2) of the EIA Regulations, 2014, as amended, this letter serves to inform you that the Basic Assessment Reports (BARs) are available for review and written comments. The BARs' review and comment period is from **Thursday, 20 August 2020 until Monday, 21 September 2020**.

<b>Applicant name</b>	<b>Project/BA Report</b>
Geelstert Solar Facility 1 (Pty) Ltd	Geelstert 1
Geelstert Solar Facility 2 (Pty) Ltd	Geelstert 2
ABO Wind renewable energies (Pty) Ltd	Geelstert Grid Connection

The reports are available for downloading from our public participation platform at [www.savannahsa.com/public-documents/energy-generation/geelstert-1-and-geelstert-2-solar-pv-facilities-and-associated-grid-connection/](http://www.savannahsa.com/public-documents/energy-generation/geelstert-1-and-geelstert-2-solar-pv-facilities-and-associated-grid-connection/)

The restrictions enforced in terms of Government Gazette 43096 which placed the country in a national state of disaster limiting the movement and gathering of people to curb the spread of the COVID-19 virus has placed some limitations on making hard copies of the BARs available at public places such as libraries and municipal offices. As per our approved public participation plan submitted to the Department of Environmental Affairs (DEA), you can also request that an electronic copy of the BARs be sent to you via file transfer services such as WeTransfer or Dropbox.

Please submit your written comments on the BARs by **Monday, 21 September 2020** via our public participation portal (link provided above) or:

- » Telephone: 011 656 3237
- » Mobile: 060 978 8396
- » Fax: 086 684 0547
- » Post: PO Box 148, Sunninghill, 2157
- » E-mail: [publicprocess@savannahsa.com](mailto:publicprocess@savannahsa.com)

All comments can be addressed to Ronald Baloyi of Savannah Environmental.

All comments received during the 30-day review and comment period will be recorded and included in the Final BARs for submission to the DEA in line with Regulation 44 of the EIA Regulations, 2014, as amended (GN R326).

Please do not hesitate to contact us should you require additional information and/or clarification regarding the project. Our team welcomes your participation and look forward to your involvement throughout this process.

Kind regards

A handwritten signature in black ink, appearing to read "Nicolene Venter". The signature is fluid and cursive, with the first name being more prominent.

**Nicolene Venter**

Public Participation and Social Consultant

Email: [publicprocess@savannahsa.com](mailto:publicprocess@savannahsa.com)

Timothy, Ratha Andrew - Ngwao-Boswa Ya Kapa Bokone (N Cape Prov Heritage Resource Authority)

Date: 8/19/2020  
Time: 5:58 PM  
Creator: Ronald Baloyi Baloyi

Note

---

Subject: GEELSTERT 1 & 2 and GRID CONNECTION: Notification of the Availability of the Basic Assessment for review and comment

Body:

GEELSTERT 1 AND GEELSTERT 2 SOLAR PV FACILITIES AND GEELSTERT GRID CONNECTION NEAR AGGENEYS, NORTHERN CAPE PROVINCE

Dear Mr Ratha,

The development of two separate solar photovoltaic (PV) facilities, each with a contracted capacity of up to 125MW, and associated grid connection is proposed on a site located approximately 11km south-east of the town of Aggeneys in the Northern Cape Province. The two solar PV facilities are to be known as Geelstert 1 and Geelstert 2. The grid connection solution will be known as Geelstert Grid Connection. The projects are situated within the Khâi-Ma Local Municipality, in the greater Namakwa District Municipality.

As a registered Interested and Affected Party (I&AP), you are hereby notified that the following three Basic Assessment Reports (BARs) are available for your review and comment from Thursday, 20 August 2020 until Monday, 21 September 2020. The reports are available for download from our website / stakeholder engagement platform on the above-mentioned link.

The restrictions enforced in terms of the Government Gazette 43096 which placed the country in a national state of disaster limiting the movement and gathering of people to curb the spread of the COVID-19 virus has placed some limitations on making hard copies of the BARs at the public places such as Libraries. We invite you to visit our online stakeholder engagement platform at <https://www.savannahsa.com/public-documents/energy-generation/geelstert-1-and-geelstert-2-solar-pv-facilities-and-associated-grid-connection/>

Should you not be able to access our online stakeholder engagement platform to download the BARs, please refer to the attached letter for alternative means to obtain the BARs. The attached letter also provides further details regarding the availability of the BARs.

Kind regards,

--

An email has been sent to "Ratha Timothy" [REDACTED] [nicolene@savannahsa.com](mailto:nicolene@savannahsa.com); [ronald@savannahsa.com](mailto:ronald@savannahsa.com); "Ronald Baloyi Baloyi" <[publicprocess@savannahsa.com](mailto:publicprocess@savannahsa.com)>

Please refer to the email saved in the Documents window.

19 August 2020

Mr Jaco Roelofse  
Director: Roads  
Northern Cape Department of Roads and Public Works

E-mail: [REDACTED]

Dear Mr Roelofse,

## **GEELSTERT 1 AND GEELSTERT 2 SOLAR PV FACILITIES AND GEELSTERT GRID CONNECTION NEAR AGGENEYS, NORTHERN CAPE PROVINCE**

---

### **NOTICE OF AVAILABILITY OF BASIC ASSESSMENT REPORTS FOR REVIEW AND COMMENTS**

---

The development of two separate solar photovoltaic (PV) facilities, each with a contracted capacity of up to 125MW, and associated grid connection is proposed on a site located approximately 11km south-east of the town of Aggeneys in the Northern Cape Province. The two solar PV facilities are to be known as Geelstert 1 and Geelstert 2. The grid connection solution will be known as Geelstert Grid Connection. The projects are situated within the Khâi-Ma Local Municipality, in the greater Namakwa District Municipality.

The two solar PV facilities are located on the Remaining Extent of the Farm Bloemhoek 61 and will be connected to the Aggeneys Main Transmission Substation (MTS). The grid connection will include a collector substation and a double-circuit power line of up to 220kV. The grid connection will traverse six (6) properties which include:

Remaining Extent of the Farm Bloemhoek 61	Remaining Extent of the Farm Aggeneys 56
Remaining Extent of Portion 1 of the Farm Aggeneys 56	Portion 2 of the Farm Aggeneys 56
Portion 12 of the Farm Aggeneys 56	Portion 13 of the Farm Aggeneys 56

It is the Developer's intention to bid each solar PV facility under the Department of Mineral Resources and Energy's<sup>1</sup> Renewable Energy Independent Power Producer Procurement (REIPPP) Programme. The power generated from each solar PV facility will be sold to Eskom and fed into the national electricity grid through the proposed grid connection. The development of the solar PV facilities and the grid connection will assist with the achievement of the electricity goals as set out in the Integrated Resources Plan (IRP), 2019.

<sup>1</sup> The Department of Mineral Resources and Energy is a merge between the Department of Mineral Resources (DMR) and the Department of Energy (DoE).

The study area is located within Zone 8 of the Renewable Energy Development Zones (REDZ) (also known as the Springbok REDZ).

The applicant for each of the solar PV facilities will be a separate Special Purpose Vehicles (SPV). The applicant for Geelstert 1 is Geelstert Solar Facility 1 (Pty) Ltd, and the applicant for Geelstert 2 is Geelstert Solar Facility 2 (Pty) Ltd. The applicant for the Geelstert Grid Connection is ABO Wind renewable energies (Pty) Ltd. Three (3) separate Applications for Environmental Authorisation have been submitted to the Department of Environmental Affairs (DEA).

The notification of the development of two 125MW solar photovoltaic (PV) facilities and the associated grid connection distributed on 13 July 2020, has reference. The notification letter was accompanied by the Background Information Document (BID) which provided information regarding these Basic Assessment (BA) processes. If you have not received these documents, please inform us accordingly or we encourage you to visit our online stakeholder engagement platform at [www.savannahsa.com/public-documents/energy-generation/geelstert-1-and-geelstert-2-solar-pv-facilities-and-associated-grid-connection/](http://www.savannahsa.com/public-documents/energy-generation/geelstert-1-and-geelstert-2-solar-pv-facilities-and-associated-grid-connection/) the public documents for these three (3) projects are available for your perusal.

#### **AVAILABILITY OF BASIC ASSESSMENT REPORTS FOR REVIEW AND COMMENT**

In terms of Regulation 43(2) of the EIA Regulations, 2014, as amended, this letter serves to inform you that the Basic Assessment Reports (BARs) are available for review and written comments. The BARs' review and comment period is from **Thursday, 20 August 2020 until Monday, 21 September 2020**.

<b>Applicant name</b>	<b>Project/BA Report</b>
Geelstert Solar Facility 1 (Pty) Ltd	Geelstert 1
Geelstert Solar Facility 2 (Pty) Ltd	Geelstert 2
ABO Wind renewable energies (Pty) Ltd	Geelstert Grid Connection

The reports are available for downloading from our public participation platform at [www.savannahsa.com/public-documents/energy-generation/geelstert-1-and-geelstert-2-solar-pv-facilities-and-associated-grid-connection/](http://www.savannahsa.com/public-documents/energy-generation/geelstert-1-and-geelstert-2-solar-pv-facilities-and-associated-grid-connection/)

The restrictions enforced in terms of Government Gazette 43096 which placed the country in a national state of disaster limiting the movement and gathering of people to curb the spread of the COVID-19 virus has placed some limitations on making hard copies of the BARs available at public places such as libraries and municipal offices. As per our approved public participation plan submitted to the Department of Environmental Affairs (DEA), you can also request that an electronic copy of the BARs be sent to you via file transfer services such as WeTransfer or Dropbox.

Please submit your written comments on the BARs by **Monday, 21 September 2020** via our public participation portal (link provided above) or:

- » Telephone: 011 656 3237
- » Mobile: 060 978 8396
- » Fax: 086 684 0547
- » Post: PO Box 148, Sunninghill, 2157
- » E-mail: [publicprocess@savannahsa.com](mailto:publicprocess@savannahsa.com)

All comments can be addressed to Ronald Baloyi of Savannah Environmental.

All comments received during the 30-day review and comment period will be recorded and included in the Final BARs for submission to the DEA in line with Regulation 44 of the EIA Regulations, 2014, as amended (GN R326).

Please do not hesitate to contact us should you require additional information and/or clarification regarding the project. Our team welcomes your participation and look forward to your involvement throughout this process.

Kind regards

A handwritten signature in black ink, appearing to read "Nicolene Venter". The signature is written in a cursive, flowing style.

**Nicolene Venter**

Public Participation and Social Consultant

Email: [publicprocess@savannahsa.com](mailto:publicprocess@savannahsa.com)

**Roelofse, Jaco - Northern Cape Department of Roads and Public Works**

Date: 8/19/2020  
Time: 6:00 PM  
Creator: Ronald Baloyi Baloyi

## Note

Subject: GEELSTERT 1 & 2 and GRID CONNECTION: Notification of the Availability of the Basic Assessment for review and comment

Body:

**GEELSTERT 1 AND GEELSTERT 2 SOLAR PV FACILITIES AND GEELSTERT GRID CONNECTION  
NEAR AGGENEYS, NORTHERN CAPE PROVINCE**

Dear Mr Roelofse,

The development of two separate solar photovoltaic (PV) facilities, each with a contracted capacity of up to 125MW, and associated grid connection is proposed on a site located approximately 11km south-east of the town of Aggeneys in the Northern Cape Province. The two solar PV facilities are to be known as Geelstert 1 and Geelstert 2. The grid connection solution will be known as Geelstert Grid Connection. The projects are situated within the Khâi-Ma Local Municipality, in the greater Namakwa District Municipality.

As a registered Interested and Affected Party (I&AP), you are hereby notified that the following three Basic Assessment Reports (BARs) are available for your review and comment from Thursday, 20 August 2020 until Monday, 21 September 2020. The reports are available for download from our website / stakeholder engagement platform on the above-mentioned link.

The restrictions enforced in terms of the Government Gazette 43096 which placed the country in a national state of disaster limiting the movement and gathering of people to curb the spread of the COVID-19 virus has placed some limitations on making hard copies of the BARs at the public places such as Libraries. We invite you to visit our online stakeholder engagement platform at <https://www.savannahsa.com/public-documents/energy-generation/geelstert-1-and-geelstert-2-solar-pv-facilities-and-associated-grid-connection/>

Should you not be able to access our online stakeholder engagement platform to download the BARs, please refer to the attached letter for alternative means to obtain the BARs. The attached letter also provides further details regarding the availability of the BARs.

Kind regards,

--

An email has been sent to "Jaco Roelofse" [REDACTED]  
nicolene@savannahsa.com;ronald@savannahsa.com;"Ronald Baloyi Baloyi" <publicprocess@savannahsa.com>

Please refer to the email saved in the Documents window.



19 August 2020

Mrs Lizell Ströh  
Obstacle Specialist: Aviation Obstacle and GIS  
South Africa Civil Aviation Authority

E-mail: [REDACTED]

Dear Mrs Ströh,

## **GEELSTERT 1 AND GEELSTERT 2 SOLAR PV FACILITIES AND GEELSTERT GRID CONNECTION NEAR AGGENEYS, NORTHERN CAPE PROVINCE**

---

### **NOTICE OF AVAILABILITY OF BASIC ASSESSMENT REPORTS FOR REVIEW AND COMMENTS**

---

The development of two separate solar photovoltaic (PV) facilities, each with a contracted capacity of up to 125MW, and associated grid connection is proposed on a site located approximately 11km south-east of the town of Aggeneys in the Northern Cape Province. The two solar PV facilities are to be known as Geelstert 1 and Geelstert 2. The grid connection solution will be known as Geelstert Grid Connection. The projects are situated within the Khâi-Ma Local Municipality, in the greater Namakwa District Municipality.

The two solar PV facilities are located on the Remaining Extent of the Farm Bloemhoek 61 and will be connected to the Aggeneys Main Transmission Substation (MTS). The grid connection will include a collector substation and a double-circuit power line of up to 220kV. The grid connection will traverse six (6) properties which include:

Remaining Extent of the Farm Bloemhoek 61	Remaining Extent of the Farm Aggeneys 56
Remaining Extent of Portion 1 of the Farm Aggeneys 56	Portion 2 of the Farm Aggeneys 56
Portion 12 of the Farm Aggeneys 56	Portion 13 of the Farm Aggeneys 56

It is the Developer's intention to bid each solar PV facility under the Department of Mineral Resources and Energy's<sup>1</sup> Renewable Energy Independent Power Producer Procurement (REIPPP) Programme. The power generated from each solar PV facility will be sold to Eskom and fed into the national electricity grid through the proposed grid connection. The development of the solar PV facilities and the grid connection will assist with the achievement of the electricity goals as set out in the Integrated Resources Plan (IRP), 2019.

<sup>1</sup> The Department of Mineral Resources and Energy is a merge between the Department of Mineral Resources (DMR) and the Department of Energy (DoE).

The study area is located within Zone 8 of the Renewable Energy Development Zones (REDZ) (also known as the Springbok REDZ).

The applicant for each of the solar PV facilities will be a separate Special Purpose Vehicles (SPV). The applicant for Geelstert 1 is Geelstert Solar Facility 1 (Pty) Ltd, and the applicant for Geelstert 2 is Geelstert Solar Facility 2 (Pty) Ltd. The applicant for the Geelstert Grid Connection is ABO Wind renewable energies (Pty) Ltd. Three (3) separate Applications for Environmental Authorisation have been submitted to the Department of Environmental Affairs (DEA).

The notification of the development of two 125MW solar photovoltaic (PV) facilities and the associated grid connection distributed on 13 July 2020, has reference. The notification letter was accompanied by the Background Information Document (BID) which provided information regarding these Basic Assessment (BA) processes. If you have not received these documents, please inform us accordingly or we encourage you to visit our online stakeholder engagement platform at [www.savannahsa.com/public-documents/energy-generation/geelstert-1-and-geelstert-2-solar-pv-facilities-and-associated-grid-connection/](http://www.savannahsa.com/public-documents/energy-generation/geelstert-1-and-geelstert-2-solar-pv-facilities-and-associated-grid-connection/) the public documents for these three (3) projects are available for your perusal.

#### **AVAILABILITY OF BASIC ASSESSMENT REPORTS FOR REVIEW AND COMMENT**

In terms of Regulation 43(2) of the EIA Regulations, 2014, as amended, this letter serves to inform you that the Basic Assessment Reports (BARs) are available for review and written comments. The BARs' review and comment period is from **Thursday, 20 August 2020 until Monday, 21 September 2020**.

<b>Applicant name</b>	<b>Project/BA Report</b>
Geelstert Solar Facility 1 (Pty) Ltd	Geelstert 1
Geelstert Solar Facility 2 (Pty) Ltd	Geelstert 2
ABO Wind renewable energies (Pty) Ltd	Geelstert Grid Connection

The reports are available for downloading from our public participation platform at [www.savannahsa.com/public-documents/energy-generation/geelstert-1-and-geelstert-2-solar-pv-facilities-and-associated-grid-connection/](http://www.savannahsa.com/public-documents/energy-generation/geelstert-1-and-geelstert-2-solar-pv-facilities-and-associated-grid-connection/)

The restrictions enforced in terms of Government Gazette 43096 which placed the country in a national state of disaster limiting the movement and gathering of people to curb the spread of the COVID-19 virus has placed some limitations on making hard copies of the BARs available at public places such as libraries and municipal offices. As per our approved public participation plan submitted to the Department of Environmental Affairs (DEA), you can also request that an electronic copy of the BARs be sent to you via file transfer services such as WeTransfer or Dropbox.

Please submit your written comments on the BARs by **Monday, 21 September 2020** via our public participation portal (link provided above) or:

- » Telephone: 011 656 3237
- » Mobile: 060 978 8396
- » Fax: 086 684 0547
- » Post: PO Box 148, Sunninghill, 2157
- » E-mail: [publicprocess@savannahsa.com](mailto:publicprocess@savannahsa.com)

All comments can be addressed to Ronald Baloyi of Savannah Environmental.

All comments received during the 30-day review and comment period will be recorded and included in the Final BARs for submission to the DEA in line with Regulation 44 of the EIA Regulations, 2014, as amended (GN R326).

Please do not hesitate to contact us should you require additional information and/or clarification regarding the project. Our team welcomes your participation and look forward to your involvement throughout this process.

Kind regards

A handwritten signature in black ink, appearing to read 'Nicolene Venter', written in a cursive style.

**Nicolene Venter**

Public Participation and Social Consultant

Email: [publicprocess@savannahsa.com](mailto:publicprocess@savannahsa.com)

**Stroh, Lizell - South African Civil Aviation Authority**



Date: 8/19/2020  
Time: 6:02 PM  
Creator: Ronald Baloyi Baloyi

Note

---

Subject: GEELSTERT 1 & 2 and GRID CONNECTION: Notification of the Availability of the Basic Assessment for review and comment

Body:

**GEELSTERT 1 AND GEELSTERT 2 SOLAR PV FACILITIES AND GEELSTERT GRID CONNECTION NEAR AGGENEYS, NORTHERN CAPE PROVINCE**

Dear Mrs Stroh,

The development of two separate solar photovoltaic (PV) facilities, each with a contracted capacity of up to 125MW, and associated grid connection is proposed on a site located approximately 11km south-east of the town of Aggeneys in the Northern Cape Province. The two solar PV facilities are to be known as Geelstert 1 and Geelstert 2. The grid connection solution will be known as Geelstert Grid Connection. The projects are situated within the Khâi-Ma Local Municipality, in the greater Namakwa District Municipality.

As a registered Interested and Affected Party (I&AP), you are hereby notified that the following three Basic Assessment Reports (BARs) are available for your review and comment from Thursday, 20 August 2020 until Monday, 21 September 2020. The reports are available for download from our website / stakeholder engagement platform on the above-mentioned link.

The restrictions enforced in terms of the Government Gazette 43096 which placed the country in a national state of disaster limiting the movement and gathering of people to curb the spread of the COVID-19 virus has placed some limitations on making hard copies of the BARs at the public places such as Libraries. We invite you to visit our online stakeholder engagement platform at <https://www.savannahsa.com/public-documents/energy-generation/geelstert-1-and-geelstert-2-solar-pv-facilities-and-associated-grid-connection/>

Should you not be able to access our online stakeholder engagement platform to download the BARs, please refer to the attached letter for alternative means to obtain the BARs. The attached letter also provides further details regarding the availability of the BARs.

Kind regards,

--

An email has been sent to "Lizell Stroh"  nicolene@savannahsa.com;ronald@savannahsa.com;"Ronald Baloyi Baloyi" <publicprocess@savannahsa.com>

Please refer to the email saved in the Documents window.

19 August 2020

Lieutenant Colonel Zondi  
South African National Defence Force

E-mail: [REDACTED]

Dear Lt Cl Zondi,

## **GEELSTERT 1 AND GEELSTERT 2 SOLAR PV FACILITIES AND GEELSTERT GRID CONNECTION NEAR AGGENEYS, NORTHERN CAPE PROVINCE**

---

### **NOTICE OF AVAILABILITY OF BASIC ASSESSMENT REPORTS FOR REVIEW AND COMMENTS**

---

The development of two separate solar photovoltaic (PV) facilities, each with a contracted capacity of up to 125MW, and associated grid connection is proposed on a site located approximately 11km south-east of the town of Aggeneys in the Northern Cape Province. The two solar PV facilities are to be known as Geelstert 1 and Geelstert 2. The grid connection solution will be known as Geelstert Grid Connection. The projects are situated within the Khâi-Ma Local Municipality, in the greater Namakwa District Municipality.

The two solar PV facilities are located on the Remaining Extent of the Farm Bloemhoek 61 and will be connected to the Aggeneys Main Transmission Substation (MTS). The grid connection will include a collector substation and a double-circuit power line of up to 220kV. The grid connection will traverse six (6) properties which include:

Remaining Extent of the Farm Bloemhoek 61	Remaining Extent of the Farm Aggeneys 56
Remaining Extent of Portion 1 of the Farm Aggeneys 56	Portion 2 of the Farm Aggeneys 56
Portion 12 of the Farm Aggeneys 56	Portion 13 of the Farm Aggeneys 56

It is the Developer's intention to bid each solar PV facility under the Department of Mineral Resources and Energy's<sup>1</sup> Renewable Energy Independent Power Producer Procurement (REIPPP) Programme. The power generated from each solar PV facility will be sold to Eskom and fed into the national electricity grid through the proposed grid connection. The development of the solar PV facilities and the grid connection will assist with the achievement of the electricity goals as set out in the Integrated Resources Plan (IRP), 2019.

<sup>1</sup> The Department of Mineral Resources and Energy is a merge between the Department of Mineral Resources (DMR) and the Department of Energy (DoE).

The study area is located within Zone 8 of the Renewable Energy Development Zones (REDZ) (also known as the Springbok REDZ).

The applicant for each of the solar PV facilities will be a separate Special Purpose Vehicles (SPV). The applicant for Geelstert 1 is Geelstert Solar Facility 1 (Pty) Ltd, and the applicant for Geelstert 2 is Geelstert Solar Facility 2 (Pty) Ltd. The applicant for the Geelstert Grid Connection is ABO Wind renewable energies (Pty) Ltd. Three (3) separate Applications for Environmental Authorisation have been submitted to the Department of Environmental Affairs (DEA).

The notification of the development of two 125MW solar photovoltaic (PV) facilities and the associated grid connection distributed on 13 July 2020, has reference. The notification letter was accompanied by the Background Information Document (BID) which provided information regarding these Basic Assessment (BA) processes. If you have not received these documents, please inform us accordingly or we encourage you to visit our online stakeholder engagement platform at [www.savannahsa.com/public-documents/energy-generation/geelstert-1-and-geelstert-2-solar-pv-facilities-and-associated-grid-connection/](http://www.savannahsa.com/public-documents/energy-generation/geelstert-1-and-geelstert-2-solar-pv-facilities-and-associated-grid-connection/) the public documents for these three (3) projects are available for your perusal.

#### **AVAILABILITY OF BASIC ASSESSMENT REPORTS FOR REVIEW AND COMMENT**

In terms of Regulation 43(2) of the EIA Regulations, 2014, as amended, this letter serves to inform you that the Basic Assessment Reports (BARs) are available for review and written comments. The BARs' review and comment period is from **Thursday, 20 August 2020 until Monday, 21 September 2020**.

<b>Applicant name</b>	<b>Project/BA Report</b>
Geelstert Solar Facility 1 (Pty) Ltd	Geelstert 1
Geelstert Solar Facility 2 (Pty) Ltd	Geelstert 2
ABO Wind renewable energies (Pty) Ltd	Geelstert Grid Connection

The reports are available for downloading from our public participation platform at [www.savannahsa.com/public-documents/energy-generation/geelstert-1-and-geelstert-2-solar-pv-facilities-and-associated-grid-connection/](http://www.savannahsa.com/public-documents/energy-generation/geelstert-1-and-geelstert-2-solar-pv-facilities-and-associated-grid-connection/)

The restrictions enforced in terms of Government Gazette 43096 which placed the country in a national state of disaster limiting the movement and gathering of people to curb the spread of the COVID-19 virus has placed some limitations on making hard copies of the BARs available at public places such as libraries and municipal offices. As per our approved public participation plan submitted to the Department of Environmental Affairs (DEA), you can also request that an electronic copy of the BARs be sent to you via file transfer services such as WeTransfer or Dropbox.

Please submit your written comments on the BARs by **Monday, 21 September 2020** via our public participation portal (link provided above) or:

- » Telephone: 011 656 3237
- » Mobile: 060 978 8396
- » Fax: 086 684 0547
- » Post: PO Box 148, Sunninghill, 2157
- » E-mail: [publicprocess@savannahsa.com](mailto:publicprocess@savannahsa.com)

All comments can be addressed to Ronald Baloyi of Savannah Environmental.

All comments received during the 30-day review and comment period will be recorded and included in the Final BARs for submission to the DEA in line with Regulation 44 of the EIA Regulations, 2014, as amended (GN R326).

Please do not hesitate to contact us should you require additional information and/or clarification regarding the project. Our team welcomes your participation and look forward to your involvement throughout this process.

Kind regards

A handwritten signature in black ink, appearing to read "Nicolene Venter". The signature is written in a cursive, flowing style.

**Nicolene Venter**

Public Participation and Social Consultant

Email: [publicprocess@savannahsa.com](mailto:publicprocess@savannahsa.com)

**Zondi, Kebasenosi - South African National Defense Force**

Date: 8/19/2020  
Time: 6:39 PM  
Creator: Ronald Baloyi Baloyi

## Note

Subject: GEELSTERT 1 & 2 and GRID CONNECTION: Notification of the Availability of the Basic Assessment for review and comment

## Body:

**GEELSTERT 1 AND GEELSTERT 2 SOLAR PV FACILITIES AND GEELSTERT GRID CONNECTION NEAR AGGENEYS, NORTHERN CAPE PROVINCE**

Dear Lt Cl Zondi,

The development of two separate solar photovoltaic (PV) facilities, each with a contracted capacity of up to 125MW, and associated grid connection is proposed on a site located approximately 11km south-east of the town of Aggeneys in the Northern Cape Province. The two solar PV facilities are to be known as Geelstert 1 and Geelstert 2. The grid connection solution will be known as Geelstert Grid Connection. The projects are situated within the Khâi-Ma Local Municipality, in the greater Namakwa District Municipality.

As a registered Interested and Affected Party (I&AP), you are hereby notified that the following three Basic Assessment Reports (BARs) are available for your review and comment from Thursday, 20 August 2020 until Monday, 21 September 2020. The reports are available for download from our website / stakeholder engagement platform on the above-mentioned link.

The restrictions enforced in terms of the Government Gazette 43096 which placed the country in a national state of disaster limiting the movement and gathering of people to curb the spread of the COVID-19 virus has placed some limitations on making hard copies of the BARs at the public places such as Libraries. We invite you to visit our online stakeholder engagement platform at <https://www.savannahsa.com/public-documents/energy-generation/geelstert-1-and-geelstert-2-solar-pv-facilities-and-associated-grid-connection/>

Should you not be able to access our online stakeholder engagement platform to download the BARs, please refer to the attached letter for alternative means to obtain the BARs. The attached letter also provides further details regarding the availability of the BARs.

Kind regards,

--

An email has been sent to "Kebasenosi Zondi" [REDACTED] nicolene@savannahsa.com;ronald@savannahsa.com;"Ronald Baloyi Baloyi" <publicprocess@savannahsa.com>

Please refer to the email saved in the Documents window.



19 August 2020

Ms Nicole Abrahams  
Environmental Coordinator: Western Region  
South African National Roads Agency

E-mail: [REDACTED]

Dear Ms Abrahams,

## **GEELSTERT 1 AND GEELSTERT 2 SOLAR PV FACILITIES AND GEELSTERT GRID CONNECTION NEAR AGGENEYS, NORTHERN CAPE PROVINCE**

---

### **NOTICE OF AVAILABILITY OF BASIC ASSESSMENT REPORTS FOR REVIEW AND COMMENTS**

---

The development of two separate solar photovoltaic (PV) facilities, each with a contracted capacity of up to 125MW, and associated grid connection is proposed on a site located approximately 11km south-east of the town of Aggeneys in the Northern Cape Province. The two solar PV facilities are to be known as Geelstert 1 and Geelstert 2. The grid connection solution will be known as Geelstert Grid Connection. The projects are situated within the Khâi-Ma Local Municipality, in the greater Namakwa District Municipality.

The two solar PV facilities are located on the Remaining Extent of the Farm Bloemhoek 61 and will be connected to the Aggeneys Main Transmission Substation (MTS). The grid connection will include a collector substation and a double-circuit power line of up to 220kV. The grid connection will traverse six (6) properties which include:

Remaining Extent of the Farm Bloemhoek 61	Remaining Extent of the Farm Aggeneys 56
Remaining Extent of Portion 1 of the Farm Aggeneys 56	Portion 2 of the Farm Aggeneys 56
Portion 12 of the Farm Aggeneys 56	Portion 13 of the Farm Aggeneys 56

It is the Developer's intention to bid each solar PV facility under the Department of Mineral Resources and Energy's<sup>1</sup> Renewable Energy Independent Power Producer Procurement (REIPPP) Programme. The power generated from each solar PV facility will be sold to Eskom and fed into the national electricity grid through the proposed grid connection. The development of the solar PV facilities and the grid connection will assist with the achievement of the electricity goals as set out in the Integrated Resources Plan (IRP), 2019.

<sup>1</sup> The Department of Mineral Resources and Energy is a merge between the Department of Mineral Resources (DMR) and the Department of Energy (DoE).

The study area is located within Zone 8 of the Renewable Energy Development Zones (REDZ) (also known as the Springbok REDZ).

The applicant for each of the solar PV facilities will be a separate Special Purpose Vehicles (SPV). The applicant for Geelstert 1 is Geelstert Solar Facility 1 (Pty) Ltd, and the applicant for Geelstert 2 is Geelstert Solar Facility 2 (Pty) Ltd. The applicant for the Geelstert Grid Connection is ABO Wind renewable energies (Pty) Ltd. Three (3) separate Applications for Environmental Authorisation have been submitted to the Department of Environmental Affairs (DEA).

The notification of the development of two 125MW solar photovoltaic (PV) facilities and the associated grid connection distributed on 13 July 2020, has reference. The notification letter was accompanied by the Background Information Document (BID) which provided information regarding these Basic Assessment (BA) processes. If you have not received these documents, please inform us accordingly or we encourage you to visit our online stakeholder engagement platform at [www.savannahsa.com/public-documents/energy-generation/geelstert-1-and-geelstert-2-solar-pv-facilities-and-associated-grid-connection/](http://www.savannahsa.com/public-documents/energy-generation/geelstert-1-and-geelstert-2-solar-pv-facilities-and-associated-grid-connection/) the public documents for these three (3) projects are available for your perusal.

#### **AVAILABILITY OF BASIC ASSESSMENT REPORTS FOR REVIEW AND COMMENT**

In terms of Regulation 43(2) of the EIA Regulations, 2014, as amended, this letter serves to inform you that the Basic Assessment Reports (BARs) are available for review and written comments. The BARs' review and comment period is from **Thursday, 20 August 2020 until Monday, 21 September 2020**.

<b>Applicant name</b>	<b>Project/BA Report</b>
Geelstert Solar Facility 1 (Pty) Ltd	Geelstert 1
Geelstert Solar Facility 2 (Pty) Ltd	Geelstert 2
ABO Wind renewable energies (Pty) Ltd	Geelstert Grid Connection

The reports are available for downloading from our public participation platform at [www.savannahsa.com/public-documents/energy-generation/geelstert-1-and-geelstert-2-solar-pv-facilities-and-associated-grid-connection/](http://www.savannahsa.com/public-documents/energy-generation/geelstert-1-and-geelstert-2-solar-pv-facilities-and-associated-grid-connection/)

The restrictions enforced in terms of Government Gazette 43096 which placed the country in a national state of disaster limiting the movement and gathering of people to curb the spread of the COVID-19 virus has placed some limitations on making hard copies of the BARs available at public places such as libraries and municipal offices. As per our approved public participation plan submitted to the Department of Environmental Affairs (DEA), you can also request that an electronic copy of the BARs be sent to you via file transfer services such as WeTransfer or Dropbox.

Please submit your written comments on the BARs by **Monday, 21 September 2020** via our public participation portal (link provided above) or:

- » Telephone: 011 656 3237
- » Mobile: 060 978 8396
- » Fax: 086 684 0547
- » Post: PO Box 148, Sunninghill, 2157
- » E-mail: [publicprocess@savannahsa.com](mailto:publicprocess@savannahsa.com)

All comments can be addressed to Ronald Baloyi of Savannah Environmental.

All comments received during the 30-day review and comment period will be recorded and included in the Final BARs for submission to the DEA in line with Regulation 44 of the EIA Regulations, 2014, as amended (GN R326).

Please do not hesitate to contact us should you require additional information and/or clarification regarding the project. Our team welcomes your participation and look forward to your involvement throughout this process.

Kind regards

A handwritten signature in black ink, appearing to read 'Nicolene Venter'.

**Nicolene Venter**

Public Participation and Social Consultant

Email: [publicprocess@savannahsa.com](mailto:publicprocess@savannahsa.com)

Abrahams, Nicole - South African National Roads Agency Limited

Date: 8/19/2020  
Time: 6:04 PM  
Creator: Ronald Baloyi Baloyi

Note

Subject: GEELSTERT 1 & 2 and GRID CONNECTION: Notification of the Availability of the Basic Assessment for review and comment

Body:

**GEELSTERT 1 AND GEELSTERT 2 SOLAR PV FACILITIES AND GEELSTERT GRID CONNECTION NEAR AGGENEYS, NORTHERN CAPE PROVINCE**

Dear Ms Abrahams,

The development of two separate solar photovoltaic (PV) facilities, each with a contracted capacity of up to 125MW, and associated grid connection is proposed on a site located approximately 11km south-east of the town of Aggeneys in the Northern Cape Province. The two solar PV facilities are to be known as Geelstert 1 and Geelstert 2. The grid connection solution will be known as Geelstert Grid Connection. The projects are situated within the Khâi-Ma Local Municipality, in the greater Namakwa District Municipality.

As a registered Interested and Affected Party (I&AP), you are hereby notified that the following three Basic Assessment Reports (BARs) are available for your review and comment from Thursday, 20 August 2020 until Monday, 21 September 2020. The reports are available for download from our website / stakeholder engagement platform on the above-mentioned link.

The restrictions enforced in terms of the Government Gazette 43096 which placed the country in a national state of disaster limiting the movement and gathering of people to curb the spread of the COVID-19 virus has placed some limitations on making hard copies of the BARs at the public places such as Libraries. We invite you to visit our online stakeholder engagement platform at <https://www.savannahsa.com/public-documents/energy-generation/geelstert-1-and-geelstert-2-solar-pv-facilities-and-associated-grid-connection/>

Should you not be able to access our online stakeholder engagement platform to download the BARs, please refer to the attached letter for alternative means to obtain the BARs. The attached letter also provides further details regarding the availability of the BARs.

Kind regards,

--

An email has been sent to "Nicole Abrahams" [REDACTED] nicolene@savannahsa.com;ronald@savannahsa.com;"Ronald Baloyi Baloyi" <publicprocess@savannahsa.com>

Please refer to the email saved in the Documents window.

19 August 2020

Dr Adriaan Tiplady  
Manager: Site Categorisation  
South African Radio Astronomy Observatory

and

Mr Busang Sethole  
Analyst: Spectrum and Telecoms  
South African Radio Astronomy Observatory

E-mail: [REDACTED]

Dear Dr Tiplady and Mr Sethole,

## **GEELSTERT 1 AND GEELSTERT 2 SOLAR PV FACILITIES AND GEELSTERT GRID CONNECTION NEAR AGGENEYS, NORTHERN CAPE PROVINCE**

### **NOTICE OF AVAILABILITY OF BASIC ASSESSMENT REPORTS FOR REVIEW AND COMMENTS**

The development of two separate solar photovoltaic (PV) facilities, each with a contracted capacity of up to 125MW, and associated grid connection is proposed on a site located approximately 11km south-east of the town of Aggeneys in the Northern Cape Province. The two solar PV facilities are to be known as Geelstert 1 and Geelstert 2. The grid connection solution will be known as Geelstert Grid Connection. The projects are situated within the Khâi-Ma Local Municipality, in the greater Namakwa District Municipality.

The two solar PV facilities are located on the Remaining Extent of the Farm Bloemhoek 61 and will be connected to the Aggeneis Main Transmission Substation (MTS). The grid connection will include a collector substation and a double-circuit power line of up to 220kV. The grid connection will traverse six (6) properties which include:

Remaining Extent of the Farm Bloemhoek 61	Remaining Extent of the Farm Aggeneys 56
Remaining Extent of Portion 1 of the Farm Aggeneys 56	Portion 2 of the Farm Aggeneys 56
Portion 12 of the Farm Aggeneys 56	Portion 13 of the Farm Aggeneys 56

It is the Developer's intention to bid each solar PV facility under the Department of Mineral Resources and Energy's<sup>1</sup> Renewable Energy Independent Power Producer Procurement (REIPPP) Programme. The power generated from each solar PV facility will be sold to Eskom and fed into the national electricity grid through the proposed grid connection. The development of the solar PV facilities and the grid connection will assist with the achievement of the electricity goals as set out in the Integrated Resources Plan (IRP), 2019.

The study area is located within Zone 8 of the Renewable Energy Development Zones (REDZ) (also known as the Springbok REDZ).

The applicant for each of the solar PV facilities will be a separate Special Purpose Vehicles (SPV). The applicant for Geelstert 1 is Geelstert Solar Facility 1 (Pty) Ltd, and the applicant for Geelstert 2 is Geelstert Solar Facility 2 (Pty) Ltd. The applicant for the Geelstert Grid Connection is ABO Wind renewable energies (Pty) Ltd. Three (3) separate Applications for Environmental Authorisation have been submitted to the Department of Environmental Affairs (DEA).

The notification of the development of two 125MW solar photovoltaic (PV) facilities and the associated grid connection distributed on 13 July 2020, has reference. The notification letter was accompanied by the Background Information Document (BID) which provided information regarding these Basic Assessment (BA) processes. If you have not received these documents, please inform us accordingly or we encourage you to visit our online stakeholder engagement platform at [www.savannahsa.com/public-documents/energy-generation/geelstert-1-and-geelstert-2-solar-pv-facilities-and-associated-grid-connection/](http://www.savannahsa.com/public-documents/energy-generation/geelstert-1-and-geelstert-2-solar-pv-facilities-and-associated-grid-connection/) the public documents for these three (3) projects are available for your perusal.

#### **AVAILABILITY OF BASIC ASSESSMENT REPORTS FOR REVIEW AND COMMENT**

In terms of Regulation 43(2) of the EIA Regulations, 2014, as amended, this letter serves to inform you that the Basic Assessment Reports (BARs) are available for review and written comments. The BARs' review and comment period is from **Thursday, 20 August 2020 until Monday, 21 September 2020**.

<b>Applicant name</b>	<b>Project/BA Report</b>
Geelstert Solar Facility 1 (Pty) Ltd	Geelstert 1
Geelstert Solar Facility 2 (Pty) Ltd	Geelstert 2
ABO Wind renewable energies (Pty) Ltd	Geelstert Grid Connection

The reports are available for downloading from our public participation platform at [www.savannahsa.com/public-documents/energy-generation/geelstert-1-and-geelstert-2-solar-pv-facilities-and-associated-grid-connection/](http://www.savannahsa.com/public-documents/energy-generation/geelstert-1-and-geelstert-2-solar-pv-facilities-and-associated-grid-connection/)

The restrictions enforced in terms of Government Gazette 43096 which placed the country in a national state of disaster limiting the movement and gathering of people to curb the spread of the COVID-19 virus has placed some limitations on making hard copies of the BARs available at public places such as libraries and municipal offices. As per our approved public participation plan submitted to the Department of Environmental Affairs (DEA), you can also request that an electronic copy of the BARs be sent to you via file transfer services such as WeTransfer or Dropbox.

---

<sup>1</sup> The Department of Mineral Resources and Energy is a merge between the Department of Mineral Resources (DMR) and the Department of Energy (DoE).

Please submit your written comments on the BARs by **Monday, 21 September 2020** via our public participation portal (link provided above) or:

- » Telephone: 011 656 3237
- » Mobile: 060 978 8396
- » Fax: 086 684 0547
- » Post: PO Box 148, Sunninghill, 2157
- » E-mail: [publicprocess@savannahsa.com](mailto:publicprocess@savannahsa.com)

All comments can be addressed to Ronald Baloyi of Savannah Environmental.

All comments received during the 30-day review and comment period will be recorded and included in the Final BARs for submission to the DEA in line with Regulation 44 of the EIA Regulations, 2014, as amended (GN R326).

Please do not hesitate to contact us should you require additional information and/or clarification regarding the project. Our team welcomes your participation and look forward to your involvement throughout this process.

Kind regards



**Nicolene Venter**

Public Participation and Social Consultant

Email: [publicprocess@savannahsa.com](mailto:publicprocess@savannahsa.com)

**Tiplady, Adrian - South African Radio Astronomy Observatory (SARAO)**



Date: 8/19/2020  
Time: 6:06 PM  
Creator: Ronald Baloyi Baloyi

Note

---

Subject: GEELSTERT 1 & 2 and GRID CONNECTION: Notification of the Availability of the Basic Assessment for review and comment

Body:

**GEELSTERT 1 AND GEELSTERT 2 SOLAR PV FACILITIES AND GEELSTERT GRID CONNECTION NEAR AGGENEYS, NORTHERN CAPE PROVINCE**

Dear Dr Tiplady and Mr Sethole,

The development of two separate solar photovoltaic (PV) facilities, each with a contracted capacity of up to 125MW, and associated grid connection is proposed on a site located approximately 11km south-east of the town of Aggeneys in the Northern Cape Province. The two solar PV facilities are to be known as Geelstert 1 and Geelstert 2. The grid connection solution will be known as Geelstert Grid Connection. The projects are situated within the Khâi-Ma Local Municipality, in the greater Namakwa District Municipality.

As a registered Interested and Affected Party (I&AP), you are hereby notified that the following three Basic Assessment Reports (BARs) are available for your review and comment from Thursday, 20 August 2020 until Monday, 21 September 2020. The reports are available for download from our website / stakeholder engagement platform on the above-mentioned link.

The restrictions enforced in terms of the Government Gazette 43096 which placed the country in a national state of disaster limiting the movement and gathering of people to curb the spread of the COVID-19 virus has placed some limitations on making hard copies of the BARs at the public places such as Libraries. We invite you to visit our online stakeholder engagement platform at <https://www.savannahsa.com/public-documents/energy-generation/geelstert-1-and-geelstert-2-solar-pv-facilities-and-associated-grid-connection/>

Should you not be able to access our online stakeholder engagement platform to download the BARs, please refer to the attached letter for alternative means to obtain the BARs. The attached letter also provides further details regarding the availability of the BARs.

Kind regards,

--

An email has been sent to "Adrian Tiplady" <[atiplady@sarao.ac.za](mailto:atiplady@sarao.ac.za)>, <[DBethel@sa.gov.za](mailto:DBethel@sa.gov.za)>, <[nicolene@savannahsa.com](mailto:nicolene@savannahsa.com)>;ronald@savannahsa.com;"Ronald Baloyi Baloyi" <[publicprocess@savannahsa.com](mailto:publicprocess@savannahsa.com)>

Please refer to the email saved in the Documents window.



19 August 2020

Mr Serame Motlhake  
Manager: GIS & Measurements Network Planning  
SENTECH

E-mail: [REDACTED]

Dear Mr Motlhake,

## GEELSTERT 1 AND GEELSTERT 2 SOLAR PV FACILITIES AND GEELSTERT GRID CONNECTION NEAR AGGENEYS, NORTHERN CAPE PROVINCE

### NOTICE OF AVAILABILITY OF BASIC ASSESSMENT REPORTS FOR REVIEW AND COMMENTS

The development of two separate solar photovoltaic (PV) facilities, each with a contracted capacity of up to 125MW, and associated grid connection is proposed on a site located approximately 11km south-east of the town of Aggeneys in the Northern Cape Province. The two solar PV facilities are to be known as Geelstert 1 and Geelstert 2. The grid connection solution will be known as Geelstert Grid Connection. The projects are situated within the Khâi-Ma Local Municipality, in the greater Namakwa District Municipality.

The two solar PV facilities are located on the Remaining Extent of the Farm Bloemhoek 61 and will be connected to the Aggeneys Main Transmission Substation (MTS). The grid connection will include a collector substation and a double-circuit power line of up to 220kV. The grid connection will traverse six (6) properties which include:

Remaining Extent of the Farm Bloemhoek 61	Remaining Extent of the Farm Aggeneys 56
Remaining Extent of Portion 1 of the Farm Aggeneys 56	Portion 2 of the Farm Aggeneys 56
Portion 12 of the Farm Aggeneys 56	Portion 13 of the Farm Aggeneys 56

It is the Developer's intention to bid each solar PV facility under the Department of Mineral Resources and Energy's<sup>1</sup> Renewable Energy Independent Power Producer Procurement (REIPPP) Programme. The power generated from each solar PV facility will be sold to Eskom and fed into the national electricity grid through the proposed grid connection. The development of the solar PV facilities and the grid connection will assist with the achievement of the electricity goals as set out in the Integrated Resources Plan (IRP), 2019.

<sup>1</sup> The Department of Mineral Resources and Energy is a merge between the Department of Mineral Resources (DMR) and the Department of Energy (DoE).

The study area is located within Zone 8 of the Renewable Energy Development Zones (REDZ) (also known as the Springbok REDZ).

The applicant for each of the solar PV facilities will be a separate Special Purpose Vehicles (SPV). The applicant for Geelstert 1 is Geelstert Solar Facility 1 (Pty) Ltd, and the applicant for Geelstert 2 is Geelstert Solar Facility 2 (Pty) Ltd. The applicant for the Geelstert Grid Connection is ABO Wind renewable energies (Pty) Ltd. Three (3) separate Applications for Environmental Authorisation have been submitted to the Department of Environmental Affairs (DEA).

The notification of the development of two 125MW solar photovoltaic (PV) facilities and the associated grid connection distributed on 13 July 2020, has reference. The notification letter was accompanied by the Background Information Document (BID) which provided information regarding these Basic Assessment (BA) processes. If you have not received these documents, please inform us accordingly or we encourage you to visit our online stakeholder engagement platform at [www.savannahsa.com/public-documents/energy-generation/geelstert-1-and-geelstert-2-solar-pv-facilities-and-associated-grid-connection/](http://www.savannahsa.com/public-documents/energy-generation/geelstert-1-and-geelstert-2-solar-pv-facilities-and-associated-grid-connection/) the public documents for these three (3) projects are available for your perusal.

#### **AVAILABILITY OF BASIC ASSESSMENT REPORTS FOR REVIEW AND COMMENT**

In terms of Regulation 43(2) of the EIA Regulations, 2014, as amended, this letter serves to inform you that the Basic Assessment Reports (BARs) are available for review and written comments. The BARs' review and comment period is from **Thursday, 20 August 2020 until Monday, 21 September 2020**.

<b>Applicant name</b>	<b>Project/BA Report</b>
Geelstert Solar Facility 1 (Pty) Ltd	Geelstert 1
Geelstert Solar Facility 2 (Pty) Ltd	Geelstert 2
ABO Wind renewable energies (Pty) Ltd	Geelstert Grid Connection

The reports are available for downloading from our public participation platform at [www.savannahsa.com/public-documents/energy-generation/geelstert-1-and-geelstert-2-solar-pv-facilities-and-associated-grid-connection/](http://www.savannahsa.com/public-documents/energy-generation/geelstert-1-and-geelstert-2-solar-pv-facilities-and-associated-grid-connection/)

The restrictions enforced in terms of Government Gazette 43096 which placed the country in a national state of disaster limiting the movement and gathering of people to curb the spread of the COVID-19 virus has placed some limitations on making hard copies of the BARs available at public places such as libraries and municipal offices. As per our approved public participation plan submitted to the Department of Environmental Affairs (DEA), you can also request that an electronic copy of the BARs be sent to you via file transfer services such as WeTransfer or Dropbox.

Please submit your written comments on the BARs by **Monday, 21 September 2020** via our public participation portal (link provided above) or:

- » Telephone: 011 656 3237
- » Mobile: 060 978 8396
- » Fax: 086 684 0547
- » Post: PO Box 148, Sunninghill, 2157
- » E-mail: [publicprocess@savannahsa.com](mailto:publicprocess@savannahsa.com)

All comments can be addressed to Ronald Baloyi of Savannah Environmental.

All comments received during the 30-day review and comment period will be recorded and included in the Final BARs for submission to the DEA in line with Regulation 44 of the EIA Regulations, 2014, as amended (GN R326).

Please do not hesitate to contact us should you require additional information and/or clarification regarding the project. Our team welcomes your participation and look forward to your involvement throughout this process.

Kind regards

A handwritten signature in black ink, appearing to read 'Nicolene Venter', written in a cursive style.

**Nicolene Venter**

Public Participation and Social Consultant

Email: [publicprocess@savannahsa.com](mailto:publicprocess@savannahsa.com)

**Motlhake, Serame - Sentech Ltd**

Date: 8/19/2020  
Time: 6:09 PM  
Creator: Ronald Baloyi Baloyi

Note

---

Subject: GEELSTERT 1 & 2 and GRID CONNECTION: Notification of the Availability of the Basic Assessment for review and comment

Body:

**GEELSTERT 1 AND GEELSTERT 2 SOLAR PV FACILITIES AND GEELSTERT GRID CONNECTION NEAR AGGENEYS, NORTHERN CAPE PROVINCE**

Dear Mr Motlhake,

The development of two separate solar photovoltaic (PV) facilities, each with a contracted capacity of up to 125MW, and associated grid connection is proposed on a site located approximately 11km south-east of the town of Aggeneys in the Northern Cape Province. The two solar PV facilities are to be known as Geelstert 1 and Geelstert 2. The grid connection solution will be known as Geelstert Grid Connection. The projects are situated within the Khâi-Ma Local Municipality, in the greater Namakwa District Municipality.

As a registered Interested and Affected Party (I&AP), you are hereby notified that the following three Basic Assessment Reports (BARs) are available for your review and comment from Thursday, 20 August 2020 until Monday, 21 September 2020. The reports are available for download from our website / stakeholder engagement platform on the above-mentioned link.

The restrictions enforced in terms of the Government Gazette 43096 which placed the country in a national state of disaster limiting the movement and gathering of people to curb the spread of the COVID-19 virus has placed some limitations on making hard copies of the BARs at the public places such as Libraries. We invite you to visit our online stakeholder engagement platform at <https://www.savannahsa.com/public-documents/energy-generation/geelstert-1-and-geelstert-2-solar-pv-facilities-and-associated-grid-connection/>

Should you not be able to access our online stakeholder engagement platform to download the BARs, please refer to the attached letter for alternative means to obtain the BARs. The attached letter also provides further details regarding the availability of the BARs.

Kind regards,

--

An email has been sent to "Serame Motlhake"  nicolene@savannahsa.com;ronald@savannahsa.com;"Ronald Baloyi Baloyi" <publicprocess@savannahsa.com>

Please refer to the email saved in the Documents window.