

WKN Windcurrent South Africa (Pty) Ltd

ENVIRONMENTAL NOISE IMPACT ASSESSMENT

**for an Application for Amendment of the Environmental
Authorization of the proposed Highlands South Wind Energy
Facility Near Somerset East, Eastern Cape Province**



Study done for:



Prepared by:



P.O. Box 2047, Garsfontein East, 0060
Tel: 012 – 004 0362, Fax: 086 – 621 0292, E-mail: info@eares.co.za

This Report should be sited as:

De Jager, M. 2021: "*Environmental Noise Impact Assessment for an Application for Amendment of the Environmental Authorization of the proposed Highlands South Wind Energy Facility Near Somerset East, Eastern Cape Province*". Enviro-Acoustic Research, Pretoria

Client:

Holland & Associates Environmental Consultants
for
WKN Windcurrent South Africa (Pty) Ltd

PO Box 31108
Tokai
7966

Report no:

HA-WKNHSWEF/ENIA/202110-Rev 2

Author:

M. de Jager (B. Ing (Chem))

Review:

Johan Maré (MSc. Microbiology, Pri Sci Nat (400092/91))

Date:

October 2021

COPYRIGHT WARNING

This information is privileged and confidential in nature and unauthorized dissemination or copying is prohibited. This information will be updated as required. WKN Windcurrent South Africa (Pty) Ltd claims protection of this information in terms of the Promotion of Access to Information Act, (No 2 of 2002) and without limiting this claim, especially the protection afforded by Chapter 4.

The document is the property of Enviro Acoustic Research cc. The content, including format, manner of presentation, ideas, technical procedure, technique and any attached appendices are subject to copyright in terms of the Copyright Act 98 of 1978 (as amended by the respective Copyright Amendment Acts No. 56 of 1980, No. 66 of 1983, No. 52 of 1984, No. 39 of 1986, No. 13 of 1988, No. 61 of 1989, No. 125 of 1992, Intellectual Property Laws Amendment Act, No. 38 of 1997 and, No. 9 of 2002) in terms of section 6 of the aforesaid Act, and may only be reproduced as part of the Environmental Impact Assessment process by Holland & Associates (Pty) Ltd.

EXECUTIVE SUMMARY

INTRODUCTION AND PURPOSE

Enviro-Acoustic Research cc was commissioned by Holland & Associates Environmental Consultants to identify and assess the potential change in the noise impact relating to the proposed changes to the authorized Highlands South Wind Energy Facility (WEF). As the author did not assess the potential noise impact of the original project, a full environmental noise impact study was done, though the author was the review specialist for the original Noise Study (Reid, 2018)¹.

This review considered local and international guidelines, using the terms of reference (ToR) as proposed by SANS 10328:2008 and as proposed by the requirements specified in the Assessment Protocol for Noise that were published on 20 March 2020, in Government Gazette 43110, GN 320.

PROJECT DESCRIPTION

Highlands North Wind Energy Facility (RF) (Pty) Ltd, Highlands Central Wind Energy Facility (RF) (Pty) Ltd, and the Highlands South Wind Energy Facility (RF) (Pty) Ltd applied for Environmental Authorisation (EA) from the Department of Environmental Affairs (DEA) in 2019 to establish three Wind Energy Facilities (WEFs), the Highlands North, the Highlands Central and the Highlands South WEFs (and associated infrastructure). The WEFs will be located approximately 20 km west of the town of Somerset West in the Eastern Cape Province. This report specifically covers the **Highlands South WEF**.

The infrastructure associated with the **90 MW Highlands South WEF**, as described in the EA (Ref: 14/12/16/3/3/1/1960) dated 21 January 2020, includes up to 15 wind turbine generators (WTGs) with a rotor diameter of up to 150 m (a blade length of up to 75 m), hub height from ground level up to 135 m and associated infrastructure including foundations, transformer hard standing areas, cabling between turbines, transformer substations, permanent and temporary laydown areas, operations & maintenance buildings, internal roads, fencing and lighting system. The original layout was assessed in 2018 by Michael Reid of Arcus Consultancy Services, with the Author doing a formal review of the report in terms of SANS 10328 for Arcus Consultancy.

¹ Reid, M. 2018: "*Proposed Highlands Wind Energy Facilities – Eastern Cape Province – Environmental Impact Assessment Report – Noise*". Arcus Consultancy Services, Glasgow

Highlands South Wind Energy Facility (RF) (Pty) Ltd wishes to increase the maximum dimensions of the Wind Turbine Generators (WTG's) for the Highlands South WEF respectively, in order to align to current international WTG models.

Subsequently, the Applicant has developed a revised proposed turbine layout consisting of up to 12 turbines, with a rotor diameter of up to 175 m and a hub height of up to 180 m, with the proposed amendments for the WEF project outlined below. The amendment will include an 870MWh Battery Energy Storage System (BESS).

Component	Approved	Proposed Amendment
Number of WTGs	15 WTGs	Maximum of 12 WTGs
Generation capacity of the WEF:	Up to 90 MW	No change
Generation capacity per turbine:	Up to 6 MW	Remove generation capacity per turbine
Rotor / blade diameters	Maximum of 150 m	Maximum of 175 m.
Hub Height	Maximum of 135 m	Maximum of 180 m
Tip Height	Maximum of 200 m	Maximum of 267.5 m
Foundation Size:	up to approximately 25 m x 25 m in total and up to 5 m deep per turbine	up to approximately 35 m x 35 m in total and up to 7 m deep per turbine
Hard Stand area per turbine:	5000 m ²	6000 m ²
Battery Storage	N/A (Not currently included in project description)	Battery Energy Storage System adjacent to the substation on the temporary laydown area (with a footprint of approximately 1ha, and a height of approximately 8m).
Length of internal roads	Approximately 50 km	Approximately 45 km

In addition, the following amendments are proposed:

- Slight adjustments to the turbine positions in the preliminary approved layout are proposed, in order to minimise wake effects, as well as to avoid the proposed new blade length extending into areas identified as highly sensitive for birds and bats.
- Refinement to the proposed access roads layout (due to amendments to turbine positions and the reduction in the number of turbines at the WEF).
- Rotation of the Substation yard, to fit the proposed amended road layout.
- Removal of Condition 17.1 (relating to the requirement of an Electromagnetic Compatibility (EMC) Control Plan for acceptance by the SKA-SA, for inclusion in the Final EMPr).

- Removal of Condition 42 which states that “The development footprint must exclude the area identified as a potential target for the protected area expansion (NPAES).
- The addition of the proposed battery storage technology, adjacent to the substation (on the temporary laydown area), would have a footprint of approximately 1 ha, and a height of approximately 8 m.

DESCRIPTION OF AMBIENT SOUND LEVELS

Ambient (background) noise levels were also measured during June 2018 in accordance with the South African National Standards, with the data augmented with measurements collected in June 2020 (for a different WEF project).

All the data indicated an area with a high potential to be quiet both day and night. The visual character of the study area is rural and it was accepted that the SANS 10103 noise district classification could be rural.

NOISE IMPACT DETERMINATION AND FINDINGS

The potential noise impact relating to the proposed amendments of the approved Highlands South WEF was evaluated using a sound propagation model. Conceptual scenarios were developed for the construction and operation phases, considering a sound power emission level of an unmitigated (108.5 dBA re 1 pW) and mitigated (106 dBA re 1 pW) Acciona AW132 wind turbine for the operational phase. With the modelled input data as used, this assessment indicated that:

- A potential noise impact of a **low** significance (with and without mitigation) relating to activities associated with the development of hardstanding areas, foundations, civil work and erecting the WTG during the day;
- A potential noise impact of a **low** significance (with and without mitigation) for the night-time construction activities (generally for the concreting of foundations and the erection of the wind turbines);
- A potential noise impact of a **low** significance (with and without mitigation) relating to the construction of the access roads;
- A potential noise impact of a **low** significance (with and without mitigation) relating to the use of access roads during the construction phase;
- A potential noise impact of a **low** significance (with and without mitigation) for operation of the proposed wind turbines during the day;
- A potential noise impact of a **medium** significance (with and without mitigation) for night-time operational activities (noises from wind turbines);
- A potential noise impact of a **low** significance (with and without mitigation) for the decommissioning of the proposed WEF;

- The development of the amended Highlands South WEF will not increase cumulative noises in the area during the construction phase;
- The development of the amended Highlands South WEF will not increase cumulative noises in the area during the operational phase; and
- The addition of a BESS will not increase noise levels and the significance of the noises from the BESS will be **low** (both construction and operational).

POTENTIAL MITIGATION MEASURES

Updates to the mitigation measures were included to clarify statements and prevent ambiguity when considering the mitigation measures. It is recommended that these updated measures replace the original mitigation measures in the updated Environmental Management Programme report (EMPr):

- With regard to unavoidable noisy construction activities in the vicinity of noise sensitive areas (closer than 500 m from any identified NSD), the contractor and ECO must liaise with local residents on how best to minimise impact and they must be kept informed of the nature and duration of intended activities;
- Blasting operations are to be strictly controlled with regard to the size of explosive charge in order to minimise noise and air blast, and timings of explosions. The number of blasts per day must be limited, blasting must be undertaken at the same times each day and no blasting must be allowed at night;
- Construction equipment must be kept in good working order and where appropriate fitted with silencers which are kept in good working order;
- Where practicable, mobile equipment should be fitted with broadband (white-noise generators), rather than tonal reverse alarms;
- The use of vehicle horns should be limited to emergency use only;
- Road trucks should slow down well before the turn onto the project site to prevent the use of air brakes; and
- Public relations should be maintained with local residents that may be affected by noise from site operations;
- The developer should implement a noise monitoring programme at NSD10. If the developer selects to use a wind turbine with a sound power emission level less than 106.0 dBA (re 1 pW) at turbine location T34 and T36 (such as the mitigated Acciona AW132), no noise monitoring will be required; and
- The developer must investigate any reasonable and valid noise complaint if registered by a receptor staying within 2,000 m from the location where construction or decommissioning activities are taking place, or a location where an operational wind turbine is present. A complaints register must be kept on site.

CONCLUSIONS AND RECOMMENDATIONS

Considering the outcome of the modelling, based on the conceptual scenarios as envisaged and input parameters used:

- The proposed amendments to the project will not result in an increased level or significance of the noise impact, nor result in a change in the nature of potential noise impacts;
- The proposed amendments to the project have the advantage that it will decrease the projected noise levels as well as the significance of the noise impact during the construction and operational phases;
- The proposed amendments to the project, due to the slightly lower noise levels, will require less mitigation measures and management as recommended in the original noise study (Reid, 2018).

It is recommended that the developer:

- implement a noise monitoring programme at NSD10. If the developer selects to use a wind turbine with a sound power emission level less than 106.0 dBA (re 1 pW) at turbine location T34 and T36 (such as the mitigated Acciona AW132), no noise monitoring will be required; and
- investigate any reasonable and valid noise complaint if registered by a receptor staying within 2,000 m from the location where construction or decommissioning activities are taking place, or a location where an operational wind turbine is present. A complaints register must be kept on site.
- re-evaluate the potential noise impact should the layout be revised where any proposed wind turbines are located closer than 1,000 m from a confirmed NSD; or
- re-evaluate the potential noise impact if the developer decides to use a different wind turbine that has a sound power emission level higher than that of the WTG used in this report (sound power emission level exceeding 108.5 dBA re 1 pW).

Considering the **low significance** (with and without mitigation) of the potential noise impacts, it is recommended that the proposed amendments to the authorized Highlands South WEF be authorized.

TABLE OF CONTENTS

	Page
EXECUTIVE SUMMARY	i
TABLE OF CONTENTS	vii
LIST OF TABLES.....	x
LIST OF FIGURES.....	xi
APPENDICES.....	xii
1 COMPLIANCE WITH THE NOISE SPECIALIST ASSESSMENT REQUIREMENTS AS PER THE PROTOCOL FOR NOISE SPECIALIST ASSESSMENTS: GOVERNMENT GAZETTE 43110	1
2 INTRODUCTION	3
2.1 Introduction and Purpose	3
2.2 Brief Project Description	3
2.2.1 <i>Project Background.....</i>	<i>3</i>
2.2.2 <i>Proposed Project Amendments.....</i>	<i>4</i>
2.3 Proposed Wind Turbine	6
2.4 Study area	6
2.4.1 <i>Topography</i>	<i>6</i>
2.4.2 <i>Roads and rail roads.....</i>	<i>6</i>
2.4.3 <i>Land use</i>	<i>7</i>
2.4.4 <i>Residential areas.....</i>	<i>7</i>
2.4.5 <i>Ground conditions and vegetation.....</i>	<i>7</i>
2.4.6 <i>Existing Ambient Sound Levels.....</i>	<i>7</i>
2.5 Noise-sensitive developments	7
2.6 Environmental Sensitivity – Noise Theme.....	9
2.7 Comments Previously Received	9
2.8 Legislative Requirements and Terms of Reference	9
2.8.1 <i>Requirements as per GG 43110.....</i>	<i>9</i>
2.8.2 <i>Requirements as per South African National Standards</i>	<i>10</i>
3 POLICIES AND THE LEGAL CONTEXT	15
3.1 The Republic of South Africa Constitution Act (“the Constitution”)...	15

3.2	The National Environmental Management Act, 1998 (Act 107 of 1998)	15
3.3	The Environment Conservation Act, 1989 (Act 73 of 1989)	16
3.3.1	<i>Noise Control Regulations (GN R154 of 1992)</i>	<i>16</i>
3.4	Noise Standards	18
3.5	Strategic Environmental Assessment for Wind Energy Facilities in South Africa	18
3.6	International Guidelines	19
3.6.1	<i>Guidelines for Community Noise (World Health Organization, 1999)</i>	<i>19</i>
3.6.2	<i>The Assessment and Rating of Noise from Wind Farms (Energy Technology Support Unit, 1997).....</i>	<i>19</i>
3.6.3	<i>Noise Guidelines for Wind Farms (MoE, 2008)</i>	<i>21</i>
3.6.4	<i>Equator Principles.....</i>	<i>21</i>
3.6.5	<i>IFC: General EHS Guidelines – Environmental Noise Management</i>	<i>22</i>
3.6.6	<i>Environmental Noise Guidelines for the European Region (2018)</i>	<i>23</i>
3.6.7	<i>European Parliament Directive 200/14/EC (2000).....</i>	<i>24</i>
4	ENVIRONMENTAL SOUND CHARACTER.....	25
4.1	Influence of Season on Ambient Sound Levels	25
4.1.1	<i>Effect of Wind</i>	<i>25</i>
4.1.2	<i>Effect of Temperature</i>	<i>26</i>
4.1.3	<i>Effect of Humidity.....</i>	<i>26</i>
4.2	Ambient Sound Levels	27
5	POTENTIAL NOISE SOURCES.....	31
5.1	Potential Noise Sources: Construction Phase	31
5.1.1	<i>Construction equipment</i>	<i>31</i>
5.1.2	<i>Material supply: Concrete batching plants and use of Borrow Pits</i>	<i>36</i>
5.1.3	<i>Blasting.....</i>	<i>36</i>
5.1.4	<i>Traffic</i>	<i>36</i>
5.2	Potential Noise Sources – Operational Phase	37
5.2.1	<i>Wind Turbine Noise.....</i>	<i>37</i>
5.2.2	<i>Low Frequency Noise</i>	<i>41</i>
5.2.3	<i>Amplitude modulation</i>	<i>43</i>
5.2.4	<i>Battery Energy Storage Systems</i>	<i>44</i>
6	ASSUMPTIONS AND LIMITATIONS.....	46
6.1	Measurements of Ambient Sound Levels.....	46

6.2	Calculating noise emissions – Adequacy of predictive methods	47
6.3	Adequacy of Underlying Assumptions	48
6.4	Uncertainties of Information Provided	48
6.5	Conditions that this Report may be Subject to	49
7	METHODOLOGY: ENVIRONMENTAL NOISE IMPACT	
	ASSESSMENT AND SIGNIFICANCE	50
7.1	Noise Impact on Animals.....	50
7.2	Why noise concerns communities	51
7.2.1	<i>Annoyance associated with Wind Energy Facilities</i>	<i>51</i>
7.3	Impact Assessment Criteria	53
7.3.1	<i>Overview: The common characteristics</i>	<i>53</i>
7.3.2	<i>Noise criteria of concern</i>	<i>53</i>
7.3.3	<i>Determining appropriate Zone Sound Levels</i>	<i>55</i>
7.3.4	<i>Determining the Significance of the Noise Impact</i>	<i>58</i>
7.3.5	<i>Identifying the Potential Impacts</i>	<i>60</i>
7.4	Representation of noise levels.....	60
8	PROJECTED NOISE RATING LEVELS	61
8.1	Construction Phase Noise Impact	61
8.2	Operation Phase Noise Impact	64
8.3	Potential Cumulative Noise Impacts	64
8.4	Decommissioning and Closure Phase Noise Impact.....	65
9	SIGNIFICANCE OF THE NOISE IMPACT	69
9.1	Construction Phase Noise Impact	69
9.2	Operation Phase Noise Impact	72
9.3	Cumulative noise impact.....	75
9.4	Decommissioning Phase Noise Impact.....	76
9.5	Comparative findings considering previous noise study	77
10	MITIGATION MEASURES	78
10.1	Mitigation options available to reduce Noise Impact during the Construction Phase	79
10.2	Mitigation options available to reduce Noise Impact during operation	80
10.3	Mitigation options available to reduce Noise Impact during decommissioning	80

10.4	Special Conditions.....	80
10.4.1	<i>Mitigation options that should be included in the updated Environmental Management Programme (EMPr)</i>	<i>80</i>
11	ENVIRONMENTAL NOISE MONITORING PLAN	82
11.1	Measurement Localities and Frequency.....	82
11.2	Measurement Procedures	83
12	CONCLUSIONS AND RECOMMENDATIONS	84
13	REFERENCES	86

LIST OF TABLES

	page
Table 2-1: Proposed Amendments to Project Description	4
Table 2-2: Original NSA labelling and NSD labeling differences	8
Table 3-1: Interpretation of noise sensitivity and assessment requirements	18
Table 3-2: Summary of Sound Level Limits for Wind Farms (MoE).....	21
Table 3-3: IFC Table 7.1-Noise Level Guidelines	23
Table 4-1: Residual Noise Levels measured onsite.....	27
Table 5-1: Potential maximum noise levels generated by construction equipment	33
Table 5-2: Potential equivalent noise levels generated by various equipment.....	35
Table 7-1: Acceptable Zone Sound Levels for noise in districts (SANS 10103).....	55
Table 7-2: Proposed ambient sound levels and acceptable rating levels	57
Table 7-3: Impact Assessment Criteria – Magnitude	58
Table 7-4: Impact Assessment Criteria - Duration	59
Table 7-5: Impact Assessment Criteria – Spatial extent	59
Table 7-6: Impact Assessment Criteria - Probability	59
Table 7-7: Significance (without mitigation) Rating	60
Table 8-1: Octave Sound Power Emission Levels used for modelling	64
Table 9-1: Impact Assessment: Construction Activities during the day.....	69
Table 9-2: Impact Assessment: Construction Activities at night	70
Table 9-3: Impact Assessment: Construction of roads (daytime)	71
Table 9-4: Impact Assessment: Daytime construction traffic	72
Table 9-5: Impact Assessment: Operational Activities during the day	73
Table 9-6: Impact Assessment: Operational Activities at night.....	74
Table 9-7: Impact Assessment: Potential Cumulative Construction Noise Impacts	75
Table 9-8: Impact Assessment: Potential Cumulative Operational Noise Impacts	76

Table 9-9: Summary of findings from original noise study (for the authorized WEF) (Reid, 2018) 77
Table 9-10: Summary of findings from this re-assessment (for the proposed amendments) (de Jager, 2021) 77

LIST OF FIGURES

	page
Figure 2-1: Aerial Image indicating original WTG layout and Noise-sensitive areas as assessed in the 2018 study	13
Figure 2-2: Proposed amended layout: Aerial Image indicating site sensitivity and closest identified Noise-sensitive developments	14
Figure 4-1: Residual Daytime Noise Level against wind speed	28
Figure 4-2: Residual Night-time Noise Level against wind speed	28
Figure 4-3: Localities where ambient sound levels were measured	29
Figure 4-4: Ambient sound levels measured in vicinity of project	30
Figure 5-1: Noise Emissions Curve of a number of different wind turbines (figure for illustration purposes only)	38
Figure 5-2: Octave sound power emissions of various wind turbines	39
Figure 5-3: Third octave band sound power levels at various wind speeds at a location where wind induced noises dominate	42
Figure 5-4: Example time-sound series graph illustrating AM as measured by Stigwood (<i>et al</i>) (2013)	43
Figure 5-5: Conceptual BESS components	45
Figure 7-1: Percentage of annoyed persons as a function of the day-evening-night noise exposure at the façade of a dwelling	52
Figure 7-2: Criteria to assess the significance of impacts stemming from noise	54
Figure 8-1: Projected conceptual construction noise levels – Decay of noise from construction activities	62
Figure 8-2: Projected conceptual construction noise levels – Decay over distance from linear activities (roads)	63
Figure 8-3: Projected maximum night-time operational noise rating levels due to operation of Highlands South WEF: Proposed amended layout	66
Figure 8-4: Effect of distance between wind turbines – potential cumulative noise	67
Figure 8-5: Projected cumulative maximum night-time operational noise levels	68
Figure 9-1: Projected noise levels at different wind speeds	75

APPENDICES

<u>Appendix A</u>	Curriculum Vitae
<u>Appendix B</u>	Glossary of Terms
<u>Appendix C</u>	Declaration of Independence
<u>Appendix D</u>	Site Sensitivity Verification
<u>Appendix E</u>	Calculated conceptual noise levels

ABBREVIATIONS

ADT	Articulated Dump Trucks
ASTER	Advanced Spaceborne Thermal Emission and Reflection Radiometer
BA	Basic Assessment
dB/dBA	Decibel
DFFE	Department of Forestry, Fisheries and the Environment
EARES	Enviro Acoustic Research cc
ECA	Environment Conservation Act
ECO	Environmental Control Officer
EIA	Environmental Impact Assessment
EHS	Environmental Health and Safety
ENIA	Environmental Noise Impact Assessment
ENM	Environmental Noise Monitoring
ENPAT	Environmental Potential Atlas for South Africa
ETSU	Energy Technology Support Unit
EPs	Equator Principles
EPFIs	Equator Principles Financial Institutions
FEL	Front-end Loader
GN	Government Notice
GNR	Government Notice Regulation
HNI	House Not Inhabited
I&APs	Interested and Affected Parties
IEC	International Electrotechnical Commission
IFC	International Finance Corporation
ISO	International Organization for Standardization
METI	Ministry of Economy, Trade, and Industry
NA	No Access
NASA	National Aeronautical and Space Administration
NEMA	National Environmental Management Act

NCR	Noise Control Regulations
NSD	Noise-sensitive Development
PPP	Public Participation Process
PWL	Sound Power Level
SABS	South African Bureau of Standards
SANS	South African National Standards
SPL	Sound Power Level
SR	Significance Rating
TLB	Tip load bucket (also referred to as a back-actor or backhoe)
UTM	Universal Transverse Mercator
WHO	World Health Organization
WEF	Wind Energy Facility
WF	Wind Farm
WTG	Wind Turbine Generator

GLOSSARY OF UNITS

dB	Decibel (expression of the relative loudness of the un-weighted sound level in air)
dBA	Decibel (expression of the relative loudness of the A-weighted sound level in air)
Hz	Hertz (measurement of frequency)
kg/m ²	Surface density (measurement of surface density)
km	kilometre (measurement of distance)
m	Meter (measurement of distance)
m ²	Square meter (measurement of area)
m ³	Cubic meter (measurement of volume)
mamsl	Meters above mean sea level
m/s	Meter per second (measurement for velocity)
°C	Degrees Celsius (measurement of temperature)
µPa	Micro pascal (measurement of pressure – in air in this document)

1 COMPLIANCE WITH THE NOISE SPECIALIST ASSESSMENT REQUIREMENTS AS PER THE PROTOCOL FOR NOISE SPECIALIST ASSESSMENTS: GOVERNMENT GAZETTE 43110

In terms of GNR 320 (20 March 2020), the Noise Specialist Assessment must contain, as a minimum, the following information:

Clause	Reporting Requirements as per the Protocol for Noise Specialist Assessments	Compliance of current report / Reference
2.3.1	Current ambient sound levels recorded at relevant locations over a minimum of two nights and that provide a representative measurement of the ambient noise climate, with each sample being a minimum of ten minutes and taken at two different times of the night on each night, in order to record typical ambient sound levels at these different times of night	section 4.2 and Figure 4-4
2.3.2	Records of the approximate wind speed at the time of the measurement	Figure 4-4
2.3.3	Mapped distance of the receiver from the proposed development that is the noise source	Figure 2-2
2.3.4	Discussion on temporal aspects of baseline ambient conditions	Section 4.1
2.4.1	Characterization and determination of noise emissions from the noise source, where characterization could include types of noise, frequency, content, vibration and temporal aspects	Sections 5.1 and 5.2
2.4.2	Projected total noise levels and changes in noise levels as a result of the construction, commissioning and operation of the proposed development for the nearest receptors using industry accepted models and forecasts	<u>Appendix E</u>
2.4.3	Desired noise levels for the area	Table 7-2
2.5.1	Contact details of the environmental assessment practitioner or noise specialist, their relevant qualifications and expertise in preparing the statement, and a curriculum vitae	<u>Appendix A</u>
2.5.2	a signed statement of independence by the environmental assessment practitioner or noise specialist.	<u>Appendix C</u>
2.5.3	The duration and date of the site inspection and the relevance of the season and weather condition to the outcome of the assessment	Section 4.2
2.5.4	A description of the methodology used to undertake the on-site assessment, inclusive of the equipment and models used, as relevant, together with the results of the noise assessment	Section 4.2

2.5.5	a map showing the proposed development footprint (including supporting infrastructure) overlaid on the noise sensitivity map generated by the screening tool	Figure 2-2
2.5.6	confirmation that all reasonable measures have been taken through micro- siting to minimize disturbance to receptors	Various layouts previously investigated
2.5.7	a substantiated statement from the specialist on the acceptability, or not, of the proposed development and a recommendation on the approval, or not, of the proposed development	Section 12
2.5.8	any conditions to which this statement is subjected	See section 6.5
2.5.9	the assessment must identify alternative development footprints within the preferred site which would be of a "low" sensitivity as identified by the screening tool and verified through the site sensitivity verification and which were not considered	Various layouts previously investigated
2.5.10	A motivation must be provided if there were development footprints identified as per paragraph 2.5.9 above that were identified as having a "low" noise sensitivity and that were not considered appropriate	Various layouts previously investigated. No turbines located in areas identified with high noise sensitivity.
2.5.11	where required, proposed impact management outcomes, mitigation measures for noise emissions during the construction and commissioning phases that may be of relative short duration, or any monitoring requirements for inclusion in the Environmental Management Programme (EMPr), and	See section 10
2.5.12	a description of the assumptions made and any uncertainties or gaps in knowledge or data as well as a statement of the timing and intensity of site inspection observations	See section 0

2 INTRODUCTION

2.1 INTRODUCTION AND PURPOSE

Enviro-Acoustic Research cc was commissioned by Holland & Associates Environmental Consultants to identify and assess the potential change in the noise impact relating to the proposed changes to the authorized Highlands South WEF. As the author did not assess the potential noise impact of the original project (noise study done by Reid (2018)), a full environmental noise impact study was done. The author did review the original Noise Study on the request of Arcus Consultancy Services in 2018.

This report briefly discusses the ambient sound levels in the area, potential worst-case noise rating levels and the potential noise impact that the proposed amendments (including amendments to the layout and wind turbine specifications as well as the addition of a BESS) may have on the surrounding environment, highlighting the methods used, potential issues identified, findings and recommendations.

This study considered local regulations and both local and international guidelines, using the terms of reference (ToR) as proposed by SANS 10328:2008 for a comprehensive Environmental Noise Impact Assessment (ENIA) and as proposed by the requirements specified in the Assessment Protocol for Noise that were published on 20 March 2020, in Government Gazette 43110, GN 320. As the author did not assess the potential noise impact of the original project, a full environmental noise impact study was done, though the author was the review specialist for the original Noise Study (Reid, 2018).

2.2 BRIEF PROJECT DESCRIPTION

2.2.1 Project Background

Highlands North Wind Energy Facility (RF) (Pty) Ltd, Highlands Central Wind Energy Facility (RF) (Pty) Ltd, and Highlands South Wind Energy Facility (RF) (Pty) Ltd applied for Environmental Authorisation (EA) from the Department of Environmental Affairs (DEA) in 2019 to establish three Wind Energy Facilities (WEFs), the Highlands North WEF (14/12/16/3/3/1/1955), the Highlands Central WEF (14/12/16/3/3/1/1958) and the **Highlands South WEF (14/12/16/3/3/1/1960)** (and associated infrastructure). The WEFs will be located approximately 20 km west of the town of Somerset West in the Eastern Cape Province. This report specifically covers the **Highlands South WEF**.

The infrastructure associated with the **90 MW Highlands South WEF**, as described in the DFFE EA (Ref: 14/12/16/3/3/1/1960) dated 21 January 2020, includes up to 15 wind

turbine generators (WTGs) with a rotor diameter of up to 150 m (a blade length of up to 75 m), hub height from ground level up to 135 m and associated infrastructure including foundations, transformer hard standing areas, cabling between turbines, transformer substations, permanent and temporary laydown areas, operations & maintenance buildings, internal roads, fencing and lighting system. The original layout was assessed in 2018 by Michael Reid of Arcus Consultancy Services, with the Author doing a formal review of the report in terms of SANS 10328 for Arcus Consultancy. The original layout, as assessed in the 2018 noise study², is depicted in **Figure 2-1**.

The project is located within the Cookhouse Renewable Energy Development Zone (REDZ), therefore Basic Assessment processes were followed in line with GN R.114 in Government Gazette 41445 of 16 February 2018. The three Basic Assessment processes for the projects were completed by Arcus Consultancy Services South Africa (Pty) Ltd in 2018/2019 and Environmental Authorizations for the proposed projects were granted by the Department of Forestry, Fisheries and the Environment (DFFE) (previously known as DEA) in January and February 2020.

2.2.2 Proposed Project Amendments

Highlands South Wind Energy Facility (RF) (Pty) Ltd wishes to increase the maximum dimensions of the Wind Turbine Generators (WTG's) for the Highlands South WEF respectively, in order to align to current international WTG models.

Subsequently, the Applicant has developed a revised proposed turbine layout consisting of up to 12 turbines, with a rotor diameter of up to 175 m and a hub height of up to 180 m, with the proposed amendments for the WEF project outlined below. The amendment will include an 870MWh Battery Energy Storage System (BESS).

In light of the above, the amendments to the project description as defined in **Table 2-1** are proposed. The latest layout is depicted in **Figure 2-2**.

Table 2-1: Proposed Amendments to Project Description

Component	Approved	Proposed Amendment
Number of WTGs	15 WTGs	Maximum of 12 WTGs
Generation capacity of the WEF:	Up to 90 MW	No change
Generation capacity per turbine:	Up to 6 MW	Remove generation capacity per turbine

² Reid, M. 2018: "Proposed Highlands Wind Energy Facilities – Eastern Cape Province – Environmental Impact Assessment Report – Noise". Arcus Consultancy Services, Glasgow

Rotor / blade diameters	Maximum of 150 m	Maximum of 175 m.
Hub Height	Maximum of 135 m	Maximum of 180 m
Tip Height	Maximum of 200 m	Maximum of 267.5 m
Foundation Size:	up to approximately 25 m x 25 m in total and up to 5 m deep per turbine	up to approximately 35 m x 35 m in total and up to 7 m deep per turbine
Hard Stand area per turbine:	5000 m ²	6000 m ²
Battery Storage	N/A (Not currently included in project description)	Battery Energy Storage System adjacent to the substation on the temporary laydown area (with a footprint of approximately 1ha, and a height of approximately 8m).
Length of internal roads	Approximately 50 km	Approximately 45 km

In addition, the following amendments are proposed:

- Slight adjustments to the turbine positions in the preliminary approved layout are proposed, in order to minimise wake effects, as well as to avoid the proposed new blade length extending into areas identified as highly sensitive for birds and bats.
- Refinement to the proposed access roads layout (due to amendments to turbine positions and the reduction in the number of turbines at the WEF).
- Rotation of the Substation yard, to fit the proposed amended road layout.
- Removal of Condition 17.1 (relating to the requirement of an Electromagnetic Compatibility (EMC) Control Plan for acceptance by the SKA-SA, for inclusion in the Final EMPr).
- Removal of Condition 42 which states that "The development footprint must exclude the area identified as a potential target for the protected area expansion (NPAES)."
- The addition of the proposed battery storage technology, adjacent to the substation (on the temporary laydown area), would have a footprint of approximately 1 ha, and a height of approximately 8 m.

Type of Battery	: Battery Storage Facility comprising Solid State or Flow technologies (e.g Lithium-ion, Sodium-sulphur, Vanadium Redox Flow or an alternative battery technology)
Life span of BESS	: Assume the same as duration of facility
Motivation for BESS	: Battery storage offers a wide range of advantages to South Africa including renewable energy time shift, renewable capacity firming, electricity supply reliability and quality improvement, voltage regulation, electricity reserve capacity improvement, transmission congestion relief, load following and time of use. In essence, this technology allows renewable energy to enter the base load and peak power generation market and therefore can compete directly with fossil fuel sources of power generation and offer a truly sustainable electricity supply option.
Footprint	: Approximately 1 ha
Connection type	: AC Connection on Grid

System Power	:	Up to 870 MWh
No. of batteries used	:	Variable, preferably containerized systems
Inverters used	:	Specific type will be chosen according to performance requirements of use cases
Height of BESS	:	Approximately 8m

2.3 PROPOSED WIND TURBINE

The wind energy market is fast changing and adapting to new technologies and site-specific constraints. Optimizing the technical specifications can add value through, for example, minimizing environmental impact and maximizing energy yield. As such the developer has been evaluating several wind turbine generator (WTG) models, however the selection will only be finalized at a later stage once a most optimal wind turbine is identified (factors such as meteorological data, price and financing options, guarantees and maintenance costs, etc. must be considered). The developer indicated that they are considering a number of different wind turbines, and may only commit to a final model at a later stage.

As the noise propagation modelling requires the details of a WTG, it was selected to use the sound power emission levels of the Acciona AW132/3.3 with a sound power emission level of 108.5 and 106.0 dBA (re 1 pW) at all wind speeds.

2.4 STUDY AREA

The proposed Highlands South WEF and associated infrastructure will be located in the Blue Crane Route Local Municipality and the Sarah Baartman District Municipality, Eastern Cape Province. The study area is further described in terms of environmental components that may contribute to or change the sound character in the area.

2.4.1 Topography

The terrain is described as “*Hills and Lowlands*”. Due to the height of the proposed wind turbines (i.e. the turbine hub height may be up to 180 m), it is unlikely that topographical features will limit the propagation of sound from the wind turbines.

2.4.2 Roads and rail roads

The R63 pass the project site to the north, though traffic on this road is low, especially at night. Traffic volumes are very low and it is not expected that existing traffic noises would be of any significance in this area.

2.4.3 Land use

Land use is mostly wilderness (ecotourism) with agricultural activities (game, sheep and cattle farming). Existing land use activities are not expected to impact on the ambient sound levels. As the night-time noise environment is of particular interest in this document, current land use activities are not expected to impact on the current ambient sound environment.

2.4.4 Residential areas

Excluding potentially Noise-Sensitive Developments (NSD) identified, there is no formal residential area close (within 2,000 m) to the proposed development.

2.4.5 Ground conditions and vegetation

Most of the area falls within the Savanna (Subarid Thorn Bushveld) and Thicket (Valley Thicket) biomes. Most of the area is vegetated with low trees, shrubs and grasses being the main ground cover. Considering a worst-case scenario, 75% hard ground conditions were used for modelling purposes. It should be noted that this factor is only relevant for air-borne waves being reflected from the ground surface, with certain frequencies slightly absorbed by the vegetation.

2.4.6 Existing Ambient Sound Levels

Ambient sound levels were measured by AJ Rens (Oswald Professional Engineers) and reported by Reid (2018). This data is augmented by measurements collected over a 2-night period in the vicinity during June 2020 by the Author for a different WEF. Based on the experience gained during the site visits, the area has a rural developmental character with a potential to be quiet during low wind conditions. Ambient sound levels do increase as wind speeds increase, as discussed further in this report (see also **section 4.2**).

2.5 NOISE-SENSITIVE DEVELOPMENTS

Potential Noise Sensitive Areas (NSAs) were initially identified in the Noise Study done for the project by Reid (2018), supported by a site visit by AJ Rens of Oswald Professional Engineers. The noise-sensitive areas as identified in the 2018 study is depicted in **Figure 2-1** (together with the original WTG layout).

Considering the proposed amended layout, the previously identified NSAs, the latest aerial images as well as the information from the Online Environmental Screening Tool the NSDs up to 2,000 m were identified. The NSDs as identified are highlighted in **Figure 2-2**, with the same figure also illustrating areas with a high noise sensitivity in terms of the National Web-based Environmental Screening Tool.

Also indicated on this figure are generalized 500 m, 1 000 m and 2 000 m buffer zones. Generally, normally, noises from wind turbines:

- Could be significant within 500 m, with receptors³ staying within 500 m from operational wind turbines subject to noises at a potentially sufficient level to be considered disturbing;
- Are normally limited to a distance of approximately 1,000m from operational wind turbines. Night-time ambient sound levels are elevated and the potential noise impact measurable;
- May be audible up to a distance of 2,000m at night; and
- Are of a low concern at distanced greater than 2,000m.

While some of the NSA (Reid, 2018) does correspond with the NSD identified for this assessment, there are differences as highlighted in **Table 2-2**.

Table 2-2: Original NSA labelling and NSD labeling differences

NSD (used in this report)	NSA Label (Reid, 2018)	Comment
1	4	Status undefined, assume residential
2	15	Status undefined, assume residential
3	15	Status undefined, assume residential
4	15	Status undefined, assume residential
5	6	Temporary use during hunting season
6	9	Status undefined, assume residential
7	8	Status undefined, assume residential
8	12	Reported unoccupied
9	13	Reported unoccupied
10	14	Currently used as residential dwelling
11	5	Status undefined, assume residential
12	5	Status undefined, assume residential
13	5	Status undefined, assume residential
-	1	Further than 2,000 m from closest WTG
-	2 & 3	Further than 2,000 m from closest WTG
-	7	Further than 2,000 m from closest WTG
-	10 & 11	Further than 2,000 m from closest WTG
	16, 17 & 18	Further than 2,000 m from closest WTG

The land owner (Highlands Trust represented by Mr. Brown) reported that the dwellings at NSDs 8 and 9 are not used for residential purposes.

³ Depending on the layout as well as the specific sound power emission levels of the selected wind turbine.

2.6 ENVIRONMENTAL SENSITIVITY – NOISE THEME

The project site was assessed in terms of the Noise Sensitivity Theme using the National Web-based Environmental Screening Tool⁴. The noise sensitive areas as obtained from the online Screening Tool is presented on **Figure 2-2**, highlighting a number of areas with a high noise sensitivity.

2.7 COMMENTS PREVIOUSLY RECEIVED

A number of noise-related comments were raised during the original Basic Assessment (BA) process. These comments were comprehensively addressed in the Comments and Responses Report⁵ (CRR) done for the BA process. These comments will not be revisited in this document and the readers are referred to the CRR.

2.8 LEGISLATIVE REQUIREMENTS AND TERMS OF REFERENCE

A noise impact assessment must be conducted if the proposed development triggers the following:

- A change in land use as highlighted in SANS 10328:2008, section 3.3;
- If a wind farm (wind turbines - SANS 10328:2008 [5.4 (i)]) or a source of low-frequency noise (such as cooling or ventilation fans - SANS 10328:2008 [5.4 (l)]) is to be established within 2,000 m from a potential NSD *or visa versa*;
- It is generally required by the local or district authority as part of the environmental authorization or planning approval in terms of Regulation 2(d) or GN R154 of 1992;
- It is a controlled activity in terms of the NEMA EIA Regulations, 2014, as amended and an ENIA is required, because:
 - It may cause a disturbing noise that is prohibited in terms of section 18(1) of the Government Notice 579 of 2010;
 - It is an environmental theme to be further assessed as identified by the National Web-based Environmental Screening Tool as required by Government Gazette No. 42451 of 10 May 2019 (proposed procedures for noise assessments);

2.8.1 Requirements as per GG 43110

The Department of Forestry, Fisheries and the Environment (DFFE) also promulgated Regulation 320, dated 20 March 2020 as published in Government Gazette No. 43110. The

⁴ <https://screening.environment.gov.za/screeningtool/#/pages/welcome>

⁵ Arcus, 2019: "Volume III – Highlands South Wind Energy Facility – Basic Assessment Process – Revised – Comments and Responses Report, November 2019". Arcus Consultancy Services South Africa (Pty) Limited, Cape Town

Procedures for the Assessment and Minimum Criteria for Reporting on Identified Environmental Themes in Terms of Sections 24(5)(a) and (h) and 44 of the National Environmental Management Act, 1998, when applying for Environmental Authorisation would be applicable to this project.

This regulation defines the requirements for undertaking a site sensitivity verification, specialist assessment and the minimum report content requirements for environmental impact where a specialist assessment is required but no protocol has been prescribed. It requires that the current land use be considered using the national web based environmental screening tool to confirm the site sensitivity available at: <https://screening.environment.gov.za>.

If an applicant intending to undertake an activity identified in the scope of this protocol for which a specialist assessment has been identified on the screening tool on a site identified as being of:

- "very high" sensitivity for noise, must submit a Noise Specialist Assessment; or
- "low" sensitivity for noise, must submit a Noise Compliance Statement.

On a site where the information gathered from the site sensitivity verification differs from the designation of "very high" sensitivity on the screening tool and it is found to be of a "low" sensitivity, a Noise Compliance Statement must be submitted. On a site where the information gathered from the initial site sensitivity verification differs from the designation of "low" sensitivity on the screening tool and it is found to be of a "very high" sensitivity, a Noise Specialist Assessment must be submitted.

If any part of the proposed development footprint falls within an area of "very high" sensitivity, the assessment and reporting requirements prescribed for the "very high" sensitivity apply to the entire footprint excluding linear activities for which noise impacts are associated with construction activities only and the noise levels return to the current levels after the completion of construction activities, in which case a compliance statement applies. In the context of this protocol, development footprint means the area on which the proposed development will take place and includes any area that will be disturbed.

The minimum requirements for a Noise Impact Assessment are also covered in **Section 1** in the form of a checklist.

2.8.2 Requirements as per South African National Standards

In South Africa the document that addresses the issues specifically concerning environmental noise is SANS 10103:2008. It has been revised extensively in 2008 and

brought in line with the guidelines of the World Health Organization (WHO). It provides the maximum average ambient noise levels during the day and night to which different types of developments may be exposed indoors.

The SANS 10328:2008 specifies the methodology to assess the potential noise impacts on the environment due to a proposed activity that might impact on the environment. This standard also stipulates the minimum requirements to be investigated for Environmental Impact Assessment (EIA) purposes. These minimum requirements are:

1. The purpose of the investigation;
2. A brief description of the planned development or the changes that are being considered;
3. A brief description of the existing environment;
4. The identification of the noise sources that may affect the particular development, together with their respective estimated sound pressure levels or sound power levels (or both);
5. The identified noise sources that were not taken into account and the reasons why they were not investigated;
6. The identified noise-sensitive developments and the estimated impact on them;
7. Any assumptions made with regard to the estimated values used;
8. An explanation, either by a brief description or by reference, of the methods that were used to estimate the existing and predicted rating levels;
9. The location of the measurement or calculation points, i.e. a description, sketch or map;
10. Estimation of the environmental noise impact;
11. Alternatives that were considered and the results of those that were investigated;
12. A list of all the interested or affected parties that offered any comments with respect to the environmental noise impact investigation;
13. A detailed summary of all the comments received from interested or affected parties as well as the procedures and discussions followed to deal with them;
14. Conclusions that were reached;
15. Recommendations, i.e. if there could be a significant impact, or if more information is needed, a recommendation that an environmental noise impact assessment be conducted, and
16. If remedial measures will provide an acceptable solution which would prevent a significant impact, these remedial measures should be outlined in detail and included in the final record of decision if the approval is obtained from the relevant authority. If the remedial measures deteriorate after time and a follow-up auditing or maintenance programme (or both) is instituted, this programme should be included

in the final recommendations and accepted in the record of decision if the approval is obtained from the relevant authority.

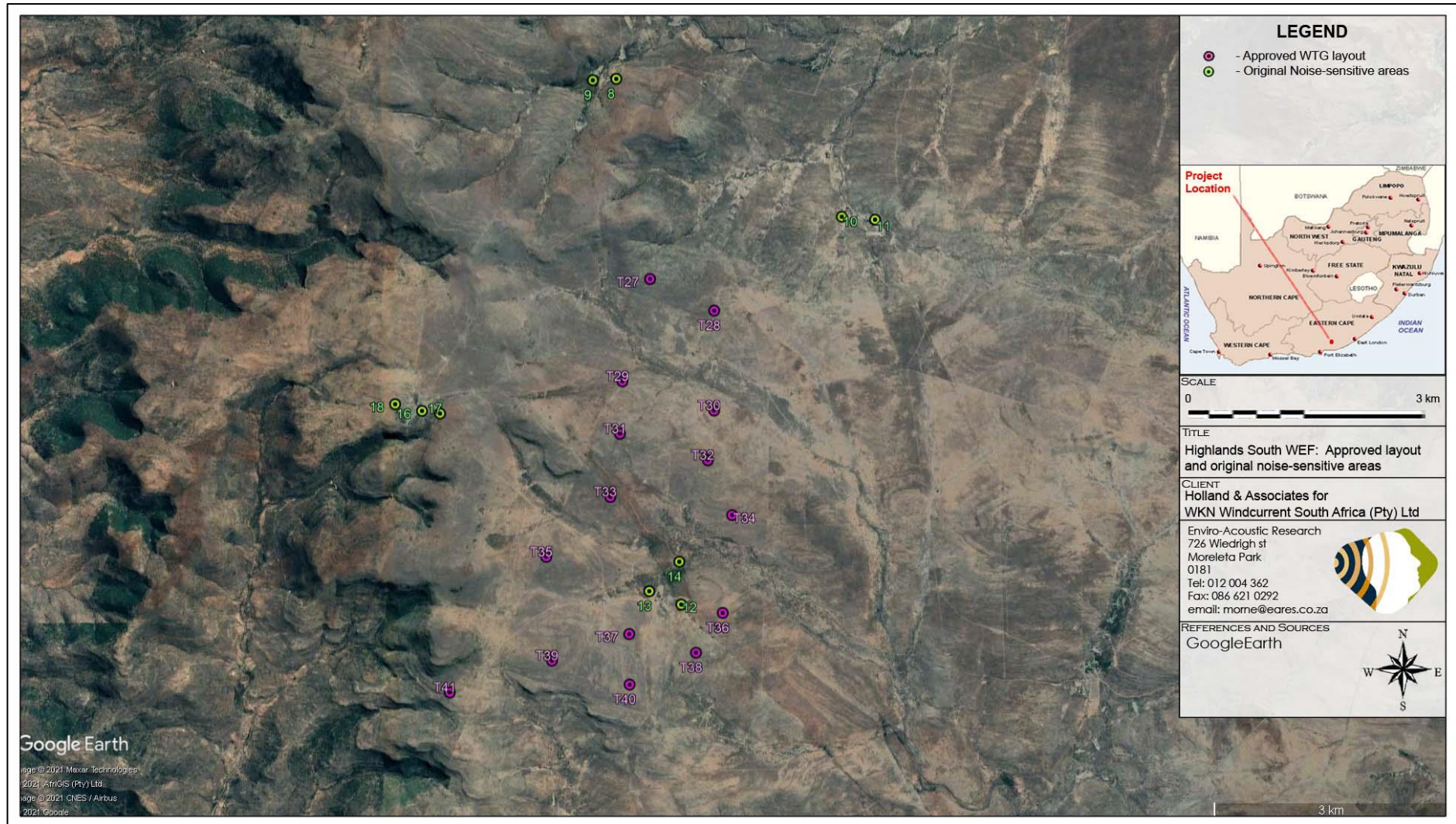

Figure 2-1: Aerial Image indicating original WTG layout and Noise-sensitive areas as assessed in the 2018 study

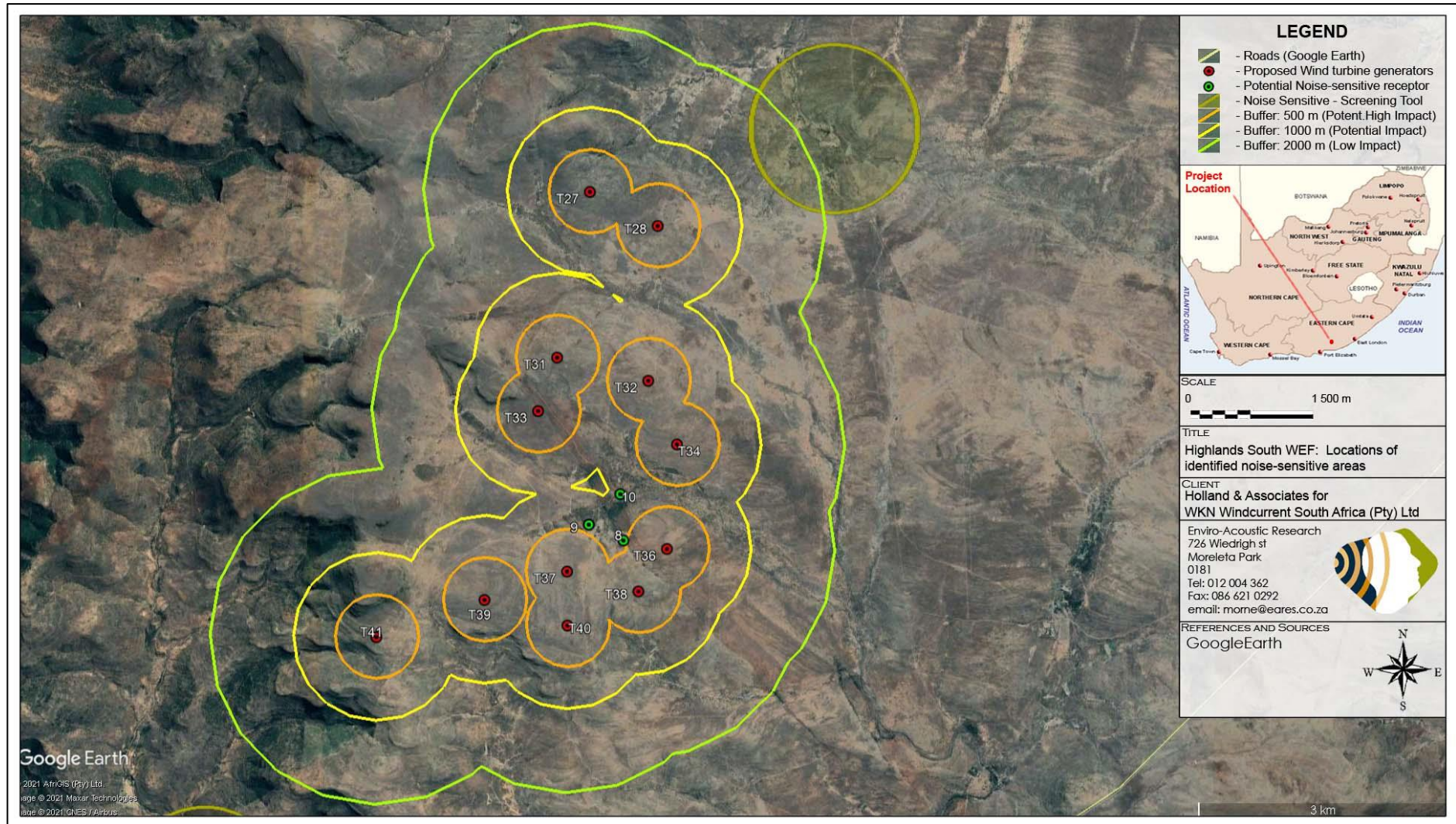

Figure 2-2: Proposed amended layout: Aerial Image indicating site sensitivity and closest identified Noise-sensitive developments

3 POLICIES AND THE LEGAL CONTEXT

3.1 THE REPUBLIC OF SOUTH AFRICA CONSTITUTION ACT (“THE CONSTITUTION”)

The environmental right contained in section 24 of the Constitution provides that everyone is entitled to an environment that is not harmful to his or her well-being. In the context of noise, this requires a determination of what level of noise is harmful to the well-being of humans. The general approach of the common law is to define an acceptable level of noise as that which the reasonable person can be expected to tolerate in the particular circumstances. The subjectivity of this approach can be problematic; however, this has led to the development of noise standards (see **Section 3.4**).

“Noise pollution” is specifically included in Part B of Schedule 5 of the Constitution, which means that noise pollution control is a local authority competence, provided that the local authority concerned has the capacity to carry out this function.

3.2 THE NATIONAL ENVIRONMENTAL MANAGEMENT ACT, 1998 (ACT 107 OF 1998)

The National Environmental Management Act, 1998 (Act 107 of 1998), as amended (“NEMA”) defines “pollution” to include any change in the environment, including noise. A duty therefore arises under section 28 of NEMA to take reasonable measures while establishing and operating any facility to prevent noise pollution occurring. NEMA sets out measures, which may be regarded as reasonable. They include the following measures to:

1. investigate, assess and evaluate the impact on the environment;
2. inform and educate employees about the environmental risks of their work and the manner in which their tasks must be performed to avoid causing significant pollution or degradation of the environment;
3. cease, modify or control any act, activity or process causing the pollution or degradation;
4. contain or prevent the movement of the pollution or degradation;
5. eliminate any source of the pollution or degradation; and
6. remedy the effects of the pollution or degradation.

Regulations have been promulgated in GN R982, R983, R984 and R985 in GG 38282, dated 4 December 2014, which came into effect on 8 December 2014. These were amended in April 2017, specifically promulgated in GN R326, R327, R325 and R324 in GG 40772, dated 7 April 2017.

Furthermore, Protocols were published in Government Gazette 43110 / GNR 320 on 20 March 2020 for specific environmental themes, including noise. "Requirements for the assessment and minimum criteria for reporting on identified environmental themes in terms of sections 24(5)(a) and (h) and 44 of the National Environmental Management Act, 1998, when applying for Environmental Authorisation". These Protocols prescribe the general requirements for undertaking site sensitivity verification and the level of specialist assessment required as well as the assessment reporting requirements per environmental theme. The requirements of the Noise Protocol for the undertaking of a Noise Specialist Assessment has been adhered to. The national web-based Environmental Screening Tool identified the site to be of high noise sensitivity and therefore full Noise Specialist Assessment has been undertaken.

When the requirements of a protocol apply, the requirements of Appendix 6 of the Environmental Impact Assessment Regulations, as amended, (EIA Regulations), promulgated under sections 24(5) and 44 of the National Environmental Management Act, 1998 (Act No. 107 of 1998), are replaced by the requirements of GNR 320.

3.3 THE ENVIRONMENT CONSERVATION ACT, 1989 (ACT 73 OF 1989)

The Environment Conservation Act, 1989 (Act 73 of 1989) ("ECA") allowed the Minister of Environmental Affairs and Tourism to make regulations regarding noise, among other concerns. The Minister has implemented Noise Control Regulations under the ECA as discussed below.

3.3.1 Noise Control Regulations (GN R154 of 1992)

In terms of section 25 of the ECA, the national Noise Control Regulations (GN R154 in *Government Gazette* No. 13717 dated 10 January 1992) (NCRs) were promulgated. The NCRs were revised under Government Notice No. R. 55 of 14 January 1994 to make it obligatory for all authorities to apply the regulations.

The NCRs (GN R154 1992) defines:

"controlled area" as:

a piece of land designated by a local authority where, in the case of--

- c) industrial noise in the vicinity of an industry-
 - i. the reading on an integrating impulse sound level meter, taken outdoors at the end of a period of 24 hours while such meter is in operation, exceeds 61 dBA; or
 - ii. the calculated outdoor equivalent continuous "A"-weighted sound pressure level at a height of at least 1,2 meters, but not more than 1,4 meters, above the ground for a period of 24 hours, exceeds 61 dBA;

"disturbing noise" as:

noise level which exceeds the zone sound level or, if no zone sound level has been designated, a noise level which exceeds the ambient sound level at the same measuring point by 7 dBA or more.

"zone sound level" as:

a derived dBA value determined indirectly by means of a series of measurements, calculations or table readings and designated by a local authority for an area. *This is the same as the Rating Level as defined in SANS 10103.*

In addition:

In terms of Regulation 2 -

"A local authority may –

(c): if a noise emanating from a building, premises, vehicle, recreational vehicle or street is a disturbing noise or noise nuisance, or may in the opinion of the local authority concerned be a disturbing noise or noise nuisance, instruct in writing the person causing such noise or who is responsible therefor, or the owner or occupant of such building or premises from which or from where such noise emanates or may emanate, or all such persons, to discontinue or cause to be discontinued such noise, or to take steps to lower the level of the noise to a level conforming to the requirements of these Regulations within the period stipulated in the instruction: Provided that the provisions of this paragraph shall not apply in respect of a disturbing noise or noise nuisance caused by rail vehicles or aircraft which are not used as recreational vehicles;

(d): before changes are made to existing facilities or existing uses of land or buildings, or before new buildings are erected, in writing require that noise impact assessments or tests are conducted to the satisfaction of that local authority by the owner, developer, tenant or occupant of the facilities, land or buildings or that, for the purposes of regulation 3(b) or (c), reports or certificates in relation to the noise impact to the satisfaction of that local authority are submitted by the owner, developer, tenant or occupant to the local authority on written demand";

In terms of Regulation 4 of the Noise Control Regulations:

"No person shall make, produce or cause a disturbing noise, or allow it to be made, produced or caused by any person, machine, device or apparatus or any combination thereof".

3.4 NOISE STANDARDS

There are a few South African scientific standards (SABS) relevant to noise from developments, industry and roads. They are:

- SANS 10103:2008. 'The measurement and rating of environmental noise with respect to annoyance and to speech communication'.
- SANS 10210:2004. 'Calculating and predicting road traffic noise'.
- SANS 10328:2008. 'Methods for environmental noise impact assessments'.
- SANS 10357:2004. 'The calculation of sound propagation by the Concave method'.
- SANS 10181:2003. 'The Measurement of Noise Emitted by Road Vehicles when Stationary'.
- SANS 10205:2003. 'The Measurement of Noise Emitted by Motor Vehicles in Motion'.

The relevant standards use the equivalent continuous rating level as a basis for determining what is acceptable. The levels may take single event noise into account, but single event noise by itself does not determine whether noise levels are acceptable for land use purposes. With regards to SANS 10103:2008, the recommendations are likely to inform decisions by authorities, but non-compliance with the standard will not necessarily render an activity unlawful *per se*.

3.5 STRATEGIC ENVIRONMENTAL ASSESSMENT FOR WIND ENERGY FACILITIES IN SOUTH AFRICA

Studies completed by the CSIR (2015 and 2019) identified 11 Renewable Energy Development Zones (REDZs) that are of strategic importance for large scale wind and solar photovoltaic development. It allows the DFFE to utilise provisions in the NEMA to streamline environmental authorisation processes in pre-assessed geographical areas.

The CSIR report used anticipated noise levels to determine sensitivity buffers, using this to assess the potential significance of noise impact as summarised in **Table 3-1** (guideline values that has not been gazetted).

Table 3-1: Interpretation of noise sensitivity and assessment requirements

Sensitivity	Interpretation	Assessment requirements
Within 300 m of temporarily or permanently inhabited residence Very High	High likelihood for significant negative impacts that cannot be mitigated. Expected noise level of 45 dBA or more.	Proponents intending to develop a wind facility that triggers an environmental assessment process in very high to medium sensitivity areas (i.e. within 1 km of a permanent or temporarily inhabited residence as a receptor) must prove to the relevant competent authority that the proposed development will not have
300 and 500 m from temporarily or permanently inhabited residence.	High potential for negative impacts that can potentially be mitigated. Expected noise level of between 45	

High	and 40 dBA, 5 to 10 dBA increase in ambient noise level.	an unacceptable negative impact on a receptor. In order to do so, a comprehensive Noise Impact Assessment undertaken by a competent noise specialist, and in accordance with the National Environmental Management Act (NEMA) regulations pertaining to specialist reports and impact assessment, is required.
500 and 1000 m from temporarily or permanently inhabited residence. Medium	Potential for negative impacts, and if there are impacts there is a high likelihood of mitigation. Expected noise level of between 35 and 40 dBA, 0 to 5 dBA increase in ambient noise level.	
Further than 1000 m from temporarily or permanently inhabited residence. Low	Expected noise level of less than 35 dBA resulting from a wind turbine at more than 1,000 m from the turbine, there are likely to be no noise impacts.	No assessment or authorisation for wind development in terms of noise impacts is required if the proposed development is further than 1 km from any temporarily or permanently inhabited residence.

3.6 INTERNATIONAL GUIDELINES

While there exists a number of international guidelines and standards that could encompass a document in itself, the three mentioned below were selected as they are used by different countries in the subject of environmental noise management, with the last two documents specifically focussing on the noises associated by WEFs.

3.6.1 Guidelines for Community Noise (World Health Organization, 1999)

The World Health Organization's (WHO) document on the *Guidelines for Community Noise* is the outcome of the WHO- expert task force meeting held in London, United Kingdom, in April 1999. It is based on the document entitled "Community Noise" that was prepared for the WHO and published in 1995 by the Stockholm University and Karolinska Institute.

The scope of the WHO's effort to derive guidelines for community noise is to consolidate actual scientific knowledge on the health impacts of community noise and to provide guidance to environmental health authorities and professionals trying to protect people from the harmful effects of noise in non-industrial environments.

Guidance on the health effects of noise exposure of the population has already been given in an early publication of the series of Environmental Health Criteria. The health risk to humans from exposure to environmental noise was evaluated and guidelines values derived. The issue of noise control and health protection was briefly addressed.

The document uses the L_{Aeq} and $L_{A,max}$ descriptors to define noise levels. This document was important in the development of the SANS 10103 standard.

3.6.2 The Assessment and Rating of Noise from Wind Farms (Energy Technology Support Unit, 1997)

This report describes the findings of a Working Group on Wind Turbine Noise, facilitated by the United Kingdom Department of Trade and Industry. It was developed as an Energy

Technology Support Unit⁶ (ETSU) project. The aim of the project was to provide information and advice to developers and planners on noise from wind turbines. The report represents the consensus view of a number of experts (experienced in assessing and controlling the environmental impact of noise from wind farms). Their findings can be summarised as follow:

1. Absolute noise limits applied at all wind speeds are not suited to wind farms; limits set relative to the background noise (including wind as seen in **Figure 4-4**) are more appropriate;
2. $LA_{90,10min}$ is a much more accurate descriptor when monitoring ambient and turbine noise levels;
3. The effects of other wind turbines in a given area should be added to the effect of any proposed WEF, to calculate the cumulative effect;
4. Noise from a WEF should be restricted to no more than 5 dBA above the current ambient noise level at a NSD. Ambient noise levels are measured onsite in terms of the $LA_{90,10min}$ descriptor for a period sufficiently long enough for a set period;
5. Wind farms should be limited within the range of 35 dBA to 40 dBA (day-time) in a low noise environment. A fixed limit of 43 dBA should be implemented during all night time noise environments. This should increase to 45 dBA (day and night) if the NSD has financial investments in the WEF; and
6. A penalty system should be implemented for wind turbine/s that operates with a tonal characteristic.

This is likely the guideline used in the most international countries to estimate the potential noise impact stemming from the operation of a WEF. It also recommends an improved methodology (compared to a fixed upper noise level) on determining ambient sound levels in periods of higher wind speeds, critical for the development of a wind energy facility. Because of its international importance, the methodologies used in the ETSU R97 document will be recommended in this report for implementation should projected noise levels (from the proposed WEF at NSDs) exceed the zone sound levels as recommended by SANS 10103:2008.

⁶ ETSU was set up in 1974 as an agency by the United Kingdom Atomic Energy Authority to manage research programmes on renewable energy and energy conservation. The majority of projects managed by ETSU were carried out by external organizations in academia and industry. In 1996, ETSU became part of AEA Technology plc which was separated from the UKAEA by privatisation.

3.6.3 Noise Guidelines for Wind Farms (MoE, 2008)

This document establishes the sound level limits for land-based wind power generating facilities and describes the information required for noise assessments and submissions under the ECA and the Environmental Protection Act, Canada.

The document defines:

- Sound Level Limits for different areas (similar to rural and urban areas), defining limits for different wind speeds at 10 m height, refer also **Table 3-2**⁷
- The Noise Assessment Report, including:
 - Information that must be part of the report;
 - Full description of noise sources;
 - Adjustments, due to the wind speed profile (wind shear);
 - The identification and defining of potential sensitive receptors;
 - Prediction methods to be used (ISO 9613-2);
 - Cumulative impact assessment requirements;
 - It also defines specific model input parameters;
 - Methods on how the results must be presented; and
 - Assessment of Compliance (defining magnitude of noise levels).

Table 3-2: Summary of Sound Level Limits for Wind Farms (MoE)

Wind speed (m/s) at 10 m height	4	5	6	7	8	9	10
Wind Turbine Sound Level Limits, Class 3 Area, dBA	40	40	40	43	45	49	51
Wind Turbine Sound Level Limits, Class 1 & 2 Areas, dBA	45	45	45	45	45	49	51

The document used the $L_{Aeq,1h}$ noise descriptor to define noise levels.

It should be noted that these Sound Level Limits are included for the reader to illustrate the criteria used internationally. Due to the lack of local regulations specifically relevant to WEFs this criterion will also be considered during the determination of the significance of the noise impact.

3.6.4 Equator Principles

The **Equator Principles** (EPs) are a voluntary set of standards for determining, assessing and managing social and environmental risk in project financing. Equator Principles Financial Institutions (EPFIs) commit to not providing loans to projects where the borrower

⁷The measurement of wind induced background sound level is not required to establish the applicable limit. The wind induced background sound level reference curve was determined by correlating the A-weighted ninetieth percentile sound level (L90) with the average wind speed measured at a particularly quiet site. The applicable Leq sound level limits at higher wind speeds are given by adding 7 dB to the wind induced background L90 sound level reference values

will not or is unable to comply with their respective social and environmental policies and procedures that implement the EPs.

The EPs were developed by private sector banks and were launched in June 2003. The banks chose to model the EPs on the environmental standards of the World Bank and the social policies of the International Finance Corporation (IFC). Sixty-seven (67) financial institutions (October 2009) have adopted the EPs, which have become the de facto standard for banks and investors on how to assess major development projects around the world. The environmental standards of the World Bank have been integrated into the social policies of the IFC since April 2007 as the IFC Environmental, Health and Safety (EHS) Guidelines.

3.6.5 IFC: General EHS Guidelines – Environmental Noise Management

These guidelines are applicable to noise created beyond the property boundaries of a development that conforms to the EPs.

It states that noise prevention and mitigation measures should be applied where predicted or measured noise impacts from a project facility or operations exceed the applicable noise level guideline at the most sensitive point of reception. The preferred method for controlling noise from stationary sources is to implement noise control measures at the source.

It goes as far as to propose methods for the prevention and control of noise emissions, including:

- Selecting equipment with lower sound power levels;
- Installing silencers for fans;
- Installing suitable mufflers on engine exhausts and compressor components;
- Installing acoustic enclosures for equipment casing radiating noise;
- Improving the acoustic performance of constructed buildings, apply sound insulation;
- Installing acoustic barriers without gaps and with a continuous minimum surface density of 10 kg/m² in order to minimize the transmission of sound through the barrier. Barriers should be located as close to the source or to the receptor location to be effective;
- Installing vibration isolation for mechanical equipment;
- Limiting the hours of operation for specific pieces of equipment or operations, especially mobile sources operating through community areas;
- Re-locating noise sources to less sensitive areas to take advantage of distance and shielding;
- Placement of permanent facilities away from community areas if possible;
- Taking advantage of the natural topography as a noise buffer during facility design;
- Reducing project traffic routing through community areas wherever possible;

- Planning flight routes, timing and altitude for aircraft (airplane and helicopter) flying over community areas; and
- Developing a mechanism to record and respond to complaints.

It sets noise level guidelines (see **Table 3-3**) as well as highlighting the certain monitoring requirements pre- and post-development.

Table 3-3: IFC Table 7.1-Noise Level Guidelines

Receptor type	One hour L_{Aeq} (dBA)	
	Daytime 07:00 - 22:00	Night-time 22:00 - 07:00
Residential; institutional; educational	55	45
Industrial; commercial	70	70

The document uses the $L_{Aeq,1\text{ hr}}$ noise descriptors to define noise levels. It does not determine the detection period, but refers to the International Electrotechnical Commission (IEC) Standards, which require the fast detector setting on the Sound Level Meter during measurements for Europe.

3.6.6 Environmental Noise Guidelines for the European Region (2018)

This document identifies levels at which noise has significant health impacts and recommends actions to reduce exposure. Compared to previous WHO guidelines on noise, this version contains five significant developments:

- Stronger evidence of the cardiovascular and metabolic effects of environmental noise;
- Inclusion of new noise sources, namely wind turbine noise and leisure noise, in addition to noise from transportation (aircraft, rail, and road traffic);
- Use of a standardized approach to assess the evidence;
- A systematic review of evidence, defining the relationship between noise exposure and risk of adverse health outcomes;
- Use of long-term average noise exposure indicators to better predict adverse health outcomes.

For average noise exposure, the WHO (2018) guideline recommends noise levels produced by wind turbines below 45 dB (Equivalent Day-Night Level), as wind turbine noise above this level is associated with adverse health effects.

3.6.7 European Parliament Directive 200/14/EC (2000)

Directive 2000/14/EC relating to the noise emission in the environment by equipment for use outdoors was adopted by the European Parliament and the Council and first published in May 2000 and applied from January, 2002. The directive placed sound power limits on equipment to be used outdoors in a suburban or urban setting. Failure to comply with these regulations may result in products being prohibited from being placed on the EU market. Equipment list is vast and includes machinery such as compaction machineries, dozers, dumpers excavators etc. Manufacturers as a result started to consider noise emission levels from their products to ensure that their equipment will continue to have a market in most countries.

4 ENVIRONMENTAL SOUND CHARACTER

4.1 INFLUENCE OF SEASON ON AMBIENT SOUND LEVELS

Natural sounds are a part of the environmental noise surrounding humans. In rural areas the sounds from insects and birds would dominate the ambient sound character, with noises such as wind flowing through vegetation increasing as wind speed increase. Work by Fégeant (2002) stressed the importance of wind speed and turbulence causing variations in the level of vegetation generated noise. In addition, factors such as the season (e.g. dry or no leaves versus green leaves), the type of vegetation (e.g. grass, conifers, deciduous), the vegetation density and the total vegetation surface all determine both the sound level as well as spectral characteristics.

Ambient sound levels are significantly affected by the area where the sound measurement location (or a listener) is situated. When the sound measurement location is situated within an urban area, close to industrial plants or areas with a constant sound source (ocean, rivers, etc.), seasons and even increased wind speeds have an insignificant to massive impact on ambient sound levels.

Sound levels in undeveloped rural areas (away from occupied dwellings), however, are impacted by changes in season for a number of complex reasons. The two main reasons are:

- Faunal communication is more significant during the warmer spring and summer months as various species communicate in an effort to find mates. Faunal communication is normally less during the colder months.
- Seasonal changes in weather patterns, mainly due to increased wind speeds (also see **Sub Section 4.1.1** below) and potential gustiness of the wind.

For environmental noise, weather plays an important role, the greater the separation distance, the greater the influence of the weather conditions, so, from day to day, a road 1,000 m away can sound very loud or can be completely inaudible. Other, environmental factors that impact on sound propagation includes wind, temperature and humidity, as discussed in **Sub-sections 4.1.1** to **4.1.3** below.

4.1.1 Effect of Wind

Wind alters sound propagation by the mechanism of refraction, that is, wind bends sound waves. Wind nearer to the ground moves more slowly than wind at higher altitudes, due to surface characteristics such as hills, trees, and man-made structures that interfere with the wind. This wind gradient, with faster wind at higher elevation and slower wind at lower elevation, causes sound waves to bend downward when they are traveling to a location

downwind of the source and to bend upward when traveling toward a location upwind of the source. Waves bending downward means that a listener standing downwind of the source will hear louder noise levels than the listener standing upwind of the source. This phenomenon can significantly impact sound propagation over long distances and when wind speeds are high. Over short distances wind direction has a small impact on sound propagation as long as wind velocities are reasonably slow, i.e. less than 5 m/s.

Wind speed frequently plays a role in increasing sound levels in natural locations. With no wind, there is little vegetation movement that could generate noises and faunal noises (normally birds and insects) dominate, however, as wind speeds increase, the rustling of leaves increases which subsequently can increase sound levels. This directly depends on the type of vegetation in a certain area. The impact of increased wind speed on sound levels depends on the vegetation type (deciduous versus conifers), the density of vegetation in an area, seasonal changes (in winter deciduous trees are bare) as well as the height of this vegetation. This excludes unanticipated consequences, as suitable vegetation may create suitable habitats and food sources attracting birds and insects (and the subsequent increase in faunal communication).

4.1.2 Effect of Temperature

On a typical sunny afternoon, the air is the hottest near the ground surface and temperature decreases at higher altitudes. This temperature gradient causes sound waves to refract upward, away from the ground and results in lower noise levels being heard at a measurement location. In the evening, this temperature gradient will reverse, resulting in cooler temperatures near the ground. This condition, often referred to is a temperature inversion will cause sound to bend downward towards the ground and results in louder noise levels at the listener position. Like wind gradients, temperature gradients can influence sound propagation over long distances and further complicate measurements. Generally sound propagate better at lower temperatures (down to 10°C), and with everything being equal, a decrease in temperature from 32°C to 10°C could increase the sound level at a listener 600 m away by ± 2.5 dB (at 1,000 Hz).

4.1.3 Effect of Humidity

The effect of humidity on sound propagation is quite complex, but effectively relates to how increased humidity changes the density of air. Lower density translates into faster sound wave travel, so sound waves travel faster at high humidity. With everything being equal, an increase in humidity from 20% to 80% would increase the sound level at a listener 600 m away by ± 4 dB (at 1,000 Hz at 20°C).

4.2 AMBIENT SOUND LEVELS

Ambient (background) noise levels were measured originally by AJ Rens in June 2018 (the measurement locations are depicted in **Figure 4-3**), with the data augmented with data collected in June 2020 (night-time illustrated in **Figure 4-4**) by the author for a different WEF project. Work was done in accordance with the South African National Standard SANS 10103:2008 "**The measurement and rating of environmental noise with respect to land use, health, annoyance and to speech communication**". The measurements done in June 2020 were completed as per the protocols defined in GG 43110.

The guidelines and protocol define the procedures, minimum equipment accuracy and time periods (in which measurements must be collected) such as:

- type of equipment (Class 1) to be used;
- minimum duration of measurement as well as time periods when measurements must take place;
- microphone positions and height above ground level;
- calibration procedures and instrument checks; and
- supplementary weather measurements and observations.

During both site visits, ambient sound levels were measured over at least 24-hour periods at a number of locations using class-1 Sound Level Meters (SLMs). The SLMs would measure "average" sound levels over 10-minute periods, save the data and start with a new 10-minute measurement till the instrument was stopped. The SLMs were referenced at 1,000 Hz directly before and after the measurements were taken. In all cases drift was less than 1.0 dBA.

Sound measurement data measured for this project in 2018 is summarized in **Table 4-1**, and illustrated in **Figure 4-1** and **Figure 4-4**.

Table 4-1: Residual Noise Levels measured onsite

Location	Residual Noise Levels, Day, Leq,16hr, dBA	Residual Noise Levels, Night, Leq,16hr, dBA
ML1	44	36
ML2	49	29
ML3	46	42
ML4	56	48
Average	49	39

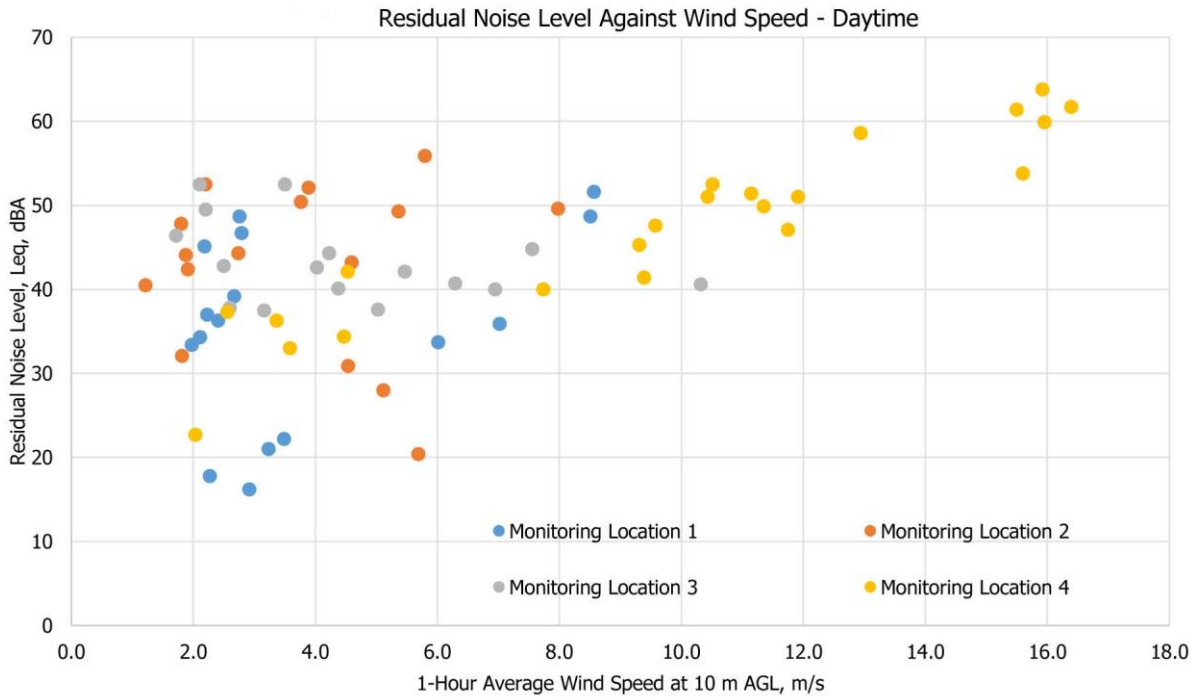

Figure 4-1: Residual Daytime Noise Level against wind speed

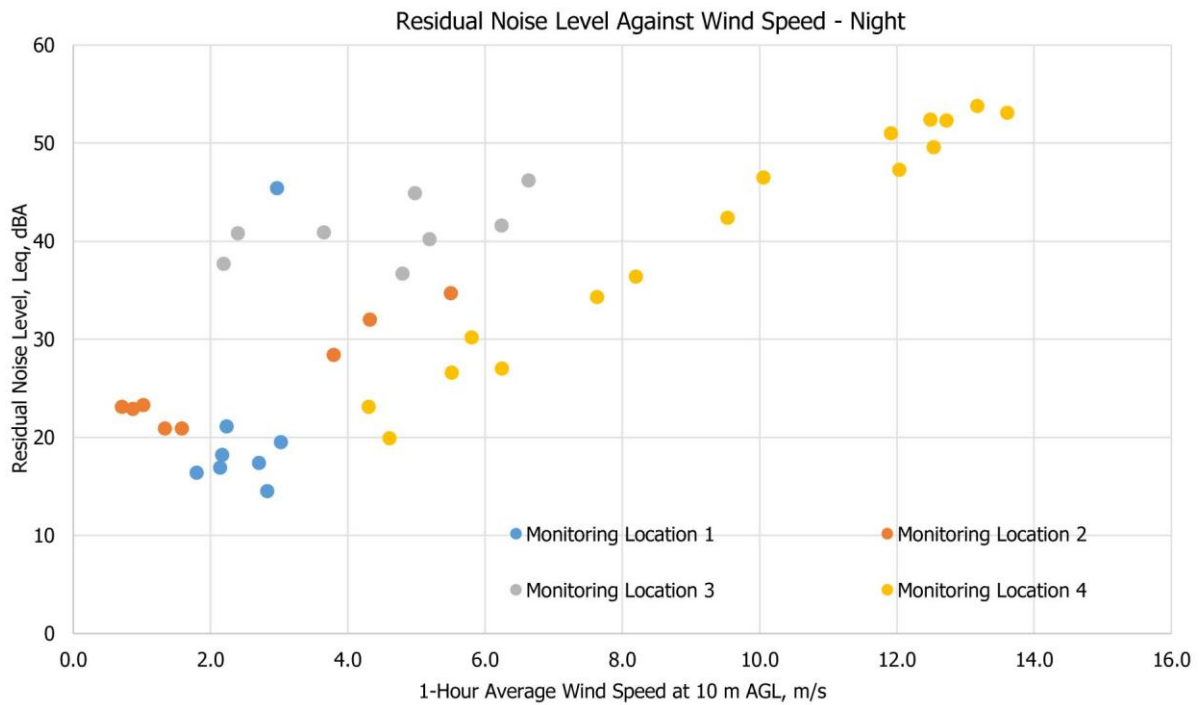

Figure 4-2: Residual Night-time Noise Level against wind speed

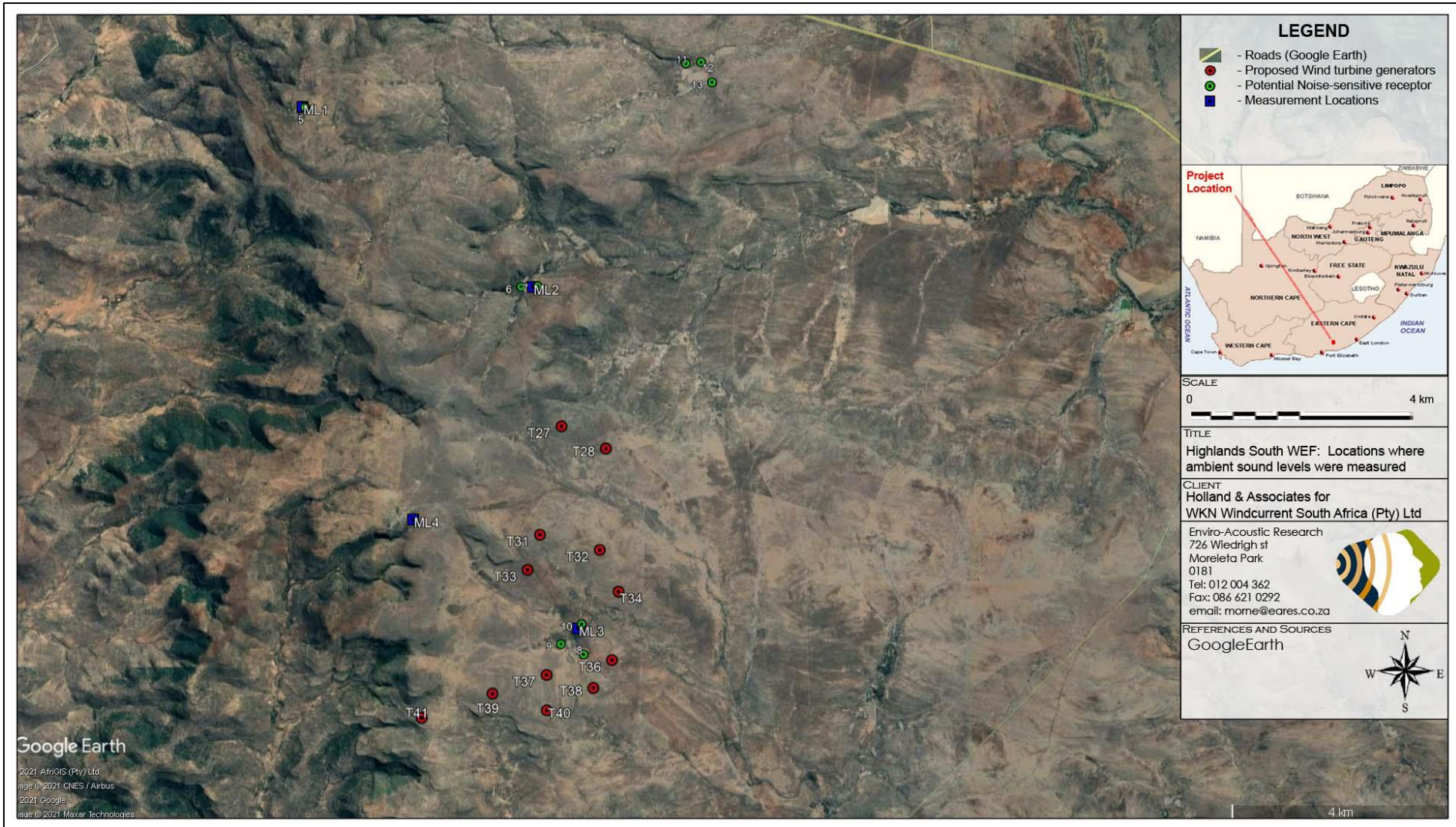

Figure 4-3: Localities where ambient sound levels were measured

Sound levels measured in June 2020 is depicted in **Figure 4-4**. The figure below presents approximately 3,000 10-minute measurements collected at other, similar locations (mainly Karoo), together with around 750 measurements collected in the vicinity of the project site during June 2020. With the night-time period being of a particular interest, only night-time data measured onsite is presented in the following figure.

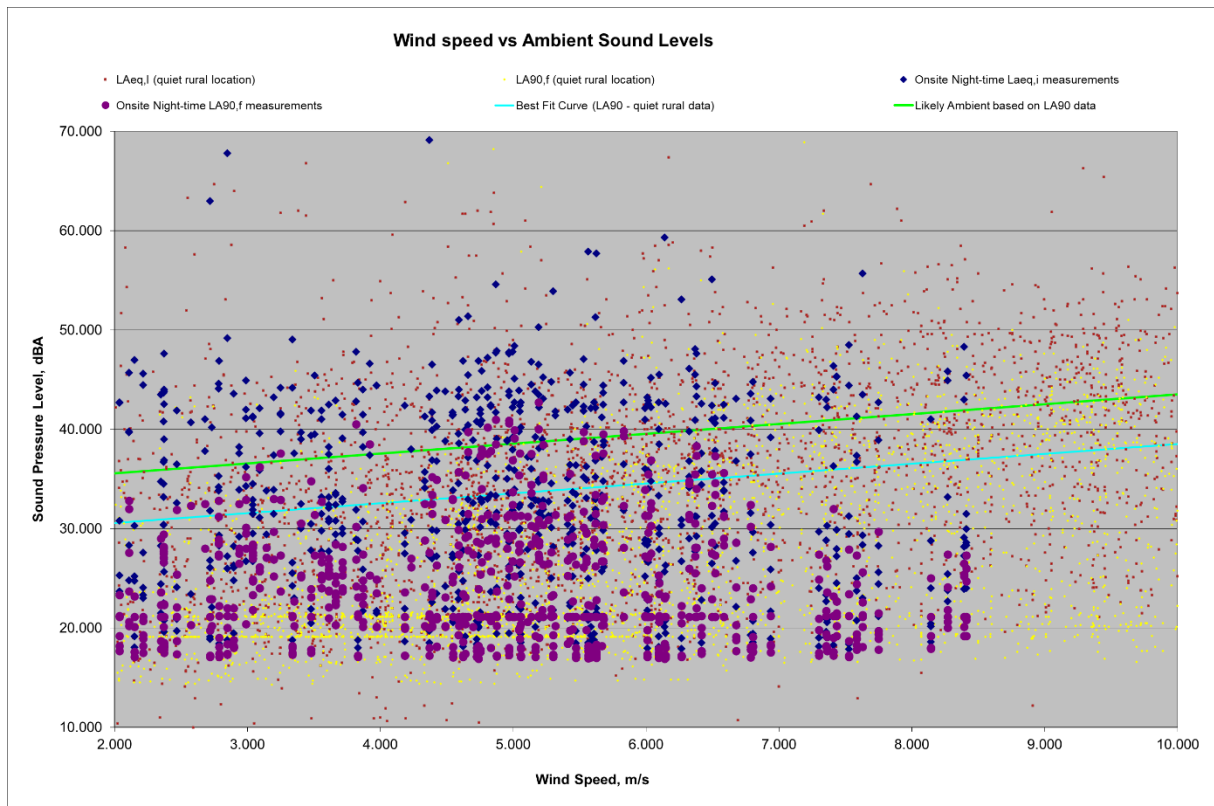

Figure 4-4: Ambient sound levels measured in vicinity of project

Considering the ambient sound levels and character of the area, ambient sound levels are generally low and typical of a rural noise district during low wind conditions (also see **Figure 4-4**). Considering measurements collected over the past decade at numerous locations during different seasons, ambient sound levels will likely increase as wind speeds increase, as illustrated in **Figure 4-4**.

5 POTENTIAL NOISE SOURCES

Increased noise levels are directly linked with the various activities associated with the construction and operational phases of the project. While the construction activities are generally of a short duration, the proposed WEF would be designed to have an operational life of up to 25 years. Upgrades and maintenance could further expand the lifetime of the WEF.

5.1 POTENTIAL NOISE SOURCES: CONSTRUCTION PHASE

5.1.1 Construction equipment

It is estimated that construction will take approximately 18 - 24 months, subject to the final design of the WEF, weather and ground conditions, including time for testing and commissioning. The construction process will consist of the following principal activities:

- Site survey and preparation;
- Establishment of site entrance, internal access roads, contractors' compound and passing places;
- Civil works to sections of the public roads to facilitate with turbine delivery;
- Site preparation activities will include clearance of vegetation at the footprint of each turbine as well as crane hard-standing areas. These activities will require the stripping of topsoil which will need to be stockpiled, backfilled and/or spread on site;
- Construct foundations – due to the volume of concrete that will be required, an on-site batching plant will be required to ensure a continuous concreting operation. The source of aggregate is yet undefined but is expected to be derived from an offsite source or brought in as ready-mix. If the stones removed during the digging of foundations are suitable as an aggregate this can be used as the aggregate in the concrete mix.
- Transport of components & equipment to site – all components will be brought to site in sections by means of flatbed trucks. Additionally, components of various specialized construction and lifting equipment are required on site to erect the wind turbines and will need to be transported to site. The typical civil engineering construction equipment will need to be brought to the site for the civil works (e.g. excavators, trucks, graders, compaction equipment, cement trucks, etc.). The transportation of ready-mix concrete to site or the materials for onsite concrete batching will result in a temporary increase in heavy traffic;
- Establishment of laydown & hard standing areas - laydown areas will need to be established at each turbine position for the placement of wind turbine components. Laydown and storage areas will also be required to be established for the civil

engineering construction equipment which will be required on site. Hard standing areas will need to be established for operation of the cranes. Cranes of the size required to erect turbines are sensitive to differential movement during lifting operations and require a hard-standing area;

- Erect turbines - a crane will be used to lift the tower sections into place and then the nacelle will be placed onto the top of the assembled tower. The next step will be to assemble or partially assemble the rotor on the ground; it will then be lifted to the nacelle and bolted in place. A small crane will likely be needed for the assembly of the rotor while the large crane will be needed to put it in place;
- Construct substation - the underground cables carrying the generated power from the individual turbines will connect at the substation. The construction of the substation would require a site survey; site clearing and levelling (including the removal / cutting of rock outcrops) and construction of access road/s (where required); construction of a substation terrace and foundation; assembly, erection and installation of equipment (including transformers); connection of conductors to equipment; and rehabilitation of any disturbed areas and protection of erosion sensitive areas. Containerized BESS will be developed close to the substation;
- Establishment of ancillary infrastructure - A workshop as well as a contractor's equipment camp may be required. The establishment of these facilities/buildings will require the clearing of vegetation and levelling of the development site and the excavation of foundations prior to construction. A laydown area for building materials and equipment associated with these buildings will also be required; and
- Site rehabilitation - once construction is completed and all construction equipment are removed; the site will be rehabilitated where practical and reasonable.

There are a number of factors that determine the audibility as well as the potential of a noise impact on receptors. Maximum noises generated can be audible over a large distance, however, are generally of very short duration. If maximum noise levels however exceed 65 dBA at a receptor, or if it is clearly audible with a significant number of instances where the noise level exceeds the prevailing ambient sound level with more than 15 dB, the noise can increase annoyance levels and may ultimately result in noise complaints. Potential maximum noise levels generated by various construction equipment as well as the potential extent of these sounds are presented in **Table 5-1**.

Average or equivalent sound levels are another factor that impacts on the ambient sound levels and is the constant sound level that the receptor can experience. Typical sound power levels associated with various activities that may be found at a construction site is presented in **Table 5-2**.

Table 5-1: Potential maximum noise levels generated by construction equipment

Equipment Description ⁸	Impact Device?	Maximum Sound Power Levels (dBA)	Operational Noise Level at given distance considering potential maximum noise levels (Cumulative as well as the mitigatory effect of potential barriers or other mitigation not included – simple noise propagation modelling only considering distance) (dBA)											
			5 m	10 m	20 m	50 m	100 m	150 m	200 m	300 m	500 m	750 m	1000 m	2000 m
Auger Drill Rig	No	119.7	94.7	88.7	82.6	74.7	68.7	65.1	62.6	59.1	54.7	51.2	48.7	42.6
Backhoe	No	114.7	89.7	83.7	77.6	69.7	63.7	60.1	57.6	54.1	49.7	46.2	43.7	37.6
Chain Saw	No	119.7	94.7	88.7	82.6	74.7	68.7	65.1	62.6	59.1	54.7	51.2	48.7	42.6
Compactor (ground)	No	114.7	89.7	83.7	77.6	69.7	63.7	60.1	57.6	54.1	49.7	46.2	43.7	37.6
Compressor (air)	No	114.7	89.7	83.7	77.6	69.7	63.7	60.1	57.6	54.1	49.7	46.2	43.7	37.6
Concrete Batch Plant	No	117.7	92.7	86.7	80.6	72.7	66.7	63.1	60.6	57.1	52.7	49.2	46.7	40.6
Concrete Mixer Truck	No	119.7	94.7	88.7	82.6	74.7	68.7	65.1	62.6	59.1	54.7	51.2	48.7	42.6
Concrete Pump Truck	No	116.7	91.7	85.7	79.6	71.7	65.7	62.1	59.6	56.1	51.7	48.2	45.7	39.6
Concrete Saw	No	124.7	99.7	93.7	87.6	79.7	73.7	70.1	67.6	64.1	59.7	56.2	53.7	47.6
Crane	No	119.7	94.7	88.7	82.6	74.7	68.7	65.1	62.6	59.1	54.7	51.2	48.7	42.6
Dozer	No	119.7	94.7	88.7	82.6	74.7	68.7	65.1	62.6	59.1	54.7	51.2	48.7	42.6
Drill Rig Truck	No	118.7	93.7	87.7	81.6	73.7	67.7	64.1	61.6	58.1	53.7	50.2	47.7	41.6
Drum Mixer	No	114.7	89.7	83.7	77.6	69.7	63.7	60.1	57.6	54.1	49.7	46.2	43.7	37.6
Dump Truck	No	118.7	93.7	87.7	81.6	73.7	67.7	64.1	61.6	58.1	53.7	50.2	47.7	41.6
Excavator	No	119.7	94.7	88.7	82.6	74.7	68.7	65.1	62.6	59.1	54.7	51.2	48.7	42.6
Flat Bed Truck	No	118.7	93.7	87.7	81.6	73.7	67.7	64.1	61.6	58.1	53.7	50.2	47.7	41.6
Front End Loader	No	114.7	89.7	83.7	77.6	69.7	63.7	60.1	57.6	54.1	49.7	46.2	43.7	37.6
Generator	No	116.7	91.7	85.7	79.6	71.7	65.7	62.1	59.6	56.1	51.7	48.2	45.7	39.6
Generator (<25KVA)	No	104.7	79.7	73.7	67.6	59.7	53.7	50.1	47.6	44.1	39.7	36.2	33.7	27.6
Grader	No	119.7	94.7	88.7	82.6	74.7	68.7	65.1	62.6	59.1	54.7	51.2	48.7	42.6
Impact Pile Driver	Yes	129.7	104.7	98.7	92.6	84.7	78.7	75.1	72.6	69.1	64.7	61.2	58.7	52.6
Jackhammer	Yes	119.7	94.7	88.7	82.6	74.7	68.7	65.1	62.6	59.1	54.7	51.2	48.7	42.6
Man Lift	No	119.7	94.7	88.7	82.6	74.7	68.7	65.1	62.6	59.1	54.7	51.2	48.7	42.6
Mounted Impact Hammer	Yes	124.7	99.7	93.7	87.6	79.7	73.7	70.1	67.6	64.1	59.7	56.2	53.7	47.6
Paver	No	119.7	94.7	88.7	82.6	74.7	68.7	65.1	62.6	59.1	54.7	51.2	48.7	42.6

⁸ Equipment list and Sound Power Level source: http://www.fhwa.dot.gov/environment/noise/construction_noise/handbook/handbook09.cfm

Pickup Truck	No	89.7	64.7	58.7	52.6	44.7	38.7	35.1	32.6	29.1	24.7	21.2	18.7	12.6
Pumps	No	111.7	86.7	80.7	74.6	66.7	60.7	57.1	54.6	51.1	46.7	43.2	40.7	34.6
Rivit Buster/Chipping Gun	Yes	119.7	94.7	88.7	82.6	74.7	68.7	65.1	62.6	59.1	54.7	51.2	48.7	42.6
Rock Drill	No	119.7	94.7	88.7	82.6	74.7	68.7	65.1	62.6	59.1	54.7	51.2	48.7	42.6
Roller	No	119.7	94.7	88.7	82.6	74.7	68.7	65.1	62.6	59.1	54.7	51.2	48.7	42.6
Sand Blasting (single nozzle)	No	119.7	94.7	88.7	82.6	74.7	68.7	65.1	62.6	59.1	54.7	51.2	48.7	42.6
Scraper	No	119.7	94.7	88.7	82.6	74.7	68.7	65.1	62.6	59.1	54.7	51.2	48.7	42.6
Sheers (on backhoe)	No	119.7	94.7	88.7	82.6	74.7	68.7	65.1	62.6	59.1	54.7	51.2	48.7	42.6
Slurry Plant	No	112.7	87.7	81.7	75.6	67.7	61.7	58.1	55.6	52.1	47.7	44.2	41.7	35.6
Slurry Trenching Machine	No	116.7	91.7	85.7	79.6	71.7	65.7	62.1	59.6	56.1	51.7	48.2	45.7	39.6
Soil Mix Drill Rig	No	114.7	89.7	83.7	77.6	69.7	63.7	60.1	57.6	54.1	49.7	46.2	43.7	37.6
Tractor	No	118.7	93.7	87.7	81.6	73.7	67.7	64.1	61.6	58.1	53.7	50.2	47.7	41.6
Vacuum Excavator	No	119.7	94.7	88.7	82.6	74.7	68.7	65.1	62.6	59.1	54.7	51.2	48.7	42.6
Vacuum Street Sweeper	No	114.7	89.7	83.7	77.6	69.7	63.7	60.1	57.6	54.1	49.7	46.2	43.7	37.6
Ventilation Fan	No	119.7	94.7	88.7	82.6	74.7	68.7	65.1	62.6	59.1	54.7	51.2	48.7	42.6
Vibrating Hopper	No	119.7	94.7	88.7	82.6	74.7	68.7	65.1	62.6	59.1	54.7	51.2	48.7	42.6
Vibratory Concrete Mixer	No	114.7	89.7	83.7	77.6	69.7	63.7	60.1	57.6	54.1	49.7	46.2	43.7	37.6
Vibratory Pile Driver	No	129.7	104.7	98.7	92.6	84.7	78.7	75.1	72.6	69.1	64.7	61.2	58.7	52.6
Warning Horn	No	119.7	94.7	88.7	82.6	74.7	68.7	65.1	62.6	59.1	54.7	51.2	48.7	42.6
Welder/Torch	No	107.7	82.7	76.7	70.6	62.7	56.7	53.1	50.6	47.1	42.7	39.2	36.7	30.6

Table 5-2: Potential equivalent noise levels generated by various equipment

Equipment Description	Equivalent (average) Sound Levels (dBA)	Operational Noise Level at given distance considering equivalent (average) sound power emission levels (Cumulative as well as the mitigatory effect of potential barriers or other mitigation not included – simple noise propagation modelling only considering distance) (dBA)											
		5 m	10 m	20 m	50 m	100 m	150 m	200 m	300 m	500 m	750 m	1000 m	2000 m
Air compressor	92.6	67.6	61.6	55.5	47.6	41.6	38.0	35.5	32.0	27.6	24.1	21.6	15.5
Bulldozer CAT D10	111.9	86.9	80.9	74.9	66.9	60.9	57.4	54.9	51.3	46.9	43.4	40.9	34.9
Cement truck (with cement)	111.7	86.7	80.7	74.7	66.7	60.7	57.2	54.7	51.2	46.7	43.2	40.7	34.7
Crane	107.5	82.5	76.5	70.5	62.5	56.5	53.0	50.5	46.9	42.5	39.0	36.5	30.5
Diesel Generator (Large - mobile)	106.1	81.2	75.1	69.1	61.2	55.1	51.6	49.1	45.6	41.2	37.6	35.1	29.1
Dumper/Haul truck - Terex 30 ton	112.2	87.2	81.2	75.2	67.2	61.2	57.7	55.2	51.7	47.2	43.7	41.2	35.2
Excavator - Hitachi EX1200	113.1	88.1	82.1	76.1	68.1	62.1	58.6	56.1	52.6	48.1	44.6	42.1	36.1
FEL (988) (FM)	115.6	90.7	84.6	78.6	70.7	64.6	61.1	58.6	55.1	50.7	47.1	44.6	38.6
General noise	108.8	83.8	77.8	71.8	63.8	57.8	54.2	51.8	48.2	43.8	40.3	37.8	31.8
Grader - Operational Hitachi	108.9	83.9	77.9	71.9	63.9	57.9	54.4	51.9	48.4	43.9	40.4	37.9	31.9
Road Truck average	109.6	84.7	78.7	72.6	64.7	58.7	55.1	52.6	49.1	44.7	41.1	38.7	32.6
Rock Breaker, CAT	120.7	95.7	89.7	83.7	75.7	69.7	66.2	63.7	60.2	55.7	52.2	49.7	43.7
Vibrating roller	106.3	81.3	75.3	69.3	61.3	55.3	51.8	49.3	45.8	41.3	37.8	35.3	29.3
Water Dozer, CAT	113.8	88.8	82.8	76.8	68.8	62.8	59.3	56.8	53.3	48.8	45.3	42.8	36.8
Wind Turbine: Acciona AW125/3000	108.4	85.4	79.4	73.4	65.4	59.4	55.9	53.4	49.9	45.4	41.9	39.4	33.4
Wind Turbine: Vestas V150-4.2 MW	104.9	79.9	73.9	67.9	60.0	54.0	50.4	48.0	44.5	40.0	36.5	34.0	28.0
Wind Turbine: Vesta V90 2 MW VCS	104.0	79.0	73.0	67.0	59.0	53.0	49.5	47.0	43.5	39.0	35.5	33.0	27.0
Wind Turbine: Vesta V66, ave	102.6	77.7	71.6	65.6	57.7	51.6	48.1	45.6	42.1	37.7	34.1	31.6	25.6
Wind Turbine: Vesta V66, max	108.0	83.0	77.0	71.0	63.0	57.0	53.5	51.0	47.5	43.0	39.5	37.0	31.0
Wind Turbine: Vesta V66, min	96.3	71.3	65.3	59.3	51.3	45.3	41.8	39.3	35.8	31.3	27.8	25.3	19.3
Wind Turbine: Vestas V117 3.3MW	107.0	82.0	76.0	70.0	62.0	56.0	52.5	50.0	46.4	42.0	38.5	36.0	30.0

The equipment likely to be required to complete the above tasks will typically include:

- excavator/graders, bulldozer(s), dump trucks(s), vibratory roller, bucket loader, rock breaker(s), drill rig, flatbed truck(s), pile drivers, TLB, concrete truck(s), crane(s), fork lift(s) and various 4WD and service vehicles.

Noise from the contractor's camp will be minimal and will not influence the ambient sound levels in the surrounding area.

5.1.2 Material supply: Concrete batching plants and use of Borrow Pits

There exist two options for the supply of the concrete to the development site. These options are:

1. The transport of "ready-mix" concrete from the closest center to the development.
2. The transport of aggregate and cement from the closest center to the development, with the establishment of a small concrete batching plant close to the activities. This would most likely be a movable plant. It may be possible to use some of the material obtained from foundation excavation as aggregate if suitable.

5.1.3 Blasting

Blasting may be required as part of the civil works to clear obstacles or to prepare foundations. However, blasting will not be considered for the following reasons:

- Blasting is highly regulated and controlled to protect human health, equipment and infrastructure, using the minimum explosives. The breaking of obstacles with explosives is also a specialized field and when correct techniques are used, it causes less noise than using a rock-breaker.
- People are generally more concerned over ground vibration and air blast levels that might cause building damage than the impact of the noise from the blast.
- Blasts are an infrequent occurrence, with a loud but a relative instantaneous character. Potentially affected parties normally receive sufficient notice (siren), and the knowledge that the duration of the siren noise as well as the blast will be over relatively fast, resulting in a higher acceptance of the noise.

5.1.4 Traffic

The last significant source of noise during the construction phase is additional traffic to and from the site, as well as traffic on the site. On site crushing and screening and concrete batching plants will significantly reduce heavy vehicle movement to and from the site.

Construction traffic is expected to be generated throughout the entire construction period, however, the volume and type of traffic generated will be dependent upon the construction activities being conducted, which will vary during the construction period. Noise levels due

to traffic were estimated using the methodology stipulated in SANS 10210:2004 (Calculating and predicting road traffic noise). Traffic volumes were estimated using:

- Up to 10 trucks and cars each, travelling on a tar road at 80 km/hr; and
- Up to 10 trucks and cars each, travelling on a gravel road at 60 km/hr.

5.2 POTENTIAL NOISE SOURCES – OPERATIONAL PHASE

Noise emitted by wind turbines can be associated with two types of noise sources. These are aerodynamic sources due to the passage of air over the wind turbine blades and mechanical sources which are associated with components of the power train within the turbine, such as the gearbox and generator and control equipment for yaw, blade pitch, etc. These sources normally have different characteristics and can be considered separately. In addition, there are other noise sources of lower levels, such as the substations and traffic (maintenance).

5.2.1 Wind Turbine Noise

5.2.1.1 Wind Turbine - Aerodynamic sources⁹

Aerodynamic noise is emitted by a wind turbine blade through a number of sources such as:

1. Self-noise due to the interaction of the turbulent boundary layer with the blade trailing edge.
2. Noise due to inflow turbulence (turbulence in the wind interacting with the blades).
3. Discrete frequency noise due to trailing edge thickness.
4. Discrete frequency noise due to laminar boundary layer instabilities (unstable flow close to the surface of the blade).
5. Noise generated by the rotor tips.

Therefore, as the wind speed increases, noises created by the wind turbine also increase. At a low wind speed the noise created by the wind turbine is generally (relatively) low, and increases to a maximum at a certain wind speed when it either remains constant, increase very slightly or even drops as illustrated in **Figure 5-1**.

The developer is investigating a number of different wind turbine models; not excluding the possibility of larger models that are not yet available in the commercial market. Therefore, for the purpose of this noise assessment a worst-case scenario will be investigated, making use of the sound power emission levels of the Vestas V150-4.2 wind turbine.

⁹ Renewable Energy Research Laboratory, 2006; ETSU R97: 1996

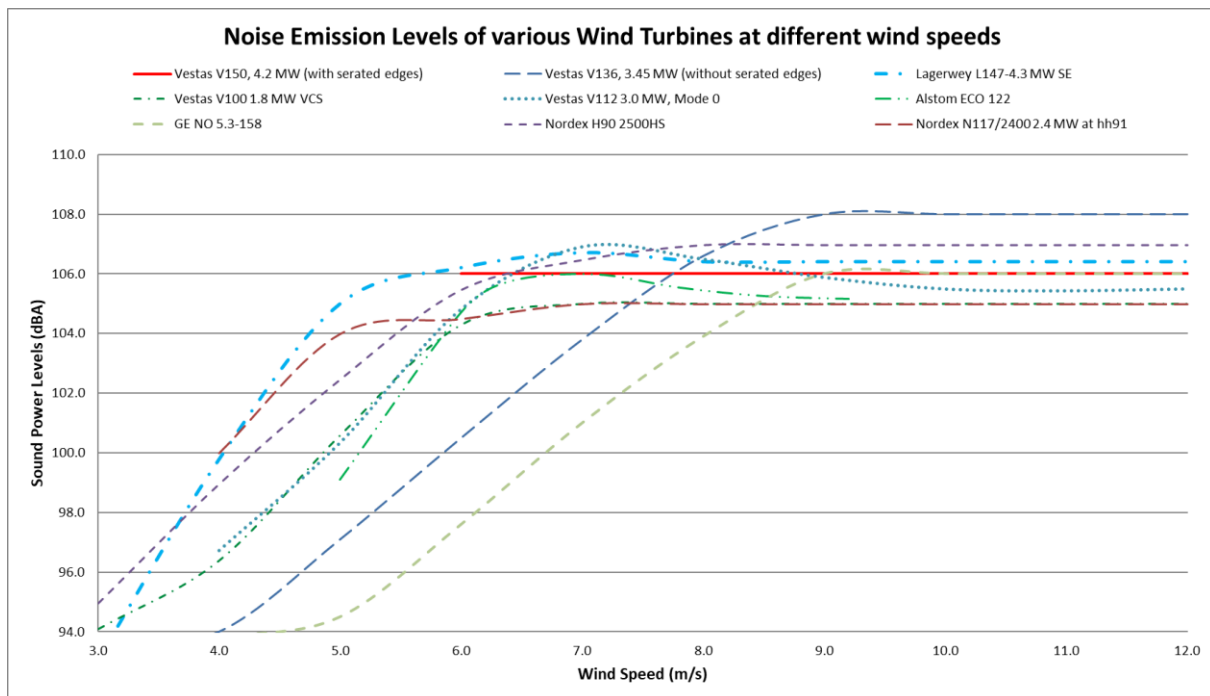

Figure 5-1: Noise Emissions Curve of a number of different wind turbines (figure for illustration purposes only)

The propagation model also makes use of various frequencies, because these frequencies are affected in different ways as it propagates through air, over barriers and over different ground conditions providing a higher accuracy than models that only use the total sound power level. The octave sound power levels for various wind turbines are presented on **Figure 5-2**.

Wind turbine manufacturers also provide their equipment with control mechanisms to allow for a certain noise reduction during operation that can include:

- A reduction of rotational speed;
- The increase of the pitch angle and/or reduction of nominal generator torque to reduce the angle of attack;
- Implementation of blade technologies such as serrated edges, changing the shape of the blade tips or the edge (proprietary technologies); and
- The insulation of the nacelle.

These mechanisms are used in various ways to allow the reduction of noise levels from the wind turbines, although this may also result in a reduction of power generation.

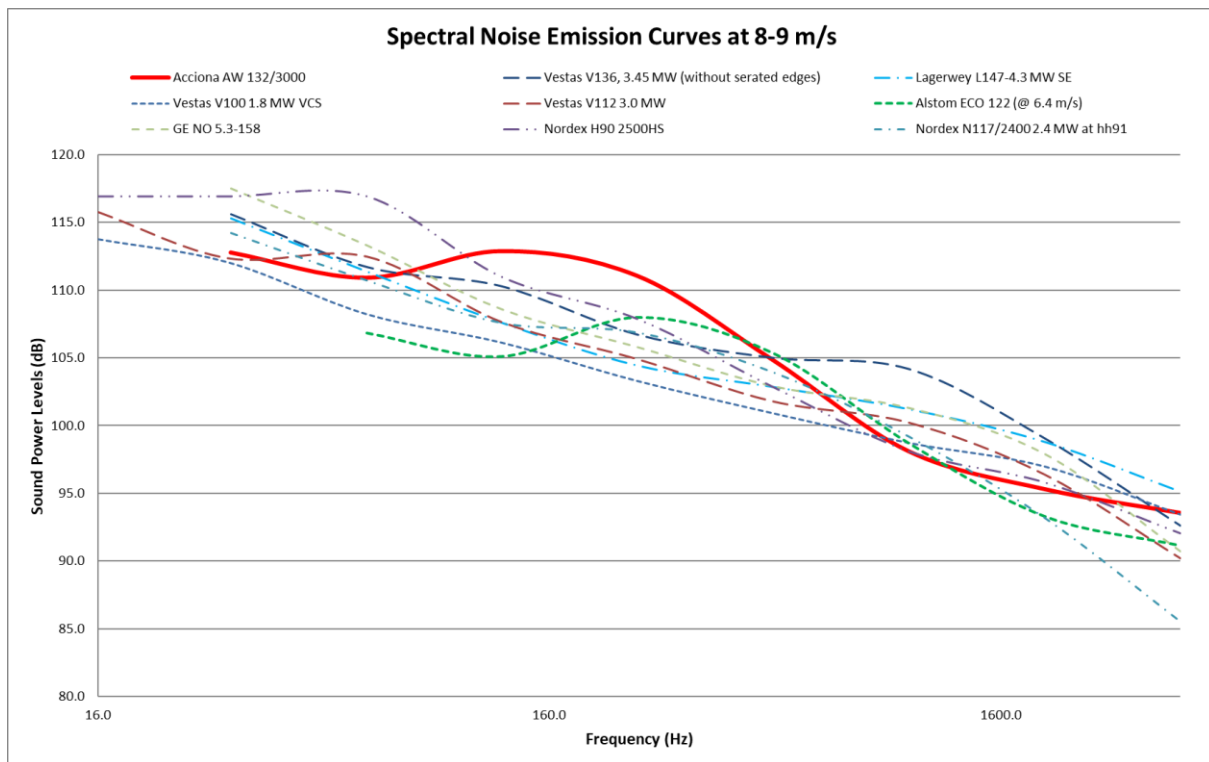

Figure 5-2: Octave sound power emissions of various wind turbines

5.2.1.2 Wind Turbine - Mechanical sources¹⁰

Mechanical noise is normally perceived within the emitted noise from wind turbines as an audible tone(s) which is subjectively more intrusive than a broad band noise of the same sound pressure level. Sources for this noise are normally associated with:

- the gearbox and the tooth mesh frequencies of the step-up stages;
- generator noise caused by coil flexure of the generator windings which is associated with power regulation and control;
- generator noise caused by cooling fans; and
- control equipment noise caused by hydraulic compressors for pitch regulation and yaw control.

Tones are noises with a narrow sound frequency composition (e.g. the whine of an electrical motor). Annoying tones can be created in numerous ways: machinery with rotating parts such as motors, gearboxes, fans and pumps often create tones. An imbalance or repeated impacts may cause vibration that, when transmitted through surfaces into the air, can be heard as tones. Pulsating flows of liquids or gases can also create tones, which may be caused by combustion processes or flow restrictions. The best and most well-known example of a tonal noise is the buzz created by a flying mosquito.

¹⁰ Renewable Energy Research Laboratory, 2006; ETSU R97: 1996; Audiology Today, 2010; HGC Engineering, 2007

Where complaints have been received due to the operation of wind farms, tonal noise from the installed wind turbines appears to have increased the annoyance perceived by the complainants and has indeed been the primary cause for complaint.

However, tones were normally associated with the older models of turbines. All turbine manufacturers have started to ensure that sufficient forethought is given to the design of quieter gearboxes and the means by which these vibration transmission paths may be broken. Through the use of careful gearbox design and/or the use of anti-vibration techniques, it is possible to minimize the transmission of vibration energy into the turbine supporting structure. The benefits of these design improvements have started to filter through into wind farm developments which are using these modified wind turbines. ***New generation wind turbine generators do not emit any clearly distinguishable tones.***

5.2.1.3 Control Strategies to manage Noise Emissions during operation

Wind turbine manufacturers also provide their equipment with control mechanisms to allow for a certain noise reduction during operation that can include:

- A reduction of rotational speed;
- The increase of the pitch angle and/or reduction of nominal generator torque to reduce the angle of attack;
- Implementation of blade technologies such as serrated edges, changing the shape of the blade tips or the edge (proprietary technologies); and
- The insulation of the nacelle.

These mechanisms are used in various ways to allow the reduction of noise levels from the wind turbines, although this may also result in a reduction of power generation.

5.2.1.4 Concluding Remarks on Wind Turbine Noise Levels

While algorithms and equations exist to **estimate** sound power levels, these formulae do not consider operating modes, specific isolation designed for the nacelle and blade technologies (such as serrated edges), which all contribute to reduce the noise levels. These measures are specific to a particular wind turbine make and model and accurately defined using a method as defined by e.g. IEC 61400-11.

The noise report considers the sound power emission levels of the wind turbine generator (WTG) that the client indicated they may consider. However, due to various reasons, a developer does not want to reveal the actual WTG that they may consider, whether for commercial/economic reasons, possible Non-Disclosure Agreements etc. It should thus be noted that the details of the actual WTG are **totally** irrelevant to a noise analysis, as the major factors that determine the noise levels are:

- The layout of the WEF (which would include the number of WTGs as well as the distance from these WTGs that could individually and cumulatively affect the noise levels at a certain location); and
- The sound power emission levels of the WTG (or noise source) selected/that the developer is considering.

Minor factors in the noise levels are:

- The spectral characteristics of the WTG;
- Temperature and Humidity of the surrounding atmosphere, with this study considering atmospheric conditions optimal for the propagation of noise (Humidity of 70% and air temperature of 10°C);
- Noise abatement technologies implemented by the manufacturer;
- Topography and wind shear effects;
- Ground surface characteristics.

Insignificant factors are:

- The hub height of the WTG;
- The rotor diameter of the WTG;
- The manufacture of the WTG, the model name or number (the sound power emission levels however relates to a specific make and model and is determined by the manufacturer).

The sound power emission levels are provided by the manufacturer either as the maximum warranted sound power levels, a calculated sound power level (for new WTG where the noise levels were not previously measured) or measured sound power levels (measured using an internationally recognised protocol as defined by IEC 61400-11). The sound power emission levels are unique for each make and model and already include the effect of the hub height, rotor diameter and abatement technologies.

5.2.2 Low Frequency Noise¹¹

Low frequency sound is the term used to describe sound energy in the region below ~200 Hz. The rumble of thunder and the throb of a diesel engine are both examples of sounds with most of their energy in this low frequency range. Infrasound is often used to describe sound energy in the region below 20 Hz.

Almost all noise in the environment has components in this region although they are of such a low level that they are not significant (wind, ocean, thunder). See also **Figure 5-3**, which

¹¹ *Renewable Energy Research Laboratory, 2006; DELTA, 2008; DEFRA, 2003; HGC Engineering, 2006; Whitford, Jacques, 2008; Noise-con, 2008; Minnesota DoH, 2009; Kamperman, 2008, Van den Berg, 2004*

indicates the sound power levels in the different octave bands from measurements taken at different wind speeds with no other audible noise sources. Sound that has most of its energy in the 'infrasound' range is only significant if it is at a very high level, far above normal environmental levels.

Because of the low rotational rates of the blades of a WTG, the peak acoustic energy radiated by large wind turbines is in the infrasonic range with a peak in the 8-12 Hz range. For smaller machines, this peak can extend into the low-frequency "audible" (20-20KHz) range because of higher rotational speeds and multiple blades.

It should be noted that a number of studies highlighted that these sounds are below the threshold of perception (BWEA, 2005), although this should be clarified. Most acousticians would agree that the low frequency sounds are inaudible to most people, yet, there are a number of studies that highlight that it can be more perceptible to people inside their houses as well as people that are more sensitive to low frequency sounds.

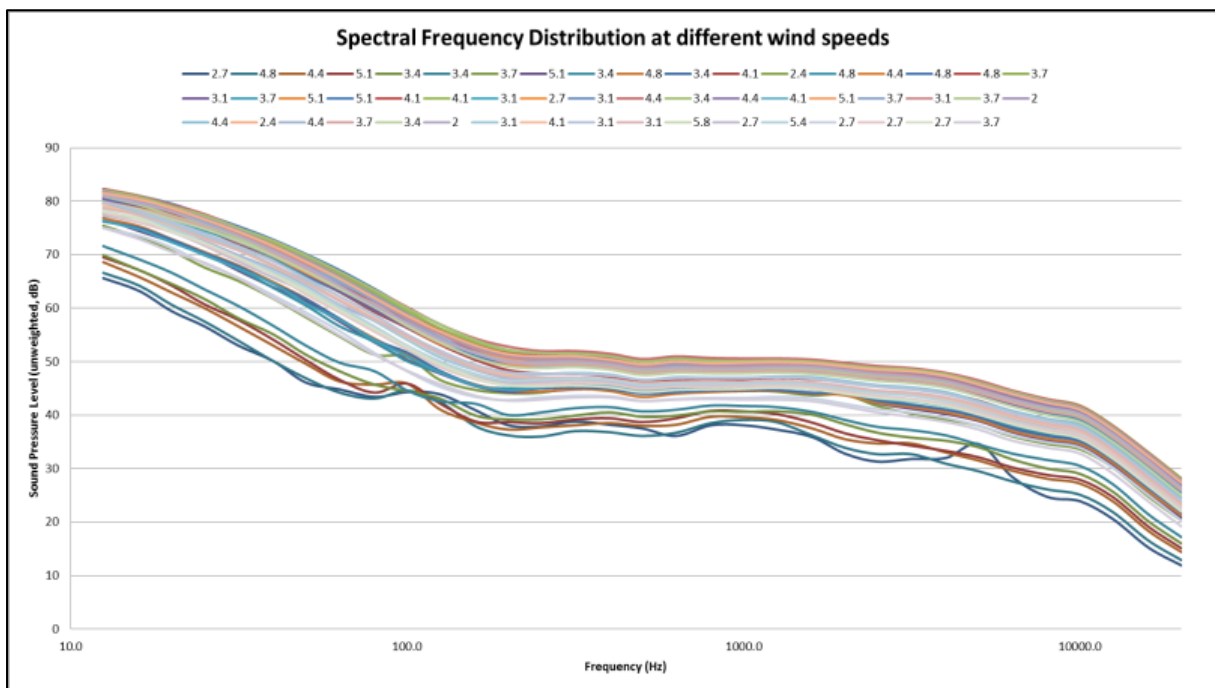

Figure 5-3: Third octave band sound power levels at various wind speeds at a location where wind induced noises dominate

Low frequency noise is always present around us as it is produced by both man and nature. While problems have been associated with older downwind wind turbines in the 1980s, this has been considered by the wind industry and modern upwind turbines do not suffer from the same problems. Low Frequency Noise however has been very controversial in the last few years with the anti-wind fraternity claiming measurable impacts, with governments and wind-energy supporter studies indicating no link between low-frequency sound and any

health impacts. This study notes the various claims and as such follow a more precautionous approach.

5.2.3 Amplitude modulation¹²

Although considered rare, there is one other characteristic of wind turbine sound that increases the sleep disturbance potential above that of other long-term noise sources. The amplitude modulation (AM) of the sound emissions from the wind turbines creates a repetitive rise and fall in sound levels synchronized to the blade rotation speed, sometimes referred to as a “swish” or “thump”.

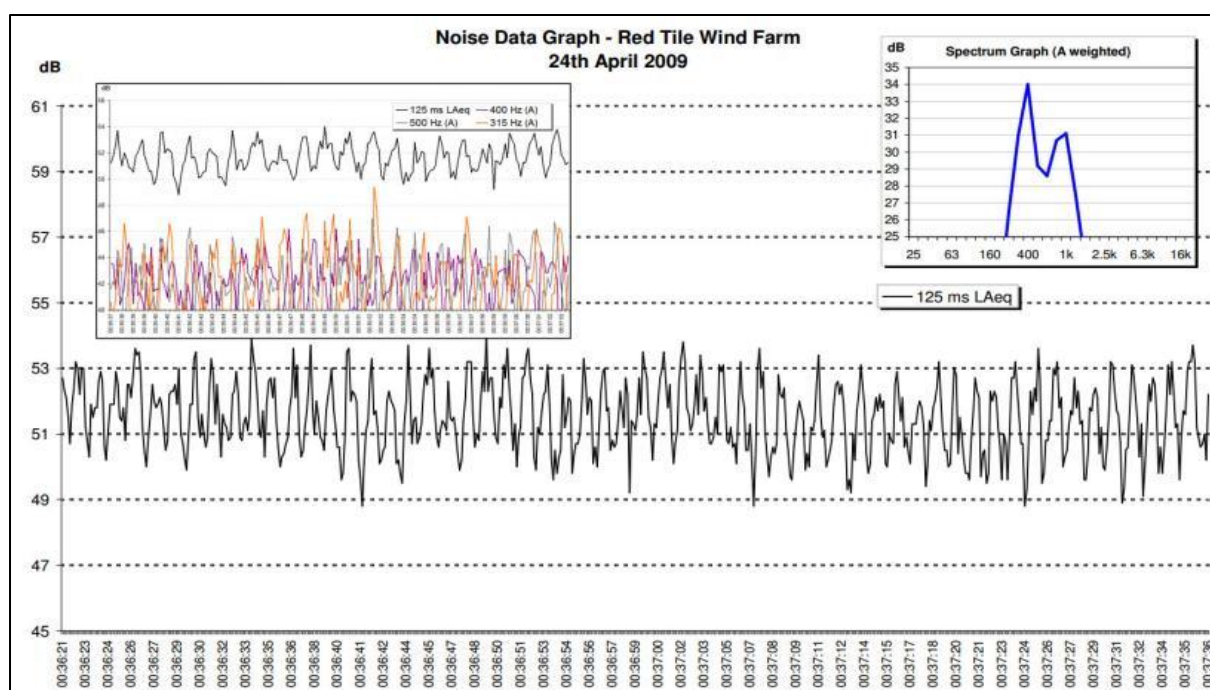

Figure 5-4: Example time-sound series graph illustrating AM as measured by Stigwood¹³ (et al) (2013)

Pedersen (2003) highlighted a weak correlation between sound pressure level and noise annoyance caused by wind turbines. Residents complaining about wind turbines noise perceived more sound characteristics than noise levels. People were able to distinguish between background ambient sounds and the sounds the blades made. The noise produced by the blades lead to most complaints. Most of the annoyance was experienced between 16:00 and midnight. This could be an issue as noise propagation modelling would be reporting an equivalent, or “average” sound pressure level, a parameter that ignores the “character” of the sound.

¹² Renewable Energy Research Laboratory, 2006; Audiology Today, 2010; HGC Engineering, 2007; Whitford, 2008; Noise-con, 2008; DEFRA, 2007; Bowdler, 2008

¹³ Stigwood (et al) (2013): “Audible amplitude modulation – results of field measurements and investigations compared to psycho-acoustical assessments and theoretical research”; Paper presented at the 5th International Conference on Wind Turbine Noise, Denver 28 – 30 August 2013

That AM can be a risk and significantly increase the annoyance with WEFs cannot be disputed. It has been reported with a number of recent studies confirming this significant noise characteristic. However, even though there are thousands of wind turbine generators in the world, amplitude modulation is still one subject receiving the least complaints and due to these very few complaints, little research went into this subject. Studies as recently as 2012 (Smith, 2012) highlight the need for additional studies and data collection.

However, because of these unknown factors (low frequency noises and AM), this noise study adopts a precautionary stance and will consider the worst-case scenario.

5.2.4 Battery Energy Storage Systems

The developer proposes to include a BESS at their WEF to store energy for use at a later time or date using electro-chemical solutions. The typical components of a BESS are (source: ADB, 2018):

- The battery system which could consist of:
 - o Multiple cells,
 - o The battery management system; and,
 - o The battery thermal management system.
- Components required for the reliable operation of the overall system, including:
 - o Energy management system; and,
 - o System thermal management.
- Power electronics that can be grouped into the conversion unit (such as an inverter), which manage the power flow between the grid and battery, including the required control and monitoring components, voltage sensing units and thermal management of power electronic components (fans or climate control system).

There could be numerous such BESS modules running in parallel to increase the total storage capacity of the system up to the desired or needed capacity. The typical components are illustrated in **Figure 5-5**.

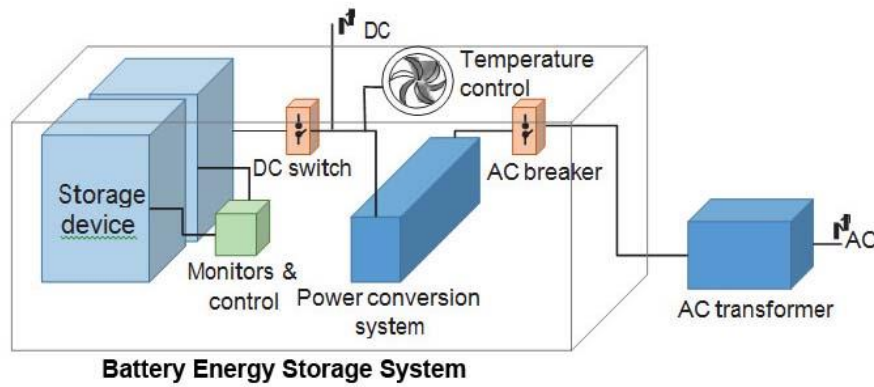

Figure 5-5: Conceptual BESS components

While certain components may generate a slight hum under load, the dominant source of noise is from the fans or climate control system used to manage heat in the system and/or to maintain the BESS within its optimal operating temperature range. These BESSs however generate low noise levels, with any potential noise impact generally limited to areas within 200m of the BESS. This is an insignificant noise level and the significance of this noise will be low.

6 ASSUMPTIONS AND LIMITATIONS

6.1 MEASUREMENTS OF AMBIENT SOUND LEVELS

- Ambient sound levels are the cumulative effects of innumerable sounds generated from a variety of noise sources at various instances both far and near from the listener. High measurements may not necessarily mean that noise levels in the area are high. Similarly, a low sound level measurement will not necessarily mean that the area is always quiet, as sound levels will vary over seasons, time of the day, faunal characteristics, vegetation in the area and meteorological conditions (especially wind). This is excluding the potential effect of sounds from anthropogenic origin. It is impossible to quantify and identify the numerous sources that influenced one 10-minute measurement using the reading result at the end of the measurement. Therefore, trying to define ambient sound levels using the result of one 10-minute measurement will be very inaccurate (very low confidence level in the results) for the reasons mentioned above. The more measurements that can be collected at a location the higher the confidence levels in the ambient sound level determined. The more complex the sound environment, the longer the required measurement, especially when at a community or house. It is assumed that the measurement locations represent ambient sound levels in the area (similar environment), yet, in practice this can be highly erroneous as there are numerous factors that can impact on ambient sound levels, including:
 - the distance to the closest trees, number and type of trees as well as the height of the trees;
 - available habitat and food for birds and other animals;
 - distance to residential dwellings, type of equipment used at dwelling (compressors, air-cons, etc.) and people in the area;
 - general maintenance condition of houses (especially during windy conditions), as well as
 - numbers and types of animals kept in the vicinity of the measurement locations.
- Determination of existing road traffic and other noise sources of significance are important (traffic counts, etc.). Traffic, however, is highly dependent on the time of day as well as general agricultural activities taking place at the time of traffic counts. Traffic noise is one of the major components in urban areas and could be a significant source of noise during busy periods. The proposed Highlands South WEF would however be located in a rural area and this study found that traffic in the area was very low, yet it cannot be assumed that it is always very low;
- Measurements over wind speeds of 3 m/s could provide data influenced by wind-induced noises. While the windshields used limits the effect of fluctuating pressure

across the microphone diaphragm, the effect of wind-induced noises in the trees in the vicinity of the microphone did impact on the ambient sound levels;

- Ambient sound levels are depended not only on the time of day and meteorological conditions, but also change due to seasonal differences. Ambient sound levels are generally higher in summer months when faunal activity is higher and lower during the winter due to reduced faunal activity;
- Ambient sound levels are presented considering the wind speeds as measured by the onsite meteorological station. This may not be typical of actual ambient sound levels because wind speeds are measured at a height of 40 – 80 m above the ground surface. This would be significantly higher than actual wind speeds at ground level because local topography and ground surface roughness (trees, buildings and structures that can influence wind) could be significantly different at the measurement location;
- Ambient sound levels recorded near rivers, streams, wetlands, trees and bushy areas can be high. This is due to faunal activity which can dominate the sound levels around the measurement location; and
- As a residential area develops the presence of people will result in increased sounds. These are generally a combination of traffic noise, voices, animals and equipment (incl. TV's and Radios). The result is that ambient sound levels will increase as a residential area matures.

6.2 CALCULATING NOISE EMISSIONS – ADEQUACY OF PREDICTIVE METHODS

The noise emissions into the environment from the various sources as defined were calculated for the WEF, using the Sound Propagation Model described in ISO 9613-2 (operation phase) and SANS 10357¹⁴ (construction phase).

The following was considered in the Noise Model:

- The octave band sound pressure emission levels of processes and equipment;
- The distance of the receiver from the noise sources;
- The impact of atmospheric absorption;
- The operational details of the proposed project, such as projected areas where activities will be taking place;
- Topographical layout, as well as
- Acoustical characteristics of the ground. Seventy-five percent (75%) hard ground conditions were modelled considering the recommendation of a number of studies.

¹⁴ SANS 10357:2004 The calculation of sound propagation by the Concave method'

The noise emission into the environment due to additional traffic was estimated using the Sound Propagation Model described in SANS 10210¹⁵. Corrections such as the following will be considered:

- Distance of receptor from the roads;
- Road construction material;
- Average vehicle speeds;
- Vehicle types, and
- Ground acoustical conditions.

It is important to understand the difference between sound, or noise level and the noise rating level (also see Glossary of Terms).

Sound, or noise levels, generally refers to a sound pressure level as measured using an instrument, whereas the noise rating level refers to a calculated sound exposure level to which various corrections and adjustments was added. These noise rating levels are further processed into a 3D map illustrating noise contours of constant rating levels or noise isopleths. In this project it illustrates the potential extent of the calculated noises of the complete project and not noise levels at a specific moment in time. It is used to define potential issues of concern and not to predict a noise level at a potential noise-sensitive receptor. For this the selected sound propagation model is internationally recognized and considered adequate.

6.3 ADEQUACY OF UNDERLYING ASSUMPTIONS

Noise experienced at a certain location is the cumulative result of innumerable sounds emitted and generated both far and close, each in a different time domain, each having a different spectral character at a different sound level. Each of these sounds are also impacted differently by surrounding vegetation, structures and meteorological conditions that result in a total cumulative noise level represented by a few numbers on a sound level meter. As previously mentioned, it is not the purpose of noise modelling to accurately determine a likely noise level at a certain receptor, but to calculate a noise rating level that is used to identify potential issues of concern.

6.4 UNCERTAINTIES OF INFORMATION PROVIDED

While it is difficult to define the character of a measured noise in terms of numbers (third octave sound power levels), it is difficult to accurately model noise levels at a receptor from

¹⁵ SANS 10210:2004. 'Calculating and predicting road traffic noise'

any operation. The projected noise levels are the output of a numerical model with the accuracy depending on the assumptions made during the setup of the model. The assumptions include the following:

- That octave sound power levels selected for processes and equipment accurately represent the sound character and power levels of these processes and equipment. The determination of octave sound power levels in itself is subject to errors, limitations and assumptions with any potential errors carried over to any model making use of these results;
- Sound power emission levels from processes and equipment changes depending on the load the process and equipment is subject to. While the octave sound power level is the average (equivalent) result of a number of measurements, this measurement relates to a period that the process or equipment was subject to a certain load (work required from the engine or motor to perform action). Normally these measurements are collected when the process or equipment is under high load. The result is that measurements generally represent a worse-case scenario;
- As it is unknown which processes and equipment will be operational (when and for how long), modelling considers a scenario where processes and equipment are under full load for a set time period. Modelling assumptions complies with the precautionary principle and operational time periods are frequently overestimated. The result is that projected noise levels would be likely over-estimated;
- Modelling cannot capture the potential impulsive character of a noise that can increase the potential nuisance factor;
- The XYZ topographical information is derived from the Advanced Spaceborne Thermal Emission and Reflection Radiometer (ASTER) Global DEM data, a product of Japan's Ministry of Economy, Trade, and Industry (METI) and the National Aeronautical and Space Administration (NASA). There are known inaccuracies and artefacts in the data set, yet this is still one of the most accurate data sets to obtain 3D-topographical information;
- The impact of atmospheric absorption is simplified and very uniform meteorological conditions are considered. This is an over-simplification and the effect of this in terms of sound propagation modelling is difficult to quantify; and
- Acoustical characteristics of the ground are over-simplified with ground conditions accepted as uniform. Seventy-five percent (75%) hard ground conditions will be modelled that should allow slightly precautionary values.

6.5 CONDITIONS THAT THIS REPORT MAY BE SUBJECT TO

This report is not subject to any conditions.

7 METHODOLOGY: ENVIRONMENTAL NOISE IMPACT ASSESSMENT AND SIGNIFICANCE

7.1 NOISE IMPACT ON ANIMALS¹⁶

A great deal of research was conducted in the 1960's and 1970's on the effects of aircraft noise on animals. While aircraft noise has a specific characteristic, the findings should be relevant to most noise sources.

Overall, the research suggests that species differ in their response to:

- Various types of noise;
- Durations of noise; and
- Sources of noise.

A general animal behavioural reaction to aircraft noise is the startle response. However, the strength and length of the startle response appears to be dependent on:

- which species is exposed;
- whether there is one animal or a group; and
- whether there have been some previous exposures.

Unfortunately, there are numerous other factors in the environment of animals that also influence the effects of noise. These include predators, weather, changing prey/food base and ground-based disturbance, especially anthropogenic. This hinders the ability to define the real impact of noise on animals.

From these and other studies the following can be concluded:

- Animals respond to impulsive (sudden) noises (higher than 90 dBA) by running away. If the noises continue, animals would try to relocate. This is not relevant to wind energy facilities because the turbines do not generate any impulsive noises close to these sound levels.
- Animals of most species exhibit adaptation with noise, including aircraft noise and sonic booms (far worse than noises associated with Wind Turbines).
- More sensitive species would relocate to a quieter area, especially species that depend on hearing to hunt or evade prey, or species that makes use of sound/hearing to locate a suitable mate.
- Noises associated with helicopters, motor- and quad bikes significantly impact on animals.

¹⁶ Report to Congressional Requesters, 2005; USEPA, 1971; Autumn, 2007; Noise quest, 2010

7.2 WHY NOISE CONCERNS COMMUNITIES¹⁷

Noise can be defined as "unwanted sound", an audible acoustic energy that adversely affects the physiological and/or psychological well-being of people, or which disturbs or impairs the convenience or peace of any person. One can generalise by saying that sound becomes unwanted when it:

- Hinders speech communication;
- Impedes the thinking process;
- Interferes with concentration;
- Obstructs activities (work, leisure and sleeping); and
- Presents a health risk due to hearing damage.

However, it is important to remember that whether a given sound is "noise" depends on the listener or hearer. The driver playing loud rock music on their car radio hears no noise, but the person in the traffic behind them hears nothing but noise.

Response to noise is unfortunately not an empirical absolute, as it is seen as a multi-faceted psychological concept, including behavioural and evaluative aspects. For instance, in some cases annoyance is seen as an outcome of disturbances, in other cases it is seen as an indication of the degree of helplessness with respect to the noise source.

Noise does not need to be loud to be considered "disturbing". One can refer to a dripping tap in the quiet of the night, or the irritating "thump-thump" of the music from a neighbouring house at night when one would like to sleep.

Severity of the annoyance depends on factors such as:

- Background sound levels, and the background sound levels the receptor is used to;
- The manner in which the receptor can control the noise (helplessness);
- The time, unpredictability, frequency, distribution, duration, and intensity of the noise;
- The physiological state of the receptor; and
- The attitude of the receptor about the emitter (noise source).

7.2.1 Annoyance associated with Wind Energy Facilities¹⁸

Annoyance is the most widely acknowledged effect of environmental noise exposure, and is considered to be the most widespread. It is estimated that less than a third of the individual noise annoyance is accounted for by acoustic parameters, and that non-acoustic factors plays a major role. Non-acoustic factors that have been identified include age, economic

¹⁷ World Health Organization, 1999; Noise quest, 2010; Journal of Acoustical Society of America, 2009

¹⁸ Van den Berg, 2011; Milieu, 2010.

dependence on the noise source, attitude towards the noise source and self-reported noise sensitivity.

On the basis of a number of studies into noise annoyance, exposure-response relationships were derived for high annoyance from different noise sources. These relationships, illustrated in **Figure 7-1**, are recommended in a European Union position paper published in 2002, stipulating policy regarding the quantification of annoyance. This can be used in an Environmental Health Impact Assessment and cost-benefit analysis to translate noise maps into overviews of the numbers of persons that may be annoyed, thereby giving insight into the situation expected in the long term. It is not applicable to local complaint-type situations or to an assessment of the short-term effects of a change in noise climate.

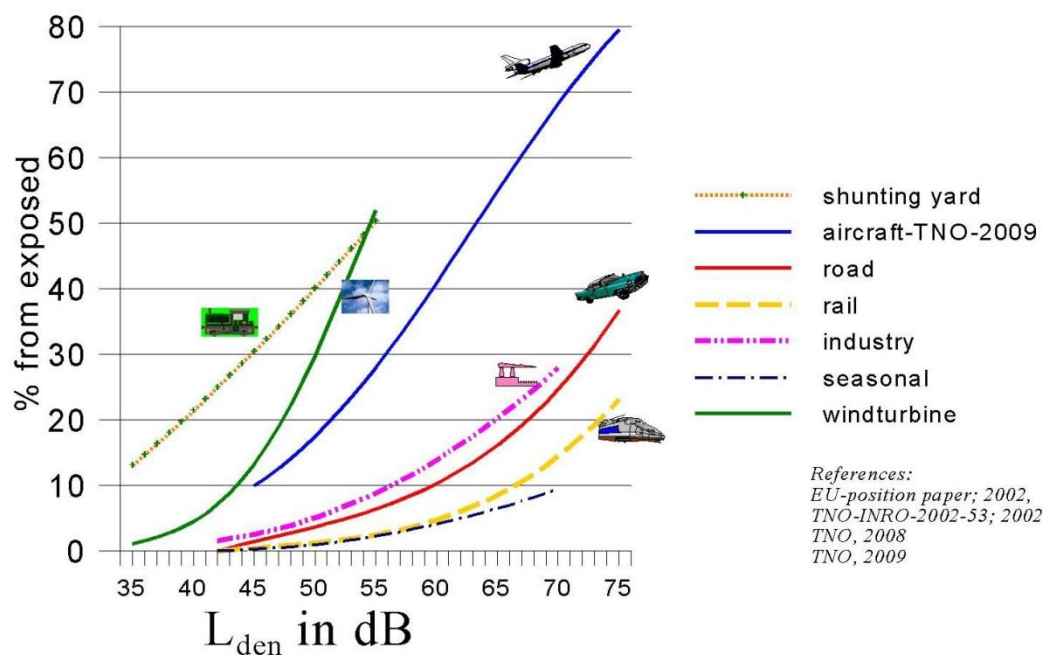

Figure 7-1: Percentage of annoyed persons as a function of the day-evening-night noise exposure at the façade of a dwelling

While the total ambient sound levels are of importance, the spectral characteristics also determines the likelihood that someone will hear external noises that may or may not be similar in spectral characteristics to that of vegetation created noise. Bolin (2006) did investigate spectral characteristics and determined the annoyance might occur at levels where noise generated by wind turbine noise exceeds natural ambient sounds with 3 dB or more.

7.3 IMPACT ASSESSMENT CRITERIA

7.3.1 Overview: The common characteristics

The word "noise" is generally used to convey a negative response or attitude to the sound received by a listener. There are four common characteristics of sound, any or all of which determine listener response and the subsequent definition of the sound as "noise". These characteristics are:

- Intensity;
- Loudness;
- Annoyance; and
- Offensiveness.

Of the four common characteristics of sound, intensity is the only one which is not subjective and can be quantified. Loudness is a subjective measure of the effect the sound has on the human ear. As a quantity it is therefore complicated but has been defined by experimentation on subjects known to have normal hearing.

The annoyance and offensive characteristics of noise are also subjective. Whether or not a noise causes annoyance mostly depends upon its reception by an individual, the environment in which it is heard, the type of activity and mood of the person and how acclimatised or familiar that person is to the sound.

7.3.2 Noise criteria of concern

The criteria used in this report were drawn from the criteria for the description and assessment of environmental impacts from the Integrated Environmental Management Information Series (DEAT, 2002).

There are a number of criteria that are of concern for the assessment of noise impacts. These can be summarised in the following manner:

- *Increase in noise levels:* People or communities often react to an increase in the ambient noise level they are used to, which is caused by a new source of noise. With regards to the NCRs, an increase of more than 7 dBA is considered a disturbing noise. See also **Figure 7-2**.
- *Zone Sound Levels:* Previously referred as the acceptable rating levels, sets acceptable noise levels for various areas. See also **Table 7-1**.
- *Absolute or total noise levels:* Depending on their activities, people generally are tolerant to noise up to a certain absolute level, e.g. 65 dBA. However, anything above this level is considered unacceptable.

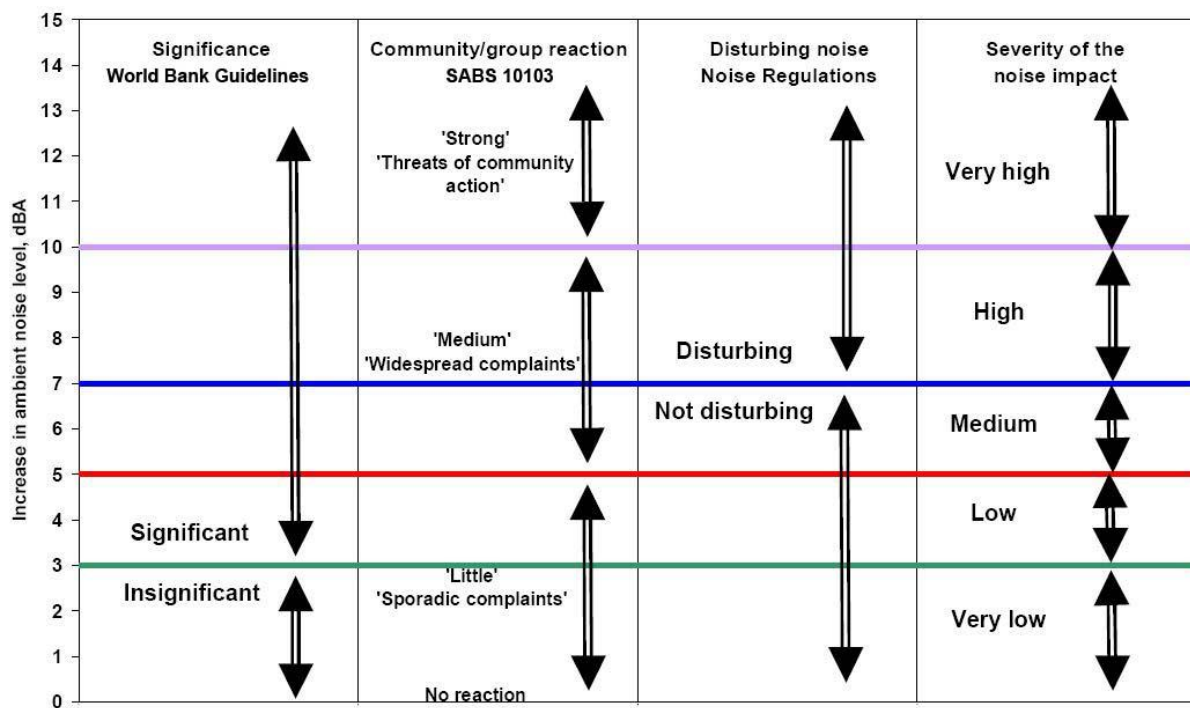

Figure 7-2: Criteria to assess the significance of impacts stemming from noise

In South Africa the document that addresses the issues concerning environmental noise is SANS 10103. See also **Table 7-1**. It provides the maximum average ambient noise levels, $L_{Req,d}$ and $L_{Req,n}$, during the day and night respectively to which different types of developments may be exposed. For rural areas the Zone Sound Levels (Rating Levels) are:

- Day (06:00 to 22:00) - $L_{Req,d} = 45$ dBA, and
- Night (22:00 to 06:00) - $L_{Req,n} = 35$ dBA.

SANS 10103 also provides a guideline for estimating community response to an increase in the general ambient noise level caused by an intruding noise. If Δ is the increase in noise level, the following criteria are of relevance:

- **$\Delta \leq 3$ dBA:** An increase of 3 dBA or less will not cause any response from a community. It should be noted that for a person with average hearing acuity an increase of less than 3 dBA in the general ambient noise level would not be noticeable.
- **$3 < \Delta \leq 5$ dBA:** An increase of between 3 dBA and 5 dBA will elicit 'little' community response with 'sporadic complaints'. People will just be able to notice a change in the sound character in the area.
- **$5 < \Delta \leq 15$ dBA:** An increase of between 5 dBA and 15 dBA will elicit a 'medium' community response with 'widespread complaints'. In addition, an increase of 10 dBA is subjectively perceived as a doubling in the loudness of a noise. For an increase of more than 15 dBA the community reaction will be 'strong' with 'threats of community action'.

In addition, it should be noted that the NCRs defines disturbing noise to be any change in the ambient noise levels higher than 7 dBA than the background.

Table 7-1: Acceptable Zone Sound Levels for noise in districts (SANS 10103)

1	2	3	4	5	6	7
Type of district	Equivalent continuous rating level ($L_{Req,T}$) for noise dBA					
	Outdoors			Indoors, with open windows		
	Day/night $L_{R,dn}^a$	Daytime $L_{Req,d}^b$	Night-time $L_{Req,n}^b$	Day/night $L_{R,dn}^a$	Daytime $L_{Req,d}^b$	Night-time $L_{Req,n}^b$
a) Rural districts	45	45	35	35	35	25
b) Suburban districts with little road traffic	50	50	40	40	40	30
c) Urban districts	55	55	45	45	45	35
d) Urban districts with one or more of the following: workshops; business premises; and main roads	60	60	50	50	50	40
e) Central business districts	65	65	55	55	55	45
f) Industrial districts	70	70	60	60	60	50

7.3.3 Determining appropriate Zone Sound Levels

SANS 10103 unfortunately does not cater for instances when background noise levels change due to the impact of external forces. Locations close to the sea for instance always have a background noise level exceeding 35 dBA, and, in cases where the sea is rather turbulent, it can easily exceed 45 dBA. Similarly, noise induced by high winds is not included.

Setting noise limits relative to the background noise level is relatively straightforward when the prevailing background noise level and source level are constant. However, wind turbines emit noise that is related to wind speed, and the environment within which they are heard will probably also be dependent upon the strength of the wind and the noise associated with its effects. It is therefore necessary to derive a background noise level that is indicative of the noise environment at the receiving property for different wind speeds so that the turbine noise level at any particular wind speed can be compared with the background noise level in the same wind conditions.

7.3.3.1 Using International Guidelines to set Noise Limits

When assessing the overall noise levels emitted by a WEF, it is necessary to consider the full range of operating wind speeds of the wind turbines. This covers the wind speed range from around 3-5 m/s (the turbine cut-in wind speed) up to a wind speed range of 25-35 m/s measured at the hub height of a wind turbine. However, ETSU-R97 (1996) proposes that noise limits only be placed up to a wind speed of 12 m/s for the following reasons:

1. Wind speeds are not often measured at wind speeds greater than 12 m/s at 10 m height;
2. Reliable measurements of background ambient sound levels and turbine noise will be difficult to make in high winds due to the effects of wind noise on the microphone and the fact that one could have to wait several months before such winds were experienced;
3. Turbine manufacturers are unlikely to be able to provide information on sound power levels at such high wind speeds for similar reasons; and
4. If a wind farm meets noise limits at wind speeds lower than 12m/s, it is most unlikely to cause any greater loss of amenity at higher wind speeds. Turbine noise levels increase only slightly as wind speeds increase; however, background ambient sound levels increase significantly with increasing wind speeds due to the force of the wind.

Available data indicates that wind-induced noises start to increase at wind speeds 3 – 4 m/s, becoming a significant (and frequently the dominant noise source in rural areas) at wind speeds higher than 10 – 12 m/s/. Most wind turbines reach their maximum noise emission level at a wind speed of 8 – 10 m/s. At these wind speeds increased wind-induced noises (wind howling around building, rustling of leaves in trees, rattling noises, etc) could start to drown other noises, including that being generated by wind turbines¹⁹.

Sound level vs. wind speed data is presented in the following figures (**Figure 4-4**)²⁰. It is based on approximately 30,000 measurements collected at various quiet locations in South Africa (locations further than 10 km from the ocean). Also indicated are around 480 actual night-time measurements collected within 10 km from the proposed WEF. There were no apparent or observable sounds that would have impacted on the measurements at these locations. There was a lack of higher wind speeds during previous site visits, but as with other sites, ambient sound levels are expected to increase as the surrounding wind speed increase. This has been found at all locations where measurements have been done for a sufficiently long enough period of time (more than 30 locations comprising of more than

¹⁹ It should be noted that this does not mean that the wind turbines are inaudible.

²⁰ The sound level measuring instruments were located at a quiet location in the garden of the various houses. Data was measured in 10-minute bins and then co-ordinated with the 10 m wind speed derived from the wind mast of the developer. This wind mast was not close to the dwellings, being approximately 3,500m from the measurement locations.

38,000 measurements) with the data agreeing with a number of international studies on the subject.

Considering this data as well as the international guidelines (MOE, see **Table 3-2**; IFC, see **Table 3-3**), noise limits starting at 40 dB that increases to more than 45 dB (as wind speeds increase) could be acceptable. Project participants could be exposed to noise levels up to 45 dBA (ETSU-R97).

7.3.3.2 Using local regulations to set noise limits

Noise limits as set by the National NCRs (GN R154 of 1992 – **section 3.3.1**) defines a "disturbing noise" as the Noise Level which exceeds the zone sound level or, if no zone sound level has been designated, a noise level which exceeds the ambient sound level at the same measuring point by 7 dBA or more. Accepting that the sound levels in the area may be typical of a rural noise district, night-time rating levels would be 35 dBA and a noise level exceeding 42 dBA may be a disturbing noise (therefore the noise limit).

As can be observed from **Figure 4-4**, if ambient sound levels were measured at increased wind speeds, ambient sound levels will be higher as wind-induced noises increase. These expected sound levels will be used to determine the probability for a noise impact to occur.

How wind-induced noises increase depends significantly on the measuring location and surrounding environment, but it is expected to be higher than 35 dBA closer to dwellings. The noise limit should increase with increased wind-speeds, but, considering international guidelines, an upper limit of 45 dBA must be honored. For modelling and assessing the potential noise impact the values as proposed in **Table 7-2** will be considered.

Table 7-2: Proposed ambient sound levels and acceptable rating levels

10 meter Wind Speed (m/s)	Estimated ambient sound levels (night-time) (dBA)	MoE Sound Level Limits of Class 3 areas (Table 3-2) (dBA)	ETSU-R97 limit for project participants (dBA)	Night-time Zone Sound Level (SANS 10103:2008) (dBA)	Proposed Night Rating Level (dBA)
4	37.6	40	45	35 (at low wind speeds, this will increase as wind speeds increase)	40
5	38.6	40	45		40
6	39.5	40	45		40
7	40.5	43	45		43
8	41.5	45	45		45
9	42.5	49	45		45

7.3.4 Determining the Significance of the Noise Impact

The level of detail as depicted in the EIA regulations was fine-tuned by assigning specific values to each impact while considering the DEAT (2002) guideline. In order to establish a coherent framework within which all impacts could be objectively assessed, it was necessary to establish a rating system, which was applied consistently to all the criteria. For such purposes each aspect was assigned a value as defined in the third column in the tables below.

The impact consequence is determined by summing the scores of Magnitude (**Table 7-3**), Duration (**Table 7-4**) and Spatial Extent (**Table 7-5**). The impact significance (see **Sections 7.3.5**) is determined by multiplying the Consequence result with the Probability score (**Table 7-6**). An explanation of the impact assessment criteria is defined in the following tables.

Table 7-3: Impact Assessment Criteria – Magnitude

This defines the impact as experienced by any receptor. In this report the receptor is defined as any resident in the area, but excludes faunal species.		
Rating	Description	Score
<i>Minor</i>	Increase in average sound pressure levels between 0 and 3 dB from the expected ambient sound levels. Ambient sound levels are defined by the lower of the measured $L_{A_{T_{eq,8hr}}}$ or $L_{A_{T_{eq,16hr}}}$ during measurement dates. Total projected noise level is less than the Zone Sound Level and/or Equator Principle in wind-still conditions.	2
<i>Low</i>	Increase in average sound pressure levels between 3 and 5 dB from the expected ambient sound levels. Total projected noise levels between 3 and 5 above the Zone Sound Level and/or Equator Principle (wind-less conditions).	4
<i>Moderate</i>	Increase in average sound pressure levels between 5 and 7 dB from the ambient sound levels. Increase in sound pressure levels between 5 and 7 above the Zone Sound Level and/or Equator Principle (wind less conditions). Sporadic complaints expected.	6
<i>High</i>	Increase in average sound pressure levels between 7 and 10 from the ambient sound level. Total projected noise levels between 7 and 10 dBA above the Zone Sound Level and/or Equator Principle (wind-less condition). This would be considered a disturbing noise level. Medium to widespread complaints expected.	8
<i>Very High</i>	Increase in average ambient sound pressure levels higher than 10 dBA. Total projected noise levels higher than 10 dB above the Zone Sound Level and/or Equator Principle (wind less-conditions). Change of 10 dBA is perceived as 'twice as loud', leading to widespread complaints and even threats of community or group action. Any point where instantaneous noise levels exceed 65 dBA at any receptor.	10

Table 7-4: Impact Assessment Criteria - Duration

The lifetime of the impact that is measured in relation to the lifetime of the proposed development (construction, operation and closure phases). Will the receptors be subjected to increased noise levels for the lifetime duration of the project, or only infrequently.		
Rating	Description	Score
<i>Temporary</i>	Impacts are predicted to be of very short duration (portion of construction period) and intermittent/occasional (0 – 1 year).	1
<i>Short term</i>	Impacts that are short, predicted to last only for the duration of the construction period (2 - 5 years).	2
<i>Medium term</i>	Impacts that will continue for the life of the Project, but ceases when the Project stops operating (5 - 15 years).	3
<i>Long term</i>	Impacts that will continue for the life of the Project, but ceases when the Project stops operating (>15 years).	4
<i>Permanent</i>	Impacts that cause a permanent change in the affected receptor or resource (e.g. removal or destruction of ecological habitat) that endures substantially beyond the Project lifetime.	5

Table 7-5: Impact Assessment Criteria – Spatial extent

Classification of the physical and spatial scale of the impact		
Rating	Description	Score
<i>Site</i>	The impacted area extends only as far as the activity, such as the footprint occurring within the total site area.	1
<i>Local</i>	The impact could affect the local area (within 1,000 m from site).	2
<i>Regional</i>	The impact could affect the area including the neighbouring farms, the transport routes and the adjoining towns (further than 1,000 m from site).	3
<i>National</i>	The impact could have an effect that expands throughout the country (South Africa).	4
<i>International</i>	Where the impact has international ramifications that extend beyond the boundaries of South Africa.	5

Table 7-6: Impact Assessment Criteria - Probability

This describes the likelihood of the impacts actually occurring, and whether it will impact on an identified receptor. The impact may occur for any length of time during the life cycle of the activity, and not at any given time. The classes are rated as follows:		
Rating	Description	Score
<i>Improbable</i>	The possibility of the impact occurring is none, due either to the circumstances, design or experience. The chance of this impact occurring is zero (0 %). Projected change in ambient sound levels is less than 3 dB.	1
<i>Possible</i>	The possibility of the impact occurring is very low, due either to the circumstances, design or experience. The chances of this impact occurring is defined to be up to 25 %. Projected change in ambient sound levels is between 3 – 5 dB.	2
<i>Likely</i>	There is a possibility that the impact will occur to the extent that provisions must therefore be made. The chances of this impact occurring is defined to be between 25% and 50 %. Projected change in ambient sound levels is between 5 – 7 dB.	3
<i>Highly Likely</i>	It is most likely that the impacts will occur at some stage of the development. Plans must be drawn up before carrying out the activity. The chances of this impact occurring is defined between 50 % to 75 %. Projected change in ambient sound levels is between 7 – 10 dB.	4
<i>Definite</i>	The impact will take place regardless of any prevention plans, and only mitigation actions or contingency plans to contain the effect can be relied on. The chance of this impact occurring is defined to be between 75% and 100 %. Projected change in ambient sound levels is more than 10 dB.	5

In order to assess the potential significance of the noise impact, these factors were assessed using the equation below, with the significance (without mitigation) rated in **Table 7-7**.

$$\text{Significance} = (\text{Magnitude} + \text{Duration} + \text{Extent}) \times \text{Probability}$$

7.3.5 Identifying the Potential Impacts

Following the assignment of the necessary weights to the respective aspects, criteria are summed and multiplied by their assigned probabilities, resulting in a Significance Rating (SR) value for each impact (prior to the implementation of mitigation measures). The significance (without mitigation) is rated on the scale defined in **Table 7-7**.

Table 7-7: Significance (without mitigation) Rating

SR<30	Low (L)	Impacts with little real effect and which should not have an influence on or require modification of the project design or alternative mitigation. No mitigation is required.
30<SR <60	Medium (M)	Where it could have an influence on the decision unless it is mitigated. An impact or benefit which is sufficiently important to require management. Of moderate significance - could influence the decisions about the project if left unmanaged.
SR>60	High (H)	Impact is significant, mitigation is critical to reduce impact or risk. Resulting impact could influence the decision depending on the possible mitigation. An impact which could influence the decision about whether or not to proceed with the project.

7.4 REPRESENTATION OF NOISE LEVELS

Noise rating levels will be calculated in detail in this report using the appropriate sound propagation models as defined. It is therefore important to understand the difference between sound or noise level as well as the noise rating level (also see Glossary of Terms, [Appendix B](#)).

Sound or noise levels generally refers to a level as measured using an instrument, whereas the noise rating level refers to a calculated sound exposure level to which various corrections and adjustments was added. These noise rating levels are further processed into a 3D map illustrating noise contours of constant rating levels or noise isopleths. In this noise report it will be used to illustrate the potential extent of the calculated noises of the project and not a noise level at a specific moment in time.

8 PROJECTED NOISE RATING LEVELS

8.1 CONSTRUCTION PHASE NOISE IMPACT

This section investigates the conceptual construction activities as discussed in **section 5.1**. The proposed amended layout as provided by the developer for the Highlands South WEF is presented in **Figure 2-2**. As can be seen from this layout, a number of different activities might take place close to potentially sensitive receptors, each with a specific potential impact.

As it is unknown where the different activities may take place it was selected to model the impact of the noisiest activity (laying of foundation totaling 113.6 dBA cumulative noise impact – various equipment operating simultaneously) at all locations (over the full daytime period of 16 hours) where wind turbines may be erected, calculating how this may impact on noise levels at potential noise-sensitive developments (see **Figure 8-1**). Noise created due to linear activities (roads) were also evaluated and plotted against distance as illustrated in **Figure 8-2**²¹.

The projected noise levels relating to construction and operational activities are defined in:

- **Appendix E, Table 1** for daytime construction activities (WTG construction);
- **Appendix E, Table 2** for night-time construction activities (WTG construction)
- **Appendix E, Table 3** for daytime construction activities (road construction);
- **Appendix E, Table 4** for daytime construction activities (construction traffic);
- **Appendix E, Table 5** for daytime operational activities; and
- **Appendix E, Table 6** for night-time operational activities.

²¹ Sound level at a receiver set at a certain distance from a road

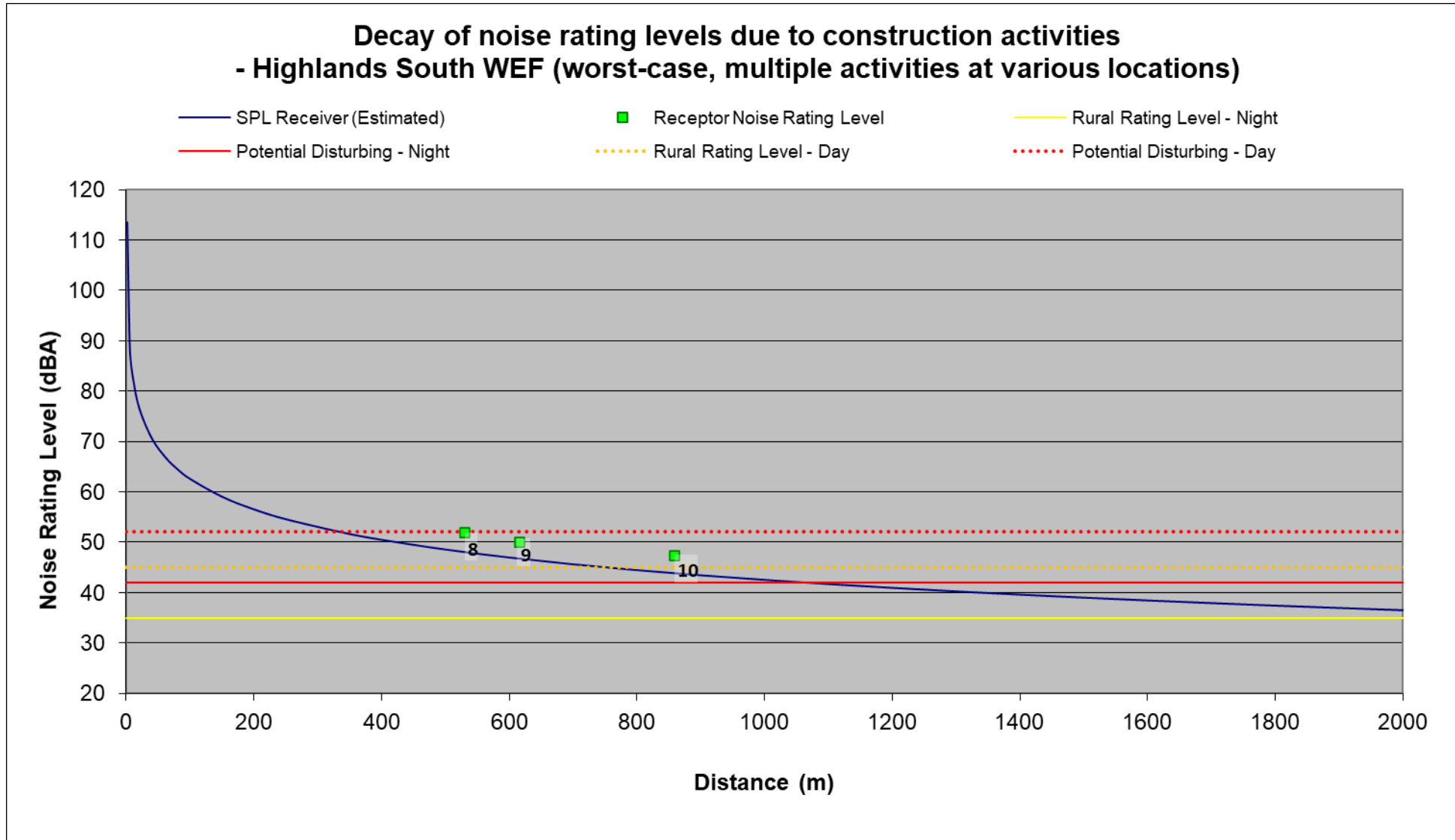

Figure 8-1: Projected conceptual construction noise levels – Decay of noise from construction activities

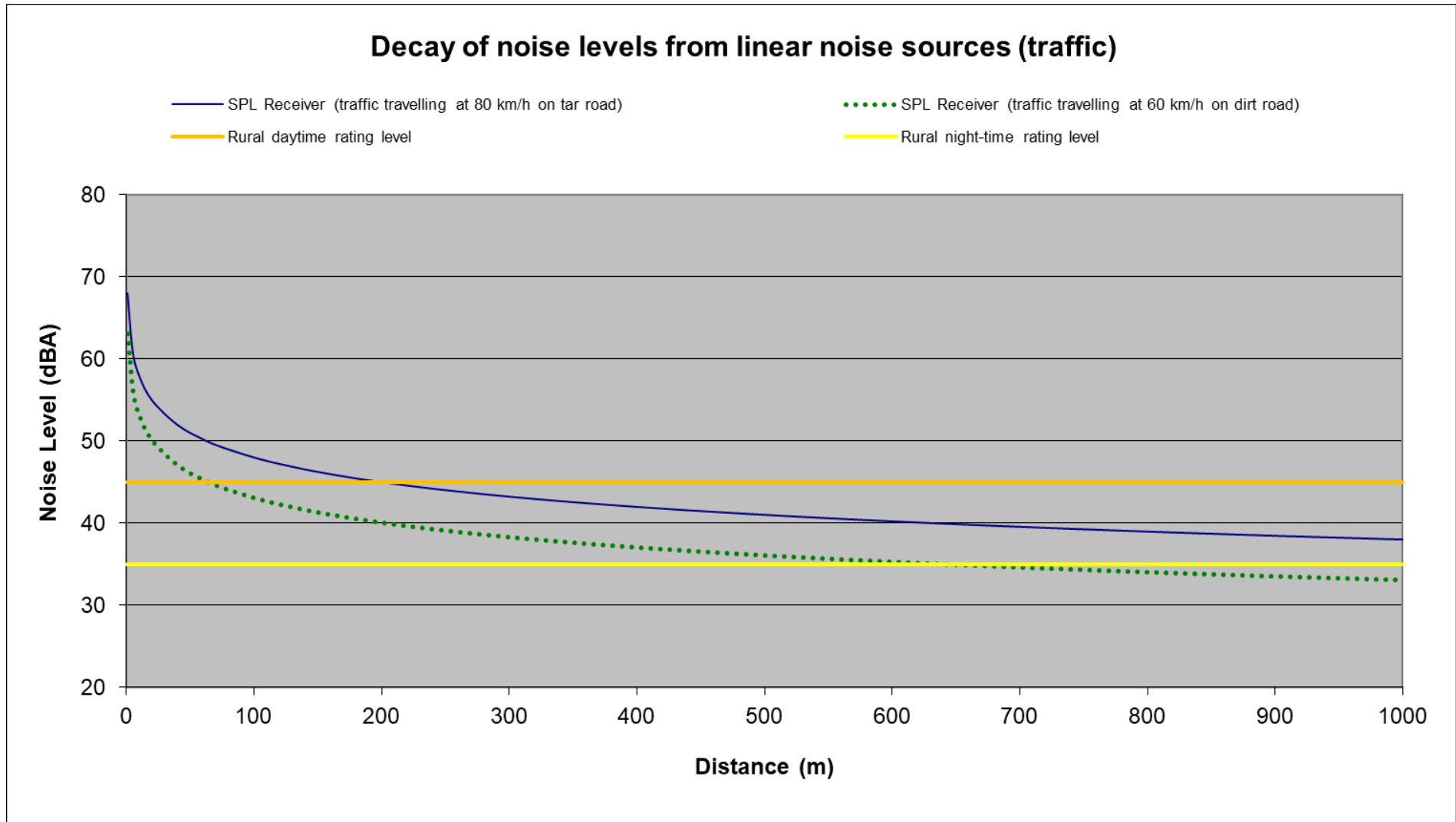

Figure 8-2: Projected conceptual construction noise levels – Decay over distance from linear activities (roads)

8.2 OPERATION PHASE NOISE IMPACT

While the significance of daytime noise impacts was considered, times when a quiet environment is desired (at night for sleeping, weekends etc.) are more critical. Surrounding receptors would desire and require a quiet environment during the night-time (22:00 – 06:00) timeslot and ambient noise levels are critical. It should be noted that maintenance activities normally take place during the day, but normally involve one or two light-delivery vehicles moving around during the course of the day, an insignificant noise source. As such maintenance activities will not be considered.

This noise impact assessment will evaluate the proposed amended layout presented in **Figure 2-2**, using the sound power emission levels presented in **Table 8-1**. The hub height used for modelling was 120 m, though the results will be valid for different hub heights (the approved hub height is 135 m, the proposed amended hub height is 180 m). The calculated noise rating level contours are presented in **Figure 8-3** with the noise levels defined in **Appendix E, Table 6** (for night-time operational activities), considering the 108.5 and 106.0 dBA power emission levels.

Table 8-1: Octave Sound Power Emission Levels used for modelling

A-Weighted Sound Power Levels (at various wind speeds) Wind Turbine: Acciona AW132 3.3 (mitigated and unmitigated) (Mitigated: Serrations + Nacelle Insulation)									
	Wind speed (m/s)								
	6	7	8	9	10				
Mitigated: Sound Power Emission Level (dB re 10 ⁻¹² Pa)	108.5	108.5	108.5	108.5	108.5				
Unmitigated: Sound Power Emission Level (dB re 10 ⁻¹² Pa)	106.0	106.0	106.0	106.0	106.0				
Expected A-weighted Octave Sound Power Levels Wind Turbine: Vestas V150-4.2 MW (Ref: Doc: DG200506, Rev. A, dated 2014-09-30)									
Frequency	31.5	63	125	250	500	1000	2000	4000	8000
L _w (dB)	112.8	110.9	112.9	111.1	104.8	98.1	95.3	93.5	89.0

8.3 POTENTIAL CUMULATIVE NOISE IMPACTS

Cumulative noise impacts generally only occur when noise sources (such as other wind turbines) are closer than 2,000m from each other (around 1,000m from the conceptual receptor located between them). The cumulative impact also only affects the area between the wind turbines of the various wind farms and normally only relate to the operational phase.

If the wind turbines of one wind farm are further than 2,000m from the wind turbines of the other wind farm, the magnitude (and subsequently the significance) of the cumulative noise

impact is reduced. If the distance between the wind turbines of two wind farms are further than 4,000m, cumulative noise impacts are non-existent. This is illustrated in **Figure 8-4**.

At the time this report was drafted, the author knows of the following operational WEFs within 70 km from the authorized Highlands South WEF, namely:

- Amakhala Emoyeni WEF;
- Cookhouse WEF;
- Golden Valley WEF;
- Nojoli WEF; and
- Nxuba WEF.

The following WEFs are authorized (but not yet operational):

- Golden Valley WEF (Phase 2);
- Msengi Emoyeni WEF (Phase 2); and
- Izidluli Emoyeni WEF (Phase 3).

As all these WEFs are further than 4,000 m, risks of cumulative noises from these activities are non-existent as the wind turbines of these projects are too far from the wind turbines of the Highlands South WEF to result in a cumulative noise impact. As such only the cumulative effect from the Highlands North, Central and South WEFs can and should be assessed.

The authorized Highlands South WEF will be located south of the authorised Highlands North and Highlands Central WEFs (forming part of the larger Highlands Wind Farm). The cumulative model considered the sound emission levels as defined in **Table 8-1** for all these WEFs. The layouts of these WEFs were included in a cumulative model with the maximum potential noise level contours illustrated in **Figure 8-5** with the calculated maximum noise levels defined in **Appendix E, Table 7**.

8.4 DECOMMISSIONING AND CLOSURE PHASE NOISE IMPACT

The potential for a noise impact to occur during the decommissioning and closure phase will be much lower than that of the construction and operation phases. This is because:

- Decommissioning activities are normally limited to the daytime period;
- Decommissioning activities have a lower urgency to complete, using minimum equipment and people.

Noise levels are therefore lower than the construction and operation phases.

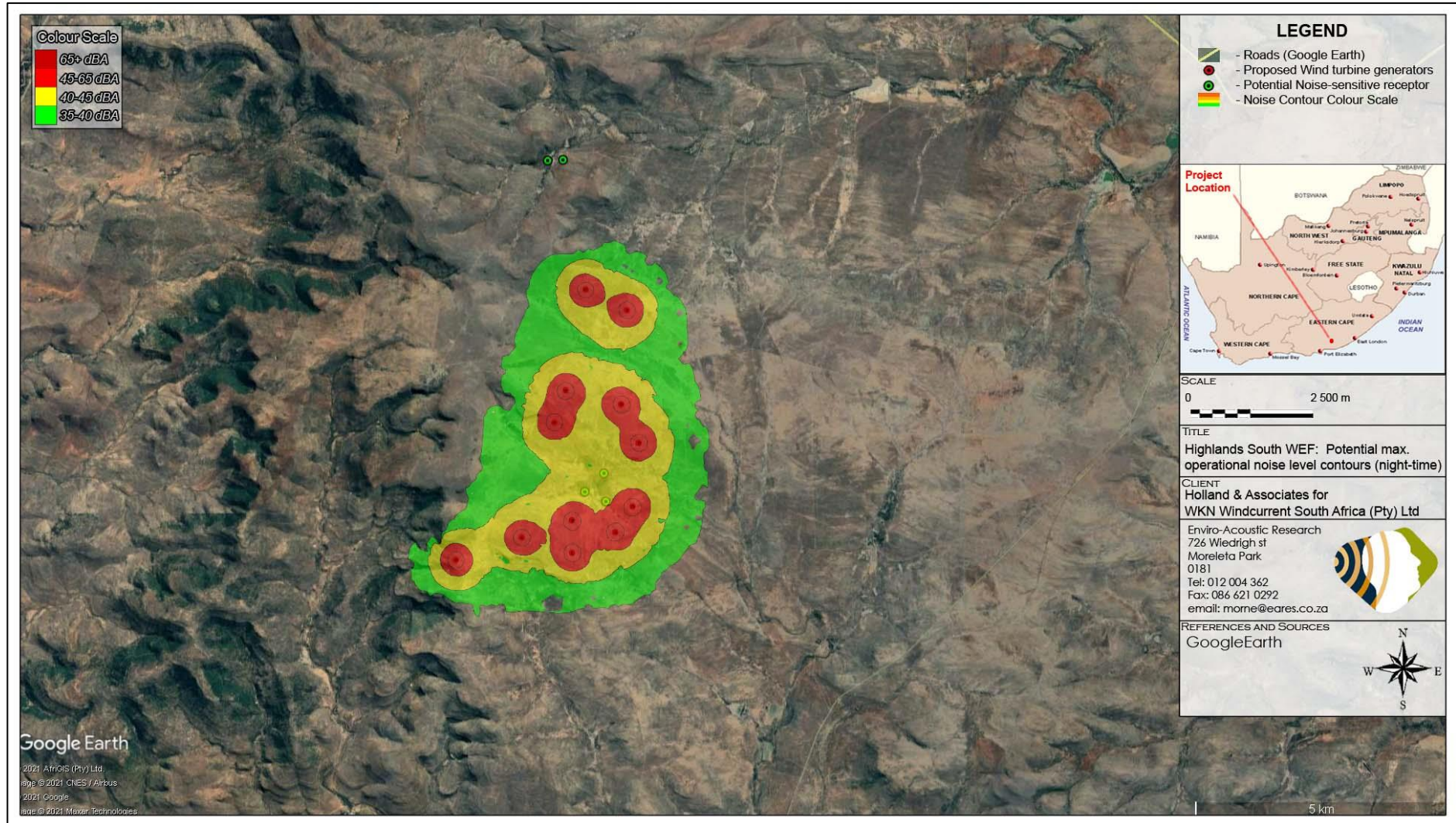

Figure 8-3: Projected maximum night-time operational noise rating levels due to operation of Highlands South WEF: Proposed amended layout

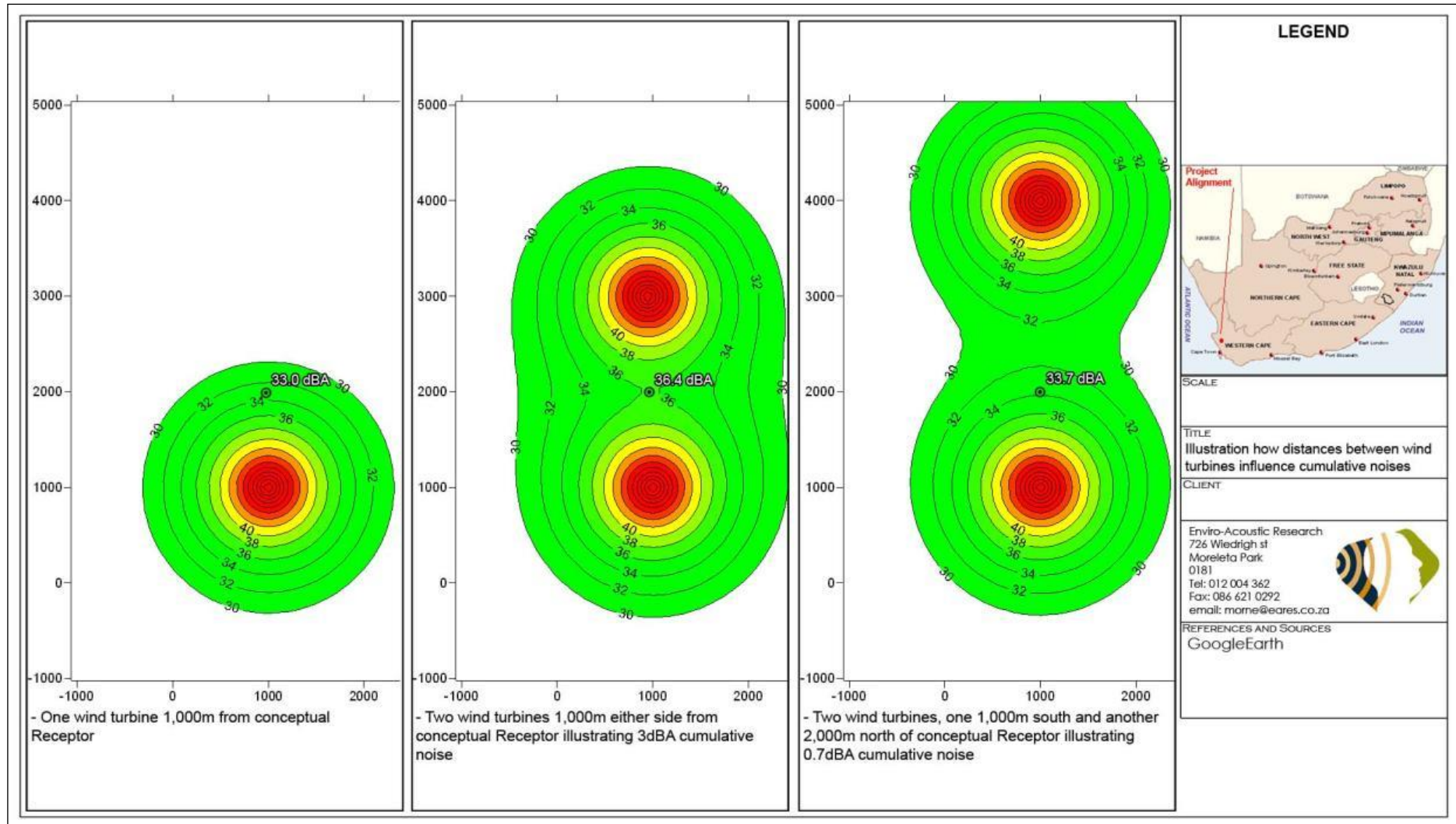

Figure 8-4: Effect of distance between wind turbines – potential cumulative noise

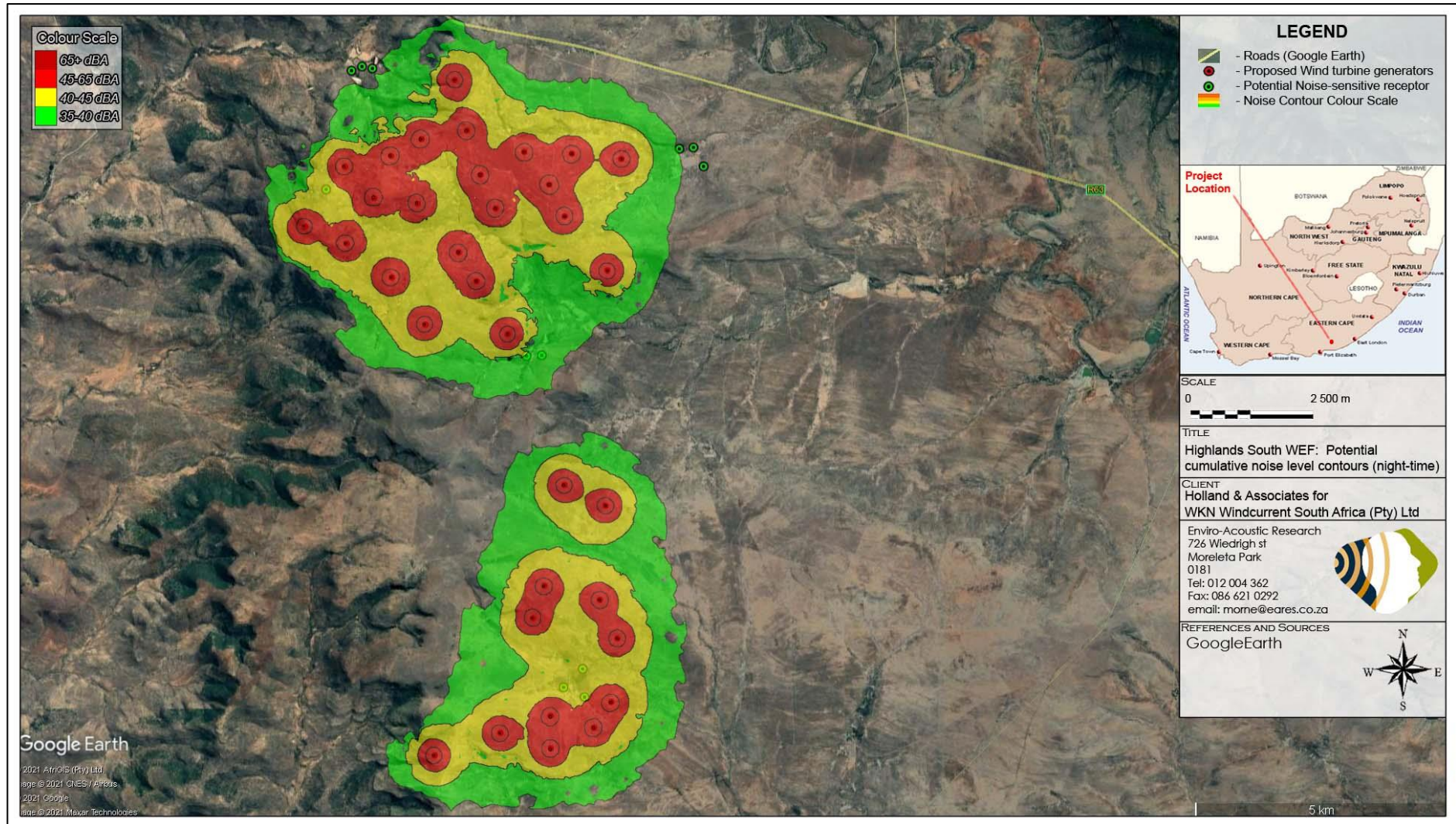

Figure 8-5: Projected cumulative maximum night-time operational noise levels

9 SIGNIFICANCE OF THE NOISE IMPACT

9.1 CONSTRUCTION PHASE NOISE IMPACT

The potential noise generating activities during construction are described in **section 5.1** and the magnitude defined in **section 8.1**. Considering the equivalent sound levels measured in the vicinity of the project site, daytime ambient sound levels (based on the full 16-hour daytime equivalent sound levels) range between 38 and 54 dBA with an average of 48 dBA. The night-time ambient sound levels (based on the 8-hour night-time equivalent sound levels) range between 36.6 and 51.7 dBA with an average of 41.68 dBA. This report will use an average night-time ambient sound level of 39.5 dBA.

The noise levels associated with the construction of the wind turbine generators can be estimated using **Figure 8-1**. The projected noise levels, as well as the potential noise impact at each receptor for any potential construction activities are defined in:

- **Appendix E, Table 1** for daytime construction activities (WTG construction);
- **Appendix E, Table 2** for night-time construction activities (WTG construction);
- **Appendix E, Table 3** for daytime construction activities (road construction); and,
- **Appendix E, Table 4** for daytime construction activities (construction traffic).

The significance of the potential daytime noise impacts is summarized in **Table 9-1** for potential daytime construction activities (for the highest noise level).

Table 9-1: Impact Assessment: Construction Activities during the day

Aspect / Impact pathway: Various construction activities (including use of a generator, construction of hard standing areas, excavation and concreting of foundations and the erection of the wind turbines) taking place simultaneously during the day will increase ambient sound levels due to air-borne noise. Noise levels due to construction activities close to the NSDs would be less than 47 dBA (at NSD 10). Noise levels are less at other NSDs.		
The potential impact is assessed per NSD in Appendix E, Table 1 . It should be noted that potential construction activities are expected to be clearly audible at receptor NSD 10 for a part of the construction phase.		
Nature of potential impact: Increase in ambient sound levels.		
Receiver no	Projected Noise Levels (Construction)	
All NSDs (see Figure 8-1)	Noise levels less than 52 dBA	Noise levels less than 52 dBA
	Without mitigation	With mitigation (not required)
Status (positive/negative)	Negative	Negative
Magnitude (Table 7-3)	High (8 – NSD 10)	High (8 – NSD 10)
Duration (Table 7-4)	Short (2)	Short (2)
Extent (Table 7-5)	Local (2)	Local (2)
Probability (Table 7-6)	Improbable (1)	Improbable (1)
Significance (Table 7-7)	Low Risk (12)	Low Risk (12)
Reversibility	High	High
Degree to which impact may cause irreplaceable loss of resources	Low	Low

Can impact be avoided, managed or mitigated?	Yes, but not required.	-
Confidence in findings: High. Worst-case scenario evaluated with all equipment operating under full load close to the potential receptors.		
Mitigation: Significance of noise impact is low for the scenario as conceptualized and therefore no specific mitigation measures are required for daytime construction activities.		
Cumulative impacts: Potential of cumulative noise impact is low.		

While night-time construction activities are not envisaged, there may be times when activities may take place after 22:00 at night, or before 06:00 in the mornings. Considering potential delays' relating to civil works (especially concrete pouring that must be undertaken in one go), the potential significance due to night-time construction activities was assessed in **Table 9-2**.

Table 9-2: Impact Assessment: Construction Activities at night

Aspect / Impact pathway: Various construction activities (use of generator, concreting of foundations and the erection of the wind turbines) taking place simultaneously at night will increase ambient sound levels due to air-borne noise. Noise levels due to construction activities may be as high as 47 dBA at NSD 10 (depending on the number of simultaneous activities taking place close to this receptor). This noise will be clearly audible at night (and may be considered disturbing), depending on the prevailing ambient sound levels as well as the number of simultaneous construction activities taking place.		
The potential impact is assessed per NSD in Appendix E, Table 2 . It should be noted that noises from construction activities will be significant at night and receptors may consider this to be disturbing, especially if the activities take place between the hours of 01:00 and 04:00 – quietest periods at night.		
Nature of potential impact: Increase in ambient sound levels.		
Receiver no	Projected Noise Levels (Construction)	
All NSDs (see Figure 8-1)	Noise levels as high as 52 dBA	Noise levels less than 40 dBA
	Without mitigation	With mitigation
Status (positive/negative)	Negative	Negative
Magnitude (Table 7-3)	High (8 – NSD 10)	High (8 – NSD 10)
Duration (Table 7-4)	Short (2)	Short (2)
Extent (Table 7-5)	Regional (3)	Regional (3)
Probability (Table 7-6)	Possible (2)	Possible (2)
Significance (Table 7-7)	Low Risk (26)	Low Risk (26)
Reversibility	High	High
Degree to which impact may cause irreplaceable loss of resources	Medium	Medium
Can impact be avoided, managed or mitigated?	Yes	-
Confidence in findings: High. Worst-case scenario evaluated with all equipment operating under full load. Very low night-time ambient sound levels assumed.		
Mitigation: There is a slight potential for a noise impact if multiple construction activities take place within 2 000 m from the identified NSDs. Night-time construction activities should be minimized where possible.		
Cumulative impacts: Potential of cumulative noise impact is low.		

The noise levels associated with the construction of the access roads can be estimated using **Figure 8-1**. From this figure it can be seen that the construction noise levels will only be higher than the acceptable zone sound level (45 dBA for a rural noise district during the day) if the road is closer than approximately 650 m from the closest receptors, although this noise impact is generally very temporary. Construction activities closer than 200 m from the identified NSDs could result in noise levels exceeding 55 dBA, higher than the IFC recommended noise limits for daytime residential use.

Considering the proposed amended layout of the WEF, it is possible that access roads could pass approximately 260 m from a potential receptor (NSD 10) and the projected noise levels relating to the construction of the road would be less than 55 dBA (less than the acceptable daytime noise rating level).

The potential magnitude of noise rating levels due to construction traffic can be estimated using **Figure 8-2**. While the graph depends on the average speed and number of vehicles, the figure can still be used to estimate potential noise impacts. For an average of 10 vehicles travelling at an average 60 km/h on a gravel road, noise from construction traffic will be well within the acceptable zone sound level (45 dBA) if the roads are further than approximately 60 m from the closest receptors (daytime construction activities). Considering the proposed amended layout of the WEF, it is possible that access roads could pass approximately 260 m from a potential receptor (NSD 10) and the projected noise levels would be less than 45 dBA. The potential impact of daytime traffic is assessed in **Table 9-4**.

Night-time traffic on the gravel roads could result in a noise level of up to 35 dBA at 600 m and around 42 dBA at 120 m (a potential disturbing noise) from the roads used for construction. This should be considered if any night-time activities are envisaged requiring significant traffic to pass within 120 m from residential dwellings at night.

Table 9-3: Impact Assessment: Construction of roads (daytime)

Aspect / Impact pathway: Construction of roads during the day may increase ambient sound levels temporarily. Road construction activities close to NSDs 8, 9 and 10, while it may be temporary, may result in noise levels as high as 49 dBA. Note: construction activities closer than 700 m from the identified NSDs could result in noise levels exceeding 45 dBA, higher than the zone sound levels for a rural area. The potential noise levels and impact is assessed per NSD in Appendix E, Table 3 .		
Nature of potential impact: Increase in ambient sound levels.		
Receiver no	Projected Noise Levels (Construction)	
All NSDs (see Figure 8-1 and Appendix E, Table 3)	Road construction activities	Road construction activities
	Without mitigation	With mitigation
Status (positive/negative)	Negative	Negative
Magnitude (Table 7-3)	High (8 – NSD 10)	High (8 – NSD 10)
Duration (Table 7-4)	Temporary (1)	Temporary (1)

Extent (Table 7-5)	Local (2)	Local (2)
Probability (Table 7-6)	Improbable (1)	Improbable (1)
Significance (Table 7-7)	Low Risk (11)	Low Risk (11)
Reversibility	High	High
Degree to which impact may cause irreplaceable loss of resources	Low	Low
Can impact be avoided, managed or mitigated?	Yes, but not required.	-
Confidence in findings: High. Worst-case scenario evaluated with construction of access road close to the NSDs.		
Mitigation: Significance of noise impact is low for the scenario as conceptualized and mitigation is not required.		
Cumulative impacts: Potential of cumulative noise impact is low.		

Table 9-4: Impact Assessment: Daytime construction traffic

Aspect / Impact pathway: Various construction vehicles passing close to potential noise-sensitive receptors may increase ambient sound levels and create disturbing noises. Appendix E, Table 4 assess the potential noise impact considering the potential access road alignments as well as the location of the closest NSDs.		
Nature of potential impact: Increase in ambient sound levels.		
Receiver no	Projected Noise Levels (Construction)	
All NSDs (see Figure 8-2)	Construction traffic passing residential dwellings	Construction traffic passing residential dwellings
	Without mitigation	With mitigation
Status (positive/negative)	Negative	Negative
Magnitude (Table 7-3)	Low (4) – All NSDs	Low (4) – All NSDs
Duration (Table 7-4)	Short (2)	Short (2)
Extent (Table 7-5)	Local (2)	Local (2)
Probability (Table 7-6)	Improbable (1)	Improbable (1)
Significance (Table 7-7)	Low Risk (8)	Low Risk (8)
Reversibility	High	High
Degree to which impact may cause irreplaceable loss of resources	Low	Low
Can impact be avoided, managed or mitigated?	Yes, but not required.	-
Confidence in findings: High. Worst-case scenario evaluated.		
Mitigation: Significance of noise impact is low and no additional mitigation are recommended or required.		
Cumulative impacts: Potential of cumulative noise impact is low.		

9.2 OPERATION PHASE NOISE IMPACT

The potential maximum noise levels associated with the operation phase is illustrated in **Figure 8-3**. The assumed ambient sound levels are also presented in **Figure 4-4** for a wind speed of 6 m/s (assuming an ambient sound level of 39.5 dBA). The potential significance of the noise impact is assessed per NSD, defined in **Appendix E, Table 5** for the daytime, and **Appendix E, Table 6** for the night-time scenarios respectively summarized:

- in **Table 9-5** for the daytime period;

- and in **Table 9-6** for the night-time period.

Using the criteria discussed in **Section 7.3.4**, considering **Figure 8-3**, the projected noise rating levels will be less than 45 dBA (the recommended acceptable night-time noise limit as per **section 7.3.3.2**) at all NSDs at a 6 m/s wind (using a maximum sound power emission level of 106.0 dBA re 1 pW). Noise level is higher than 42 dBA at two NSD's and the noises from the WTG may be annoying. Considering the most sensitive time period (night-time), based on the projected noise rating levels the following are observed:

- The change in ambient sound levels would be less than 5 dB when assuming ambient sound levels of 39.5 dBA (at a 6 m/s wind). The **magnitude** could be **Low (4)** for NSD 10 for the night-time period. It should be noted that it is expected that the wind turbines may be audible at this receptor at night;
- The duration will be the full project life - **Long term (4)**;
- The wind turbines may be audible further than 1 000 m during quiet periods - **Regional (3)**;
- Considering sound levels measured onsite (see **Figure 4-4**), average ambient sound levels could be higher than 45 dBA at times. Assuming a sound level typical of the L_{Aeq} graph, equivalent ambient sound levels could be around 39.5 dBA at a 6 m/s wind speed which will increase as wind speeds increase. Considering a worst-case scenario, the probability of a noise impact occurring is considered **Possible (2)**;
- The noise impact will stop once the project terminates and reversibility is **High**;
- There is a slight potential that closest surrounding noise-sensitive receptors lose an environment where natural noise dominates - **Medium**.

Table 9-5: Impact Assessment: Operational Activities during the day

Aspect / Impact pathway: Wind turbines (and BESS) operating simultaneously during the day, resulting in increased ambient sound levels. Considering Figure 9-1 , noise from the wind turbines will exceed the potential ambient sound levels (using a sound power emission levels of 108.5 and 106 dBA re 1 pW for all WTG) though the noise levels from the wind turbines will be less than 45 dBA. The noise levels are defined in Appendix E, Table 5 .		
Nature of potential impact: Increase in ambient sound levels.		
Receiver no	Projected Noise Levels	
All NSDs	Noise levels less than 45 dBA	Noise levels less than 45 dBA
	Without mitigation	With mitigation
Status (positive/negative)	Negative	Negative
Magnitude (Table 7-3)	Low (4 - NSD 10)	Low (4 - NSD 10)
Duration (Table 7-4)	Long (4)	Long (4)
Extent (Table 7-5)	Local (2)	Local (2)
Probability (Table 7-6)	Improbable (1)	Improbable (1)
Significance (Table 7-7)	Low Risk (10)	Low Risk (10)
Reversibility	High	High
Degree to which impact may cause irreplaceable loss of resources	Medium	Medium
Can impact be avoided, managed or mitigated?	Yes, but not required.	-

Confidence in findings: High. Worst-case scenario evaluated.
Mitigation: Significance of noise impact is low for the scenario as conceptualized and no specific mitigation is required.
Cumulative impacts: Potential of cumulative noise impact is low.

Table 9-6: Impact Assessment: Operational Activities at night

Aspect / Impact pathway: Wind turbines (and BESS) operating simultaneously at night. Increases in ambient sound levels due to air-borne noise from the wind turbines. Considering Figure 9-1 , noise from the wind turbines will exceed the potential ambient sound levels (using a sound power emission level of 108.5 and 106 dBA re 1 pW). The total noise level was calculated to be less than 45 dBA. The noise levels are defined in Appendix E, Table 6 .		
Nature of potential impact: Increase in ambient sound levels.		
Receiver no All NSDs (see Appendix E, Table 6)	Projected Noise Levels	
	Noise levels less than 45 dBA	Noise levels less than 45 dBA
	Without mitigation	With mitigation
Status (positive/negative)	Negative	Negative
Magnitude (Table 7-3)	Low (4)	Low (4)
Duration (Table 7-4)	Long (4)	Long (4)
Extent (Table 7-5)	Regional (3)	Regional (3)
Probability (Table 7-6)	Possible (2)	Possible (2)
Significance (Table 7-7)	Low Risk (22)	Low Risk (22)
Reversibility	High	High
Degree to which impact may cause irreplaceable loss of resources	Medium	Medium
Can impact be avoided, managed or mitigated?	Yes, but not required.	-
Confidence in findings: High. Worst-case scenario evaluated.		
Mitigation: Significance of noise impact is low for the scenario as conceptualized and additional mitigation measures are not required.		
Cumulative impacts: Potential of cumulative noise impact is low.		

As highlighted in **section 5.2.4**, noise levels from a BESS are very low and the significance of this noise impact will be low for both the day- and night-time periods.

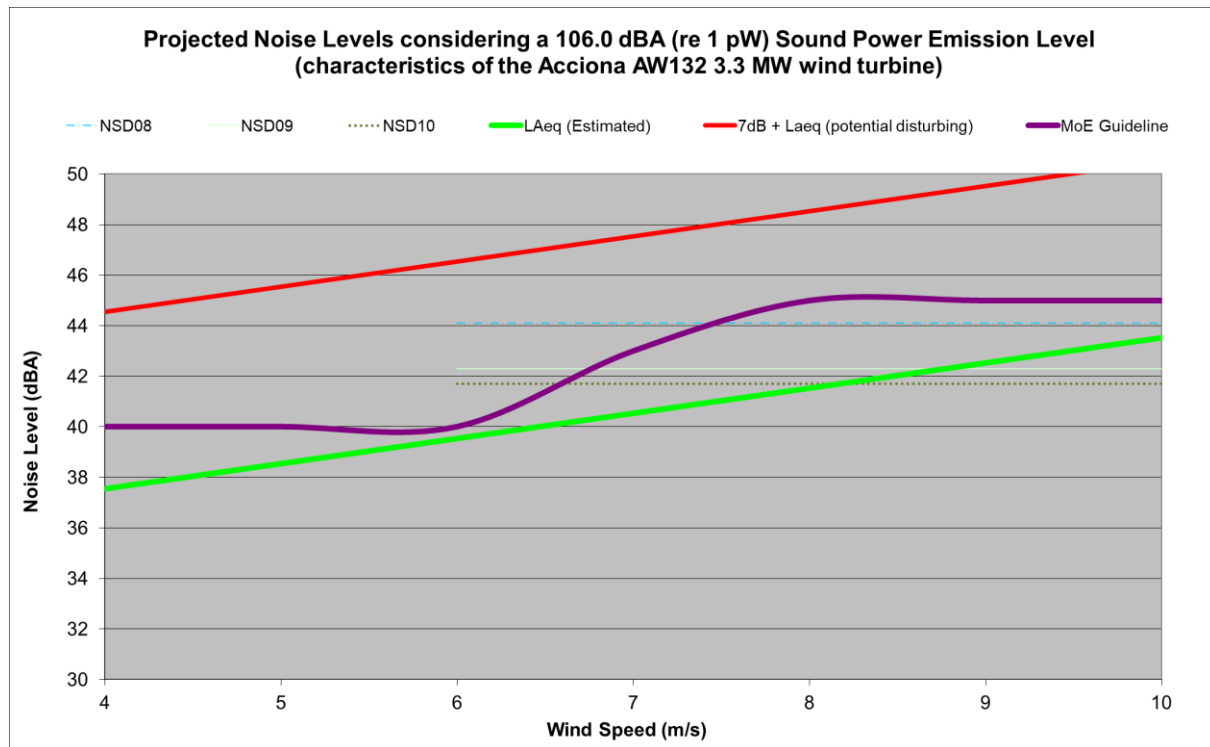

Figure 9-1: Projected noise levels at different wind speeds

9.3 CUMULATIVE NOISE IMPACT

There is a very low risk of cumulative noises during the construction phase, as noises from other construction activities (at other WEFs) are highly unlikely to result in cumulative construction noise impacts. The potential significance of the cumulative noise impacts during the operational phase is very low as defined in **Table 9-8**. This is because of the distance between the Highlands South and Highland Central WEFs, as well as a non-existent probability of a noise impact occurring.

Table 9-7: Impact Assessment: Potential Cumulative Construction Noise Impacts

Aspect / Impact pathway: Potential cumulative noise impacts due to construction activities.		
Nature of potential impact: Increase in ambient sound levels.		
Receiver no	Projected Noise Levels	
All NSDs	Noise levels similar to the construction phase noise levels for the individual projects. Change in sound level due to cumulative effects will be less than 3 dB.	
	Overall impact of the proposed project considered in isolation	Cumulative impact of the project and other projects in the area
Status (positive/negative)	Negative	Negative
Magnitude (Table 7-3)	Minor (2)	Minor (2)
Duration (Table 7-4)	Short (2)	Short (2)
Extent (Table 7-5)	Local (2)	Local (2)
Probability (Table 7-6)	Improbable (1)	Improbable (1)
Significance (Table 7-7)	Low Risk (6)	Low Risk (6)
Reversibility	High	High

Degree to which impact may cause irreplaceable loss of resources	Medium	Medium
Can impact be avoided, managed or mitigated?	Yes, but not required.	Yes, but not required.
Confidence in findings: High. Worst-case scenario evaluated.		
Mitigation: Significance of noise impact is low for the scenario as conceptualized.		
Cumulative impacts: Potential of cumulative noise impact is low.		

Considering **Figure 8-5**, the contribution from the Highlands South WEF on total cumulative noises (if all three Highlands projects are developed) will be less than 3 dBA and total noise levels will be less than 45 dBA. The potential significance of the cumulative noise impacts during the operational phase is low as defined in **Table 9-8**.

Table 9-8: Impact Assessment: Potential Cumulative Operational Noise Impacts

Aspect / Impact pathway: Wind turbines from various WEFs operating simultaneously. Increases in ambient sound levels due to air-borne noise from all the wind turbines in area.		
Nature of potential impact: Increase in ambient sound levels.		
Receiver no	Projected Noise Levels	
All NSDs	Potential cumulative noise levels during the operational phase will be less than 45 dBA. Changes in sound level will be less than 3 dB as defined in Appendix E, Table 7 .	
	Overall impact of the proposed project considered in isolation	Cumulative impact of the project and other projects in the area
Status (positive/negative)	Negative	Negative
Magnitude (Table 7-3)	Minor (2)	Minor (2)
Duration (Table 7-4)	Long (4)	Long (4)
Extent (Table 7-5)	Regional (3)	Regional (3)
Probability (Table 7-6)	Improbable (1)	Improbable (1)
Significance (Table 7-7)	Low Risk (9)	Low Risk (9)
Reversibility	High	High
Degree to which impact may cause irreplaceable loss of resources	Medium	Medium
Can impact be avoided, managed or mitigated?	Yes, but not required.	Yes, but not required.
Confidence in findings: High. Worst-case scenario evaluated.		
Mitigation: Significance of noise impact is low for the scenario as conceptualized.		
Cumulative impacts: Potential of cumulative noise impact is low.		

9.4 DECOMMISSIONING PHASE NOISE IMPACT

Final decommissioning activities typically have a noise impact lower than either the construction or operation phases. This is because decommissioning and closure activities normally take place during the day using minimal equipment (due to the decreased urgency of the project) and because decommissioning activities are normally limited to the day-time period (when the acceptable zone sound level is higher). As such the significance of

the potential noise impact would be **Low** during the decommissioning phase (without mitigation).

9.5 COMPARATIVE FINDINGS CONSIDERING PREVIOUS NOISE STUDY

The findings of the previous noise assessment (Reid, 2018) (for the authorized WEF) are summarized in **Table 9-9**, with the findings of the re-assessment (for the proposed amendments) summarized in **Table 9-10**. Reasons for the difference are difficult to define, and may relate to changes in the layout of the wind farm, modelling approach and assumptions as well as the Basic Assessment criteria employed.

Table 9-9: Summary of findings from original noise study (for the authorized WEF) (Reid, 2018)

Potential Impact Assessed	Significance rating	
	Without mitigation	With mitigation
Construction Phase: Tracks and Hard standing	Medium	Low
Construction Phase: Tracks and Hard standing, Cumulative Impact	Medium	Low
Construction Phase: Excavation and concreting foundations	Medium	Low
Construction Phase: Excavation and concreting foundations, Cumulative Impact	Medium	Low
Construction Phase: turbine erection	Medium	Low
Construction Phase: turbine erection, Cumulative impact	Medium	Low
Construction Phase: Generator (night-time use)	Low	Low
Construction Phase: Generator (night-time use), Cumulative Impact	Low	Low
Operational Phase: Daytime operation	Low	Low
Operational Phase: Daytime operation, Cumulative Impact	Low	Low
Operational Phase: Night-time operation	High	Medium
Operational Phase: Night-time operation, Cumulative impact	High	Medium

Table 9-10: Summary of findings from this re-assessment (for the proposed amendments) (de Jager, 2021)

Potential Impact Assessed	Significance rating	
	Without mitigation	With mitigation
Construction Phase: Activities during day	Low	Low
Construction Phase: Activities at night	Low	Low
Construction Phase: daytime road construction	Low	Low
Construction Phase: daytime traffic	Low	Low
Operational Phase: Day-time operation	Low	Low
Operational Phase: Night-time operation	Low	Low
Cumulative Impact: Construction Phase	Low	Low
Cumulative Impact: Operational Phase	Low	Low

10 MITIGATION MEASURES

This study considers the potential noise impact on the surrounding environment due to the construction, operational and future decommissioning activities associated with the Highlands South WEF. It was determined that the potential noise impacts, without mitigation, would be:

- of a **low significance** for the daytime construction activities (hard standing areas, excavation and concreting of foundations and the erection of the wind turbines);
- of a **low significance** for the night-time construction activities (generally for the concreting of foundations and the erection of the wind turbines);
- of a **low significance** for the construction of access roads and tracks;
- of a **low significance** relating to the construction traffic passing residential dwellings;
- of a **low significance** for daytime operational activities (noises from wind turbines); and
- of a **low significance** for night-time operational activities (noises from wind turbines).

Potential cumulative noise impacts will be insignificant, resulting in a noise impact of low significance for both the construction and operational phases.

The developer must know that community involvement needs to continue throughout the project. Annoyance is a complicated psychological phenomenon, as with many industrial operations, expressed annoyance with sound can reflect an overall annoyance with the project, rather than a rational reaction to the sound itself. At all stages, surrounding receptors should be informed about the project, providing them with factual information without setting unrealistic expectations. It is counterproductive to suggest that the activities (or facility) will be inaudible due to existing high ambient sound levels. The magnitude of the sound levels will depend on a multitude of variables and will vary from day to day and from place to place with environmental and operational conditions. Audibility is distinct from the sound level, because it depends on the relationship between the sound level from the activities, the spectral character and that of the surrounding soundscape (both level and spectral character).

The developer must implement a line of communication (i.e. a help line where complaints could be lodged). All potential sensitive receptors should be made aware of these contact numbers. The proposed WEF should maintain a commitment to the local community

(people staying within 2,000 m from construction or operational activities) and respond to noise concerns in an expedient fashion. Sporadic and legitimate noise complaints could be raised. For example, sudden and sharp increases in sound levels could result from mechanical malfunctions or perforations or slits in the blades. Problems of this nature can be corrected quickly and it is in the developer's interest to do so.

Continuing management objectives would be:

- Ensure that total noise levels due to operational activities are less than 45 dBA at all potential NSDs (dwellings used for residential purposes); and
- Prevent the generation of nuisance noises.

10.1 MITIGATION OPTIONS AVAILABLE TO REDUCE NOISE IMPACT DURING THE CONSTRUCTION PHASE

The significance of noise during the construction of the WTG's (hard standing, digging of foundations, civil works, erection of turbine) phase, the development of the access road (for all NSDs) and construction traffic will have a noise impact of a **low** significance for both the daytime and potential night-time construction activities.

It is recommended that the following mitigation measures replace the previous mitigation measures (as proposed by Reid, 2018) in the updated EMPr:

- With regard to unavoidable noisy construction activities in the vicinity of noise sensitive areas (closer than 500 m from any identified NSD), the contractor and ECO must liaise with local residents on how best to minimise impact and they must be kept informed of the nature and duration of intended activities;
- Blasting operations are to be strictly controlled with regard to the size of explosive charge in order to minimise noise and air blast, and timings of explosions. The number of blasts per day must be limited, blasting must be undertaken at the same times each day and no blasting must be allowed at night;
- Construction equipment must be kept in good working order and where appropriate fitted with silencers which are kept in good working order;
- Where practicable, mobile equipment should be fitted with broadband (white-noise generators), rather than tonal reverse alarms;
- The use of vehicle horns should be limited to emergency use only; and
- Public relations should be maintained with local residents that may be affected by noise from site operations.

10.2 MITIGATION OPTIONS AVAILABLE TO REDUCE NOISE IMPACT DURING OPERATION

The significance of noise during the operation phase is **Low** (both day- and night-time operation) and additional mitigation measures are not required.

It is recommended that the mitigation measures defined in the original noise study (Reid, 2018) be removed and replaced with the condition:

- The developer must ensure that the noise levels due to operating wind turbines are less than 45 dBA at NSD10 and that the noise does not change the existing ambient sound levels with more than 7 dB.

The measurement of ambient sound and noise levels are discussed in **section 11**. The developer may consider the use of a mitigated WTG (such as a WTG with a sound power emission level of 106 dBA) at locations T34 and T36 to reduce the noise level to less than 42 dBA.

10.3 MITIGATION OPTIONS AVAILABLE TO REDUCE NOISE IMPACT DURING DECOMMISSIONING

The potential significance of the noise impact would be similar as the construction phase (low significance) and no further mitigation is recommended or required for the decommissioning phase.

10.4 SPECIAL CONDITIONS

10.4.1 Mitigation options that should be included in the updated Environmental Management Programme (EMPr)

1. The potential noise impact must be evaluated again should the layout be revised where any wind turbines are located closer than 1,000 m from a confirmed NSD.
2. The potential noise impact must be evaluated again should the developer make use of a wind turbine with a maximum sound power emission level exceeding 108.5 dBA re 1 pW.
3. The developer must confirm with the land owner that the dwellings at NSD 8 and 9 will not be used for residential purposes during the operational phase.
4. The developer should implement a noise monitoring programme at NSD10. If the developer selects to use a wind turbine with a sound power emission level less than 106.0 dBA (re 1 pW) at turbine location T34 and T36 (such as the mitigated Acciona AW132), no noise monitoring will be required; and

5. The developer must investigate any reasonable and valid noise complaint if registered by a receptor staying within 2,000 m from the location where construction or decommissioning activities are taking place, or a location where an operational wind turbine is present. A complaints register must be kept on site.

11 ENVIRONMENTAL NOISE MONITORING PLAN

Environmental Noise Monitoring can be divided into two distinct categories, namely:

- Passive monitoring – the registering of any complaints (reasonable and valid) regarding noise; and
- Active monitoring – the measurement of ambient sound (or noise) levels at identified locations.

While the total projected noise levels are less than 45 dBA (the noise levels from the operating wind turbines are 44.2 dBA at NSD10 for a wind turbine with a sound power emission level of 108.5 dBA (re 1 pW)) active noise monitoring is recommended.

If the developer selects to use a wind turbine with a sound power emission level of 106.0 dBA (re 1 pW)) at WTG location T34 and T36, the total projected noise levels will be less than 42 dBA at NSD10 and active noise monitoring will not be required.

In addition, should a reasonable and valid noise complaint be registered, the WEF developer should investigate the noise complaint as per the guidelines below. These guidelines should be used as a rough guideline as site specific conditions may require that the monitoring locations, frequency or procedure be adapted.

11.1 MEASUREMENT LOCALITIES AND FREQUENCY

Once-off noise measurements are recommended at the location of NSD10 before the construction phase start, to allow the defining of existing ambient sound levels. Once the WEF is operational, noise measurements should be repeated to assess the noise levels at NSD10. If the developer selects to use a wind turbine with a sound power emission level less than 106.0 dBA (re 1 pW) at turbine location T34 and T36 (such as the mitigated Acciona AW132), no noise monitoring will be required

Should there be a noise complaint, once-off noise measurements must be conducted at the location of the person that registered a valid and reasonable noise complaint. The measurement location should consider the direct surroundings to ensure that other sound sources cannot influence the reading.

11.2 MEASUREMENT PROCEDURES

Ambient sound measurements should be collected as defined in SANS 10103:2008, though measurements in terms of ETSU-R97 are highly recommended. Due to the variability that naturally occurs in sound levels at most locations, it is recommended that semi-continuous measurements are conducted over a period of at least 48 hours (the ETSU-R97 protocol require a significantly larger measurement sample), covering at least a full day- (06:00 – 22:00) and two night-time (22:00 – 06:00) periods. When a noise complaint is being investigated, measurements should be collected during a period or in conditions similar to when the receptor experienced the disturbing noise event.

12 CONCLUSIONS AND RECOMMENDATIONS

This report is an Environmental Noise Impact Assessment of the noise impacts due to the proposed amendments to the project of the authorized Highlands South WEF (and associated infrastructure) west of Somerset East in the Eastern Cape Province. It is based on predictive models to estimate potential noise levels due to the various activities and to assist in the identification of potential issues of concern and the implication of the proposed amendments.

Conceptual scenarios were developed for the construction and operation phases. With the modelled input data as used, this assessment indicated that:

- A potential noise impact of a **low** significance (with and without mitigation) relating to activities associated with the development of hardstanding areas, foundations, civil work and erecting the WTG during the day;
- A potential noise impact of a **low significance** for the night-time construction activities (generally for the concreting of foundations and the erection of the wind turbines);
- A potential noise impact of a **low** significance (with and without mitigation) relating to the construction of the access roads;
- A potential noise impact of a **low** significance (with and without mitigation) relating to the use of access roads during the construction phase;
- A potential noise impact of a **low** significance (with and without mitigation) for operation of the proposed wind turbines during the day;
- A potential noise impact of a **low significance** for night-time operational activities (noises from wind turbines);
- A potential noise impact of a **low** significance (with and without mitigation) for the decommissioning of the proposed WEF;
- The development of the amended Highlands South WEF will not increase cumulative noises in the area during the construction phase;
- The development of the amended Highlands South WEF will not increase cumulative noises in the area during the operational phase; and
- The addition of a BESS will not increase noise levels and the significance of the noises from the BESS will be **low** (both construction and operational).

Considering the outcome of the modelling, based on the conceptual scenarios as envisaged and input parameters used:

- The proposed amendments to the project will not result in an increased level or significance of the noise impact, nor result in a change in the nature of potential noise impacts;

- The proposed amendments to the project have the advantage that it will decrease the projected noise levels as well as the significance of the noise impact during the construction and operational phase;
- The proposed amendments to the project, due to the slightly lower noise levels, will require less mitigation measures and management as recommended in the original noise study (Reid, 2018). Updates to the mitigation measures were included to clarify statements and prevent ambiguity when considering the mitigation measures. The mitigation measures include:
 - With regard to unavoidable noisy construction activities in the vicinity of noise sensitive areas (closer than 500 m from any identified NSD), the contractor and ECO must liaise with local residents on how best to minimise impact and they must be kept informed of the nature and duration of intended activities;
 - Blasting operations are to be strictly controlled with regard to the size of explosive charge in order to minimise noise and air blast, and timings of explosions. The number of blasts per day must be limited, blasting must be undertaken at the same times each day and no blasting must be allowed at night;
 - Construction equipment must be kept in good working order and where appropriate fitted with silencers which are kept in good working order;
 - Where practicable, mobile equipment should be fitted with broadband (white-noise generators), rather than tonal reverse alarms;
 - The use of vehicle horns should be limited to emergency use only;
 - Road trucks should slow down well before the turn onto the project site to prevent the use of air brakes; and
 - Public relations should be maintained with local residents that may be affected by noise from site operations;
 - The developer should implement a noise monitoring programme at NSD10. If the developer selects to use a wind turbine with a sound power emission level less than 106.0 dBA (re 1 pW) at turbine location T34 and T36 (such as the mitigated Acciona AW132), no noise monitoring will be required; and
 - The developer must investigate any reasonable and valid noise complaint if registered by a receptor staying within 2,000 m from the location where construction or decommissioning activities are taking place, or a location where an operational wind turbine is present. A complaints register must be kept on site.

It is recommended that the proposed amendments to the authorized Highlands South WEF be authorized.

13 REFERENCES

In this report reference was made to the following documentation:

1. Acciona, 2014: *General Document, Sound Power Levels AW132/3000*. Doc DG200506, Spain
2. Acoustics, 2008: *A review of the use of different noise prediction models for wind farms and the effects of meteorology*
3. Acoustics Bulletin, 2009: *Prediction and assessment of wind turbine noise*
4. Ambrose, SE and Rand, RW, 2011. *The Bruce McPherson Infrasound and Low Frequency Noise Study: Adverse health effects produced by large industrial wind turbines confirmed*. Rand Acoustics, December 14, 2011.
5. Audiology Today, 2010: *Wind-Turbine Noise – What Audiologists should know*
6. Autumn, Lyn Radle, 2007: *The effect of noise on Wildlife: A literature review*
7. Atkinson-Palombo, C and Hoen, B. 2014: *Relationship between Wind Turbines and Residential Property Values in Massachusetts – A Joint Report of University of Connecticut and Lawrence Berkley National Laboratory*. Boston, Massachusetts
8. Bakker, RH et al. 2011: *Effects of wind turbine sound on health and psychological distress*. Science of the Total Environment (in press, 2012)
9. Barber, J.R., K.R. Crooks, and K. Fristrup. 2010. *The costs of chronic noise exposure for terrestrial organisms*. Trends Ecology and Evolution 25(3): 180–189
10. Bass JH et al, 1996: *Development of a wind farm noise propagation prediction model*. JH Bass, AJ Bullmore, E Sloth. Contract JOR3-CT95-0051. Renewable Energy Systems Limits, Hoare Lea & Partners Acoustics, Acoustica A/S
11. Bayne EM et al, 2008: *Impacts of chronic anthropogenic noise from energy-sector activity on abundance of songbirds in the boreal forest*. Conservation Biology 22(5) 1186-1193.
12. Bolin et al, 2011: *Infrasound and low frequency noise from wind turbines: exposure and health effects*. Environ. Res. Lett. 6 (2011) 035103
13. Bowdler, Dick, 2008: *Amplitude modulation of wind turbine noise: a review of the evidence*
14. Bray, W and James, R. 2011. *Dynamic measurements of wind turbine acoustic signals, employing sound quality engineering methods considering the time and frequency sensitivities of human perception*. Noise-Con 2011.
15. BWEA, 2005: *Low Frequency Noise and Wind Turbines – Technical Annex*
16. Chapman et al. 2013: *Spatio-temporal differences in the history of health and noise complaints about Australian wind farms: evidence for the psychogenic, "communicated disease" hypothesis*. Sydney School of Public Health, University of Sydney

17. Chief Medical Officer of Health, 2010: *The Potential Health Impact of Wind Turbines*, Canada
18. Cooper, 2012: *Are Wind Farms too close to communities*, The Acoustic Group (date posted on Wind-watch.org: Referenced on various anti-wind energy websites)
19. Crichton *et al.* 2014: *Can expectations produce symptoms from infrasound associated with wind turbines? Health Psychology, Vol 33(4), Apr 2014, 360-364*
20. CSIR, 2002: *Integrated Environmental Management Information Series: Information Series 5: Impact Assessment*. Issued by the Department of Environmental Affairs and Tourism, Pretoria
21. CSIR, 2015: *The Strategic Environmental Assessment for Wind and Solar Photovoltaic Energy in South Africa*. Issued by the Department of Environmental Affairs and Tourism, Pretoria
22. Cummings, J. 2012: *Wind Farm Noise and Health: Lay summary of new research released in 2011*. Acoustic Ecology Institute, April 2012 (online resource: http://www.acousticecology.org/wind/winddocs/AEI_WindFarmsHealthResearch2011.pdf)
23. Cummings, J. 2009: *AEI Special Report: Wind Energy Noise Impacts*. Acoustic Ecology Institute, (online resource: <http://acousticecology.org/srwind.html>)
24. DEFRA, 2003: *A Review of Published Research on Low Frequency Noise and its Effects*, Report for Defra by Dr Geoff Leventhall Assisted by Dr Peter Pelmear and Dr Stephen Benton
25. DEFRA, 2007: *Research into Aerodynamic Modulation of Wind Turbine Noise: Final Report*
26. DELTA, 2008: *EFP-06 project: Low Frequency Noise from Large Wind Turbines, a procedure for evaluation of the audibility for low frequency sound and a literature study*. Danish Energy Authority
27. Derryberry EP *et al*, 2016: *Patterns of song across Natural and Anthropogenic Soundscapes suggest that White-Crowned Sparrows minimize acoustic masking and maximize signal content*. PLOS ONE| DOI: 10.1371/journal.pone.0154456, April 29, 2016
28. Dooling, R. 2002. *Avian Hearing and the Avoidance of Wind Turbines*. National Renewable Energy Laboratory, NREL/TP-500-30844
29. Dooling R. J., and A. N. Popper. 2007. *The effects of highway noise on birds*. Report to the California Department of Transportation, contract 43AO139. California Department of Transportation, Division of Environmental Analysis, Sacramento, California, USA

30. Duncan, E. and Kaliski, K. 2008: *Propagation Modelling Parameters for Wind Power Projects*
31. Enertrag, 2008: *Noise and Vibration*. Hempnall Wind Farm (<http://www.enertraguk.com/technical/noise-and-vibration.html>)
32. ETSU R97: 1996. 'The Assessment and Rating of Noise from Wind Farms: Working Group on Noise from Wind Turbines'
33. Evans Tom, Cooper Jonathan, 2012: *Comparison of predicted and measured wind farm noise levels and implications for assessments of new wind farms*. Acoustics Australia, Vol. 40, No. 1, April 2012.
34. Garrad Hassan, 2013: *Summary of results of the noise emission measurement, in accordance with IEC 61400-11, of a WTGS of the type N117/3000*. Doc. GLGH-4286 12 10220 258-S-0002-A (extract from GLGH-4286 12 10220 258-A-0002-A)
35. Gibbons, S. 2014: *Gone with the Wind: Valuing the Visual Impacts of Wind turbines through House Prices*, Spatial Economics Research Centre
36. Guillaume Dutilleux. *Anthropogenic outdoor sound and wildlife: it's not just bioacoustics!*. Soci 'et 'e Fran ,caise d'Acoustique. Acoustics 2012, Apr 2012, Nantes, France
37. Hanning, 2010: *Wind Turbine Noise, Sleep and Health*. (referenced on a few websites, especially anti-wind energy. No evidence that the study has been published formally.)
38. Havas, M and Colling, D. 2011: *Wind Turbines Make Waves: Why Some Residents Near Wind Turbines Become Ill*. *Bulletin of Science Technology & Society* published online 30 September 2011
39. Hessler, D. 2011: *Best Practices Guidelines for Assessing Sound Emissions From Proposed Wind Farms and Measuring the Performance of Completed Projects*. Prepared for the Minnesota Public Utilities Commission, under the auspices of the National Association of Regulatory Utility Commissioners (NARUC)
40. HGC Engineering, 2006: *Wind Turbines and Infrasound*, report to the Canadian Wind Energy Association
41. HGC Engineering, 2007: *Wind Turbines and Sound*, report to the Canadian Wind Energy Association
42. HGC Engineering, 2011: *Low frequency noise and infrasound associated with wind turbine generator systems: A literature review*. Ontario Ministry of the Environment RFP No. OSS-078696.
43. IFC, 2007: '*Environmental, Health, and Safety General Guidelines*'. International Finance Corporation, Washington

44. IFC, 2015: '*Environmental, Health, and Safety Guidelines for Wind Energy*'. International Finance Corporation, Washington
45. ISO 9613-2: 1996. '*Acoustics – Attenuation of sound during propagation outdoors – Part 2: General method of calculation*'
46. Jeffery *et al*, 2013: *Adverse health effects of industrial wind turbines*, Can Fam Physician, 2013 May. 59(5): 473-475
47. Journal of Acoustical Society of America, 2009: *Response to noise from modern wind farms in the Netherlands*
48. Kaliski K & Duncan E, 2008: *Propagation modelling Parameters for Wind Power Projects*.
49. Kaliski K & Wilson DK. 2011: *Improving predictions of wind turbine noise using PE modelling*. Noise-con 2011.
50. Kamperman GW & James RR, 2008: *The "How to" guide to siting wind turbines to prevent health risks from sound*
51. Knopper LD & Ollsen CA. 2011. *Health effects and wind turbines: A review of the literature*. Environmental Health 2011, 10:78
52. Kroesen & Schreckenber, 2011. *A measurement model for general noise reaction in response to aircraft noise*. J. Acoust. Soc. Am. 129 (1), January 2011, 200-210
53. Lohr B *et al*, 2003. *Detection and discrimination of natural calls in masking noise by birds: estimating the active space of a signal*. B Lohr, TF Wright & RJ Dooling. Animal Behavior 65:763-777
54. McMurtry RY, 2011: *Toward a Case Definition of Adverse Health Effects in the Environs of Industrial Wind Turbines: Facilitating a Clinical Diagnosis*. Bulletin of Science Technology Society. August 2011 vol. 31 no. 4 316-320
55. Minnesota Department of Health, 2009: *Public Health Impacts of Wind Farms*
56. Ministry of the Environment, 2008: *Noise Guidelines for Wind Farms, Interpretation for Applying MOE NPC Publications to Wind Power Generation Facilities*
57. Møller H, 2010: *Low-frequency noise from large wind turbines*. J. Acoust. Soc. Am, 129(6), June 2011, 3727 - 3744
58. Nissenbaum A, 2012: *Effects of industrial wind turbine noise on sleep and health*. Noise and Health, Vol. 14, Issue 60, p 237 – 243.
59. Noise-con, 2008: *Simple guidelines for siting wind turbines to prevent health risks*
60. Noise quest, Aviation Noise Information &Resources, 2010: <http://www.noisequest.psu.edu/pmwiki.php?n=Main.HomePage>
61. Norton, M.P. and Karczub, D.G.: *Fundamentals of Noise and Vibration Analysis for Engineers*, Second Edition, 2003

62. Oud, M. 2012: *Low-frequency noise: a biophysical phenomenon* (http://www.leefmilieu.nl/sites/www3.leefmilieu.nl/files/imported/pdf_s/2012_OudM_Low-frequency%20noise_0.pdf) (unpublished webresource)
63. O'Neal, et al. 2011: *Low frequency noise and infrasound from wind turbines*. Noise Control Eng. J. 59 (2), March-April 2011
64. Parry G, 2008: *A review of the use of different noise prediction models for windfarms and the effect of meteorology*. Acoustics 2008, Paris.
65. Pedersen, Eja; Halmstad, Högskolan I, 2003: '*Noise annoyance from wind turbines: a review*'. Naturvårdsverket, Swedish Environmental Protection Agency, Stockholm
66. Pedersen, E. 2011: "*Health aspects associated with wind turbine noise—Results from three field studies*", Noise Control Eng. J. 59 (1), Jan-Feb 2011
67. Phillips, CV, 2011: "*Properly Interpreting the Epidemiologic Evidence About the Health Effects of Industrial Wind Turbines on Nearby Residents*". Bulletin of Science Technology & Society 2011 31: 303 DOI: 10.1177/0270467611412554
68. Pierpont, N. 2009: "*Wind Turbine Syndrome: A Report on a Natural Experiment*", K Select Books, 2009
69. Punch, et al. 2010: *Wind Turbine Noise. What Audiologists should know*. Audiology Today. JulAug2010
70. Quinn, J.L., M.J. Whittingham, S.J. Butler, and W. Cresswell. 2006. *Noise, predation risk compensation and vigilance in the chaffinch Fringilla coelebs*. Journal of Avian Biology 37: 601-608
71. Rabin, L.A., R.G. Coss, D.H. Owings. 2006. *The effects of wind turbines on antipredator behavior in California ground squirrels (Spermophilus beecheyi)*. Biological Conservation 131: 410-420
72. Reid, M. 2018: *Proposed Highlands Wind Energy Facilities – Eastern Cape Province – Environmental Impact Assessment Report – Noise*. Arcus Consultancy Services, Glasgow
73. Renewable Energy Research Laboratory, 2006: *Wind Turbine Acoustic Noise*
74. Report to Congressional Requesters, 2005: *Wind Power – Impacts on Wildlife and Government Responsibilities for Regulating Development and Protecting Wildlife*
75. SANS 10103:2008. '*The measurement and rating of environmental noise with respect to annoyance and to speech communication*'.
76. SANS 10210:2004. '*Calculating and predicting road traffic noise*'.
77. SANS 10328:2008. '*Methods for environmental noise impact assessments*'.
78. SANS 10357:2004. *The calculation of sound propagation by the Concave method*'.
79. Schaub, A, J. Ostwald and B.M. Siemers. 2008. "*Foraging bats avoid noise*". The Journal of Experimental Biology 211: 3174-3180

80. Sheperd, D and Billington, R. 2011: *Mitigating the Acoustic Impacts of Modern Technologies: Acoustic, Health, and Psychosocial Factors Informing Wind Farm Placement*. *Bulletin of Science Technology & Society* published online 22 August 2011, DOI: 10.1177/0270467611417841
81. Shepherd, D *et al*. 2011: *Evaluating the impact of wind turbine noise on health related quality of life*. *Noise & Health*, September-October 2011, 13:54,333-9.
82. Smith, M (*et al*) (2012): "*Mechanisms of amplitude modulation in wind turbine noise*"; Proceedings of the Acoustics 2012 Nantes Conference
83. Stigwood (*et al*) (2013): "*Audible amplitude modulation – results of field measurements and investigations compared to psycho-acoustical assessments and theoretical research*"; Paper presented at the 5th International Conference on Wind Turbine Noise, Denver 28 – 30 August 2013
84. Tachibana, H (*et al*) (2013): "*Assessment of wind turbine noise in immission areas*"; Paper presented at the 5th International Conference on Wind Turbine Noise, Denver 28 – 30 August 2013
85. Thorne *et al*, 2010: *Noise Impact Assessment Report Waubra Wind Farm Mr & Mrs N Dean Report No 1537 - Rev 1*
86. Thorne, 2010: *The Problems with "Noise Numbers" for Wind Farm Noise Assessment*. *Bulletin of Science Technology and Society*, 2011 31: 262
87. USEPA, 1971: *Effects of Noise on Wildlife and other animals*
88. Van den Berg, G.P., 2003. '*Effects of the wind profile at night on wind turbine sound*'. *Journal of Sound and Vibration*
89. Van den Berg, G.P., 2004. '*Do wind turbines produce significant low frequency sound levels?*'. 11th International Meeting on Low Frequency Noise and Vibration and its Control
90. Wang, Z. 2011: *Evaluation of Wind Farm Noise Policies in South Australia: A Case Study of Waterloo Wind Farm*. Masters Degree Research Thesis, Adelaide University 2011
91. Whitford, Jacques, 2008: *Model Wind Turbine By-laws and Best Practices for Nova Scotia Municipalities*
92. World Health Organization, 2009: *Night Noise Guidelines for Europe*
93. World Health Organization, 1999: *Protection of the Human Environment; Guidelines for Community Noise*

APPENDIX A

Curriculum Vitae

The Author started his career in the mining industry as a bursar Learner Official (JCI, Randfontein), working in the mining industry, doing various mining related courses (Rock Mechanics, Surveying, Sampling, Safety and Health [Ventilation, noise, illumination etc] and Metallurgy. He did work in both underground (Coal, Gold and Platinum) as well as opencast (Coal) for 4 years. He changed course from Mining Engineering to Chemical Engineering after his second year of his studies at the University of Pretoria.

After graduation he worked as a Water Pollution Control Officer at the Department of Water Affairs and Forestry for two years (first year seconded from Wates, Meiring and Barnard), where duties included the perusal (evaluation, commenting and recommendation) of various regulatory required documents (such as EMPR's, Water Use License Applications and EIA's), auditing of license conditions as well as the compilation of Technical Documents.

Since leaving the Department of Water Affairs, Morné has been in private consulting for the last 20 years, managing various projects for the mining and industrial sector, private developers, business, other environmental consulting firms as well as the Department of Water Affairs. During that period he has been involved in various projects, either as specialist, consultant, trainer or project manager, successfully completing these projects within budget and timeframe. During that period he gradually moved towards environmental acoustics, focusing on this field exclusively since 2007.

He has been interested in acoustics as from school days, doing projects mainly related to loudspeaker design. Interest in the matter brought him into the field of Environmental Noise Measurement, Prediction and Control as well as blasting impacts. Since 2007 he has completed more than 400 Environmental Noise Impact Assessments and Noise Monitoring Reports as well as various acoustic consulting services, including amongst others:

**Wind Energy
Facilities**

Full Environmental Noise Impact Assessments for - Bannf (Vidigenix), iNca Gouda (Aurecon SA), Isivunguvungu (Aurecon), De Aar (Aurecon), Kokerboom 1 (Aurecon), Kokerboom 2 (Aurecon), Kokerboom 3 (Aurecon), Kangnas (Aurecon), Plateau East and West (Aurecon), Wolf (Aurecon), Outeniqwa (Aurecon), Umsinde Emoyeni (ARCUS), Komsberg (ARCUS), Karee (ARCUS), Kolkies (ARCUS), San Kraal (ARCUS), Phezukomoya (ARCUS), Canyon Springs (Canyon Springs), Perdekraal (ERM), Scarlet Ibis (CESNET), Albany (CESNET), Sutherland (CSIR), Kap Vley (CSIR), Kuruman (CSIR), Rietrug (CSIR), Sutherland 2 (CSIR), Perdekraal (ERM), Teekloof (Mainstream), Eskom Aberdene (SE), Dorper (SE), Spreeukloof (SE), Loperberg (SE), Penhoek Pass (SE), Amakhala Emoyeni (SE), Zen (Savannah Environmental – SE), Goereesoe (SE), Springfontein (SE), Garob (SE), Project Blue (SE), ESKOM Kleinzee (SE), Namas (SE), Zonnequa (SE), Walker Bay (SE), Oyster Bay (SE), Hidden Valley (SE), Deep River (SE), Tsitsikamma (SE), AB (SE), West Coast One (SE), Hopefield II (SE), Namakwa Sands (SE), VentuSA Gouda (SE), Dorper (SE), Klipheuwel (SE), INCA Swellendam (SE), Cookhouse (SE), Iziduli (SE), Msenge (SE), Cookhouse II (SE), Rhebokfontein (SE), Suurplaat (SE), Karoo Renewables (SE), Koningaas (SE), Spitskop (SE), Castle (SE), Khai Ma (SE), Poortjies (SE), Korana (SE), IE Moorreesburg (SE), Gunstfontein (SE), Boulders (SE), Vredenburg (Terramanzi), Loeriesfontein (SiVEST), Rhenosterberg (SiVEST), Noupoot (SiVEST), Prieska (SiVEST), Dwarsrug (SiVEST),

	<p><i>Graskoppies (SiVEST), Philco (SiVEST), Hartebeest Leegte (SiVEST), Ithemba (SiVEST), IXha Boom (SiVEST), Spitskop West (Terramanzi), Haga Haga (Terramanzi), Vredenburg (Terramanzi), Msenge Emoyeni (Windlab), Wobben (IWP), Trakas (SiVest), Beaufort West (SiVest)</i></p>
<p>Mining and Industry</p>	<p><i>Full Environmental Noise Impact Assessments for – Delft Sand (AGES), BECSA – Middelburg (Golder Associates), Kromkrans Colliery (Geovicon Environmental), SASOL Borrow Pits Project (JMA Consulting), Lesego Platinum (AGES), Tweefontein Colliery (Cleanstream Environmental), Evraz Vametco Mine and Plant (JMA), Goedehoop Colliery (Geovicon), Hacra Project (Prescali Environmental), Der Brochen Platinum Project (J9 Environment), Brandbach Sand (AGES), Verkeerdepan Extension (CleanStream Environmental), Dwaalboom Limestone (AGES), Jagdlust Chrome (MENCO), WPB Coal (MENCO), Landau Expansion (CleanStream Environmental), Otjikoto Gold (AurexGold), Klipfontein Colliery (MENCO), Imbabala Coal (MENCO), ATCOM East Expansion (Jones and Wagner), IPP Waterberg Power Station (SE), Kangra Coal (ERM), Schoongesicht (CleanStream Environmental), EastPlats (CleanStream Environmental), Chapudi Coal (Jacana Environmental), Generaal Coal (JE), Mopane Coal (JE), Glencore Boshhoek Chrome (JMA), Langpan Chrome (PE), Vlakpoort Chrome (PE), Sekoko Coal (SE), Frankford Power (REMIG), Strahrae Coal (Ferret Mining), Transalloys Power Station (Savannah), Pan Palladium Smelter, Iron and PGM Complex (Prescali Environmental), Fumani Gold (AGES), Leiden Coal (EIMS), Colenso Coal and Power Station (SiVEST/EcoPartners), Klippoortjie Coal (Gudani), Rietspruit Crushers (MENCO), Assen Iron (Tshikovha), Transalloys (SE), ESKOM Ankerlig (SE), Nooitgedacht Titano Project (EcoPartners), Algoa Oil Well (EIMS), Spitskop Chrome (EMAssistance), Vlakfontein South (Gudani), Leandra Coal (Jacana), Grazvalley and Zoetveld (Prescali), Tjate Chrome (Prescali), Langpan Chromite (Prescali), Vereeniging Recycling (Pro Roof), Meyerton Recycling (Pro Roof), Hammanskraal Billeting Plant 1 and 2 (Unica), Development of Altona Furnace, Limpopo Province (Prescali Environmental), Haakdoorndrift Opencast at Amandelbult Platinum (Aurecon), Landau Dragline relocation (Aurecon), Stuart Coal Opencast (CleanStream Environmental), Tetra4 Gas Field Development (EIMS), Kao Diamonds – Tipping Village Relocation (EIMS), Kao Diamonds – West Valley Tailings Deposit (EIMS), Upington Special Economic Zone (EOH), Arcelor Mittal CCGT Project near Saldanha (ERM), Malawi Sugar Mill Project (ERM), Proposed Mooifontein Colliery (Geovicon Environmental), Goedehoop North Residue Deposit Expansion (Geovicon Environmental), Mutsho 600MW Coal-Fired Power Plant (Jacana Environmentals), Tshivhaso Coal-Fired Power Plant (Savannah Environmental), Doornhoek Fluorspar Project (Exigo), Royal Sheba Project (Cabanga Environmental), Rietkol Silica (Jacana), Gruisfontein Colliery (Jacana), Lehlabile Colliery (Jaco-K Consulting), Bloemendal Colliery (Enviro-Insight), Rondevly Colliery (REC), Welgedacht Colliery (REC), Kalabasfontein Extension (EIMS), Waltloo Power Generation Project (EScience), Buffalo Colliery (Marang), Balgarthen Colliery (Rayten), Kusipongo Block C (Rayten), Zandheuvel (Exigo), NamPower Walvis Bay (GPT), Eloff Phase 3 (EIMS), Dunbar (Enviro-Insight), Smokey Hills (Prescali), Bierspruit (Aurecon)</i></p>
<p>Road and Railway</p>	<p><i>K220 Road Extension (Urbansmart), Boskop Road (MTO), Sekoko Mining (AGES), Davel-Swaziland-Richards Bay Rail Link (Aurecon), Moloto Transport Corridor Status Quo Report and Pre-Feasibility (SiVEST), Postmasburg Housing Development (SE), Tshwane Rapid Transport Project, Phase 1 and 2 (NRM Consulting/City of Tshwane), Transnet Apies-river Bridge Upgrade (Transnet), Gautrain Due-diligence (SiVest), N2 Piet Retief (SANRAL), Atterbury Extension, CoT (Bokomoso Environmental), Riverfarm Development (Terramanzi), Conakry to Kindia Toll Road (Rayten)</i></p>
<p>Airport</p>	<p><i>Oudtshoorn Noise Monitoring (AGES), Sandton Heliport (Alpine Aviation), Tete Airport Scoping (Aurecon)</i></p>
<p>Noise monitoring and Audit Reports</p>	<p><i>Peerboom Colliery (EcoPartners), Thabametsi (Digby Wells), Doxa Deo (Doxa Deo), Harties Dredging (Rand Water), Xstrata Coal – Witbank Regional (Xstrata), Sephaku Delmas (AGES), Amakhala Emoyeni WEF (Windlab Developments), Oyster Bay WEF (Renewable Energy Systems), Tsitsikamma WEF Ambient Sound Level study (Cennergi and SE), Hopefield WEF (Umoya), Wesley WEF (Innowind), Ncora WEF (Innowind), Boschmanspoort (Jones and Wagner), Nqamakwe WEF (Innowind), Hopefield WEF Noise Analysis (Umoya), Dassiesfontein WEF Noise Analysis (BioTherm), Transnet Noise Analysis (Aurecon), Jeffries Bay Wind Farm (Globeleq), Sephaku Aganang (Exigo), Sephaku Delmas (Exigo), Beira Audit (BP/GPT), Nacala Audit (BP/GPT), NATREF (Nemai), Rappa Resources (Rayten), Measurement Report for Sephaku Delmas (Ages), Measurement Report for Sephaku Aganang (Ages), Bank of Botswana measurements (Linnospace), Skukuza Noise Measurements (Concor), Development noise measurement protocol for Mamba Cement (Exigo), Measurement Report for Mamba Cement (Exigo), Measurement Report for Nokeng Fluorspar (Exigo), Tsitsikamma Community Wind Farm Pre-operation sound measurements (Cennergi), Waainek WEF Operational Noise Measurements (Innowind), Sedibeng Brewery Noise Measurements (MENCO), Tsitsikamma Community Wind Farm</i></p>

	<p><i>Operational noise measurements (Cennergi), Noupoot Wind Farm Operational noise measurements (Mainstream), Twisdraai Colliery (Lefatshe Minerals), SASOL Prospecting (Lefatshe Minerals), South32 Klipspruit (Rayten), Sibanye Stillwater Kroondal (Rayten), Rooiberg Asphalt (Rooiberg Asphalt), SASOL Shondoni (Lefatshe), SASOL Twisdraai (Lefatshe), Anglo Mototolo (Exigo), Heineken Inyaniga (AECOM), Glencore Izimbiwa (Cleanstream) Glencore Impunzi (Cleanstream), Black Chrome Mine (Prescali) Sibanye Stillwater Ezulwini (Aurecon), Sibanye Stillwater Beatrix (Aurecon), Bank of Botswana (Linspace), Lakeside (Linspace), Skukuza (SiVest), Rietvlei Colliery (Jaco-K Consulting)</i></p>
<p>Small Noise Impact Assessments</p>	<p><i>TCTA AMD Project Baseline (AECOM), NATREF (Nemai Consulting), Christian Life Church (UrbanSmart), Kosmosdale (UrbanSmart), Louwlandia K220 (UrbanSmart), Richards Bay Port Expansion (AECOM), Babalegi Steel Recycling (AGES), Safika Slag Milling Plant (AGES), Arcelor Mittal WEF (Aurecon), RVM Hydroplant (Aurecon), Grootvlei PS Oil Storage (SiVEST), Rhenosterberg WEF, (SiVEST), Concerto Estate (BPTrust), Ekuseni Youth Centre (MENCO), Kranskop Industrial Park (Cape South Developments), Pretoria Central Mosque (Noman Shaikh), Soshanguve Development (Maluleke Investments), Seshego-D Waste Disposal (Enviroexcellence), Zambesi Safari Equipment (Owner), Noise Annoyance Assessment due to the Operation of the Gautrain (Thornhill and Lakeside Residential Estate), Uppington Solar (SE), Ilangaletu Solar (SE), Pofadder Solar (SE), Flagging Trees WEF (SE), Uyekraal WEF (SE), Ruuki Power Station (SE), Richards Bay Port Expansion 2 (AECOM), Babalegi Steel Recycling (AGES), Safika Ladium (AGES), Safika Cement Isando (AGES), RareCo (SE), Struisbaai WEF (SE), Perdekraal WEF (ERM), Kotula Tsatsi Energy (SE), Olievenhoutbosch Township (Nali), , HDMS Project (AECOM), Quarry extensions near Ermelo (Rietspruit Crushers), Proposed uMzimkhulu Landfill in KZN (nZingwe Consultancy), Linksfield Residential Development (Bokomoso Environmental), Rooihuiskraal Ext. Residential Development, CoT (Plandev Town Planners), Floating Power Plant and LNG Import Facility, Richards Bay (ERM), Floating Power Plant project, Saldanha (ERM), Vopak Growth 4 project (ERM), Elandspoort Ext 3 Residential Development (Gibb Engineering), Tiegerpoort Wedding Venue (Henwood Environmental), Monavoni Development (Marindzini), Rezoning of Portion 1 (Primo Properties), Tswaing Mega City (Makole), Mabopane Church (EP Architects), ERGO Soweto Cluster (Kongiwe), Fabio Chains (Marang), GIDZ JMP (Marang), Temple Complex (KWP Create), Germiston Metals (Dorean), Sebenza Metals (Dorean)</i></p>
<p>Project reviews and amendment reports</p>	<p><i>Loperberg (Savannah), Dorper (Savannah), Penhoek Pass (Savannah), Oyster Bay (RES), Tsitsikamma Community Wind Farm Noise Simulation project (Cennergi), Amakhala Emoyeni (Windlab), Spreukloof (Savannah), Spinning Head (SE), Kangra Coal (ERM), West Coast One (Moyeng Energy), Rhebokfontein (Moyeng Energy), De Aar WEF (Holland), Quarterly Measurement Reports – Dangote Delmas (Exigo), Quarterly Measurement Reports – Dangote Lichtenburg (Exigo), Quarterly Measurement Reports – Mamba Cement (Exigo), Quarterly Measurement Reports – Dangote Delmas (Exigo) Quarterly Measurement Reports – Nokeng Fluorspar (Exigo), Proton Energy Limited Nigeria (ERM), Hartebeest WEF Update (Moorreesburg) (Savannah Environmental), Modderfontein WEF Opinion (Terramanzi), IPD Vredenburg WEF (IPD Power Vredenburg), Paul Puts WEF (ARCUS), Juno WEF (ARCUS), etc.</i></p>

Contact details for the Author are:

Author: Morné de Jager
 Company: Enviro-Acoustic Research cc
 Website: <http://www.eares.co.za>
 Email: morne@eares.co.za
 Office number: 012 004 0362
 Mobile number: 082 565 4059

APPENDIX B

Glossary of Terms

GLOSSARY OF ACOUSTIC TERMS, DEFINITIONS AND GENERAL INFORMATION

<i>1/3-Octave Band</i>	A filter with a bandwidth of one-third of an octave representing four semitones, or notes on the musical scale. This relationship is applied to both the width of the band, and the centre frequency of the band. See also definition of octave band.
<i>A – Weighting</i>	An internationally standardised frequency weighting that approximates the frequency response of the human ear and gives an objective reading that therefore agrees with the subjective human response to that sound.
<i>Air Absorption</i>	The phenomena of attenuation of sound waves with distance propagated in air, due to dissipative interaction within the gas molecules.
<i>Alternatives</i>	A possible course of action, in place of another, that would meet the same purpose and need (of proposal). Alternatives can refer to any of the following, but are not limited hereto: alternative sites for development, alternative site layouts, alternative designs, alternative processes and materials. In Integrated Environmental Management the so-called “no go” alternative refers to the option of not allowing the development and may also require investigation in certain circumstances.
<i>Ambient</i>	The conditions surrounding an organism or area.
<i>Ambient Noise</i>	The all-encompassing sound at a point being composed of sounds from many sources both near and far. It includes the noise from the noise source under investigation.
<i>Ambient Sound</i>	The all-encompassing sound at a point being composite of sounds from near and far.
<i>Ambient Sound Level</i>	Means the reading on an integrating impulse sound level meter taken at a measuring point in the absence of any alleged disturbing noise at the end of a total period of at least 10 minutes after such a meter was put into operation. In this report the term Background Ambient Sound Level will be used.
<i>Amplitude Modulated Sound</i>	A sound that noticeably fluctuates in loudness over time.
<i>Applicant</i>	Any person who applies for an authorisation to undertake a listed activity or to cause such activity in terms of the relevant environmental legislation.
<i>Assessment</i>	The process of collecting, organising, analysing, interpreting and communicating data that is relevant to some decision.
<i>Attenuation</i>	Term used to indicate reduction of noise or vibration, by whatever method necessary, usually expressed in decibels.
<i>Audible frequency Range</i>	Generally assumed to be the range from about 20 Hz to 20,000 Hz, the range of frequencies that our ears perceive as sound.
<i>Ambient Sound Level</i>	The level of the ambient sound indicated on a sound level meter in the absence of the sound under investigation (e.g. sound from a particular noise source or sound generated for test purposes). Ambient sound level as per Noise Control Regulations.
<i>Broadband Noise</i>	Spectrum consisting of a large number of frequency components, none of which is individually dominant.
<i>C-Weighting</i>	This is an international standard filter, which can be applied to a pressure signal or to a <i>SPL</i> or <i>PWL</i> spectrum, and which is essentially a pass-band filter in the frequency range of approximately 63 to 4000 Hz. This filter provides a more constant, flatter, frequency response, providing significantly less adjustment than the A-scale filter for frequencies less than 1000 Hz.
<i>Controlled area (as per National Noise Control Regulations)</i>	a piece of land designated by a local authority where, in the case of- (a) road transport noise in the vicinity of a road- (i) the reading on an integrating impulse sound level meter, taken outdoors at the end of a period extending from 06:00 to 24:00 while such meter is in operation, exceeds 65 dBA; or (ii) the equivalent continuous "A"-weighted sound pressure level at a height of at least 1,2 metres, but not more than 1,4 metres, above the

	<p>ground for a period extending from 06:00 to 24:00 as calculated in accordance with SABS 0210-1986, titled: "Code of Practice for calculating and predicting road traffic noise", published under Government Notice No. 358 of 20 February 1987, and projected for a period of 15 years following the date on which the local authority has made such designation, exceeds 65 dBA;</p> <p>(b) aircraft noise in the vicinity of an airfield, the calculated noisiness index, projected for a period of 15 years following the date on which the local authority has made such designation, exceeds 65 dBA; or</p> <p>(c) industrial noise in the vicinity of an industry-</p> <p>(i) the reading on an integrating impulse sound level meter, taken outdoors at the end of a period of 24 hours while such meter is in operation, exceeds 61 dBA; or</p> <p>(ii) the calculated outdoor equivalent continuous "A"-weighted sound pressure level at a height of at least 1,2 metres, but not more than 1,4 metres, above the ground for a period of 24 hours, exceeds 61 dBA;</p>
<i>dB(A)</i>	Sound Pressure Level in decibel that has been A-weighted, or filtered, to match the response of the human ear.
<i>Decibel (db)</i>	A logarithmic scale for sound corresponding to a multiple of 10 of the threshold of hearing. Decibels for sound levels in air are referenced to an atmospheric pressure of 20 μ Pa.
<i>Diffraction</i>	The process whereby an acoustic wave is disturbed and its energy redistributed in space as a result of an obstacle in its path, Reflection and refraction are special cases of diffraction.
<i>Direction of Propagation</i>	The direction of flow of energy associated with a wave.
<i>Disturbing noise</i>	Means a noise level that exceeds the zone sound level or, if no zone sound level has been designated, a noise level that exceeds the ambient sound level at the same measuring point by 7 dBA or more.
<i>Environment</i>	The external circumstances, conditions and objects that affect the existence and development of an individual, organism or group; these circumstances include biophysical, social, economic, historical, cultural and political aspects.
<i>Environmental Control Officer</i>	Independent Officer employed by the applicant to ensure the implementation of the Environmental Management Plan (EMP) and manages any further environmental issues that may arise.
<i>Environmental impact</i>	A change resulting from the effect of an activity on the environment, whether desirable or undesirable. Impacts may be the direct consequence of an organisation's activities or may be indirectly caused by them.
<i>Environmental Impact Assessment</i>	An Environmental Impact Assessment (EIA) refers to the process of identifying, predicting and assessing the potential positive and negative social, economic and biophysical impacts of any proposed project, plan, programme or policy that requires authorisation of permission by law and that may significantly affect the environment. The EIA includes an evaluation of alternatives, as well as recommendations for appropriate mitigation measures for minimising or avoiding negative impacts, measures for enhancing the positive aspects of the proposal, and environmental management and monitoring measures.
<i>Environmental issue</i>	A concern felt by one or more parties about some existing, potential or perceived environmental impact.
<i>Equivalent continuous A-weighted sound exposure level ($L_{Aeq,T}$)</i>	The value of the average A-weighted sound pressure level measured continuously within a reference time interval T , which have the same mean-square sound pressure as a sound under consideration for which the level varies with time.
<i>Equivalent continuous A-weighted rating level ($L_{Req,T}$)</i>	The Equivalent continuous A-weighted sound exposure level ($L_{Aeq,T}$) to which various adjustments has been added. More commonly used as ($L_{Req,d}$) over a time interval 06:00 – 22:00 ($T=16$ hours) and ($L_{Req,n}$) over a time interval of 22:00 – 06:00 ($T=8$ hours). It is a calculated value.
<i>F (fast) time weighting</i>	(1) Averaging detection time used in sound level meters.

	(2) Fast setting has a time constant of 125 milliseconds and provides a fast reacting display response allowing the user to follow and measure not too rapidly fluctuating sound.
<i>Footprint area</i>	Area to be used for the construction of the proposed development, which does not include the total study area.
<i>Free Field Condition</i>	An environment where there is no reflective surfaces.
<i>Frequency</i>	The rate of oscillation of a sound, measured in units of Hertz (Hz) or kiloHertz (kHz). One hundred Hz is a rate of one hundred times per second. The frequency of a sound is the property perceived as pitch: a low-frequency sound (such as a bass note) oscillates at a relatively slow rate, and a high-frequency sound (such as a treble note) oscillates at a relatively high rate.
<i>Green field</i>	A parcel of land not previously developed beyond that of agriculture or forestry use; virgin land. The opposite of Greenfield is Brownfield, which is a site previously developed and used by an enterprise, especially for a manufacturing or processing operation. The term Brownfield suggests that an investigation should be made to determine if environmental damage exists.
<i>G-Weighting</i>	An International Standard filter used to represent the infrasonic components of a sound spectrum.
<i>Harmonics</i>	Any of a series of musical tones for which the frequencies are integral multiples of the frequency of a fundamental tone.
<i>I (impulse) time weighting</i>	(1) Averaging detection time used in sound level meters as per South African standards and Regulations. (2) Impulse setting has a time constant of 35 milliseconds when the signal is increasing (sound pressure level rising) and a time constant of 1,500 milliseconds while the signal is decreasing.
<i>Impulsive sound</i>	A sound characterized by brief excursions of sound pressure (transient signal) that significantly exceed the ambient sound level.
<i>Infrasound</i>	Sound with a frequency content below the threshold of hearing, generally held to be about 20 Hz. Infrasonic sound with sufficiently large amplitude can be perceived, and is both heard and felt as vibration. Natural sources of infrasound are waves, thunder and wind.
<i>Integrated Development Plan</i>	A participatory planning process aimed at developing a strategic development plan to guide and inform all planning, budgeting, management and decision-making in a Local Authority, in terms of the requirements of Chapter 5 of the Municipal Systems Act, 2000 (Act 32 of 2000).
<i>Integrated Environmental Management</i>	IEM provides an integrated approach for environmental assessment, management, and decision-making and to promote sustainable development and the equitable use of resources. Principles underlying IEM provide for a democratic, participatory, holistic, sustainable, equitable and accountable approach.
<i>Interested and affected parties</i>	Individuals or groups concerned with or affected by an activity and its consequences. These include the authorities, local communities, investors, work force, consumers, environmental interest groups and the general public.
<i>Key issue</i>	An issue raised during the Scoping process that has not received an adequate response and that requires further investigation before it can be resolved.
<i>L_{A90}</i>	the sound level exceeded for the 90% of the time under consideration
<i>Listed activities</i>	Development actions that is likely to result in significant environmental impacts as identified by the delegated authority (formerly the Minister of Environmental Affairs and Tourism) in terms of Section 21 of the Environment Conservation Act.
<i>L_{AMin} and L_{AMax}</i>	Is the RMS (root mean squared) minimum or maximum level of a noise source.
<i>Loudness</i>	The attribute of an auditory sensation that describes the listener's ranking of sound in terms of its audibility.
<i>Magnitude of impact</i>	Magnitude of impact means the combination of the intensity, duration and extent of an impact occurring.
<i>Masking</i>	The raising of a listener's threshold of hearing for a given sound due to the presence of another sound.
<i>Mitigation</i>	To cause to become less harsh or hostile.

<i>Negative impact</i>	A change that reduces the quality of the environment (for example, by reducing species diversity and the reproductive capacity of the ecosystem, by damaging health, or by causing nuisance).
<i>Noise</i>	a. Sound that a listener does not wish to hear (unwanted sounds). b. Sound from sources other than the one emitting the sound it is desired to receive, measure or record. c. A class of sound of an erratic, intermittent or statistically random nature.
<i>Noise Level</i>	The term used in lieu of sound level when the sound concerned is being measured or ranked for its undesirability in the contextual circumstances.
<i>Noise-sensitive development</i>	developments that could be influenced by noise such as: a) districts (see table 2 of SANS 10103:2008) 1. rural districts, 2. suburban districts with little road traffic, 3. urban districts, 4. urban districts with some workshops, with business premises, and with main roads, 5. central business districts, and 6. industrial districts; b) educational, residential, office and health care buildings and their surroundings; c) churches and their surroundings; d) auditoriums and concert halls and their surroundings; e) recreational areas; and f) nature reserves. In this report Noise-sensitive developments is also referred to as a Potential Sensitive Receptor
<i>Octave Band</i>	A filter with a bandwidth of one octave, or twelve semi-tones on the musical scale representing a doubling of frequency.
<i>Positive impact</i>	A change that improves the quality of life of affected people or the quality of the environment.
<i>Property</i>	Any piece of land indicated on a diagram or general plan approved by the Surveyor-General intended for registration as a separate unit in terms of the Deeds Registries Act and includes an erf, a site and a farm portion as well as the buildings erected thereon
<i>Public Participation Process</i>	A process of involving the public in order to identify needs, address concerns, choose options, plan and monitor in terms of a proposed project, programme or development
<i>Reflection</i>	Redirection of sound waves.
<i>Refraction</i>	Change in direction of sound waves caused by changes in the sound wave velocity, typically when sound wave propagates in a medium of different density.
<i>Reverberant Sound</i>	The sound in an enclosure which results from repeated reflections from the boundaries.
<i>Reverberation</i>	The persistence, after emission of a sound has stopped, of a sound field within an enclosure.
<i>Significant Impact</i>	An impact can be deemed significant if consultation with the relevant authorities and other interested and affected parties, on the context and intensity of its effects, provides reasonable grounds for mitigating measures to be included in the environmental management report. The onus will be on the applicant to include the relevant authorities and other interested and affected parties in the consultation process. Present and potential future, cumulative and synergistic effects should all be taken into account.
<i>S (slow) time weighting</i>	(1) Averaging times used in sound level meters. (2) Time constant of one [1] second that gives a slower response which helps average out the display fluctuations.
<i>Sound Level</i>	The level of the frequency and time weighted sound pressure as determined by a sound level meter, i.e. A-weighted sound level.
<i>Sound Power</i>	Of a source, the total sound energy radiated per unit time.
<i>Sound Pressure Level (SPL)</i>	Of a sound, 20 times the logarithm to the base 10 of the ratio of the RMS sound pressure level to the reference sound pressure level. International values for the reference sound pressure level are 20 micropascals in air and 100

	millipascals in water. SPL is reported as L_p in dB (not weighted) or in various other weightings.
<i>Soundscape</i>	Sound or a combination of sounds that forms or arises from an immersive environment. The study of soundscape is the subject of acoustic ecology. The idea of soundscape refers to both the natural acoustic environment, consisting of natural sounds, including animal vocalizations and, for instance, the sounds of weather and other natural elements; and environmental sounds created by humans, through musical composition, sound design, and other ordinary human activities including conversation, work, and sounds of mechanical origin resulting from use of industrial technology. The disruption of these acoustic environments results in noise pollution.
<i>Study area</i>	Refers to the entire study area encompassing all the alternative routes as indicated on the study area map.
<i>Sustainable Development</i>	Development that meets the needs of the present without compromising the ability of future generations to meet their own needs. It contains within it two key concepts: the concept of "needs", in particular the essential needs of the world's poor, to which overriding priority should be given; and the idea of limitations imposed by the state of technology and social organization on the environment's ability to meet present and the future needs (Brundtland Commission, 1987).
<i>Tread braked</i>	The traditional form of wheel brake consisting of a block of friction material (which could be cast iron, wood or nowadays a composition material) hung from a lever and being pressed against the wheel tread by air pressure (in the air brake) or atmospheric pressure in the case of the vacuum brake.
<i>Zone of Potential Influence</i>	The area defined as the radius about an object, or objects beyond which the noise impact will be insignificant.
<i>Zone Sound Level</i>	Means a derived dBA value determined indirectly by means of a series of measurements, calculations or table readings and designated by a local authority for an area. This is similar to the Rating Level as defined in SANS 10103:2008.

APPENDIX C

Declaration of Independence

APPENDIX D

Site Sensitivity Verification

SITE SENSITIVITY VERIFICATION (IN TERMS OF PART A OF THE ASSESSMENT PROTOCOLS PUBLISHED IN GN 320 ON 20 MARCH 2020

Part A of the Assessment Protocols published in GN 320 on 20 March 2020 (i.e. Site sensitivity verification is required where a specialist assessment is required but no specific assessment protocol has been prescribed) is applicable where the Department of Environment, Forestry and Fisheries Screening Tool has the relevant themes to verify.

In accordance with Appendix 6 of the National Environmental Management Act (Act 107 of 1998, as amended) (NEMA) Environmental Impact Assessment (EIA) Regulations of 2014, a site sensitivity verification has been undertaken in order to confirm the current land use and environmental sensitivity of the proposed project area as identified by the National Web-Based Environmental Screening Tool (Screening Tool). The details of the site sensitivity verification are noted below:

Date of Site Visit	19 to 24 June 2018
Specialist Name	AJ Rens
Professional Registration Number (if applicable)	Not applicable, there is no registration body in South Africa that could allow professional registration for acoustic consultants.
Specialist Affiliation / Company	Oswald Professional Engineers

Output from National Environmental Screening Tool

The site was initially assessed using the National Environmental Screening tool, available at, <https://screening.environment.gov.za>. The output from the National Online Screening tool indicates a number of areas within, and up to 2,000 m from the project boundary is considered to be of a "very high" sensitivity to noise. These potentially "very high" sensitive areas (in terms of noise) are indicated on **Figure D.1** together with the potential noise-sensitive receptors as identified.

Description on how the site sensitivity verification was undertaken

The site sensitivity was verified using:

- a) *available aerial images (Google Earth®) (See **Figure D.1** for initially identified potential noise-sensitive receptors);*
- b) *the statuses of these structures were verified during the site visit in June 2018 by AJ Rens.*

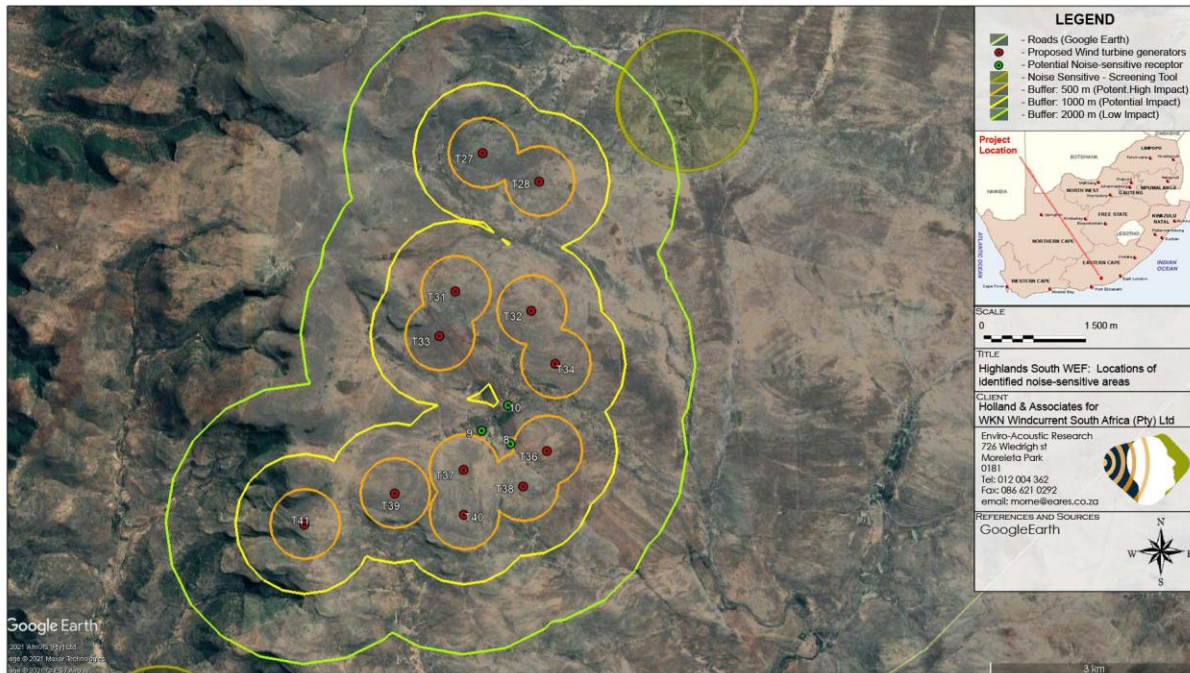

Figure D.1: Areas defined to be of “Very High” sensitivity in terms of noise by the online screening tool

Outcome of the Site Sensitivity Verification

- 1. The screening tool did identify a potential noise-sensitive area to the north-east of WTG T28. This receptor is further than 2,000 m from the WTG of the Highlands South WEF.*
- 2. This assessment identified a number of residential dwellings to the west of WTG T36 and north of WTGs T37 and T38. These were not identified by the online screening tool and the potential impact from noise from the project is assessed in this Noise Specialist Study. The land owner (Highlands Trust represented by Mr. Brown) reported that the dwellings at NSDs 8 and 9 are not used for residential purposes.*

Signature
Morné de Jager
2021 – 10 – 25

APPENDIX E

Calculated conceptual noise levels

Appendix E, Table 1: Projected daytime construction noise levels – WTG related

NSD	Estimated ambient sound levels	Daytime Noise Limit	Projected Noise Level	Change in rating level	Mag	Dur	Ext	Prob	Sig
8*	40	47	52	13	10	2	2	2	28
9*	40	47	50	11	10	2	2	2	28
10	40	47	47	8	8	2	2	1	12

* Dwellings at NSDs 8 and 9 reported by land owner not to be occupied.

Appendix E, Table 2: Projected night-time construction noise levels – WTG related

NSD	Estimated ambient sound levels	Night Noise Limit	Projected Noise Level	Change in rating level	Mag	Dur	Ext	Prob	Sig
8*	40	42	52	13	10	2	3	3	45
9*	40	42	50	11	10	2	3	3	45
10	40	42	47	8	8	2	3	2	26

* Dwellings at NSDs 8 and 9 reported by land owner not to be occupied.

Appendix E, Table 3: Projected construction noise levels – Roads related

NSD	Estimated ambient sound levels	Daytime Noise Limit	Projected Noise Level	Change in rating level	Mag	Dur	Ext	Prob	Sig
8*	40	47	49	10	8	1	2	1	11
9*	40	47	49	10	8	1	2	1	11
10	40	47	48	9	10	1	2	1	13

* Dwellings at NSDs 8 and 9 reported by land owner not to be occupied.

Appendix E, Table 4: Projected noise levels – Construction Traffic

NSD	Estimated ambient sound levels	Daytime Noise Limit	Projected Noise Level	Change in rating level	Mag	Dur	Ext	Prob	Sig
8*	40	47	41	4	2	2	2	1	6
9*	40	47	40	3	2	2	2	1	6
10	40	47	44	6	4	2	2	1	8

* Dwellings at NSDs 8 and 9 reported by land owner not to be occupied.

Appendix E, Table 5: Projected daytime operational noise levels

NSD	Estimated ambient sound levels	Noise Limit	Projected Noise Level (106 dBA Sound Power Emission Level)	Projected Noise Level (108.5 dBA Sound Power Emission Level)	Change in rating level (108.5 dBA Sound Power Emission Level)	Mag	Dur	Ext	Prob	Sig
8*	39.5	45	44.1	46.6	7.9	6	4	2	1	14
9*	39.5	45	42.3	44.8	6.4	4	4	2	1	12
10	39.5	45	41.7	44.2	6.0	4	4	2	1	12

* Dwellings at NSDs 8 and 9 reported by land owner not to be occupied.

Appendix E, Table 6: Projected night-time operational noise levels

NSD	Estimated ambient sound levels	Noise Limit	Projected Noise Level (106 dBA Sound Power Emission Level)	Projected Noise Level (108.5 dBA Sound Power Emission Level)	Change in rating level (108.5 dBA Sound Power Emission Level)	Mag	Dur	Ext	Prob	Sig
8*	39.5	45	44.1	46.6	7.9	8	4	3	3	42
9*	39.5	45	42.3	44.8	6.4	6	4	3	3	36
10	39.5	45	41.7	44.2	6.0	6	4	3	2	24

* Dwellings at NSDs 8 and 9 reported by land owner not to be occupied.

Appendix E, Table 7: Projected cumulative noise levels

NSD	Noise Level (Highlands North and South) (108.5 dBA Sound Power Emission Level)	Noise Level (Highlands South only) (108.5 dBA Sound Power Emission Level)	Cumulative Noise Level (108.5 dBA Sound Power Emission Level)	Change in rating level (due to contribution of the Highlands South WEF)	Mag	Dur	Ext	Prob	Sig
1	31.6	30.0	31.9	2.0	2	4	3	1	9
2	34.9	30.0	34.9	1.2	2	4	3	1	9
3	36.5	30.0	36.5	0.9	2	4	3	1	9
4	36.5	30.0	36.5	0.9	2	4	3	1	9
5	44.8	38.4	44.8	0.9	2	4	3	1	9
6	42.1	42.0	42.2	2.9	2	4	3	1	9
7	39.7	39.3	39.8	2.7	2	4	3	1	9
8*	30.0	30.0	44.7	-11.7	2	4	3	1	9
9*	30.0	30.0	44.2	-11.2	2	4	3	1	9
10	30.0	30.0	43.7	-10.7	2	4	3	1	9
11	36.8	30.0	36.8	0.8	2	4	3	1	9
12	35.6	30.0	35.6	1.1	2	4	3	1	9
13	30.8	30.0	30.8	2.6	2	4	3	1	9

* Dwellings at NSDs 8 and 9 reported by land owner not to be occupied.

End of Report