

**HIGH LEVEL SAFETY HEALTH AND
ENVIRONMENTAL RISK ASSESSMENT FOR
THE DEVELOPMENT OF A BATTERY ENERGY STORAGE
SYSTEM AT THE PROPOSED ROOS SOLAR ENERGY
FACILITY, NEAR BELFAST, MPUMALANGA PROVINCE**

26th July 2023

REPORT:	HIGH LEVEL SAFETY HEALTH AND ENVIRONMENTAL RISK ASSESSMENT FOR THE DEVELOPMENT OF A BATTERY ENERGY STORAGE SYSTEM AT THE PROPOSED ROOS SOLAR ENERGY FACILITY NEAR BELFAST IN MPUMALANGA
ASSIGNMENT NO:	J3396M
REPORT DATE:	26 th July 2023
RISK ASSESSOR:	Debra Mitchell Telephone: 011 201 4783/5 Mobile phone: 082 428 8844 Email: mitchelld@ishecon.co.za
CLIENT:	JUWI South Africa (Pty) Ltd
ENVIRONMENTAL ASSESSMENT PRACTITIONER:	Phumela Madubela of SiVEST Environmental Division D +27 11 798 0637 / +27 63 884 6439 / PhumelaM@sivest.co.za
INSTALLATION REPRESENTATIVE	Justine Wyngaardt – JUWI – Senior Environmental Manager: Project Development
ADDRESS OF INSTALLATION:	Emakhazeni Local Municipality in Mpumalanga
ADDRESS OF COMPANY:	20th Floor, The Halyard, 4 Christiaan Barnard Street, Foreshore, Cape Town, 8001, South Africa

REPORT ADMINISTRATIVE RECORD

LIST OF ASSESSMENTS

Assessment	Rev. No.	Assessment Date	Description
SHE Risk Assessment	2	26 th July 2023	J3396M – High-Level Safety Health and Environmental Risk Assessment for the Development of a Battery Energy Storage System at the proposed Roos Solar Energy Facilities near Belfast in Mpumalanga - issued by ISHECON

CONTRIBUTORS

The validity, results and conclusions of this assessment are based on the expertise, skills and information provided by the following contributing team members:

NAME	ORGANISATION	DISCIPLINE
Phumela Madubela	SiVest	Environmental Consultant
Justine Wyngaardt	JUWI	Senior Environmental Manager: Project Development

DISCLAIMER

Although every effort has been made by ISHECON to obtain the correct information and to carry out an appropriate, independent, impartial and competent study, it remains the responsibility of the Contractor to ensure suitable Process Safety Measures are in place. ISHECON cannot be held liable for any accident or incident, due to negligence by the owner/operator, which directly or indirectly relates to the plant, equipment, facilities and systems analysed in this document and which may have an effect on the client or any other third party.

CONFIDENTIALITY

ISHECON will keep all information, results and findings confidential, and will not pass these on to other parties without the permission of the Client. However, as an Approved Inspection Authorities for Department of Employment and Labour, ISHECON is also under legal obligation to the Department of Employment and Labour to report any obvious violations of the OHS Act during site inspections.

RISK ASSESSMENT APPROVAL

This report is approved for issue by the undersigned Technical Signatory as per the ISHECON.

NAME	CAPACITY	REPORT DATE	SIGNATURE
D.C. Mitchell	Risk Assessment, Report preparation, Technical signatory	26 th July 2023	

EXECUTIVE SUMMARY

The applicant, JUWI (Pty) Ltd, is considering a Battery Energy Storage System (BESS) to complement a proposed Renewable Solar Energy Facility with four PV installations (Solar PV1,2,4 & 4), each with a capacity of up to 28 megawatts (MW) in the Wonderfontein area west of Belfast in Mpumalanga. The projects fall within the Emalahleni Renewable Energy Development Zone (REDZ).

There will be a single BESS serving all four Solar PV facilities. The BESS storage capacity will be up to 500MW with up to four hours of storage i.e. up to 2000 megawatt-hour (MWh). Two alternative technologies are being considered for the BESS, i.e. either Solid State (typically Lithium chemistry) (SSL) or Redox Flow (typically vanadium chemistry) (VRFB). The technology is advancing rapidly and the exact technology and chemistry will be chosen during the Engineering, Procurement and Construction (EPC) phase. For SSL batteries this would mean multiple containerised units. For VRFB, the systems can be containerized but could, in order to achieve economies of scale, be one large utility scale plant within a conventional industrial type structural steel / brick warehousing structure. In either configuration there could be large volumes of electrolyte on site either in smaller tanks inside containers or larger tanks in a building. The VRFB facilities, either containerized or as utility buildings, will be banded to contain 110% of the largest vessel.

Supplementary infrastructure and equipment may include substations, power cables, transformers, power converters, substation buildings & offices, HV/MV switch gear, inverters and other control equipment that may be positioned within the battery containers / separate dedicated containers / the battery building.

This report summarizes the high-level Safety Health and Environmental Risk Assessment conducted by ISHECON for the proposed Battery Energy Storage Systems systems at the proposed Roos SEF facilities.

1. METHODOLOGY

This assessment of risk comprises:

- Identification of the likely hazards and hazardous events related to the construction, operation and decommissioning of the installation using a checklist approach.
- Estimation of the likelihood/probability of these hazardous events occurring.
- Estimation of the consequences of these hazardous events.
- Estimation of the risk and comparison against certain acceptability criteria.

For the purpose of this high-level Risk Assessment a desktop study of the available information, preliminary layout of the facility and associated BESS location on satellite images, reports of related incidents and various literature sources was undertaken. The facility and the project were divided into the sections/phases and using a checklist approach the hazards in each section/phase were identified. Each identified hazard was then analysed in terms of causes, consequences, expected and suggested preventive and mitigative measures to be in place. Each hazard was qualitatively assessed using a qualitative risk ranking system.

2. FINDINGS

In order to highlight the maximum differences between the possible technology types, this study is based on the assumption that redox flow batteries (typically vanadium based chemistry) could be installed within a building using bulk tanks, while solid state batteries (typically lithium based chemistry) would be installed in shipping containers that have hundreds of individual batteries combined into packs. Redox flow batteries can be installed

in containers where the individual quantities of electrolyte involved would be smaller, although the hazards are the same just smaller in magnitude.

GENERAL

- This Risk Assessment has found that with suitable preventative and mitigative measures in place, none of the identified potential risks are excessively high, i.e., from a Safety, Health and Environment (SHE) perspective no fatal flaws were found with either type of technology for the proposed BESS installation at the Roos Solar Energy Facility near Belfast, Mpumalanga.
- At a large facility, without installation of the state-of-the art battery technology that includes protective features, there can be significant risks to employees and first responders. The latest battery designs include many preventative and mitigative measures to reduce these risks to tolerable levels. (Refer to tables in section 4 under preventative and mitigative measures). State-of-the-art technology should be used, i.e., not old technology that may have been prone to fire and explosion risks.
- The design should be subject to a full Hazard and Operability Study (HAZOP) prior to commencement of procurement. A HAZOP is a detailed technical systematic study that looks at the intricacies of the design, the control system, the emergency system etc. and how these may fail under abnormal operating conditions. Additional safeguards may be suggested by the team doing the study.

LITHIUM SOLID STATE CONTAINERIZED BATTERIES

- With lithium solid-state batteries, the most significant hazard with battery units is the possibility of thermal runaway and the generation of toxic and flammable gases. There have been numerous such incidents around the world with batteries at all scales and modern technology providers include many preventative and mitigative features in their designs. This type of event also generates heat which may possibly propagate the thermal runaway event to neighbouring batteries if suitable state of the art technology is not employed.
- The flammable gases generated may ignite leading to a fire which accelerates the runaway process and may spread the fire to other parts of the BESS or other equipment located near-by.
- If the flammable gases accumulate within the container before they ignite, they may eventually ignite with explosive force. This type of event is unusual but has happened with an older technology container installed at McMicken in the USA in 2019.
- Due to a variety of causes, thermal runaway could happen at any point during transport to the facility, during construction or operation / maintenance at the facility or during decommissioning and safe making for disposal.
- Due to the containerized approach as well as the usual good practice of separation between containers, which should be applied on this project, and therefore the likely restriction of events to one container at a time, the main risks are close to the containers i.e., to transport drivers, employees at the facilities and first responders to incidents.
- In terms of a worst conceivable case container fires, the significant impact zone is likely to be limited to within 10m of the container and mild impacts to 20m. Based on the current proposed layout,

impacts at the closest isolated farmhouses are not expected.

- In terms of a worst conceivable case explosion, the significant impact zone is likely to be limited to within 10m of the container and minor impacts such as debris within 50m. Based on the current proposed layout, impacts at the closest isolated farmhouses are not expected.
- In terms of a worst reasonably conceivable toxic smoke scenario, provided the units are placed suitably far apart to prevent propagation from one unit to another and large external fires are prevented, the amount of material burning should be limited to one container at any one time. In this case, beyond the immediate vicinity of the fire, the concentrations of harmful gases within the smoke should be low. Both the preferred and the alternative BESS installation locations are over 500m from any occupied development / farmhouse and therefore the risks posed by BESS are negligible.

VANADIUM REDOX FLOW BATTERY INSTALLATIONS

- The most significant hazard with VRF battery units is the possibility of spills of corrosive and environmentally toxic electrolyte. Many preventative and mitigative features will be included in the design and operation, e.g., full secondary containment, level control on tanks, leak detection on equipment etc. (Refer to tables in section 4 under preventative and mitigative measures).
- VRF batteries do not present significant fire and electrical arcing hazards provided they are correctly designed, operated, maintained and managed. Suitable Battery Management System (BMS), safety procedures, operating instructions, maintenance procedures, trips, alarms and interlocks should be in place. (Refer to tables in section 4 under preventative and mitigative measures).

TECHNOLOGY AND LOCATION OF BESS FACILITIES

- From a safety and health point of view, the above Risk Assessment shows that risks posed by VRFB systems may be slightly lower than those of SSL facilities, particularly with respect to fire and explosion risks. From an environmental spill and pollution point of view the VRFB systems present higher short-term risks than the SSL systems. However, the above conclusions may be due to the fact that the VRFB technology is not as mature as SSL technology and therefore there is not as much operating experience and accident information available for the VRFB. Overall, from and SHE RA points of view, there is no specific preference for a type of technology.
- From a SHE risks assessment point of view, where there is a choice of location (not applicable on this project) that is further from public roads, water courses or isolated farmhouses/occupied developments, this would be preferred. VRFB hazards are mostly related to possible loss of containment of electrolyte and SSL batteries to fires producing toxic smoke and fire fighting which may result in contaminated firewater runoff. One would not want these liquids to enter water courses nor the smoke to pass close to houses / public traffic.

CUMULATIVE IMPACTS

- From a safety and health point of view, there are no significant cumulative impacts from any other BESS installation in the greater area.

3. RECOMMENDATIONS

The following recommendations have been made:

- There are numerous different battery technologies but using one consistent battery technology system for the BESS installations associated with all the developments in the Belfast area associated with the Roos Project would allow for ease of training, maintenance, emergency response and could significantly reduce risks.
- Where reasonably practicable, state-of-the-art battery technology should be used with all the necessary protective features e.g., draining of cells during shutdown and standby-mode, full BMS with deviation monitoring and trips, leak detection systems.
- There are no fatal flaws associated with the proposed Solar Energy battery installation for either technology type.
- The tables in Section 4 of this report contains technical and systems suggestions for managing and reducing risks. Ensure the items listed in these tables under preventative and mitigative measures are included in the design.
- The overall design should be subject to a full Hazop prior to finalization of the design.
- For the VRFB systems an end of life (and for possible periodic purging requirements) solution for the large quantities of hazardous electrolyte should be investigated, e.g., can it be returned to the supplier for re-conditioning.
- Prior to bringing any solid-state battery containers into the country, the contractor should ensure that:
 - An Emergency Response Plan is in place that would be applicable for the full route from the ship to the site. This plan would include details of the most appropriate emergency response to fires both while the units are in transit and once they are installed and operating.
 - An End-of-Life plan is in place for the handling, repurposing or disposal of dysfunctional, severely damaged batteries, modules and containers.
- The site layout and spacing between lithium solid-state containers should be such that it mitigates the risk of a fire or explosion event spreading from one container to another.
- In order to limit the possibility of domino failures the BESS should be separated from the substation by at least 20m.
- Under certain weather conditions, the noxious smoke from a fire in a lithium battery container could travel some distance from the unit. The smoke will most likely be acrid and could cause irritation, coughing, distress etc. Close to the source of the smoke, the concentration of toxic gases may be high enough to cause irreversible harmful effects. Location of the facilities needs to ensure a suitable separation distance from public facilities/residences etc. The preferred and the alternative BESS locations are over 500m from isolated farmhouses/developments, and are therefore suitable in this context.
- VRFB hazards are mostly related to possible loss of containment of electrolyte and solid-state systems may experience fires that may result in loss of containment of liquids or the use of large amounts of

fire water which could be contaminated. One would not want these run-offs to enter water courses directly and a BESS Location that is far from water courses would be preferred. The buffer distance between water bodies and the facilities containing chemicals should be set in consultation with a water specialist and is therefore not specified in this SHE RA. It is noted that there are no tributaries of the main water courses in the area within 100m of the proposed BESS Location.

- Finally, it is suggested once the BESS technology has been chosen and more details of the final design are available, the necessary updated Risk Assessments should be in place (prior to commencement, after environmental authorisation and other necessary approvals are granted (should such be granted)).

TABLE OF CONTENTS

1. INTRODUCTION.....	11
1.1 SCOPE OF ASSESSMENT	11
1.2 EIA REGULATION SCOPE OF APPLICATION	11
1.3 RISK ASSESSMENT METHODOLOGY	11
2. DESCRIPTIONS	19
2.1 ORGANISATION, SITE LOCATION AND SURROUNDING AREAS	19
2.1.1 ORGANIZATION	19
2.1.2 LOCATION AND PHYSICAL ADDRESS	19
2.1.3 DESCRIPTION OF SITE AND SURROUNDINGS	19
2.2 TOPOGRAPHY, LAND-USE AND METEOROLOGY	23
2.2.1 TOPOGRAPHY	23
2.2.2 LAND-USE	23
2.2.3 METEOROLOGY.....	23
2.3 PLANT AND PROCESSES.....	24
2.3.1 PROPOSED DESIGN LITHIUM SOLID STATE BATTERIES.....	24
2.3.2 PROPOSED DESIGN - VANADIUM REDOX FLOW BATTERIES	27
2.3.3 STAFF AND SHIFT ARRANGEMENT	29
2.3.4 OPERATIONS AT THE BESS FACILITY AND PHASES OF THE BESS PROJECT	29
3. HAZARD IDENTIFICATION.....	32
3.1 SOLID STATE LITHIUM BATTERY CHEMICAL HAZARDS	32
3.1.1 BATTERIES IN GENERAL	32
3.1.2 LITHIUM BATTERY CHEMISTRY	32
3.1.3 HAZARD - THERMAL DECOMPOSITION	32
3.1.4 HAZARD - PROPAGATION	33
3.1.5 HAZARD - ELECTROLYTE LEAKS.....	34
3.2 VANADIUM REDOX FLOW BATTERY HAZARDS	34
3.2.1 BATTERIES IN GENERAL	34
3.2.2 VANADIUM BATTERY CHEMISTRY	35
3.2.3 HAZARD – TOXICITY AND CORROSIVITY	36
3.2.4 HAZARD – ELECTRICAL SHOCK/ARC.....	37
3.2.5 HAZARD – FIRE / DEFLAGRATION	37
3.2.6 HAZARD - HYDROGEN GENERATION	37
3.2.7 HAZARD – WASTE ELECTROLYTE	38
3.2.8 HAZARD - ELECTROLYTE LEAKS.....	38
3.3 OTHER CHEMICALS OR HAZARDS	38
3.3.1 COOLING SYSTEMS	39
3.3.2 FIRE SUPPRESSION SYSTEMS	39
3.3.3 GENERAL ELECTRICAL AND ELECTRONIC EQUIPMENT	39
3.4 PAST ACCIDENTS AND INCIDENTS RELEVANT TO BESS.....	40
4. RISK ASSESSMENT.....	45
4.1 SOLID STATE LITHIUM-ION BATTERY ENERGY STORAGE SYSTEMS.....	46
4.2 VANADIUM REDOX FLOW BATTERY ENERGY STORAGE SYSTEMS.....	75
5. CONCLUSIONS AND RECOMMENDATIONS.....	100
5.1 CONCLUSIONS.....	100
5.2 RECOMMENDATIONS	102
6 REFERENCES.....	104

GLOSSARY OF SOME TERMS POSSIBLY USED IN THIS REPORT

List of units, acronyms and abbreviations used in this report	Definition
BEI	Biological Exposure Index (Refers to values in blood or urine etc as per to OHS Act)
BESS	Battery Energy Storage System
BMS	Battery Management System
dB	Decibels
DEA	Department of Environmental Affairs
DFFE	Department of Forestry, Fisheries and the Environment
EIA	Environmental Impact Assessment
EMPr	Environmental Management Programme
ERPG	Emergency Response Planning Guideline (a series of values in ppm or mg/m ³ that indicates various levels health effects if exposed to this concentration for more than 60 minutes)
E-stop	Emergency stop button
HAZOP	Hazard and Operability Study
HBA	Hazardous Biological Agents (Refers to pathogens, parasites, cell cultures etc - Refer to the Occupational Health and Safety Act, 1993 (Act No. 83 of 1993) (OHS Act)
HCS	Hazardous Chemical Substances (Refers to a list of hazardous chemicals - Refer to the OHS Act)
HV / MV	High Voltage / Medium Voltage
IDLH	Immediately Dangerous to Life and Health (a value in ppm or mg/m ³ that indicates serious health effects if exposed to this concentration for more than 30 minutes)
kW	Kilowatts
kPa	Kilopascal
m	Metres
m ²	Metres squared
m ³	Metres cubed
NEMA	National Environmental Management Act, 1998 (Act No. 107 of 1998), as amended
NFPA	National Fire Protection Agency
NRT Act	National Road Traffic Act, 1996 (Act No. 93 of 1996) (Chapter 8 deals with transportation of dangerous goods) Note various South African National Standards (SANS) are incorporated into the regulations.
OEL	Occupational Exposure Limit (usually in ppm or mg/m ³ in the air for each HCS as defined in the Hazardous Chemical Substances Regulations of the OHS Act)
OHS Act	Occupational Health and Safety Act, 1993 (Act No. 83 of 1993)
PV	Photovoltaic
RA	Risk Assessment
RQ	Reportable Quantity in terms of NEMA to DFFE
QC / QA	Quality Control or Quality Assurance
SANS	South African National Standards
SDS	Safety Data Sheet
SHE	Safety, Health and Environment
SSLB	Solid State Lithium Batteries
TWA (8 hrs)	Time weighted average of 8 hrs
VRFB	Vanadium redox flow battery
WEF	Wind Energy Facility
WBGT Index	An index in degrees Celsius composed of fractions of the Wet Bulb, Globe and Dry Bulb Temperatures (Refer to Environmental Regulations under the OHS Act)

1. INTRODUCTION

1.1 SCOPE OF ASSESSMENT

The applicant, Juwi (Pty) Ltd, is considering a Battery Energy Storage System (BESS) to complement a proposed Renewable Solar Energy Facility with four PV installations (Solar PV1,2,4 & 4) each with a capacity of up to 28 megawatts (MW) in the Wonderfontein area west of Belfast in Mpumalanga. The projects fall within the Emalahleni Renewable Energy Development Zone (REDZ)

There will be a single BESS serving all four Solar PV facilities. The BESS storage capacity will be up to 500MW with up to four hours of storage i.e. 2000 megawatt-hour (MWh). Two alternative technologies are being considered for the BESS, i.e. either Solid State (typically Lithium chemistry) (SSL) or Redox Flow (typically vanadium chemistry) (VRFB). The technology is advancing rapidly and the exact technology and chemistry will be chosen during the Engineering, Procurement and Construction (EPC) phase. For SSL batteries this would mean multiple containerised units. For VRFB, the systems can be containerized but could, in order to achieve economies of scale, be one large utility scale plant within a conventional industrial type structural steel / brick warehousing structure. In either configuration there could be large volumes of electrolyte on site either in smaller tanks inside containers or larger tanks in a building. The VRFB facilities, either containerized or as utility buildings, will be bunded to contain 110% of the largest vessel.

Supplementary infrastructure and equipment may include substations, power cables, transformers, power converters, substation buildings & offices, HV/MV switch gear, inverters and other control equipment that may be positioned within the battery containers / separate dedicated containers / the battery building.

The proposed BESS is subject to an Environmental Impact Assessment (S&EIA) process. In 2019, the Department of Forestry, Fisheries and the Environment (DFFE) requested that EIA applications for BESSs, either on their own or as part of a power generation (e.g., PV or wind) application, should include a high-level Risk Assessment of the BESS considering all applicable risks (e.g., fire, explosion, contamination, end-of life disposal etc).

This report summaries the high-level Safety Health and Environmental Risk Assessment conducted by ISHECON for the proposed Battery Energy Storage Systems systems at the proposed Roos SEF facilities.

Although this assessment is based on the best available information and expertise, ISHECON cc cannot be held liable for any incident that may occur on this installation and associated equipment which directly or indirectly relate to the work in this report.

1.2 EIA REGULATION SCOPE OF APPLICATION

This Risk Assessment is conducted as a technical input into the EIA process for the proposed renewable energy facility to comply with the requirement for a high-level Health and Safety Assessment, and it does not necessarily comply with all the requirements of a specialist study as defined in Appendix 6 of the Environmental Impact Assessment Regulations of 2014, as amended, under the National Environmental Management Act, 1998 (Act No. 107 of 1998), as amended (NEMA).

1.3 RISK ASSESSMENT METHODOLOGY

This Risk Assessment will consider the technology in detail. However, considering the general risks posed by the technology, each of the possible locations will be assessed with respect to advising on preferred locations from a SHE perspective.

Risk is made up of two components:

- The probability of a certain hazardous event or incident occurring.
- The severity of the consequences of that hazardous event / incident.

Therefore, this assessment of risk comprises:

- Identification of the likely hazards and hazardous events related to the operation of the installation.
- Estimation of the likelihood/probability of these hazardous events occurring.
- Estimation of the consequences of these hazardous events.
- Estimation of the risk and comparison against certain acceptability criteria.

For the purpose of this high-level Risk Assessment a general area visit was conducted. A desktop study of the available information, preliminary BESS locations, reports of related incidents and various literature sources was undertaken. Based on this information the facility and the project were divided into the following phases:

- construction,
- operation,
- decommissioning (end of life).

This study makes use of a qualitative risk ranking system framework¹. The method considers the nature of what causes the effect, what will be affected and how it will be affected.

NATURE OF IMPACT DEFINITION

Beneficial / Positive	An impact that is considered to represent an improvement on the baseline or introduces a positive change.
Adverse / Negative	An impact that is considered to represent an adverse change from the baseline, or introduces a new undesirable factor.
Direct	Impacts that arise directly from activities that form an integral part of the Project (e.g., new infrastructure).
Indirect	Impacts that arise indirectly from activities not explicitly forming part of the Project (e.g., noise changes due to changes in road or rail traffic resulting from the operation of Project).
Secondary	Secondary or induced impacts caused by a change in the Project environment (e.g., employment opportunities created by the supply chain requirements).
Cumulative	Impacts are those impacts arising from the combination of multiple impacts from existing projects, the Project and/or future projects.

A Health and Safety Risk Assessment is focussed on hazards arising from the construction, operation and decommissioning of a facility and their impact on humans, either employees or members of the public outside the site. By definition the nature of the chemical and machine hazards is negative, i.e., adverse impact on health and safety. Some of the impacts are immediate and direct such as effects of fires and explosions or exposure to high concentrations of chemicals (in health and safety we refer to these as acute impacts). Other impacts are longer term such as repeated exposure to low concentrations of harmful chemicals, noise etc. (in health and safety we refer to these as chronic impacts).

Using the checklist detailed in Table 1.3.1 the hazards in each section/phase were identified. Each identified hazard was then described by the assessor in terms of causes, consequences, preventive and mitigative measures in place.

¹ Adapted from a method developed by WSP to meet the combined requirements of international best practice and NEMA, Environmental Assessment Regulations, 2014, as amended (GN No.326) (the "EIA Regulations").

Each hazard was qualitatively dimensioned and assessed using the method as per Table 1.3.2. There are five dimensioning criteria in this method:

- a) The magnitude of impact on the processes of interest (i.e., human health and safety) e.g., no impact, moderate impact and will alter the operation of the process (e.g., injuries), very high impact and will destroy the process (e.g., fatalities).
- b) The physical extent, e.g., will it be limited to the site or not.
- c) The duration, i.e., how long will the person bear the brunt of the impact.
- d) Reversibility: an impact may either be reversible or irreversible, e.g., fatalities are permanent, while it may be possible to recover from injuries.
- e) The probability of occurrence of the impact.

After dimensioning these aspects, a combined overall risk / significance was calculated for each hazard, see Table 1.3.3.

The impact significance without design controls, preventative and mitigation measures will be assessed. Impacts without mitigation measures in place are not representative of the proposed development's actual extent of impact and are included to facilitate understanding of how and why mitigation measures were identified.

The residual impact is what remains following the application of mitigation and management measures and is thus the final level of impact associated with the development.

Residual impacts also serve as the focus of management and monitoring activities during Project implementation to verify that actual impacts are the same as those predicted in this Report.

There are other specialist assessments being carried out as part of the S&EIA process, for example assessments in the field of impacts on terrestrial biodiversity, including fauna and flora, aquatic biodiversity, avifauna etc. The focus of this study is on human health and safety with possible impacts from chemicals, fires, explosions etc. and on broad issues of chemical pollution, emissions and waste of resources.

TABLE 1.3.1 SAFETY, HEALTH AND ENVIRONMENTAL RISK ASSESSMENT CHECKLIST

NO	RISKS	DESCRIPTION OF TYPICAL HAZARDS	TYPICAL STANDARD (OHS ACT) OR KEY ISSUES
	HEALTH RISKS		
H1	Chronic Chemical or Biological Toxic Exposure	Continuous releases of toxic materials (Chemical or biological) Long term exposure to low concentrations Unsanitary or unhygienic conditions Diseases Harmful animals/insects	Do not exceed Occupational Exposure Limits (OEL's) and Biological Exposure Indices (BEI's – OHS Act Hazardous Chemical Substances (HCS) and Hazardous Biological Agents (HBA) Regulations)) for continuous work time exposure to hazardous chemical substances and materials. Awareness of HBA.
H2	Noise	Continuous and peak exposure to high levels of noise	Continuous noise not to exceed 85dB at workstation (OHS Act Noise-Induced Hearing Loss Regulations) and 61dB at boundary of the site.
H3	Environmental	High temperatures in work areas Low temperatures in work areas High humidity in work areas	Wet Bulb Globe Temperature (WBGT) index above 30 in summer and/or very cold less than 6 deg C in winter (OHS Act Environmental Regulations for Workplaces)
H4	Psychological	Inherently dangerous tasks Monotonous tasks High production pressure	
H5	Ergonomics	Bad ergonomic design, chronic or acute impact Vibration, repetitive impact	Maximum weight to lift 20 – 25kg
	SAFETY RISKS		
S1	Fire	Internal and external fire Small fire Large fires	Upper and lower flammability limits for materials. 12.5 kW/m ² for 1-minute leads to 1% fatalities. 37.5 kW/m ² leads to >90% fatalities and probable structural failure.
S2	Explosion	Internal explosions inside equipment Confined explosion inside structures Unconfined explosions outside	7 kPa overpressure leads to minor structural damage. 70 kPa leads to 90 % fatalities and probable structural failure.
S3	Acute Chemical or Biological Toxic Exposure	Large releases of toxic gases Exposure to high concentrations of harmful materials Asphyxiation inside a vessel Exposure to corrosive materials, burns	Immediately Dangerous to Life and Health values (IDLH) and Emergency Response Planning Guidelines (ERPG's) for all materials. Minimum oxygen levels.

NO	RISKS	DESCRIPTION OF TYPICAL HAZARDS	TYPICAL STANDARD (OHS ACT) OR KEY ISSUES
		Ingestion of poisonous materials	Low or high pH.
S4	Acute physical Impact or violent release of energy	Slips and trips Working at heights Moving equipment, objects or personnel	
S5	Generation impact	Electrocution Radiation sources Lasers Static Lightning	
	ENVIRONMENTAL RISKS		
E1	Emissions	Continuous emissions	Exceeding permitted emission levels
E2	Pollution	Unplanned pollution incidents causing immediate damage	Not transporting as per legislation (SANS10228/0229 and Haz. Subs. Act – Road Tanker Regs.) Hazmat requirements Reportable spill quantities NEMA Section 30
E3	Waste of resources	Water Power Other non-renewable resources (minerals) Biodiversity	Exceeding water consumption permits Peak demand requirements
	GENERAL RISKS		
G1	Aesthetics	Tall unsightly structures Glaring glass Odours	
G2	Financial	Risks of litigation Business collapse – recovery after emergency Sustainability	Business continuity Std SANS22301
G3	Security	Theft Hi-jacking Looting	
G4	Emergencies	Emergencies originating off-site (neighbours) Natural disasters	MHI Emergency Response Planning SANS1514
G5	Legal compliance	Applicable South African Legislation	OHS Act

TABLE 1.3.2 – SHE QUALITATIVE RISK ASSESSMENT MATRIX

a) The magnitude of impact on human health and safety and environmental pollution, quantified on a scale from 0-5, where a score is assigned.

SCORE	DESCRIPTION
0	small and will have no effect on the environment.
1	minor and will not result in an impact on processes.
2	low and will cause a slight impact on processes.
3	moderate and will result in processes continuing but in a modified way.
4	high (processes are altered to the extent that they temporarily cease).
5	very high and results in complete destruction of patterns and permanent cessation of processes.

b) The physical extent.

SCORE	DESCRIPTION
1	the impact will be limited to the site;
2	the impact will be limited to the local area;
3	the impact will be limited to the region;
4	the impact will be national; or
5	the impact will be international.

c) The duration, wherein it is indicated whether the lifetime of the impact will be:

SCORE	DESCRIPTION
1	of a very short duration (0 to 1 years)
2	of a short duration (2 to 5 years)
3	medium term (5–15 years)
4	long term (> 15 years)
5	permanent

d) Reversibility: An impact is either reversible or irreversible. How long before impacts on receptors cease to be evident.

SCORE	DESCRIPTION
1	The impact is immediately reversible.
3	The impact is reversible within 2 years after the cause or stress is removed; or
5	The activity will lead to an impact that is in all practical terms permanent.

e) The probability of occurrence, which describes the likelihood of the impact actually occurring.

SCORE	DESCRIPTION
1	very improbable (probably will not happen).
2	improbable (some possibility, but low likelihood).
3	probable (distinct possibility).
4	highly probable (most likely).
5	definite (impact will occur regardless of any prevention measures).

TABLE 1.3.3 – CALCULATION AND INTERPRETATION OF RISK / SIGNIFICANCE

The final assessment of the risk, i.e., the significance, of a particular impact is determined through combination of the characteristics described above (refer formula below)

$$\begin{aligned} \text{Risk} &= \text{Consequence} \times \text{Likelihood} \\ \text{Significance} &= (\text{Extent} + \text{Duration} + \text{Reversibility} + \text{Magnitude}) \times \text{Probability} \end{aligned}$$

The risk (significance) can then be assessed as very low, low, medium, high or very high as follows:

OVERALL SCORE	SIGNIFICANCE RATING (NEGATIVE)	SIGNIFICANCE RATING (POSITIVE)	DESCRIPTION
4-15	Very Low	Very Low	Where the impact is negligible
16-30	Low	Low	Where this impact would not have a direct influence on the decision to develop in the area
31-60	Moderate	Moderate	Where the impact could influence the decision to develop in the area unless it is effectively mitigated
61-80	High	High	Where the impact must have an influence on the decision process to develop in the area
81-100	Very High	Very High	Where the impact would indicate a potential fatal flaw

2. DESCRIPTIONS

2.1 ORGANISATION, SITE LOCATION AND SURROUNDING AREAS

2.1.1 ORGANIZATION

JUWI South Africa is the Cape Town based subsidiary (opened in 2011) of German renewable energy specialist company JUWI AG which is part of the international renewable energy company JUWI Group. JUWI Group was established in 1996 in Germany and is now a wholly-owned subsidiary of the Mannheim-based energy supplier, MVV Energie AG.

JUWI develop solar, wind and hybrid renewable energy solutions and provide engineering, procurement and construction (EPC) and operations and maintenance (O&M) services for solar PV and hybrid systems.

JUWI has planned and built roughly 1,700 PV-plants and has completed wind projects totalling approximately 990 wind turbines with a total capacity of 2,300 megawatt (MW) at more than 175 sites in the last 20 years. JUWI has successfully installed over 400MW of renewables in South Africa and over 5.5GW internationally

2.1.2 LOCATION AND PHYSICAL ADDRESS

Roos Solar Energy BESS – PREFERRED LOCATION

Affected properties for the BESS only: Portion 00014 of Farm 423 Generaalsdraai
Emakhazeni Local Municipality, Mpumalanga Province
GPS co-ordinates: 25°46'07.92" S 29°55'10.27" E

Roos Solar Energy BESS – ALTERNATIVE LOCATION

Affected properties for the BESS only: Portion 00014 of Farm 423 Generaalsdraai; Portion 00003 of Farm 423 Generaalsdraai and Portion 00016 of Farm 423 Generaalsdraai
Emakhazeni Local Municipality, Mpumalanga Province
GPS co-ordinates: 25°46'38.75" S 29°54'21.94" E

2.1.3 DESCRIPTION OF SITE AND SURROUNDINGS

The maps below show that the BESS facilities are planned in an isolated location. Activities in the area consist of crop and livestock farming.

Figure 2.1.1 is a map of South Africa showing the location of the proposed Roos Solar Energy facility.

Figure 2.1.2 is the development area showing the location of the BESS facilities.

Figure 2.1.3 shows 500m circles (from the edge of the site) around the proposed BESS Facilities (Blue) as well as local farmsteads/occupied developments with (red 500m circles) and near-by water courses/bodies (green lines/circles/polygons).

Figure 2.1.1 - Map showing the location of the proposed Roos SEF near Belfast, Mpumalanga, South Africa.

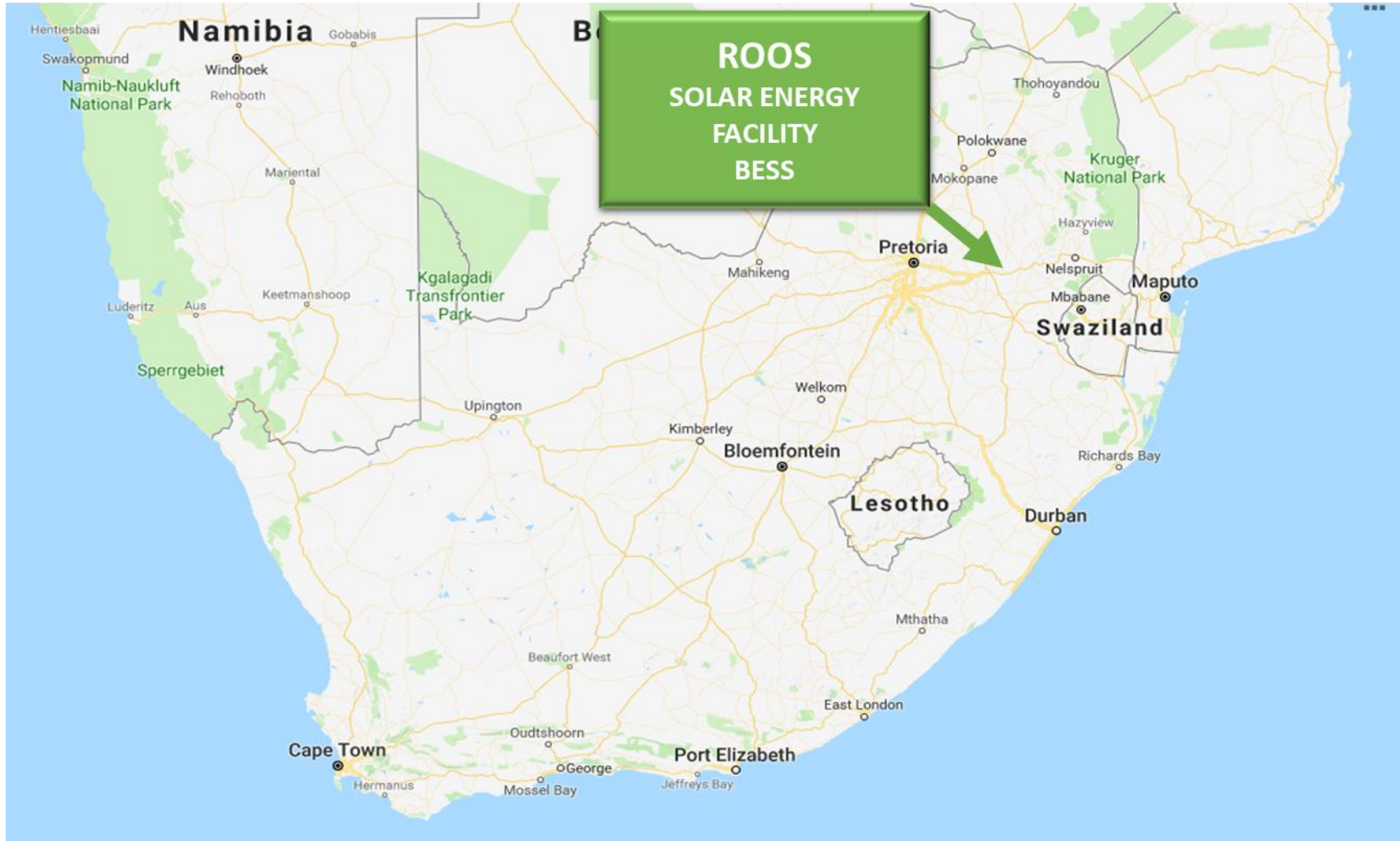
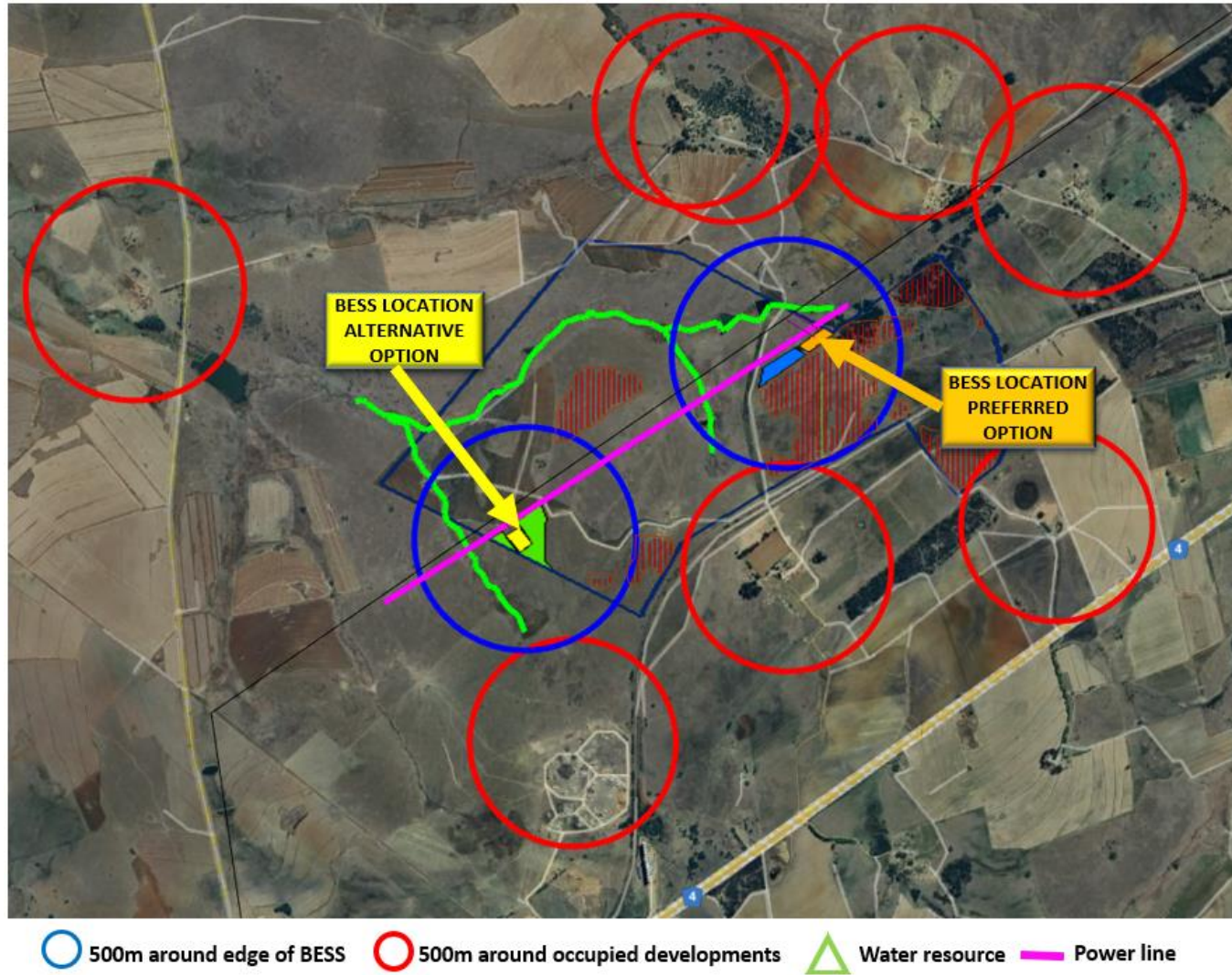

Figure 2.1.2 - The general area of interest for the BESS



Figure 2.1.3 – 500m circles around the BESS Facilities (Blue) and Location of Occupied Developments / Farmhouses (Red) and Nearby Water Courses/Bodies (Green) in the immediate vicinity of the BESS



2.2 TOPOGRAPHY, LAND-USE AND METEOROLOGY

2.2.1 TOPOGRAPHY

Refer to the relevant EIA specialist studies for details of flora and fauna as well as water resources in the area. Vegetation in the area is mostly grass and bushes closer to water courses, the area having been disturbed by agriculture.

The area immediately around the BESS is flat ground.

There are no significant streams immediately adjacent the BESS although there are head waters of streams 100m to the north and west of the proposed sites.

2.2.2 LAND-USE

Refer to the relevant EIA specialist studies for details of the agricultural and commercial activities and cultural aspects in the area. The BESS facilities will not use large amounts of land, typically 2 ha.

The general area is used moderately for agricultural activity, both crops and livestock. There are isolated developments in the vicinity of the SEF, however, none of the dwellings in the area is within 500m of the proposed BESS location.

Across South Africa seismic activity is conceivable with Gauteng (man-made activity) and the Western Cape (natural activity) being relatively higher risk areas. However, compared with aspects such as corrosion, human error etc. seismic activity is not usually a highly likely risk factor, refer to SANS 10160:2011, part 4. [Ref 6]. The proposed area is a low seismic activity area and civil / structural design of the BESS facilities would not normally need to take major additional seismic protection into account.

2.2.3 METEOROLOGY

The site is on the escarpment between the Lowveld and Highveld. The area experiences relatively high rain with frequent heavy thunderstorms in the summer months. Refer to the wind rose below in Figure 2.2.2 which is typical of the area (source SA Weather).

The dominant wind direction in the area is from the north east and north west (typical Highveld conditions) across the site towards the open land to the south.

Across South Africa, lightning strikes are conceivable as a source of ignition of major hazards, refer to SANS10313:2012 lightning strike density table [Ref 7]. The lightning ground flash density (ground strike rate) in the Belfast area (10.9 Flashes/km²/year) is high but not near the highest in South Africa.g. Piet Retief is 15.1. Nevertheless, ignition from on-plant sources is much more likely than lightning, but lightning cannot be ignored as a source of risk particularly for tall structures in wide open flat areas.

Figure 2.2.1 Wind rose indicating the typical wind conditions for the Belfast area

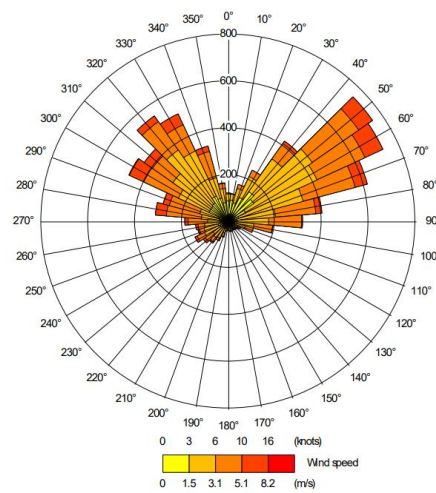

Source – Exxaro Belfast Expansion Project 2021

2.3 PLANT AND PROCESSES

2.3.1 PROPOSED DESIGN LITHIUM SOLID STATE BATTERIES

The one type of battery technology being considered for each BESS is a Solid-State Battery which consists of multiple battery cells that are assembled together to form modules. Each cell contains a positive electrode, a negative electrode and an electrolyte. The BESS will comprise of multiple battery units or modules housed in shipping containers and/or an applicable housing structure which is delivered pre-assembled to the project site. Containers are usually raised slightly off the ground and layout out in rows. They can be stacked if required although this may increase the risk of events in one container spreading to another container. Supplementary infrastructure and equipment may include substations, power cables, transformers, power converters, substation buildings & offices, HV/MV switch gear, inverters and temperature control equipment that may be positioned between the battery containers. The solid-state batteries that are being considered are Lithium-ion systems. The pictures in Figure 2.3.1.1 are typical BESS installations servicing solar power farms. Figures 2.3.1.2 & 2.3.1.3 show typical battery modules in the BESS facility.

FIGURE 2.3.1.1 – Images of Typical BESS Systems Servicing Solar Power Farms



FIGURE 2.3.1.2 – Typical Battery Modules in a BESS with the Separated Sections

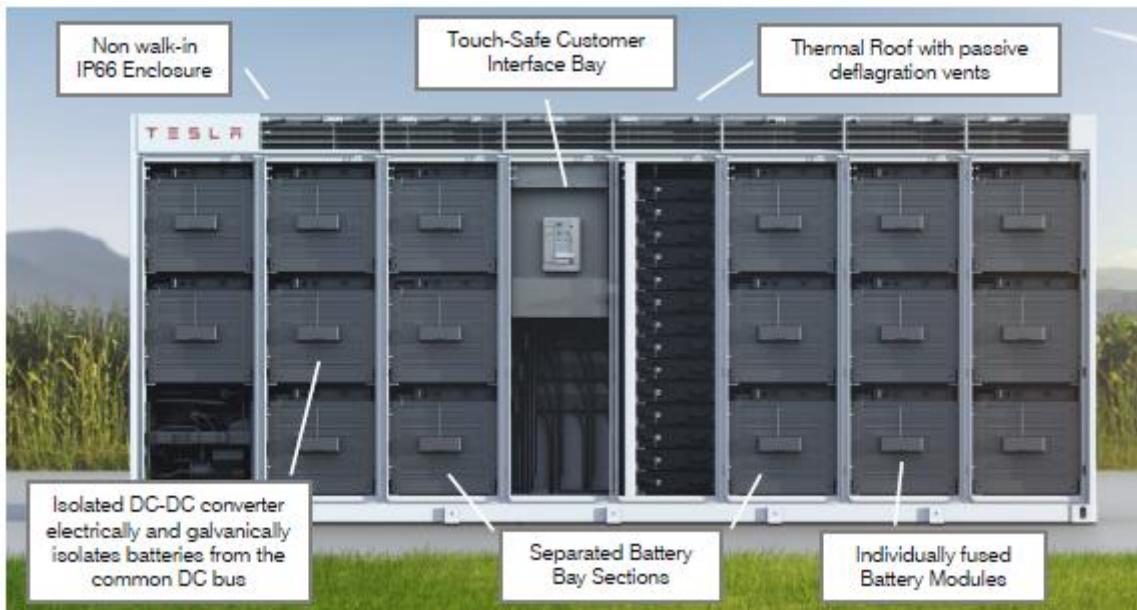

Source – Tesla MegaPack – Safety Overview

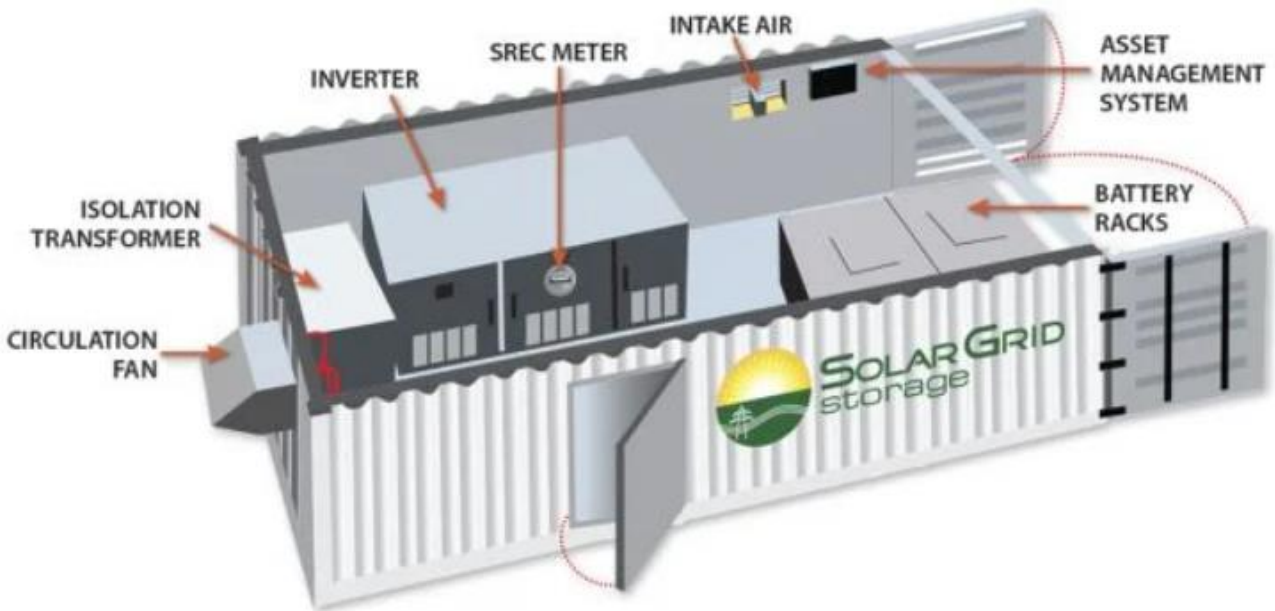

Source – Tesla MegaPack – Safety Overview

FIGURE 2.3.1.3 – Typical Battery Modules in a BESS with the Power Conversion Systems in with the Batteries

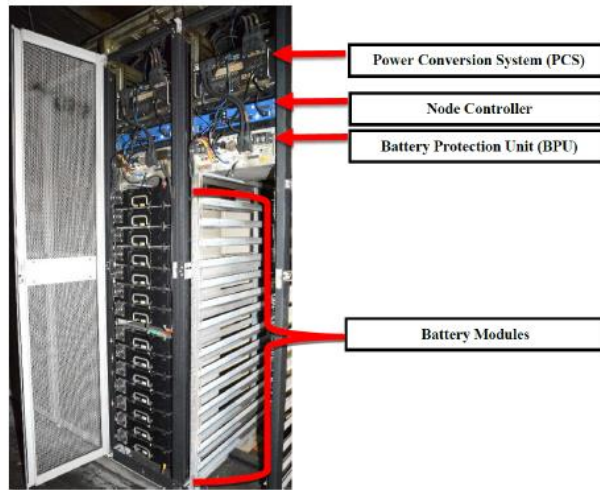

Source – DNV-GL McMicken Event Analysis

2.3.2 PROPOSED DESIGN - VANADIUM REDOX FLOW BATTERIES

One of the types of battery technology being considered for the Battery Energy Storage System (BESS) would be Redox Flow Batteries, typically Vanadium chemistry based (VRFB). These energy storage systems can be supplied either as containerized units or as a fixed installation within a building etc. For this project containerized units are envisioned. However, in order to present contrasting hazards with the containerized lithium batteries in the section above, this report will discuss redox flow systems housed within a large battery building. If containerized systems are used, the essential hazards remain the same, but may just be slightly smaller in magnitude. The pictures in Figure 2.3.1 are typical Redox Flow BESS installations. For this project (up to 500 MW) there are expected to be up to 720 containers, each with six 25m3 tanks of electrolyte within the containers, hence approximately 108 000 m3 of electrolyte in the entire project. Each container acts as bund (secondary containment) able to hold at least the volume of one tank. In addition a bund mound/trench (tertiary containment primarily for any runoff) will be constructed around the entire facility. The pictures in Figure 2.3.2.1&2 are typical Redox Flow BESS installations.

FIGURE 2.3.2.1 – Images of Some Redox Flow BESS Systems – containerized systems or buildings with tanks of electrolyte and battery systems



1 MW 4 MWh containerized vanadium flow battery owned by Avista Utilities and manufactured by UniEnergy Technologies



Source – Bulk Redox flow batteries for renewable energy storage, 21 Jan 2020, J Noak, N Roznyatovskaya, C Menictas, M Skyllas-Kazacos

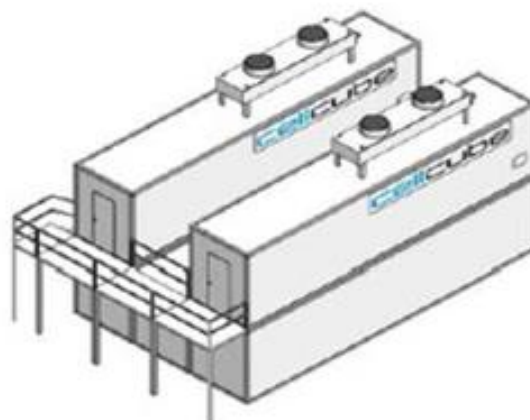

Source – Bushveld Minerals and Energy – Energy Storage and Vanadium Redox Flow batteries 101 – 13 November 2018.
And general Product Info 2023

FIGURE 2.3.2.2 – Typical Battery Cell and Stack Set-up

Within each unit, battery cells assembled together to form stacks, the image below showing a view of typical stack.



Stacks of a 2MW/20MWh vanadium redox flow battery at Fraunhofer ICT. Image:

2.3.3 STAFF AND SHIFT ARRANGEMENT

The BESS facilities will run 7 days a week for 24 hours a day. Although the system will be largely automated with a battery management system and electronic operator interface etc, it will still require attention from operators and maintenance staff. The facility will need routine checking / preventative and breakdown maintenance / grass cutting / security etc. During normal operations there are assumed to be approximately 10 persons on site during the day depending on the activities taking place and possibly one or two operators as well as security personnel at night.

2.3.4 OPERATIONS AT THE BESS FACILITY AND PHASES OF THE BESS PROJECT

The BESS facilities can be considered to have three main phases:

- Construction including transport to site and storage prior to installation,
- Operation including commissioning, maintenance, shutdown – restart,
- Decommissioning including repurposing and disposal.

The main processes undertaken in each of these stages can be summarized as follow together with some details:

TABLE 2.3.4.1 – Project Phase with Main Processes/Activities and Some Details of Likely Elements

No	PHASE	MAIN PROCESSES	DETAILS
1.1	Construction both types of battery technology	Construction machines e.g., cranes, graders, cement trucks, diesel and oil storage	Graders to clear ground make roads, diggers for trenches foundations, cement mixers for civil works, cranes to place containers, diesel bowser for fuel for machines, oil for machines
1.2		Materials for the construction of the Vanadium Redox Flow Battery (VRFB) building, container plinths etc Equipment items for installations within the VRFB building	Building materials such as bricks, cement, re-bar, I-beams, roof sheeting etc. BESS equipment such as tanks, pumps, piping etc. Electrical equipment such as transformers, pylons, cabling.
		Equipment items for containerized installation e.g., lithium battery containers, VRFB containers	Battery containers Electrical equipment such as transformers, pylons, cabling.
1.3		Waste e.g., packaging materials, paint	Connections, transformers, switches etc will likely have protective coverings (Plastic, paper, cable ties etc) to remove during installation, paint waste (cans, brushes, solvents), building rubble
1.4		Construction camp	Temporary offices, accommodation, ablutions
2.1	VRFB Operation	Chemical electrolyte and electrode materials in the battery cell	Tanks, pumps and pipes containing vanadium electrolyte.
2.2		Battery cells, stacks	The batteries will be able to generate up to 500 MW of power for four hours. The electrolyte storage will have capacity to dispatch up to 2000 MWh.
2.3		Electronic equipment in building/container	Battery management system for monitoring of the batteries and control of the loading and unloading cycles
2.4		Electrical equipment inside	Power conversion system, connections, switches, cabling
2.5		Support mechanical equipment	Air conditioners, fans, coolant
2.6		Electrical equipment outside	Network interconnection equipment, switchgear, transformers
2.7		Site office and workshop	Including potable water, 220V power, kitchen, sewage, tools and parts store etc
2.8		Support services	Dirt roads, access control fences, lights inside the container and outside for general access lighting, fire suppression/fighting systems, grass cutting, communication systems
2.9		Waste	Broken parts, storm water run-off, hot air from battery and PCS cooling systems, waste electrolyte from maintenance or other spills
2.10		Lithium Solid State Operation	Chemical electrolyte and electrode materials in the battery cell
2.11	Battery cells, modules and racks typically in shipping containers		The facilities are designed for up to 500 MW/2000 MWh having typically ~ 700 containers. (for example, each Tesla Megapack has up to 3 megawatt hours (MWhs) of storage and 1.5 MW of inverter capacity, other units only have a power rating of just over 0.7 MW per container).
2.12	Electronic equipment in container		Battery management system for monitoring of the batteries and control of the loading and unloading cycles

2.13		Electrical equipment in container or separate container	Power conversion system, connections, switches, cabling
2.14		Mechanical equipment in container(s)	Air conditioners, fans, filters, coolant
2.15		Electrical equipment outside the containers	Network interconnection equipment, switchgear, transformers
2.16		Site office and workshop	Including potable water, 220V power, kitchen, sewage, tools and parts store etc
2.17		Support services	Dirt roads, access control fences, lights inside the container and outside for general access lighting, fire suppression/fighting systems, grass cutting, communication systems
2.18		Waste	Broken parts, storm water run-off, hot air from battery and PCS cooling systems
3.1	Decommissioning both types of battery technology	VRFB Liquid chemical waste	Waste electrolyte solution, transformer oils, coolants
		Solid State Lithium chemical waste	Batteries, air filters, transformer oils, coolants
3.2		Electronic waste	Circuit boards, HMI screens
3.3		Building rubble - non-hazardous waste	Steel, copper, cement, equipment and structures
3.4		VRFB Hazardous waste	Contaminated equipment such as pumps, pipes, bund linings
3.5		Lithium Containers	Shipping containers

3. HAZARD IDENTIFICATION

3.1 SOLID STATE LITHIUM BATTERY CHEMICAL HAZARDS

3.1.1 BATTERIES IN GENERAL

One of the battery types being considered by the project proponent is lithium-ion based solid state batteries.

Lithium-ion based battery systems are becoming one of the dominant technologies for utility systems in Europe and America. For this reason, this assessment assumes that lithium-based batteries will be used in the BESS facilities. Should sodium-based batteries be used, the hazards are likely to be similar at a high level but different in their details, and therefore the Risk Assessment may need to be reviewed.

Primary (non-rechargeable) batteries use lithium metal anodes. Lithium is one of the lightest and most reactive metallic elements and is highly reactive towards water and oxygen. Exposure of lithium metal to water even as humidity can decompose exothermically to produce flammable hydrogen gas and heat. These lithium metal batteries are not used in a BESS. However, if secondary batteries discussed below are charged at temperatures below 0 deg C, then lithium can plate out onto the anode surface and in this manner lithium metal could be present even in lithium-ion batteries.

Secondary, rechargeable lithium batteries, as used in bulk BESSs, use cathodes that contain lithium in the crystal structure of the cathode coating and/or lithium salts in an electrolyte that is in the battery. These are called lithium -ion batteries. Lithium-ion batteries operate at room temperature and have significant limitations outside the 0 – 50 deg range. The exact lithium-ion composition of the batteries can vary with suppliers. In addition, the technology allows for many combinations of chemistry to suit the particular application.

3.1.2 LITHIUM BATTERY CHEMISTRY

The lithium in the batteries is usually in the form of lithium salts dissolved in an electrolyte solution that is absorbed within the electrodes and/or lithium plated onto the surface of the electrode. These are referred to as solid state batteries because electrolyte liquid is not freely available in a form that can easily leak or be extracted. The electrolytes are typically ethylene carbonate or di-ethyl carbonate. The flash points of these carbonates can vary from 18 – 145 deg C which means they can be highly flammable (FP < 60 deg C) or merely combustible if involved in an external fire (FP > 60 deg C). Some of the lithium compound in the electrolyte include lithium hexafluorophosphate, lithium perchlorate, lithium cobalt oxide etc.

3.1.3 HAZARD - THERMAL DECOMPOSITION

Upon heating of the contents of a battery due to shorting, contaminants, external heat or exposure to water and reaction heat, the lithium salts in batteries begin to break down exothermically to release either oxygen (oxidants) that enhances combustion, possibly leading to explosion, or fumes such as hydrogen fluoride or chlorine that are toxic.

These exothermic break down reactions are self-sustaining above a certain temperature (typically 70 deg C) and can lead to thermal run away. In this process the battery gets hotter and hotter, the decomposition reactions happen faster and faster and excessive hot fumes are generated in the battery. Eventually the pressure in the battery builds up to the point where those gases need to vent, usually via the weakest point in the system. These vented fumes can be flammable due to vaporization of the electrolyte and can ignite as a flash fire or fire ball (if large amounts) leading to the fire spreading to any surrounding combustible

materials, e.g., plastic insulation on cables, the electrolyte, the electrodes and possibly even the plastic parts of the battery casing etc. If the vented flammable vapours do not ignite immediately, they can accumulate within the surrounding structures. If this flammable mixture is ignited later, e.g., due to a spark, this can lead to a violent explosion of the module, cabinet, room, container etc.

In addition to being flammable the vented gases will contain toxic components. These could include:

- the products of combustion such as carbon dioxide/monoxide, hydrogen cyanide,
- VOCs like benzene and ethylene,
- decomposition products such as hydrogen fluoride, hydrogen chloride, phosphorous pentafluoride, phosphoryl fluoride and oxides of aluminium, cobalt, copper etc.

The temperature in the batteries and of these vented gases can be extremely high, e.g., > 600 deg C.

In the situation where oxygen is released internally as part of the decomposition (e.g., lithium perchlorate) the oxygen is available to react with the combustible electrolyte and if all this happens extremely fast in a self-sustaining manner within the confines of the device, an explosion of the device can occur with only localized impacts.

3.1.4 HAZARD - PROPAGATION

A BESS is composed of individual batteries which are combined into different size packs such as modules and racks, as illustrated on the diagram below.

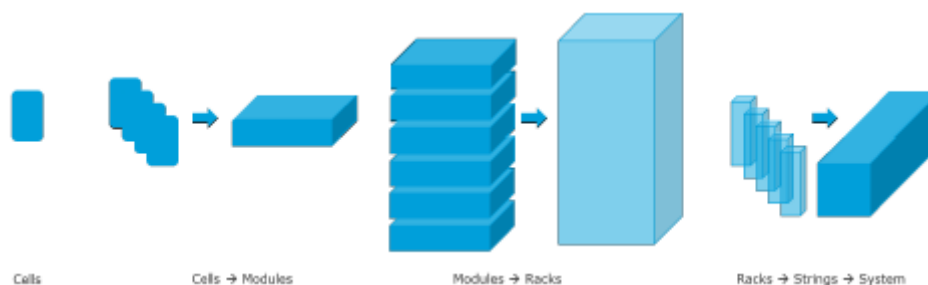

Source DNV-GL McMicken Event Analysis

The very high temperature generated by one battery cell in thermal run away could lead to overheating of adjacent cells. This cell in turn then starts thermal decomposition and so the process propagates through the entire system, as illustrated on the diagram below.

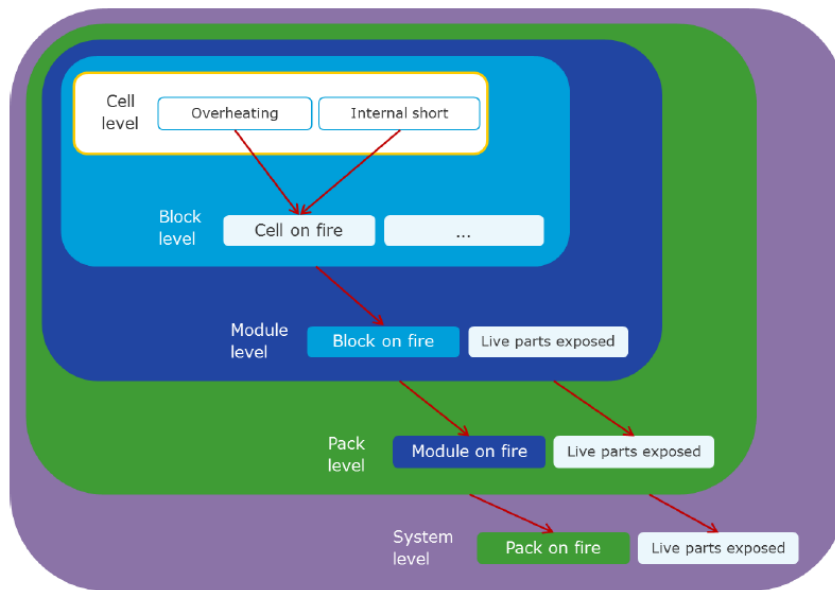

Source – STALLION Report

In order to prevent propagation, there are separation requirements between cells, modules etc. Separation could be with physical space or insulating materials etc.

3.1.5 HAZARD - ELECTROLYTE LEAKS

Although extremely unlikely due to the structure of the batteries, should electrolyte liquid leak out of the batteries, it can be potentially flammable as well as corrosive etc. If ignited as fire, or explosion, the smoke would contain toxic components. If unignited it can still be extremely harmful especially if its decomposition products include hydrofluoric acid.

3.2 VANADIUM REDOX FLOW BATTERY HAZARDS

3.2.1 BATTERIES IN GENERAL

All electrochemical energy storage systems convert electrical energy into chemical energy when charging, and the process is reversed when discharging. With conventional batteries, the conversion and storage take place in closed cells. With redox flow batteries, however, the conversion and storage of energy are separated. Redox flow batteries differ from conventional batteries in that the energy storage material is conveyed by an energy converter. This requires the energy storage material to be in a flowable form. In redox flow batteries, charging and discharging processes can take place in the same cell. Redox flow batteries thus have the distinguishing feature that energy and power can be scaled separately. The power determines the cell size, or the number of cells and the energy is determined by the amount of the energy storage medium. In theory, there is no limit to the amount of energy that can be produced and/or stored thereby allowing for scalability of these systems.

Figure 3.2.1 shows the general operating principle of redox flow batteries. The energy conversion takes place in an electrochemical cell which is divided into two half cells. The half cells are separated from each other by an ion-permeable membrane or separator, so that the liquids of the half cells mix as little as possible. The separator ensures a charge balance between positive and negative half cells, ideally without the negative

and positive active materials coming into direct contact with each other. In fact, however, separators are not perfect so some cross-over of the active materials always occurs and this leads to the self-discharge effect.

FIGURE 3.2.1 – Schematic Diagrams of Redox Flow BESS Systems

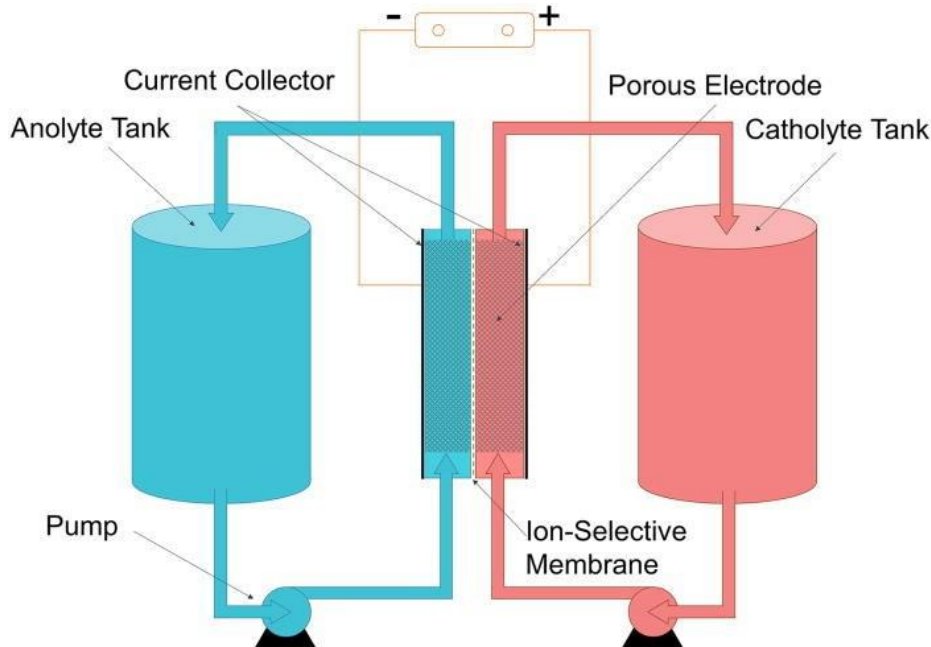

Source – WIKIPEDIA

3.2.2 VANADIUM BATTERY CHEMISTRY

The vanadium redox battery (VRB), also known as the vanadium flow battery (VFB) or vanadium redox flow battery (VRFB), is a type of rechargeable flow battery that employs vanadium ions in different oxidation states to store chemical potential energy. The vanadium redox battery exploits the ability of vanadium to exist in solution in four different oxidation states, and uses this property to make a battery that has just one electroactive element instead of two.

The possibility of creating a vanadium flow battery was explored by Pissort in the 1930s, NASA researchers in the 1970s, and Pellegrini and Spaziante in the 1970s, but none of them were successful in demonstrating the technology. The first successful demonstration of the all-vanadium redox flow battery which employed vanadium in a solution of sulfuric acid in each half was by Maria Skyllas-Kazacos at the University of New South Wales in the 1980s. In redox flow batteries, the electrodes should not participate in the reactions for energy conversion and should not cause any further side reactions (e.g., undesirable gas formation). Most redox flow batteries are therefore based on carbon electrodes.

The redox pair VO_2^+/VO_2^{2+} are at the positive electrode and the redox pair V^{2+}/V^{3+} at the negative electrode. The use of the same ions in the positive and negative electrolytes permits relatively high concentrations of active material. It also overcomes the cross-contamination degradation issues which plague other flow type batteries. The energy storage solution consists primarily of vanadium sulphate in a diluted (2mol/L) sulphuric acid (possibly containing a low concentration of phosphoric acid) and is therefore

roughly comparable to the acid of lead/acid batteries. The energy density is limited by the concentration of the pentavalent + VO₂.

The vanadium redox flow battery is without doubt the best investigated and most installed redox flow battery. For several reasons, including their relative bulkiness, most vanadium batteries are currently used for grid energy storage, i.e., attached to power plants or electrical grids. Currently, there are over 100 VRFB installations globally with an estimated capacity of over 209,800 kWh of energy and the use of vanadium in energy storage applications has doubled to 2.1% of the global vanadium consumption in 2018.

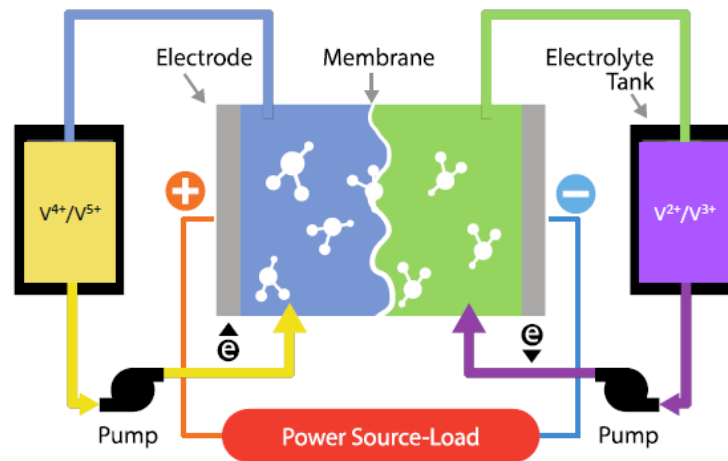

Source: IEEE Spectrum: "It's Big and Long-Lived, and It Won't Catch Fire: The Vanadium Redox-Flow Battery", 26 October 2017

3.2.3 HAZARD – TOXICITY AND CORROSIVITY

The electrolyte in the VRFB system is corrosive. It is composed of a sulphuric acid-based solution similar to common automotive lead acid batteries. Unlike traditional lead-acid batteries, VRBs do not include lead. Therefore, VRBs do not have the toxicity issues of lead that conventional car batteries have. The only potential source of human toxicity in a VRB is Vanadium.

Vanadium in various physio-chemical states can have a relatively high aquatic and human toxicity. Acute oral exposure to high doses can lead to hemorrhaging, while chronic exposure leads to adverse effects on the digestive system, kidneys and blood (diarrhea, cramps etc.).

Inhalation hazards lead to irritation of the respiratory tract, bronchospasm, pulmonary congestion. There is little evidence that vanadium compounds are reproductive toxics or teratogens. There is also no evidence that it is carcinogenic (Source USA EPA Risk Assessment Information Systems, Toxicity Profiles, Vanadium 1998).

In the electrolyte the concentration levels of Vanadium are so low that when it is mixed into liquid form in the final product and put into operation, the VRB is deemed non-toxic. In addition, VRBs have a lower concentration of sulfuric acid than traditional lead-acid batteries. Vanadium poses a hazard when it is in powder form, i.e. when making up the electrolyte solution. The facilities will use electrolyte already made up and there will be no solid vanadium powder on site.

Toxicity or corrosion risks may be present from off-gassing produced by over-heating aqueous or vaporized electrolytes. In addition, flow batteries in fire scenarios may generate toxic gas from the combustion of hydrocarbons, plastics, or acidic electrolytes. Refer to sections on fire below for mitigation measures.

3.2.4 HAZARD – ELECTRICAL SHOCK/ARC

Electrical shock presents a risk to workers and emergency responders, if the energy storage system cannot be “turned off”. This is referred to as “stranded energy” and presents unique hazards. Arc flash or blast is possible for systems operating above 100 V. Li-ion systems operate from 48 - 1000 V, depending on the battery design.

In the area of shock hazard, a flow battery produces voltage only when electrolytes are in a cell stack. For most designs, if the motors are turned off and fluids drained from the cell stack, then the cell stacks have no measurable voltage at the terminals. This happens not only when the battery is forcibly turned off but also in the standby mode as vanadium batteries do not include any metal plates to hold the chemical reactions / charges / voltages and can be fully drained when not in use.

If not fully drained, vanadium flow batteries are also unique in terms of short circuiting in that the internal dynamics of the battery are such that the energy discharge is limited to the fluid in the battery at any given time and the is typically less than 1% of the total stored energy. Therefore, together with the relatively low energy density of the vanadium electrolyte, the immediate release of energy, which occurs as a result of electrical shorting, is somewhat limited. The high heat capacity of the aqueous electrolyte is also beneficial in limiting the temperature rise.

Vanadium flow batteries have been tested under dead-short conditions resulting in normal operation with no danger to either equipment or personnel.

3.2.5 HAZARD – FIRE / DEFLAGRATION

Over 50% of the electrolyte solution is made up of water, which gives the electrolyte a non-flammable property. In the event of short circuiting, intense heat or high pressure, it is unlikely for the battery to catch fire. There is no “thermal runaway” risk when compared to other battery technologies.

Whilst some heat may be discharged from the battery, it will not be at a level that is deemed unsafe.

Like all other RFBs, VRFBs also have a battery management system. A battery management system ensures optimum and safe conditions for battery operation. Often a heat management system is integrated to avoid too high or too low temperatures.

3.2.6 HAZARD - HYDROGEN GENERATION

As with all other aqueous batteries, aqueous energy storage media from redox flow batteries are also subject to water limitations. In case of too high voltages or more precisely too high or too low half-cell potentials, the water is decomposed into its components, hydrogen and oxygen.

The generation of hydrogen in particular is often present as a very small but undesirable side reaction and causes a charge carrier imbalance between positive and negative half-cells, which leads to a slow loss of capacity. It also presents a fire / explosion hazard.

With VRFB, due to the flowability of the energy storage medium, the reaction products that would normally remain in the half-cell can be transported out of the cell and stored in separate tanks thus allowing the capability for a higher capacity than that attainable with conventional batteries. In addition, any deviations from safe operating parameter will trigger the shutdown of the system pumps ceasing to charge the electrolyte and thereby reducing the chances of accidental H₂ generation. In addition, the thermal mass of

the electrolyte tanks can provide an additional barrier to overcharging conditions by allowing ambient temperature during the discharge times to cool the VRFB for the next charge cycle.

3.2.7 HAZARD – WASTE ELECTROLYTE

Unfortunately, pentavalent vanadium ions have a tendency to react with each other, which leads to the formation of larger molecules which precipitate as solids and can thus damage the system. The reaction depends on the temperature and the concentration of VO₂⁺ (state of charge) but is also a function of the proton concentration. Temperature and concentrations therefore need to be controlled within specified ranges.

Should the concentration of undesirable components increase in the electrolyte, a part may need to be purged and replaced with fresh electrolyte. There may be facilities for regenerating purged electrolyte or it may have to be disposed of to a suitable hazardous waste facility.

3.2.8 HAZARD - ELECTROLYTE LEAKS

Leaks must be expected in any hazardous-fluid handling equipment. Secondary containment is typically designed into the system and standard corrosive PPE is required for handling liquid. Reliable leak detection, warning alarms, and containment is paramount. As with any chemicals plant, a suitable design with detection, alarm and trip instrumentation that has been subject to thorough Hazop study should be in place, e.g., detection of dry running of pumps, detection of dead heading of pumps, prevention of reverse flow, detection of drop in tank levels etc.

3.3 OTHER CHEMICALS OR HAZARDS

The BESS is composed not only of the batteries, but also electrical connections, switches, power converters, cooling systems etc. The diagram below shows a typical complex system for a lithium solid state facility.

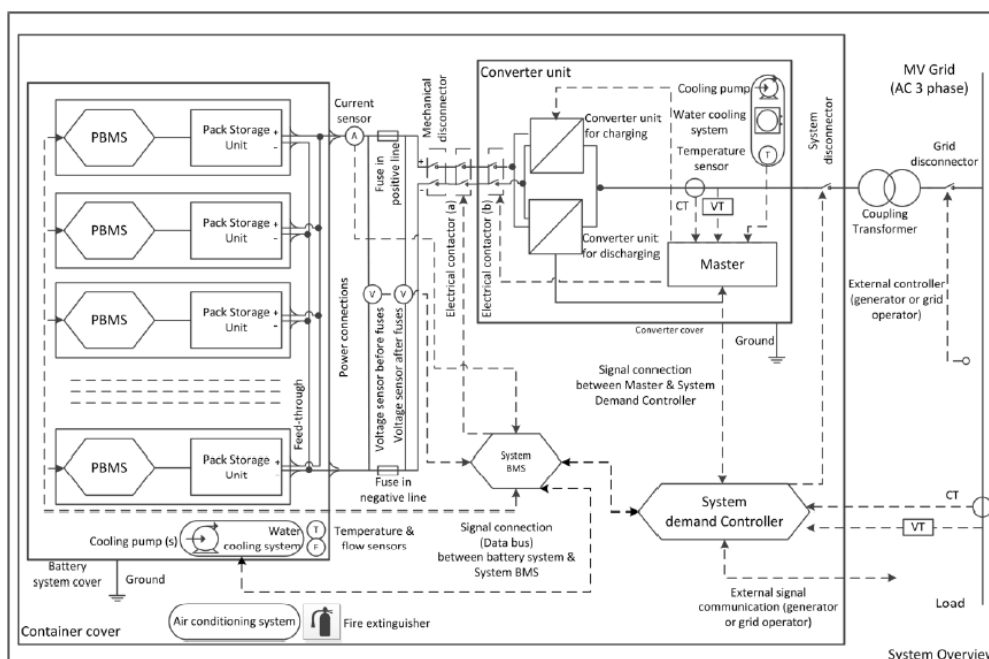

Source – STALLION reports

3.3.1 COOLING SYSTEMS

Due to the need to keep the batteries within a specified temperature range most of the containerized modular system have built-in air-conditioning systems while the VRFB building systems may have cooling water systems. Some have only fans for air cooling with filters to remove dust prior to cooling. Others, particularly those in hot environments requiring more cooling, may have refrigerant-based systems. These would have a refrigerant circuit usually containing non-flammable non-toxic refrigerant such as R134a (simple asphyxiant) etc as well as a low hazard circulating medium such as an ethylene glycol-based coolant. At high temperatures above 250 deg C R134 may decompose and may generate hydrogen fluoride and other toxic gases. Ethylene glycol is really only harmful if swallowed. In the environment it breaks down quickly and at low concentrations that would typically occur from occasional small spills, it has no toxicity.

3.3.2 FIRE SUPPRESSION SYSTEMS

Although these are only effective for some fire scenarios, some of the solid-state containerized systems come fitted with “Clean agent” fire suppressant systems. These are pressurized containers of powder/gases that are released into the container to snuff a fire and do not leave a residue on the equipment. Some containers have water sprinkler systems installed to quench thermal run-away reactions.

In general fire fighters may respond with water cannons/hydrants, foam systems etc. Such responses may generate large amount of contaminated and hazardous water runoff. A system to contain as much of this as possible should be in place.

3.3.3 GENERAL ELECTRICAL AND ELECTRONIC EQUIPMENT

Whatever the configuration of the battery containers/ buildings there will be electrical and electronic equipment in the battery compartment, the battery building as well as outside. In some installations the main electrical equipment such as the power conversion system is in a separate compartment separated by a fire wall. In others it can be in a separate container.

Wherever there is electrical equipment there is a possibility of shorting and overheating and fire.

3.4 PAST ACCIDENTS AND INCIDENTS RELEVANT TO BESS

The following events occurred with various types of batteries, e.g., solid state, and are included for the purpose of possible ideas on how things may go wrong with equipment around the batteries themselves:

1. There have been sodium-sulphur fires in Japanese installations. One such event was at the Tsukuba Plant, (Joso City, Ibaraki Prefecture) of Mitsubishi Materials Corporation where molten material leaked from a battery cell causing a short between battery cells in an adjoining block. As there was no fuse between cells the current continued to flow, with the whole battery module catching fire. Hot molten material melted the battery cell casings inside the battery overflowing to the modules below, causing the fire to spread further.
2. There have been exploding, melting Samsung smartphone lithium batteries.
3. A tesla electric battery powered car caught fire, see image below. Initially, a metal object penetrated the battery causing damage leading to short circuiting and thermal runaway. There was an alarm and the driver warned by on-board computer to park car safely and exit. The runaway did not propagate to the other battery compartment due to separation measures installed. Fire fighters actually made the fire worse by their action to open the battery system to try and get water into it. This allowed air in and the flames to spread to the rest of the car. By way of comparison the American National Fire Protection Agency (NFPA) has stated that there are approximately 90 fires per billion kilometers driven with internal combustion engine cars as compared to the Tesla electric car with only 2 fires per billion driven kilometers.



Source STALLION Report

4. 2010 a UPS Airlines cargo plane from Dubai crashed after a fire started in a large undeclared lithium battery shipment. Since not declared the batteries were not handled in any special manner as would be required if they were a declared hazardous load. There have been two other fires on flights containing lithium battery cargo. In all cases the fire went from small to uncontrolled in less than 30 minutes.
5. 2013 the lithium batteries installed two separate Air Japan Boeing 787 Dreamliners ignited resulting in fires, while on the ground in one case and in-flight in the other.
6. In August 2012, there was a fire at night at the Kahuku wind farm in Hawaii with an advanced lead-acid battery system installed indoors. The fire department were called several hours later and attempted, unsuccessfully to extinguish the fire with dry powder. The fire fighters faced thick smoke and could not enter the building for several hours because it was unclear whether the batteries were emitting toxic fumes
7. February 2012 during commission of a solar BESS in Arizona USA a fire started. The cause is unknown but the fire did not spread beyond the shipping container.
8. 10 August 2016 in Wisconsin USA a fire started in the DC power control compartment of a BESS under construction. Fire department arrived and applied alcohol resistant foam to extinguish the fire. The

fire did not spread to the batteries. As the system was in commissioning the fire suppression system in the PCS was not yet functional.

9. 11 November 2017 Lithium based BESS in Belgium caught fire during commissioning. Fitted fire detection and extinguishing system failed to contain the fire. The fire department were called and rapidly extinguished the fire preventing spreading to adjacent containers.



A fire engulfs a lithium-ion battery system at an Engie test site in Belgium, Nov. 11.

Photo Credit: MrJoostvanL/ YouTube

10. 19 April 2019 explosion at utility company Arizona Public Service's (APS) solar battery facility in Surprise, Arizona. The incident on April 19, 2019, started when there were reports at around 17:00 of smoke from the building housing the BESS. A few hours later, at approximately 20:04, an explosion occurred from inside the BESS. Nine people were injured. The factual conclusions reached by the investigation into the incident were:

- The suspected fire was actually an extensive cascading thermal runaway event, initiated by an internal cell failure within one battery cell in the BESS: cell pair 7, module 2, rack 15.
- It is believed to a reasonable degree of scientific certainty that this internal failure was caused by an internal cell defect, specifically abnormal Lithium metal deposition and dendritic growth within the cell.
- The total flooding clean agent fire suppression system installed in the BESS operated early in the incident and in accordance with its design. However, clean agent fire suppression systems are designed to extinguish incipient fires in ordinary combustibles. Such systems are not capable of preventing or stopping cascading thermal runaway in a BESS.
- As a result, thermal runaway cascaded and propagated from cell 7-2 through every cell and module in Rack 15, via heat transfer. This propagation was facilitated by the absence of adequate thermal barrier protections between battery cells, which may have stopped or slowed the propagation of thermal runaway.
- The uncontrolled cascading of thermal runaway from cell-to-cell and then module-to-module in Rack 15 led to the production of a large quantity of flammable gases within the BESS. Analysis and modelling from experts in this investigation confirmed that these gases were sufficient to create a flammable atmosphere within the BESS container.
- Approximately three hours after thermal runaway began, the BESS door was opened by firefighters, agitating the remaining flammable gases, and allowing the gases to make contact with a heat source or spark. This led to the explosion.



Arizona utility APS has grounded its energy storage operations while the investigation continues.



Posted Tuesday, April 30, 2019 9:44 am

By Jason Stone & Matt Roy, Independent Newsmedia



Source DNV-GL McMicken Event Analysis

11. Records (By WoodMac) indicate that there are approximately 200 BESS systems in the USA and there have been 2 -3 fires in the last 5 -10 years. This is an event frequency of 0.001 - 0.003 events per unit per year. DNV-GL in their quantitative risk analysis of BESS sites found that considering all the latest (2019) safety features the theoretical event frequency should be as low as 0.00001 events/unit/year i.e., 2 orders of magnitude lower than the actual values.
12. Korea has installed over 1200 energy storage systems as part of the clean energy programs. In December 2018 a lithium BESS caught fire at a cement plant in Jecheon. It was the 15th fire in 2018 in Korea. As of June 2019, there had been 23 fires at Korean facilities. The faults are reported to be with the incorrect installation of battery management systems, electrical systems and not due to the batteries themselves. Assuming these BESS systems have on average been in place for 5 years then the event frequency is approximately 0.004 events per unit per year. This correlates to the high value estimated for the USA data. This data is also two orders of magnitude higher than the DNV theoretical prediction on 0.00001 events/unit/year.
13. The Electric Power Research Institute (EPRI) of California USA maintains a list of Battery released accidents on its Wiki-Storage Page. The EPRI is an independent non-profit energy research, development and deployment organization that is funded by organizations around the world including the energy sector, academia and governments. The graphs and lists below summarize some of the incidents and the three accidents described in more below the table are typical of the types of accidents recorded.

System Size ■ < 5MWh ■ 5 - 50 MWh ■ 50 MWh < ■ Unknown

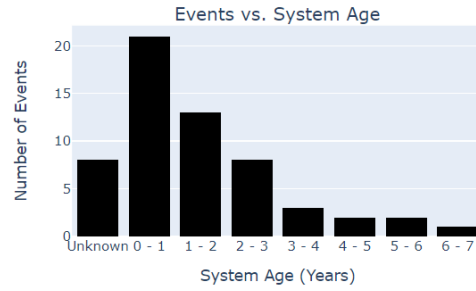
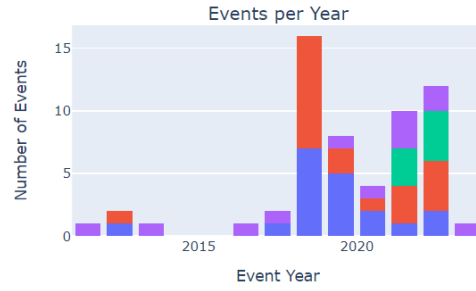
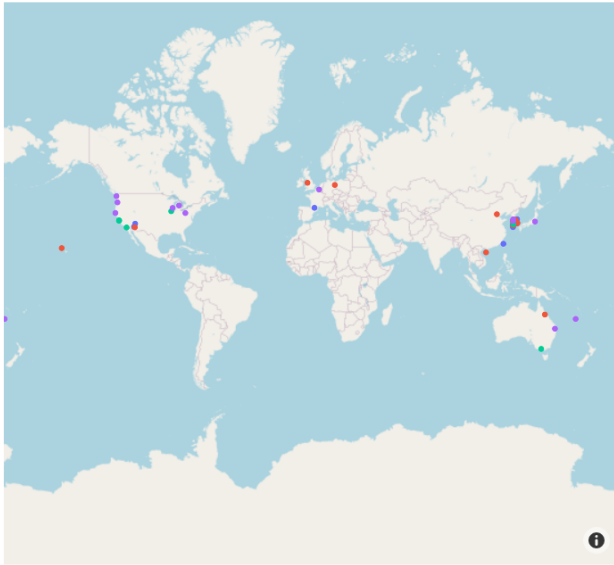

Location	Energy (MWh)	Power (MW)	Application	Installation	Event Date	System Age (yr)	State During Accident	Source	
US, PA, Millvale			Solar Integration	Urban	30 January 2023		Operational	WTAE	
South Korea, Jeollanam-do, Yeongam-gun, Geumjeong-myeon	251		Solar Integration	Rural	27 December 2022	1.8	Operational	E2News.com	
South Korea, Jeollanam-do, Damyang-gun, Mujeong-myeon, Deokgok-ri	9.1	2.5	Solar Integration	Rural	8 December 2022	5.5	Operational	E2News.com	
China, Hainan	50	25	Solar Integration		20 October 2022	0	Commissioning	china5e.com	
US, CA, Moss Landing	730	182.5	Energy Shifting, Ancillary Services	Substation	20 September 2022	0.5	Operational	KSBW News	
South Korea, Incheon		103	Energy Shifting	Factory	6 September 2022		Operational	Teller Report	
US, CA, Rio Dell			Solar Integration / Backup	Rural	3 August 2022	4	Operational	KRCR	
US, AZ, Chandler	40	10		Substation	18 April 2022	3	Operational	AZ Central	
US, CA, Valley Center	560	140		Substation	5 April 2022	0.2	Operational	Valley Road Runner	
Longjing, Taichung City, Taiwan	1	1	Solar Integration	Power Plant	30 March 2022	2	Operational	Economic Daily	
US, CA, Moss Landing	400	100	LG Energy Solution	Solar Integration	Power Plant	13 February 2022	1	Operational	KSBW News
South Korea, Gunwi-gun, Gyeongsangbuk-do	1.5	0.45	LG Energy Solution	Solar integration	Rural	17 January 2022	3	Operation. Fully charged	E2News
South Korea, Nam-gu, Ulsan	50	10	SK Innovation	Peak Load Reduction	Urban	12 January 2022	2	Operational	E2News
US, CA, Moss Landing	1,200	300	LG Energy Solution	Solar Integration	Power Plant	4 September 2021	0.8		Vistra
Australia, Victoria, Geelong	450	300	Tesla	Grid Stability	Rural	30 July 2021	0	Construction, Commissioning	ABC News
US, IL, LaSalle	72	72	LFP	Frequency Regulation	Rural	19 July 2021	1.6		The Times
Germany, Neuhausen	5	5	[LFP]	Solar Integration and Frequency Regulation	Indoor/Hangar	18 July 2021	5		RBB 24
Boulouparis, New Caledonia, France				Solar Integration	Rural	13 July 2021			FranceTVInfo.fr
US, MI, Standish				Demand Charge Mgmt	Substation	19 April 2021	0	Installation	WSGW
China, Beijing	25		Gotion High-Tech [LFP]	Solar Integration	Commerce Area	16 April 2021	2	Construction, Commissioning	CTIF Accident Analysis

- a) There have been three incidents at the Moss Landing Power plants PG&E battery storage facility in the USA where there are 256 TESLA Mega Packs installed. The latest involved one pack which caught alight and burned out five hours later. Firefighting approach was to let the pack burn out. Near-by communities were warned to shelter-in-place and the adjacent highway shutdown due to possible toxic smoke. Only one mega pack burned out and the fire did not spread.



- b) There was a small fire at the new Terra-Gen battery storage facility on Valley Centre Road USA. A small electrical failure produced some smoke which triggered the protection systems. Those worked exactly as planned and the failure was contained to a single battery module (meaning literally a single battery which is about the size of a DVD case). The safety systems worked exactly as planned and in addition the enclosure next to the one with the problem shut down because it also detected the smoke.
- c) The fire broke out during testing of a 13-tonne Tesla lithium megapack at the Victorian Big Battery site near Geelong Australia. A 13-tonne lithium battery was engulfed in flames, which then spread to an adjacent battery bank. This event indicates that if the battery pack units are not suitably separated the heat from one fire can set off an adjacent unit.



4. RISK ASSESSMENT

An analysis was undertaken to identify the failure events, their causes, consequences, as well as the preventative and mitigative measures in place on the proposed installation for all three phases of a typical project.

4.1 SOLID STATE LITHIUM-ION BATTERY ENERGY STORAGE SYSTEMS

TABLE 4.1.1 - CONSTRUCTION PHASE (Excluding commissioning)

Impact number	Receptor	Description	Stage	Character	Preventative and Mitigative Measures	Ease of Mitigation	(M+	E+	R+	D)x	P=	S	(M+	E+	R+	D)x	P=	S
							Raw Risk						Residual Risk					
Impact 1:	Human Health - chronic exposure to toxic chemical or biological agents	Causes - Construction materials such as cement, paints, solvents, welding fumes, truck fumes etc. Consequences - Employee / contractor illness.	Construction	Negative	The construction phase will be managed according to all the requirements of the Occupational Health and Safety Act 85 of 1993 specifically the Construction Regulations. SHEQ policy in place. A detailed construction Risk Assessment prior to work. SHE procedure in place. PPE to be specified. SHE appointees in place. Contractor's safety files in place and up to date. All necessary health controls/ practices to be in place, e.g., ventilation of welding and painting areas. SHE monitoring and reporting programs in place. Emergency response plan to be in place prior to beginning construction and to include aspects such as appointment of emergency controller, provision of first aid, first responder contact numbers.	Moderate	3	1	3	4	4	44	1	1	3	4	2	18
							Significance						N3 - Moderate			N2 - Low		
Impact 2:	Human Health - exposure to noise	Causes - Drilling, piling, generators, air compressors. Consequences - Adverse impact on hearing of workers. Possible nuisance factor in near-by areas.	Construction	Negative	Health Risk Assessment to determine if equipment noise exceeds 85dB at workstation and 61dB at boundary of the site. OHS Act Noise Induced hearing Loss Regulations Employees to be provided with hearing protection if working near equipment that exceeds the noise limits.	Easy	3	1	5	5	4	56	2	1	5	5	2	26
							Significance						N3 - Moderate			N2 - Low		

Impact number	Receptor	Description	Stage	Character	Preventative and Mitigative Measures	Ease of Mitigation	(M+	E+	R+	D)x	P=	S	(M+	E+	R+	D)x	P=	S
							Raw Risk						Residual Risk					
Impact 3:	Human Health - exposure to temperature extremes and/or humidity	Causes - Heat during the day. Cold in winter. Consequence - Heat stroke. Hypothermia.	Construction	Negative	Construction site facilities to comply with Occupational Health and Safety Act 85 of 1993 specifically the thermal, humidity, lighting and ventilation requirements of the Environmental Regulations for Workplaces. Adequate potable water for employees to be provided during all phases of the project. Bore hole, bowser and tank or small water treatment plant may be required to provide potable water for the BESS installation staff during all phases of the project.	Easy	3	2	3	1	2	18	2	2	3	1	1	8
						Significance	N2 - Low						N1 - Very Low					
Impact 4:	Human Health - exposure to psychological stress	Causes - Large projects bring many contractor workers into a small, isolated community. Consequences – Lack of sufficient accommodation, entertainment etc. Increase in alcohol abuse, violence	Construction	Negative	Refer to Social Specialist Study for this project.	Easy	2	3	3	2	2	20	2	3	3	2	2	20
						Significance	N2 - Low						N2 - Low					
Impact 5:	Human Health - exposure to ergonomic stress	Causes - Lifting heavy equipment. Awkward angles during construction. Consequences - Back and other injuries.	Construction	Negative	Training in lifting techniques. Ensure that despite the isolated location all the necessary equipment is available (and well maintained) during construction. Otherwise employees may revert to unsafe practices. Isolated location, maintenance of construction equipment to ensure safe operation is critical. Utilization of local service providers where possible. Ensure this is in place prior to project beginning. First aid provision on site.	Moderate	4	1	3	2	3	30	4	1	3	2	2	20
						Significance	N2 - Low						N2 - Low					

Impact number	Receptor	Description	Stage	Character	Preventative and Mitigative Measures	Ease of Mitigation	(M+	E+	R+	D)x	P=	S	(M+	E+	R+	D)x	P=	S
							Raw Risk						Residual Risk					
Impact 6a:	Human and Equipment Safety - exposure to fire radiation	Causes – Involvement in an external fire. Fire involving fuels used in construction vehicles or vehicles themselves (e.g., tyre fire). Fire due to uncontrolled welding or other hot-work Consequences - Injuries due to radiation especially amongst first responders and bystanders. Fatalities unlikely from the heat radiation as not highly flammable nor massive fire.	Construction	Negative	Fuels stored on site in dedicated, demarcated and banded areas. Suitable fire-fighting equipment on site near source of fuel, e.g., diesel tank, generators, mess, workshops etc. The company responsible for the facility at this particular development stage is to have: 1. Emergency plan to be in place prior to commencement of construction. 2. Fuel spill containment procedures and equipment to be in place. 3. Hot-work permit and management system to be in place.	Complex	4	2	3	5	4	56	4	2	3	5	2	28
							Significance						N3 - Moderate			N2 - Low		
Impact 6b:	Human and Equipment Safety - exposure to fire radiation	Causes - Solid state battery containers damaged on route e.g., dropped in port (drops do happen about 1/2000 containers) and importing possibly < 30 containers for the site. With this it is possible, although unlikely, that one will be dropped, traffic accident on-route. Involvement in an external fire e.g., at the port or on route. Data indicates	Construction	Negative	Solid state battery design includes abuse tests such as drop test, impact, rapid discharge etc. Propagation tests for systems, e.g., heat insulating materials between cells/modules. Factory acceptance test prior to prior to leaving manufacture. Batteries are usually stored at 50% charge to prolong life but may be shipped fully discharged. This level of detail should be understood so as to assess the risk during transport and storage. The company responsible for the battery installation should ensure suitably competent transport companies are appointed. The company responsible for transportation should ensure: - Compliance with National Road Traffic Act regulation 8 – dangerous goods. - Port Authorities should be alerted to the overall project and the hazardous nature of the contents of battery containers being imported. Note. If, as per one	Complex	5	2	5	5	4	68	5	2	5	5	1	17

Impact number	Receptor	Description	Stage	Character	Preventative and Mitigative Measures	Ease of Mitigation	Raw Risk						Residual Risk							
							(M+	E+	R+	D)x	P=	S	(M+	E+	R+	D)x	P=	S		
		<p>installed facility events are 0.001/year. Transport of 700 units per installation assumed to take 4 weeks each so f= 0.05 - once in 20 years so likelihood is moderate.</p> <p>Consequences – Injuries due to radiation especially amongst first responders and bystanders. Fatalities unlikely from the heat radiation as not highly flammable nor massive fire (refer to noxious smoke in APPENDIX A below for the major impact).</p>			<p>of the typical suppliers (Tesla) indications, the containers are classified as IMDG Class 9 – the containers will not receive any special care in the ports and may be stored next to flammables. Port emergency response in particular need training on mitigating battery hazards.</p> <p>Prior to bringing any containers into the country, the company responsible for the battery installation (possibly via appointed contractors) should ensure that an Emergency response plan is in place for the full route from the ship to the site. Drivers trained in the hazards of containerized batteries.</p> <p>The Emergency plan must determine and address:</p> <ul style="list-style-type: none"> - What gases would be released in a fire and are there inhalation hazards. - Extinguishing has two important elements, put out fire and to provide cooling. Different approaches may be needed for small fire – e.g., put out, and for large fires e.g., cool with copious quantities of water. Note inert gases and foam may put out the initial fire but fail to control thermal runaway or to cool the batteries resulting in reignition. - What initial fire extinguishing medium should be used. - Whether there are any secondary gases or residues from use of extinguishers. - If water is appropriate, determine if the system needs outside connections to sprinklers inside the container. - First responders need to know what media to use, especially if water totally unsuitable and if there are no connection points for water etc. - Must the container be left unopened or opened. - PPE to be specified including possible exposure to chemicals and fumes as well as radiate heat. - Containment of residues/water/damaged equipment. - Suitable safe making and disposal plan for after the event i.e. how do responders deal with partially charged damage units, contaminated surfaces (e.g., HF residues). 															
						Significance	N4 - High						N2 - Low							

Impact number	Receptor	Description	Stage	Character	Preventative and Mitigative Measures	Ease of Mitigation	Raw Risk						Residual Risk					
							(M+)	E+	R+	(D)x	P=	S	(M+)	E+	R+	(D)x	P=	S
Impact 7:	Human and Equipment Safety - exposure to explosion over pressures	Causes - With solid state lithium containers, flammable gases generated by thermal run away reach explosive limits. Ignition on hot surfaces, static. Consequences - Potential fatalities amongst first responders. Damage to container, transport truck or other nearby items, e.g., other container in the port.	Construction	Negative	During transport this is only likely to happen due to possible inappropriate emergency response, e.g., opening containers when they may be the type that should be left to burn out. For simplicity one transport route would be preferable. The route needs to be assessed in terms of responding local services, rest places for drivers, refuelling if required, break down services available etc. Once an import route has been chosen, e.g., Richards Bay or Durban and along N2/N3/N11 etc, then the appointed transport company should ensure key emergency services on route could be given awareness training in battery fire/accident response. Emergency response planning and training referred to above may be important for key locations such as the mountain passes / tunnels.	N/A	5	4	5	5	3	57	5	4	5	5	1	19
Impact 8a:	Human and Equipment Safety - exposure to acute toxic chemical and biological agents	Causes Human pathogens and diseases, sewage, food waste. Snakes, insects, wild and domesticated animals and harmful plants. Consequences - Illness and at worst without mitigation, possibly extending to fatalities. Effects can vary from discomfort to fatalities for venomous snakes or bee swarms etc	Construction	Negative	All necessary good hygiene practices to be in place, e.g., provision of toilets, eating areas, infectious disease controls. Policies and practice for dealing with known vectors of disease such as Aids, TB, COVID 19 and others. Awareness training for persons on site, safety induction to include animal hazards. First aid and emergency response to consider the necessary anti-venom, anti-histamines, topical medicines etc. Due to isolated locations some distance from town, ensure the ability to treat with anti-venom and extreme allergic reactions on site.	Complex	4	2	3	2	3	33	3	2	3	2	2	20

Impact number	Receptor	Description	Stage	Character	Preventative and Mitigative Measures	Ease of Mitigation	(M+	E+	R+	D)x	P=	S	(M+	E+	R+	D)x	P=	S
							Raw Risk						Residual Risk					
Impact 8b:	Human and Equipment Safety - exposure to acute toxic chemical and biological agents	<p>Causes - Damaged solid-state batteries release fumes, leak electrolyte, are completely broken exposing hazardous chemicals. Thermal runaway and hazardous fumes released.</p> <p>Consequences - Impacts can vary from mild skin irritation from exposure to small leaks to serious corrosive burns or lung damage.</p>	Construction	Negative	<p>Appointed transport company to ensure transport in accordance with Regulation 8 of the National Road Traffic Act 93 of 1996, Dangerous Goods. Not permitted to transport prescribed goods in manner not consistent with the prescriptions, e.g., consignor and consignee responsibilities. Prescription found in SANS 10228/29 and international codes for battery transport etc.</p> <p>Transport in sealed packages that are kept upright, protected from movement damage etc.</p> <p>Also packaged to ensure no short-circuiting during transport.</p> <p>Transport to prevent excessive vibration considerations as battery internal may be damaged leading to thermal run-away during commissioning. Pre-assembled containers will most likely be supplied. These will be fitted with the necessary protective measures by the supplier considering marine and road transport as well as lifting, setting down etc.</p> <p>Route selection to consider possible incidents along the way and suitable response, e.g., satellite tracking, mobile communication, 24/7 helpline response.</p> <p>Standard dangerous goods requirements for Hazmat labels, Trem cards, driver trained in the hazards of the load.</p> <p>Likelihood similar to fire above.</p>	Complex	4	3	3	5	3	45	4	3	3	5	2	30
							Significance						N3 - Moderate					

Impact number	Receptor	Description	Stage	Character	Preventative and Mitigative Measures	Ease of Mitigation	(M+)	E+	R+	D)x	P=	S	(M+)	E+	R+	D)x	P=	S
							Raw Risk						Residual Risk					
Impact 9:	Human and Equipment Safety - exposure to violent release of kinetic or potential energy	Causes - Construction moving equipment, heavy loaded, elevated loads, working at heights Consequences - Injury or possibly fatality. Damage to equipment. Delays in starting the project, financial losses	Construction	Negative	The construction phase will be managed according to all the requirements of the Occupational Health and Safety Act 85 of 1993 specifically the Construction Regulations. SHEQ policy in place. A detailed construction Risk Assessment prior to work. SHE procedure in place. PPE to be specified. SHE appointees in place. Contractors safety files in place and up to date. SHE monitoring and reporting programs in place. Standard construction site rules regarding traffic, reversing sirens, rigging controls, cordoning off excavations etc. Civil and building structures to National Building Regulations and building Standards Act 103 of 1977 SANS 10400 and other relevant codes. Other constructions such as roads, sewers etc also to relevant SANS standards. All normal procedures for working at heights, hot work permits, confined space entry, cordon off excavations etc to be in place before construction begins. Emergency response plan to be in place before construction begins.	Complex	5	1	5	5	4	64	5	1	5	5	1	16
							N4 - High						N2 - Low					
Impact 10:	Human and Equipment Safety - exposure to electromagnetic waves	Causes - Use of electrical machines, generators etc. Hot dry area static generation is highly likely. Lightning strike. Consequences - Electrocutation. Ignition and burns. Injury and death. Damage electrical equipment.	Construction	Negative	Standard maintenance of condition of electrical equipment and safe operating instructions. Ability to shut off power to systems in use on site. If persons are decanting fuels or dealing with other highly flammable materials care should be taken regarding possible static discharge, installations to be suitably designed and maintained. Lightning strike rate in the study area is high. Outside work must be stopped during thunderstorms. Lighting conductors may be required for the final installation, to be confirmed during design phase.	Complex	5	2	5	5	3	51	5	2	5	5	1	17
						Significance	N3 - Moderate						N2 - Low					

Impact number	Receptor	Description	Stage	Character	Preventative and Mitigative Measures	Ease of Mitigation	(M+	E+	R+	D)x	P=	S	(M+	E+	R+	D)x	P=	S
							Raw Risk						Residual Risk					
Impact 11:	Environment - emissions to air	Causes - Dust from construction and generally hot dry area. Consequences - Adverse impact on employee health.	Construction	Negative	May need to use dampening on roads etc. as per normal construction practices. May need PPE (dust masks) for specific construction workers.	Easy	3	2	1	1	4	28	2	2	1	1	2	12
						Significance	N2 - Low						N1 - Very Low					
Impact 12:	Environment - emissions to water	Causes - Diesel for equipment, paints and solvents. Transformer oil spills. Sewage and kitchen/mess area wastewater. Consequences - Environmental damage, particularly to the surface and underground water in the area.	Construction	Negative	Normal construction site practices for preventing and containing fuels/paint/oil etc spills. Bunding under any temporary tanks, curbing under truck offloading areas and sealed surfaces (e.g., concrete) under truck parking area is particularly important. Spill clean-up procedures to be in place before commencing construction. Sewage and any kitchen liquids - containment and suitable treatment/disposal	Moderate	2	2	3	2	3	27	2	2	3	2	2	18
						Significance	N2 - Low						N2 - Low					
Impact 13:	Environment - emissions to earth	Causes - Mess area and other solid waste. Consequences - Environmental damage.	Construction	Negative	There will be packaging materials that will need to be disposed of after the entire system is connected and commissioned as well as after regular maintenance. There will need to be waste segregation (e.g., electronic equipment, chemicals) and management on the site.	Easy	2	2	3	3	3	30	1	2	3	3	2	18
						Significance	N2 - Low						N2 - Low					
Impact 14:	Environment - waste of resources e.g., water, power etc	Causes - Water usage not controlled. Battery containers damaged. Consequences - Delays.	Construction	Negative	Water usage to be monitored on site during construction. Handling protocols to be provided by battery supplier. End of Life plan needs to be in place before any battery containers enter the country as there may be damaged battery unit from day 1. Water management plan and spill containment plans to be in place.	Easy	1	1	1	2	4	20	1	1	1	2	2	10
							N2 - Low						N1 - Very Low					

Impact number	Receptor	Description	Stage	Character	Preventative and Mitigative Measures	Ease of Mitigation	(M+	E+	R+	D)x	P=	S	(M+	E+	R+	D)x	P=	S
							Raw Risk						Residual Risk					
Impact 15:	Public - Aesthetics	Causes - Bright surfaces reflecting light. Tall structures in a flat area. Consequences - Irritation.	Construction	Negative	Refer to visual impact assessment.	Moderate	2	2	3	3	3	30	2	2	3	3	3	30
							Significance						N2 - Low					
Impact 16:	Investors - Financial	Causes - Defective technology. Extreme project delays. Consequences - Financial loss	Construction	Negative	Design by experienced contractors using internationally recognized and proven technology. Project management with deviation monitoring.	Moderate	5	1	3	4	3	39	3	1	3	4	2	22
							Significance						N2 - Low					
Impact 17:	Employees and investors - Security	Causes - On route, potential hi-jacking of valuable but hazardous load. On site, theft of construction equipment and battery installation facilities. Civil unrest or violent strike by employees. Consequences - Theft. Injury to burglars. Damage to equipment possibly setting off thermal runaway.	Construction	Negative	Fencing around electrical infrastructure to SANS standard and Eskom Guidelines. The hazardous nature of the electrical and battery equipment should be clearly indicated – e.g., Skull and Cross Bones or other signs. Isolated location both helps and hinders security. Night lighting to be provided both indoors and outdoors where necessary.	Complex	4	1	3	2	4	40	3	1	3	2	3	27
							Significance						N2 - Low					

Impact number	Receptor	Description	Stage	Character	Preventative and Mitigative Measures	Ease of Mitigation	(M+	E+	R+	D)x	P=	S	(M+	E+	R+	D)x	P=	S
							Raw Risk						Residual Risk					
Impact 18:	Emergencies	<p>Causes - Fires, explosions, toxic smoke, large spills, traffic accidents, equipment/structural collapse.</p> <p>Inadequate emergency response to small event leads to escalation. Consequences - Injuries turn to fatalities, small losses become extended down time.</p>	Construction	Negative	<p>Emergency procedures need to be practiced prior to commencement of construction.</p> <p>If batteries are stored at 50% charge, thermal run away can happen while in storage on site waiting for installation. In addition, if involved in an external fire thermal run away can happen even with uncharged batteries. Except during shipping, ideally the units should not be stored any closer to each other than they would be in the final installation so that propagation is prevented, i.e. laydown area needs to be considered.</p> <p>The company in charge of the containers at each stage in the transport process needs to be very clear so that responsibility for the integrity of the load and protection of the persons involved in transfer and coordination of emergency response on-route. E.g., if purchased from Tesla where does hand over occur to the South African contractor / owner, at the factory door in USA, at the port in RSA, at the site fence. For example, who will be accountable if there's thermal runaway event on a truck with a container that stops in a small town for driver refreshments</p>	Complex	4	2	3	5	4	56	4	2	3	5	2	28
Impact 19:	Investors - Legal	<p>Causes Battery field is evolving quickly with new guides, codes and regulations happening at the same time as evolving technology. Consequences - Unknown hazards manifest due to using "cheaper supplier or less developed technology".</p>	Construction	Negative	<p>Use only internationally reputable battery suppliers who comply with all known regulations/guideline at the time of purchasing.</p> <p>Ensure only state of the art battery systems are used and not old technologies prone to fires/explosions etc.</p>	Moderate	3	1	3	3	4	40	2	1	3	3	2	18

The above Risk Assessment shows that provided the preventative and mitigative measures are incorporated, the construction phase of the project does not present any high risks nor any fatal flaws.

TABLE 4.1.2 - OPERATIONAL PHASE (Including Commissioning)

From the details of accidents that have happened both with BESS installations and chemical plants in general, it is clear that many potential problems manifest during the commissioning phase when units are first powered up to test functionality. This phase is critical and all controls, procedures, mitigation measures etc that would be in place for full operation should be in place before commissioning commences.

Impact number	Receptor	Description	Stage	Character	Preventative and Mitigative Measures	Ease of Mitigation	Raw Risk						Residual Risk					
							(M+	E+	R+	D)x	P=	S	(M+	E+	R+	D)x	P=	S
Impact 1a:	Human Health - chronic exposure to toxic chemical or biological agents	<p>Causes - Operation and maintenance materials spare parts, paints, solvents, welding fumes, transformers oils, lubricating oils and greases etc.</p> <p>Consequences - Occupational illness.</p>	Operation	Negative	<p>The operation and maintenance phase will be managed according to all the requirements of the Occupational Health and Safety Act 85 of 1993. SHEQ policy in place.</p> <p>A detailed Risk Assessment of all normal operating and maintenance activities on site to be compiled, and form the basis of operating instructions, prior to commencing commissioning.</p> <p>SHE procedure in place, e.g., PPE specified, management of change, integrity monitoring. SHE appointees in place.</p> <p>Training of staff in general hazards on site.</p> <p>All necessary health controls/ practices to be in place, e.g., ventilation of confined areas, occupational health monitoring if required and reporting programs in place.</p> <p>Emergency response plan for full operation and maintenance phase to be in place prior to beginning commissioning and to include aspects such as:</p> <ul style="list-style-type: none"> - appointment of emergency controller, - emergency isolation systems for electricity, - emergency isolation and containment systems for electrolyte, - provision of PPE for hazardous materials response, - provision of emergency facilities for staff at the main office building, - provision of first aid facilities, - first responder contact numbers etc. 	Easy	2	1	3	4	5	50	1	1	3	4	2	18
							Significance						N3 - Moderate					

Impact number	Receptor	Description	Stage	Character	Preventative and Mitigative Measures	Ease of Mitigation	(M+	E+	R+	D)x	P=	S	(M+	E+	R+	D)x	P=	S
							Raw Risk						Residual Risk					
Impact 1b:	Human Health - chronic exposure to toxic chemical or biological agents	Causes - Compromised battery compartments vapours accumulate in the containers, solids/liquids on surfaces. Maintenance of battery components, corrosive and mildly toxic liquid on surfaces. Consequences - Dermatitis, skin /eye/lung irritation.	Operation	Negative	<p>Solid state batteries sealed, individual batteries in modules which are also sealed, pre-packed in the container.</p> <p>Maintenance procedures will be in place should equipment need to be opened, e.g., pumps drained and decontaminated prior to repair in workshop etc. PPE will be specified for handling battery parts and other equipment on site.</p> <p>Training of staff in hazards of chemicals on site.</p> <p>Possible detectors with local alarms if regulated occupational exposure limits are exceeded etc prior to entry for inspection of battery containers.</p> <p>Labelling of all equipment.</p> <p>Confined space entry procedures if entering tanks.</p> <p>There needs to be careful thought given to procedures to be adopted before entering into the BESS or a container particularly after a BMS shut down where there may be flammable or toxic gases present, a fire etc.</p> <p>Safety Data Sheets (SDSs) to be available on site.</p> <p>Operating manuals to be provided including start-up, shut-down, steady state, monitoring requirements.</p> <p>Maintenance manuals with make safe, decontamination and repair procedures.</p> <p>Proposed maintenance schedules e.g., checklists for weekly, monthly, annual etc.</p> <p>Provided portable equipment for calibration and for testing/verification of defective equipment, e.g., volt/current meters, infrared camera</p>	Complex	3	1	3	5	4	48	1	1	3	5	2	20
						Significance	N3 - Moderate						N2 - Low					
Impact 2:	Human Health - exposure to noise	Causes - Moving parts inside containers, buildings, pumps, compressors, cooling systems etc. Consequences - Adverse impact on hearing of workers. Nuisance factor at	Operation	Negative	<p>Design to ensure continuous noise does not exceed 85dB within the facilities or at any other location on site or 61 dB at the site boundary, e.g., emergency generator, air compressor etc. OHS Act Noise Induced hearing Loss Regulations</p> <p>Employees to be provided with hearing protection if working near equipment that exceeds the noise limits.</p>	Easy	2	1	5	5	4	52	2	1	5	5	2	26

Impact number	Receptor	Description	Stage	Character	Preventative and Mitigative Measures	Ease of Mitigation	(M+	E+	R+	D)x	P=	S	(M+	E+	R+	D)x	P=	S
							Raw Risk						Residual Risk					
		near -by residences or other activities.																
Significance						N3 - Moderate						N2 - Low						
Impact 3:	Human Health - exposure to temperature extremes and/or humidity	Causes - Heat during the day. Batteries generate heat within enclosed building / containers. Cold in winter. Night work requires lighting. Consequences - Heat stroke. Hypothermia.	Operation	Negative	Building and container facilities to comply with Occupational Health and Safety Act 85 of 1993 specifically the thermal, humidity, lighting and ventilation requirements of the Environmental Regulations for Workplaces. Ensure containers are temperature controlled as required to remain within the optimal battery operating temperature range. Lighting to be provided inside any buildings, inside the containers, possibly linked to the door opening and outdoors where necessary. Adequate potable water to be provided during all phases of the project. Suitable lighting to be provided including emergency lighting for safe building exit in the event of power failure. PPE for operations and maintenance staff to be suitable for the weather conditions.	Easy	4	2	3	1	2	20	3	2	3	1	1	9
Significance						N2 - Low						N1 - Very Low						
Impact 4:	Human Health - exposure to psychological stress	Causes - Isolated workstation and monotonous repetitive work. Consequences - Low performance, system productivity suffers.	Operation	Negative	Staff rotation to other activities within the site may be necessary. Performance monitoring of inspections / maintenance tasks in particular will be necessary.	Easy	2	3	3	2	2	20	1	3	3	2	1	9
Significance						N2 - Low						N1 - Very Low						

Impact number	Receptor	Description	Stage	Character	Preventative and Mitigative Measures	Ease of Mitigation	(M+	E+	R+	D)x	P=	S	(M+	E+	R+	D)x	P=	S
							Raw Risk						Residual Risk					
Impact 5:	Human Health - exposure to ergonomic stress	Causes - Lifting heavy equipment. Awkward angles during maintenance, stretching reaching to high level and bending to low level. Working at height if equipment located on top of roofs or elevated electrical equipment (e.g., pylons). Consequences - Back and other injuries.	Operation	Negative	Training in lifting techniques. Training in working at heights. If equipment is at height (see OHS Act General Safety Regulation 6), ensure suitable safe (electrically and physically) ladders / harnesses etc. are available. Working at height procedure to be in place.	Easy	5	1	3	2	3	33	4	1	3	2	2	20
						Significance	N3 - Moderate						N2 - Low					

Impact number	Receptor	Description	Stage	Character	Preventative and Mitigative Measures	Ease of Mitigation	Raw Risk						Residual Risk					
							(M+	E+	R+	D)x	P=	S	(M+	E+	R+	D)x	P=	S
Impact 6a:	Human and Equipment Safety - exposure to fire radiation	<p>Causes – Involvement in an external fire e.g., veld fire, maintenance vehicle fire, electrical systems fire. Manufacturing defects or damage to battery leading to shorting and heating. High humidity condensation of water or ingress of water or flooding leading to shorting. Dust accumulation on electrical parts leading to overheating. Excessive electrical loads - surges Operator abuse BMS failure or software failure. Incorrect extinguishing medium, escalate the fire. Consequences - Contaminated run off. Radiation burns unlikely to be severe as no highly flammable materials on site. Damaged equipment. Fire spreads to other units or offsite if</p>	Operation	Negative	<p>Grass cutting and fire breaks around the BESS installations to prevent veld fires. No combustible materials to be stored in or near the batteries or electrical infrastructure. Separation of site diesel tank, transformers from BESS and vice versa. There are BESS design codes from the USA and standards of practice that can be used e.g., UL9540, NFPA 855 and DNV GL RP 43. Detailed FMEA/Hazop/Bowtie to done during design at the component level and system levels. Safety integrity level rating of equipment (failure probably) with suitable redundancy if required. Site Acceptance Testing as part of commissioning of each unit and the overall system. Abuse tests conducted by supplier. BMS should be checking individual cell voltage as well as stack, module, container, system voltages/current etc. BMS tripping the cell and possibly the stack/building unit or module/rack/container, if variations in voltage. Diagnostics easily accessible. Diagnostics able to distinguish cell from stack or cell from module faults. Protective systems are only as good as their reliability and functionality testing is important, e.g., testing that all battery trips actually work. Fire resistant barrier between the batteries and the PCS side if in the same container, or separate containers. Suitable ingress protection level provided for electrical equipment, e.g., IP55 - 66. If air cooling into container, suitable dust filters to be provided. Smoke detectors linked to BMS & alerts in control room. Effects of battery aging to be considered. Solid state battery life starts to be impacted above 40 deg C and significant impacts above 50 deg C with thermal run away starting at 65-70 deg C. BMS trips system at 50 deg C. Temperature monitoring to be in place. Regular infrared scanning. Data needs to be stored for trend analysis. Data indicates an event frequency of 0.001 per installation and with 700 units this would mean an event once 2 years, i.e. a high probability event. Most events will be small not resulting in injuries, but this is possible if the event is not controlled.</p>	Complex	5	1	5	5	4	64	5	1	5	5	1	16

Impact number	Receptor	Description	Stage	Character	Preventative and Mitigative Measures	Ease of Mitigation	Raw Risk					Residual Risk							
							(M+	E+	R+	D)x	P=	S	(M+	E+	R+	D)x	P=	S	
		grass/vegetation not controlled.			<p>Prior to commencement of cold commissioning, emergency plan from transport and construction phase to be extended to operational phase and to include the hazards of the electrically live system.</p> <p>Procedure to address solid state container fires - extinguishing, ventilating, entering as appropriate or not. PPE for container firefighting include fire retardant, chemically resistant, nitrile gloves, antistatic acid resistant boots, full face shields, BA sets.</p> <p>A planned fire response to prevent escalation to an explosion or an environmental event.</p> <p>Suitable supply of fire extinguishing medium and cooling medium</p> <p>Consider fire water for cooling adjacent equipment – BESS units.</p> <p>Can use fogging nozzles to direct smoke.</p> <p>Ensure procedures in place for clean up after event Lingering HF and other toxic residues in the soil and on adjacent structures.</p> <p>Procedures to be in place for IR scanning (or other suitable method) to determine if batteries are still smouldering / are sufficient cooled to handle as batteries may still be active some weeks after an event.</p> <p>Smoke or gas detector systems that are not part of the original battery container package, need to be linked to the main control panel for the entire system so that issues can be detected and responded to rapidly.</p>														

Impact number	Receptor	Description	Stage	Character	Preventative and Mitigative Measures	Ease of Mitigation	(M+	E+	R+	D)x	P=	S	(M+	E+	R+	D)x	P=	S						
							Raw Risk						Residual Risk											
							Significance						N4 - High						N2 - Low					
Impact 6b:	Human and Equipment Safety - exposure to fire radiation	Causes - Power Conversion System (PCS – DC to AC) cooling failure electrical fire. Consequences - Fire starts in PCS or another section or room and spreads to battery area.	Operation	Negative	Modern lithium container design put the PCS in another part of the container with a fire rated wall separating it from the battery. Alternately the PCS is another container altogether.	Moderate	5	2	5	5	4	68	5	2	5	5	1	17						
							Significance						N4 - High						N2 - Low					
Impact 7:	Human and Equipment Safety - exposure to explosion over pressures	Cause 1 - Transformer shorting / overheating / explosion. Cause 2 - Flammable gases generated by thermal run away reach explosive limits. Ignition on hot surfaces, static. Lithium Cobalt Oxide generates O2 during decomposition – escalation. Consequences - Potential fatalities amongst first responders. Damage to container or other nearby items, e.g., other container.	Operation	Negative	Electrical equipment will be specified to suit application. Emergency response plan and employee training referred to above is to be in place. This is only really likely to happen due to possible inappropriate emergency response, e.g., opening containers when they may be the type that should be left to burn out. Modern state of the art containers have ventilation systems for vapours. Undertake a hazardous area classification of the inside of the container to confirm the rating of electrical equipment, due to possible leaks of electrolyte or generation of flammable gases under thermal run away. Emergency response plan and employee training referred to above is critical. Suitable training of selected emergency responders who may be called out to the facilities is critical. NOTE. Refer to Appendix A for an initial approximation of worst-case possible explosion impact zones.	Moderate	5	1	5	5	2	32	5	1	5	5	1	16						
							Significance						N3 - Moderate						N2 - Low					

Impact number	Receptor	Description	Stage	Character	Preventative and Mitigative Measures	Ease of Mitigation	Raw Risk						Residual Risk					
							(M+)	E+	R+	(D)x	P=	S	(M+)	E+	R+	(D)x	P=	S
Impact 8a:	Human and Equipment Safety - exposure to acute toxic chemical and biological agents	Causes Human pathogens and diseases, sewage, food waste. Snakes, insects, wild and domesticated animals and harmful plants. Consequences - Illness and at worst without mitigation, possibly extending to fatalities. Effects can vary from discomfort to fatalities for venomous snakes or bee swarms etc	Operation	Negative	All necessary good hygiene practices to be in place, e.g., provision of toilets, eating areas, infectious disease controls. Policies and practice for dealing with known vectors of disease such as Aids, TB, COVID 19 and others. Awareness training for persons on site, safety induction to include animal hazards. First aid and emergency response to consider the necessary anti-venom, anti-histamines, topical medicines etc. Due to isolated locations some distance from town, ensure the ability to treat with anti-venom and extreme allergic reactions on site.	Moderate	4	1	3	2	3	30	3	1	2	2	2	16
							Significance						N2 - Low			N2 - Low		
Impact 8b:	Human and Equipment Safety - exposure to acute toxic chemical and biological agents	Causes - Damaged batteries components, leak electrolyte, are completely broken exposing hazardous chemicals. Hazardous fumes released on thermal run away see fire above. Consequences - Impacts can vary from mild skin irritation from exposure to small leaks to serious corrosive burns for large exposure.	Operation	Negative	Acid resistant PPE (e.g., overalls, gloves, eyeglasses) to be specified for all operations in electrolyte areas. PPE to be increased (e.g., full-face shield, aprons, chemical suits) for operations that involve opening equipment and potential exposure, e.g., sampling, maintenance. All operators/maintenance staff trained in the hazards of chemicals on site. Batteries contained, modules contained and all inside a container that acts as bund. Refer to fire above as all the protective measures apply to prevent toxic smoke. Refer to fire above as all the measures apply to mitigate toxic smoke. 24/7 helpline response. Standard dangerous goods requirements for Hazmat labels. All operators/maintenance staff trained in the hazards.	Moderate	4	3	3	5	3	45	3	3	3	5	2	28

Impact number	Receptor	Description	Stage	Character	Preventative and Mitigative Measures	Ease of Mitigation	(M+	E+	R+	D)x	P=	S	(M+	E+	R+	D)x	P=	S
							Raw Risk						Residual Risk					
		In the case of toxic fumes, serious lung damage.			NOTE Refer to Appendix A for an initial approximation of worst case possible noxious smoke impact zones.													
						Significance	N3 - Moderate						N2 - Low					
Impact 9:	Human and Equipment Safety - exposure to violent release of kinetic or potential energy	Causes - Moving equipment, pumps, heavy equipment at elevation, nip points, working at heights. Traffic accidents. Earthquake / tremor. Consequences - Injury. Fatality in unlikely worst case, e.g., traffic accidents or fall from heights. Damage to equipment, spills, environment pollution	Operation	Negative	<p>Apart from pumps, no major moving parts during operation.</p> <p>Maintenance equipment to be serviced and personnel suitably trained in the use thereof. Normally just small vehicles on site, bakkies, grass cutting, cherry-pickers etc. Possibly large cranes if large equipment or elevated structure removed/replaced.</p> <p>Traffic signs, rules etc in place on site.</p> <p>All normal working at heights, hot work permits, confined space entry, cordon off unsafe areas/works etc to be in place.</p> <p>Emergency response plan.</p> <p>Civil design to take seismic activity into account.</p>	Moderate	5	1	5	5	3	48	5	1	5	5	1	16
							N3 - Moderate						N2 - Low					

Impact number	Receptor	Description	Stage	Character	Preventative and Mitigative Measures	Ease of Mitigation	Raw Risk						Residual Risk					
							(M+	E+	R+	D)x	P=	S	(M+	E+	R+	D)x	P=	S
Impact 10:	Human and Equipment Safety - exposure to electromagnetic waves	Causes - Use of electrical machines, generators etc. Hot dry area static generation is highly likely. Lightning strike. Consequences - Electrocution. Ignition and burns. Injury and death. Damage electrical equipment.	Operation	Negative	<p>Codes and guidelines for electrical insulation. Suitable PPE to be specified. Low voltage equipment (e.g., batteries) separated from high voltage (e.g., transmission to grid). Ensure trained personnel and refer to guideline – IEE 1657 – 2018. Ensure compliance with Eskom Operating Regulations for high voltage systems including access control, permit to work, safe work procedures, live work, abnormal and emergency situations, keeping records. Electromagnetic fields, impact on other equipment e.g., testing devices, mobile phones – malfunction, permanent damage. Software also need to be kept as update to date as reasonably practicable. Consider suitably located Emergency stop buttons for the facility and the other equipment on site. PPE to consider static accumulation for entering the facility, and particularly the battery containers especially after a high temperature shut down where there could possibly be flammable materials. The procedures for responding to alarm and auto shut down on containers, needs to consider that there may be a dangerous environment inside and how to protect personnel who may enter to respond.</p> <p>Lightning strike rate in proposed development area is high. All outside work must be stopped during thunder storms. Lighting conductors may be required for the installation, to be confirmed during design</p>	Complex	5	2	5	5	3	51	5	2	5	5	1	17
Impact 11:	Environment - emissions to air	Not expected on a normal basis. Refrigerant may be an asphyxiant if accidentally released indoors it can	Operation	Negative	Especially after any warning alarms have gone off, but possibly even normally the container could be treated as entering a confined space and similar procedures could be in place, e.g., do not enter alone, gas testing prior to entering, ensure adequate ventilation	Easy	3	1	1	1	3	18	3	1	1	1	1	6

Impact number	Receptor	Description	Stage	Character	Preventative and Mitigative Measures	Ease of Mitigation	Raw Risk						Residual Risk					
							(M+	E+	R+	D)x	P=	S	(M+	E+	R+	D)x	P=	S
		accumulate and displace oxygen.																
						Significance	N2 - Low						N1 - Very Low					
Impact 12:	Environment - emissions to water	<p>Causes - Cooling water blow-down. Laboratory waste (if included in the design). Maintenance waste, e.g., oils. Spills from batteries, coolant system, diesel trucks, transformers. Parked vehicles – oil drips. Fire water runoff control. Kitchen waste and sewage. Refrigerant release.</p> <p>Consequences - Pollution if not contained. Excessive disposal costs if emissions not limited.</p>	Operation	Negative	<p>Bunding under any outdoors tanks, curbing under truck offloading areas and sealed surfaces (e.g., concrete) under truck parking area is particularly important.</p> <p>Sewage and any kitchen liquids - containment and suitable treatment/disposal.</p> <p>Procedures for dealing with damaged/leaking equipment as well as clean-up of spills.</p> <p>Normal site practices for preventing and containing diesel/paint etc spills.</p> <p>Waste management plan to be in place e.g., liquid waste treatment or suitable removal and disposal will be provided.</p> <p>Spill clean-up procedures to be in place before bringing container on site, including spill kits – non-combustible materials, hazmat disposal.</p> <p>The National Environment Management Act (NEMA) has a list of substances with Reportable spill Quantities, ensure compliance with this.</p>	Moderate	2	2	3	2	3	27	2	2	3	2	2	18
						Significance	N2 - Low						N2 - Low					
Impact 13:	Environment - emissions to earth	<p>Causes - Mess area and other solid waste. Disposal of solid-state batteries. Consequences - Environmental damage.</p>	Operation	Negative	<p>Implement waste segregation (e.g., electronic equipment, chemicals, domestic) and management on the site.</p>	Easy	2	2	3	3	3	30	2	2	3	3	1	10
						Significance	N2 - Low						N1 - Very Low					

Impact number	Receptor	Description	Stage	Character	Preventative and Mitigative Measures	Ease of Mitigation	(M+	E+	R+	D)x	P=	S	(M+	E+	R+	D)x	P=	S
							Raw Risk						Residual Risk					
Impact 14:	Environment - waste of resources e.g., water, power etc	Causes - Similar to construction phase. Disposal of batteries or components. Disposal of containers. Water usage not controlled. Consequences - Delays. Excessive costs and disposal of large volumes of hazardous waste.	Operation	Negative	Water usage to be monitored on site. Handling protocols to be provided by supplier of batteries. Water management plan and spill containment plans to be in place. Investigate end of Life plan for solid state batteries - reuse / recovery / reconditioning. Similarly, for decommissioned containers – reuse / recovery / repurpose	Easy	1	1	1	2	4	20	1	1	1	2	2	10
							N2 - Low						N1 - Very Low					
Impact 15:	Public - Aesthetics	Causes - Bright surfaces reflecting light. Tall structures in a flat area. Consequences - Irritation.	Operation	Negative	Refer to Visual Impact Assessment which is to include the BESS installation once design details are available	Easy	1	2	4	4	2	22	1	2	4	4	2	22
							Significance						N2 - Low					
Impact 16:	Investors - Financial	Causes - Defective technology. Extreme project delays. Consequences - Financial loss	Operation	Negative	Design by experienced contractors using internationally recognized and proven technology. Project management with deviation monitoring.	Easy	5	1	3	4	3	39	3	1	3	4	2	22
							Significance						N3 - Moderate					

Impact number	Receptor	Description	Stage	Character	Preventative and Mitigative Measures	Ease of Mitigation	(M+	E+	R+	D)x	P=	S	(M+	E+	R+	D)x	P=	S
						Raw Risk						Residual Risk						
Impact 17a:	Employees and investors - Security	Causes - On route, potential hi-jacking of valuable but hazardous load. On site, theft of construction equipment and battery installation facilities. Civil unrest or violent strike by employees. Consequences - Theft. Injury to burglars. Damage to equipment possibly setting off thermal runaway.	Operation	Negative	Fencing around electrical infrastructure to SANS standard and Eskom Guidelines. Consider motion detection lights and CCTV. The hazardous nature of the electrical and battery equipment should be clearly indicated – e.g., Skull and Cross Bones or other signs. Isolated location both helps and hinders security. Night lighting to be provided both indoors and outdoors where necessary.	Moderate	3	1	3	2	4	36	3	1	3	2	2	18
						Significance	N3 - Moderate						N2 - Low					
Impact 17b:	Employees and investors - Security	Causes - Cyber security attacks aimed at the National Electricity Grid. Consequences - Ransom of the National Electricity Grid.	Operation	Negative	Cyber security needs monitoring. Remote access to system needs to be negotiated and controlled. Password controls, levels of authority etc. Protection of the National Electricity Grid from Cyber-attacks accessing through the BESS. Cyber emergency procedures – should be in place prior to commissioning.	Complex	4	4	3	1	4	48	4	4	3	1	2	24
						Significance	N3 - Moderate						N2 - Low					
Impact 18:	Emergencies	Causes - Fires, explosions, toxic smoke, large spills, traffic accidents, equipment/structural collapse. Inadequate emergency response to small event leads	Operation	Negative	Emergency procedures need to be practiced prior to commencement of operations. Escape doors should swing open outwards and not into the container. Doors should be able to be hooked open when persons are inside the container, i.e. they should not be automatically self-closing. More than one exit from buildings. Storage of spare batteries (e.g., in stores on site or	Complex	4	2	3	4	3	39	4	2	3	4	2	26

Impact number	Receptor	Description	Stage	Character	Preventative and Mitigative Measures	Ease of Mitigation	(M+	E+	R+	D)x	P=	S	(M+	E+	R+	D)x	P=	S
							Raw Risk						Residual Risk					
		to escalation. Consequences - Injuries turn to fatalities, small losses become extended down time.			elsewhere) also needs to consider possible thermal run away.													
Significance						N3 - Moderate						N2 - Low						
Impact 19:	Investors - Legal	Causes Battery field is evolving quickly with new guides, codes and regulations happening at the same time as evolving technology. Consequences - Unknown hazards manifest due to using "cheaper supplier or less developed technology".	Operation	Negative	Use only internationally reputable battery suppliers who comply with all known regulations/guideline at the time of purchasing. Ensure only state of the art battery systems are used and not old technologies prone to fires/explosions etc.	Moderate	3	1	3	3	4	40	3	1	3	3	2	20
Significance						N3 - Moderate						N2 - Low						

The above Risk Assessment shows that, provided the preventative and mitigative measures are incorporated, the operational phase of the project does not present any high risks nor any fatal flaws.

TABLE 4.1.3 - DECOMMISSIONING PHASE

Battery components may have a limited lifespan, there are damaged equipment etc. There could already be “waste” on the first day of commissioning and plans should be in place to deal with this. Ideally an End-of-Life plan needs to be in place before the first container / equipment is brought on site.

All decommissioning activities must comply with the relevant regulations at the time. Decommissioning will ultimately need to be informed by the regulatory requirements at the time, which may be different to present requirements. The impact rating are not possible to determine now given the uncertainties in mitigations applicable at that time, hence they have been left as neutral.

Impact number	Receptor	Description	Stage	Character	Preventative and Mitigative Measures	Ease of Mitigation	(M+	E+	R+	D)x	P=	S	(M+	E+	R+	D)x	P=	S
							Raw Risk						Residual Risk					
Impact 1:	Human Health - chronic exposure to toxic chemical or biological agents	Similar to the construction and operational phases - no new hazards.	De-commission	Negative	As per construction and operational phases.	Easy	1	1	1	1	1	4	1	1	1	1	1	4
							Significance						#N/A					
Impact 2:	Human Health - exposure to noise	Similar to the construction and operational phases - no new hazards.	De-commission	Negative	As per construction and operational phases.	Easy	1	1	1	1	1	4	1	1	1	1	1	4
							Significance						#N/A					
Impact 3:	Human Health - exposure to temperature extremes and/or humidity	Similar to the construction and operational phases - no new hazards.	De-commission	Negative	As per construction and operational phases.	Easy	1	1	1	1	1	4	1	1	1	1	1	4
							Significance						#N/A					
Impact 4:	Human Health - exposure to psychological stress	Similar to the construction and operational phases - no new hazards.	De-commission	Negative	As per construction and operational phases.	Easy	1	1	1	1	1	4	1	1	1	1	1	4
							Significance						#N/A					

Impact number	Receptor	Description	Stage	Character	Preventative and Mitigative Measures	Ease of Mitigation	(M+	E+	R+	D)x	P=	S	(M+	E+	R+	D)x	P=	S
							Raw Risk						Residual Risk					
Significance							#N/A						#N/A					
Impact 5:	Human Health - exposure to ergonomic stress	Similar to the construction and operational phases - no new hazards.	De-commission	Negative	As per construction and operational phases.	Easy	1	1	1	1	1	4	1	1	1	1	1	4
Significance							#N/A						#N/A					
Impact 6:	Human and Equipment Safety - exposure to fire radiation	Similar to the construction and operational phases - no new hazards.	De-commission	Negative	As per construction and operational phases.	Easy	1	1	1	1	1	4	1	1	1	1	1	4
Significance							#N/A						#N/A					
Impact 7:	Human and Equipment Safety - exposure to explosion over pressures	Similar to the construction and operational phases - no new hazards.	De-commission	Negative	As per construction and operational phases.	Easy	1	1	1	1	1	4	1	1	1	1	1	4
Significance							#N/A						#N/A					
Impact 8:	Human and Equipment Safety - exposure to acute toxic chemical and biological agents	Similar to the construction and operational phases - no new hazards.	De-commission	Negative	As per construction and operational phases.	Easy	1	1	1	1	1	4	1	1	1	1	1	4
Significance							#N/A						#N/A					
Impact 9:	Human and Equipment Safety - exposure to violent release of kinetic or potential energy	Similar to the construction and operational phases - no new hazards.	De-commission	Negative	As per construction and operational phases.	Easy	1	1	1	1	1	4	1	1	1	1	1	4
							#N/A						#N/A					

Impact number	Receptor	Description	Stage	Character	Preventative and Mitigative Measures	Ease of Mitigation	(M+	E+	R+	D)x	P=	S	(M+	E+	R+	D)x	P=	S
							Raw Risk						Residual Risk					
Impact 10:	Human and Equipment Safety - exposure to electromagnetic waves	Similar to the construction and operational phases - no new hazards.	De-commission	Negative	As per construction and operational phases.	Easy	1	1	1	1	1	4	1	1	1	1	1	4
						Significance	#N/A						#N/A					
Impact 11:	Environment - emissions to air	Similar to the construction and operational phases - no new hazards.	De-commission	Negative	As per construction and operational phases.	Easy	1	1	1	1	1	4	1	1	1	1	1	4
						Significance	#N/A						#N/A					
Impact 12:	Environment - emissions to water	Similar to the construction and operational phases - no new hazards.	De-commission	Negative	As per construction and operational phases.	Easy	1	1	1	1	1	4	1	1	1	1	1	4
						Significance	#N/A						#N/A					
Impact 13:	Environment - emissions to earth	Causes - Batteries / equipment reached end of life and may leak. Consequences - Environment damage from heavy metal ions.	De-commission	Negative	End of Life shutdown procedure including a Risk Assessment of the specific activities involved. Where possible re-purpose the solid-state batteries / containers and equipment with associated environmental impact considered. Disposal according to local regulations and other directives such as the European Batteries Directive. End of life, which is affected by temperature and time, cycles etc, should be predefined and the monitoring should be in place to determine if it has been reached.	Complex	4	3	3	5	4	60	4	3	3	5	2	30
						Significance	N3 - Moderate						N2 - Low					
Impact 14:	Environment - waste of resources e.g., water, power etc	Similar to the construction and operational phases - no new hazards.	De-commission	Negative	As per construction and operational phases.	Easy	1	1	1	1	1	4	1	1	1	1	1	4
						Significance	#N/A						#N/A					
Impact 15:	Public - Aesthetics	Similar to the construction and	De-commission	Negative	As per construction and operational phases.	Easy	1	1	1	1	1	4	1	1	1	1	1	4

Impact number	Receptor	Description	Stage	Character	Preventative and Mitigative Measures	Ease of Mitigation	(M+	E+	R+	D)x	P=	S	(M+	E+	R+	D)x	P=	S
		operational phases - no new hazards.					Raw Risk						Residual Risk					
						Significance	#N/A						#N/A					
Impact 16:	Investors - Financial	Similar to the construction and operational phases - no new hazards.	De-commission	Negative	As per construction and operational phases.	Easy	1	1	1	1	1	4	1	1	1	1	1	4
						Significance	#N/A						#N/A					
Impact 17:	Employees and investors - Security	Similar to the construction and operational phases - no new hazards.	De-commission	Negative	As per construction and operational phases.	Easy	1	1	1	1	1	4	1	1	1	1	1	4
						Significance	#N/A						#N/A					
Impact 18:	Emergencies	Similar to the construction and operational phases - no new hazards.	De-commission	Negative	As per construction and operational phases.	Easy	1	1	1	1	1	4	1	1	1	1	1	4
						Significance	#N/A						#N/A					
Impact 19:	Investors - Legal	Disposal of hazardous "waste" is rife with difficulties and numerous regulations that need to be complied with.	De-commission	Negative	Applicants should seek the opinion from a waste consultant on how to correctly dispose of hazardous waste.	Complex	3	1	3	3	4	40	3	1	3	3	3	30
						Significance	N3 - Moderate						N2 - Low					

The above Risk Assessment shows that, provided the preventative and mitigative measures are incorporated, the de-commissioning phase of the project does not present any high risks nor any fatal flaws.

4.2 VANADIUM REDOX FLOW BATTERY ENERGY STORAGE SYSTEMS

TABLE 4.2.1 - CONSTRUCTION PHASE (Excluding commissioning)

Impact number	Receptor	Description	Stage	Character	Preventative and Mitigative Measures	Ease of Mitigation	(M+	E+	R+	D)x	P=	S	(M+	E+	R+	D)x	P=	S
							Raw Risk						Residual Risk					
Impact 1:	Human Health - chronic exposure to toxic chemical or biological agents	Causes - Construction materials such as cement, paints, solvents, welding fumes, truck fumes etc. Consequences - Employee / contractor illness.	Construction	Negative	The construction phase will be managed according to all the requirements of the Occupational Health and Safety Act 85 of 1993 specifically the Construction Regulations. SHEQ policy in place. A detailed construction Risk Assessment prior to work. SHE procedure in place. PPE to be specified. SHE appointees in place. Contractor's safety files in place and up to date. All necessary health controls/ practices to be in place, e.g., ventilation of welding and painting areas. SHE monitoring and reporting programs in place. Emergency response plan to be in place prior to beginning construction and to include aspects such as appointment of emergency controller, provision of first aid, first responder contact numbers.	Moderate		1	3	4	4	44	1	1	3	4	2	18
							Significance						N3 - Moderate			N2 - Low		
Impact 2:	Human Health - exposure to noise	Causes - Drilling, piling, generators, air compressors. Consequences - Adverse impact on hearing of workers. Possible nuisance factor in near-by areas.	Construction	Negative	Health Risk Assessment to determine if equipment noise exceeds 85dB at workstation and 61dB at boundary of the site. OHS Act Noise Induced hearing Loss Regulations. Employees to be provided with hearing protection if working near equipment that exceeds the noise limits.	Easy	3	1	5	5	4	56	2	1	5	5	2	26
							Significance						N3 - Moderate			N2 - Low		

Impact number	Receptor	Description	Stage	Character	Preventative and Mitigative Measures	Ease of Mitigation	(M+	E+	R+	D)x	P=	S	(M+	E+	R+	D)x	P=	S
							Raw Risk						Residual Risk					
Impact 3:	Human Health - exposure to temperature extremes and/or humidity	Causes - Heat during the day. Cold in winter. Consequence - Heat stroke. Hypothermia.	Construction	Negative	Construction site facilities to comply with Occupational Health and Safety Act 85 of 1993 specifically the thermal, humidity, lighting and ventilation requirements of the Environmental Regulations for Workplaces. Adequate potable water to be provided during all phases of the project. Bore hole, bowser and tank or small water treatment plant may be required to provide potable water for the employees during all phases of the project.	Easy	3	2	3	1	2	18	2	2	3	1	1	8
							Significance						N2 - Low					
Impact 4:	Human Health - exposure to psychological stress	Causes - Large projects bring many contractor workers into a small, isolated community. Consequences – Lack of sufficient accommodation, entertainment etc. Increase in alcohol abuse, violence	Construction	Negative	Refer to Social Specialist Studies for this project.	Easy	2	3	3	2	2	20	2	3	3	2	2	20
							Significance						N1 - Very Low					
Impact 5:	Human Health - exposure to ergonomic stress	Causes - Lifting heavy equipment. Awkward angles during construction. Consequences - Back and other injuries.	Construction	Negative	Training in lifting techniques. Ensure that despite the isolated location all the necessary equipment is available (and well maintained) during construction. Otherwise employees may revert to unsafe practices. Isolated location, maintenance of construction equipment to ensure safe operation is critical. Utilization of local service providers where possible. Ensure this is in place prior to project beginning. First aid provision on site.	Moderate	4	1	3	2	3	30	4	1	3	2	2	20
							Significance						N2 - Low					

Impact number	Receptor	Description	Stage	Character	Preventative and Mitigative Measures	Ease of Mitigation	(M+	E+	R+	D)x	P=	S	(M+	E+	R+	D)x	P=	S
							Raw Risk						Residual Risk					
Impact 6:	Human and Equipment Safety - exposure to fire radiation	Causes – Involvement in an external fire. Fire involving fuels used in construction vehicles or vehicles themselves (e.g., tyre fire). Fire due to uncontrolled welding or other hot-work Consequences - Injuries due to radiation especially amongst first responders and bystanders. Fatalities unlikely from the heat radiation as not highly flammable nor massive fire.	Construction	Negative	Fuels stored on site in dedicated, demarcated and bunded areas. Suitable fire-fighting equipment on site near source of fuel, e.g., diesel tank, generators, mess, workshops etc. The company responsible for the facility at this stage is to have: 1. Emergency plan to be in place prior to commencement of construction. 2. Fuel spill containment procedures and equipment to be in place. 3. Hot-work permit and management system to be in place.	Complex	4	2	3	5	4	56	4	2	3	5	2	28
							Significance						N3 - Moderate					
Impact 7:	Human and Equipment Safety - exposure to explosion over pressures	No credible causes	Construction	Negative	No credible causes, hence no mitigation necessary.	N/A	1	1	1	1	1	4	1	1	1	1	1	4
						Significance	#N/A						#N/A					

Impact number	Receptor	Description	Stage	Character	Preventative and Mitigative Measures	Ease of Mitigation	(M+	E+	R+	D)x	P=	S	(M+	E+	R+	D)x	P=	S
							Raw Risk						Residual Risk					
Impact 8a:	Human and Equipment Safety - exposure to acute toxic chemical and biological agents	Causes Human pathogens and diseases, sewage, food waste. Snakes, insects, wild and domesticated animals and harmful plants. Consequences - Illness and at worst without mitigation, possibly extending to fatalities. Effects can vary from discomfort to fatalities for venomous snakes or bee swarms etc	Construction	Negative	<p>All necessary good hygiene practices to be in place, e.g., provision of toilets, eating areas, infectious disease controls.</p> <p>Policies and practice for dealing with known vectors of disease such as Aids, TB, COVID 19 and others.</p> <p>Awareness training for persons on site, safety induction to include animal hazards.</p> <p>First aid and emergency response to consider the necessary anti-venom, anti-histamines, topical medicines etc.</p> <p>Due to isolated locations some distance from town, ensure the ability to treat with anti-venom and extreme allergic reactions on site.</p>	Complex	4	2	3	2	3	33	3	2	3	2	2	20
							Significance						N3 - Moderate					

Impact number	Receptor	Description	Stage	Character	Preventative and Mitigative Measures	Ease of Mitigation	(M+	E+	R+	D)x	P=	S	(M+	E+	R+	D)x	P=	S
							Raw Risk						Residual Risk					
Impact 9:	Human and Equipment Safety - exposure to violent release of kinetic or potential energy	Causes - Construction moving equipment, heavy loaded, elevated loads, working at heights Consequences - Injury or possibly fatality. Damage to equipment. Delays in starting the project, financial losses	Construction	Negative	<p>The construction phase will be managed according to all the requirements of the Occupational Health and Safety Act 85 of 1993 specifically the Construction Regulations. SHEQ policy in place. A detailed construction Risk Assessment prior to work. SHE procedure in place. PPE to be specified. SHE appointees in place. Contractors safety files in place and up to date. SHE monitoring and reporting programs in place. Standard construction site rules regarding traffic, reversing sirens, rigging controls, cordoning off excavations etc. Civil and building structures to National Building Regulations and building Standards Act 103 of 1977 SANS 10400 and other relevant codes. Other constructions such as roads, sewers etc also to relevant SANS standards. All normal procedures for working at heights, hot work permits, confined space entry, cordon off excavations etc to be in place before construction begins. Emergency response plan to be in place before construction begins.</p>	Complex	5	1	5	5	4	64	5	1	5	5	1	16
							N4 - High						N2 - Low					
Impact 10:	Human and Equipment Safety - exposure to electromagnetic waves	Causes - Use of electrical machines, generators etc. Hot dry area static generation is highly likely. Lightning strike. Consequences - Electrocutation. Ignition and burns. Injury and death. Damage electrical equipment.	Construction	Negative	<p>Standard maintenance of condition of electrical equipment and safe operating instructions. Ability to shut off power to systems in use on site. If persons are decanting fuels or dealing with other highly flammable materials care should be taken regarding possible static discharge, installations to be suitably designed and maintained. Lightning strike rate in the study area is high. Outside work must be stopped during thunderstorms.</p>	Complex	5	2	5	5	3	51	5	2	5	5	1	17

Impact number	Receptor	Description	Stage	Character	Preventative and Mitigative Measures	Ease of Mitigation	Raw Risk						Residual Risk							
							(M+	E+	R+	D)x	P=	S	(M+	E+	R+	D)x	P=	S		
					Lighting conductors may be required for the final installation, to be confirmed during design phase.															
Significance						N3 - Moderate						N2 - Low								
Impact 11:	Environment - emissions to air	Causes - Dust from construction and generally hot dry area. Consequences - Adverse impact on employee health.	Construction	Negative	May need to use dampening on roads etc. as per normal construction practices. May need PPE (dust masks) for specific construction workers.	Easy	3	2	1	1	4	28	2	2	1	1	2	12		
Significance						N2 - Low						N1 - Very Low								
Impact 12:	Environment - emissions to water	Causes - Diesel for equipment, paints and solvents. Transformer oil spills. Sewage and kitchen/mess area wastewater. Consequences - Environmental damage, particularly to the surface and underground water in the area.	Construction	Negative	Normal construction site practices for preventing and containing fuels/paint/oil etc spills. Bunding under any temporary tanks, curbing under truck offloading areas and sealed surfaces (e.g., concrete) under truck parking area is particularly important. Spill clean-up procedures to be in place before commencing construction. Sewage and any kitchen liquids - containment and suitable treatment/disposal	Moderate	2	2	3	2	3	27	2	2	3	2	2	18		
Significance						N2 - Low						N2 - Low								

Impact number	Receptor	Description	Stage	Character	Preventative and Mitigative Measures	Ease of Mitigation	(M+	E+	R+	D)x	P=	S	(M+	E+	R+	D)x	P=	S
							Raw Risk						Residual Risk					
Impact 13:	Environment - emissions to earth	Causes - Mess area and other solid waste. Consequences - Environmental damage.	Construction	Negative	There will be packaging materials that will need to be disposed of after the entire system is connected and commissioned as well as after regular maintenance. There will need to be waste segregation (e.g., electronic equipment, chemicals) and management on the site.	Easy	2	2	3	3	3	30	1	2	3	3	2	18
Significance						N2 - Low						N2 - Low						
Impact 14:	Environment - waste of resources e.g., water, power etc	Causes - Water usage not controlled. Battery equipment damaged. Consequences - Delays.	Construction	Negative	Water usage to be monitored on site during construction. Handling protocols to be provided by battery supplier. Water management plan and spill containment plans to be in place.	Easy	1	1	1	2	4	20	1	1	1	2	2	10
Significance						N2 - Low						N1 - Very Low						
Impact 15:	Public - Aesthetics	Causes - Bright surfaces reflecting light. Tall structures in a flat area. Consequences - Irritation.	Construction	Negative	Visual impact assessment to include BESS installation when design details become available. Confirm any height limitations for VRFB BESS building (if utility scale)	Moderate	3	2	3	4	4	48	1	2	3	4	2	20
Significance						N3 - Moderate						N2 - Low						
Impact 16:	Investors - Financial	Causes - Defective technology. Extreme project delays. Consequences - Financial loss	Construction	Negative	Design by experienced contractors using internationally recognized and proven technology. Project management with deviation monitoring.	Moderate	5	1	3	4	3	39	3	1	3	4	2	22
Significance						N3 - Moderate						N2 - Low						
Impact 17:	Employees and investors - Security	Causes - On route, potential hi-jacking of valuable but hazardous load. On site, theft of construction equipment and battery installation facilities.	Construction	Negative	Fencing around electrical infrastructure to SANS standard and Eskom Guidelines. The hazardous nature of the electrical and battery equipment should be clearly indicated – e.g., Skull and Cross Bones or other signs. Isolated location both helps and hinders security.	Complex	4	1	3	2	4	40	3	1	3	2	3	27

Impact number	Receptor	Description	Stage	Character	Preventative and Mitigative Measures	Ease of Mitigation	(M+	E+	R+	D)x	P=	S	(M+	E+	R+	D)x	P=	S
							Raw Risk						Residual Risk					
		Civil unrest or violent strike by employees. Consequences - Theft. Injury to burglars. Damage to equipment possibly setting off thermal runaway.			Night lighting to be provided both indoors and outdoors where necessary.													
						Significance	N3 - Moderate						N2 - Low					
Impact 18:	Emergencies	Causes - Fires, explosions, toxic smoke, large spills, traffic accidents, equipment/structural collapse. Inadequate emergency response to small event leads to escalation. Consequences - Injuries turn to fatalities, small losses become extended down time.	Construction	Negative	Emergency procedures need to be practiced prior to commencement of construction.	Complex	4	2	3	4	3	39	4	2	3	4	2	26
						Significance	N3 - Moderate						N2 - Low					
Impact 19:	Investors - Legal	Causes Battery field is evolving quickly with new guides, codes and regulations happening at the same time as evolving technology. Consequences -	Construction	Negative	Use only internationally reputable battery suppliers who comply with all known regulations/guideline at the time of purchasing. Ensure only state of the art battery systems are used and not old technologies prone to fires/explosions etc.	Moderate	3	1	3	3	4	40	2	1	3	3	2	18

Impact number	Receptor	Description	Stage	Character	Preventative and Mitigative Measures	Ease of Mitigation	(M+	E+	R+	D)x	P=	S	(M+	E+	R+	D)x	P=	S
							Raw Risk						Residual Risk					
		Unknown hazards manifest due to using "cheaper supplier or less developed technology".																
						Significance	N3 - Moderate						N2 - Low					

The above Risk Assessment shows that provided the preventative and mitigative measures are incorporated, the construction phase of the project does not present any high risks nor any fatal flaws.

TABLE 4.2.2 - OPERATIONAL PHASE (Including Commissioning)

From the details of accidents that have happened both with BESS installations and chemical plants in general, it is clear that many potential problems manifest during the commissioning phase when units are first powered up to test functionality. This phase is critical and all controls, procedures, mitigation measures etc that would be in place for full operation should be in place before commissioning commences.

Impact number	Receptor	Description	Stage	Character	Preventative and Mitigative Measures	Ease of Mitigation	Raw Risk						Residual Risk					
							(M+)	E+	R+	D)x	P=	S	(M+)	E+	R+	D)x	P=	S
Impact 1a:	Human Health - chronic exposure to toxic chemical or biological agents	<p>Causes - Operation and maintenance materials spare parts, paints, solvents, welding fumes, transformers oils, lubricating oils and greases etc.</p> <p>Consequences - Occupational illness.</p>	Operation	Negative	<p>The operation and maintenance phase will be managed according to all the requirements of the Occupational Health and Safety Act 85 of 1993. SHEQ policy in place.</p> <p>A detailed Risk Assessment of all normal operating and maintenance activities on site to be compiled, and form the basis of operating instructions, prior to commencing commissioning.</p> <p>SHE procedure in place, e.g., PPE specified, management of change, integrity monitoring. SHE appointees in place.</p> <p>Training of staff in general hazards on site.</p> <p>All necessary health controls/ practices to be in place, e.g., ventilation of confined areas, occupational health monitoring if required and reporting programs in place.</p> <p>Emergency response plan for full operation and maintenance phase to be in place prior to beginning commissioning and to include aspects such as:</p> <ul style="list-style-type: none"> - appointment of emergency controller, - emergency isolation systems for electricity, - emergency isolation and containment systems for electrolyte, - provision of PPE for hazardous materials response, - provision of emergency facilities for staff at the main office building, - provision of first aid facilities, - first responder contact numbers etc. 	Easy	2	1	3	4	5	50	1	1	3	4	2	18
							Significance						N3 - Moderate					

Impact number	Receptor	Description	Stage	Character	Preventative and Mitigative Measures	Ease of Mitigation	(M+	E+	R+	D)x	P=	S	(M+	E+	R+	D)x	P=	S
						Raw Risk						Residual Risk						
Impact 1b:	Human Health - chronic exposure to toxic chemical or biological agents	Causes - Compromised battery compartments vapours accumulate in the containers, solids/liquids on surfaces. Maintenance of battery components, corrosive and mildly toxic liquid on surfaces. Consequences - Dermatitis, skin /eye/lung irritation.	Operation	Negative	<p>VRFB Batteries facilities normally within buildings but may be containerized.</p> <p>Maintenance procedures will be in place should equipment need to be opened, e.g., pumps drained and decontaminated prior to repair in workshop etc. PPE will be specified for handling battery parts and other equipment on site.</p> <p>Training of staff in hazards of chemicals on site.</p> <p>Labelling of all equipment.</p> <p>Confined space entry procedures if entering tanks. Safety Data Sheets (SDSs) to be available on site. Operating manuals to be provided including start-up, shut-down, steady state, monitoring requirements.</p> <p>Maintenance manuals with make safe, decontamination and repair procedures.</p> <p>Proposed maintenance schedules e.g., checklists for weekly, monthly, annual etc.</p> <p>Provided portable equipment for calibration and for testing/verification of defective equipment, e.g., volt/current meters, infrared camera</p>	Complex	2	1	3	5	4	44	1	1	3	5	2	20
						Significance	N3 - Moderate						N2 - Low					
Impact 2:	Human Health - exposure to noise	Causes - Moving parts inside containers, buildings, pumps, compressors, cooling systems etc. Consequences - Adverse impact on hearing of workers. Nuisance factor at near -by residences or other activities.	Operation	Negative	<p>Design to ensure continuous noise does not exceed 85dB within the facilities or at any other location on site or 61 dB at the site boundary, e.g., emergency generator, air compressor etc. OHS Act Noise Induced hearing Loss Regulations.</p> <p>Employees to be provided with hearing protection if working near equipment that exceeds the noise limits.</p>	Easy	2	1	5	5	4	52	2	1	5	5	2	26
						Significance	N3 - Moderate						N2 - Low					

Impact number	Receptor	Description	Stage	Character	Preventative and Mitigative Measures	Ease of Mitigation	(M+	E+	R+	D)x	P=	S	(M+	E+	R+	D)x	P=	S
							Raw Risk						Residual Risk					
Impact 3:	Human Health - exposure to temperature extremes and/or humidity	Causes - Heat during the day. Batteries generate heat within enclosed building / containers. Cold in winter. Night work requires lighting. Consequences - Heat stroke. Hypothermia.	Operation	Negative	Building and container facilities to comply with Occupational Health and Safety Act 85 of 1993 specifically the thermal, humidity, lighting and ventilation requirements of the Environmental Regulations for Workplaces. Night work is likely for VRFB. Suitable lighting to be provided including emergency lighting for safe building exit in the event of power failure. PPE for operations and maintenance staff to be suitable for the weather conditions. Adequate potable water to be provided during all phases of the project. PPE for operations and maintenance staff to be suitable for the weather conditions.	Easy	4	2	3	1	2	20	3	2	3	1	1	9
Significance						N2 - Low						N1 - Very Low						
Impact 4:	Human Health - exposure to psychological stress	Causes - Isolated workstation and monotonous repetitive work. Consequences - Low performance, system productivity suffers.	Operation	Negative	Staff rotation to other activities within the site may be necessary. Performance monitoring of inspections / maintenance tasks in particular will be necessary.	Easy	2	3	3	2	2	20	1	3	3	2	1	9
Significance						N2 - Low						N1 - Very Low						
Impact 5:	Human Health - exposure to ergonomic stress	Causes - Lifting heavy equipment. Awkward angles during maintenance, stretching reaching to high level and bending to low level. Working ta height if equipment located on top of electrolyte tanks, roofs or elevated electrical equipment (e.g., pylons). Consequences - Back and other injuries.	Operation	Negative	Training in lifting techniques. Training in working at heights. If equipment is at height (see OHS Act General Safety Regulation 6), ensure suitable safe (electrically and physically) ladders / harnesses etc. are available. Working at height procedure to be in place.	Easy	5	1	3	2	3	33	4	1	3	2	2	20

Impact number	Receptor	Description	Stage	Character	Preventative and Mitigative Measures	Ease of Mitigation	Raw Risk						Residual Risk					
							(M+	E+	R+	D)x	P=	S	(M+	E+	R+	D)x	P=	S
							Significance N3 - Moderate						N2 - Low					
Impact 6a:	Human and Equipment Safety - exposure to fire radiation	<p>Causes – Involvement in an external fire e.g., veld fire, maintenance vehicle fire, electrical systems fire.</p> <p>Manufacturing defects or damage to battery leading to shorting and heating.</p> <p>High humidity condensation of water or ingress of water or flooding leading to shorting.</p> <p>Dust accumulation on electrical parts leading to overheating.</p> <p>Excessive electrical loads - surges</p> <p>Operator abuse</p> <p>BMS failure or software failure.</p> <p>Incorrect extinguishing medium, escalate the fire.</p> <p>Consequences - Contaminated run off. Radiation burns. No affected bystanders. Damaged equipment. Fire spreads to other units or offsite if grass/vegetation not controlled.</p>	Operation	Negative	<p>Grass cutting and fire breaks around the BESS installations.</p> <p>No combustible materials to be stored in or near the batteries or electrical infrastructure, e.g., separation of site diesel tank. Fire resistant barrier between the batteries and the PCS side if in the same container. Design codes from USA and standards of practice UL9540, NFPA 855 and DNV GL RP 43. Detailed FMEA/Hazop/Bowtie to done during design at the component level and system levels.</p> <p>Safety integrity level rating of equipment (failure probably) with suitable redundancy if required. Site Acceptance Testing as part of commissioning of each unit and the overall system. BMS should be checking individual cell voltage as well as stack, module, container, system voltages/current etc. BMS tripping the cell and possibly the stack/ building unit or module/rack/container, if variations in voltage. Diagnostics easily accessible. Diagnostics able to distinguish cell from stack or cell from module faults. As per SANS Standards, suitable ingress protection (IP) level provided for electrical equipment, e.g., IP55 - 66. If air cooling into container / building, suitable dust filters to be provided if needed. Smoke detectors may be needed linked to BMS and alerts in the main control room.</p> <p>Effects of battery aging to be considered. Temperature monitoring, regular infrared scanning. Data stored for trend analysis.</p> <p>Protective systems functionality testing.</p> <p>Prior to commencement of cold commissioning, emergency plan from transport and construction phase to extended to operational phase and to include the hazards of the electrically live system. Procedure to address suitable extinguishing media, ventilating, entering container as appropriate or not. PPE for firefighting may need to include fire retardant, chemically resistant, nitrile gloves, antistatic acid resistant boots, fill face shields, BA sets. A planned fire response to prevent escalation to an environmental event is critical. Suitable fire extinguishing medium, cooling medium and adequate supply of both is critical e.g., cooling adjacent equipment and can use fogging nozzles to direct smoke. Ensure procedures in place to clean up after event Lingering toxic residues in the soil and on adjacent structures.</p>	Complex	5	1	5	5	3	48	5	1	5	5	1	16

Impact number	Receptor	Description	Stage	Character	Preventative and Mitigative Measures	Ease of Mitigation	(M+	E+	R+	D)x	P=	S	(M+	E+	R+	D)x	P=	S
							Raw Risk						Residual Risk					
						Significance	N3 - Moderate						N2 - Low					
Impact 6b:	Human and Equipment Safety - exposure to fire radiation	Causes - Power Conversion System (PCS – DC to AC) cooling failure electrical fire. Consequences - Fire starts in PCS or another section or room and spreads to battery area.	Operation	Negative	VRFB building systems PCS in another area separating it from the batteries and other equipment	Moderate	5	2	5	5	3	51	5	2	5	5	1	17
						Significance	N3 - Moderate						N2 - Low					
Impact 7:	Human and Equipment Safety - exposure to explosion over pressures	Transformer shorting / overheating / explosion. Consequences - Potential fatalities, e.g., amongst first responders. Damage to nearby equipment.	Operation	Negative	Electrical equipment will be specified to suit application. Emergency response plan and employee training referred to above is to be in place.	Moderate	5	1	5	5	2	32	5	1	5	5	1	16
						Significance	N3 - Moderate						N2 - Low					

Impact number	Receptor	Description	Stage	Character	Preventative and Mitigative Measures	Ease of Mitigation	Raw Risk						Residual Risk					
							(M+)	E+	R+	(D)x	P=	S	(M+)	E+	R+	(D)x	P=	S
Impact 8a:	Human and Equipment Safety - exposure to acute toxic chemical and biological agents	Causes Human pathogens and diseases, sewage, food waste. Snakes, insects, wild and domesticated animals and harmful plants. Consequences - Illness and at worst without mitigation, possibly extending to fatalities. Effects can vary from discomfort to fatalities for venomous snakes or bee swarms etc	Operation	Negative	All necessary good hygiene practices to be in place, e.g., provision of toilets, eating areas, infectious disease controls. Policies and practice for dealing with known vectors of disease such as Aids, TB, COVID 19 and others. Awareness training for persons on site, safety induction to include animal hazards. First aid and emergency response to consider the necessary anti-venom, anti-histamines, topical medicines etc. Due to isolated locations some distance from town, ensure the ability to treat with anti-venom and extreme allergic reactions on site.	Moderate	4	1	3	2	3	30	3	1	2	2	2	16
							Significance						N2 - Low			N2 - Low		
Impact 8b:	Human and Equipment Safety - exposure to acute toxic chemical and biological agents	Causes - Damaged batteries components, leak electrolyte, are completely broken exposing hazardous chemicals. Consequences - Impacts can vary from mild skin irritation from exposure to small leaks to serious corrosive burns for large exposure.	Operation	Negative	Corrosion resistant PPE (e.g., overalls, gloves, eyeglasses) to be specified for all operations in electrolyte areas. PPE to be increased (e.g., full-face shield, aprons, chemical suits) for operations that involve opening equipment and potential exposure, e.g., sampling, maintenance. All operators/maintenance staff trained in the hazards of chemicals on site. Electrolyte contained, modules contained inside a building that is banded. 24/7 helpline response. Standard dangerous goods requirements for Hazmat labels. All operators/maintenance staff trained in the hazards.	Moderate	4	3	3	5	3	45	3	3	3	5	2	28
							Significance						N3 - Moderate			N2 - Low		

Impact number	Receptor	Description	Stage	Character	Preventative and Mitigative Measures	Ease of Mitigation	Raw Risk						Residual Risk					
							(M+	E+	R+	D)x	P=	S	(M+	E+	R+	D)x	P=	S
Impact 9:	Human and Equipment Safety - exposure to violent release of kinetic or potential energy	Causes - Moving equipment, pumps, heavy equipment at elevation, nip points, working at heights. Traffic accidents. Earthquake / tremor. Consequences - Injury. Fatality in unlikely worst case, e.g., traffic accidents or fall from heights. Damage to equipment, spills, environment pollution	Operation	Negative	<p>Apart from pumps, no major moving parts during operation.</p> <p>Maintenance equipment to be serviced and personnel suitably trained in the use thereof. Normally just small vehicles on site, bakkies, grass cutting, cherry-pickers etc. Possibly large cranes if large equipment or elevated structure removed/replaced.</p> <p>Traffic signs, rules etc in place on site. All normal working at heights, hot work permits, confined space entry, cordon off unsafe areas/works etc to be in place. Emergency response plan.</p> <p>Civil design to take seismic activity into account.</p>	Moderate	5	1	5	5	3	48	5	1	5	5	1	16
							N3 - Moderate						N2 - Low					

Impact number	Receptor	Description	Stage	Character	Preventative and Mitigative Measures	Ease of Mitigation	Raw Risk						Residual Risk					
							(M+	E+	R+	D)x	P=	S	(M+	E+	R+	D)x	P=	S
Impact 10:	Human and Equipment Safety - exposure to electromagnetic waves	Causes - Use of electrical machines, generators etc. Hot dry area static generation is highly likely. Lightning strike. Consequences - Electrocution. Ignition and burns. Injury and death. Damage electrical equipment.	Operation	Negative	<p>Codes and guidelines for electrical insulation. PPE to suit. Low voltage equipment (e.g., batteries) separated from high voltage (e.g., transmission to grid). Ensure trained personnel and refer to guideline – IEE 1657 – 2018. Ensure compliance with Eskom Operating Regulations for high voltage systems including access control, permit to work, safe work procedures, live work, abnormal and emergency situations, keeping records. Electromagnetic fields, impact on other equipment e.g., testing devices, mobile phones – malfunction, permanent damage. Software also need to be kept as update to date as reasonably practicable. Consider suitably located Emergency stop buttons for the facility and the other equipment on site. PPE to consider static accumulation for entering the facilities, and particularly the battery containers especially after a high temperature shut down where there could possibly be flammable materials. The procedures for responding to alarm and auto shut down on containers, needs to consider that there may be a dangerous environment inside and how to protect personnel who may enter to respond.</p> <p>Lightning strike rate in proposed development area is high. All outside work must be stopped during thunder storms. Lighting conductors may be required for the installation, to be confirmed during design</p>	Complex	5	2	5	5	3	51	5	2	5	5	1	17
Impact 11:	Environment - emissions to air	Not expected on a normal basis. Refrigerant may be an asphyxiant if accidentally released indoors it can	Operation	Negative	Especially after any warning alarms have gone off, but possibly even normally the container could be treated as entering a confined space and similar procedures could be in place, e.g., do not enter alone, gas testing prior to entering, ensure adequate ventilation	Easy	3	1	1	1	3	18	3	1	1	1	1	6

Impact number	Receptor	Description	Stage	Character	Preventative and Mitigative Measures	Ease of Mitigation	(M+	E+	R+	D)x	P=	S	(M+	E+	R+	D)x	P=	S
							Raw Risk						Residual Risk					
		accumulate and displace oxygen.																
						Significance	N2 - Low						N1 - Very Low					
Impact 12:	Environment - emissions to water	<p>Causes - Cooling water blow-down. Laboratory waste (if included in the design). Maintenance waste, e.g., oils. Spills from batteries, coolant system, diesel trucks, transformers. Parked vehicles – oil drips. Fire water runoff control. Kitchen waste and sewage. Refrigerant release. VRFB electrolyte purging.</p> <p>Consequences - Pollution if not contained. Excessive disposal costs if emissions not limited.</p>	Operation	Negative	<p>Electrolyte areas fully bunded to 110% of largest tank, or more.</p> <p>Bunding under any outdoors tanks, curbing under truck offloading areas and sealed surfaces (e.g., concrete) under truck parking area is particularly important.</p> <p>Sewage and any kitchen liquids - containment and suitable treatment/disposal.</p> <p>Procedures for dealing with damaged/leaking equipment as well as clean-up of spills.</p> <p>Normal site practices for preventing and containing diesel/paint etc spills.</p> <p>Waste management plan to be in place e.g., liquid waste treatment or suitable removal and disposal will be provided.</p> <p>Spill clean-up procedures to be in place before bringing container on site, including spill kits – non-combustible materials, hazmat disposal.</p> <p>The National Environment Management Act (NEMA) has a list of substances with Reportable spill Quantities, ensure compliance with this.</p> <p>Process controls in place to prevent contamination and deterioration of electrolyte leading to excessive purging.</p> <p>Ensure proposed locations of the BESS facilities are a suitable distance from the closest water course. In the event of a major spill if this is too close it may not allow time for mitigation to be taken. Adequate secondary and possibly tertiary containment systems may then be needed on site.</p>	Moderate	3	2	3	2	3	30	3	2	3	2	2	20
						Significance	N2 - Low						N2 - Low					

Impact number	Receptor	Description	Stage	Character	Preventative and Mitigative Measures	Ease of Mitigation	(M+	E+	R+	D)x	P=	S	(M+	E+	R+	D)x	P=	S
							Raw Risk						Residual Risk					
Impact 13:	Environment - emissions to earth	Causes - Mess area and other solid waste. Disposal of battery components. Consequences - Environmental damage.	Operation	Negative	Implement waste segregation (e.g., electronic equipment, chemicals, domestic) and management on the site.	Easy	2	2	3	3	3	30	2	2	3	3	1	10
						Significance	N2 - Low						N1 - Very Low					
Impact 14:	Environment - waste of resources e.g., water, power etc	Causes - Similar to construction phase. Disposal of batteries or components. Disposal of containers. Water usage not controlled. Excessive purging of deteriorated or contaminated electrolyte. Consequences - Delays. Excessive costs and disposal of large volumes of hazardous waste.	Operation	Negative	Water usage to be monitored on site. Handling protocols to be provided by supplier of electrolyte. Water management plan and spill containment plans to be in place. Investigate End of Life plan for electrolyte - reuse / recovery / reconditioning. Similarly, for decommissioned containers / equipment – reuse / recovery / repurpose	Easy	2	1	1	2	4	24	2	1	1	2	2	12
							N2 - Low						N1 - Very Low					
Impact 15:	Public - Aesthetics	Causes - Bright surfaces reflecting light. Tall structures in a flat area. Consequences - Irritation.	Construction	Negative	Visual impact assessment to include BESS installation when design details become available. Confirm any height limitations for VRFB BESS building (if utility scale)	Moderate	3	2	3	4	4	48	1	2	3	4	2	20
						Significance	N3 - Moderate						N2 - Low					

Impact number	Receptor	Description	Stage	Character	Preventative and Mitigative Measures	Ease of Mitigation	(M+	E+	R+	D)x	P=	S	(M+	E+	R+	D)x	P=	S
							Raw Risk						Residual Risk					
Impact 16:	Investors - Financial	Causes - Defective technology. Extreme project delays. Consequences - Financial loss	Operation	Negative	Design by experienced contractors using internationally recognized and proven technology. Project management with deviation monitoring.	Easy	5	1	3	4	3	39	3	1	3	4	2	22
						Significance	N3 - Moderate						N2 - Low					
Impact 17a:	Employees and investors - Security	Causes - On route, potential hi-jacking of valuable but hazardous load. On site, theft of construction equipment and battery installation facilities. Civil unrest or violent strike by employees. Consequences - Theft. Injury to burglars. Damage to equipment possibly setting off thermal runaway.	Operation	Negative	Fencing around electrical infrastructure to SANS standard and Eskom Guidelines. Consider motion detection lights and CCTV. The hazardous nature of the electrical and battery equipment should be clearly indicated – e.g., Skull and Cross Bones or other signs. Isolated location both helps and hinders security. Night lighting to be provided both indoors and outdoors where necessary.	Moderate	3	1	3	2	4	36	3	1	3	2	2	18
						Significance	N3 - Moderate						N2 - Low					
Impact 17b:	Employees and investors - Security	Causes - Cyber security attacks aimed at the National Electricity Grid. Consequences - Ransom of the National Electricity Grid.	Operation	Negative	Cyber security needs monitoring. Remote access to system needs to be negotiated and controlled. Password controls, levels of authority etc. Protection of the National Electricity Grid from Cyber-attacks accessing through the BESS. Cyber emergency procedures – should be in place prior to commissioning.	Complex	4	4	3	1	4	48	4	4	3	1	2	24
						Significance	N3 - Moderate						N2 - Low					

Impact number	Receptor	Description	Stage	Character	Preventative and Mitigative Measures	Ease of Mitigation	(M+	E+	R+	D)x	P=	S	(M+	E+	R+	D)x	P=	S
							Raw Risk						Residual Risk					
Impact 18:	Emergencies	Causes - Fires, explosions, toxic smoke, large spills, traffic accidents, equipment/structural collapse. Inadequate emergency response to small event leads to escalation. Consequences - Injuries turn to fatalities, small losses become extended down time.	Operation	Negative	Emergency procedures need to be practiced prior to commencement of operations. Escape doors should swing open outwards and not into the building/container. More than one exit from buildings.	Complex	4	2	3	4	3	39	4	2	3	4	2	26
							Significance						N3 - Moderate			N2 - Low		
Impact 19:	Investors - Legal	Causes Battery field is evolving quickly with new guides, codes and regulations happening at the same time as evolving technology. Consequences - Unknown hazards manifest due to using "cheaper supplier or less developed technology".	Operation	Negative	Use only internationally reputable battery suppliers who comply with all known regulations/guideline at the time of purchasing. Ensure only state of the art battery systems are used and not old technologies prone to fires/explosions etc.	Moderate	3	1	3	3	4	40	3	1	3	3	2	20
							Significance						N3 - Moderate			N2 - Low		

The above Risk Assessment shows that, provided the preventative and mitigative measures are incorporated, the operational phase of the project does not present any high risks nor any fatal flaws.

TABLE 4.2.3 - DECOMMISSIONING PHASE

Battery components may have a limited lifespan, there are damaged equipment, waste electrolyte etc. There could already be “waste” on the first day of commissioning and plans should be in place to deal with this. Ideally an End-of-Life plan needs to be in place before the first electrolyte / container / equipment is brought on site.

All decommissioning activities must comply with the relevant regulations at the time. Decommissioning will ultimately need to be informed by the regulatory requirements at the time, which may be different to present requirements. The impact rating are not possible to determine now given the uncertainties in mitigations applicable at that time, hence they have been left as neutral.

Impact number	Receptor	Description	Stage	Character	Preventative and Mitigative Measures	Ease of Mitigation	(M+)	E+	R+	(D)x	P=	S	(M+)	E+	R+	(D)x	P=	S
							Raw Risk						Residual Risk					
Impact 1:	Human Health - chronic exposure to toxic chemical or biological agents	Similar to the construction and operational phases - no new hazards.	De-commission	Negative	As per construction and operational phases.	Easy	1	1	1	1	1	4	1	1	1	1	1	4
							Significance						#N/A					
Impact 2:	Human Health - exposure to noise	Similar to the construction and operational phases - no new hazards.	De-commission	Negative	As per construction and operational phases.	Easy	1	1	1	1	1	4	1	1	1	1	1	4
							Significance						#N/A					
Impact 3:	Human Health - exposure to temperature extremes and/or humidity	Similar to the construction and operational phases - no new hazards.	De-commission	Negative	As per construction and operational phases.	Easy	1	1	1	1	1	4	1	1	1	1	1	4
							Significance						#N/A					
Impact 4:	Human Health - exposure to psychological stress	Similar to the construction and operational phases - no new hazards.	De-commission	Negative	As per construction and operational phases.	Easy	1	1	1	1	1	4	1	1	1	1	1	4
							Significance						#N/A					

Impact number	Receptor	Description	Stage	Character	Preventative and Mitigative Measures	Ease of Mitigation	(M+	E+	R+	D)x	P=	S	(M+	E+	R+	D)x	P=	S
							Raw Risk						Residual Risk					
Significance							#N/A						#N/A					
Impact 5:	Human Health - exposure to ergonomic stress	Similar to the construction and operational phases - no new hazards.	De-commission	Negative	As per construction and operational phases.	Easy	1	1	1	1	1	4	1	1	1	1	1	4
Significance							#N/A						#N/A					
Impact 6:	Human and Equipment Safety - exposure to fire radiation	Similar to the construction and operational phases - no new hazards.	De-commission	Negative	As per construction and operational phases.	Easy	1	1	1	1	1	4	1	1	1	1	1	4
Significance							#N/A						#N/A					
Impact 7:	Human and Equipment Safety - exposure to explosion over pressures	Similar to the construction and operational phases - no new hazards.	De-commission	Negative	As per construction and operational phases.	Easy	1	1	1	1	1	4	1	1	1	1	1	4
Significance							#N/A						#N/A					
Impact 8:	Human and Equipment Safety - exposure to acute toxic chemical and biological agents	Similar to the Construction and operational phases - no new hazards.	De-commission	Negative	As per construction and operational phases.	Easy	1	1	1	1	1	4	1	1	1	1	1	4
Significance							#N/A						#N/A					
Impact 9:	Human and Equipment Safety - exposure to violent release of kinetic or potential energy	Similar to the Construction and operational phases - no new hazards.	De-commission	Negative	As per construction and operational phases.	Easy	1	1	1	1	1	4	1	1	1	1	1	4
							#N/A						#N/A					

Impact number	Receptor	Description	Stage	Character	Preventative and Mitigative Measures	Ease of Mitigation	(M+	E+	R+	D)x	P=	S	(M+	E+	R+	D)x	P=	S
							Raw Risk						Residual Risk					
Impact 10:	Human and Equipment Safety - exposure to electromagnetic waves	Similar to the Construction and operational phases - no new hazards.	De-commission	Negative	As per construction and operational phases.	Easy	1	1	1	1	1	4	1	1	1	1	1	4
						Significance	#N/A						#N/A					
Impact 11:	Environment - emissions to air	Similar to the Construction and operational phases - no new hazards.	De-commission	Negative	As per construction and operational phases.	Easy	1	1	1	1	1	4	1	1	1	1	1	4
						Significance	#N/A						#N/A					
Impact 12:	Environment - emissions to water	Similar to the Construction and operational phases - no new hazards.	De-commission	Negative	As per construction and operational phases.	Easy	1	1	1	1	1	4	1	1	1	1	1	4
						Significance	#N/A						#N/A					
Impact 13:	Environment - emissions to earth	Causes - Batteries / electrolyte / equipment reached end of life and may leak. Consequences - Environment damage from heavy metal ions.	Construction	Negative	End of Life shutdown procedure including a Risk Assessment of the specific activities involved. Where possible re-purpose the solid-state batteries / containers and equipment with associated Environmental impact considered. Disposal according to local regulations and other directives such as the European Batteries Directive. End of life, which is affected by temperature and time, cycles etc, should be predefined and the monitoring should be in place to determine if it has been reached.	Complex	4	3	3	5	4	60	4	3	3	5	2	30
						Significance	N3 - Moderate						N2 - Low					
Impact 14:	Environment - waste of resources e.g., water, power etc	Similar to the Construction and operational phases - no new hazards.	De-commission	Negative	As per construction and operational phases.	Easy	1	1	1	1	1	4	1	1	1	1	1	4
						Significance	#N/A						#N/A					
Impact 15:	Public - Aesthetics	Similar to the Construction and	De-commission	Negative	As per construction and operational phases.	Easy	1	1	1	1	1	4	1	1	1	1	1	4

Impact number	Receptor	Description	Stage	Character	Preventative and Mitigative Measures	Ease of Mitigation	(M+	E+	R+	D)x	P=	S	(M+	E+	R+	D)x	P=	S
		operational phases - no new hazards.					Raw Risk						Residual Risk					
						Significance	#N/A						#N/A					
Impact 16:	Investors - Financial	Similar to the Construction and operational phases - no new hazards.	De-commission	Negative	As per construction and operational phases.	Easy	1	1	1	1	1	4	1	1	1	1	1	4
						Significance	#N/A						#N/A					
Impact 17:	Employees and investors - Security	Similar to the Construction and operational phases - no new hazards.	De-commission	Negative	As per construction and operational phases.	Easy	1	1	1	1	1	4	1	1	1	1	1	4
						Significance	#N/A						#N/A					
Impact 18:	Emergencies	Similar to the Construction and operational phases - no new hazards.	De-commission	Negative	As per construction and operational phases.	Easy	1	1	1	1	1	4	1	1	1	1	1	4
						Significance	#N/A						#N/A					
Impact 19:	Investors - Legal	Disposal of hazardous "waste" is rife with difficulties and numerous regulations that need to be complied with.	De-commission	Negative	Applicants should seek the opinion from a waste consultant on how to correctly dispose of hazardous waste.	Complex	3	1	3	3	4	40	3	1	3	3	3	30
						Significance	N3 - Moderate						N2 - Low					

The above Risk Assessment shows that, provided the preventative and mitigative measures are incorporated, the de-commissioning phase of the project does not present any high risks nor any fatal flaws.

5. CONCLUSIONS AND RECOMMENDATIONS

The tables in Section 4 contain all the recommended preventative and mitigative measures necessary to ensure risks are not unacceptably high.

Below are a few extracted items that are possibly of highest risks and therefore a priority.

5.1 CONCLUSIONS

GENERAL

- This Risk Assessment has found that with suitable preventative and mitigative measures in place, none of the identified potential risks are excessively high, i.e., from a Safety, Health and Environment (SHE) perspective no fatal flaws were found with either type of technology for the proposed BESS installation at the Roos Solar Energy Facility near Belfast, Mpumalanga.
- At a large facility, without installation of the state-of-the-art battery technology that includes protective features, there can be significant risks to employees and first responders. The latest battery designs include many preventative and mitigative measures to reduce these risks to tolerable levels. (Refer to tables in section 4 under preventative and mitigative measures). State-of-the-art technology should be used, i.e., not old technology that may have been prone to fire and explosion risks.
- The design should be subject to a full Hazard and Operability Study (HAZOP) prior to commencement of procurement. A HAZOP is a detailed technical systematic study that looks at the intricacies of the design, the control system, the emergency system etc. and how these may fail under abnormal operating conditions. Additional safeguards may be suggested by the team doing the study.

LITHIUM SOLID STATE CONTAINERIZED BATTERIES

- With lithium solid-state batteries, the most significant hazard with battery units is the possibility of thermal runaway and the generation of toxic and flammable gases. There have been numerous such incidents around the world with batteries at all scales and modern technology providers include many preventative and mitigative features in their designs. This type of event also generates heat which may possibly propagate the thermal runaway event to neighbouring batteries if suitable state of the art technology is not employed.
- The flammable gases generated may ignite leading to a fire which accelerates the runaway process and may spread the fire to other parts of the BESS or other equipment located near-by.
- If the flammable gases accumulate within the container before they ignite, they may eventually ignite with explosive force. This type of event is unusual but has happened with an older technology container installed at McMicken in the USA in 2019.
- Due to a variety of causes, thermal runaway could happen at any point during transport to the facility, during construction or operation / maintenance at the facility or during decommissioning and safe making for disposal.
- Due to the containerized approach as well as the usual good practice of separation between

containers, which should be applied on this project, and therefore the likely restriction of events to one container at a time, the main risks are close to the containers i.e., to transport drivers, employees at the facilities and first responders to incidents.

- In terms of a worst conceivable case container fires, the significant impact zone is likely to be limited to within 10m of the container and mild impacts to 20m. Based on the current proposed layout, impacts at the closest isolated farmhouses are not expected.
- In terms of a worst conceivable case explosion, the significant impact zone is likely to be limited to within 10m of the container and minor impacts such as debris within 50m. Based on the current proposed layout, impacts at the closest isolated farmhouses are not expected.
- In terms of a worst reasonably conceivable toxic smoke scenario, provided the units are placed suitably far apart to prevent propagation from one unit to another and large external fires are prevented, the amount of material burning should be limited to one container at any one time. In this case, beyond the immediate vicinity of the fire, the concentrations of harmful gases within the smoke should be low. Both the preferred and the alternative BESS installation locations are over 500m from any occupied development / farmhouse and therefore the risks posed by BESS are negligible.

VANADIUM REDOX FLOW BATTERY INSTALLATIONS

- The most significant hazard with VRF battery units is the possibility of spills of corrosive and environmentally toxic electrolyte. Many preventative and mitigative features will be included in the design and operation, e.g., full secondary containment, level control on tanks, leak detection on equipment etc. (Refer to tables in section 4 under preventative and mitigative measures).
- VRF batteries do not present significant fire and electrical arcing hazards provided they are correctly designed, operated, maintained and managed. Suitable Battery Management System (BMS), safety procedures, operating instructions, maintenance procedures, trips, alarms and interlocks should be in place. (Refer to tables in section 4 under preventative and mitigative measures).

TECHNOLOGY AND LOCATION OF BESS FACILITIES

- From a safety and health point of view, the above Risk Assessment shows that risks posed by VRFB systems may be slightly lower than those of SSL facilities, particularly with respect to fire and explosion risks. From an environmental spill and pollution point of view the VRFB systems present higher short-term risks than the SSL systems. However, the above conclusions may be due to the fact that the VRFB technology is not as mature as SSL technology and therefore there is not as much operating experience and accident information available for the VRFB. Overall, from and SHE RA points of view, there is no specific preference for a type of technology.
- From a SHE risks assessment point of view, where there is a choice of location (not applicable on this project) that is further from public roads, water courses or isolated farmhouses/occupied developments, this would be preferred. VRFB hazards are mostly related to possible loss of containment of electrolyte and SSL batteries to fires producing toxic smoke and fire fighting which may result in contaminated firewater runoff. One would not want these liquids to enter water courses nor the smoke to pass close to houses / public traffic.

CUMULATIVE IMPACTS

- From a safety and health point of view, there are no significant cumulative impacts from any other BESS installation in the greater area.

5.2 RECOMMENDATIONS

The following recommendations have been made:

- There are numerous different battery technologies but using one consistent battery technology system for the BESS installations associated with all the developments in the Belfast area associated with the Roos Project would allow for ease of training, maintenance, emergency response and could significantly reduce risks.
- Where reasonably practicable, state-of-the-art battery technology should be used with all the necessary protective features e.g., draining of cells during shutdown and standby-mode, full BMS with deviation monitoring and trips, leak detection systems.
- There are no fatal flaws associated with the proposed Solar Energy battery installation for either technology type.
- The tables in Section 4 of this report contains technical and systems suggestions for managing and reducing risks. Ensure the items listed in these tables under preventative and mitigative measures are included in the design.
- The overall design should be subject to a full Hazop prior to finalization of the design.
- For the VRFB systems an end of life (and for possible periodic purging requirements) solution for the large quantities of hazardous electrolyte should be investigated, e.g., can it be returned to the supplier for re-conditioning.
- Prior to bringing any solid-state battery containers into the country, the contractor should ensure that:
 - An Emergency Response Plan is in place that would be applicable for the full route from the ship to the site. This plan would include details of the most appropriate emergency response to fires both while the units are in transit and once they are installed and operating.
 - An End-of-Life plan is in place for the handling, repurposing or disposal of dysfunctional, severely damaged batteries, modules and containers.
- The site layout and spacing between lithium solid-state containers should be such that it mitigates the risk of a fire or explosion event spreading from one container to another.
- In order to limit the possibility of domino failures the BESS should be separated from the substation by at least 20m.
- Under certain weather conditions, the noxious smoke from a fire in a lithium battery container could travel some distance from the unit. The smoke will most likely be acrid and could cause irritation, coughing, distress etc. Close to the source of the smoke, the concentration of toxic gases may be high enough to cause irreversible harmful effects. Location of the facilities needs to ensure a suitable separation distance from public facilities/residences etc. The preferred and the alternative BESS

locations are over 500m from isolated farmhouses/developments, and are therefore suitable in this context.

- VRFB hazards are mostly related to possible loss of containment of electrolyte and solid-state systems may experience fires that may result in loss of containment of liquids or the use of large amounts of fire water which could be contaminated. One would not want these run-offs to enter water courses directly and a BESS Location that is far from water courses would be preferred. The buffer distance between water bodies and the facilities containing chemicals should be set in consultation with a water specialist and is therefore not specified in this SHE RA. It is noted that there are no tributaries of the main water courses in the area within 100m of the proposed BESS Location.
- Finally, it is suggested once the BESS technology has been chosen and more details of the final design are available, the necessary updated Risk Assessments should be in place (prior to commencement, after environmental authorisation and other necessary approvals are granted (should such be granted)).

6 REFERENCES

1. "National Environmental Management Act, 1998 (Act No. 107 of 1998), as amended (NEMA) and the NEMA EIA Regulations, 2014, as amended. Government Gazette No 19519 of 27 November 1998.
2. "Environmental Impact Assessment Regulations, 2014, as amended", Government Gazette No 326 of 7 April 2017.
3. SABS, "SANS 10228 – The Identification and Classification of Dangerous Goods for Transport", Standards South Africa, Pretoria, 2012.
4. SABS, "SANS 10234 – Globally Harmonize System of classification and labelling of chemicals (GHS)", SABS, Pretoria 2008.
5. SABS, "Supplement to SANS 10234 – List of classification and labelling of chemicals in accordance with the Globally Harmonize System (GHS)", SABS, Pretoria, 2008.
6. SABS, "SANS 10160: part 4: Basis of structural design and actions for buildings and industrial structures Part 4 seismic actions and general requirements for building", SABS, Pretoria, 2011.
7. SABS, "SANS10313: Protection against lightning – physical damage to structure and life hazard", SABS, Pretoria, 2012.
8. DNV-GL, Recommended Practice – Safety, operation and performance of grid-connected energy storage systems, DNVGL-RP-0043, September 2017
9. IEC, "IEC 62619 – Secondary cells and batteries containing alkaline or other non-acid electrolytes – Safety Requirements or secondary lithium cells and batteries for use in industrial applications", Feb 2017.
10. Hare, G. "Batteries – What's the Problem", Brandz, Fire and Emergency New Zealand Research Report 174. Jan 2020.
11. DNV-GL, 'McMicken Battery Energy Storage Systems Event – Technical Analysis and Recommendations, July 2020.
12. DNV-GL, 'Quantitative risk analysis for battery energy storage sites', 17 May 2019.
13. Energy Response Solutions, "Energy Storage Systems Safety - Comparing Vanadium Redox Flow and Lithium-Ion Based Systems ", Aug 2017.
14. Wikipedia, "Vanadium redox Batteries".
15. Bushveld Minerals and Energy, "Energy Storage and Vanadium Redox Flow batteries 101", 13 November 2018.
16. Whitehead A.H, Rabbow T.J, Trampert M, Pokorny P, "Critical safety features of the vanadium redox flow battery", Volume 351, 31 May 2017, Pages 1-7.
17. ESI AFRICA, "The vanadium redox flow battery, a leading technology in energy storage", Aug 8, 2019.
18. Noak J, Roznyatovskaya N, Menictas C and Skyllas-Kazacos AM, "Redox flow batteries for renewable energy storage", 21 Jan 2020.
19. Global Sustainable Energy Solutions, "Battery Storage Systems: What are their chemical hazards?", GSES Technical Papers, 2016, www.gses.com.au.
20. University of Washington Environment Health and Safety, "Lithium Battery Safety", www.ehs.washington.edu, April 2018.
21. Hesler, P & Travers, K.A., "Lithium-ion Battery Energy Storage Systems - The risks and how to manage them", AIG, 17 July 2019.
22. Verhaegh, N., van de Burgt, J., Tiggelman, A and Mulder G. "STALLION Handbook on safety assessment for large Scale, stationary, grid-connected Lithium -ion energy Storage Systems", Arnhem, March 2015.
23. TESLA, Battery Emergency Response Guide (Lithium-ion), 17 Dec 2019.
24. Tesla, MegaPack – Datasheet Safety Overview.
25. St John, J, "SunEdison Buys Solar Grid Storage for Battery-Backed PV and Wind Power", Greentechmedia.com, 5 March 2015.
26. Energy Storage Association, "Operation Risk Management in the US Energy Storage Industry: Lithium-Ion Fire and Thermal Event Safety", Sept 2019.

APPENDIX A

Preliminary Approximations of Absolute WORST-CASE Consequence and Risk Modelling (Modelling done using DNV-GL software PHAST RISK 6.7)

PLEASE NOTE – the modelling, especially the noxious smoke modelling, is an approximation.

Approximation of WORST-CASE Radiation Levels from an Entire Container on Fire

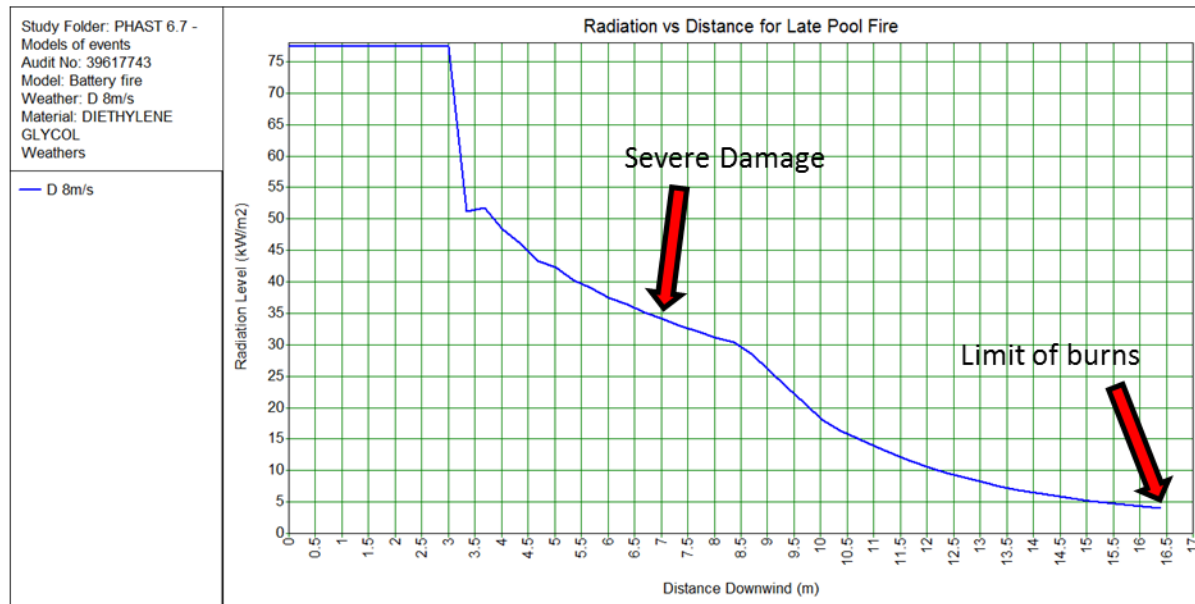

Approximation of WORST-CASE Explosion Over pressures from an Entire Container Explosion

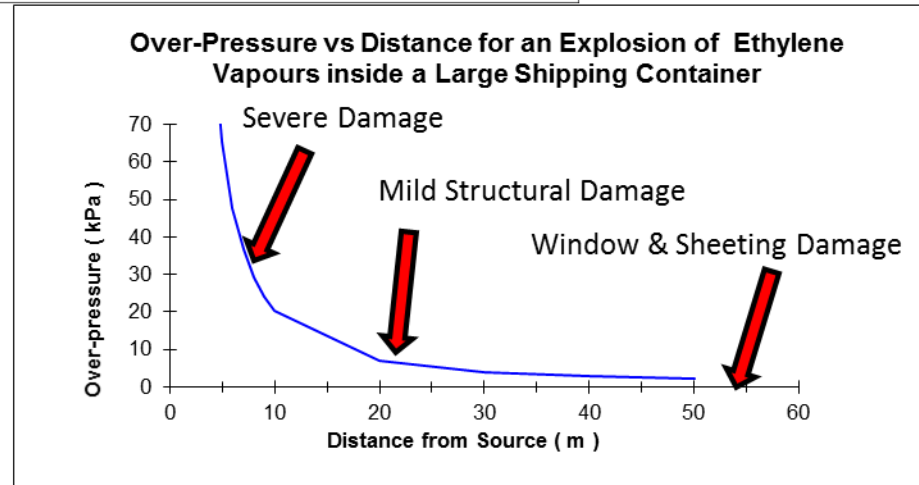
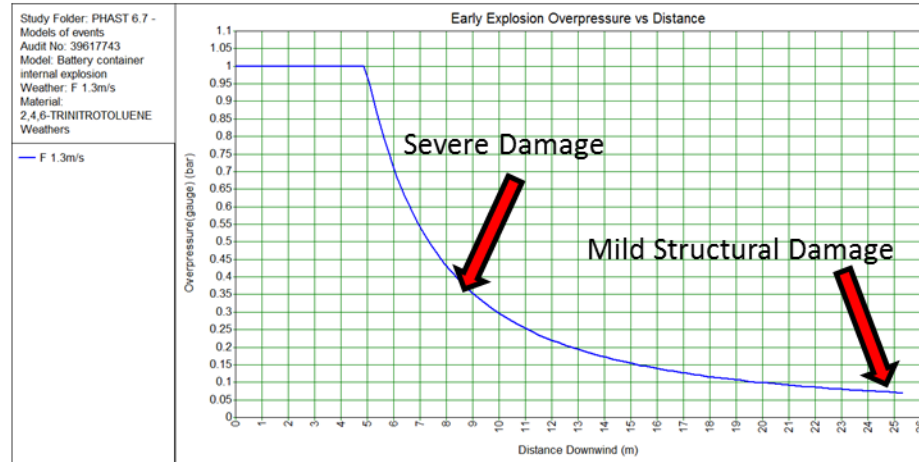

**Approximation of Maximum Concentration of Carbon Monoxide in Noxious Smoke Cloud from Lithium Container Fire
200ppm is the Nuisance Level, 500ppm is potentially harmful**

