



Appendix 7C
Proof of Advertisements

**OMGEWINGSIMPAKEVALUERING (OIE) VIR DIE BEOOGDE ONTWIKKELING VAN DIE
RONDEKOP WINDKRAGAAANLEG TUSSEN MATJIESFONTEIN EN SUTHERLAND,
NOORD-KAAPPROVINSIE**

Ingevolge die Nasionale Wet op Omgewingsbestuur, 1998 (Wet 107 van 1998) (NEMA), soos gewysig, en die Regulasies op Omgewingsimpakevaluering (OIE), kragtens Staatskennisgewing R982, R983, R984 en R985 wat op 4 Desember 2014 afgekondig en op 7 April 2017 gewysig is, geskied kennis hiermee dat Rondekop Wind Farm (Edms.) Bpk. SiVEST SA (Edms.) Bpk. aangestel het as die onafhanklike Omgewingsevalueringpraktisyn (OEP) om die nodige Omgewingsimpakevaluering- en Openbare Deelnameproses (ODP) vir die onderstaande ontwikkeling te onderneem wat by die Nasionale Departement van Omgewingsake ingedien moet word vir besluitneming.

PROJEKBESKRYWING

Ter ondersteuning van die behoefte om weg te beweeg van steenkool as ons hoofbron van elektrisiteit en om meer volhoubare en omgewingsvriendelike energiehulpbronne te kry, het Suid-Afrika 'n program vir die ontwikkeling van infrastruktuur van stapel gestuur wat deur verskeie staatsinisiatiewe ondersteun word. In antwoord op hierdie doel, beoog Rondekop Wind Farm (Edms.) Bpk. om die Rondekop Windkragaanleg (WEF) naby Sutherland in die Noord-Kaapprovinsie te ontwikkel. Die oorhoofse doelwit van die projek is om elektrisiteit aan die hand van hernubare kragtegnologieë op te wek deur windkrag in te span en dit by die nasionale kragnet in te voer.

Op hierdie stadium word aan die hand gedoen dat die beoogde Rondekop WEF uit hoogstens 48 windturbines en gepaardgaande infrastruktuur met 'n totale opwekkingsvermoë van hoogstens 325 MW sal bestaan. Die uiteindelijke aantal turbines en uitleg van die WEF sal egter afhang van die uitkoms van die spesialisstudies wat tydens die OIE-proses onderneem word.

PROJEKLIIGING

Die WEF-projekgebied is sowat 45 km suidwes van Sutherland in die Noord-Kaapprovinsie geleë. Die beoogde aanleg is geleë in die Karoo Hoogland Plaaslike Munisipaliteit, wat in die Namakwa Distriksmunisipaliteit val. Die projek sluit die volgende plase in (waarvan party slegs deur die opgradering van die openbare pad geraak word):

Ashoek No. 224	Restant van Vinke Kuil 171
Gedeelte 1 en Restant van Bloem Fontein No. 192	Gedeelte 1, 3 en Restant van Venters Kraal No. 166
Gedeelte 1 van Lange Huis 174	Gedeelte 1 en Restant van Wind Heuvel No. 190
Restant van Hout Hoek No. 191	Restant van Zeekoegat No. 169
Gedeelte 1 en Restant van Rootheuvel No. 170	Restant van Plaas 220
Gedeelte 1 en 2 van Urias Gat No. 193	

Om as 'n belangstellende en/of geaffekteerde party (B&GP) te registreer en/of om bykomende inligting te bekom, moet u asseblief u naam, kontakbesonderhede (telefoonnommer, pos- en e-posadres) en die belang wat u by die aansoek het aan SiVEST by die onderstaande besonderhede verstrek en die verwysing "Rondekop WEF" in u korrespondensie gebruik. SiVEST sal alle geregistreerde B&GP's op hoogte van die proses hou.

Hlengiwe Ntuli – SiVEST

SiVEST Environmental	Tel: 011 798 0600
Posbus 2921	Faks: 011 803 7272
RIVONIA	E-pos: hlengiwen@sivest.co.za / sivest_ppp@sivest.co.za
2128	Webwerf: www.sivest.co.za

**ENVIRONMENTAL IMPACT ASSESSMENT (EIA) FOR THE PROPOSED DEVELOPMENT OF THE
RONDEKOP WIND ENERGY FACILITY BETWEEN MATJIESFONTEIN AND SUTHERLAND,
NORTHERN CAPE PROVINCE**

In terms of the National Environmental Management Act, 1998 (Act No. 107 of 1998) (NEMA) as amended and the Environmental Impact Assessment (EIA) Regulations, under Government Notices No R982, R983, R984 and R985 promulgated on 4 December 2014 and amended on 07 April 2017, notice is hereby given that Rondekop Wind Farm (Pty) Ltd has appointed SiVEST SA (Pty) Ltd, as the independent Environmental Assessment Practitioner (EAP), to undertake the required Environmental Impact Assessment and Public Participation Processes (PPP) for the below-mentioned development to be submitted to the National Department of Environmental Affairs for decision-making.

PROJECT DESCRIPTION

In support of the need to divert from coal as our main source of electricity and to find more sustainable and environmentally friendly energy resources, South Africa has embarked on an infrastructure growth programme supported by various government initiatives. In response to this goal; Rondekop Wind Farm (Pty) Ltd is proposing to develop the Rondekop Wind Energy Facility (WEF) near Sutherland in the Northern Cape Province. The overall objective of the project is to generate electricity by means of renewable energy technologies capturing wind energy and to feed into the national grid.

At this stage it is anticipated that the proposed Rondekop WEF will comprise of up to 48 wind turbines and associated infrastructure with a total generation capacity of up to 325MW. The final number of turbines and layout of the WEF will, however, be dependent on the outcome of the specialist studies conducted during the EIA process.

PROJECT LOCATION

The WEF project area is located approximately 45 km south-west of Sutherland in the Northern Cape Province. The proposed facility is located in the Karoo Hoogland Local Municipality which falls within the Namakwa District Municipality. The project includes the following farms (some which are only affected by the public road upgrade):

Ashoek No 224	Remainder of Vinke Kuil 171
Portion 1 and Remainder of Bloem Fontein No 192	Portion 1, 3 and Remainder of Venters Kraal No 166
Portion 1 of Lange Huis 174	Portion 1 and Remainder of Wind Heuvel No 190
Remainder of Hout Hoek No 191	Remainder of Zeekoegat No 169
Portion 1 and Remainder of Roodeheuvel No 170	Remainder of Farm 220
Portion 1 and 2 of Urias Gat No 193	

To register as an Interested and / or Affected Party (I&AP) and / or to obtain additional information please submit your name, contact details (telephone number, postal address and email address) and the interest which you have in the application to SiVEST as per the details below and please reference the 'Rondekop WEF' in your correspondence. SiVest shall keep all registered I&APs informed of the process.

Hlengiwe Ntuli - SiVest

SiVEST Environmental	Tel: (011) 798 0600
P O Box 2921	Fax: (011) 803 7272
RIVONIA	E-mail: hlengiwen@sivest.co.za / sivest_ppp@sivest.co.za
2128	Website: www.sivest.co.za

**SKIET WENNERS**

BY Boesmanlandjag op Calvinia se jaarlikse drie-geweer skietkompetisie Saterdag 3 November 2018 was Johann Strauss die voorsitter, wenner van die "bakkie" klas. Saam met hom is Louwtjie Hanekom (Standaard klas wenner), Johan Kuhn (Ope klas wenner) en Gerhard van Rensburg van die borg Wildman.

GWK STAL UIT

NEIL HAVENGA, Josef Burger, Adri Myburgh en Rodney Gous het vanjaar GWK se stalletjie by die Oewerfees langs die rivier net buite Prieska beman. Die fees was weer eens 'n reuse sukses.

WOLPRYS SAK MET SES PERSENT**Noord-Kaap wol**

PORT ELIZABETH – Hierdie week het die wolmark weer laer verhandel en die Cape Wools Merino Aanwyser het met 6% en 1312 punte verswak en gesluit op 'n skoonprys van R204,68/kg.

Onder die Top Tien hoogste pryse op OVK/CMW se veiling was drie verkopers uit hierdie streek. Hulle is:

* W.A. Nolte, Victoria-Wes vir 1 BFFY van 17,5 mikron teen R167,50/kg

* J.A. van der Merwe, Sutherland vir 4 AFY van 18,4 mikron teen R166,10/kg

* W.A. Nolte, Victoria-Wes vir 3 CFF van 17,6 mikron teen R165,80/kg

Onder die Top Tien vir die Noord-Kaap is nog die volgende kliënte van OVK uit hierdie streek:

* W.A. Nolte, Victoria-Wes vir 1 BFF van 18,1 mikron teen R163,70/kg

* J.A. van der Merwe, Sutherland vir 6 CL van 17,3 mikron teen R162,10/kg

* W.A. Nolte, Victoria-Wes vir 2 CFFY van 16,7 mikron teen R160,60/kg



NAMAKWA
DISTRIKSMUNISIPALITEIT
DISTRICT MUNICIPALITY
KENNISGEWINGNOMMER 31/2018

RAADSVERGADERING 20 NOVEMBER 2018

KENNIS GESKIED HIERMEE DAT DIE VOLGENDE VERGADERING VAN DIE RAAD OP

DINSDAG, 20 NOVEMBER 2018 OM 10:00

IN DIE RAADSAAL OP SPRINGBOK

van die Namakwa Distriksmunisipaliteit (Hendrik Visser-gebou) plaasvind.

Dit is 'n oop vergadering en die publiek is welkom.

MUNISIPALE BESTUURDER

Namakwa Distriksmunisipaliteit
Privaatsak X20
SPRINGBOK 8240

**SIVEST**

ENVIRONMENTAL IMPACT ASSESSMENT (EIA) FOR THE PROPOSED DEVELOPMENT OF THE RONDEKOP WIND ENERGY FACILITY BETWEEN MATJIESFONTEIN AND SUTHERLAND, NORTHERN CAPE PROVINCE

In terms of the National Environmental Management Act, 1998 (Act No. 107 of 1998) (NEMA) as amended and the Environmental Impact Assessment (EIA) Regulations, under Government Notices No R982, R983, R984 and R985 promulgated on 4 December 2014 and amended on 07 April 2017, notice is hereby given that Rondekop Wind Farm (Pty) Ltd. has appointed SIVEST SA (Pty) Ltd, as the independent Environmental Assessment Practitioner (EAP), to undertake the required Environmental Impact Assessment and Public Participation Processes (PPP) for the below-mentioned development to be submitted to the National Department of Environmental Affairs for decision-making.

PROJECT DESCRIPTION

In support of the need to divert from coal as our main source of electricity and to find more sustainable and environmentally friendly energy resources, South Africa has embarked on an infrastructure growth programme supported by various government initiatives. In response to this goal: Rondekop Wind Farm (Pty) Ltd. is proposing to develop the Rondekop Wind Energy Facility (WEF) near Sutherland in the Northern Cape Province. The overall objective of the project is to generate electricity by means of renewable energy technologies capturing wind energy and to feed into the national grid.

At this stage it is anticipated that the proposed Rondekop WEF will comprise of up to 48 wind turbines and associated infrastructure with a total generation capacity of up to 325MW. The final number of turbines and layout of the WEF will, however, be dependent on the outcome of the specialist studies conducted during the EIA process.

PROJECT LOCATION

The WEF project area is located approximately 45km south-west of Sutherland in the Northern Cape Province. The proposed facility is located in the Karoo Hoogland Local Municipality which falls within the Namakwa District Municipality. The project includes the following farms (some which are only affected by the public road upgrade):

Ashoek No.224	Remainder of Vinke Kuil 171
Portion 1 and Remainder of Bloem Fontein No. 192	Portion 1, 3 and Remainder of Venters Kraal No. 166
Portion 1 of Lange Huis 174	Portion 1 and Remainder of Wind Heuvel No. 190
Remainder of Hout Hoek No. 191	Remainder of Zeekoegat No. 169
Portion 1 and Remainder of Roodeheuvel No. 170	Remainder of Farm 220
Portion 1 and 2 of Urias Gat No. 193	

To register as an interested and / or Affected Party (I&AP) and / or to obtain additional information please submit your name, contact details (telephone number, postal address and email address) and the interest which you have in the application to SIVEST as per the details below and please reference the "RondekopWEF" in your correspondence. SIVEST shall keep all registered I&APs informed of the process.

SIVEST Environmental Tel.:	Hlangiwe Ntuli – SIVEST
P.O. Box 2921	011 798 0600
RIVONIA	Fax: 011 803 7272
2128	E-mail: hlangiwen@sivest.co.za / sivest_ppp@sivest.co.za

**BESTE GRONDSLAG**

TYDENS Malherbe Human Laerskool se prysuitdeling was hierdie leersders die beste presteerders in die Grondslagfase: Gayrinne Isaacs (Gr.1); Jowaylin Veldsman (Gr.2); Carlynn Heynse (Gr.3).

HULLE WAS TOPS

TYDENS Malherbe Human Laerskool op Fraserburg se jaarlikse prysuitdeling was Erin Muller die topleerder in Graad 4, Jayden Hartnick die topleerder in Graad 5 en Kayrin Malan die topleerder in Graad 6.

**Dr. Wim Gericke Ortopediese Chirurg**

van die Paarl, besoek Calvinia gereeld om pasiënte met ortopediese probleme te sien. Dr. Gericke het 'n spesiale belangstelling in voet, nek en rugprobleme.

Die volgende besoek is Calvinia 22 November 2018

Afsprake: 021 872 1000 / 021 872 1408 / 082 610 9967
Paarl Mediese Sentrum, Kamer 11 Prak nr: 2805200

MUNISIPALITEIT UBUNTU MUNICIPALITY

KENNISGEWING NR. 03/2018

VOORGESTELDE ONDERVERDELING VAN ERF 372 VICTORIA-WES, UBUNTU PLAASLIKE MUNISIPALITEIT

Kennis geskied ingevolge die bepalinge van die Ruimtelike Beplanning en Grondgebruik Bestuur Wet, Wet 16 van 2013, saamgelees met die Ruimtelike Beplanning en Grondgebruik Bestuur Bywet dat die gedelegeerde Munisipale Amptenaar/Saamgestelde Munisipale Beplannings Tribunaal van voorneme is om die onderstaande aksie op onroerende eiendom te oorweeg:

Eiendom: Die restant van erf 540, erf 541 en erf 1116 Victoria Wes, Ubuntu Munisipaliteit, Noord-Kaap Provinsie

Ligging: Die aansoek gebied is geleë te Helpmekaarstraat/Landboustraat Victoria-Wes, Noord-Kaap, Provinsie

Eienaar: Bernard Gericke Andrag

Aansoeker: SMG PROFPLAN (PTY) LTD (Schalk M Grobelaar Pr.Pln)

Doel van aansoek:

Die aansoek behels (a) die opheffing van beperkings in die titelvoorwaardes T 049494/2010, (b) die konsolidering van die restant van erf 540, erf 541 en erf 1116 en (c) die hersoening van die gekonsolideerde erf van residensiële doeleindes na institusionele doeleindes (privaat skool).

Nadere besonderhede is verkrygbaar vanaf die Munisipale Bestuurder, Telefoon 053 621 0026, gedurende normale kantoorure en besware teen die aansoek, indien enige, moet aldaar skriftelik (E-pos: ubuntuvw@gmail.com of Faks: 053 6210 368) ingedien word om hom voor of op **Vrydag 30 November 2018**, te bereik. Indien enige persoon wat teen die aansoek beswaar wil maak, nie kan skryf nie, kan sodanige persoon gedurende normale kantoorure voor of op **Vrydag 30 November 2018**, die Infrastruktuurafdeling, aanmeld waar sodanige persoon se beswaar op skrif gestel sal word.

Mr. D Maposa

Acting Municipal Manager/ Waarnemende Munisipale Bestuurder

NOTICE NO. 03/2018

PROPOSED SUBDIVISION OF ERF 372 VICTORIA WEST, UBUNTU LOCAL MUNICIPALITY

Notice is given in terms of the provisions of the Spatial Planning Land Use Management Act, Act 16 of 2013, read with the Spatial Planning and Land Use Bylaw that it is the intention of the delegated Municipal Official/ Joint Municipal Planning Tribunal Council to consider the under mentioned actions on immovable property:

Property: The remainder of erf 540, erf 541 and erf 1116 Victoria West, Ubuntu Municipality, Northern Cape Province

Location: The application area is located in Helpmekaar Street/Landbou Street, Victoria West, Northern Cape Province

Owner: Bernard Gericke Andrag

Applicant: SMG PROFPLAN (PTY) LTD (Schalk M Grobelaar Pr.Pln)

Purpose of application:

The application comprises (a) the removal of restrictions in the title deed T 049494/2010, (b) the consolidation of the remainder of erf 540, erf 541 and 1116 Victoria West, and (c) the rezoning of the consolidated erf from residential purposes to institutional (private school) purposes.

Full particulars are obtainable from the Municipal Manager, Telephone 053 621 0026, during normal office hours and objections against the application, if any, must be lodged in writing to the Municipal Manager (E-mail: ubuntuvw@gmail.com or Fax: 053 6210 368 before or on **Friday 30 November 2018**. Any person with objections against the application, who is unable to write, can during normal office hours on or before **Friday 30 November 2018**, report to the Infrastructure Division where such a person's objections will be put in writing.

Ubuntu Municipality

Private Bag X329, Victoria West 7070

JAPIE VERSKIL EFFE VAN EINSTEIN

Hang af van wat jy gaan saamstel

Geagte Leser,

Albert Einstein was altyd verwonderd oor die mag van saamgestelde rente. Dit is verstaanbaar. Kyk na die volgende voorbeeld: As jy op 22-jarige ouderdom 'n R1 000 belê vir 40 jaar teen 'n koers van 8% jaarliks saamgestel, sal die eindbedrag nagenoeg R16 000 wees. Dit klink na baie geld, sesien keer meer as wat aanvanklik belê is.

Daar moet egter twee faktore in ag geneem word. Daar is nie voorsiening gemaak vir die uitwerking van inkomste belasting nie. Die tweede faktor is die verlies van koopkrag wat maar meeste van die tyd by ons is. Dit beteken in die praktyk dat wanneer jy die R1 000 belê, die eindbedrag van R16 000 na baie geld lyk. As voorsiening gemaak word aan die verlies aan koopkrag soos gemeet deur die jaarliks saamgestelde verbruikers-prysindeks (VPI), dan is die werklike waarde van die eindbedrag ongeveer R500. Dit is minder as wat aanvanklik belê is. Hierdie verskynsel is nie onbekend aan ons nie. Dit tref veral mense wat vroeg afgetree het en dan later op hul oudag uitvind dat hulle nie meer genoeg geld het

om van te lewe nie.

Die volgende vergelykings maak interessante leesstof. In 1984 kon 'n mens 'n ooi koop vir R50. Op grond van die saamgestelde VPI sal 'n ooi nou R727 werd wees. In der waarheid is aantelooie se waarde nou nader aan R1 500 wat beteken die prys van ooe het vinniger gestyg as die jaarliks saamgestelde VPI. Grondpryse lyk asof dit dieselfde tendens volg.

Dit is interessant om op dieselfde wyse na ander syfers te kyk. As jy in 1955 'n halfkroon as kollektegeld in die kerk se bordjie gegooi het, moet jy vandag R25 ingooi om dieselfde waarde aan die kerk te gee. In 1967 sou 'n studiebeurs van R700 aan 'n universiteit al jou uitgawes dek. Vandag is daardie R700 ongeveer R50 000 werd wat net die helfte is van wat nodig is vir een studiejaar. 'n Onderwyser het in 1970 ongeveer R130 per maand huis toe geneem. Gemeent aan die jaarliks saamgestelde VPI moet die onderwyser nou ongeveer R9 000 huis toe neem. Die werklike salaris is nader aan R20 000. Ons kan dus sê dat dit moeiliker is om studies te bekostig, maar dat onderwysers relatief meer verdien as hul eweknieë van 1970.

Waar al hierdie syfers 'n mens bring is nie so duidelik nie. Al wat seker is, is dat saamgestelde rente 'n ewebeld het naamlik jaarliks saamgestelde VPI en dat albei oor tyd dramatiese afmetings aanneem.

Groete, Japie.

MAJOOR VEREER

MAJOOR PEARL BLOCK van die Suid-Afrikaanse Nasionale Weermag saam met die Kanadese Eerste Minister, Justin Trudeau in Vancouver Kanada. Sy is daar aangewys as die VN se Militêre Gender Advokaat van die Jaar.



OMGEWINGSIMPAKEVALUERING (OIE) VIR DIE BEOOGDE ONTWIKKELING VAN DIE RONDEKOP WINDKRAAGANLEG TUSSEN MATJIESFONTEIN EN SUTHERLAND, NOORD-KAAPPROVINSIE

Ingevolge die Nasionale Wet op Omgewingsbestuur, 1998 (Wet 107 van 1998) (NEMA), soos gewysig, en die Regulasies op Omgewingsimpakevaluering (OIE), kragtens Staatskennisgewing R982, R983, R984 en R985 wat op 4 Desember 2014 afgekondig en op 7 April 2017 gewysig is, geskied kennis hiermee dat Rondekop Wind Farm (Edms.) Bpk. SIVEST SA (Edms.) Bpk. aangestel het as die onafhanklike Omgewingsimpakevaluering (OIE) en die nodige Omgewingsimpakevaluering- en Openbare Deelnemingsproses (ODP) vir die onderstaande ontwikkeling te onderneem wat by die Nasionale Departement van Omgewingsake ingedien moet word vir besluitneming.

PROJEKBERSKRYWING

Ter ondersteuning van die behoefte om weg te beweeg van steenkool as ons hoofbron van elektrisiteit en om meer volhoubare en omgewingsvriendelike energiebronne te kry, het Suid-Afrika 'n program vir die ontwikkeling van infrastruktuur van stapel gestuur wat deur verskeie staatsinisiatiewe ondersteun word. In antwoord op hierdie doel, beoog Rondekop Wind Farm (Edms.) Bpk. om die Rondekop Windkragaanleg (WEF) naby Sutherland in die Noord-Kaapprovinsie te ontwikkel. Die oorhoofse doelwit van die projek is om elektrisiteit aan die hand van hernubare kragtegnologieë op te wek deur windkrag in te span en dit by die nasionale kragnet in te voer.

Op hierdie stadium word aan die hand gedoen dat die beoogde Rondekop WEF uit hoogstens 48 windturbines en gepaardgaande infrastruktuur met 'n totale opwekkingsvermoë van hoogstens 325 MW sal bestaan. Die uiteindelijke aantal turbines en uitleg van die WEF sal egter afhang van die uitkoms van die spesialisstudies wat tydens die OIE-proses onderneem word.

PROJEKLIIGING

Die WEF-projekgebied is sowat 45 km suidwes van Sutherland in die Noord-Kaapprovinsie-geleë. Die beoogde aanleg is geleë in die Karoo Hoogland Plaaslike Munisipaliteit, wat in die Namakwa Distriksmunisipaliteit val. Die projek sluit die volgende plase in (waarvan party slegs deur die opgradering van die openbare pad geraak word):

Ashoek No. 224

Gedeelte 1 en Restant van Bloem Fontein No. 192

Gedeelte 1 van Lange Huis 174

Restant van Hout Hoek No. 191

Gedeelte 1 en Restant van Roodeheuwel No. 170

Gedeelte 1 en 2 van Urias Gat No. 193

Restant van Vinke Kuil 171

Gedeelte 1, 3 en Restant van Venters Kraal No. 166

Gedeelte 1 en Restant van Wind Heuwel No. 190

Restant van Zeekoegat No. 169

Restant van Plaas 220

Om as 'n belangstellende en/of geaffekteerde party (B&GP) te registreer en/of om bykomende inligting te bekom, moet u asseblief u naam, kontakbesonderhede (telefoonnommer, pos- en e-posadres) en die belang wat u by die aansoek het aan SIVEST by die onderstaande besonderhede verstrek en die verwysing "Rondekop WEF" in u korrespondensie gebruik. SIVEST sal alle geregistreerde B&GP's op hoogte van die proses hou.

Hlangiwe Ntuli - SIVEST

SIVEST Environmental	Tel:	011 798 0600
Posbus 2921	Faks:	011 803 7272
RIVONIA	E-pos:	hlangiwen@sivest.co.za / sivest_ppp@sivest.co.za
2128		

LAERSKOOI DIEPDRIFT PRIMARY VAKANTE POS VIR DEPARTEMENTELE MULTIGRAAD-OPVOEDER

(POSVLAK 1)

VANAF 1 APRIL 2019

GRAAD 4-7: ALLE VAKKE

VEREISTES

- * Opvoeder sal al 27 vakke aanbied.
- * Relevante onderwys kwalifikasie word verlang.
- * Opvoeder moet SASAMS-vaardig wees
- * Opvoeder moet by SACE geregistreer wees

Sluitingsdatum: **30 November 2018**

Skakel

Me C. Cupido (kringbestuurder) by 027 341 1728 of

Me C.G. Steenkamp (prinsipaal) by 027 341 2280 / 082 463 3927



Appendix 7D
Correspondence



**Appendix 7D1
FROM Authorities**

sivest_PPP

From: Alishea Pretorius <PretoriusA@sentech.co.za>
Sent: 15 November 2018 10:34 AM
To: sivest_PPP
Subject: FW: Rondekop Wind Energy Facility: EIA Commencing

Importance: High

Good day

See email below with info needed before we can comment.

Regards



Alishea Pretorius
Site Acquisition and Environmental Specialist

Tel: +27 11 471 4540 • Cell phone: +27 82 777 8506
Sender Technology Park • Octave Road • Honeydew
E-mail: pretoriusa@sentech.co.za
Website: www.sentech.co.za

From: Serame Motlhake
Sent: Tuesday, 13 November 2018 11:39 AM
To: Alishea Pretorius <PretoriusA@sentech.co.za>
Subject: RE: Rondekop Wind Energy Facility: EIA Commencing
Importance: High

Good Day Madame,

We have no records of this planned WTG.

Below is the information required for us to do the study:

The following process is followed:

1. A preliminary study to be conducted and a quotation for a detailed study. A .kml with wind turbine positions is required for this purpose;
2. We will conduct the preliminary study of the wind farm location to determine how many terrestrial transmitter stations might be effected. Based on the findings we will forward the man-hours required for the study to our Marketing and Sales Division who will then issue a quotation;
3. Once the amount is settled an interference investigation study will be conducted. The results and findings will be compiled in an interference assessment report. If the findings indicate that the interference area and number of people affected is acceptable a conditional letter of approval will be provided.
4. The following information is required for the detailed study:
 - Latest .KML WTG layout of the wind farm;
 - Number of wind turbines (please provide the total number of wind turbines)
 - Height of wind turbine up to the hub;
 - Length of wind turbine blade;

- Maximum blade width;
- Diameter of tower at base;
- Diameter of tower below hub;

5. Demarcated map indicating wind turbine positions and wind farm boundary areas.

Regards,

Serame

From: Alishea Pretorius
Sent: 13 November 2018 10:58 AM
To: Serame Motlhake <MotlhakeS@sentech.co.za>
Subject: FW: Rondekop Wind Energy Facility: EIA Commencing

Good day Sir

Are we aware of this potential development of a wind energy facility?

Kind regards



Alishea Pretorius
 Site Acquisition and Environmental Specialist

Tel: +27 11 471 4540 • Cell phone: +27 82 777 8506
 Sender Technology Park • Octave Road • Honeydew
 Email: pretoriaa@sentech.co.za
 Website: www.sentech.co.za

From: sivist_PPP [mailto:sivist_ppp@sivest.co.za]
Sent: Friday, 09 November 2018 4:53 PM
To: Andrea Gibb <AndreaG@sivest.co.za>; Shivani Naidoo <ShivaniN@sivest.co.za>; 'Veronique Fyfe' <veronique@g7energies.com>
Cc: 'Henning Myburg' <henning@agrink.co.za>; 'Simphiwe Masilela' <ObstacleEvaluators@atns.co.za>; 'Johanna Morobane' <JohannaM@atns.co.za>; 'S Frans' <franss@netstar.altech.co.za>; 'Johan' <Johan@fleetcall.co.za>; 'Phillip De Lange' <phillipd@atns.co.za>; 'Ferdie Smit' <ferdis@atns.co.za>; 'Candice Stevens' <advocacy@birdlife.org.za>; 'Samantha Ralston-Paton' <energy@birdlife.org.za>; 'Coert Smit' <coert@breedenet.co.za>; 'Vivian Kiewitz' <VKiewitz@cellc.co.za>; 'Jacoline Mans' <jacolinema@daff.gov.za>; 'Paul Avenant' <paula@daff.gov.za>; 'Colonel Loy de Jager' <loydejager@hotmail.com>; 'Mmatlala Rabothata' <mrabothata@environment.gov.za>; 'Seoka Lekota' <slekota@environment.gov.za>; 'Rasibe Sekepane' <Lungi.Mondela@dmr.gov.za>; 'Ntsundeni Ravhogoni' <Ntsundeni.Ravhogoni@dmr.gov.za>; 'Vincent Muila' <pieter.swart@dmr.gov.za>; 'Patrick Lenyibi' <plenyibi@ncpg.gov.za>; 'Ester Makungo' <makungoe@dws.gov.za>; 'Moses Mahunonyane' <MahunonyaneM@dws.gov.za>; 'Brian Fisher' <bfisher@ncpg.gov.za>; 'Andre Crous' <andre.crous@eskom.co.za>; 'John Geeringh' <GeerinJH@eskom.co.za>; 'Lourens Leeuwner' <lourensl@ewt.org.za>; 'Allistar Gibbons' <a.gibbons@karoohoogland.gov.za>; 'Willenise Klein' <w.klein@karoohoogland.gov.za>; 'Jeremy Davids' <jeremydavids11@gmail.com>; 'Veruschka Wentzel' <vcwentzel123@gmail.com>; 'Jan Johannes Jacobs' <jacobsjan624@gmail.com>; 'Jacobus Jooste' <info@karoohoogland.gov.za>; 'Giel Klazen' <seunklazen@gmail.com>; 'Johan van der Colff' <jvdc@mtnloaded.co.za>; 'Charles van Reenen' <vanree_c@mtn.co.za>; 'Jannie Loubser' <janniel@namakwa-dm.gov.za>; 'Gert Steenkamp' <gsteenkamp@ncpg.gov.za>; 'Jaco Roelofse' <roelofse.j@vodamail.co.za>; 'Thulani Mthombeni' <tmtho@webmail.co.za>; 'Lizell Stroh' <strohl@caa.co.za>; 'Administration' <salt@salt.ac.za>; 'Nicole Abrahams' <AbrahamsN@nra.co.za>; 'Rene De Kock' <Dekockr@nra.co.za>; 'Mlungisi Ngwenya'

<[Mlungisi.Ngwenya@weathersa.co.za](mailto:MLungisi.Ngwenya@weathersa.co.za)>; 'Frank Creese' <creesef@sentech.co.za>; Alishea Pretorius <PretoriusA@sentech.co.za>; Johan Koegelenberg <KoegelenbergJ@sentech.co.za>; 'Ramatholo Sefako' <rrs@sao.ac.za>; 'Danie Erasmus' <radiotech@saps.org.za>; 'Adriaan Tiplady' <atiplady@ska.ac.za>; 'Tshegofatso Monama' <temonama@ska.ac.za>; 'J Martiens' <sutherlandlib@ncpg.gov.za>; 'Ronell Cloete' <sutherlandlibrary@ncpg.gov.za>; 'M Malan' <sutherland.sc@saps.gov.za>; 'Keverne Thurling' <Thurling@telkom.co.za>; 'Heleen van den Heever' <vdheevhd@telkom.co.za>; 'Amanda Bester' <WayleaCR@telkom.co.za>; 'Sam Fiff' <Francis.Rahlapane@transnet.net>; 'Craig Barnes' <barnesc@vodacom.co.za>; 'Morgan Griffiths' <morgan.griffiths@wessa.co.za>; 'isak@breedenet.co.za' <isak@breedenet.co.za>; 'kmothomi@ncpg.gov.za' <kmothomi@ncpg.gov.za>; 'leflourd@dws.gov.za' <leflourd@dws.gov.za>; 'Mpho Sebole' <sebolemd@eskom.co.za>; 'mayorv@karoohoogland.gov.za' <mayorv@karoohoogland.gov.za>; 'ruth.cuttings@yahoo.com' <ruth.cuttings@yahoo.com>; 'BesterAD@telkom.co.za' <BesterAD@telkom.co.za>

Subject: Rondekop Wind Energy Facility: EIA Commencing

Dear Interested and/or Affected Party,

ENVIRONMENTAL IMPACT ASSESSMENT (EIA) FOR THE PROPOSED 325MW RONDEKOP WIND ENERGY FACILITY BETWEEN MATJIESFONTEIN AND SUTHERLAND IN THE NORTHERN CAPE PROVINCE

INVITATION TO PARTICIPATE IN THE ENVIRONMENTAL IMPACT ASSESSMENT PROCESS

In terms of the EIA Regulations and the National Environmental Management Act, 1998 (Act No. 107 of 1998), SiVEST SA (Pty) Ltd (hereafter referred to as SiVEST) has been appointed as the independent Environmental Assessment Practitioner (EAP) by Rondekop Wind Farm (Pty) Ltd (hereafter referred to as Rondekop Wind Farm) to conduct the Environmental Impact Assessment (EIA) process for the proposed development of the 325MW Rondekop Wind Energy Facility Between Matjiesfontein and Sutherland in the Northern Cape Province.

SiVEST would like to invite you, as a potential Interested and/or Affected Party (I&AP), to become actively involved in the EIA and Public Participation Process (PPP) for this proposed project. The aim of this process is as follows:

- To ensure that all the relevant environmental impacts are taken into consideration;
- To ensure public input; and
- Provide decision - makers with sufficient information to make an informed decision on the proposed

activities.

Attached is the Background Information Document (BID), which contains information regarding the proposed project as well as the EIA and PPP, which is currently being undertaken.

We would like to thank you, in advance, for becoming part of the Public Participation Process and are looking forward to receiving your valuable comments relating to the proposed project.

Geagte Belangstellende en/of Geaffekteerde Party

OMGEWINGSIMPAKEVALUERING (OIE) VIR DIE BEOOGDE 325 MW RONDEKOP WINDKRAGANLEG TUSSEN MATJIESFONTEIN EN SUTHERLAND IN DIE NOORD-KAAPROVINSIE

UITNODIGING OM DEEL TE NEEM AAN DIE OMGEWINGSIMPAKEVALUERINGSPROSES

Ingevolge die OIE-regulasies en die Nasionale Wet op Omgewingsbestuur, 1998 (Wet 107 van 1998), is SiVEST SA (Edms.) Bpk. (hierna SiVEST genoem) deur Rondekop Wind Farm (Edms.) Bpk. (hierna Rondekop Wind Farm genoem) aangestel as die onafhanklike Omgewingsevalueringpraktisyn (OEP) om die Omgewingsimpak-evalueringproses (OIE) vir die beoogde ontwikkeling van die 325 MW Rondekop Windkraganleg tussen Matjiesfontein en Sutherland in die Noord-Kaapprovinsie te onderneem.

SiVEST nooi u, as 'n potensiële belangstellende en/of geaffekteerde party (B&GP), uit om aktief betrokke te raak by die OIE en Openbare Deelnameproses (ODP) vir hierdie beoogde projek.

Die doel van hierdie proses is om:

- toe te sien dat oorweging aan al die tersaaklike omgewingsimpakte geskenk word;
- openbare insette te verseker; en
- besluitnemers van genoegsame inligting te voorsien om 'n ingeligte besluit oor die beoogde aktiwiteite te maak.

Aangeheg is die Agtergrondinligtingsdokument (AID) wat inligting rakende die beoogde projek, asook die OIE en ODP bevat wat tans onderneem word.

Ons bedank u by voorbaat dat u deel word van die openbare deelnameproses en ons sien uit daarna om u waardevolle insette betreffende die beoogde projek te ontvang.

Kind Regards

Shivani Naidoo

Environmental Consultant

SiVEST Environmental Division



SiVEST is a Level 3 BBBEE Contributor

D +27 11 798 0600 | **T** +27 11 798 0600 **W** www.sivest.co.za

Engineering Consulting | Project Management | Environmental Consulting | Town & Regional Planning | Management Systems Consulting

Durban | Johannesburg | Pretoria | Pietermaritzburg | Richards Bay | Port Louis (Mauritius)

Disclaimer

The information contained in this communication from the sender is confidential. It is intended solely for use by the recipient and others authorized to receive it. If you are not the recipient, you are hereby notified that any disclosure, copying, distribution or taking action in relation of the contents of this information is strictly prohibited and may be unlawful.

This email has been scanned for viruses and malware, and automatically archived by **Mimecast SA (Pty) Ltd**, an innovator in Software as a Service (SaaS) for business. **Mimecast Unified Email Management ??? (UEM)** offers email continuity, security, archiving and compliance with all current legislation. To find out more, [contact Mimecast](#).



DISCLAIMER:

This email contains confidential information. It may also be legally privileged. Interception of this email is illegal. The information contained in this email is only for the use of the intended recipient. If you are not the intended recipient, any disclosure, copying and/or distribution of the contents of this email, or the taking of any action in reliance thereon or pursuant thereto, is strictly prohibited. Should you have received this email in error, please notify us immediately by return email.

	<p style="text-align: center;">SCOT</p>	<p style="text-align: center;">Technology</p>
---	--	--

Title: **Renewable Energy Generation Plant Setbacks to Eskom Infrastructure** Unique Identifier: **240-65559775**

Alternative Reference Number: **N/A**

Area of Applicability: **Power Line Engineering**

Documentation Type: **Guideline**

Revision: **0**

Total Pages: **8**

Next Review Date: **N/A**

Disclosure Classification: **CONTROLLED DISCLOSURE**

Compiled by



J W Chetty
Mechanical Engineer

Date: 20/02/2014

Approved by



V Naidoo
Chief Engineer (Lines)

Date: 24/02/2014

Authorised by

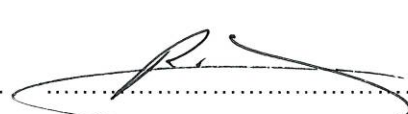

R A Vajeth
Acting Snr Manager (Lines)

Date: 27/2/2014

Supported by SCOT/SC



R Vajeth
SCOT/SC/ Chairperson

Date: 27/2/2014

PCM Reference: 240-65132732 **LINE ENGINEERING SERVICES**

SCOT Study Committee Number/Name : **OVERHEAD LINES**

CONTENTS

	Page
EXECUTIVE SUMMARY	3
1. INTRODUCTION.....	4
2. SUPPORTING CLAUSES	4
2.1 SCOPE	4
2.1.1 Purpose.....	4
2.1.2 Applicability	5
2.2 NORMATIVE/INFORMATIVE REFERENCES	5
2.2.1 Normative.....	5
2.2.2 Informative	5
2.3 DEFINITIONS	5
2.3.1 Disclosure Classification.....	6
2.4 ABBREVIATIONS	6
2.5 ROLES AND RESPONSIBILITIES	6
2.6 PROCESS FOR MONITORING	6
2.7 RELATED/SUPPORTING DOCUMENTS	6
3. DOCUMENT CONTENT	6
3.1 INTERNATIONAL SETBACK COMPARISON	6
3.2 ESKOM APPROACH FOR WIND FARMS.....	7
4. AUTHORISATION	8
5. REVISIONS.....	8
6. DEVELOPMENT TEAM	9

FIGURES

Figure 1: Horizontal Axis Wind Turbine	8
--	---

CONTROLLED DISCLOSURE

When downloaded from the EDMS, this document is uncontrolled and the responsibility rests with the user to ensure it is in line with the authorised version on the system.

EXECUTIVE SUMMARY

In recent decades, the use of wind turbines, concentrated solar plants and photovoltaic plants have been on the increase as it serves as an abundant source of energy. This document specifies setbacks for wind turbines and the reasons for these setbacks from infrastructure as well as setbacks for concentrated solar plants and photovoltaic plants. Setbacks for wind turbines employed in other countries were compared and a general setback to be used by Eskom was suggested for use with wind turbines and other renewable energy generation plants.

CONTROLLED DISCLOSURE

When downloaded from the EDMS, this document is uncontrolled and the responsibility rests with the user to ensure it is in line with the authorised version on the system.

1. INTRODUCTION

During the last few decades, a large amount of wind turbines have been installed in wind farms to accommodate for the large demand of energy and depleting fossil fuels. Wind is one of the most abundant sources of renewable energy. Wind turbines harness the energy of this renewable resource for integration in electricity networks. The extraction of wind energy is its primary function and thus the aerodynamics of the wind turbine is important. There are many different types of wind turbines which will all exhibit different wind flow characteristics. The most common wind turbine used commercially is the Horizontal Axis Wind Turbine. Wind flow characteristics of this turbine are important to analyse as it may have an effect on surrounding infrastructure.

Wind turbines also cause large turbulence downwind that may affect existing infrastructure. Debris or parts of the turbine blade, in the case of a failure, may be tossed behind the turbine and may lead to damage of infrastructure in the wake path.

This document outlines the minimum distances that need to be introduced between a wind turbine and Eskom infrastructure to ensure that debris and / or turbulence would not negatively impact on the infrastructure.

Safety distances of wind turbines from other structures as implemented by other countries were also considered and the reasons for their selection were noted.

Concentrated solar plants and photovoltaic plants setbacks away from substations were also to be considered to prevent restricting possible power line access routes to the substation.

2. SUPPORTING CLAUSES

2.1 SCOPE

This document provides guidance on the safe distance that a wind turbine should be located from any Eskom power line or substation. The document specifies setback distances for transmission lines (220 kV to 765 kV), distribution lines (6.6 kV to 132 kV) and all Eskom substations. Setbacks for concentrated solar plants and photovoltaic plants are also specified away from substations.

2.1.1 Purpose

Setbacks for wind turbines and power lines / substations are required for various reasons. These include possible catastrophic failure of the turbine blade that may release fragments and which may be thrown onto nearby power lines that may result in damage with associated unplanned outages. Turbulence behind the turbine may affect helicopter flight during routine Eskom live line maintenance and

CONTROLLED DISCLOSURE

When downloaded from the EDMS, this document is uncontrolled and the responsibility rests with the user to ensure it is in line with the authorised version on the system.

inspections that may lead to safety risk of the aircraft / personnel. Concentrated solar plants and photovoltaic plants setback away from substations were required to prevent substations from being boxed in by these renewable generation plants limiting line route access to the substations.

2.1.2 Applicability

This document is applicable to the siting of all new and existing wind turbines, concentrated solar plants and photovoltaic plants near power lines and substations.

2.2 NORMATIVE/INFORMATIVE REFERENCES

2.2.1 Normative

1. <http://www.envir.ee/orb.aw/class=file/action=preview/id=1170403/Hiiumaa+turbulence+impact+EMD.pdf>.
2. <http://www.energy.ca.gov/2005publications/CEC-500-2005-184/CEC-500-2005-184.PDF>
3. <http://www.adamscountywind.com/Revised%20Site/Windmills/Adams%20County%20Ordinance/Adams%20County%20Wind%20Ord.htm>
4. http://www.dsireusa.org/incentives/incentive.cfm?Incentive_Code=PA11R&RE=1&EE=1
5. <http://www.wind-watch.org/documents/european-setbacks-minimum-distance-between-wind-turbines-and-habitations/>
6. <http://www.publications.parliament.uk/pa/ld201011/ldbills/017/11017.1-i.html>
7. http://www.caw.ca/assets/pdf/Turbine_Safety_Report.pdf
8. Rogers J, Slegers N, Costello M. (2011) A method for defining wind turbine setback standards. Wind energy 10.1002/we.468

2.2.2 Informative

None

2.3 DEFINITIONS

Definition	Description
Setback	The minimum distance between a wind turbine and boundary line/dwelling/road/infrastructure/servitude etc.
Flicker	Effect caused when rotating wind turbine blades periodically cast shadows
Tip Height	The total height of the wind turbine ie. Hub height plus half rotor diameter (see Figure1)

CONTROLLED DISCLOSURE

When downloaded from the EDMS, this document is uncontrolled and the responsibility rests with the user to ensure it is in line with the authorised version on the system.

2.3.1 Disclosure Classification

Controlled disclosure: controlled disclosure to external parties (either enforced by law, or discretionary).

2.4 ABBREVIATIONS

Abbreviation	Description
None	

2.5 ROLES AND RESPONSIBILITIES

All personnel involved in the positioning wind turbines, concentrated solar plants and photovoltaic plants near power lines/substations must follow the setbacks outlined in this guideline.

2.6 PROCESS FOR MONITORING

Approval by Eskom in writing.

2.7 RELATED/SUPPORTING DOCUMENTS

None

3. DOCUMENT CONTENT

3.1 INTERNATIONAL SETBACK COMPARISON

Wind Turbine setbacks employed by various countries were considered. It was found that setbacks were determined for various reasons that include noise, flicker, turbine blade failure and wind effects. The distances (setbacks) varied based on these factors and were influenced by the type of infrastructure

Wind turbine setbacks varied for roads, power lines, dwellings, buildings and property and it was noted that the largest setbacks were employed for reasons of noise and flicker related issues [1-7]. Very few countries specified setbacks for power lines.

The literature survey [1-7], yielded information about studies and experiments were conducted to determine the distance that a broken fragment from a wind turbine might be thrown. Even though of low probability of hitting a power line [5.0×10^{-5}]^[8], the distances recorded were significant [750m]^[8]

Setbacks were thus introduced to prevent any damage to Eskom infrastructure.

CONTROLLED DISCLOSURE

When downloaded from the EDMS, this document is uncontrolled and the responsibility rests with the user to ensure it is in line with the authorised version on the system.

Wind turbines may also cause changes in wind patterns with turbulent effects behind the hub. These factors dictate the wind turbine setbacks specified in this document.

Concentrated solar plants and photovoltaic plants also can limit access into the substation for power lines of all voltages. A setback distance must therefore be employed to prevent the substation from being boxed in by these generation plants. These setback distances are specified in this document.

3.2 ESKOM REQUIRED SETBACKS

- Eskom requires a setback distance of 3 times the tip height of the wind turbine from the edge of the closest Eskom servitude (including vacant servitudes) for transmission lines.
- Eskom requires a setback distance of 1 times the tip height of the wind turbine from the edge of the closest Eskom servitude (including vacant servitudes) for distribution Lines.
- Eskom must be informed of any proposed wind turbine, concentrated solar plants and photovoltaic activity within a 5 km radius of a substation. No wind turbine structure shall be built within a 2 km radius of the closest point of the substation. Where concentrated solar plants and photovoltaic structures fall within a 2 km radius of the closest point of a substation, Eskom should be informed in writing during the planning phase of the construction of such plant or structure.
- Applicants must show that Eskom radio telecommunication systems (mainly microwave systems) will not be affected in any way by wind turbines.

CONTROLLED DISCLOSURE

When downloaded from the EDMS, this document is uncontrolled and the responsibility rests with the user to ensure it is in line with the authorised version on the system.

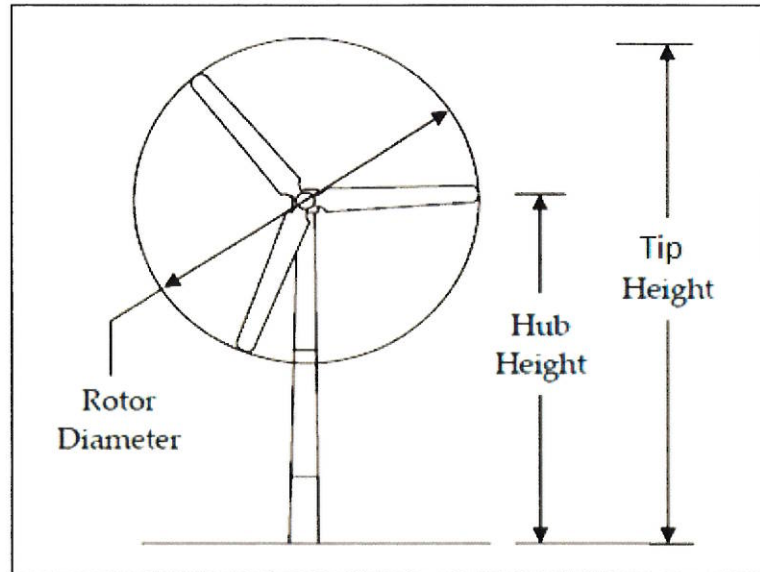

Figure 1: Horizontal Axis Wind Turbine ^[2]

4. AUTHORISATION

This document has been seen and accepted by:

Name & Surname	Designation
V Naidoo	Chief Engineer
Dr P H Pretorius	Electrical Specialist
J Geeringh	Snr Consultant Environ Mngt
B Haridass	Snr Consultant Engineer
R A Vajeth	Acting Snr Manager (Lines)

5. REVISIONS

Date	Rev.	Compiler	Remarks
November 2013	0	J W Chetty	First Publication - No renewable energy generation plant setback specification in existence

CONTROLLED DISCLOSURE

When downloaded from the EDMS, this document is uncontrolled and the responsibility rests with the user to ensure it is in line with the authorised version on the system.

6. DEVELOPMENT TEAM

The following people were involved in the development of this document:

Jonathan W Chetty (Mechanical Engineer)

Vivendhra Naidoo (Chief Engineer)

Dr Pieter H Pretorius (Electrical Specialist)

John Geeringh (Snr Consultant Environ Mngt)

Bharat Haridass (Snr Consultant Engineer)

Riaz A Vajeth (Acting Snr Manager (Lines))

CONTROLLED DISCLOSURE

When downloaded from the EDMS, this document is uncontrolled and the responsibility rests with the user to ensure it is in line with the authorised version on the system.

Eskom requirements for work at or near Eskom infrastructure.

1. Eskom's rights and services must be acknowledged and respected at all times.
2. Eskom shall at all times retain unobstructed access to and egress from its servitudes.
3. Eskom's consent does not relieve the developer from obtaining the necessary statutory, land owner or municipal approvals.
4. Any cost incurred by Eskom as a result of non-compliance to any relevant environmental legislation will be charged to the developer.
5. If Eskom has to incur any expenditure in order to comply with statutory clearances or other regulations as a result of the developer's activities or because of the presence of his equipment or installation within the servitude restriction area, the developer shall pay such costs to Eskom on demand.
6. The use of explosives of any type within 500 metres of Eskom's services shall only occur with Eskom's previous written permission. If such permission is granted the developer must give at least fourteen working days prior notice of the commencement of blasting. This allows time for arrangements to be made for supervision and/or precautionary instructions to be issued in terms of the blasting process. It is advisable to make application separately in this regard.
7. Changes in ground level may not infringe statutory ground to conductor clearances or statutory visibility clearances. After any changes in ground level, the surface shall be rehabilitated and stabilised so as to prevent erosion. The measures taken shall be to Eskom's satisfaction.
8. Eskom shall not be liable for the death of or injury to any person or for the loss of or damage to any property whether as a result of the encroachment or of the use of the servitude area by the developer, his/her agent, contractors, employees, successors in title, and assignees. The developer indemnifies Eskom against loss, claims or damages including claims pertaining to consequential damages by third parties and whether as a result of damage to or interruption of or interference with Eskom's services or apparatus or otherwise. Eskom will not be held responsible for damage to the developer's equipment.
9. No mechanical equipment, including mechanical excavators or high lifting machinery, shall be used in the vicinity of Eskom's apparatus and/or services, without prior written permission having been granted by Eskom. If such permission is granted the developer must give at least seven working days' notice prior to the commencement of work. This allows time for arrangements to be made for supervision and/or precautionary instructions to be issued by the relevant Eskom Manager

Note: Where and electrical outage is required, at least fourteen work days are required to arrange it.

10. Eskom's rights and duties in the servitude shall be accepted as having prior right at all times and shall not be obstructed or interfered with.
11. Under no circumstances shall rubble, earth or other material be dumped within the servitude restriction area. The developer shall maintain the area concerned to Eskom's satisfaction. The developer shall be liable to Eskom for the cost of any remedial action which has to be carried out by Eskom.
12. The clearances between Eskom's live electrical equipment and the proposed construction work shall be observed as stipulated by *Regulation 15 of the Electrical Machinery Regulations of the Occupational Health and Safety Act, 1993 (Act 85 of 1993)*.
13. Equipment shall be regarded electrically live and therefore dangerous at all times.
14. In spite of the restrictions stipulated by Regulation 15 of the Electrical Machinery Regulations of the Occupational Health and Safety Act, 1993 (Act 85 of 1993), as an additional safety precaution, Eskom will not approve the erection of houses, or structures occupied or frequented by human beings, under the power lines or within the servitude restriction area.
15. Eskom may stipulate any additional requirements to highlight any possible exposure to Customers or Public to coming into contact or be exposed to any dangers of Eskom plant.
16. It is required of the developer to familiarise himself with all safety hazards related to Electrical plant.
17. Any third party servitudes encroaching on Eskom servitudes shall be registered against Eskom's title deed at the developer's own cost. If such a servitude is brought into being, its existence should be endorsed on the Eskom servitude deed concerned, while the third party's servitude deed must also include the rights of the affected Eskom servitude.

John Geeringh (Pr Sci Nat)

Senior Consultant Environmental Management
Eskom GC: Land Development

sivest_PPP

From: John Geeringh <GeerinJH@eskom.co.za>
Sent: 15 November 2018 02:53 PM
To: sivest_PPP
Cc: Andrea Gibb; Shivani Naidoo; 'Veronique Fyfe'
Subject: RE: Rondekop Wind Energy Facility near Sutherland: DSR Comment Period Starting
Attachments: Eskom requirements for work in or near Eskom servitudes WIND (3).doc;
Renewable Energy Generation Plant Setbacks to Eskom Infrastructure - Signed.pdf

Please find attached Eskom requirements for works at or near Eskom infrastructure and servitudes. Please send me KMZ files of the affected properties, proposed layouts and proposed grid connection.

Kind regards

John Geeringh (Pr Sci Nat)
Senior Consultant Environmental Management
Group Capital Division: Land Development and Management
Megawatt Park, D1Y42, Maxwell Drive, Sunninghill, Sandton.
P O Box 1091, Johannesburg, 2000.
Tel: 011 516 7233
Cell: 083 632 7663
Fax: 086 661 4064
E-mail: john.geeringh@eskom.co.za



From: sivest_PPP [mailto:sivest_ppp@sivest.co.za]
Sent: 14 November 2018 03:52 PM
Cc: Andrea Gibb; Shivani Naidoo; 'Veronique Fyfe'
Subject: Rondekop Wind Energy Facility near Sutherland: DSR Comment Period Starting

Dear Interested and/or Affected Party

ENVIRONMENTAL IMPACT ASSESSMENT PROCESS (EIA) FOR THE PROPOSED 325MW RONDEKOP WIND ENERGY FACILITY BETWEEN MATJIESFONTEIN AND SUTHERLAND IN THE NORTHERN CAPE PROVINCE

Please note that SiVEST SA (Pty) Ltd has been appointed by Rondekop Wind Farm (Pty) Ltd as the Environmental Assessment Practitioner (EAP) for the abovementioned project.

We would like to take this opportunity to inform you that, in accordance with the National Environmental Management Act, 1998 (Act No. 107 of 1998) (NEMA) (as amended), the Draft Scoping Report (DSR) for the above mentioned project will be available for public comment and review as from **Wednesday 14 November 2018 to Friday 14 December 2018** (end of business day). Should you wish to receive an electronic copy of the DSR (on CD) please forward your request in writing to us. Hard copies of the DSR can be reviewed at the following public place:

VENUE	STREET ADDRESS	HOURS	CONTACT NO
-------	----------------	-------	------------

The report can also be downloaded from <http://data.g7energies.com/eia/rondekop> during the review period.

Attached is an English and Afrikaans letter notifying of the review period.

Kind Regards

Shivani Naidoo

Environmental Consultant

SiVEST Environmental Division



SiVEST is a Level 3 BBBEE Contributor

D +27 11 798 0600 | **T** +27 11 798 0600 **W** www.sivest.co.za

Engineering Consulting | Project Management | Environmental Consulting | Town & Regional Planning | Management Systems Consulting

Durban | Johannesburg | Pretoria | Pietermaritzburg | Richards Bay | Port Louis (Mauritius)

Disclaimer

The information contained in this communication from the sender is confidential. It is intended solely for use by the recipient and others authorized to receive it. If you are not the recipient, you are hereby notified that any disclosure, copying, distribution or taking action in relation of the contents of this information is strictly prohibited and may be unlawful.

This email has been scanned for viruses and malware, and automatically archived by **Mimecast SA (Pty) Ltd**, an innovator in Software as a Service (SaaS) for business. **Mimecast Unified Email Management ??? (UEM)** offers email continuity, security, archiving and compliance with all current legislation. To find out more, [contact Mimecast](#).

NB: This Email and its contents are subject to the Eskom Holdings SOC Ltd EMAIL LEGAL NOTICE which can be viewed at http://www.eskom.co.za/Pages/Email_Legal_Spam_Disclaimer.aspx

sivest_PPP

From: Ferdi Smit <ferdis@atns.co.za>
Sent: 19 November 2018 09:17 AM
To: sivest_PPP
Cc: Raoul Bester
Subject: RE: Rondekop Wind Energy Facility near Sutherland: DSR Comment Period Starting

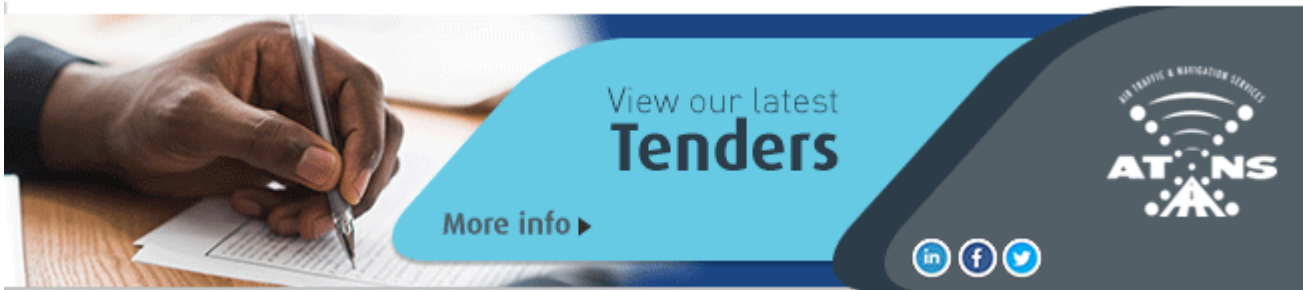

Hi Shivani

Do you perhaps have the position (LAT/LONG co-ordinates) of all the proposed wind turbines in a “kml” format (for use in Google Earth) or else maybe in an Excel format?

I would also require the Hub height, as well as the max height above ground of the blade tip.

There are quite a few new windfarm developments planned for the Sutherland/ Matjiesfontein area, so I would like to plot them in order to properly evaluate the impact on our radar systems – if any.

Regards

Ferdi Smit
Specialist: Radar CT | COO - Operations Technology
FACT

T: +2721 937 1151 • F: +27 021 937 1174 • C: +2782 553 3923
E: ferdis@atns.co.za • W: www.atns.com



[View Disclaimer](#)

From: sivest_PPP <sivest_ppp@sivest.co.za>
Sent: 14 November 2018 05:40 PM
To: Andrea Gibb <AndreaG@sivest.co.za>; Shivani Naidoo <ShivaniN@sivest.co.za>; 'Veronique Fyfe' <veronique@g7energie.com>
Cc: 'Henning Myburg' <henning@agrink.co.za>; Obstacle Evaluators <ObstacleEvaluators@atns.co.za>; Johanna Morobane <JohannaMorobane@atns.co.za>

<phillipd@atns.co.za>; Ferdi Smit <ferdis@atns.co.za>; 'Candice Stevens' <advocacy@birdlife.org.za>; 'Samantha Ralston-Pat Mans' <jacolinema@daff.gov.za>; 'Paul Avenant' <paula@daff.gov.za>; 'Colonel Loy de Jager' <loydejager@hotmail.com>; 'M' <mrabothata@environment.gov.za>; 'Seoka Lekota' <slekota@environment.gov.za>; 'Ntsundeni Ravhogoni' <Ntsundeni.Ravh <plenyibi@ncpg.gov.za>; 'Ester Makungo' <makungoe@dws.gov.za>; 'Moses Mahunonyane' <MahunonyaneM@dws.gov.za>; 'Andre Crous' <andre.crous@eskom.co.za>; 'John Geeringh' <GeerinJH@eskom.co.za>; 'Lourens Leeuwner' <lourensl@ewt.or <a.gibbons@karoohoogland.gov.za>; 'Jannie Loubser' <janniel@namakwa-dm.gov.za>; 'Gert Steenkamp' <gsteenkamp@ncpg <roelofse.j@vodamail.co.za>; 'Thulani Mthombeni' <tmtho@webmail.co.za>; 'Lizell Stroh' <strohl@caa.co.za>; 'Nicole Abrah Ngwenya' <Mlungisi.Ngwenya@weathersa.co.za>; 'Frank Creese' <creesef@sentech.co.za>; 'Alisha Pretorius' <pretoriusa@se <KoegelenbergJ@sentech.co.za>; 'Ramatholo Sefako' <rrs@saa.ac.za>; 'Danie Erasmus' <radiotech@saps.org.za>; 'Adriaan Thurling' <Thurling@telkom.co.za>; 'Heleen van den Heever' <vdheevhd@telkom.co.za>; 'Amanda Bester' <WayleaCR@telko <morgan.griffiths@wessa.co.za>

Subject: Rondekop Wind Energy Facility near Sutherland: DSR Comment Period Starting

Dear Stakeholder

ENVIRONMENTAL IMPACT ASSESSMENT PROCESS (EIA) FOR THE PROPOSED 325MW RONDEKOP WIND ENERGY AND SUTHERLAND IN THE NORTHERN CAPE PROVINCE

SiVEST is in the process of undertaking the Environmental Impact Assessment (EIA) for the proposed development of the Rondekop Wind Energy Facility near Sutherland in the Northern Cape.

We would like to take this opportunity to inform you that, in accordance with the National Environmental Management Act, 1998 the Draft Scoping Report (DSR) for the above mentioned wind project will be available for public comment and review as from **the Friday 14th of December 2018** (before end of business day).

The DSRs as well as the accompanying appendices are available online (<http://data.g7energies.com/eia/rondekop>) and an electronic public participation office (EPP) will be established. We kindly request that you submit your comments to the Public Participation Office at the below details, on or before Friday the 14th of December 2018 (before end of business day). SiVEST will forward any comments received after the public comment and review period directly to the relevant case officer (DEA).

Should you have any questions or queries please do not hesitate to contact us at:

Hlengiwe Ntuli

PO Box 2921, RIVONIA, 2128

Phone: (011) 798 0600

E-mail: hlengiwen@sivest.co.za

Fax: (011) 803 7272

Kind Regards

Shivani Naidoo

Environmental Consultant

SiVEST Environmental Division



SiVEST is a Level 3 BBBEE Contributor

D +27 11 798 0600 | **T** +27 11 798 0600 **W** www.sivest.co.za

Engineering Consulting | Project Management | Environmental Consulting | Town & Regional Planning | Management Systems Consulting
Durban | Johannesburg | Pretoria | Pietermaritzburg | Richards Bay | Port Louis (Mauritius)

Disclaimer

The information contained in this communication from the sender is confidential. It is intended solely for use by the recipient and others authorized by the recipient, you are hereby notified that any disclosure, copying, distribution or taking action in relation of the contents of this information is

This email has been scanned for viruses and malware, and automatically archived by **Mimecast SA (Pty) Ltd**, an innovator in Software and **Unified Email Management ??? (UEM)** offers email continuity, security, archiving and compliance with all current legislation. To find out

The contents of this email are confidential and intended for the named recipient(s) only. The information may be privileged or otherwise protected from disclosure. The views expressed in this message are those of the sender, unless otherwise stated to be. This email is also subject to copyright. No part hereof may be reproduced, adapted, transmitted, or used in any way without the written consent of ATNS SOC Limited. Please do not hesitate to contact us immediately should you have any doubts regarding the authenticity of an email purportedly sent by the sender.



environmental affairs

Department:
Environmental Affairs
REPUBLIC OF SOUTH AFRICA

Private Bag X 447· PRETORIA · 0001· Environment House· 473 Steve Biko Road · PRETORIA

Ref: 14/12/16/N2

Enquiries: Ms Azrah Essop

Tel: 012 399 8529 Email: EIAAdmin@environment.gov.za

Dear Sir/Madam

SUBMISSION OF DOCUMENTS TO THE DEPARTMENT IN TERMS OF THE NEMA EIA REGULATIONS, 2014, AS AMENDED AND CLOSURE OF THE DEPARTMENT.

Kindly take note of the following:

Please be herewith informed that in terms of Regulation 3(2) of the Regulations, 2014, as amended, it is stated that **"for any action contemplated in terms of these Regulations for which a timeframe is prescribed, the period of 15 December 2018 to 5 January 2019 must be excluded in the reckoning of days."**

The last day for receiving any documentation contemplated in terms of the EIA Regulations, 2014, as amended will be on **14 December 2018**. All documentation delivered to the physical address of this Department must be delivered during the official Departmental Office Hours which is visible on the Departmental gate. EIA related documents (includes application forms, reports or any EIA related submissions) that are faxed; emailed; delivered to Security or placed in the Departmental Tender Box will not be accepted.

However, should any documents be received during the period mentioned above, it will be regarded as having been received in terms of Regulation 3(1) of the Regulations, 2014, as amended on **07 January 2019**.

Further please be herewith informed that the last day that the Offices of the Department of Environmental Affairs will be open to the public is on **21 December 2018 until 10h00** in the morning, where after it will be closed and will re-open to the public on **02 January 2019 at 7h00**.

Yours faithfully

Mr Sabelo Malaza
Chief Director, Integrated Environmental Authorisations
Department of Environmental Affairs

Date: *19/11/2018*



environmental affairs

Department:
Environmental Affairs
REPUBLIC OF SOUTH AFRICA

Private Bag X 447· PRETORIA · 0001· Environment House · 473 Steve Biko Road, Arcadia · PRETORIA

DEA Reference: 14/12/16/3/3/2/1115

Enquiries: Azrah Essop

Tel: 012 399 8529 E-mail: AEssop@environment.gov.za

Andrea Gibb
SiVEST SA (Pty) Ltd
P O Box 2921
RIVONIA
2128

Tel: 011 798 0638
Email: andreag@sivest.co.za

PER EMAIL / MAIL

Dear Sir/Madam

ACKNOWLEDGEMENT OF RECEIPT OF THE NEW APPLICATION FOR ENVIRONMENTAL AUTHORISATION (ENVIRONMENTAL IMPACT ASSESSMENT PROCESS) AND SCOPING REPORT FOR THE PROPOSED CONSTRUCTION OF THE 325MW RONDEKOP WIND ENERGY FACILITY BETWEEN MATJIESFONTEIN AND SUTHERLAND IN THE NORTHERN CAPE PROVINCE

The Department confirms having received the Application and draft Scoping Report for Environmental Authorisation for the abovementioned project on 14 November 2018. We further confirm that you have submitted these documents to comply with the National Environmental Management Act, 1998 (Act No. 107 of 1998) Environmental Impact Assessment Regulations, 2014 published under Government Notice R982 in Government Gazette No. 38282 dated 04 December 2014, as amended ('the EIA Regulations, 2014').

Please take note of Regulation 40(3) of the EIA Regulations, 2014 which states that potential Interested & Affected Parties, including the Competent Authority, may be provided with an opportunity to comment on reports and plans contemplated in Regulation 40(1) of the EIA Regulations, 2014, prior to the submission of an application but must be provided an opportunity to comment on such reports once an application has been submitted to the Competent Authority.

Note that in terms of Regulation 45 of the EIA Regulations, 2014 this application will lapse if the applicant fails to meet any of the time-frames prescribed in terms of these Regulations, unless an extension has been granted by the Department in terms of Regulation 3(7) of the EIA Regulations, 2014.

All documentation delivered to the physical address contained in this form must be delivered during the official Departmental Office Hours which is visible on the Departmental gate. EIA related documents (includes application forms, reports or any EIA related submissions) that are faxed; emailed; delivered to Security or placed in the Departmental Tender Box will not be accepted.

You are hereby reminded of Section 24F of the National Environmental Management Act, 1998 (Act No. 107 of 1998), as amended, that no activity may commence prior to an Environmental Authorisation being granted by the Department.

Kindly quote the abovementioned reference number in any future correspondence in respect of the application.

Yours sincerely



Mr Sabelo Malaza

Chief Director: Integrated Environmental Authorisations

Department of Environmental Affairs

Letter signed by: Ms Azrah Essop

Designation: Environmental Officer: EIA Coordination, Strategic Planning and Support

Date: 19 November 2018

CC:	Dr Kilian Hagemann	Rondekop Wind Farm (Pty) Ltd	Email: rondkop@7energies.com
	Thulani Mthombeni	Northern Cape Department of Environment and Nature Conservation (DENC)	Email: tmthombeni@ncpg.gov.za
	Allistar Gibbons	Karoo Hooiland Local Municipality	Email: a.gibbons@karoohooiland.gov.za

sivest_PPP

From: Ferdi Smit <ferdis@atns.co.za>
Sent: 21 November 2018 01:56 PM
To: sivest_PPP; Andrea Gibb; Shivani Naidoo; 'Veronique Fyfe'
Cc: Obstacle Evaluators; Phillip De Lange
Subject: RE: Rondekop Wind Energy Facility near Sutherland: DSR Comment Period Starting
Attachments: Rondekop Wind Energy Facility near Sutherland: DSR Comment Period Starting



Hi Shivani

Please note that all wind farm applications have to be submitted to a specific department within ATNS. They will ensure the correct order to determine the impact of the proposed wind farm on any of our equipment – if any.

“Wind clients require a CNS impact assessment report obtained from ATNS as published on the SACAA website. All applications must be forwarded to the Obstacle Evaluation department.”

Please forward all queries to: ObstacleEvaluators@atns.co.za

Regards

Ferdi Smit

Specialist: Radar CT | COO - Operations Technology
FACT

T: +2721 937 1151 • F: +27 021 937 1174 • C: +2782 553 3923
E: ferdis@atns.co.za • W: www.atns.com

From: sivest_PPP <sivest_ppp@sivest.co.za>
Sent: 14 November 2018 03:52 PM
Cc: Andrea Gibb <AndreaG@sivest.co.za>; Shivani Naidoo <ShivaniN@sivest.co.za>; 'Veronique Fyfe' <veronique@g7energies.com>
Subject: Rondekop Wind Energy Facility near Sutherland: DSR Comment Period Starting

Dear Interested and/or Affected Party

ENVIRONMENTAL IMPACT ASSESSMENT PROCESS (EIA) FOR THE PROPOSED 325MW RONDEKOP WIND ENERGY FACILITY NEAR SUTHERLAND IN THE NORTHERN CAPE PROVINCE

Please note that SiVEST SA (Pty) Ltd has been appointed by Rondekop Wind Farm (Pty) Ltd as the Environmental Assessment consultant for this project.

We would like to take this opportunity to inform you that, in accordance with the National Environmental Management Act, 1998 the Draft Scoping Report (DSR) for the above mentioned project will be available for public comment and review as from **Wednesday, 27 December 2018** (end of business day). Should you wish to receive an electronic copy of the DSR (on CD) please forward your request to info@atns.com. The DSR can be reviewed at the following public place:

VENUE	STREET ADDRESS	HOURS	CONTACT NO
Sutherland Library	Sarel Cillier Street, Sutherland	Mondays- Fridays 08h00 – 13h00 14h00 – 17h00	023 571 1429

The report can also be downloaded from <http://data.g7energies.com/eia/rondekop> during the review period.

Attached is an English and Afrikaans letter notifying of the review period.

Kind Regards
Shivani Naidoo
 Environmental Consultant
SiVEST Environmental Division



SiVEST is a Level 3 BBBEE Contributor

D +27 11 798 0600 | **T** +27 11 798 0600 **W** www.sivest.co.za

Engineering Consulting | Project Management | Environmental Consulting | Town & Regional Planning | Management Systems Consulting
 Durban | Johannesburg | Pretoria | Pietermaritzburg | Richards Bay | Port Louis (Mauritius)

Disclaimer

The information contained in this communication from the sender is confidential. It is intended solely for use by the recipient and others authorized to receive it. If you are not the intended recipient, you are hereby notified that any disclosure, copying, distribution or taking action in relation of the contents of this information is strictly prohibited.

This email has been scanned for viruses and malware, and automatically archived by **Mimecast SA (Pty) Ltd**, an innovator in Software as a Service. **Unified Email Management (UEM)** offers email continuity, security, archiving and compliance with all current legislation. To find out more, visit www.mimecast.com



[View Disclaimer](#)

The contents of this email are confidential and intended for the named recipient(s) only. The information may be privileged or otherwise protected from disclosure. The views expressed in this message are those of the sender, unless otherwise stated to be. This email is also subject to copyright. No part hereof may be reproduced, adapted, transmitted, or used in any way without the written consent of ATNS SOC Limited. Please do not hesitate to contact us immediately should you have any doubts regarding the authenticity of an email purportedly sent by the sender.

Ms. Shivani Naidoo

Environmental Consultant

Sivest Environmental Division (Pty) Ltd

email:sivest_ppp@sivest.co.za

Date: 21 November 2018

Dear Ms. Naidoo

RE: EIA FOR THE PROPOSED 325MW RONDEKO WIND ENERGY FACILITY

This letter is in response to your invitation to participate in the EIA process for the above project, that was received by our office on 9 November 2018.

Based only on the distance from the location of the proposed WEF to the nearest SKA radio telescope, we do not anticipate any negative impact on the SKA and have no objection to the project at this current stage. However, we advise that you also contact the South African Astronomy Observatory as there may be risks to the South African Large Telescope in the Sutherland.

We would also like to advise you to ensure that the electromagnetic emissions of the facility do not exceed the limits as prescribed in the latest edition of the CISPR standards. In addition, all wireless communication should comply with the Regulations on the Protection of the Karoo Central Astronomy Advantage Area as published.

Regards,



Mr Selaelo Matlhane
Spectrum & Telecommunication Manager
South African Radio Astronomy Observatory (SARAO)
Tel: 011 442 2434
Email: smatlhane@ska.ac.za

www.ska.ac.za

The South African Radio Astronomy Observatory (SARAO) is a National Facility managed by the National Research Foundation and incorporates all national radio astronomy telescopes and programmes. SARAO is responsible for implementing the Square Kilometre Array (SKA) in South Africa.

Rondekop Wind Energy

Adobe Sign Document History

11/26/2018



Created:	11/26/2018
By:	Musa Baloye (mbaloye@ska.ac.za)
Status:	Signed
Transaction ID:	CBJCHBCAABAA3nkrImKC-uNIN5rwcHqny0tWkGEuNOuB

"Rondekop Wind Energy" History

-  Document created by Musa Baloye (mbaloye@ska.ac.za)
11/26/2018 - 1:09:45 AM PST - IP address: 196.24.39.242
-  Document emailed to Selaelo Matlhane (smatlhane@ska.ac.za) for signature
11/26/2018 - 1:10:18 AM PST
-  Document viewed by Selaelo Matlhane (smatlhane@ska.ac.za)
11/26/2018 - 1:16:40 AM PST - IP address: 66.249.93.208
-  Document e-signed by Selaelo Matlhane (smatlhane@ska.ac.za)
Signature Date: 11/26/2018 - 1:17:04 AM PST - Time Source: server- IP address: 196.24.39.242
-  Signed document emailed to Selaelo Matlhane (smatlhane@ska.ac.za) and Musa Baloye (mbaloye@ska.ac.za)
11/26/2018 - 1:17:04 AM PST



Jacobus Treurnich <jacobus@g7energies.com>

RE: Wind Farm application for Rondekop and Kudusberg

1 message

Obstacles <Obstacles@caa.co.za>

22 November 2018 at 10:09

To: Jacobus Treurnich <jacobus@g7energies.com>, Obstacles <Obstacles@caa.co.za>

Good day Kobus, confirmation on receipt of your applications to the above mentioned projects.

Kind regards

Lizell Stroh
Obstacle Inspector
PANS-OPS Section
Air Navigation Services Department
Tel: 011 545 1232 | 083 461 6660 / Email: strohl@caa.co.za | www.caa.co.za
Follow us on

-----Original Message-----

From: Jacobus Treurnich [mailto:jacobus@g7energies.com]
Sent: 26 October 2018 10:36 AM
To: Obstacles
Subject: Wind Farm application

The attached file contains data that was entered into a form. It is not the form itself.

The recipient of this data file should save it locally with a unique name. Adobe Acrobat Professional 7 or later can process this data by importing it back into the blank form or creating a spreadsheet from several data files. See Help in Adobe Acrobat Professional 7 or later for more details.

Email secured by Check Point

This email has been scanned for email related threats and delivered safely by Mimecast.
For more information please visit <http://www.mimecast.com>



agriculture, forestry & fisheries

Department:
Agriculture, Forestry and Fisheries
REPUBLIC OF SOUTH AFRICA

Directorate: Forestry Management (Other Regions)
P.O. Box 2782, Upington, 8800, Tel 054 338 5909, Fax 054 334 0030

Enquiries: J Mans
E-mail: JacolineMa@daff.gov.za
Date: 27 November 2018
Ref: 40.8.14.2/NC/137

SIVEST
P.O. Box 2921
Rivonia
2128

ATTENTION: Shivani Naidoo (hlengiwen@sivest.co.za)

RE: COMMENTS ON DRAFT SCOPING REPORT FOR THE PROPOSED 325 MW RONDEKOP WIND ENERGY FACILITY BETWEEN MATJIESFONTEIN AND SUTHERLAND, KAROO HOOGLAND LOCAL MUNICIPALITY, NORTHERN CAPE PROVINCE (DEA REF: NOT SUPPLIED)

1. DEPARTMENTAL MANDATE

The Directorate: Forestry Management (Other Regions) in the Department of Agriculture, Forestry and Fisheries (DAFF) is responsible for administration of the **National Forests Act, Act 84 of 1998 (NFA)** and **the National Veld and Forest Fires Act, Act 101 of 1998** as amended. The developer must take note of the following sections of the NFA:

- 1.1 Section 12(1): "The Minister may declare-
- (a) a particular tree,
 - (b) a particular group of trees,
 - (c) a particular woodland; or
 - (d) trees belonging to a particular species, to be a protected tree, group of trees, woodland or species.
- 1.2 Section 15(1): "No person may-
- (a) Cut, disturb, damage or destroy any protected tree; or
 - (b) Possess, collect, remove, transport, export, purchase, sell, donate or in any other manner acquire or dispose of any protected tree, or any forest product derived from a protected tree, except-
 - (i) under a license granted by the Minister; or
 - (ii) in terms of an exemption from the provision of this subsection published by the Minister in the Gazette on the advice of the Council."
- 1.3 "Any person who contravenes the prohibition on-
- (i) The cutting, disturbance, damage or destruction of temporarily protected trees or groups of trees referred to in section 14(2) or protected trees referred to in section 15(1)(a); or

- (ii) The possession, collection, removal, transport, export, purchase or sale of temporarily protected trees or groups of trees referred to in section 14(2) or protected trees referred to in section 15(1)(b), or any forest product derived from a temporarily protected tree, group of trees or protected tree, is guilty of a first category offence.
- 1.4 Section 58 (1): "Any person who is guilty of a first category offence referred to in sections 62 and 63 may be sentenced to a fine or imprisonment for a period of up to three years, or to both a fine and such imprisonment."
- 1.5 The list of protected tree species under section 12(1) (d) of the National Forests Act, 1998 (Act No. 84 of 1998) is published annually; the most recent publication was in GN536 of 7 September 2018.

2. COMMENTS ON DRAFT SCOPING REPORT AND TERRESTRIAL ECOLOGY SCOPING REPORT

- 2.1 The affected vegetation types are Koedoesberg-Moordenaars Karoo and Central Mountain Shale Renosterveld. The study site falls in Critical Biodiversity Area (CBA) 1 and 2 and most of the northern half is mapped as an Ecological Support Area (ESA), therefore comments must be obtained from the provincial Department of Environment and Nature Conservation (DENC).
- 2.2 The report confirmed that only one NFA listed protected tree species has a geographical distribution in close vicinity to the study area, namely *Podocarpus latifolius*, but this species does not occur near to the site. The report stated that no protected tree species were found or are likely to occur in the site. The only tree species associated with the riparian vegetation is *Vachellia karroo*, which is indigenous, but not protected. The proposed development is therefore unlikely to have any impacts on NFA listed protected tree species and therefore this Department has no objection and no further comments about the proposed development.
- 2.3 The developer must note that trees with active bird nests may not be removed or disturbed without a valid Fauna Permit from Nature Conservation under the Northern Cape Nature Conservation Act, Act 9 of 2009. It was not mentioned in the report.

Kind Regards,

J. Mans
Jacoline Mans

Chief Forester: NFA Regulation
DATE: 27/11/2018

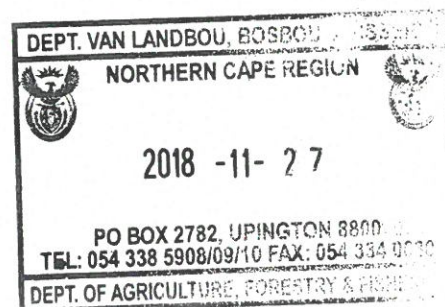

Hlengiwe Ntuli

From: JacolineMa <JacolineMa@daff.gov.za>
Sent: Tuesday, 27 November 2018 4:02 PM
To: Hlengiwe Ntuli
Subject: Proposed 325 MW Rondekop Wind Energy Facility, Sutherland
Attachments: 40.8.14.2-NC-137.pdf

Dear Mr. / Ms. Naidoo

Attached please find comments from the Department of Forestry on the above-mentioned proposed development. Thank you for notifying this Department.

Kind Regards,

Jacoline Mans

Chief Forester: NFA Regulation
Directorate: Forestry Management (Other Regions)
Department of Agriculture, Forestry and Fisheries
Tel (054) 338 5909; Cell 060 973 1660
Web: www.daff.gov.za
E-mail: JacolineMa@daff.gov.za



agriculture,
forestry & fisheries

Department:
Agriculture, Forestry and Fisheries
REPUBLIC OF SOUTH AFRICA

Notice

The information contained in this e-mail may be confidential, legally privileged and protected by law. Access by the intended recipient only is authorised. If you are not the intended recipient, kindly notify the sender immediately. Unauthorised use, copying or dissemination hereof is strictly prohibited. Save for *bona fide* departmental purposes, the Department of Agriculture, Forestry and Fisheries does not accept responsibility for the contents or opinions expressed in this e-mail, nor does it warrant this communication to be free from errors, contamination, interference or interception.



Technology Division

Sender Technology Park (STP)
Octave Road, Honeydew,
Johannesburg

Private Bag X06,
Honeydew, 2040

Tel: +27 11 471 4400

Enquiries:

Motlhakes@sentech.co.za

6 December 2018

Rondekop Wind Energy Facility
SIVEST Environmental Division
529 Jorissen Street
Sunnyside, Pretoria
0002
South Africa
Email: Kerrys@sivest.co.za
Office Tel: +27. (0)11 798 0600

Attention: Kerry Schwartz

RE: PROPOSED RONDEKOP WIND ENERGY FACILITY

1. The above matter refers.
2. We wish to advise that SENTECH SOC Ltd ("SENTECH") has received an application from Rondekop Wind Energy Facility (Pty) Ltd ("the applicant"), which plans to construct a Wind Turbine Generator (WTG) energy facility as described in annexure 1 hereto, hereafter referred to as "the site", in accordance with the provisions of Section 29(1) (b) of the Electronic Communications Act no. 36 of 2005 ("the Act").
3. SENTECH has analyzed the information provided by the applicant in accordance with the provisions of Section 29(1) (c) of the Act, and specifically the location of the site and confirm that there would be limited degradation of SENTECH transmitted Terrestrial UHF/VHF Television (TV), and/or FM radio services in the planned deployment area, as indicated in annexure 1.
4. SENTECH hereby grants the applicant approval to proceed with the construction of its energy project at the site subject to the following terms and conditions:
 - 4.1 Due to the fact that the findings made by SENTECH are based on simulations and calculated on a theoretical model, using available data and assumptions where no data was provided, such findings may change at any time should any further information be made available to or come to SENTECH's attention;

SENTECH SOC Ltd Reg no: 1990/001791/30

Directors: Mr. M Mello (Chairperson), Mr. M Booï (CEO), Mr. S Mthethwa CA (SA) (CFO), Mr. T Leshope (COO), Ms. J Huntley, Mr. L Mtimde, Dr S Malinga, Ms T Malaka, Ms. M Manyama CA (SA), Ms. P Sibiya
Company Secretary: Adv. P Matsane

- 4.2 At any time after the approval, and during construction of the project, should any radio transmissions be affected by construction activities, SENTECH will give the applicant 7 (seven) day's written notice to remove the cause of the interference.
- 4.3 Under no circumstances whatsoever will SENTECH be liable to the applicant or any third party for any damages, loss or costs, of any nature whatsoever or howsoever arising, suffered as a consequence of the aforementioned request and the applicant fully indemnify SENTECH;
- 4.4 SENTECH prior written consent must first be obtained before any construction activities underneath, along, across or within close proximity to SENTECH infrastructure can begin and shall comply with the applicable SENTECH guidelines relating to clearances between equipment and the proposed construction activity. Furthermore, the applicant shall clearly adhere to, and ensure all installations shall be fully compliant with the Occupational Health and Safety Act No. 85 of 1993.
5. This approval is further subject to the submitted applications boundaries or structures listed in annexure 1 hereto, the materials used, as well as the size and positioning of structures declared in the application. If the services of SENTECH or its clients is in any way compromised by a deviation or change of this submission, the applicant shall be liable for all costs to re-establish, or relocate the services, and under no circumstances whatsoever will SENTECH be liable to the applicant or any other third party for any damages, loss or costs, of any nature whatsoever or howsoever arising, suffered as a consequence.
6. This approval is valid and applicable between SENTECH and the applicant only. It does not include any approval for any of the other electronic communication operators which have current co-sharing agreements to utilize SENTECH's radio masts.
7. Any additions, amendments, additional structures to be built, or any change to the energy farm boundaries, will require a new application to SENTECH.
8. The validity of this approval is for a period of 12 (twelve) months. If construction of the designed project commences after the expiry of the twelve month period, the application must be re-submitted to SENTECH for further evaluation and approval.
9. This approval does not imply any rights of access whatsoever to SENTECH property or use of SENTECH's access roads for construction or maintenance of the design project. Separate permission must be obtained from SENTECH in this regard. Furthermore, SENTECH reserves the right to claim damages in terms of Section 29 of the Act, for any loss or damages sustained as a result of damages to any of SENTECH's electronic broadcast and communications infrastructure.

SENTECH SOC Ltd Reg no: 1990/001791/30

Directors: Mr. M Mello (Chairperson), Mr. M Booi (CEO), Mr. S Mthethwa CA (SA) (CFO), Mr. T Leshope (COO), Ms. J Huntley, Mr. L Mtimde, Dr S Malinga, Ms T Malaka, Ms. M Manyama CA (SA), Ms. P Sibiya
Company Secretary: Adv. P Matsane

10. The applicant shall, in carrying out any work or project, take all the necessary precautions for the safety of SENTECH's employees, contractors, representatives and its property, including the radio transmitters and links on or near the site against damages as a result of construction of the applicant's energy project.
11. The applicant shall be liable for all and any direct and/or indirect, and/or consequential damages or injury that may be caused by the applicant, its contractors, subcontractors, employees, agents or representatives to any employee, contractor, representative or property of SENTECH including radio network transmitters and/or links or land which may have been disturbed shall be restored to the same condition in which it was before commencement of the construction of the energy project.
12. In no event will SENTECH, its employees, contractors, or representatives be liable to the applicant or any third party whatsoever for special, collateral, exemplary, direct, indirect, incidental, consequential or any other damages of any nature whatsoever or howsoever arising (including without limitation, loss of goodwill, loss of profits or revenues, loss of savings, loss of use, interruptions or noisiness, or injury) whether or not such damages or injury occurred prior or subsequent to, or are alleged as a result of any SENTECH radio network approved and/or not approved in terms of this letter, even if SENTECH has been advised of the possibility of such damages or injury.

All SENTECH rights are fully reserved. Regards.



Mr Serame Motlhake

Date: 06/12/2018

Manager: Broadcast Planning

SENTECH SOC Ltd Reg no: 1990/001791/30

Directors: Mr. M Mello (Chairperson), Mr. M Booi (CEO), Mr. S Mthethwa CA (SA) (CFO), Mr. T Leshope (COO), Ms. J Huntley, Mr. L Mtimde, Dr S Malinga, Ms T Malaka, Ms. M Manyama CA (SA), Ms. P Sibiya
Company Secretary: Adv. P Matsane

ANNEXURE 1

The planned 48 Rondekop Wind Turbine Generator's (WTG's) will be located east of the Kookfonteinberg in the Windheuwel area of the Northern Cape, according to the developer. The wind energy facility will be located ± 57.6 km north of the Matjiesfontein C12 transmitter station and ± 43.4 km due south from the town of Sutherland. The proposed area where the WTG's are planned to be build, is isolated from any settlements, except for scattered farms in the wider area.

Potential interferences on viewers would be very limited due to the geographical nature of the terrain, the location of the wind energy facility, combined with very low population density of the area.

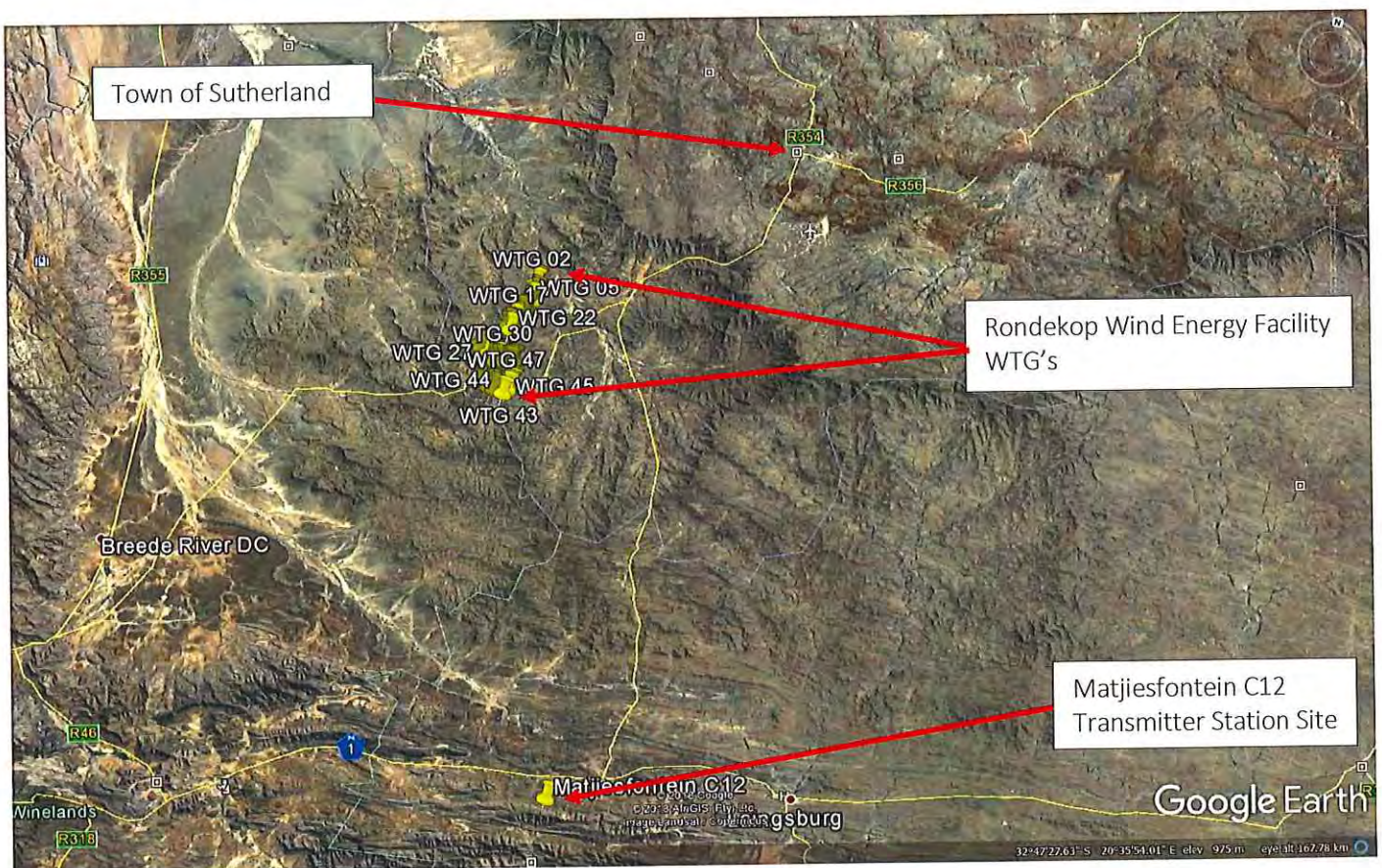

Map 1: Google Earth Map indicating the location of the Rondekop wind turbines in the Northern Cape.

SENTECH SOC Ltd Reg no: 1990/001791/30

Directors: Mr. M Mello (Chairperson), Mr. M Booi (CEO), Mr. S Mthethwa CA (SA) (CFO), Mr. T Leshope (COO), Ms. J Huntley, Mr. L Mtimde, Dr S Malinga, Ms T Malaka, Ms. M Manyama CA (SA), Ms. P Sibiya
Company Secretary: Adv. P Matsane

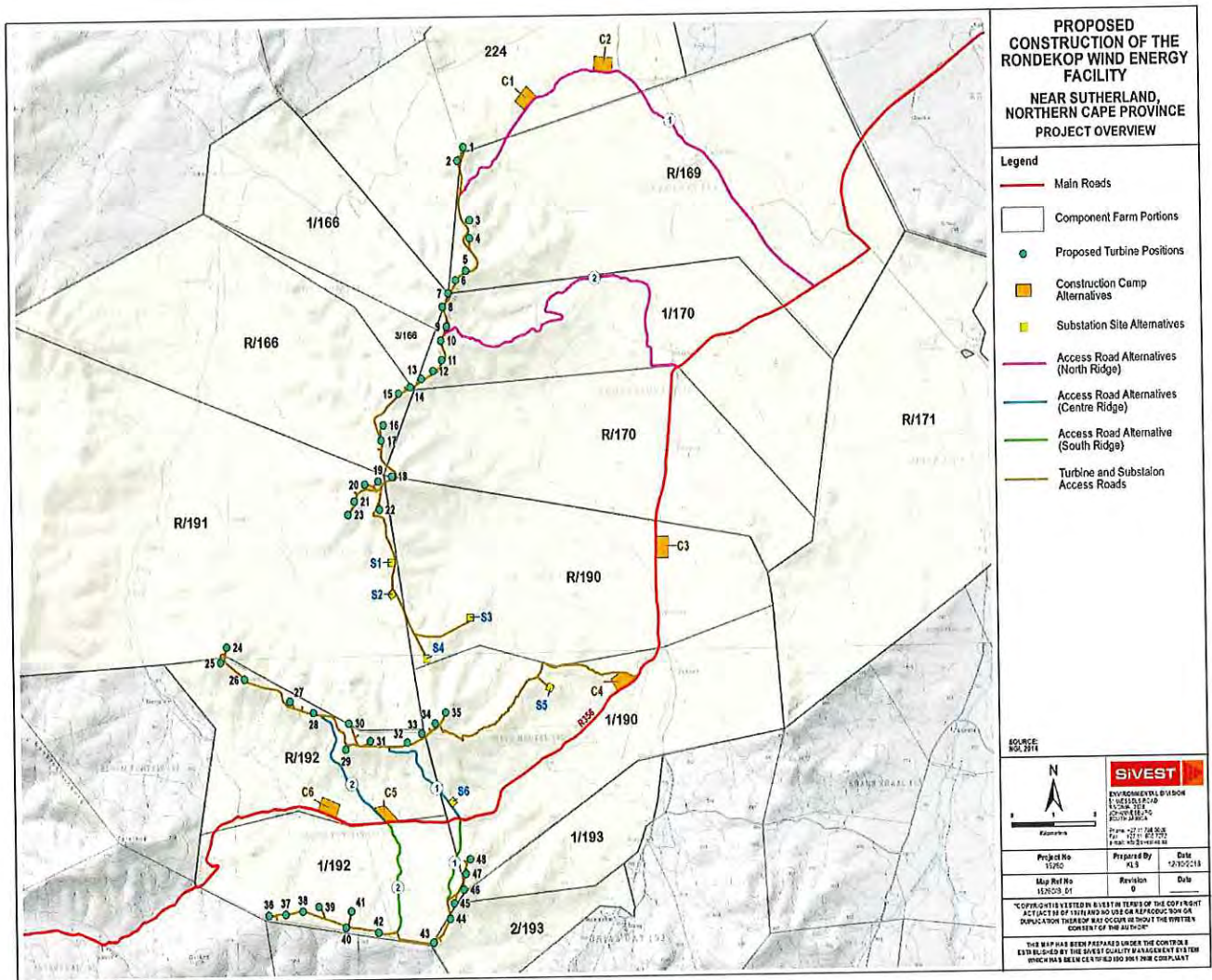

Map 2: Wind Turbine Generator Layout for Rondekop Energy Facility

SENTECH SOC Ltd Reg no: 1990/001791/30

Directors: Mr. M Mello (Chairperson), Mr. M Booi (CEO), Mr. S Mthethwa CA (SA) (CFO), Mr. T Leshope (COO), Ms. J Huntley, Mr. L Mtimde, Dr S Malinga, Ms T Malaka, Ms. M Manyama CA (SA), Ms. P Sibiyi
Company Secretary: Adv. P Matsane

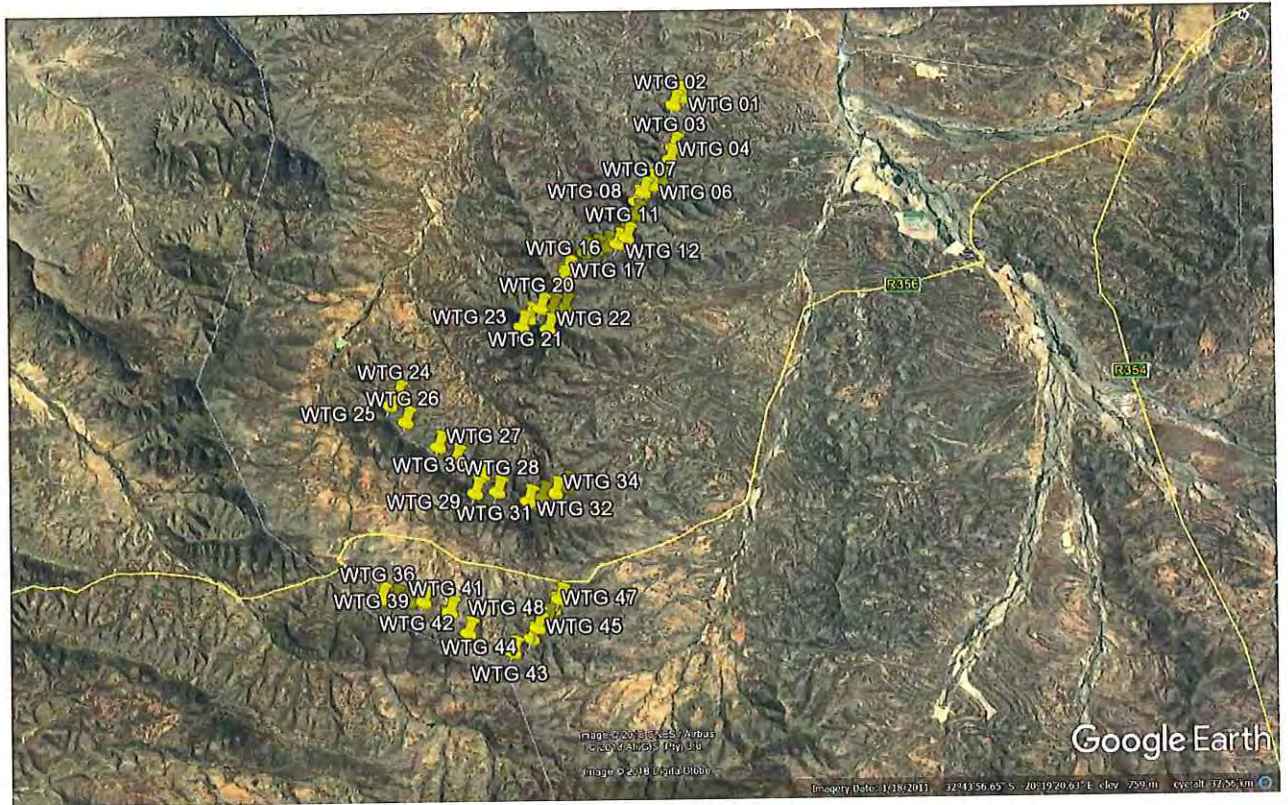

MAP 3: Google Earth Map Wind Turbine Generator Layout for Rondekop Energy Facility

SENTECH SOC Ltd Reg no: 1990/001791/30

Directors: Mr. M Mello (Chairperson), Mr. M Booi (CEO), Mr. S Mthethwa CA (SA) (CFO), Mr. T Leshope (COO),
Ms. J Huntley, Mr. L Mtimde, Dr S Malinga, Ms T Malaka, Ms. M Manyama CA (SA), Ms. P Sibiya
Company Secretary: Adv. P Matsane



environmental affairs

Department:
Environmental Affairs
REPUBLIC OF SOUTH AFRICA

Private Bag X 447 · PRETORIA · 0001 · Environment House · 473 Steve Biko Road, Arcadia, · PRETORIA
Tel (+ 27 12) 399 9372

DEA Reference: 14/12/16/3/3/2/1115

Enquiries: Constance Musemburi

Telephone: (012) 399 9416 **E-mail:** Cmusemburi@environment.gov.za

Ms Andrea Gibb
SiVest SA (Pty) Ltd.
P. O. Box 2921
RIVONIA
2128

Tel No: 011 798 0638
Email: andreag@sivest.co.za

ER E-MAIL / MAIL

Dear Madam

COMMENTS ON THE DRAFT SCOPING REPORT FOR THE PROPOSED CONSTRUCTION OF THE 325MW RONDEKOP WIND ENERGY FACILITY BETWEEN MATJIESFONTEIN AND SUTHERLAND, NORTHERN CAPE PROVINCE.

The application form and the draft Scoping Report (SR) received by this Department on 14 November 2018 and the acknowledgement thereof dated 19 November 2018 refers.

This Department has the following comments on the abovementioned application:

- i. This Department has noted the use of the word **“may, will likely”**, when describing the project activity that triggers the listed activities applied for. The use of these words show that the EAP/applicant is not confident and/or is uncertain as to why the listed activities applied for are being triggered by the proposed activity. You are therefore required to rephrase all project activity descriptions to refrain from the use of these words. **The onus is on the applicant to ensure that only the applicable listed activities are included in the application form.** A full assessment of impacts and proposed mitigation thereto of all the triggered activities must be provided in the final SR.
- ii. Please ensure that **the relevant listed activities are applied for, are specific and that it can be linked to the development activity or infrastructure as described in the project description.**
- iii. If the activities applied for in the application form differ from those mentioned in the final SR, an amended application form must be submitted. Please note that the Department's application form template has been amended and can be downloaded from the following link <https://www.environment.gov.za/documents/forms>.
- iv. Please ensure that all issues raised and comments received during the circulation of the draft SR from registered I&APs and organs of state which have jurisdiction in respect of the proposed activity are adequately addressed in the Final SR. Proof of correspondence with the various stakeholders must be included in the Final SR. Should you be unable to obtain comments, proof should be submitted to the Department of the attempts that were made to obtain comments. The Public Participation Process must be conducted in terms of Regulation 39, 40, 41, 42, 43 & 44 of the EIA Regulations 2014.

- v. Please provide a description of any identified alternatives for the proposed activity that are feasible and reasonable, including the advantages and disadvantages that the proposed activity or alternatives will have on the environment and on the community that may be affected by the activity as per Appendix 2 (1) (c) (d) and 2 (h) of GN R.982 of 2014. Alternatively, you should submit written proof of an investigation and motivation if no reasonable or feasible alternatives exist in terms of Appendix 2 (2)(x)(xi).
- vi. In accordance with Appendix 2 (2) (a) of the EIA Regulations 2014, the details of—
 - (i) *the EAP who prepared the report; and*
 - (ii) *the expertise of the EAP to carry out Scoping and Environmental Impact assessment procedures; must be submitted.*
- vii. Please ensure that the final SR includes a legible site layout map; an environmental sensitivity map indicating all environmental sensitive areas and features; a map combining a layout map superimposed (overlain) on the environmental sensitivity map; and a regional map of the area.
- viii. You are further reminded that the final SR to be submitted to this Department must comply with all the requirements in terms of the scope of assessment and content of Scoping reports in accordance with Appendix 2 and Regulation 21(1) of the EIA Regulations, 2014.
- ix. Please ensure that a CD/flash drive is submitted together with your FSR.
- x. Further note that in terms of Regulation 45 of the EIA Regulations 2014, this application will lapse if the applicant fails to meet any of the timeframes prescribed in terms of these Regulations, unless an extension has been granted in terms of Regulation 3(7).

You are hereby reminded of Section 24F of the National Environmental Management Act, Act No 107 of 1998, as amended, that no activity may commence prior to an environmental authorisation being granted by the Department.

Yours sincerely



Mr Sabelo Malaza
Chief Director: Integrated Environmental Authorisations
Department of Environmental Affairs
Signed by: Mr. Wayne Hector
Designation: Deputy Director: Strategic Infrastructure Developments
Date: 07/12/18

cc:	Dr Kilian Hagemann	Rondekop Wind Farm (Pty) Ltd	Tel no: 021 300 0613	Email: rondkop@g7energies.com
-----	--------------------	------------------------------	----------------------	-------------------------------

sivest_PPP

From: Morgan Griffiths <morgan.griffiths@wessa.co.za>
Sent: 12 December 2018 10:17 AM
To: sivest_PPP
Subject: RE: Rondekop Wind Energy Facility near Sutherland: DSR Comment Period Ending

Hi Shivani

WESSA will not be submitting a comment, thank you for inviting us to comment on this application.

Regards
Morgan Griffiths

From: sivest_PPP <sivest_ppp@sivest.co.za>
Sent: 12 December 2018 10:14
To: Andrea Gibb <AndreaG@sivest.co.za>; Shivani Naidoo <ShivaniN@sivest.co.za>; 'Veronique Fyfe' <veronique@g7energies.com>; Liandra Scott-Shaw <LiandraS@sivest.co.za>
Cc: 'Henning Myburg' <henning@agrink.co.za>; 'Simphiwe Masilela' <ObstacleEvaluators@atns.co.za>; 'Johanna Morobane' <JohannaM@atns.co.za>; 'Phillip De Lange' <phillipd@atns.co.za>; 'Ferdie Smit' <ferdis@atns.co.za>; 'Candice Stevens' <advocacy@birdlife.org.za>; 'Samantha Ralston-Paton' <energy@birdlife.org.za>; 'Jacoline Mans' <jacolinema@daff.gov.za>; 'Paul Avenant' <paula@daff.gov.za>; 'Colonel Loy de Jager' <loydejager@hotmail.com>; 'Mmatlala Rabothata' <mrabothata@environment.gov.za>; 'Seoka Lekota' <slekota@environment.gov.za>; 'Ntsundeni Ravhogoni' <Ntsundeni.Ravhogoni@dmr.gov.za>; 'Patrick Lenyibi' <plenyibi@ncpg.gov.za>; 'Ester Makungo' <makungoe@dws.gov.za>; 'Moses Mahunonyane' <MahunonyaneM@dws.gov.za>; 'Brian Fisher' <bfisher@ncpg.gov.za>; 'Andre Crous' <andre.crous@eskom.co.za>; 'John Geeringh' <GeerinJH@eskom.co.za>; 'Lourens Leeuwner' <lourensl@ewt.org.za>; 'Allistar Gibbons' <a.gibbons@karoohoogland.gov.za>; 'Jannie Loubser' <janniel@namakwa-dm.gov.za>; 'Gert Steenkamp' <gsteenkamp@ncpg.gov.za>; 'Jaco Roelofse' <roelofse.j@vodamail.co.za>; 'Thulani Mthombeni' <tmtho@webmail.co.za>; 'Lizell Stroh' <strohl@caa.co.za>; 'Nicole Abrahams' <AbrahamsN@nra.co.za>; 'Mlungisi Ngwenya' <Mlungisi.Ngwenya@weathersa.co.za>; 'Frank Creese' <creesef@sentech.co.za>; 'Alisha Pretorius' <pretoriusa@sentech.co.za>; 'Johan Koegelenberg' <KoegelenbergJ@sentech.co.za>; 'Ramatholo Sefako' <rrs@sao.ac.za>; 'Danie Erasmus' <radiotech@saps.org.za>; 'Adriaan Tiplady' <atiplady@ska.ac.za>; 'Keverne Thurling' <Thurling@telkom.co.za>; 'Heleen van den Heever' <vdheevhd@telkom.co.za>; 'Amanda Bester' <WayleaCR@telkom.co.za>; Morgan Griffiths <morgan.griffiths@wessa.co.za>; 'Administration' <salt@salt.ac.za>; 'Johan' <Johan@fleetcall.co.za>; 'Adriaan Tiplady' <atiplady@ska.ac.za>; 'Alisha Pretorius' <pretoriusa@sentech.co.za>; 'Allistar Gibbons' <a.gibbons@karoohoogland.gov.za>; 'Amanda Bester' <WayleaCR@telkom.co.za>; 'Andre Crous' <andre.crous@eskom.co.za>; 'Brian Fisher' <bfisher@ncpg.gov.za>; 'Candice Stevens' <advocacy@birdlife.org.za>; 'Charles van Reenen' <vanree_c@mtn.co.za>; 'Coert Smit' <coert@breedenet.co.za>; 'Colonel Loy de Jager' <loydejager@hotmail.com>; 'Craig Barnes' <barnesc@vodacom.co.za>; 'Danie Erasmus' <radiotech@saps.org.za>; 'Ester Makungo' <makungoe@dws.gov.za>; 'Ferdie Smit' <ferdis@atns.co.za>; 'Frank Creese' <creesef@sentech.co.za>; 'Gert Steenkamp' <gsteenkamp@ncpg.gov.za>; 'Giel Klazen' <seunklazen@gmail.com>; 'Heleen van den Heever' <vdheevhd@telkom.co.za>; 'Henning Myburg' <henning@agrink.co.za>; 'J Martiens' <sutherlandlib@ncpg.gov.za>; 'Jaco Roelofse' <roelofse.j@vodamail.co.za>; 'Jacobus Jooste' <info@karoohoogland.gov.za>; 'Jacoline Mans' <jacolinema@daff.gov.za>; 'Jan Johannes Jacobs' <jacobsjan624@gmail.com>; 'Jannie Loubser' <janniel@namakwa-dm.gov.za>; 'Jeremy Davids' <jeremydavids11@gmail.com>; 'Johan Koegelenberg' <KoegelenbergJ@sentech.co.za>; 'Johan van der Colff' <jvdc@mtnloaded.co.za>; 'Johanna Morobane' <JohannaM@atns.co.za>; 'John Geeringh' <GeerinJH@eskom.co.za>; 'Keverne Thurling' <Thurling@telkom.co.za>; 'Lizell Stroh' <strohl@caa.co.za>; 'Lourens Leeuwner' <lourensl@ewt.org.za>; 'M Malan' <sutherland.sc@saps.gov.za>; 'Mmatlala Rabothata' <mrabothata@environment.gov.za>; Morgan Griffiths <morgan.griffiths@wessa.co.za>; 'Moses Mahunonyane' <MahunonyaneM@dws.gov.za>; 'Nelly Boshielo' <Nelly.Boshielo@weathersa.co.za>; 'Nicole Abrahams' <AbrahamsN@nra.co.za>; 'Ntsundeni Ravhogoni' <Ntsundeni.Ravhogoni@dmr.gov.za>; 'Patrick Lenyibi' <plenyibi@ncpg.gov.za>; 'Paul Avenant' <paula@daff.gov.za>; 'Phillip De Lange' <phillipd@atns.co.za>; 'Ramatholo

Sefako' <rrs@sao.ac.za>; 'Rasibe Sekepane' <Lungi.Mondela@dmr.gov.za>; 'Rene De Kock' <Dekockr@nra.co.za>; 'Ronell Cloete' <sutherlandlibrary@ncpg.gov.za>; 'S Frans' <franss@netstar.altech.co.za>; 'Sam Fiff' <Francis.Rahlapane@transnet.net>; 'Samantha Ralston-Paton' <energy@birdlife.org.za>; 'Seoka Lekota' <slekota@environment.gov.za>; 'Simphiwe Masilela' <ObstacleEvaluators@atns.co.za>; 'Thoko Buthelezi' <ThokoB@daff.gov.za>; 'Thulani Mthombeni' <tmtho@webmail.co.za>; 'Tshegofatso Monama' <temonama@ska.ac.za>; 'Veruschka Wentzel' <vcwentzel123@gmail.com>; 'Vincent Mula' <pieter.swart@dmr.gov.za>; 'Vivian Kiewitz' <VKiewitz@cellc.co.za>; 'Willenise Klein' <w.klein@karoohoogland.gov.za>; 'ruth.cuttings@yahoo.com' <ruth.cuttings@yahoo.com>; 'Mpho Sebole' <sebolemd@eskom.co.za>; 'Obstacles@caa.co.za' <Obstacles@caa.co.za>; 'isak@breedenet.co.za' <isak@breedenet.co.za>; 'kmothomi@ncpg.gov.za' <kmothomi@ncpg.gov.za>; 'mayorv@karoohoogland.gov.za' <mayorv@karoohoogland.gov.za>

Subject: Rondekop Wind Energy Facility near Sutherland: DSR Comment Period Ending

Importance: High

Dear Stakeholder,

SiVEST sent the Draft Scoping report for the proposed 325MW Rondekop Wind Energy facility between Matjiesfontein and Sutherland in the Northern Cape province to your department on 14th November 2018 for comment (refer to the below email). Please can you advise if comments will be submitted to us for inclusion in the final Scoping Report.

We would like to inform you that the comment period is ending on **Friday 14th December 2018** and you are advised to please send comments as soon as possible.

Should you have any comments, please feel free to contact the public participation office at the details below:

Sivest Environmental

PO Box 2921, RIVONIA, 2128

Phone: (011) 798 0600

E-mail: hlengiwen@sivest.co.za / Sivest_ppp@sivest.co.za

Fax: (011) 803 7272

Kind Regards

Shivani Naidoo

Environmental Consultant

SiVEST Environmental Division



SiVEST is a Level 3 BBBEE Contributor

D +27 11 798 0600 | **T** +27 11 798 0600 **W** www.sivest.co.za

Engineering Consulting | Project Management | Environmental Consulting | Town & Regional Planning | Management Systems Consulting

Durban | Johannesburg | Pretoria | Pietermaritzburg | Richards Bay | Port Louis (Mauritius)

From: sivest_PPP

Sent: 14 November 2018 05:40 PM

To: Andrea Gibb <AndreaG@sivest.co.za>; Shivani Naidoo <ShivaniN@sivest.co.za>; 'Veronique Fyfe' <veronique@g7energies.com>

Cc: 'Henning Myburg' <henning@agrink.co.za>; 'Simphiwe Masilela' <ObstacleEvaluators@atns.co.za>; 'Johanna Morobane' <JohannaM@atns.co.za>; 'Phillip De Lange' <phillipd@atns.co.za>; 'Ferdie Smit' <ferdis@atns.co.za>; 'Candice Stevens' <advocacy@birdlife.org.za>; 'Samantha Ralston-Paton' <energy@birdlife.org.za>; 'Jacoline Mans' <jacolinema@daff.gov.za>; 'Paul Avenant' <paula@daff.gov.za>; 'Colonel Loy de Jager' <loydejager@hotmail.com>; 'Mmatlala Rabothata' <mrabothata@environment.gov.za>; 'Seoka Lekota' <slekota@environment.gov.za>; 'Ntsundeni Ravhogoni' <Ntsundeni.Ravhogoni@dmr.gov.za>; 'Patrick Lenyibi' <plenyibi@ncpg.gov.za>; 'Ester

Makungo' <makungoe@dws.gov.za>; 'Moses Mahunonyane' <MahunonyaneM@dws.gov.za>; 'Brian Fisher' <bfisher@ncpg.gov.za>; 'Andre Crous' <andre.crous@eskom.co.za>; 'John Geeringh' <GeerinJH@eskom.co.za>; 'Lourens Leeuwner' <lourensl@ewt.org.za>; 'Allistar Gibbons' <a.gibbons@karoohoogland.gov.za>; 'Jannie Loubser' <janniel@namakwa-dm.gov.za>; 'Gert Steenkamp' <gsteenkamp@ncpg.gov.za>; 'Jaco Roelofse' <roelofse.j@vodamail.co.za>; 'Thulani Mthombeni' <tmtho@webmail.co.za>; 'Lizell Stroh' <strohl@caa.co.za>; 'Nicole Abrahams' <AbrahamsN@nra.co.za>; 'Mlungisi Ngwenya' <Mlungisi.Ngwenya@weathersa.co.za>; 'Frank Creese' <creesef@sentech.co.za>; 'Alisha Pretorius' <pretoriusa@sentech.co.za>; 'Johan Koegelenberg' <KoegelenbergJ@sentech.co.za>; 'Ramatholo Sefako' <rrs@sao.ac.za>; 'Danie Erasmus' <radiotech@saps.org.za>; 'Adriaan Tiplady' <atiplady@ska.ac.za>; 'Keverne Thurling' <Thurling@telkom.co.za>; 'Heleen van den Heever' <vdheevhd@telkom.co.za>; 'Amanda Bester' <WayleaCR@telkom.co.za>; 'Morgan Griffiths' <morgan.griffiths@wessa.co.za>

Subject: Rondekop Wind Energy Facility near Sutherland: DSR Comment Period Starting

Dear Stakeholder

ENVIRONMENTAL IMPACT ASSESSMENT PROCESS (EIA) FOR THE PROPOSED 325MW RONDEKOP WIND ENERGY FACILITY BETWEEN MATJIESFONTEIN AND SUTHERLAND IN THE NORTHERN CAPE PROVINCE

SiVEST is in the process of undertaking the Environmental Impact Assessment (EIA) for the proposed development of the Rondekop Wind Energy Facility near Sutherland in the Northern Cape.

We would like to take this opportunity to inform you that, in accordance with the National Environmental Management Act, 1998 (Act No. 107 of 1998) (NEMA) (as amended), the Draft Scoping Report (DSR) for the above mentioned wind project will be available for public comment and review as from **Wednesday the 14th of November 2018 to the Friday 14th of December 2018** (before end of business day).

The DSRs as well as the accompanying appendices are available online (<http://data.g7energies.com/eia/rondekop>) and an electronic copy (on CD) has been posted to you. We kindly request that you submit your comments to the Public Participation Office at the below details, on or before Friday the 14th of December 2018 (before end of business day). SiVEST will forward any comments received after the public comment and review period directly to the relevant case officer at the Department of Environmental Affairs (DEA).

Should you have any questions or queries please do not hesitate to contact us at:

Hlengiwe Ntuli

PO Box 2921, RIVONIA, 2128

Phone: (011) 798 0600

E-mail: hlengiwen@sivest.co.za

Fax: (011) 803 7272

Kind Regards

Shivani Naidoo

Environmental Consultant

SiVEST Environmental Division



SiVEST is a Level 3 BBBEE Contributor

D +27 11 798 0600 | **T** +27 11 798 0600 **W** www.sivest.co.za

Engineering Consulting | Project Management | Environmental Consulting | Town & Regional Planning | Management Systems Consulting

Durban | Johannesburg | Pretoria | Pietermaritzburg | Richards Bay | Port Louis (Mauritius)

Disclaimer

The information contained in this communication from the sender is confidential. It is intended solely for use by the recipient and others authorized to receive it. If you are not the recipient, you are hereby notified that any disclosure, copying, distribution or taking action in relation of the contents of this information is strictly prohibited and may be unlawful.

This email has been scanned for viruses and malware, and automatically archived by **Mimecast SA (Pty) Ltd**, an innovator in Software as a Service (SaaS) for business. **Mimecast Unified Email Management ??? (UEM)** offers email continuity, security, archiving and compliance with all current legislation. To find out more, [contact Mimecast](#).

From: Simphiwe Masilela <SimphiweM@atns.co.za>
Sent: 14 December 2018 11:29 AM
To: sivest_PPP
Cc: Graham Mondzinger; Francois Coetzee
Subject: RE: Rondekop Wind Energy Facility near Sutherland: DSR Comment Period Starting



Good day Hlengiwe,

RE: RONDEKOP WIND ENERGY FACILITY

This area is situated 214KM NE of Cape Town International Airport and 208KM W of Langebaanweg Military Airport (They need to be well).

The proposed falls outside the Annex14 surfaces associated with the mentioned airport, however, we need to determine whether the proposed flights.

We would have to conduct a formal Communication, Navigation and Surveillance (CNS) assessment as per South African Civil Aviation Regulations. The proposed should not be seen by the radar.

The line of sight may be affected upon a Terrain profile assessment, as the radar extends to a 250NM radius.

We request that you please update us should there be any new developments that may affect our interests.

We will duly conduct assessments as required when the project is ready for construction upon a formal request.

Kindly note there is a charge attached to this service.

Furthermore, we kindly request that all queries or new applications to be forwarded to the Obstacle Evaluators on the following email: obstacleEvaluator@atns.co.za

Please note, for us to carry out a successful assessment we require the following information:

1. LOCATION (Co-ordinates WGS84 system)
2. SITE/GROUND ELEVATION (AMSL)
3. HEIGHT TO TOP OF PROPOSED DEVELOPMENT (in meters)
4. THE NUMBER OF WIND TURBINES

Kind Regards,

Simphiwe Masilela
Obstacle Evaluator | COO - Air Traffic Services
ATNS Head Office, Bruma, Johannesburg, South Africa

T: +2711 607 1228 • F: 011 607 1466 • C:



[View Disclaimer](#)

From: sivest_PPP [mailto:sivest_ppp@sivest.co.za]

Sent: Wednesday, November 14, 2018 5:40 PM

To: Andrea Gibb <AndreaG@sivest.co.za>; Shivani Naidoo <ShivaniN@sivest.co.za>; 'Veronique Fyfe' <veronique@g7energie

Cc: 'Henning Myburg' <henning@agrink.co.za>; Obstacle Evaluators <ObstacleEvaluators@atns.co.za>; Johanna Morobane <

<phillipd@atns.co.za>; Ferdi Smit <ferdis@atns.co.za>; 'Candice Stevens' <advocacy@birdlife.org.za>; 'Samantha Ralston-Pat

Mans' <jacolinema@daff.gov.za>; 'Paul Avenant' <paula@daff.gov.za>; 'Colonel Loy de Jager' <loydejager@hotmail.com>; 'M

<mrabothata@environment.gov.za>; 'Seoka Lekota' <slekota@environment.gov.za>; 'Ntsundeni Ravhogoni' <Ntsundeni.Ravh

<plenyibi@ncpg.gov.za>; 'Ester Makungo' <makungoe@dws.gov.za>; 'Moses Mahunonyane' <MahunonyaneM@dws.gov.za>

'Andre Crous' <andre.crous@eskom.co.za>; 'John Geeringh' <GeerinJH@eskom.co.za>; 'Lourens Leeuwner' <lourensl@ewt.or

<a.gibbons@karoohoogland.gov.za>; 'Jannie Loubser' <janniel@namakwa-dm.gov.za>; 'Gert Steenkamp' <gsteenkamp@ncpg

<roelofse.j@vodamail.co.za>; 'Thulani Mthombeni' <tmtho@webmail.co.za>; 'Lizell Strohl' <strohl@caa.co.za>; 'Nicole Abrah

Ngwenya' <Mlungisi.Ngwenya@weathersa.co.za>; 'Frank Creese' <creesef@sentech.co.za>; 'Alisha Pretorius' <pretoriusa@se

<KoegelenbergJ@sentech.co.za>; 'Ramatholo Sefako' <rrs@sao.ac.za>; 'Danie Erasmus' <radiotech@saps.org.za>; 'Adriaan T

Thurling' <Thurling@telkom.co.za>; 'Heleen van den Heever' <vdheevhd@telkom.co.za>; 'Amanda Bester' <WayleaCR@telko

<morgan.griffiths@wessa.co.za>

Subject: Rondekop Wind Energy Facility near Sutherland: DSR Comment Period Starting

Dear Stakeholder

ENVIRONMENTAL IMPACT ASSESSMENT PROCESS (EIA) FOR THE PROPOSED 325MW RONDEKOP WIND ENERGY AND SUTHERLAND IN THE NORTHERN CAPE PROVINCE

SiVEST is in the process of undertaking the Environmental Impact Assessment (EIA) for the proposed development of the Rondekop Wind Energy Facility near Sutherland in the Northern Cape.

We would like to take this opportunity to inform you that, in accordance with the National Environmental Management Act, 1998 the Draft Scoping Report (DSR) for the above mentioned wind project will be available for public comment and review as from **the Friday 14th of December 2018** (before end of business day).

The DSRs as well as the accompanying appendices are available online (<http://data.g7energies.com/eia/rondekop>) and an electronic public participation office (EPP) will be established. We kindly request that you submit your comments to the Public Participation Office at the below details, on or before Friday the 14th of December 2018 (before end of business day). SiVEST will forward any comments received after the public comment and review period directly to the relevant case officer (DEA).

Should you have any questions or queries please do not hesitate to contact us at:

Hlengiwe Ntuli

PO Box 2921, RIVONIA, 2128

Phone: (011) 798 0600

E-mail: hlengiwen@sivest.co.za

Fax: (011) 803 7272

Kind Regards

Shivani Naidoo

Environmental Consultant

SiVEST Environmental Division



SiVEST is a Level 3 BBBEE Contributor

D +27 11 798 0600 | **T** +27 11 798 0600 **W** www.sivest.co.za

Engineering Consulting | Project Management | Environmental Consulting | Town & Regional Planning | Management Systems Consulting
Durban | Johannesburg | Pretoria | Pietermaritzburg | Richards Bay | Port Louis (Mauritius)

Disclaimer

The information contained in this communication from the sender is confidential. It is intended solely for use by the recipient and others a recipient, you are hereby notified that any disclosure, copying, distribution or taking action in relation of the contents of this information is

This email has been scanned for viruses and malware, and automatically archived by **Mimecast SA (Pty) Ltd**, an innovator in Software a **Unified Email Management ??? (UEM)** offers email continuity, security, archiving and compliance with all current legislation. To find out

The contents of this email are confidential and intended for the named recipient(s) only. The information may be privileged or otherwise protected from disclosure. The views expressed in this message are those of the sender, unless otherwise stated to be. This email is also subject to copyright. No part hereof may be reproduced, adapted, transmitted, or used in any way without the written consent of ATNS SOC Limited. Please do not hesitate to contact us immediately should you have any doubts regarding the authenticity of an email purportedly sent by the sender.

The provisions of Sections 11,12, and 13 of the Electronic Communications and Transactions Act, 25 of 2002, in so far as e-contracting is concerned are expressly excluded and contracted out of by Air Traffic Navigation Services (ATNS) and, unless clearly stated to the contrary in the body of the data message or electronic communication no data message or electronic communication will be recognised as having legal contractual status as per the aforementioned provisions under any circumstances. All contracts concluded by ATNS and its Business Units will only be legally binding and recognised once reduced to physical writing and physically signed by a duly authorised representative of ATNS. All other provisions of the Electronic Communications and Transactions Act, 25 of 2002 are accepted.

Although ATNS has taken all reasonable precautions to ensure that this e-mail is virus free, ATNS does not accept any liability for any damage caused by any virus transmitted by this email.

sivest_PPP

From: Werner Kleynhans <kleynhansw@caa.co.za>
Sent: 14 December 2018 02:27 PM
To: sivest_PPP
Subject: RE: Rondekop Wind Energy Facility near Sutherland: DSR Comment Period Ending

Dear Me Naidoo

The email regarding the proposed development of the Rondekop Wind Energy facility between Matjiesfontein and Sutherland refer.

Due to the proximity of the site relative to the Sutherland Navigation Beacon (VOR SLV) & the Sutherland Radar, a more detailed investigation is required to determine if the proposed wind farm will have an impact on these aviation safety critical navigation systems. The SACAA will therefore not be able to provide a response by close of business today but will provide an official response by no later than 11 January 2019.

In terms of the Civil Aviation Regulations (CAR) Part 139.01.30, approval of the Director of Civil Aviation will be required due to the location (°, height & nature of the structure. The Obstacle application process is published on the CAA's website (<http://www.caa.co.za/Pages/Obstacles/Urgent-notice.aspx>). Kindly also note "Obstacle Notice 2/2017 (17/11/2017): Additional Requirements for Wind Farm Applications" which requires that all new wind farm applications have to be accompanied by an aviation Communication, Navigation & Surveillance (CNS) Impact Assessment Report obtained from ATNS.

Kind Regards



Werner Kleynhans
Manager: PANS-OPS
PANS-OPS Section
Air Navigation Services Department
Tel: +27 11 545 1468 | Mobile: +27 82 774 8994
Email: kleynhansw@caa.co.za | www.caa.co.za

Follow us on  

From: sivest_PPP [mailto:sivest_ppp@sivest.co.za]

Sent: 12 December 2018 10:14 AM

To: Andrea Gibb; Shivani Naidoo; 'Veronique Fyfe'; Liandra Scott-Shaw

Cc: 'Henning Myburg'; 'Simpfiwe Masilela'; 'Johanna Morobane'; 'Phillip De Lange'; 'Ferdie Smit'; 'Candice Stevens'; 'Samantha Ralston-Paton'; 'Jacoline Mans'; 'Paul Avenant'; 'Colonel Loy de Jager'; 'Mmatlala Rabothata'; 'Seoka Lekota'; 'Ntsundeni Ravhogoni'; 'Patrick Lenyibi'; 'Ester Makungo'; 'Moses Mahunonyane'; 'Brian Fisher'; 'Andre Crous'; 'John Geeringh'; 'Lourens Leeuwner'; 'Allistar Gibbons'; 'Jannie Loubser'; 'Gert Steenkamp'; 'Jaco Roelofse'; 'Thulani Mthombeni'; 'Lizell Stroh'; 'Nicole Abrahams'; 'Mlungisi Ngwenya'; 'Frank Creese'; 'Alisha Pretorius'; 'Johan Koegelenberg'; 'Ramatholo Sefako'; 'Danie Erasmus'; 'Adriaan Tiplady'; 'Keverne Thurling'; 'Heleen van den Heever'; 'Amanda Bester'; 'Morgan Griffiths'; 'Administration'; 'Johan'; 'Adriaan Tiplady'; 'Alisha Pretorius'; 'Allistar Gibbons'; 'Amanda Bester'; 'Andre Crous'; 'Brian Fisher'; 'Candice Stevens'; 'Charles van Reenen'; 'Coert Smit'; 'Colonel Loy de Jager'; 'Craig Barnes'; 'Danie Erasmus'; 'Ester Makungo'; 'Ferdie Smit'; 'Frank Creese'; 'Gert Steenkamp'; 'Giel Klazen'; 'Heleen van den Heever'; 'Henning Myburg'; 'J Martiens'; 'Jaco Roelofse'; 'Jacobus Jooste'; 'Jacoline Mans'; 'Jan Johannes Jacobs'; 'Jannie Loubser'; 'Jeremy Davids'; 'Johan Koegelenberg'; 'Johan van der Colff'; 'Johanna Morobane'; 'John Geeringh'; 'Keverne Thurling'; 'Lizell Stroh'; 'Lourens Leeuwner'; 'M Malan'; 'Mmatlala Rabothata'; 'Morgan Griffiths'; 'Moses Mahunonyane'; 'Nelly Boshieho'; 'Nicole Abrahams'; 'Ntsundeni Ravhogoni'; 'Patrick Lenyibi'; 'Paul Avenant'; 'Phillip De Lange'; 'Ramatholo Sefako'; 'Rasibe Sekepane'; 'Rene De Kock'; 'Ronell Cloete'; 'S Frans'; 'Sam Fiff'; 'Samantha Ralston-Paton'; 'Seoka Lekota'; 'Simpfiwe Masilela'; 'Thoko Buthelezi'; 'Thulani Mthombeni'; 'Tshegofatso Monama'; 'Veruschka Wentzel'; 'Vincent Mula'; 'Vivian Kiewitz'; 'Willenise Klein';

'ruth.cuttings@yahoo.com'; 'Mpho Sebole'; Obstacles; 'isak@breedenet.co.za'; 'kmotlhomi@ncpg.gov.za'; 'mayorv@karoohoogland.gov.za'

Subject: Rondekop Wind Energy Facility near Sutherland: DSR Comment Period Ending

Importance: High

Dear Stakeholder,

SiVEST sent the Draft Scoping report for the proposed 325MW Rondekop Wind Energy facility between Matjiesfontein and Sutherland in the Northern Cape province to your department on 14th November 2018 for comment (refer to the below email). Please can you advise if comments will be submitted to us for inclusion in the final Scoping Report.

We would like to inform you that the comment period is ending on **Friday 14th December 2018** and you are advised to please send comments as soon as possible.

Should you have any comments, please feel free to contact the public participation office at the details below:

Sivest Environmental

PO Box 2921, RIVONIA, 2128

Phone: (011) 798 0600

E-mail: hlengiwen@sivest.co.za / Sivest_ppp@sivest.co.za

Fax: (011) 803 7272

Kind Regards

Shivani Naidoo

Environmental Consultant

SiVEST Environmental Division



SiVEST is a Level 3 BBBEE Contributor

D +27 11 798 0600 | **T** +27 11 798 0600 **W** www.sivest.co.za

Engineering Consulting | Project Management | Environmental Consulting | Town & Regional Planning | Management Systems Consulting

Durban | Johannesburg | Pretoria | Pietermaritzburg | Richards Bay | Port Louis (Mauritius)

From: sivist_PPP

Sent: 14 November 2018 05:40 PM

To: Andrea Gibb <AndreaG@sivest.co.za>; Shivani Naidoo <ShivaniN@sivest.co.za>; 'Veronique Fyfe' <veronique@g7energies.com>

Cc: 'Henning Myburg' <henning@agrink.co.za>; 'Simphiwe Masilela' <ObstacleEvaluators@atns.co.za>; 'Johanna Morobane' <JohannaM@atns.co.za>; 'Phillip De Lange' <phillipd@atns.co.za>; 'Ferdie Smit' <ferdis@atns.co.za>; 'Candice Stevens' <advocacy@birdlife.org.za>; 'Samantha Ralston-Paton' <energy@birdlife.org.za>; 'Jacoline Mans' <jacolinema@daff.gov.za>; 'Paul Avenant' <paula@daff.gov.za>; 'Colonel Loy de Jager' <loydejager@hotmail.com>; 'Mmatlala Rabothata' <mrabothata@environment.gov.za>; 'Seoka Lekota' <slekota@environment.gov.za>; 'Ntsundeni Ravhogoni' <Ntsundeni.Ravhogoni@dmr.gov.za>; 'Patrick Lenyibi' <plenyibi@ncpg.gov.za>; 'Ester Makungo' <makungoe@dws.gov.za>; 'Moses Mahunonyane' <MahunonyaneM@dws.gov.za>; 'Brian Fisher' <bfisher@ncpg.gov.za>; 'Andre Crous' <andre.crous@eskom.co.za>; 'John Geeringh' <GeerinJH@eskom.co.za>; 'Lourens Leeuwner' <lourensl@ewt.org.za>; 'Allistar Gibbons' <a.gibbons@karoohoogland.gov.za>; 'Jannie Loubser' <janniel@namakwa-dm.gov.za>; 'Gert Steenkamp' <gsteenkamp@ncpg.gov.za>; 'Jaco Roelofse' <roelofse.j@vodamail.co.za>; 'Thulani Mthombeni' <tmtho@webmail.co.za>; 'Lizell Stroh' <strohl@caa.co.za>; 'Nicole Abrahams' <AbrahamsN@nra.co.za>; 'Mlungisi Ngwenya' <Mlungisi.Ngwenya@weathersa.co.za>; 'Frank Creese' <creesef@sentech.co.za>; 'Alisha Pretorius' <pretoriusa@sentech.co.za>; 'Johan Koegelenberg' <KoegelenbergJ@sentech.co.za>; 'Ramatholo Sefako' <rrs@saao.ac.za>; 'Danie Erasmus' <radiotech@saps.org.za>; 'Adriaan Tiplady' <atiplady@ska.ac.za>; 'Keverne Thurling' <Thurling@telkom.co.za>; 'Heleen van den Heever'

<vdheevhd@telkom.co.za>; 'Amanda Bester' <WayleaCR@telkom.co.za>; 'Morgan Griffiths' <morgan.griffiths@wessa.co.za>

Subject: Rondekop Wind Energy Facility near Sutherland: DSR Comment Period Starting

Dear Stakeholder

ENVIRONMENTAL IMPACT ASSESSMENT PROCESS (EIA) FOR THE PROPOSED 325MW RONDEKOP WIND ENERGY FACILITY BETWEEN MATJIESFONTEIN AND SUTHERLAND IN THE NORTHERN CAPE PROVINCE

SiVEST is in the process of undertaking the Environmental Impact Assessment (EIA) for the proposed development of the Rondekop Wind Energy Facility near Sutherland in the Northern Cape.

We would like to take this opportunity to inform you that, in accordance with the National Environmental Management Act, 1998 (Act No. 107 of 1998) (NEMA) (as amended), the Draft Scoping Report (DSR) for the above mentioned wind project will be available for public comment and review as from **Wednesday the 14th of November 2018 to the Friday 14th of December 2018** (before end of business day).

The DSRs as well as the accompanying appendices are available online (<http://data.g7energies.com/eia/rondekop>) and an electronic copy (on CD) has been posted to you. We kindly request that you submit your comments to the Public Participation Office at the below details, on or before Friday the 14th of December 2018 (before end of business day). SiVEST will forward any comments received after the public comment and review period directly to the relevant case officer at the Department of Environmental Affairs (DEA).

Should you have any questions or queries please do not hesitate to contact us at:

Hlengiwe Ntuli

PO Box 2921, RIVONIA, 2128

Phone: (011) 798 0600

E-mail: hlengiwen@sivest.co.za

Fax: (011) 803 7272

Kind Regards

Shivani Naidoo

Environmental Consultant

SiVEST Environmental Division



SiVEST is a Level 3 BBBEE Contributor

D +27 11 798 0600 | **T** +27 11 798 0600 **W** www.sivest.co.za

Engineering Consulting | Project Management | Environmental Consulting | Town & Regional Planning | Management Systems Consulting

Durban | Johannesburg | Pretoria | Pietermaritzburg | Richards Bay | Port Louis (Mauritius)

Disclaimer

The information contained in this communication from the sender is confidential. It is intended solely for use by the recipient and others authorized to receive it. If you are not the recipient, you are hereby notified that any disclosure, copying, distribution or taking action in relation of the contents of this information is strictly prohibited and may be unlawful.

This email has been scanned for viruses and malware, and automatically archived by **Mimecast SA (Pty) Ltd**, an innovator in

Software as a Service (SaaS) for business. **Mimecast Unified Email Management ??? (UEM)** offers email continuity, security, archiving and compliance with all current legislation. To find out more, [contact Mimecast](#).

Email secured by Check Point



Confidentiality and Disclaimer Notice: This email contains the South African Civil Aviation Authority

(◆SACAA◆) confidential information intended only for the person to whom it is addressed and access to this e-mail by anyone else is unauthorized. Any recipient who is not a named addressee is not entitled to read the rest of the email or disclose its contents to any person or take copies. An incorrect addressee is requested to notify SACAA immediately by return email. Whilst all reasonable steps are taken to ensure the accuracy and integrity of information and data transmitted electronically and to preserve the confidentiality thereof, no liability or responsibility whatsoever is accepted if information or data is, for whatever reason, corrupted or does not reach its intended destination. In the event that this e mail is of a personal nature and not business related, the recipient must note that this e-mail is not authorised by, or sent on behalf of the senders employer.



Confidentiality and Disclaimer Notice: This email contains the South African Civil Aviation Authority

(◆SACAA◆) confidential information intended only for the person to whom it is addressed and access to this e-mail by anyone else is unauthorized. Any recipient who is not a named addressee is not entitled to read the rest of the email or disclose its contents to any person or take copies. An incorrect addressee is requested to notify SACAA immediately by return email. Whilst all reasonable steps are taken to ensure the accuracy and integrity of information and data transmitted electronically and to preserve the confidentiality thereof, no liability or responsibility whatsoever is accepted if information or data is, for whatever reason, corrupted or does not reach its intended destination. In the event that this e mail is of a personal nature and not business related, the recipient must note that this e-mail is not authorised by, or sent on behalf of the senders employer.

This email has been scanned for email related threats and delivered safely by Mimecast.
For more information please visit <http://www.mimecast.com>



environmental affairs

Department:
Environmental Affairs
REPUBLIC OF SOUTH AFRICA

Private Bag X 447 · PRETORIA · 0001 · Environment House · 473 Steve Biko Road, Arcadia, · PRETORIA
Tel (27 12) 399 9372

DEA Reference: Rondekop WEF
Enquiries: Ms Mmatlala Rabothata
Telephone: (012) 399 9174 **E-mail:** MRabothata@environment.gov.za

Andrea Gibb
SiVEST
PO Box 2921
RIVONIA
2128

Telephone Number: 011 798 0638
Email Address: andreaq@sivest.co.za

Dear Sir/Madam

COMMENTS ON THE DRAFT SCOPING REPORT (DSR) FOR THE PROPOSED CONSTRUCTION OF THE 325MW RONDEKOP WIND ENERGY FACILITY BETWEEN MATJIESFONTEIN AND SUTHERLAND, NORTHERN CAPE PROVINCE

The Directorate: Biodiversity Conservation has reviewed and evaluated the aforementioned report and its specialist's studies. The following recommendations must be included in the Final Scoping Report (FSR).

- A detailed site Rehabilitation Plan should be developed and included in the final Scoping Report;
- If several plant species of conservation concern (SCC) which are protected are identified in the study area, the Search and Rescue Plan must be compiled by a qualified ecologist and submitted for review;
- An alien invasive species eradication plan must be developed, in order to reduce the establishment and spread of alien plant species within the development footprint;
- A terrestrial ecological study, avifaunal and Bat study and aquatic impact assessment study must be undertaken and be included as part of the final Scoping Report;
- A Pre-construction Bird and Bat Monitoring Program should be conducted so as to inform the EIA and confirm the predicted impacts and significance as well as proposed appropriate mitigation measures;
- It is noted in the report that there is a number of plants species that are provincially protected by the Northern Cape Nature Conservation Act, (Act No. 9 of 2009) and one protected

according National Environmental Management: Biodiversity Act (Act No 10. Of 2004) (NEM:BA), therefore a permit to destroy them must be obtained from the relevant Authorities;

- The proposed development site falls within an area classified as Critical Biodiversity Area (CBA): Optimal area; therefore the Environmental Management Programme (EMPr) to be submitted as part of the final Scoping Report and must clearly indicate the biodiversity impacts that might occur as a result of the proposed project and the proposed mitigation measures thereof;
- You are further advised to consider or make reference to any Provincial Biodiversity Conservation Plan or guideline in your report.

The overall biodiversity objective is to minimise loss to biodiversity as possible. In order to achieve this objective the above mentioned recommendations must be adhered to.

Yours faithfully

pp 

Mr Stanley Tshitwamulomoni
Acting Director: Biodiversity Conservation
Department of Environmental Affairs
Date: 14/12/2018

Hlengiwe Ntuli

From: MMatlala Rabothata <MRabothata@environment.gov.za>
Sent: Friday, 14 December 2018 11:07 AM
To: Andrea Gibb; Hlengiwe Ntuli; sivist_PPP
Subject: FW: Rondekop Wind Energy Facility near Sutherland: DSR Comment Period Ending
Attachments: Signed Comments for DSR Rondekop WEF.pdf

Importance: High

Dear Andrea,

Please find the attached comments requested for your attention.

Regards,

*Ms Mmatlala Rabothata
Department of Environmental Affairs
Environment House
473 Steve Biko Rd
Arcadia
Pretoria
Tel: 012 -399 9174
E-mail: MRabothata@environment.gov.za*

Postal Address:

*P/Bag x 447
Pretoria
0001*

From: sivist_PPP [mailto:sivist_ppp@sivist.co.za]

Sent: 12 December 2018 10:14 AM

To: Andrea Gibb; Shivani Naidoo; 'Veronique Fyfe'; Liandra Scott-Shaw

Cc: 'Henning Myburg'; 'Simphiwe Masilela'; 'Johanna Morobane'; 'Phillip De Lange'; 'Ferdie Smit'; 'Candice Stevens'; 'Samantha Ralston-Paton'; 'Jacoline Mans'; 'Paul Avenant'; 'Colonel Loy de Jager'; MMatlala Rabothata; Seoka Lekota; 'Ntsundeni Ravhogoni'; 'Patrick Lenyibi'; 'Ester Makungo'; 'Moses Mahunonyane'; 'Brian Fisher'; 'Andre Crous'; 'John Geering'; 'Lourens Leeuwner'; 'Allistar Gibbons'; 'Jannie Loubser'; 'Gert Steenkamp'; 'Jaco Roelofse'; 'Thulani Mthombeni'; 'Lizell Stroh'; 'Nicole Abrahams'; 'Mlungisi Ngwenya'; 'Frank Creese'; 'Alisha Pretorius'; 'Johan Koegelenberg'; 'Ramatholo Sefako'; 'Danie Erasmus'; 'Adriaan Tiplady'; 'Keverne Thurling'; 'Heleen van den Heever'; 'Amanda Bester'; 'Morgan Griffiths'; 'Administration'; 'Johan'; 'Adriaan Tiplady'; 'Alisha Pretorius'; 'Allistar Gibbons'; 'Amanda Bester'; 'Andre Crous'; 'Brian Fisher'; 'Candice Stevens'; 'Charles van Reenen'; 'Coert Smit'; 'Colonel Loy de Jager'; 'Craig Barnes'; 'Danie Erasmus'; 'Ester Makungo'; 'Ferdie Smit'; 'Frank Creese'; 'Gert Steenkamp'; 'Giel Klazen'; 'Heleen van den Heever'; 'Henning Myburg'; 'J Martiens'; 'Jaco Roelofse'; 'Jacobus Jooste'; 'Jacoline Mans'; 'Jan Johannes Jacobs'; 'Jannie Loubser'; 'Jeremy Davids'; 'Johan Koegelenberg'; 'Johan van der Colff'; 'Johanna Morobane'; 'John Geering'; 'Keverne Thurling'; 'Lizell Stroh'; 'Lourens Leeuwner'; 'M Malan'; MMatlala Rabothata; 'Morgan Griffiths'; 'Moses Mahunonyane'; 'Nelly Boshie'; 'Nicole Abrahams'; 'Ntsundeni Ravhogoni'; 'Patrick Lenyibi'; 'Paul Avenant'; 'Phillip De Lange'; 'Ramatholo Sefako'; 'Rasibe Sekepane'; 'Rene De Kock'; 'Ronell Cloete'; 'S Frans'; 'Sam Fiff'; 'Samantha Ralston-Paton'; Seoka Lekota; 'Simphiwe Masilela'; 'Thoko Buthelezi'; 'Thulani Mthombeni'; 'Tshegofatso Monama'; 'Veruschka Wentzel'; 'Vincent Muila'; 'Vivian Kiewitz'; 'Willenise Klein'; 'ruth.cuttings@yahoo.com'; 'Mpho Sebole'; 'Obstacles@caa.co.za'; 'isak@breedenet.co.za'; 'kmothomi@ncpg.gov.za'; 'mayorv@karoohoogland.gov.za'

Subject: Rondekop Wind Energy Facility near Sutherland: DSR Comment Period Ending

Importance: High

Dear Stakeholder,

SiVEST sent the Draft Scoping report for the proposed 325MW Rondekop Wind Energy facility between Matjiesfontein and Sutherland in the Northern Cape province to your department on 14th November 2018 for comment (refer to the below email). Please can you advise if comments will be submitted to us for inclusion in the final Scoping Report.

We would like to inform you that the comment period is ending on **Friday 14th December 2018** and you are advised to please send comments as soon as possible.

Should you have any comments, please feel free to contact the public participation office at the details below:

Sivest Environmental

PO Box 2921, RIVONIA, 2128

Phone: (011) 798 0600

E-mail: hlengiwen@sivest.co.za / Sivest_ppp@sivest.co.za

Fax: (011) 803 7272

Kind Regards

Shivani Naidoo

Environmental Consultant

SiVEST Environmental Division



SiVEST is a Level 3 BBBEE Contributor

D +27 11 798 0600 | **T** +27 11 798 0600 **W** www.sivest.co.za

Engineering Consulting | Project Management | Environmental Consulting | Town & Regional Planning | Management Systems Consulting

Durban | Johannesburg | Pretoria | Pietermaritzburg | Richards Bay | Port Louis (Mauritius)

From: sivest_PPP

Sent: 14 November 2018 05:40 PM

To: Andrea Gibb <AndreaG@sivest.co.za>; Shivani Naidoo <ShivaniN@sivest.co.za>; 'Veronique Fyfe' <veronique@g7energies.com>

Cc: 'Henning Myburg' <henning@agrink.co.za>; 'Simpfiwe Masilela' <ObstacleEvaluators@atns.co.za>; 'Johanna Morobane' <JohannaM@atns.co.za>; 'Phillip De Lange' <phillipd@atns.co.za>; 'Ferdie Smit' <ferdis@atns.co.za>; 'Candice Stevens' <advocacy@birdlife.org.za>; 'Samantha Ralston-Paton' <energy@birdlife.org.za>; 'Jacoline Mans' <jacolinema@daff.gov.za>; 'Paul Avenant' <paula@daff.gov.za>; 'Colonel Loy de Jager' <loydejager@hotmail.com>; 'Mmatlala Rabothata' <mrabothata@environment.gov.za>; 'Seoka Lekota' <slekota@environment.gov.za>; 'Ntsundeni Ravhogoni' <Ntsundeni.Ravhogoni@dmr.gov.za>; 'Patrick Lenyibi' <plenyibi@ncpg.gov.za>; 'Ester Makungo' <makungoe@dws.gov.za>; 'Moses Mahunonyane' <MahunonyaneM@dws.gov.za>; 'Brian Fisher' <bfisher@ncpg.gov.za>; 'Andre Crous' <andre.crous@eskom.co.za>; 'John Geeringh' <GeerinJH@eskom.co.za>; 'Lourens Leeuwner' <lourensl@ewt.org.za>; 'Allistar Gibbons' <a.gibbons@karoohoogland.gov.za>; 'Jannie Loubser' <janniel@namakwa-dm.gov.za>; 'Gert Steenkamp' <gsteenkamp@ncpg.gov.za>; 'Jaco Roelofse' <roelofse.j@vodamail.co.za>; 'Thulani Mthombeni' <tmtho@webmail.co.za>; 'Lizell Strohl' <strohl@caa.co.za>; 'Nicole Abrahams' <AbrahamsN@nra.co.za>; 'Mlungisi Ngwenya' <Mlungisi.Ngwenya@weathersa.co.za>; 'Frank Creese' <creesef@sentech.co.za>; 'Alisha Pretorius' <pretoriusa@sentech.co.za>; 'Johan Koegelenberg' <KoegelenbergJ@sentech.co.za>; 'Ramatholo Sefako' <rrs@saao.ac.za>; 'Danie Erasmus' <radiotech@saps.org.za>; 'Adriaan Tiplady' <atiplady@ska.ac.za>; 'Keverne Thurling' <Thurling@telkom.co.za>; 'Heleen van den Heever' <vdheevhd@telkom.co.za>; 'Amanda Bester' <WayleaCR@telkom.co.za>; 'Morgan Griffiths' <morgan.griffiths@wessa.co.za>

Subject: Rondekop Wind Energy Facility near Sutherland: DSR Comment Period Starting

Dear Stakeholder

ENVIRONMENTAL IMPACT ASSESSMENT PROCESS (EIA) FOR THE PROPOSED 325MW RONDEKOP WIND ENERGY FACILITY BETWEEN MATJIESFONTEIN AND SUTHERLAND IN THE NORTHERN CAPE PROVINCE

SiVEST is in the process of undertaking the Environmental Impact Assessment (EIA) for the proposed development of the Rondekop Wind Energy Facility near Sutherland in the Northern Cape.

We would like to take this opportunity to inform you that, in accordance with the National Environmental Management Act, 1998 (Act No. 107 of 1998) (NEMA) (as amended), the Draft Scoping Report (DSR) for the above mentioned wind project will be available for public comment and review as from **Wednesday the 14th of November 2018 to the Friday 14th of December 2018** (before end of business day).

The DSRs as well as the accompanying appendices are available online (<http://data.g7energies.com/eia/rondekop>) and an electronic copy (on CD) has been posted to you. We kindly request that you submit your comments to the Public Participation Office at the below details, on or before Friday the 14th of December 2018 (before end of business day). SiVEST will forward any comments received after the public comment and review period directly to the relevant case officer at the Department of Environmental Affairs (DEA).

Should you have any questions or queries please do not hesitate to contact us at:

Hlengiwe Ntuli

PO Box 2921, RIVONIA, 2128

Phone: (011) 798 0600

E-mail: hlengiwen@sivest.co.za

Fax: (011) 803 7272

Kind Regards

Shivani Naidoo

Environmental Consultant

SiVEST Environmental Division



SiVEST is a Level 3 BBBEE Contributor

D +27 11 798 0600 | **T** +27 11 798 0600 **W** www.sivest.co.za

Engineering Consulting | Project Management | Environmental Consulting | Town & Regional Planning | Management Systems Consulting

Durban | Johannesburg | Pretoria | Pietermaritzburg | Richards Bay | Port Louis (Mauritius)

Disclaimer

The information contained in this communication from the sender is confidential. It is intended solely for use by the recipient and others authorized to receive it. If you are not the recipient, you are hereby notified that any disclosure, copying, distribution or taking action in relation of the contents of this information is strictly prohibited and may be unlawful.

This email has been scanned for viruses and malware, and automatically archived by **Mimecast SA (Pty) Ltd**, an innovator in Software as a Service (SaaS) for business. **Mimecast Unified Email Management ??? (UEM)** offers email continuity, security, archiving and compliance with all current legislation. To find out more, [contact Mimecast](#).

'Please consider the environment before you print this email'

'Please consider the environment before you print this email'

This message and any attachments transmitted with it are intended solely for the addressee(s) and may be legally privileged and/or confidential. If you have received this message in error please destroy it and notify the sender. Any unauthorized usage, disclosure, alteration or dissemination is prohibited. The Department of Environmental Affairs accepts no responsibility for any loss whether it be direct, indirect or consequential, arising from information made available and actions resulting there from. The views and opinions expressed in this e-mail message may not necessarily be those of Management.



an agency of the
Department of Arts and Culture

T: +27 21 462 4502 | F: +27 21 462 4509 | E: info@sahra.org.za
South African Heritage Resources Agency | 111 Harrington Street | Cape Town
P.O. Box 4637 | Cape Town | 8001
www.sahra.org.za

Enquiries: Natasha Higgitt
Tel: 021 462 4502
Email: nhiggitt@sahra.org.za
CaseID: 13209

Date: Wednesday December 19, 2018
Page No: 1

Interim Comment

In terms of Section 38(8) of the National Heritage Resources Act (Act 25 of 1999)

Attention: SiVEST SA (Pty) Ltd

Proposed Construction of the 325MW Rondekop Wind Energy Facility between Matjiesfontein and Sutherland, Northern Cape Province

Sivest SA (Pty) Ltd has been appointed by Rondekop Wind Farm (Pty) Ltd to conduct an Environmental Authorisation (EA) Application process for the proposed Rondekop Wind Energy Facility near Sutherland, Northern Cape Province. A draft Scoping Report (DSR) has been completed in terms of the National Environmental Management Act, 1998 (NEMA) and the 2017 NEMA Environmental Impact Assessment (EIA) Regulations. The proposed development will include the construction of a WEF comprising up to 48 turbines with associated infrastructure such as crane pads and turbine foundations, access roads with alternative routes, one on-site substation with alternative locations, a construction camp with alternative locations, underground cabling, and four (4) wind measuring lattice masts.

PGS Heritage and Banzai Environmental have been appointed to provide heritage input into the EA Application process as per section 38(8) of the National Heritage Resources Act, Act 25 of 1999 (NHRA).

Smeyatsky, I and Hutton, M. 2018. Heritage Impact Assessment: Environmental Impact Assessment for the proposed 325MW Rondekop Wind Energy Facility between Matjiesfontein and Sutherland, Northern Cape Province.

A total of five (5) heritage resources were identified within the proposed development footprint. These include three (3) surface find spots of Later Stone Age (LSA) and Middle Stone Age (MSA) lithics of low heritage significance, a memorial of medium heritage significance and a stone built house with stone-walled kraal and dip of medium heritage significance. None of the identified heritage resources will be directly impacted by the proposed development. The cultural landscape encapsulated in the Visual Impact Assessment (VIA) conducted as part of the EA application, is defined as a typical Karoo landscape, with no significant scenic route close by.

Recommendations provided in the report include the following:



an agency of the
Department of Arts and Culture

T: +27 21 462 4502 | F: +27 21 462 4509 | E: info@sahra.org.za
South African Heritage Resources Agency | 111 Harrington Street | Cape Town
P.O. Box 4637 | Cape Town | 8001
www.sahra.org.za

Enquiries: Natasha Higgitt
Tel: 021 462 4502
Email: nhiggitt@sahra.org.za

Date: Wednesday December 19, 2018

Page No: 2

CaseID: 13209

- A 20 m buffer should be applied to all Stone Age find spots and sites;
- A 50 m buffer should be applied to all monuments, colonial buildings and stone walled kraals;
- The Environmental Control Officer (ECO) must be provided the location of the heritage sites and these must be monitored during excavations;
- An archaeological walk down of the final approved layout will be required before construction commences;
- Any heritage features of significance identified during this walk down will require formal mitigation or where possible a slight change in design could accommodate such resources;
- A management plan for the heritage resources needs then to be compiled and approved for implementation during construction and operations; and
- A chance finds protocol must be developed that must include the procedure to follow regarding work stoppage, site protection and evaluation and informing SAHRA of such finds and a final process of mitigation implementation.

Butler, E. 2018. Palaeontological Impact Assessment: Environmental Impact Assessment for the proposed 325MW Rondekop Wind Energy Facility between Matjiesfontein and Sutherland, Northern Cape Province.

The proposed development area is underlain by the Abrahamskraal Formation (Adelaide Subgroup, lower Beaufort Group, Karoo Supergroup) and the Waterford Formation (Ecca Group, Karoo Supergroup). Known fossil material within the Abrahamskraal Formation includes material from the *Tapinocephalus* Assemblage Zone, while the Waterford Formation is known to contain tetrapod bones, fish scales and coprolites, non-marine bivalves, insects and *Glossopteris* flora.

Exposed bedrock was inspected during the site visit, and no fossil material was identified. The overall palaeontological sensitivity is rated as low and the impact to palaeontological resources is expected to be low.

Recommendations provided in the report include

- Monitoring of major excavations (deeper than 1 m) for fossil material by the ECO on an on-going basis during construction phase;
- Significant fossil finds to be reported to SAHRA for recording and sampling by a professional palaeontologist; and
- A Chance Finds procedure must be followed.

Our Ref:



an agency of the
Department of Arts and Culture

T: +27 21 462 4502 | F: +27 21 462 4509 | E: info@sahra.org.za
South African Heritage Resources Agency | 111 Harrington Street | Cape Town
P.O. Box 4637 | Cape Town | 8001
www.sahra.org.za

Enquiries: Natasha Higgitt
Tel: 021 462 4502
Email: nhiggitt@sahra.org.za
CaseID: 13209

Date: Wednesday December 19, 2018
Page No: 3

Interim Comment

The SAHRA Archaeology, Palaeontology and Meteorites (APM) Unit notes the submitted HIA inclusive of a Palaeontological Impact Assessment (PIA). The SAHRA APM unit has no objections to the proposed development at present and agrees with the recommendations of the specialists in principle, however, SAHRA will reserve the right to make a Final Comment at this time.

The Final Scoping report and the draft EIA with associated appendices must be uploaded to the case when available for public review before further comments are issued.

Should you have any further queries, please contact the designated official using the case number quoted above in the case header.

Yours faithfully

Natasha Higgitt
Heritage Officer
South African Heritage Resources Agency

Phillip Hine
Acting Manager: Archaeology, Palaeontology and Meteorites Unit
South African Heritage Resources Agency

ADMIN:

Direct URL to case: <http://www.sahra.org.za/node/514787>

Our Ref:



an agency of the
Department of Arts and Culture

T: +27 21 462 4502 | F: +27 21 462 4509 | E: info@sahra.org.za
South African Heritage Resources Agency | 111 Harrington Street | Cape Town
P.O. Box 4637 | Cape Town | 8001
www.sahra.org.za

Enquiries: Natasha Higgitt
Tel: 021 462 4502
Email: nhiggitt@sahra.org.za
CaseID: 13209

Date: Wednesday December 19, 2018
Page No: 4

(DEA, Ref:)

Liandra Scott-Shaw

From: Adri La Meyer <Adri.LaMeyer@westerncape.gov.za>
Sent: Tuesday, 15 January 2019 9:23 AM
To: Liandra Scott-Shaw
Cc: Andrea Gibb; Stephan Jacobs; 'Veronique Fyfe'; Hlengiwe Ntuli
Subject: RE: 15260: Rondekop Wind Energy Facility near Sutherland: FSR Submitted to DEA

Dear Liandra,

Thank you for the quick response. Since the application does not fall within the Western Cape, the Department does not require further communication regarding the status of the application as we cannot comment on the application.

Kind regards,
Adri

From: Liandra Scott-Shaw <LiandraS@sivest.co.za>
Sent: 15 January 2019 09:04 AM
To: Adri La Meyer <Adri.LaMeyer@westerncape.gov.za>
Cc: Andrea Gibb <AndreaG@sivest.co.za>; Stephan Jacobs <StephanJ@sivest.co.za>; 'Veronique Fyfe' <veronique@g7energies.com>; Hlengiwe Ntuli <HlengiweN@sivest.co.za>
Subject: 15260: Rondekop Wind Energy Facility near Sutherland: FSR Submitted to DEA

Dear Adri

The application does not fall within the Western Cape Boundary (Please see attached KML).

Please don't hesitate to contact me if you require further information.

Kind regards

Liandra Scott-Shaw (*Pr.Sci.Nat*)
Environmental Scientist
SiVEST Environmental Division



SiVEST is a Level 3 BBBEE Contributor

T +27 33 347 1600 | **M** +2773 658 7955 | **E** liandras@sivest.co.za | **W** www.sivest.co.za

Engineering Consulting | Project Management | Environmental Consulting | Town & Regional Planning | Management Systems Consulting

Durban | Johannesburg | Pretoria | Pietermaritzburg | Richards Bay | Port Louis (Mauritius)

From: Adri La Meyer [<mailto:Adri.LaMeyer@westerncape.gov.za>]
Sent: Tuesday, 15 January 2019 7:18 AM
To: sivest_PPP
Cc: Andrea Gibb; Liandra Scott-Shaw; Stephan Jacobs; 'Veronique Fyfe'
Subject: RE: Rondekop Wind Energy Facility near Sutherland: FSR Submitted to DEA

Dear Andrea,

Your e-mail of 14 January 2019 refers. Could you please indicate whether the application falls within the Western Cape boundaries and if so, if the Department commented on the DSR? I am not aware of the application, but it could be that our EIA section received the request for comment, but failed to notify me.

Thank you and regards,
Adri

Adri La Meyer
Directorate: Development Facilitation
Department of Environmental Affairs and Development Planning
Western Cape Government

11th Floor, Utilitas Building, 1 Dorp Street, Cape Town, 8001
Private Bag X9086, Cape Town, 8000

Tel: 021 483 2887
Fax: 021 483 4185
E-mail: Adri.Lameyer@westerncape.gov.za
Website: www.westerncape.gov.za/eadp



Be 110% Green. Read from the screen.

From: sivist_PPP <sivist_ppp@sivest.co.za>
Sent: 14 January 2019 03:00 PM
Cc: Andrea Gibb <AndreaG@sivest.co.za>; Liandra Scott-Shaw <LiandraS@sivest.co.za>; Stephan Jacobs <StephanJ@sivest.co.za>; 'Veronique Fyfe' <veronique@g7energies.com>
Subject: Rondekop Wind Energy Facility near Sutherland: FSR Submitted to DEA

Dear Interested and/or Affected Party (I&AP),

ENVIRONMENTAL IMPACT ASSESSMENT (EIA) PROCESS FOR THE PROPOSED 325MW RONDEKOP WIND ENERGY FACILITY (WEF) BETWEEN MATJIESFONTEIN AND SUTHERLAND IN THE NORTHERN CAPE PROVINCE (DEA Ref No: 14/12/16/3/3/2/1115)

- **SUBMISSION OF FINAL SCOPING REPORT (FSR) TO THE DEPARTMENT OF ENVIRONMENTAL AFFAIRS (DEA)**

Following the public comment and review period of the Draft Scoping Report (DSR) for the above-mentioned proposed project from Wednesday the 14th of November 2018 to Friday the 14th of December 2018 (end of business day), the

Draft Scoping Report (DSR) was updated, taking into consideration the issues and concerns raised by Interested and/or Affected Parties (I&APs), Organs of State / Authorities, Landowners and Stakeholders, and the Final Scoping Report (FSR) was submitted to the Department of Environmental Affairs (DEA) on Monday the 14th of January 2019.

We would like to thank you in anticipation of your active and meaningful contribution to the EIA and Public Participation processes.

Kind Regards,

Geagte Belangstellende en/of Geaffekteerde Party / Belanghebbende,

OMGEWINGSIMPAKEVALUERINGSPROSES (OIE) VIR DIE BEOOGDE 325MW RONDEKOP WINDKRAGANLEG TUSSEN MATJIESFONTEIN EN SUTHERLAND IN DIE NOORD-KAAPPROVINSIE (DOS Verw. No.: 14/12/16/3/3/2/1115)

• INDIENING VAN DIE FINALE BESTEKOPNAMEVERSLAE (FBV) BY DIE DEPARTEMENT VAN OMGEWINGSAKE (DOS)

Na aanleiding van die kommentaar deur die openbare oorsigtydperk van die Konsep Bestekopnameverslag (KBV) vir die bogenoemde projek van Woensdag 14 November 2018 tot Vrydag 14 Desember 2018 (teen sluitingstyd), was die KBV bygewerk en gefinaliseer, met inagneming van die kwessies en kommentaar wat deur belanghebbendes opgewek was, en die FBV was op Maandag 14 Januarie 2019 aan die Departement van Omgewingsake (DOS) ingedien vir oorweging.

Ons dank u byvoorbaat vir u aktiewe en betekenisvolle bydrae tot die OIE en die Openbare Deelnameproses.

Vriendelike groete,

Andrea Gibb
Senior Manager
SiVEST Environmental Division



SiVEST is a Level 3 BBBEE Contributor

D +27 11 798 0638 | T +27 11 798 0600 | E andrea@sivest.co.za | W www.sivest.co.za
Engineering Consulting | Project Management | Environmental Consulting | Town & Regional Planning | Management Systems Consulting
Durban | Johannesburg | Pretoria | Pietermaritzburg | Richards Bay | Port Louis (Mauritius)

Disclaimer

The information contained in this communication from the sender is confidential. It is intended solely for use by the recipient and others authorized to receive it. If you are not the recipient, you are hereby notified that any disclosure, copying, distribution or taking action in relation of the contents of this information is strictly prohibited and may be unlawful.

This email has been scanned for viruses and malware, and automatically archived by **Mimecast SA (Pty) Ltd**, an innovator in Software as a Service (SaaS) for business. **Mimecast Unified Email Management ??? (UEM)** offers email continuity, security, archiving and compliance with all current legislation. To find out more, [contact Mimecast](#).

"All views or opinions expressed in this electronic message and its attachments are the view of the sender and do not necessarily reflect the views and opinions of the Western Cape Government (the WCG). No employee of the WCG is entitled to conclude a binding contract on behalf of the WCG unless he/she is an accounting officer of the WCG, or his or her authorised representative. The information contained in this message and its attachments may be confidential or privileged and is for the use of the named recipient only, except where the sender specifically states otherwise.
If you are not the intended recipient you may not copy or deliver this message to anyone."

Disclaimer

The information contained in this communication from the sender is confidential. It is intended solely for use by the recipient and others authorized to receive it. If you are not the recipient, you are hereby notified that any disclosure, copying, distribution or taking action in relation of the contents of this information is strictly prohibited and may be unlawful.

This email has been scanned for viruses and malware, and automatically archived by **Mimecast SA (Pty) Ltd**, an innovator in Software as a Service (SaaS) for business. **Mimecast Unified Email Management ??? (UEM)** offers email continuity, security, archiving and compliance with all current legislation. To find out more, [contact Mimecast](#).

"All views or opinions expressed in this electronic message and its attachments are the view of the sender and do not necessarily reflect the views and opinions of the Western Cape Government (the WCG). No employee of the WCG is entitled to conclude a binding contract on behalf of the WCG unless he/she is an accounting officer of the WCG, or his or her authorised representative. The information contained in this message and its attachments may be confidential or privileged and is for the use of the named recipient only, except where the sender specifically states otherwise.
If you are not the intended recipient you may not copy or deliver this message to anyone."

Liandra Scott-Shaw

From: Adri La Meyer <Adri.LaMeyer@westerncape.gov.za>
Sent: Tuesday, 15 January 2019 7:18 AM
To: sivist_PPP
Cc: Andrea Gibb; Liandra Scott-Shaw; Stephan Jacobs; 'Veronique Fyfe'
Subject: RE: Rondekop Wind Energy Facility near Sutherland: FSR Submitted to DEA

Dear Andrea,

Your e-mail of 14 January 2019 refers. Could you please indicate whether the application falls within the Western Cape boundaries and if so, if the Department commented on the DSR? I am not aware of the application, but it could be that our EIA section received the request for comment, but failed to notify me.

Thank you and regards,
Adri

Adri La Meyer
Directorate: Development Facilitation
Department of Environmental Affairs and Development Planning
Western Cape Government

11th Floor, Utilitas Building, 1 Dorp Street, Cape Town, 8001
Private Bag X9086, Cape Town, 8000

Tel: 021 483 2887
Fax: 021 483 4185
E-mail: Adri.Lameyer@westerncape.gov.za
Website: www.westerncape.gov.za/eadp



Be 110% Green. Read from the screen.

From: sivist_PPP <sivist_ppp@sivist.co.za>
Sent: 14 January 2019 03:00 PM
Cc: Andrea Gibb <AndreaG@sivist.co.za>; Liandra Scott-Shaw <LiandraS@sivist.co.za>; Stephan Jacobs <StephanJ@sivist.co.za>; 'Veronique Fyfe' <veronique@g7energies.com>
Subject: Rondekop Wind Energy Facility near Sutherland: FSR Submitted to DEA

Dear Interested and/or Affected Party (I&AP),

ENVIRONMENTAL IMPACT ASSESSMENT (EIA) PROCESS FOR THE PROPOSED 325MW RONDEKOP WIND ENERGY FACILITY (WEF) BETWEEN MATJIESFONTEIN AND SUTHERLAND IN THE NORTHERN CAPE PROVINCE (DEA Ref No: 14/12/16/3/3/2/1115)

• SUBMISSION OF FINAL SCOPING REPORT (FSR) TO THE DEPARTMENT OF ENVIRONMENTAL AFFAIRS (DEA)

Following the public comment and review period of the Draft Scoping Report (DSR) for the above-mentioned proposed project from Wednesday the 14th of November 2018 to Friday the 14th of December 2018 (end of business day), the Draft Scoping Report (DSR) was updated, taking into consideration the issues and concerns raised by Interested and/or Affected Parties (I&APs), Organs of State / Authorities, Landowners and Stakeholders, and the Final Scoping Report (FSR) was submitted to the Department of Environmental Affairs (DEA) on Monday the 14th of January 2019.

We would like to thank you in anticipation of your active and meaningful contribution to the EIA and Public Participation processes.

Kind Regards,

Geagte Belangstellende en/of Geaffekteerde Party / Belanghebbende,

OMGEWINGSIMPAKEVALUERINGSPROSES (OIE) VIR DIE BEOOGDE 325MW RONDEKOP WINDKRAGANLEG TUSSEN MATJIESFONTEIN EN SUTHERLAND IN DIE NOORD-KAAPPROVINSIE (DOS Verw. No.: 14/12/16/3/3/2/1115)

• INDIENING VAN DIE FINALE BESTEKOPNAMEVERSLAE (FBV) BY DIE DEPARTEMENT VAN OMGEWINGSAKE (DOS)

Na aanleiding van die kommentaar deur die openbare oorsigtydperk van die Konsep Bestekopnameverslag (KBV) vir die bogenoemde projek van Woensdag 14 November 2018 tot Vrydag 14 Desember 2018 (teen sluitingstyd), was die KBV bygewerk en gefinaliseer, met inagneming van die kwessies en kommentaar wat deur belanghebbendes opgewek was, en die FBV was op Maandag 14 Januarie 2019 aan die Departement van Omgewingsake (DOS) ingedien vir oorweging.

Ons dank u byvoorbaat vir u aktiewe en betekenisvolle bydrae tot die OIE en die Openbare Deelnameproses.

Vriendelike groete,

Andrea Gibb
Senior Manager
SiVEST Environmental Division



SiVEST is a Level 3 BBBEE Contributor

D +27 11 798 0638 | T +27 11 798 0600 | E andreaq@sivest.co.za | W www.sivest.co.za
Engineering Consulting | Project Management | Environmental Consulting | Town & Regional Planning | Management Systems Consulting
Durban | Johannesburg | Pretoria | Pietermaritzburg | Richards Bay | Port Louis (Mauritius)

Disclaimer

The information contained in this communication from the sender is confidential. It is intended solely for use by the recipient and others authorized to receive it. If you are not the recipient, you are hereby notified that any disclosure, copying, distribution or taking action in relation of the contents of this information is strictly prohibited and may be unlawful.

This email has been scanned for viruses and malware, and automatically archived by **Mimecast SA (Pty) Ltd**, an innovator in Software as a Service (SaaS) for business. **Mimecast Unified Email Management ??? (UEM)** offers email continuity, security, archiving and compliance with all current legislation. To find out more, [contact Mimecast](#).

"All views or opinions expressed in this electronic message and its attachments are the view of the sender and do not necessarily reflect the views and opinions of the Western Cape Government (the WCG). No employee of the WCG is entitled to conclude a binding contract on behalf of the WCG unless he/she is an accounting officer of the WCG, or his or her authorised representative. The information contained in this message and its attachments may be confidential or privileged and is for the use of the named recipient only, except where the sender specifically states otherwise.
If you are not the intended recipient you may not copy or deliver this message to anyone."

sivest_PPP

From: Ontvangs <ontvangs@agrink.co.za>
Sent: 25 February 2019 08:26 AM
To: Sutherland LU : Abra van Wyk
Cc: sivest_PPP
Subject: FW: Rondekop Wind Energy Facility near Sutherland: FSR Accepted by DEA
Attachments: 15260_ROMDEKOP WIND ENERGY FACILITY EIA Newsletter.pdf; 15260_ROMDEKOP WIND ENERGY FACILITY EIA News Letter (Afrikaans).pdf

Goeie dag Abra

Sien asseblief meegaande dokumentasie vir jou kennisname en verdere hantering indien nodig.

Baie dankie

Vriendelike groete

Lucelle van Niekerk

ONTVANGS : AGRI NOORD-KAAP

E-pos : ontvangs@agrink.co.za

Tel : (053) 83 29595

Faks : (053) 83 27126



From: sivest_PPP [mailto:sivest_ppp@sivest.co.za]
Sent: Friday, February 22, 2019 4:30 PM
Cc: Andrea Gibb <AndreaG@sivest.co.za>; Liandra Scott-Shaw <LiandraS@sivest.co.za>; Stephan Jacobs <StephanJ@sivest.co.za>
Subject: Rondekop Wind Energy Facility near Sutherland: FSR Accepted by DEA

Dear Interested and/or Affected Party (I&AP)

We would like to take this opportunity to inform you that the Department of Environmental Affairs (DEA) has accepted the Final Scoping Report (FSR) and approved the Plan of Study (PoS) for the Environmental Impact Assessment (EIA) Phase of the above-mentioned project.

Attached is the English and Afrikaans EIA Newsletter for your information.

Best Regards,

.....
Geagte Geaffekteerde en/of Belanghebbende

Ons wil graag hierdie geleentheid gebruik om u in kennis te stel dat die Departement van Omgewingsake (DOS) die Finale Omvangsbepalingsverslag aanvaar het en die Studieplan vir die Omgewingsimpakevaluering (OIE) van die bogenoemde projek goedgekeur het.

Vind asseblief aangeheg die Engelse en Afrikaanse OIE-nuusbrief vir jou inligting.

Die uwe,

Liandra Scott-Shaw (*Pr.Sci.Nat*)

Environmental Scientist

SiVEST Environmental Division



SiVEST is a Level 3 BBBEE Contributor

T +27 11 798 0600 | **E** liandras@sivest.co.za | **W** www.sivest.co.za

Engineering Consulting | Project Management | Environmental Consulting | Town & Regional Planning | Management Systems Consulting
Durban | Johannesburg | Pretoria | Pietermaritzburg | Richards Bay | Port Louis (Mauritius)

Disclaimer

The information contained in this communication from the sender is confidential. It is intended solely for use by the recipient and others authorized to receive it. If you are not the recipient, you are hereby notified that any disclosure, copying, distribution or taking action in relation of the contents of this information is strictly prohibited and may be unlawful.

This email has been scanned for viruses and malware, and automatically archived by **Mimecast SA (Pty) Ltd**, an innovator in Software as a Service (SaaS) for business. **Mimecast Unified Email Management** (UEM) offers email continuity, security, archiving and compliance with all current legislation. To find out more, [contact Mimecast](#).



**Appendix 7D2
TO Authorities**

Liandra Scott-Shaw

From: Liandra Scott-Shaw
Sent: Friday, 14 December 2018 11:51 AM
To: MRabothata@environment.gov.za
Cc: Marelize Berning; Andrea Gibb; Hlengiwe Ntuli; Veronique Fyfe; Shivani Naidoo
Subject: 15260: Rondekop Wind Energy Facility near Sutherland: DSR Comment Period Ending

Tracking:	Recipient	Read
	MRabothata@environment.gov.za	
	Marelize Berning	Read: 2018/12/14 11:52 AM
	Andrea Gibb	Read: 2018/12/14 12:24 PM
	Hlengiwe Ntuli	Read: 2018/12/14 2:47 PM
	Veronique Fyfe	
	Shivani Naidoo	

Dear Mmatalala

Thank you for your comments.

Kind regards

Liandra Scott-Shaw (*Pr.Sci.Nat*)
Environmental Scientist
SiVEST Environmental Division



SiVEST is a Level 3 BBBEE Contributor

T +27 33 347 1600 | **M** +2773 658 7955 | **E** liandras@sivest.co.za | **W** www.sivest.co.za

Engineering Consulting | Project Management | Environmental Consulting | Town & Regional Planning | Management Systems Consulting

Durban | Johannesburg | Pretoria | Pietermaritzburg | Richards Bay | Port Louis (Mauritius)

From: MMatlala Rabothata <MRabothata@environment.gov.za>
Sent: Friday, 14 December 2018 11:07 AM
To: Andrea Gibb <AndreaG@sivest.co.za>; Hlengiwe Ntuli <HlengiweN@sivest.co.za>; sivist_PPP <sivist_ppp@sivest.co.za>
Subject: FW: Rondekop Wind Energy Facility near Sutherland: DSR Comment Period Ending
Importance: High

Dear Andrea,

Please find the attached comments requested for your attention.

Regards,
Ms Mmatlala Rabothata
Department of Environmental Affairs
Environment House

473 Steve Biko Rd
Arcadia
Pretoria
Tel: 012 -399 9174
E-mail: MRabothata@environment.gov.za

Postal Address:
P/Bag x 447
Pretoria
0001

From: sivest_PPP [mailto:sivest_ppp@sivest.co.za]

Sent: 12 December 2018 10:14 AM

To: Andrea Gibb; Shivani Naidoo; 'Veronique Fyfe'; Liandra Scott-Shaw

Cc: 'Henning Myburg'; 'Simphiwe Masilela'; 'Johanna Morobane'; 'Phillip De Lange'; 'Ferdie Smit'; 'Candice Stevens'; 'Samantha Ralston-Paton'; 'Jacoline Mans'; 'Paul Avenant'; 'Colonel Loy de Jager'; MMatlala Rabothata; Seoka Lekota; 'Ntsundeni Ravhogoni'; 'Patrick Lenyibi'; 'Ester Makungo'; 'Moses Mahunonyane'; 'Brian Fisher'; 'Andre Crous'; 'John Geeringh'; 'Lourens Leeuwner'; 'Allistar Gibbons'; 'Jannie Loubser'; 'Gert Steenkamp'; 'Jaco Roelofse'; 'Thulani Mthombeni'; 'Lizell Stroh'; 'Nicole Abrahams'; 'Mlungisi Ngwenya'; 'Frank Creese'; 'Alisha Pretorius'; 'Johan Koegelenberg'; 'Ramatholo Sefako'; 'Danie Erasmus'; 'Adriaan Tiplady'; 'Keverne Thurling'; 'Heleen van den Heever'; 'Amanda Bester'; 'Morgan Griffiths'; 'Administration'; 'Johan'; 'Adriaan Tiplady'; 'Alisha Pretorius'; 'Allistar Gibbons'; 'Amanda Bester'; 'Andre Crous'; 'Brian Fisher'; 'Candice Stevens'; 'Charles van Reenen'; 'Coert Smit'; 'Colonel Loy de Jager'; 'Craig Barnes'; 'Danie Erasmus'; 'Ester Makungo'; 'Ferdie Smit'; 'Frank Creese'; 'Gert Steenkamp'; 'Giel Klazen'; 'Heleen van den Heever'; 'Henning Myburg'; 'J Martiens'; 'Jaco Roelofse'; 'Jacobus Jooste'; 'Jacoline Mans'; 'Jan Johannes Jacobs'; 'Jannie Loubser'; 'Jeremy Davids'; 'Johan Koegelenberg'; 'Johan van der Colff'; 'Johanna Morobane'; 'John Geeringh'; 'Keverne Thurling'; 'Lizell Stroh'; 'Lourens Leeuwner'; 'M Malan'; MMatlala Rabothata; 'Morgan Griffiths'; 'Moses Mahunonyane'; 'Nelly Boshieho'; 'Nicole Abrahams'; 'Ntsundeni Ravhogoni'; 'Patrick Lenyibi'; 'Paul Avenant'; 'Phillip De Lange'; 'Ramatholo Sefako'; 'Rasibe Sekepane'; 'Rene De Kock'; 'Ronell Cloete'; 'S Frans'; 'Sam Fiff'; 'Samantha Ralston-Paton'; Seoka Lekota; 'Simphiwe Masilela'; 'Thoko Buthelezi'; 'Thulani Mthombeni'; 'Tshegofatso Monama'; 'Veruschka Wentzel'; 'Vincent Muila'; 'Vivian Kiewitz'; 'Willenise Klein'; 'ruth.cuttings@yahoo.com'; 'Mpho Sebole'; 'Obstacles@caa.co.za'; 'isak@breedenet.co.za'; 'kmothomi@ncpg.gov.za'; 'mayorv@karoohoogland.gov.za'

Subject: Rondekop Wind Energy Facility near Sutherland: DSR Comment Period Ending

Importance: High

Dear Stakeholder,

SiVEST sent the Draft Scoping report for the proposed 325MW Rondekop Wind Energy facility between Matjiesfontein and Sutherland in the Northern Cape province to your department on 14th November 2018 for comment (refer to the below email). Please can you advise if comments will be submitted to us for inclusion in the final Scoping Report.

We would like to inform you that the comment period is ending on **Friday 14th December 2018** and you are advised to please send comments as soon as possible.

Should you have any comments, please feel free to contact the public participation office at the details below:

Sivest Environmental
PO Box 2921, RIVONIA, 2128
Phone: (011) 798 0600
E-mail: hengiwen@sivest.co.za / Sivest_ppp@sivest.co.za
Fax: (011) 803 7272

Kind Regards

Shivani Naidoo

Environmental Consultant

SiVEST Environmental Division



SiVEST is a Level 3 BBBEE Contributor

D +27 11 798 0600 | T +27 11 798 0600 W www.sivest.co.za

Engineering Consulting | Project Management | Environmental Consulting | Town & Regional Planning | Management Systems Consulting

Durban | Johannesburg | Pretoria | Pietermaritzburg | Richards Bay | Port Louis (Mauritius)

From: sivest_PPP

Sent: 14 November 2018 05:40 PM

To: Andrea Gibb <AndreaG@sivest.co.za>; Shivani Naidoo <ShivaniN@sivest.co.za>; 'Veronique Fyfe' <veronique@g7energies.com>

Cc: 'Henning Myburg' <henning@agrink.co.za>; 'Simphiwe Masilela' <ObstacleEvaluators@atns.co.za>; 'Johanna Morobane' <JohannaM@atns.co.za>; 'Phillip De Lange' <phillipd@atns.co.za>; 'Ferdie Smit' <ferdis@atns.co.za>; 'Candice Stevens' <advocacy@birdlife.org.za>; 'Samantha Ralston-Paton' <energy@birdlife.org.za>; 'Jacoline Mans' <jacolinema@daff.gov.za>; 'Paul Avenant' <paula@daff.gov.za>; 'Colonel Loy de Jager' <loydejager@hotmail.com>; 'Mmatlala Rabothata' <mrabothata@environment.gov.za>; 'Seoka Lekota' <slekota@environment.gov.za>; 'Ntsundeni Ravhogoni' <Ntsundeni.Ravhogoni@dmr.gov.za>; 'Patrick Lenyibi' <plenyibi@ncpg.gov.za>; 'Ester Makungo' <makungoe@dws.gov.za>; 'Moses Mahunonyane' <MahunonyaneM@dws.gov.za>; 'Brian Fisher' <bfisher@ncpg.gov.za>; 'Andre Crous' <andre.crous@eskom.co.za>; 'John Geering' <GeerinJH@eskom.co.za>; 'Lourens Leeuwner' <lourensl@ewt.org.za>; 'Allistar Gibbons' <a.gibbons@karoohoogland.gov.za>; 'Jannie Loubser' <janniell@namakwa-dm.gov.za>; 'Gert Steenkamp' <gsteenkamp@ncpg.gov.za>; 'Jaco Roelofse' <roelofse.j@vodamail.co.za>; 'Thulani Mthombeni' <tmtho@webmail.co.za>; 'Lizell Strohl' <strohl@caa.co.za>; 'Nicole Abrahams' <AbrahamsN@nra.co.za>; 'Mlungisi Ngwenya' <Mlungisi.Ngwenya@weathersa.co.za>; 'Frank Creese' <creesef@sentech.co.za>; 'Alisha Pretorius' <pretoriusa@sentech.co.za>; 'Johan Koegelenberg' <KoegelenbergJ@sentech.co.za>; 'Ramatholo Sefako' <rrs@saao.ac.za>; 'Danie Erasmus' <radiotech@saps.org.za>; 'Adriaan Tiplady' <atiplady@ska.ac.za>; 'Keverne Thurling' <Thurling@telkom.co.za>; 'Heleen van den Heever' <vdheevhd@telkom.co.za>; 'Amanda Bester' <WayleaCR@telkom.co.za>; 'Morgan Griffiths' <morgan.griffiths@wessa.co.za>

Subject: Rondekop Wind Energy Facility near Sutherland: DSR Comment Period Starting

Dear Stakeholder

ENVIRONMENTAL IMPACT ASSESSMENT PROCESS (EIA) FOR THE PROPOSED 325MW RONDEKOP WIND ENERGY FACILITY BETWEEN MATJIESFONTEIN AND SUTHERLAND IN THE NORTHERN CAPE PROVINCE

SiVEST is in the process of undertaking the Environmental Impact Assessment (EIA) for the proposed development of the Rondekop Wind Energy Facility near Sutherland in the Northern Cape.

We would like to take this opportunity to inform you that, in accordance with the National Environmental Management Act, 1998 (Act No. 107 of 1998) (NEMA) (as amended), the Draft Scoping Report (DSR) for the above mentioned wind project will be available for public comment and review as from **Wednesday the 14th of November 2018 to the Friday 14th of December 2018** (before end of business day).

The DSRs as well as the accompanying appendices are available online (<http://data.g7energies.com/eia/rondekop>) and an electronic copy (on CD) has been posted to you. We kindly request that you submit your comments to the Public Participation Office at the below details, on or before Friday the 14th of December 2018 (before end of business day). SiVEST will forward any comments received after the public comment and review period directly to the relevant case officer at the Department of Environmental Affairs (DEA).

Should you have any questions or queries please do not hesitate to contact us at:

Hlengiwe Ntuli

PO Box 2921, RIVONIA, 2128

Phone: (011) 798 0600

E-mail: hlengiwen@sivest.co.za
Fax: (011) 803 7272

Kind Regards
Shivani Naidoo
Environmental Consultant
SIVEST Environmental Division



SIVEST is a Level 3 BBBEE Contributor

D +27 11 798 0600 | **T** +27 11 798 0600 **W** www.sivest.co.za
Engineering Consulting | Project Management | Environmental Consulting | Town & Regional Planning | Management Systems Consulting
Durban | Johannesburg | Pretoria | Pietermaritzburg | Richards Bay | Port Louis (Mauritius)

Disclaimer

The information contained in this communication from the sender is confidential. It is intended solely for use by the recipient and others authorized to receive it. If you are not the recipient, you are hereby notified that any disclosure, copying, distribution or taking action in relation of the contents of this information is strictly prohibited and may be unlawful.

This email has been scanned for viruses and malware, and automatically archived by **Mimecast SA (Pty) Ltd**, an innovator in Software as a Service (SaaS) for business. **Mimecast Unified Email Management ??? (UEM)** offers email continuity, security, archiving and compliance with all current legislation. To find out more, [contact Mimecast](#).

'Please consider the environment before you print this email'
'Please consider the environment before you print this email'

This message and any attachments transmitted with it are intended solely for the addressee(s) and may be legally privileged and/or confidential. If you have received this message in error please destroy it and notify the sender. Any unauthorized usage, disclosure, alteration or dissemination is prohibited. The Department of Environmental Affairs accepts no responsibility for any loss whether it be direct, indirect or consequential, arising from information made available and actions resulting there from. The views and opinions expressed in this e-mail message may not necessarily be those of Management.

Kerry Schwartz

From: Kerry Schwartz
Sent: Thursday, 22 November 2018 13:20
To: 'ferdis@atns.co.za'
Cc: andreag@sivest.co.za; 'Veronique Fyfe'; Shivani Naidoo; Liandra Scott-Shaw
Subject: FW: Rondekop Wind Energy Facility near Sutherland: DSR Comment Period Starting
Attachments: 15260_TurbineLayout_13Sept2018.kml

Hi Ferdi,

I have attached a kml of the proposed turbine layout as requested. The hub height will be between 90m and up to 140m and the rotor diameter between 100m and up to 180m. Hence the maximum height of the blade tip above ground will be 230m.

Please do not hesitate to contact us if you have any further queries.

Kind Regards
Kerry Schwartz
Senior GIS Consultant
SiVEST Environmental Division



SiVEST is a Level 3 BBBEE Contributor

D +27 11 798 0632 | **T** +27 11 798 0600 | **M** +27 00 000 0000 | **E** kerrys@sivest.co.za | **W** www.sivest.co.za

Engineering Consulting | Project Management | Environmental Consulting | Town & Regional Planning | Management Systems Consulting

Durban | Johannesburg | Pretoria | Pietermaritzburg | Richards Bay | Port Louis (Mauritius)

From: sivist_PPP <sivist_ppp@sivest.co.za>
Sent: Thursday, 22 November 2018 10:50
To: Shivani Naidoo <ShivaniN@sivest.co.za>; Andrea Gibb <AndreaG@sivest.co.za>
Cc: Kerry Schwartz <KerryS@sivest.co.za>
Subject: FW: Rondekop Wind Energy Facility near Sutherland: DSR Comment Period Starting

Hi Ladies,

Please assist.

From: Ferdi Smit [<mailto:ferdis@atns.co.za>]
Sent: 19 November 2018 09:17 AM
To: sivist_PPP <sivist_ppp@sivest.co.za>
Cc: Raoul Bester <RaoulB@atns.co.za>
Subject: RE: Rondekop Wind Energy Facility near Sutherland: DSR Comment Period Starting

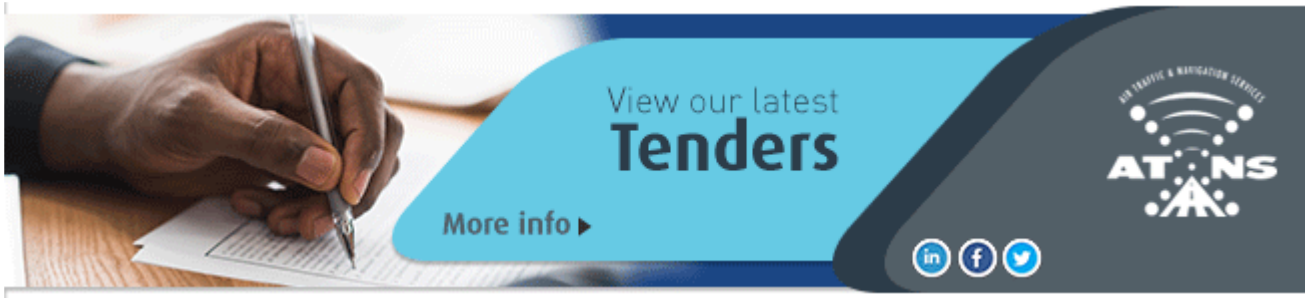

Hi Shivani

Do you perhaps have the position (LAT/LONG co-ordinates) of all the proposed wind turbines in a “kml” format (for use in Google Earth) or
Else maybe in an Excel format?

I would also require the Hub height, as well as the max height above ground of the blade tip.

There are quite a few new windfarm developments planned for the Sutherland/ Matjiesfontein area, so I would like to plot them in Google Earth
order to properly evaluate the impact on our radar systems – if any.

Regards

Ferdi Smit

Specialist: Radar CT | COO - Operations Technology
FACT

T: +2721 937 1151 • F: +27 021 937 1174 • C: +2782 553 3923
E: ferdis@atns.co.za • W: www.atns.com



[View Disclaimer](#)

From: sivest_PPP <sivest_ppp@sivest.co.za>

Sent: 14 November 2018 05:40 PM

To: Andrea Gibb <AndreaG@sivest.co.za>; Shivani Naidoo <ShivaniN@sivest.co.za>; 'Veronique Fyfe' <veronique@g7energie.com>

Cc: 'Henning Myburg' <henning@agrink.co.za>; Obstacle Evaluators <ObstacleEvaluators@atns.co.za>; Johanna Morobane <phillipd@atns.co.za>; Ferdi Smit <ferdis@atns.co.za>; 'Candice Stevens' <advocacy@birdlife.org.za>; 'Samantha Ralston-Paterson' <jacolinema@daff.gov.za>; 'Paul Avenant' <paula@daff.gov.za>; 'Colonel Loy de Jager' <loydejager@hotmail.com>; 'Marius van der Merwe' <mrabothata@environment.gov.za>; 'Seoka Lekota' <slekota@environment.gov.za>; 'Ntsundeni Ravhogni' <Ntsundeni.Ravhogni@nccpg.gov.za>; 'Ester Makungo' <makungoe@dws.gov.za>; 'Moses Mahunonyane' <MahunonyaneM@dws.gov.za>; 'Andre Crous' <andre.crous@eskom.co.za>; 'John Geeringh' <GeerinJH@eskom.co.za>; 'Lourens Leeuwner' <lourensl@ewt.org.za>; 'Amanda Gibbons' <a.gibbons@karoohoogland.gov.za>; 'Jannie Loubser' <janniell@namakwa-dm.gov.za>; 'Gert Steenkamp' <gsteenkamp@nccpg.gov.za>; 'Roelofse J. van der Merwe' <roelofse.j@vodamail.co.za>; 'Thulani Mthombeni' <tmtho@webmail.co.za>; 'Lizell Stroh' <strohl@caa.co.za>; 'Nicole Abraham' <Mlungisi.Ngwenya@weathersa.co.za>; 'Frank Creese' <creesef@sentech.co.za>; 'Alisha Pretorius' <pretoriusa@sentech.co.za>; 'Koegelenberg J. van der Merwe' <KoegelenbergJ@sentech.co.za>; 'Ramatholo Sefako' <rrs@saao.ac.za>; 'Danie Erasmus' <radiotech@saps.org.za>; 'Adriaan van der Merwe' <Thurling@telkom.co.za>; 'Heleen van den Heever' <vdheevhd@telkom.co.za>; 'Amanda Bester' <WayleaCR@telkom.co.za>; 'Morgan Griffiths' <morgan.griffiths@wessa.co.za>

Subject: Rondekop Wind Energy Facility near Sutherland: DSR Comment Period Starting

Dear Stakeholder

ENVIRONMENTAL IMPACT ASSESSMENT PROCESS (EIA) FOR THE PROPOSED 325MW RONDEKOP WIND ENERGY AND SUTHERLAND IN THE NORTHERN CAPE PROVINCE

SiVEST is in the process of undertaking the Environmental Impact Assessment (EIA) for the proposed development of the Rondekop in the Northern Cape.

We would like to take this opportunity to inform you that, in accordance with the National Environmental Management Act, 1998 the Draft Scoping Report (DSR) for the above mentioned wind project will be available for public comment and review as from **the Friday 14th of December 2018** (before end of business day).

The DSRs as well as the accompanying appendices are available online (<http://data.g7energies.com/eia/rondekop>) and an electronic copy will be available for public comment and review as from the Friday 14th of December 2018 (before end of business day). We kindly request that you submit your comments to the Public Participation Office at the below details, on or before Friday the 14th of December 2018 (before end of business day). SiVEST will forward any comments received after the public comment and review period directly to the relevant case officer (DEA).

Should you have any questions or queries please do not hesitate to contact us at:

Hlengiwe Ntuli

PO Box 2921, RIVONIA, 2128

Phone: (011) 798 0600

E-mail: hlengiwen@sivest.co.za

Fax: (011) 803 7272

Kind Regards

Shivani Naidoo

Environmental Consultant

SiVEST Environmental Division



SiVEST is a Level 3 BBBEE Contributor

D +27 11 798 0600 | **T** +27 11 798 0600 **W** www.sivest.co.za

Engineering Consulting | Project Management | Environmental Consulting | Town & Regional Planning | Management Systems Consulting
Durban | Johannesburg | Pretoria | Pietermaritzburg | Richards Bay | Port Louis (Mauritius)

Disclaimer

The information contained in this communication from the sender is confidential. It is intended solely for use by the recipient and others a recipient, you are hereby notified that any disclosure, copying, distribution or taking action in relation of the contents of this information is

This email has been scanned for viruses and malware, and automatically archived by **Mimecast SA (Pty) Ltd**, an innovator in Software a **Unified Email Management ??? (UEM)** offers email continuity, security, archiving and compliance with all current legislation. To find out

The contents of this email are confidential and intended for the named recipient(s) only. The information may be privileged or otherwise protected from disclosure. The views expressed in this message are those of the sender, unless otherwise stated to be. This email is also subject to copyright. No part hereof may be reproduced, adapted, transmitted, or used in any way without the written consent of ATNS SOC Limited. Please do not hesitate to contact us immediately should you have any doubts regarding the authenticity of an email purportedly sent by the sender.

Kerry Schwartz

From: Kerry Schwartz
Sent: Thursday, 22 November 2018 12:27
To: 'GeerinJH@eskom.co.za'
Cc: andreag@sivest.co.za; 'Veronique Fyfe'; Shivani Naidoo
Subject: FW: Rondekop Wind Energy Facility near Sutherland: DSR Comment Period Starting
Attachments: 15260_LayoutData_22Nov2018.zip

Hi John,

Attached please find the kml files for the affected properties and proposed layout for the Rondekop Wind Energy Facility. With regard to the grid connection, this will be subject to a separate BA process and you will be informed once that process is initiated.

Please do not hesitate to contact us if you have any further queries.

Kind Regards
Kerry Schwartz
Senior GIS Consultant
SiVEST Environmental Division



SiVEST is a Level 3 BBBEE Contributor

D +27 11 798 0632 | **T** +27 11 798 0600 | **M** +27 00 000 0000 | **E** kerrys@sivest.co.za | **W** www.sivest.co.za

Engineering Consulting | Project Management | Environmental Consulting | Town & Regional Planning | Management Systems Consulting

Durban | Johannesburg | Pretoria | Pietermaritzburg | Richards Bay | Port Louis (Mauritius)

From: Andrea Gibb <AndreaG@sivest.co.za>
Sent: Thursday, 15 November 2018 23:08
To: Kerry Schwartz <KerryS@sivest.co.za>
Subject: FW: Rondekop Wind Energy Facility near Sutherland: DSR Comment Period Starting

Kerry – please can you assist with the data highlighted below.

From: John Geeringh <GeerinJH@eskom.co.za>
Sent: Thursday, 15 November 2018 2:53 PM
To: sivest_PPP <sivest_ppp@sivest.co.za>
Cc: Andrea Gibb <AndreaG@sivest.co.za>; Shivani Naidoo <ShivaniN@sivest.co.za>; 'Veronique Fyfe' <veronique@g7energies.com>
Subject: RE: Rondekop Wind Energy Facility near Sutherland: DSR Comment Period Starting

Please find attached Eskom requirements for works at or near Eskom infrastructure and servitudes. Please send me **KMZ files of the affected properties, proposed layouts and proposed grid connection.**

Kind regards

John Geeringh (Pr Sci Nat)
Senior Consultant Environmental Management
Group Capital Division: Land Development and Management
Megawatt Park, D1Y42, Maxwell Drive, Sunninghill, Sandton.
P O Box 1091, Johannesburg, 2000.
Tel: 011 516 7233
Cell: 083 632 7663
Fax: 086 661 4064
E-mail: john.geeringh@eskom.co.za

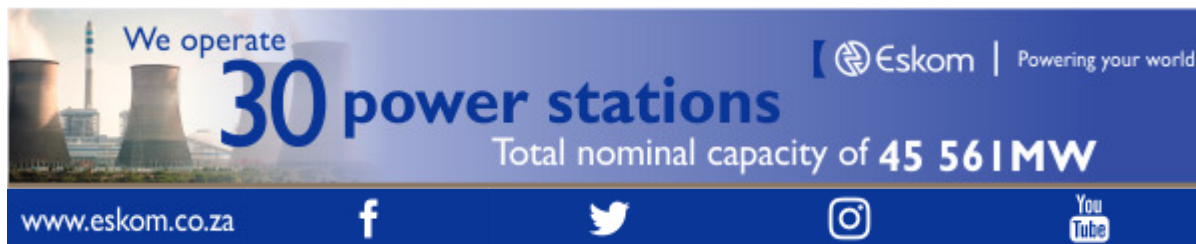

From: sivest_PPP [mailto:sivest_ppp@sivest.co.za]
Sent: 14 November 2018 03:52 PM
Cc: Andrea Gibb; Shivani Naidoo; 'Veronique Fyfe'
Subject: Rondekop Wind Energy Facility near Sutherland: DSR Comment Period Starting

Dear Interested and/or Affected Party

ENVIRONMENTAL IMPACT ASSESSMENT PROCESS (EIA) FOR THE PROPOSED 325MW RONDEKOP WIND ENERGY FACILITY BETWEEN MATJIESFONTEIN AND SUTHERLAND IN THE NORTHERN CAPE PROVINCE

Please note that SiVEST SA (Pty) Ltd has been appointed by Rondekop Wind Farm (Pty) Ltd as the Environmental Assessment Practitioner (EAP) for the abovementioned project.

We would like to take this opportunity to inform you that, in accordance with the National Environmental Management Act, 1998 (Act No. 107 of 1998) (NEMA) (as amended), the Draft Scoping Report (DSR) for the above mentioned project will be available for public comment and review as from **Wednesday 14 November 2018 to Friday 14 December 2018** (end of business day). Should you wish to receive an electronic copy of the DSR (on CD) please forward your request in writing to us. Hard copies of the DSR can be reviewed at the following public place:

VENUE	STREET ADDRESS	HOURS	CONTACT NO
Sutherland Library	Sarel Cillier Street, Sutherland	Mondays- Fridays 08h00 – 13h00 14h00 – 17h00	023 571 1429

The report can also be downloaded from <http://data.g7energies.com/eia/rondekop> during the review period.

Attached is an English and Afrikaans letter notifying of the review period.

Kind Regards
Shivani Naidoo
Environmental Consultant
SiVEST Environmental Division



SiVEST is a Level 3 BBBEE Contributor

D +27 11 798 0600 | **T** +27 11 798 0600 **W** www.sivest.co.za

Engineering Consulting | Project Management | Environmental Consulting | Town & Regional Planning | Management Systems Consulting

Durban | Johannesburg | Pretoria | Pietermaritzburg | Richards Bay | Port Louis (Mauritius)

Disclaimer

The information contained in this communication from the sender is confidential. It is intended solely for use by the recipient and others authorized to receive it. If you are not the recipient, you are hereby notified that any disclosure, copying, distribution or taking action in relation of the contents of this information is strictly prohibited and may be unlawful.

This email has been scanned for viruses and malware, and automatically archived by **Mimecast SA (Pty) Ltd**, an innovator in Software as a Service (SaaS) for business. **Mimecast Unified Email Management ??? (UEM)** offers email continuity, security, archiving and compliance with all current legislation. To find out more, [contact Mimecast](#).

NB: This Email and its contents are subject to the Eskom Holdings SOC Ltd EMAIL LEGAL NOTICE which can be viewed at http://www.eskom.co.za/Pages/Email_Legal_Spam_Disclaimer.aspx

Kerry Schwartz

From: Kerry Schwartz
Sent: Friday, 23 November 2018 07:40
To: 'Ferdie Smit'
Cc: andreag@sivest.co.za; Liandra Scott-Shaw; Marelize Berning
Subject: RE: Rondekop Wind Energy Facility near Sutherland: DSR Comment Period Starting

Hi Ferdie,

Please be advised that we received your email of 21st November 2018 and that ObstacleEvaluators@atns.co.za is already on the project database.

Kind Regards
Kerry Schwartz
Senior GIS Consultant
SiVEST Environmental Division



SiVEST is a Level 3 BBBEE Contributor

D +27 11 798 0632 | **T** +27 11 798 0600 | **M** +27 00 000 0000 | **E** kerrys@sivest.co.za | **W** www.sivest.co.za

Engineering Consulting | Project Management | Environmental Consulting | Town & Regional Planning | Management Systems Consulting

Durban | Johannesburg | Pretoria | Pietermaritzburg | Richards Bay | Port Louis (Mauritius)

From: Ferdie Smit <ferdis@atns.co.za>
Sent: Thursday, 22 November 2018 13:30
To: Kerry Schwartz <KerryS@sivest.co.za>
Subject: RE: Rondekop Wind Energy Facility near Sutherland: DSR Comment Period Starting



Thank you.
Did you received the email I sent yesterday? (attached)

Regards

Ferdie Smit
Specialist: Radar CT | COO - Operations Technology
FACT

T: +2721 937 1151 • F: +27 021 937 1174 • C: +2782 553 3923
E: ferdis@atns.co.za • W: www.atns.com



[View Disclaimer](#)

From: Kerry Schwartz <KerryS@sivest.co.za>

Sent: 22 November 2018 01:20 PM

To: Ferdi Smit <ferdis@atns.co.za>

Cc: Andrea Gibb <AndreaG@sivest.co.za>; Veronique Fyfe <veronique@g7energies.com>; Shivani Naidoo <ShivaniN@sivest.co.za>

Subject: FW: Rondekop Wind Energy Facility near Sutherland: DSR Comment Period Starting

Hi Ferdi,

I have attached a kml of the proposed turbine layout as requested. The hub height will be between 90m and up to 140m and hence the maximum height of the blade tip above ground will be 230m.

Please do not hesitate to contact us if you have any further queries.

Kind Regards

Kerry Schwartz

Senior GIS Consultant

SiVEST Environmental Division



SiVEST is a Level 3 BBBEE Contributor

D +27 11 798 0632 | **T** +27 11 798 0600 | **M** +27 00 000 0000 | **E** kerrys@sivest.co.za | **W** www.sivest.co.za

Engineering Consulting | Project Management | Environmental Consulting | Town & Regional Planning | Management Systems Consulting
Durban | Johannesburg | Pretoria | Pietermaritzburg | Richards Bay | Port Louis (Mauritius)

From: sivest_PPP <sivest_ppp@sivest.co.za>

Sent: Thursday, 22 November 2018 10:50

To: Shivani Naidoo <ShivaniN@sivest.co.za>; Andrea Gibb <AndreaG@sivest.co.za>

Cc: Kerry Schwartz <KerryS@sivest.co.za>

Subject: FW: Rondekop Wind Energy Facility near Sutherland: DSR Comment Period Starting

Hi Ladies,

Please assist.

From: Ferdi Smit [<mailto:ferdis@atns.co.za>]

Sent: 19 November 2018 09:17 AM

To: sivest_PPP <sivest_ppp@sivest.co.za>

Cc: Raoul Bester <RaoulB@atns.co.za>

Subject: RE: Rondekop Wind Energy Facility near Sutherland: DSR Comment Period Starting

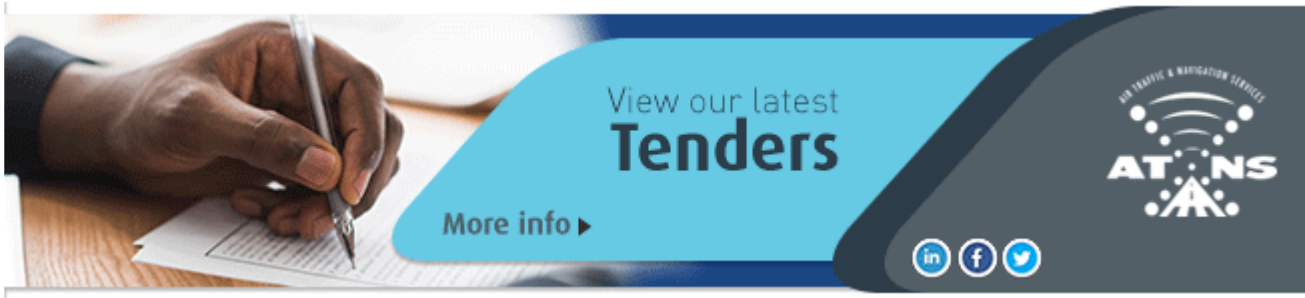

Hi Shivani

Do you perhaps have the position (LAT/LONG co-ordinates) of all the proposed wind turbines in a “kml” format (for use in Google Earth) or maybe in an Excel format?

I would also require the Hub height, as well as the max height above ground of the blade tip.

There are quite a few new windfarm developments planned for the Sutherland/ Matjiesfontein area, so I would like to plot them to properly evaluate the impact on our radar systems – if any.

Regards

Ferdi Smit

Specialist: Radar CT | COO - Operations Technology
FACT

T: +2721 937 1151 • F: +27 021 937 1174 • C: +2782 553 3923

E: ferdis@atns.co.za • W: www.atns.com



[View Disclaimer](#)

From: sivist_PPP <sivist_ppp@sivest.co.za>

Sent: 14 November 2018 05:40 PM

To: Andrea Gibb <AndreaG@sivest.co.za>; Shivani Naidoo <ShivaniN@sivest.co.za>; 'Veronique Fyfe' <veronique@g7energie.com>

Cc: 'Henning Myburg' <henning@agrink.co.za>; Obstacle Evaluators <ObstacleEvaluators@atns.co.za>; Johanna Morobane <phillipd@atns.co.za>; Ferdi Smit <ferdis@atns.co.za>; 'Candice Stevens' <advocacy@birdlife.org.za>; 'Samantha Ralston-Paterson' <jacolinema@daff.gov.za>; 'Paul Avenant' <paula@daff.gov.za>; 'Colonel Loy de Jager' <loydejager@hotmail.com>; 'Mmatlala Seoka Lekota' <slekota@environment.gov.za>; 'Ntsundeni Ravhogoni' <Ntsundeni.Ravhogoni@dmr.gov.za>; 'Patrick Lenyibi' <makungoe@dws.gov.za>; 'Moses Mahunonyane' <MahunonyaneM@dws.gov.za>; 'Brian Fisher' <bfisher@ncpg.gov.za>; 'Arno Geeringh' <GeerinJH@eskom.co.za>; 'Lourens Leeuwner' <lourensl@ewt.org.za>; 'Allistar Gibbons' <a.gibbons@karoohoogland.gov.za>; 'Gert Steenkamp' <gsteenkamp@ncpg.gov.za>; 'Jaco Roelofse' <roelofse.j@vodamail.co.za>; 'Thulani Mthombeni' <strohl@caa.co.za>; 'Nicole Abrahams' <AbrahamsN@nra.co.za>; 'Mlungisi Ngwenya' <Mlungisi.Ngwenya@weathersa.co.za>; 'Pretorius' <pretoriusa@sentech.co.za>; 'Johan Koegelenberg' <KoegelenbergJ@sentech.co.za>; 'Ramatholo Sefako' <rrs@saa.gov.za>; 'Adriaan Tiplady' <atiplady@ska.ac.za>; 'Keverne Thurling' <Thurling@telkom.co.za>; 'Heleen van den Heever' <vdheevhd@telkom.co.za>; 'WayleaCR' <WayleaCR@telkom.co.za>; 'Morgan Griffiths' <morgan.griffiths@wessa.co.za>

Subject: Rondekop Wind Energy Facility near Sutherland: DSR Comment Period Starting

Dear Stakeholder

ENVIRONMENTAL IMPACT ASSESSMENT PROCESS (EIA) FOR THE PROPOSED 325MW RONDEKOP WIND ENERGY SUTHERLAND IN THE NORTHERN CAPE PROVINCE

SiVEST is in the process of undertaking the Environmental Impact Assessment (EIA) for the proposed development of the Rondekop Wind Energy Project in the Northern Cape Province.

We would like to take this opportunity to inform you that, in accordance with the National Environmental Management Act, 1998, the Draft Environmental Impact Assessment Scoping Report (DSR) for the above mentioned wind project will be available for public comment and review as from **Wednesday, 27 December 2018** (before end of business day).

The DSRs as well as the accompanying appendices are available online (<http://data.g7energies.com/eia/rondekop>) and an electronic request that you submit your comments to the Public Participation Office at the below details, on or before Friday the 14th of December 2018. All comments received during the public comment and review period will be forwarded to the relevant case officer at the Department of Environmental Affairs.

Should you have any questions or queries please do not hesitate to contact us at:

Hlengiwe Ntuli

PO Box 2921, RIVONIA, 2128

Phone: (011) 798 0600

E-mail: hlengiwen@sivest.co.za

Fax: (011) 803 7272

Kind Regards

Shivani Naidoo

Environmental Consultant

SiVEST Environmental Division



SiVEST is a Level 3 BBBEE Contributor



D +27 11 798 0600 | **T** +27 11 798 0600 **W** www.sivest.co.za

Engineering Consulting | Project Management | Environmental Consulting | Town & Regional Planning | Management Systems Consulting
Durban | Johannesburg | Pretoria | Pietermaritzburg | Richards Bay | Port Louis (Mauritius)

Disclaimer

The information contained in this communication from the sender is confidential. It is intended solely for use by the recipient and others who have been hereby notified that any disclosure, copying, distribution or taking action in relation of the contents of this information is strictly prohibited.

This email has been scanned for viruses and malware, and automatically archived by **Mimecast SA (Pty) Ltd**, an innovator in Software as a Service (SaaS) **Management** (UEM) offers email continuity, security, archiving and compliance with all current legislation. To find out more, [contact us](#).

The contents of this email are confidential and intended for the named recipient(s) only. The information may be privileged or otherwise protected from disclosure. The views expressed in this message are those of the sender, unless otherwise stated to be. This email is also subject to copyright. No part hereof may be reproduced, adapted, transmitted, or used in any way without the written consent of ATNS SOC Limited. Please do not hesitate to contact us immediately should you have any doubts regarding the authenticity of an email purportedly sent by the sender.

Disclaimer

The information contained in this communication from the sender is confidential. It is intended solely for use by the recipient and others a hereby notified that any disclosure, copying, distribution or taking action in relation of the contents of this information is strictly prohibited

This email has been scanned for viruses and malware, and automatically archived by **Mimecast SA (Pty) Ltd**, an innovator in Software a **Management ??? (UEM)** offers email continuity, security, archiving and compliance with all current legislation. To find out more, [contact](#)

The contents of this email are confidential and intended for the named recipient(s) only. The information may be privileged or otherwise protected from disclosure. The views expressed in this message are those of the sender, unless otherwise stated to be. This email is also subject to copyright. No part hereof may be reproduced, adapted, transmitted, or used in any way without the written consent of ATNS SOC Limited. Please do not hesitate to contact us immediately should you have any doubts regarding the authenticity of an email purportedly sent by the sender.

Kerry Schwartz

From: Kerry Schwartz
Sent: Friday, 23 November 2018 08:23
To: 'PretoriusA@sentech.co.za'; 'MotlhakeS@sentech.co.za'
Cc: andreag@sivest.co.za; Liandra Scott-Shaw; 'Veronique Fyfe'; Karen de Bruyn; 'francois@g7energies.com'
Subject: FW: Rondekop Wind Energy Facility: EIA Commencing
Attachments: 15260_TurbineLayout_13Sept2018.kml; A3_15260_ProjectOverview_Reduced.jpg
Importance: High

Hi Alishea & Serame,

With regard to your email of 15th November 2018, your queries and comments are addressed in red below:

We have no records of this planned WTG. Noted. The project has just been released into the public domain for a 30-day comment period which ends on 14th December 2018.

Below is the information required for us to do the study:

The following process is followed:

- 1. A preliminary study to be conducted and a quotation for a detailed study. A .kml with wind turbine positions is required for this purpose: We have attached a kml file showing the proposed turbine layout.*
- 2. We will conduct the preliminary study of the wind farm location to determine how many terrestrial transmitter stations might be effected. Based on the findings we will forward the man-hours required for the study to our Marketing and Sales Division who will then issue a quotation: Noted. Please contact Francois Pigeau from G7 Renewable energies regarding the quotation. His contact details are as follows:*

*Francois Pigeau
Tel: 021 300 0615
Email: francois@g7energies.com*
- 3. Once the amount is settled an interference investigation study will be conducted. The results and findings will be compiled in an interference assessment report. If the findings indicate that the interference area and number of people affected is acceptable a conditional letter of approval will be provided: Noted.*
- 4. The following information is required for the detailed study:*
 - Latest .KML WTG layout of the wind farm: See attached.*
 - Number of wind turbines (please provide the total number of wind turbines): Up to 48 wind turbines, each between 3MW and 6.5MW in nameplate capacity.*
 - Height of wind turbine up to the hub: The max hub height of each turbine will up to 140 m.*
 - Length of wind turbine blade: The max rotor diameter of each turbine will be 180 m.*
 - Maximum blade width: Cannot be confirmed at this stage. Currently the biggest turbine on the market has a blade width of about 4m.*
 - Diameter of tower at base: See comment below.*
 - Diameter of tower below hub: The diameter of tower at base and tower below hub should not be considered for the calculation as this depends on the final design and load assessment. This will be done at a later stage.*
- 5. Demarcated map indicating wind turbine positions and wind farm boundary areas. The latest layout map is attached.*

Please do not hesitate to contact us if you require any additional information.

Kind Regards
Kerry Schwartz
Senior GIS Consultant
SiVEST Environmental Division



SiVEST is a Level 3 BBBEE Contributor

D +27 11 798 0632 | **T** +27 11 798 0600 | **M** +27 00 000 0000 | **E** kerrys@sivest.co.za | **W** www.sivest.co.za

Engineering Consulting | Project Management | Environmental Consulting | Town & Regional Planning | Management Systems Consulting

Durban | Johannesburg | Pretoria | Pietermaritzburg | Richards Bay | Port Louis (Mauritius)

From: sivest_PPP <sivest_ppp@sivest.co.za>
Sent: Thursday, 22 November 2018 10:53
To: Andrea Gibb <AndreaG@sivest.co.za>; Shivani Naidoo <ShivaniN@sivest.co.za>
Cc: Kerry Schwartz <KerryS@sivest.co.za>
Subject: FW: Rondekop Wind Energy Facility: EIA Commencing
Importance: High

Good Day Team,

Please assist with the below.

From: Alishea Pretorius [<mailto:PretoriusA@sentech.co.za>]
Sent: 15 November 2018 10:34 AM
To: sivest_PPP <sivest_ppp@sivest.co.za>
Subject: FW: Rondekop Wind Energy Facility: EIA Commencing
Importance: High

Good day

See email below with info needed before we can comment.

Regards



Alishea Pretorius
Site Acquisition and Environmental Specialist

Tel +27 11 471 4540 • Cell phone +27 82 777 8506
Sender Technology Park • Octave Road • Honeydew
E mail pretoriusa@sentech.co.za
Website www.sentech.co.za

From: Serame Motlhake
Sent: Tuesday, 13 November 2018 11:39 AM
To: Alishea Pretorius <PretoriusA@sentech.co.za>

Subject: RE: Rondekop Wind Energy Facility: EIA Commencing
Importance: High

Good Day Madame,

We have no records of this planned WTG.

Below is the information required for us to do the study:

The following process is followed:

1. A preliminary study to be conducted and a quotation for a detailed study. A .kml with wind turbine positions is required for this purpose;
2. We will conduct the preliminary study of the wind farm location to determine how many terrestrial transmitter stations might be effected. Based on the findings we will forward the man-hours required for the study to our Marketing and Sales Division who will then issue a quotation;
3. Once the amount is settled an interference investigation study will be conducted. The results and findings will be compiled in an interference assessment report. If the findings indicate that the interference area and number of people affected is acceptable a conditional letter of approval will be provided.
4. The following information is required for the detailed study:
 - Latest .KML WTG layout of the wind farm;
 - Number of wind turbines (please provide the total number of wind turbines)
 - Height of wind turbine up to the hub;
 - Length of wind turbine blade;
 - Maximum blade width;
 - Diameter of tower at base;
 - Diameter of tower below hub;
5. Demarcated map indicating wind turbine positions and wind farm boundary areas.

Regards,

Serame

From: Alishea Pretorius
Sent: 13 November 2018 10:58 AM
To: Serame Motlhake <MotlhakeS@sentech.co.za>
Subject: FW: Rondekop Wind Energy Facility: EIA Commencing

Good day Sir

Are we aware of this potential development of a wind energy facility?

Kind regards



From: sivist_PPP [mailto:sivist_ppp@sivest.co.za]

Sent: Friday, 09 November 2018 4:53 PM

To: Andrea Gibb <AndreaG@sivest.co.za>; Shivani Naidoo <ShivaniN@sivest.co.za>; 'Veronique Fyfe' <veronique@g7energies.com>

Cc: 'Henning Myburg' <henning@agrink.co.za>; 'Simphele Masilela' <ObstacleEvaluators@atns.co.za>; 'Johanna Morobane' <JohannaM@atns.co.za>; 'S Frans' <franss@netstar.altech.co.za>; 'Johan' <Johan@fleetcall.co.za>; 'Phillip De Lange' <phillipd@atns.co.za>; 'Ferdi Smit' <ferdis@atns.co.za>; 'Candice Stevens' <advocacy@birdlife.org.za>; 'Samantha Ralston-Paton' <energy@birdlife.org.za>; 'Coert Smit' <coert@breedenet.co.za>; 'Vivian Kiewitz' <VKiewitz@cellc.co.za>; 'Jacoline Mans' <jacolinema@daff.gov.za>; 'Paul Avenant' <paula@daff.gov.za>; 'Colonel Loy de Jager' <loydejager@hotmail.com>; 'Mmatlala Rabothata' <mrabothata@environment.gov.za>; 'Seoka Lekota' <slekota@environment.gov.za>; 'Rasibe Sekepane' <Lungi.Mondela@dmr.gov.za>; 'Ntsundeni Ravhogoni' <Ntsundeni.Ravhogoni@dmr.gov.za>; 'Vincent Muila' <pieter.swart@dmr.gov.za>; 'Patrick Lenyibi' <plenyibi@ncpg.gov.za>; 'Ester Makungo' <makungoe@dws.gov.za>; 'Moses Mahunonyane' <MahunonyaneM@dws.gov.za>; 'Brian Fisher' <bfisher@ncpg.gov.za>; 'Andre Crous' <andre.crous@eskom.co.za>; 'John Geeringh' <GeerinJH@eskom.co.za>; 'Lourens Leeuwener' <lourensl@ewt.org.za>; 'Allistar Gibbons' <a.gibbons@karoohoogland.gov.za>; 'Willenise Klein' <w.klein@karoohoogland.gov.za>; 'Jeremy Davids' <jeremydavids11@gmail.com>; 'Veruschka Wentzel' <vcwentzel123@gmail.com>; 'Jan Johannes Jacobs' <jacobsjan624@gmail.com>; 'Jacobus Jooste' <info@karoohoogland.gov.za>; 'Giel Klazen' <seunklazen@gmail.com>; 'Johan van der Colff' <jvdc@mtnloaded.co.za>; 'Charles van Reenen' <vanree_c@mtn.co.za>; 'Jannie Loubser' <janniel@namakwa-dm.gov.za>; 'Gert Steenkamp' <gsteenkamp@ncpg.gov.za>; 'Jaco Roelofse' <roelofse.j@vodamail.co.za>; 'Thulani Mthombeni' <tmtho@webmail.co.za>; 'Lizell Stroh' <strohl@caa.co.za>; 'Administration' <salt@salt.ac.za>; 'Nicole Abrahams' <AbrahamsN@nra.co.za>; 'Rene De Kock' <Dekockr@nra.co.za>; 'Mlungisi Ngwenya' <Mlungisi.Ngwenya@weathersa.co.za>; 'Frank Creese' <creesef@sentech.co.za>; Alishea Pretorius <PretoriusA@sentech.co.za>; Johan Koegelenberg <KoegelenbergJ@sentech.co.za>; 'Ramatholo Sefako' <rrs@saa.ac.za>; 'Danie Erasmus' <radiotech@saps.org.za>; 'Adriaan Tiplady' <atiplady@ska.ac.za>; 'Tshegofatso Monama' <temonama@ska.ac.za>; 'J Martiens' <sutherlandlib@ncpg.gov.za>; 'Ronell Cloete' <sutherlandlibrary@ncpg.gov.za>; 'M Malan' <sutherland.sc@saps.gov.za>; 'Keverne Thurling' <Thurling@telkom.co.za>; 'Heleen van den Heever' <vdheevhd@telkom.co.za>; 'Amanda Bester' <WayleaCR@telkom.co.za>; 'Sam Fiff' <Francis.Rahlapane@transnet.net>; 'Craig Barnes' <barnesc@vodacom.co.za>; 'Morgan Griffiths' <morgan.griffiths@wessa.co.za>; 'isak@breedenet.co.za' <isak@breedenet.co.za>; 'kmothomi@ncpg.gov.za' <kmothomi@ncpg.gov.za>; 'lefleurd@dws.gov.za' <lefleurd@dws.gov.za>; 'Mpho Sebole' <sebolemd@eskom.co.za>; 'mayorv@karoohoogland.gov.za' <mayorv@karoohoogland.gov.za>; 'ruth.cuttings@yahoo.com' <ruth.cuttings@yahoo.com>; 'BesterAD@telkom.co.za' <BesterAD@telkom.co.za>

Subject: Rondekop Wind Energy Facility: EIA Commencing

Dear Interested and/or Affected Party,

ENVIRONMENTAL IMPACT ASSESSMENT (EIA) FOR THE PROPOSED 325MW RONDEKOP WIND ENERGY FACILITY BETWEEN MATJIESFONTEIN AND SUTHERLAND IN THE NORTHERN CAPE PROVINCE

INVITATION TO PARTICIPATE IN THE ENVIRONMENTAL IMPACT ASSESSMENT PROCESS

In terms of the EIA Regulations and the National Environmental Management Act, 1998 (Act No. 107 of 1998), SiVEST SA (Pty) Ltd (hereafter referred to as SiVEST) has been appointed as the independent Environmental Assessment Practitioner (EAP) by Rondekop Wind Farm (Pty) Ltd (hereafter referred to as Rondekop Wind Farm) to conduct the Environmental Impact Assessment (EIA) process for the proposed development of the 325MW Rondekop Wind Energy Facility Between Matjiesfontein and Sutherland in the Northern Cape Province.

SiVEST would like to invite you, as a potential Interested and/or Affected Party (I&AP), to become actively involved in the EIA and Public Participation Process (PPP) for this proposed project. The aim of this process is as follows:

- To ensure that all the relevant environmental impacts are taken into consideration;
- To ensure public input; and
- Provide decision - makers with sufficient information to make an informed decision on the proposed

activities.

Attached is the Background Information Document (BID), which contains information regarding the proposed project as well as the EIA and PPP, which is currently being undertaken.

We would like to thank you, in advance, for becoming part of the Public Participation Process and are looking forward to receiving your valuable comments relating to the proposed project.

Geagte Belangstellende en/of Geaffekteerde Party

OMGEWINGSIMPAKEVALUERING (OIE) VIR DIE BEOOGDE 325 MW RONDEKOP WINDKRAGANLEG TUSSEN MATJIESFONTEIN EN SUTHERLAND IN DIE NOORD-KAAPROVINSIE

UITNODIGING OM DEEL TE NEEM AAN DIE OMGEWINGSIMPAKEVALUERINGSPROSES

Ingevolge die OIE-regulasies en die Nasionale Wet op Omgewingsbestuur, 1998 (Wet 107 van 1998), is SiVEST SA (Edms.) Bpk. (hierna SiVEST genoem) deur Rondekop Wind Farm (Edms.) Bpk. (hierna Rondekop Wind Farm genoem) aangestel as die onafhanklike Omgewingsevalueringpraktisyn (OEP) om die Omgewingsimpak-evalueringproses (OIE) vir die beoogde ontwikkeling van die 325 MW Rondekop Windkragaanleg tussen Matjiesfontein en Sutherland in die Noord-Kaapprovinsie te onderneem.

SiVEST nooi u, as 'n potensiële belangstellende en/of geaffekteerde party (B&GP), uit om aktief betrokke te raak by die OIE en Openbare Deelnameproses (ODP) vir hierdie beoogde projek.

Die doel van hierdie proses is om:

- toe te sien dat oorweging aan al die tersaaklike omgewingsimpakte geskenk word;
- openbare insette te verseker; en
- besluitnemers van genoegsame inligting te voorsien om 'n ingeligte besluit oor die beoogde aktiwiteit te maak.

Aangeheg is die Agtergrondinligtingsdokument (AID) wat inligting rakende die beoogde projek, asook die OIE en ODP bevat wat tans onderneem word.

Ons bedank u by voorbaat dat u deel word van die openbare deelnameproses en ons sien uit daarna om u waardevolle insette betreffende die beoogde projek te ontvang.

Kind Regards

Shivani Naidoo

Environmental Consultant

SiVEST Environmental Division



SiVEST is a Level 3 BBBEE Contributor

D +27 11 798 0600 | **T** +27 11 798 0600 **W** www.sivest.co.za

Engineering Consulting | Project Management | Environmental Consulting | Town & Regional Planning | Management Systems Consulting

Durban | Johannesburg | Pretoria | Pietermaritzburg | Richards Bay | Port Louis (Mauritius)

Disclaimer

The information contained in this communication from the sender is confidential. It is intended solely for use by the recipient and others authorized to receive it. If you are not the recipient, you are hereby notified that any disclosure, copying, distribution or taking action in relation of the contents of this information is strictly prohibited and may be unlawful.

This email has been scanned for viruses and malware, and automatically archived by **Mimecast SA (Pty) Ltd**, an innovator in Software as a Service (SaaS) for business. **Mimecast Unified Email Management ??? (UEM)** offers email continuity, security, archiving and compliance with all current legislation. To find out more, [contact Mimecast](#).



SENTECH achieves a clean audit for the sixth consecutive year

DISCLAIMER:

This email contains confidential information. It may also be legally privileged. Interception of this email is illegal. The information contained in this email is only for the use of the intended recipient. If you are not the intended recipient, any disclosure, copying and/or distribution of the contents of this email, or the taking of any action in reliance thereon or pursuant thereto, is strictly prohibited. Should you have received this email in error, please notify us immediately by return email.

Liandra Scott-Shaw

From: Liandra Scott-Shaw
Sent: Thursday, 13 December 2018 3:57 PM
To: 'JacolineMa'
Cc: 'Veronique Fyfe'; Andrea Gibb
Subject: 15260: Proposed 325 MW Rondekop Wind Energy Facility, Sutherland

Dear Jacoline

Thank you for your comments.

Kind regards

Liandra Scott-Shaw (*Pr.Sci.Nat*)
Environmental Scientist
SiVEST Environmental Division



SiVEST is a Level 3 BBBEE Contributor

T +27 33 347 1600 | **M** +2773 658 7955 | **E** liandras@sivest.co.za | **W** www.sivest.co.za

Engineering Consulting | Project Management | Environmental Consulting | Town & Regional Planning | Management Systems Consulting

Durban | Johannesburg | Pretoria | Pietermaritzburg | Richards Bay | Port Louis (Mauritius)

From: JacolineMa <JacolineMa@daff.gov.za>
Sent: Tuesday, 27 November 2018 4:02 PM
To: Hlengiwe Ntuli <HlengiweN@sivest.co.za>
Subject: Proposed 325 MW Rondekop Wind Energy Facility, Sutherland

Dear Mr. / Ms. Naidoo

Attached please find comments from the Department of Forestry on the above-mentioned proposed development. Thank you for notifying this Department.

Kind Regards,

Jacoline Mans
Chief Forester: NFA Regulation
Directorate: Forestry Management (Other Regions)
Department of Agriculture, Forestry and Fisheries
Tel (054) 338 5909; Cell 060 973 1660
Web: www.daff.gov.za
E-mail: JacolineMa@daff.gov.za



agriculture,
forestry & fisheries

Department:
Agriculture, Forestry and Fisheries
REPUBLIC OF SOUTH AFRICA

Notice

The information contained in this e-mail may be confidential, legally privileged and protected by law. Access by the intended recipient only is authorised. If you are not the intended recipient, kindly notify the sender immediately. Unauthorised use, copying or dissemination hereof is strictly prohibited. Save for *bona fide* departmental purposes, the Department of Agriculture, Forestry and Fisheries does not accept responsibility for the contents or opinions expressed in this e-mail, nor does it warrant this communication to be free from errors, contamination, interference or interception.

Shivani Naidoo

From: Shivani Naidoo
Sent: Thursday, 13 December 2018 4:06 PM
To: 'morgan.griffiths@wessa.co.za'
Cc: Andrea Gibb; Liandra Scott-Shaw; 'Veronique Fyfe'; Karen de Bruyn
Subject: RE: Rondekop Wind Energy Facility near Sutherland: DSR Comment Period Ending

Dear Morgan

Thank you for your response.

Kind Regards,
Shivani Naidoo
Environmental Consultant
SiVEST Environmental Division



SiVEST is a Level 3 BBBEE Contributor

C 084 547 7544 **T** 033 347 1600 | **E** shivanin@sivest.co.za **W** www.sivest.co.za

Engineering Consulting | Project Management | Environmental Consulting | Town & Regional Planning | Management Systems Consulting

Durban | Johannesburg | Pretoria | Pietermaritzburg | Richards Bay | Port Louis (Mauritius)

From: Morgan Griffiths [<mailto:morgan.griffiths@wessa.co.za>]
Sent: 12 December 2018 10:17 AM
To: sivist_PPP <sivist_ppp@sivest.co.za>
Subject: RE: Rondekop Wind Energy Facility near Sutherland: DSR Comment Period Ending

Hi Shivani

WESSA will not be submitting a comment, thank you for inviting us to comment on this application.

Regards
Morgan Griffiths

From: sivist_PPP <sivist_ppp@sivest.co.za>
Sent: 12 December 2018 10:14
To: Andrea Gibb <AndreaG@sivest.co.za>; Shivani Naidoo <ShivaniN@sivest.co.za>; 'Veronique Fyfe' <veronique@g7energies.com>; Liandra Scott-Shaw <LiandraS@sivest.co.za>
Cc: 'Henning Myburg' <henning@agrink.co.za>; 'Simpfiwe Masilela' <ObstacleEvaluators@atns.co.za>; 'Johanna Morobane' <JohannaM@atns.co.za>; 'Phillip De Lange' <phillipd@atns.co.za>; 'Ferdie Smit' <ferdis@atns.co.za>; 'Candice Stevens' <advocacy@birdlife.org.za>; 'Samantha Ralston-Paton' <energy@birdlife.org.za>; 'Jacoline Mans' <jacolinema@daff.gov.za>; 'Paul Avenant' <paula@daff.gov.za>; 'Colonel Loy de Jager' <loydejager@hotmail.com>; 'Mmatlala Rabothata' <mrabothata@environment.gov.za>; 'Seoka Lekota' <slekota@environment.gov.za>; 'Ntsundeni Ravhogoni' <Ntsundeni.Ravhogoni@dmr.gov.za>; 'Patrick Lenyibi' <plenyibi@ncpg.gov.za>; 'Ester Makungo' <makungoe@dws.gov.za>; 'Moses Mahunonyane' <MahunonyaneM@dws.gov.za>; 'Brian Fisher' <bfisher@ncpg.gov.za>; 'Andre Crous' <andre.crous@eskom.co.za>; 'John Geeringh' <GeerinJH@eskom.co.za>; 'Lourens Leeuwner' <lourensl@ewt.org.za>; 'Allistar Gibbons' <a.gibbons@karoohoogland.gov.za>; 'Jannie Loubser'

<janniell@namakwa-dm.gov.za>; 'Gert Steenkamp' <gsteenkamp@ncpg.gov.za>; 'Jaco Roelofse' <roelofse.j@vodamail.co.za>; 'Thulani Mthombeni' <tmtho@webmail.co.za>; 'Lizell Strohl' <strohl@caa.co.za>; 'Nicole Abrahams' <AbrahamsN@nra.co.za>; 'Mlungisi Ngwenya' <Mlungisi.Ngwenya@weathersa.co.za>; 'Frank Creese' <creesef@sentech.co.za>; 'Alisha Pretorius' <pretoriusa@sentech.co.za>; 'Johan Koegelenberg' <KoegelenbergJ@sentech.co.za>; 'Ramatholo Sefako' <rrs@saa.ac.za>; 'Danie Erasmus' <radiotech@saps.org.za>; 'Adriaan Tiplady' <atiplady@ska.ac.za>; 'Keverne Thurling' <Thurling@telkom.co.za>; 'Heleen van den Heever' <vdheevhd@telkom.co.za>; 'Amanda Bester' <WayleaCR@telkom.co.za>; Morgan Griffiths <morgan.griffiths@wessa.co.za>; 'Administration' <salt@salt.ac.za>; 'Johan' <Johan@fleetcall.co.za>; 'Adriaan Tiplady' <atiplady@ska.ac.za>; 'Alisha Pretorius' <pretoriusa@sentech.co.za>; 'Allistar Gibbons' <a.gibbons@karoohoogland.gov.za>; 'Amanda Bester' <WayleaCR@telkom.co.za>; 'Andre Crous' <andre.crous@eskom.co.za>; 'Brian Fisher' <bfisher@ncpg.gov.za>; 'Candice Stevens' <advocacy@birdlife.org.za>; 'Charles van Reenen' <vanree_c@mtn.co.za>; 'Coert Smit' <coert@breedenet.co.za>; 'Colonel Loy de Jager' <loydejager@hotmail.com>; 'Craig Barnes' <barnesc@vodacom.co.za>; 'Danie Erasmus' <radiotech@saps.org.za>; 'Ester Makungo' <makungoe@dws.gov.za>; 'Ferdie Smit' <ferdis@atns.co.za>; 'Frank Creese' <creesef@sentech.co.za>; 'Gert Steenkamp' <gsteenkamp@ncpg.gov.za>; 'Giel Klazen' <seunklazen@gmail.com>; 'Heleen van den Heever' <vdheevhd@telkom.co.za>; 'Henning Myburg' <henning@agrink.co.za>; 'J Martiens' <sutherlandlib@ncpg.gov.za>; 'Jaco Roelofse' <roelofse.j@vodamail.co.za>; 'Jacobus Jooste' <info@karoohoogland.gov.za>; 'Jacoline Mans' <jacolinema@daff.gov.za>; 'Jan Johannes Jacobs' <jacobsjan624@gmail.com>; 'Jannie Louber' <janniell@namakwa-dm.gov.za>; 'Jeremy Davids' <jeremydavids11@gmail.com>; 'Johan Koegelenberg' <KoegelenbergJ@sentech.co.za>; 'Johan van der Colff' <jvdc@mtnloaded.co.za>; 'Johanna Morobane' <JohannaM@atns.co.za>; 'John Geeringh' <GeerinJH@eskom.co.za>; 'Keverne Thurling' <Thurling@telkom.co.za>; 'Lizell Strohl' <strohl@caa.co.za>; 'Lourens Leeuwener' <lourensl@ewt.org.za>; 'M Malan' <sutherland.sc@saps.gov.za>; 'Mmatlala Rabothata' <mrabothata@environment.gov.za>; Morgan Griffiths <morgan.griffiths@wessa.co.za>; 'Moses Mahunonyane' <MahunonyaneM@dws.gov.za>; 'Nelly Boshielo' <Nelly.Boshielo@weathersa.co.za>; 'Nicole Abrahams' <AbrahamsN@nra.co.za>; 'Ntsundeni Ravhogoni' <Ntsundeni.Ravhogoni@dmr.gov.za>; 'Patrick Lenyibi' <plenyibi@ncpg.gov.za>; 'Paul Avenant' <paula@daff.gov.za>; 'Phillip De Lange' <phillipd@atns.co.za>; 'Ramatholo Sefako' <rrs@saa.ac.za>; 'Rasibe Sekepane' <Lungi.Mondela@dmr.gov.za>; 'Rene De Kock' <Dekockr@nra.co.za>; 'Ronell Cloete' <sutherlandlibrary@ncpg.gov.za>; 'S Frans' <franss@netstar.altech.co.za>; 'Sam Fiff' <Francis.Rahlapane@transnet.net>; 'Samantha Ralston-Paton' <energy@birdlife.org.za>; 'Seoka Lekota' <slekota@environment.gov.za>; 'Simphiwe Masilela' <ObstacleEvaluators@atns.co.za>; 'Thoko Buthelezi' <ThokoB@daff.gov.za>; 'Thulani Mthombeni' <tmtho@webmail.co.za>; 'Tshegofatso Monama' <temonama@ska.ac.za>; 'Veruschka Wentzel' <vcwentzel123@gmail.com>; 'Vincent Muila' <pieter.swart@dmr.gov.za>; 'Vivian Kiewitz' <VKiewitz@cellc.co.za>; 'Willenise Klein' <w.klein@karoohoogland.gov.za>; 'ruth.cuttings@yahoo.com' <ruth.cuttings@yahoo.com>; 'Mpho Sebole' <sebolemd@eskom.co.za>; 'Obstacles@caa.co.za' <Obstacles@caa.co.za>; 'isak@breedenet.co.za' <isak@breedenet.co.za>; 'kmothomi@ncpg.gov.za' <kmothomi@ncpg.gov.za>; 'mayorv@karoohoogland.gov.za' <mayorv@karoohoogland.gov.za>

Subject: Rondekop Wind Energy Facility near Sutherland: DSR Comment Period Ending

Importance: High

Dear Stakeholder,

SiVEST sent the Draft Scoping report for the proposed 325MW Rondekop Wind Energy facility between Matjiesfontein and Sutherland in the Northern Cape province to your department on 14th November 2018 for comment (refer to the below email). Please can you advise if comments will be submitted to us for inclusion in the final Scoping Report.

We would like to inform you that the comment period is ending on **Friday 14th December 2018** and you are advised to please send comments as soon as possible.

Should you have any comments, please feel free to contact the public participation office at the details below:

Sivest Environmental

PO Box 2921, RIVONIA, 2128

Phone: (011) 798 0600

E-mail: hlengiwen@sivest.co.za / Sivest_ppp@sivest.co.za

Fax: (011) 803 7272

Kind Regards
Shivani Naidoo
Environmental Consultant
SiVEST Environmental Division



SiVEST is a Level 3 BBBEE Contributor

D +27 11 798 0600 | **T** +27 11 798 0600 **W** www.sivest.co.za

Engineering Consulting | Project Management | Environmental Consulting | Town & Regional Planning | Management Systems Consulting

Durban | Johannesburg | Pretoria | Pietermaritzburg | Richards Bay | Port Louis (Mauritius)

From: sivest_PPP

Sent: 14 November 2018 05:40 PM

To: Andrea Gibb <AndreaG@sivest.co.za>; Shivani Naidoo <ShivaniN@sivest.co.za>; 'Veronique Fyfe' <veronique@g7energies.com>

Cc: 'Henning Myburg' <henning@agrink.co.za>; 'Simphiwe Masilela' <ObstacleEvaluators@atns.co.za>; 'Johanna Morobane' <JohannaM@atns.co.za>; 'Phillip De Lange' <phillipd@atns.co.za>; 'Ferdie Smit' <ferdis@atns.co.za>; 'Candice Stevens' <advocacy@birdlife.org.za>; 'Samantha Ralston-Paton' <energy@birdlife.org.za>; 'Jacoline Mans' <jacolinema@daff.gov.za>; 'Paul Avenant' <paula@daff.gov.za>; 'Colonel Loy de Jager' <loydejager@hotmail.com>; 'Mmatlala Rabothata' <mrabothata@environment.gov.za>; 'Seoka Lekota' <slekota@environment.gov.za>; 'Ntsundeni Ravhogni' <Ntsundeni.Ravhogni@dmr.gov.za>; 'Patrick Lenyibi' <plenyibi@ncpg.gov.za>; 'Ester Makungo' <makungoe@dws.gov.za>; 'Moses Mahunonyane' <MahunonyaneM@dws.gov.za>; 'Brian Fisher' <bfisher@ncpg.gov.za>; 'Andre Crous' <andre.crous@eskom.co.za>; 'John Geeringh' <GeerinJH@eskom.co.za>; 'Lourens Leeuwner' <lourensl@ewt.org.za>; 'Allistar Gibbons' <a.gibbons@karoohoogland.gov.za>; 'Jannie Loubser' <janniel@namakwa-dm.gov.za>; 'Gert Steenkamp' <gsteenkamp@ncpg.gov.za>; 'Jaco Roelofse' <roelofse.j@vodamail.co.za>; 'Thulani Mthombeni' <tmtho@webmail.co.za>; 'Lizell Strohl' <strohl@caa.co.za>; 'Nicole Abrahams' <AbrahamsN@nra.co.za>; 'Mlungisi Ngwenya' <Mlungisi.Ngwenya@weathersa.co.za>; 'Frank Creese' <creesef@sentech.co.za>; 'Alisha Pretorius' <pretoriusa@sentech.co.za>; 'Johan Koegelenberg' <KoegelenbergJ@sentech.co.za>; 'Ramatholo Sefako' <rrs@saao.ac.za>; 'Danie Erasmus' <radiotech@saps.org.za>; 'Adriaan Tiplady' <atiplady@ska.ac.za>; 'Keverne Thurling' <Thurling@telkom.co.za>; 'Heleen van den Heever' <vdheevhd@telkom.co.za>; 'Amanda Bester' <WayleaCR@telkom.co.za>; 'Morgan Griffiths' <morgan.griffiths@wessa.co.za>

Subject: Rondekop Wind Energy Facility near Sutherland: DSR Comment Period Starting

Dear Stakeholder

ENVIRONMENTAL IMPACT ASSESSMENT PROCESS (EIA) FOR THE PROPOSED 325MW RONDEKOP WIND ENERGY FACILITY BETWEEN MATJIESFONTEIN AND SUTHERLAND IN THE NORTHERN CAPE PROVINCE

SiVEST is in the process of undertaking the Environmental Impact Assessment (EIA) for the proposed development of the Rondekop Wind Energy Facility near Sutherland in the Northern Cape.

We would like to take this opportunity to inform you that, in accordance with the National Environmental Management Act, 1998 (Act No. 107 of 1998) (NEMA) (as amended), the Draft Scoping Report (DSR) for the above mentioned wind project will be available for public comment and review as from **Wednesday the 14th of November 2018 to the Friday 14th of December 2018** (before end of business day).

The DSRs as well as the accompanying appendices are available online (<http://data.g7energies.com/eia/rondekop>) and an electronic copy (on CD) has been posted to you. We kindly request that you submit your comments to the Public Participation Office at the below details, on or before Friday the 14th of December 2018 (before end of business day). SiVEST will forward any comments received after the public comment and review period directly to the relevant case officer at the Department of Environmental Affairs (DEA).

Should you have any questions or queries please do not hesitate to contact us at:

Hlengiwe Ntuli

PO Box 2921, RIVONIA, 2128

Phone: (011) 798 0600

E-mail: hlengiwen@sivest.co.za

Fax: (011) 803 7272

Kind Regards

Shivani Naidoo

Environmental Consultant

SIVEST Environmental Division



SiVEST is a Level 3 BBBEE Contributor

D +27 11 798 0600 | **T** +27 11 798 0600 **W** www.sivest.co.za

Engineering Consulting | Project Management | Environmental Consulting | Town & Regional Planning | Management Systems Consulting

Durban | Johannesburg | Pretoria | Pietermaritzburg | Richards Bay | Port Louis (Mauritius)

Disclaimer

The information contained in this communication from the sender is confidential. It is intended solely for use by the recipient and others authorized to receive it. If you are not the recipient, you are hereby notified that any disclosure, copying, distribution or taking action in relation of the contents of this information is strictly prohibited and may be unlawful.

This email has been scanned for viruses and malware, and automatically archived by **Mimecast SA (Pty) Ltd**, an innovator in Software as a Service (SaaS) for business. **Mimecast Unified Email Management ??? (UEM)** offers email continuity, security, archiving and compliance with all current legislation. To find out more, [contact Mimecast](#).

Liandra Scott-Shaw

From: Liandra Scott-Shaw
Sent: Tuesday, 18 December 2018 9:30 AM
To: 'kleynhansw@caa.co.za'
Cc: Andrea Gibb; Shivani Naidoo; 'Veronique Fyfe'
Subject: 15260: Rondekop Wind Energy Facility near Sutherland: DSR Comment Period Ending

Tracking:	Recipient	Delivery
	'kleynhansw@caa.co.za'	
	Andrea Gibb	Delivered: 2018/12/18 9:30 AM
	Shivani Naidoo	Delivered: 2018/12/18 9:30 AM
	'Veronique Fyfe'	

Dear Mr Kleynhans

Thank you for your comments.

Kind regards

Liandra Scott-Shaw (*Pr.Sci.Nat*)
Environmental Scientist
SiVEST Environmental Division



SiVEST is a Level 3 BBBEE Contributor

T +27 33 347 1600 | **M** +2773 658 7955 | **E** liandras@sivest.co.za | **W** www.sivest.co.za

Engineering Consulting | Project Management | Environmental Consulting | Town & Regional Planning | Management Systems Consulting

Durban | Johannesburg | Pretoria | Pietermaritzburg | Richards Bay | Port Louis (Mauritius)

From: Werner Kleynhans [<mailto:kleynhansw@caa.co.za>]
Sent: 14 December 2018 02:27 PM
To: sivest_PPP <sivest_ppp@sivest.co.za>
Subject: RE: Rondekop Wind Energy Facility near Sutherland: DSR Comment Period Ending

Dear Me Naidoo

The email regarding the proposed development of the Rondekop Wind Energy facility between Matjiesfontein and Sutherland refer.

Due to the proximity of the site relative to the Sutherland Navigation Beacon (VOR SLV) & the Sutherland Radar, a more detailed investigation is required to determine if the proposed wind farm will have an impact on these aviation safety critical navigation systems. The SACAA will therefore not be able to provide a response by close of business today but will provide an official response by no later than 11 January 2019.

In terms of the Civil Aviation Regulations (CAR) Part 139.01.30, approval of the Director of Civil Aviation will be required due to the location (°, height & nature of the structure. The Obstacle application process is published on

the CAA's website (<http://www.caa.co.za/Pages/Obstacles/Urgent-notice.aspx>). Kindly also note "Obstacle Notice 2/2017 (17/11/2017): Additional Requirements for Wind Farm Applications" which requires that all new wind farm applications have to be accompanied by an aviation Communication, Navigation & Surveillance (CNS) Impact Assessment Report obtained from ATNS.

Kind Regards



Werner Kleynhans
Manager: PANS-OPS
PANS-OPS Section
Air Navigation Services Department
Tel: +27 11 545 1468 | Mobile: +27 82 774 8994
Email: kleynhansw@caa.co.za | www.caa.co.za
Follow us on  

From: sivest_PPP [mailto:sivest_ppp@sivest.co.za]

Sent: 12 December 2018 10:14 AM

To: Andrea Gibb; Shivani Naidoo; 'Veronique Fyfe'; Liandra Scott-Shaw

Cc: 'Henning Myburg'; 'Simphiwe Masilela'; 'Johanna Morobane'; 'Phillip De Lange'; 'Ferdie Smit'; 'Candice Stevens'; 'Samantha Ralston-Paton'; 'Jacoline Mans'; 'Paul Avenant'; 'Colonel Loy de Jager'; 'Mmatlala Rabothata'; 'Seoka Lekota'; 'Ntsundeni Ravhogni'; 'Patrick Lenyibi'; 'Ester Makungo'; 'Moses Mahunonyane'; 'Brian Fisher'; 'Andre Crous'; 'John Geeringh'; 'Lourens Leeuwner'; 'Allistar Gibbons'; 'Jannie Loubser'; 'Gert Steenkamp'; 'Jaco Roelofse'; 'Thulani Mthombeni'; Lizell Stroh; 'Nicole Abrahams'; 'Mlungisi Ngwenya'; 'Frank Creese'; 'Alisha Pretorius'; 'Johan Koegelenberg'; 'Ramatholo Sefako'; 'Danie Erasmus'; 'Adriaan Tiplady'; 'Keverne Thurling'; 'Heleen van den Heever'; 'Amanda Bester'; 'Morgan Griffiths'; 'Administration'; 'Johan'; 'Adriaan Tiplady'; 'Alisha Pretorius'; 'Allistar Gibbons'; 'Amanda Bester'; 'Andre Crous'; 'Brian Fisher'; 'Candice Stevens'; 'Charles van Reenen'; 'Coert Smit'; 'Colonel Loy de Jager'; 'Craig Barnes'; 'Danie Erasmus'; 'Ester Makungo'; 'Ferdie Smit'; 'Frank Creese'; 'Gert Steenkamp'; 'Giel Klazen'; 'Heleen van den Heever'; 'Henning Myburg'; 'J Martiens'; 'Jaco Roelofse'; 'Jacobus Jooste'; 'Jacoline Mans'; 'Jan Johannes Jacobs'; 'Jannie Loubser'; 'Jeremy Davids'; 'Johan Koegelenberg'; 'Johan van der Colff'; 'Johanna Morobane'; 'John Geeringh'; 'Keverne Thurling'; Lizell Stroh; 'Lourens Leeuwner'; 'M Malan'; 'Mmatlala Rabothata'; 'Morgan Griffiths'; 'Moses Mahunonyane'; 'Nelly Boshieho'; 'Nicole Abrahams'; 'Ntsundeni Ravhogni'; 'Patrick Lenyibi'; 'Paul Avenant'; 'Phillip De Lange'; 'Ramatholo Sefako'; 'Rasibe Sekepane'; 'Rene De Kock'; 'Ronell Cloete'; 'S Frans'; 'Sam Fiff'; 'Samantha Ralston-Paton'; 'Seoka Lekota'; 'Simphiwe Masilela'; 'Thoko Buthelezi'; 'Thulani Mthombeni'; 'Tshegofatso Monama'; 'Veruschka Wentzel'; 'Vincent Muila'; 'Vivian Kiewitz'; 'Willenise Klein'; 'ruth.cuttings@yahoo.com'; 'Mpho Sebole'; Obstacles; 'isak@breedenet.co.za'; 'kmothomi@ncpg.gov.za'; 'mayorv@karoohoogland.gov.za'

Subject: Rondekop Wind Energy Facility near Sutherland: DSR Comment Period Ending

Importance: High

Dear Stakeholder,

SiVEST sent the Draft Scoping report for the proposed 325MW Rondekop Wind Energy facility between Matjiesfontein and Sutherland in the Northern Cape province to your department on 14th November 2018 for comment (refer to the below email). Please can you advise if comments will be submitted to us for inclusion in the final Scoping Report.

We would like to inform you that the comment period is ending on **Friday 14th December 2018** and you are advised to please send comments as soon as possible.

Should you have any comments, please feel free to contact the public participation office at the details below:

Sivest Environmental

PO Box 2921, RIVONIA, 2128

Phone: (011) 798 0600

E-mail: hlengiwen@sivest.co.za / Sivest_ppp@sivest.co.za

Fax: (011) 803 7272

Kind Regards

Shivani Naidoo
Environmental Consultant
SiVEST Environmental Division

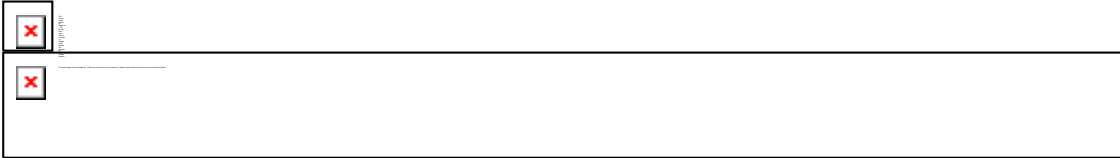

SiVEST is a Level 3 BBBEE Contributor

D +27 11 798 0600 | **T** +27 11 798 0600 **W** www.sivest.co.za

Engineering Consulting | Project Management | Environmental Consulting | Town & Regional Planning | Management Systems Consulting

Durban | Johannesburg | Pretoria | Pietermaritzburg | Richards Bay | Port Louis (Mauritius)

From: sivest_PPP

Sent: 14 November 2018 05:40 PM

To: Andrea Gibb <AndreaG@sivest.co.za>; Shivani Naidoo <ShivaniN@sivest.co.za>; 'Veronique Fyfe' <veronique@g7energies.com>

Cc: 'Henning Myburg' <henning@agrink.co.za>; 'Simpfiwe Masilela' <ObstacleEvaluators@atns.co.za>; 'Johanna Morobane' <JohannaM@atns.co.za>; 'Phillip De Lange' <phillipd@atns.co.za>; 'Ferdie Smit' <ferdis@atns.co.za>; 'Candice Stevens' <advocacy@birdlife.org.za>; 'Samantha Ralston-Paton' <energy@birdlife.org.za>; 'Jacoline Mans' <jacolinema@daff.gov.za>; 'Paul Avenant' <paula@daff.gov.za>; 'Colonel Loy de Jager' <loydejager@hotmail.com>; 'Mmatlala Rabothata' <mrabothata@environment.gov.za>; 'Seoka Lekota' <slekota@environment.gov.za>; 'Ntsundeni Ravhogoni' <Ntsundeni.Ravhogoni@dmr.gov.za>; 'Patrick Lenyibi' <plenyibi@ncpg.gov.za>; 'Ester Makungo' <makungoe@dws.gov.za>; 'Moses Mahunonyane' <MahunonyaneM@dws.gov.za>; 'Brian Fisher' <bfisher@ncpg.gov.za>; 'Andre Crous' <andre.crous@eskom.co.za>; 'John Geeringh' <GeerinJH@eskom.co.za>; 'Lourens Leeuwner' <lourensl@ewt.org.za>; 'Allistar Gibbons' <a.gibbons@karoohoogland.gov.za>; 'Jannie Loubser' <janniel@namakwa-dm.gov.za>; 'Gert Steenkamp' <gsteenkamp@ncpg.gov.za>; 'Jaco Roelofse' <roelofse.j@vodamail.co.za>; 'Thulani Mthombeni' <tmtho@webmail.co.za>; 'Lizell Strohl' <strohl@caa.co.za>; 'Nicole Abrahams' <AbrahamsN@nra.co.za>; 'Mlungisi Ngwenya' <Mlungisi.Ngwenya@weathersa.co.za>; 'Frank Creese' <creesef@sentech.co.za>; 'Alisha Pretorius' <pretoriusa@sentech.co.za>; 'Johan Koegelenberg' <KoegelenbergJ@sentech.co.za>; 'Ramatholo Sefako' <rrs@saao.ac.za>; 'Danie Erasmus' <radiotech@saps.org.za>; 'Adriaan Tiplady' <atiplady@ska.ac.za>; 'Keverne Thurling' <Thurling@telkom.co.za>; 'Heleen van den Heever' <vdheevhd@telkom.co.za>; 'Amanda Bester' <WayleaCR@telkom.co.za>; 'Morgan Griffiths' <morgan.griffiths@wessa.co.za>

Subject: Rondekop Wind Energy Facility near Sutherland: DSR Comment Period Starting

Dear Stakeholder

ENVIRONMENTAL IMPACT ASSESSMENT PROCESS (EIA) FOR THE PROPOSED 325MW RONDEKOP WIND ENERGY FACILITY BETWEEN MATJIESFONTEIN AND SUTHERLAND IN THE NORTHERN CAPE PROVINCE

SiVEST is in the process of undertaking the Environmental Impact Assessment (EIA) for the proposed development of the Rondekop Wind Energy Facility near Sutherland in the Northern Cape.

We would like to take this opportunity to inform you that, in accordance with the National Environmental Management Act, 1998 (Act No. 107 of 1998) (NEMA) (as amended), the Draft Scoping Report (DSR) for the above mentioned wind project will be available for public comment and review as from **Wednesday the 14th of November 2018 to the Friday 14th of December 2018** (before end of business day).

The DSRs as well as the accompanying appendices are available online (<http://data.g7energies.com/eia/rondekop>) and an electronic copy (on CD) has been posted to you. We kindly request that you submit your comments to the Public Participation Office at the below details, on or before Friday the 14th of December 2018 (before end of business day). SiVEST will forward any comments received after the public comment and review period directly to the relevant case officer at the Department of Environmental Affairs (DEA).

Should you have any questions or queries please do not hesitate to contact us at:

Hlengiwe Ntuli

PO Box 2921, RIVONIA, 2128

Phone: (011) 798 0600

E-mail: hlengiwen@sivest.co.za

Fax: (011) 803 7272

Kind Regards

Shivani Naidoo

Environmental Consultant

SiVEST Environmental Division

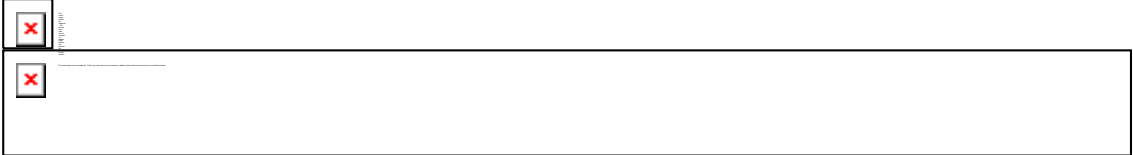

SiVEST is a Level 3 BBBEE Contributor

D +27 11 798 0600 | **T** +27 11 798 0600 **W** www.sivest.co.za

Engineering Consulting | Project Management | Environmental Consulting | Town & Regional Planning | Management Systems Consulting

Durban | Johannesburg | Pretoria | Pietermaritzburg | Richards Bay | Port Louis (Mauritius)

Disclaimer

The information contained in this communication from the sender is confidential. It is intended solely for use by the recipient and others authorized to receive it. If you are not the recipient, you are hereby notified that any disclosure, copying, distribution or taking action in relation of the contents of this information is strictly prohibited and may be unlawful.

This email has been scanned for viruses and malware, and automatically archived by **Mimecast SA (Pty) Ltd**, an innovator in Software as a Service (SaaS) for business. **Mimecast Unified Email Management ??? (UEM)** offers email continuity, security, archiving and compliance with all current legislation. To find out more, [contact Mimecast](#).

Email secured by Check Point



Confidentiality and Disclaimer Notice: This email contains the South African Civil Aviation Authority

(◆SACAA◆) confidential information intended only for the person to whom it is addressed and access to this e-mail by anyone else is unauthorized. Any recipient who is not a named addressee is not entitled to read the rest of the email or disclose its contents to any person or take copies. An incorrect addressee is requested to notify SACAA immediately by return email. Whilst all reasonable steps are taken to ensure the accuracy and integrity of information and data transmitted electronically and to preserve the confidentiality thereof, no liability or responsibility whatsoever is accepted if information or data is, for whatever reason, corrupted or does not reach its intended destination. In the event that this e mail is of a personal nature and not business related, the recipient must note that this e-mail is not authorised by, or sent on behalf of the senders employer.



Confidentiality and Disclaimer Notice: This email contains the South African Civil Aviation Authority (SACAA) confidential information intended only for the person to whom it is addressed and access to this e-mail by anyone else is unauthorized. Any recipient who is not a named addressee is not entitled to read the rest of the email or disclose its contents to any person or take copies. An incorrect addressee is requested to notify SACAA immediately by return email. Whilst all reasonable steps are taken to ensure the accuracy and integrity of information and data transmitted electronically and to preserve the confidentiality thereof, no liability or responsibility whatsoever is accepted if information or data is, for whatever reason, corrupted or does not reach its intended destination. In the event that this e mail is of a personal nature and not business related, the recipient must note that this e-mail is not authorised by, or sent on behalf of the senders employer.

This email has been scanned for email related threats and delivered safely by Mimecast.
For more information please visit <http://www.mimecast.com>

Liandra Scott-Shaw

From: Liandra Scott-Shaw
Sent: Tuesday, 18 December 2018 9:32 AM
To: 'SimphiweM@atns.co.za'
Cc: Andrea Gibb; Shivani Naidoo; 'grahamm@atns.co.za'; 'FrancoisC@atns.co.za'; 'Veronique Fyfe'
Subject: 15260: Rondekop Wind Energy Facility near Sutherland: DSR Comment Period Starting

Tracking:	Recipient	Delivery	Read
	'SimphiweM@atns.co.za'		
	Andrea Gibb	Delivered: 2018/12/18 9:32 AM	
	Shivani Naidoo	Delivered: 2018/12/18 9:32 AM	Read: 2018/12/18 9:32 AM
	'grahamm@atns.co.za'		
	'FrancoisC@atns.co.za'		
	'Veronique Fyfe'		

Dear Mr Masilela

Thank you for your comments.

Kind regards

Liandra Scott-Shaw (*Pr.Sci.Nat*)
Environmental Scientist
SiVEST Environmental Division



SiVEST is a Level 3 BBBEE Contributor

T +27 33 347 1600 | **M** +2773 658 7955 | **E** liandras@sivest.co.za | **W** www.sivest.co.za

Engineering Consulting | Project Management | Environmental Consulting | Town & Regional Planning | Management Systems Consulting

Durban | Johannesburg | Pretoria | Pietermaritzburg | Richards Bay | Port Louis (Mauritius)

From: Simphiwe Masilela [<mailto:SimphiweM@atns.co.za>]
Sent: 14 December 2018 11:29 AM
To: sivest_PPP <sivest_ppp@sivest.co.za>
Cc: Graham Mondzinger <grahamm@atns.co.za>; Francois Coetzee <FrancoisC@atns.co.za>
Subject: RE: Rondekop Wind Energy Facility near Sutherland: DSR Comment Period Starting

ATNS
WGS-84 SURVEY
A step towards reaching your AIS to AIM Roadmap - an ICAO requirement

GET YOUR FREE OBSTACLE EVALUATION TODAY:
BOOK A FULL WGS-84 SURVEY WITH US!

MORE INFO...

Good day Hlengiwe,

RE: RONDEKOP WIND ENERGY FACILITY

This area is situated 214KM NE of Cape Town International Airport and 208KM W of Langebaanweg Military Airport (They need to make comments as well).

The proposed falls outside the Annex14 surfaces associated with the mentioned airport, however, we need to determine what will affect the safety of flights.

We would have to conduct a formal Communication, Navigation and Surveillance (CNS) assessment as per South African Civil Aviation Authority (SACAA) request, the proposed should not be seen by the radar.

The line of sight may be affected upon a Terrain profile assessment, as the radar extends to a 250NM radius.

We request that you please update us should there be any new developments that may affect our interests.

We will duly conduct assessments as required when the project is ready for construction upon a formal request.

Kindly note there is a charge attached to this service.

Furthermore, we kindly request that all queries or new applications to be forwarded to the Obstacle Evaluators on the following obstacleEvaluator@atns.co.za

Please note, for us to carry out a successful assessment we require the following information:

1. LOCATION (Co-ordinates WGS84 system)
2. SITE/GROUND ELEVATION (AMSL)
3. HEIGHT TO TOP OF PROPOSED DEVELOPMENT (in meters)
4. THE NUMBER OF WIND TURBINES

Kind Regards,

Simphiwe Masilela

Obstacle Evaluator | COO - Air Traffic Services
ATNS Head Office, Bruma, Johannesburg, South Africa

T: +2711 607 1228 • F: 011 607 1466 • C:
E: SimphiweM@atns.co.za • W: www.atns.com



[View Disclaimer](#)

From: sivest_PPP [mailto:sivest_ppp@sivest.co.za]

Sent: Wednesday, November 14, 2018 5:40 PM

To: Andrea Gibb <AndreaG@sivest.co.za>; Shivani Naidoo <ShivaniN@sivest.co.za>; 'Veronique Fyfe' <veronique@g7energie.com>

Cc: 'Henning Myburg' <henning@agrink.co.za>; Obstacle Evaluators <ObstacleEvaluators@atns.co.za>; Johanna Morobane <JohannaM@atns.co.za>; Phillip De Lange <phillipd@atns.co.za>; Ferdi Smit <ferdis@atns.co.za>; 'Candice Stevens' <advocac@atns.co.za>; 'Samantha Ralston-Paton' <energy@birdlife.org.za>; 'Jacoline Mans' <jacolinema@daff.gov.za>; 'Paul Avenant' <paula@daff.gov.za>

de Jager' <loydejager@hotmail.com>; 'Mmatlala Rabothata' <mrabothata@environment.gov.za>; 'Seoka Lekota' <slekota@e>
'Ntsundeni Ravhogoni' <Ntsundeni.Ravhogoni@dmr.gov.za>; 'Patrick Lenyibi' <plenyibi@ncpg.gov.za>; 'Ester Makungo'
<makungoe@dws.gov.za>; 'Moses Mahunonyane' <MahunonyaneM@dws.gov.za>; 'Brian Fisher' <bfisher@ncpg.gov.za>; 'Ar
<andre.crous@eskom.co.za>; 'John Geeringh' <GeerinJH@eskom.co.za>; 'Lourens Leeuwner' <lourensl@ewt.org.za>; 'Allistar
<a.gibbons@karoohoogland.gov.za>; 'Jannie Loubser' <janniel@namakwa-dm.gov.za>; 'Gert Steenkamp' <gsteenkamp@ncpg>
'Roelofse' <roelofse.j@vodamail.co.za>; 'Thulani Mthombeni' <tmtho@webmail.co.za>; 'Lizell Stroh' <strohl@caa.co.za>; 'Nic
<AbrahamsN@nra.co.za>; 'Mlungisi Ngwenya' <Mlungisi.Ngwenya@weathersa.co.za>; 'Frank Creese' <creesef@sentech.co.z>
<pretoriusa@sentech.co.za>; 'Johan Koegelenberg' <KoegelenbergJ@sentech.co.za>; 'Ramatholo Sefako' <rrs@sao.ac.za>;
<radiotech@saps.org.za>; 'Adriaan Tiplady' <atiplady@ska.ac.za>; 'Keverne Thurling' <Thurling@telkom.co.za>; 'Heleen van c
<vdheevhd@telkom.co.za>; 'Amanda Bester' <WayleaCR@telkom.co.za>; 'Morgan Griffiths' <morgan.griffiths@wessa.co.za>

Subject: Rondekop Wind Energy Facility near Sutherland: DSR Comment Period Starting

Dear Stakeholder

ENVIRONMENTAL IMPACT ASSESSMENT PROCESS (EIA) FOR THE PROPOSED 325MW RONDEKOP WIND ENERGY BETWEEN MATJIESFONTEIN AND SUTHERLAND IN THE NORTHERN CAPE PROVINCE

SiVEST is in the process of undertaking the Environmental Impact Assessment (EIA) for the proposed development of the Rondekop Wind Energy Facility near Sutherland in the Northern Cape.

We would like to take this opportunity to inform you that, in accordance with the National Environmental Management Act, 1998 (NEMA) (as amended), the Draft Scoping Report (DSR) for the above mentioned wind project will be available for public comment from **Wednesday the 14th of November 2018 to the Friday 14th of December 2018** (before end of business day).

The DSRs as well as the accompanying appendices are available online (<http://data.g7energies.com/eia/rondekop>) and an email has been posted to you. We kindly request that you submit your comments to the Public Participation Office at the below details by the 14th of December 2018 (before end of business day). SiVEST will forward any comments received after the public comment period directly to the relevant case officer at the Department of Environmental Affairs (DEA).

Should you have any questions or queries please do not hesitate to contact us at:

Hlengiwe Ntuli

PO Box 2921, RIVONIA, 2128

Phone: (011) 798 0600

E-mail: hlengiwen@sivest.co.za

Fax: (011) 803 7272

Kind Regards

Shivani Naidoo

Environmental Consultant

SiVEST Environmental Division



SiVEST is a Level 3 BBBEE Contributor

D +27 11 798 0600 | **T** +27 11 798 0600 **W** www.sivest.co.za

Engineering Consulting | Project Management | Environmental Consulting | Town & Regional Planning | Management Systems Consulting
Durban | Johannesburg | Pretoria | Pietermaritzburg | Richards Bay | Port Louis (Mauritius)

Disclaimer

The information contained in this communication from the sender is confidential. It is intended solely for use by the recipient and others who are authorised to receive it. If you are not the recipient, you are hereby notified that any disclosure, copying, distribution or taking action in relation of the contents of this information is strictly prohibited and may be unlawful.

This email has been scanned for viruses and malware, and automatically archived by **Mimecast SA (Pty) Ltd**, an innovator in Software as a Service.

business. **Mimecast Unified Email Management ??? (UEM)** offers email continuity, security, archiving and compliance with all current I more, [contact Mimecast](#).

The contents of this email are confidential and intended for the named recipient(s) only. The information may be privileged or otherwise protected from disclosure. The views expressed in this message are those of the sender, unless otherwise stated to be. This email is also subject to copyright. No part hereof may be reproduced, adapted, transmitted, or used in any way without the written consent of ATNS SOC Limited. Please do not hesitate to contact us immediately should you have any doubts regarding the authenticity of an email purportedly sent by the sender.

The provisions of Sections 11,12, and 13 of the Electronic Communications and Transactions Act, 25 of 2002, in so far as e-contracting is concerned are expressly excluded and contracted out of by Air Traffic Navigation Services (ATNS) and, unless clearly stated to the contrary in the body of the data message or electronic communication no data message or electronic communication will be recognised as having legal contractual status as per the aforementioned provisions under any circumstances. All contracts concluded by ATNS and its Business Units will only be legally binding and recognised once reduced to physical writing and physically signed by a duly authorised representative of ATNS. All other provisions of the Electronic Communications and Transactions Act, 25 of 2002 are accepted.

Although ATNS has taken all reasonable precautions to ensure that this e-mail is virus free, ATNS does not accept any liability for any damage caused by any virus transmitted by this email.

Liandra Scott-Shaw

From: Liandra Scott-Shaw
Sent: Tuesday, 08 January 2019 3:06 PM
To: 'Werner Kleynhans'
Cc: Andrea Gibb; 'Veronique Fyfe'; Hlengiwe Ntuli
Subject: RE: 15260: Rondekop Wind Energy Facility near Sutherland: DSR Comment Period Ending

Tracking:	Recipient	Delivery	Read
	'Werner Kleynhans'		
	Andrea Gibb	Delivered: 2019/01/08 3:06 PM	Read: 2019/01/08 4:05 PM
	'Veronique Fyfe'		
	Hlengiwe Ntuli	Delivered: 2019/01/08 3:06 PM	Read: 2019/01/08 3:26 PM

Dear Mr Kleynhans

Happy New Year!

This is just a courtesy email to confirm that the SACAA will still be providing comment by the 11th January on the Rondekop Wind Energy Facility near Sutherland?

Kind regards

Liandra Scott-Shaw (*Pr.Sci.Nat*)
Environmental Scientist
SiVEST Environmental Division



SiVEST is a Level 3 BBBEE Contributor

T +27 33 347 1600 | **M** +2773 658 7955 | **E** liandras@sivest.co.za | **W** www.sivest.co.za

Engineering Consulting | Project Management | Environmental Consulting | Town & Regional Planning | Management Systems Consulting

Durban | Johannesburg | Pretoria | Pietermaritzburg | Richards Bay | Port Louis (Mauritius)

From: Werner Kleynhans [mailto:kleynhansw@caa.co.za]
Sent: Tuesday, 18 December 2018 9:29 AM
To: Liandra Scott-Shaw
Subject: Automatic reply: 15260: Rondekop Wind Energy Facility near Sutherland: DSR Comment Period Ending

Kindly note that:

1. The SACAA will be closed from 22 December 2018 & will reopen on 02 January 2019. During this period, please contact me on +27 82 774 8994 for any urgent matters that cannot wait until 2 January 2019. Please leave a message or send a text/WhatsApp & I will respond as soon as I can.

2. I am leave from 18-21 December 2018 & will be back in the office on 2 January 2019.

For PANS-OPS, Cartography & General Office matters please contact:

Mr Thulani Masuku
Email: masukut@caa.co.za
Tel: +27 11 545 1071

For Obstacle matters please contact:

Mr Canny Mothapo
Email: mothapoc@caa.co.za<<mailto:mothapoc@caa.co.za>>
Tel: +27 11 545 1364

Ms Gugulethu Khanyile
Email: khanyileg@caa.co.za<<mailto:khanyileg@caa.co.za>>
Tel: +27 11 545 1036

For all other urgent matters, please contact me on +27 82 774 8994. Please leave a message or send a text/WhatsApp & I will respond as soon as I can.

Kind Regards

Werner Kleynhans
Manager: PANS-OPS
PANS-OPS Section
Air Navigation Services Department
Tel: +27 11 545 1468 | Mobile: +27 82 774 8994
Email: kleynhansw@caa.co.za<<mailto:kleynhansw@caa.co.za>>

[Facebook]<<https://www.facebook.com/pages/South-African-Civil-Aviation-Authority-SACAA/804366836280516>> [Twitter] <https://twitter.com/SA_CAA>

Confidentiality and Disclaimer Notice: This email contains the South African Civil Aviation Authority (SACAA) confidential information intended only for the person to whom it is addressed and access to this e-mail by anyone else is unauthorized. Any recipient who is not a named addressee is not entitled to read the rest of the email or disclose its contents to any person or take copies. An incorrect addressee is requested to notify SACAA immediately by return email. Whilst all reasonable steps are taken to ensure the accuracy and integrity of information and data transmitted electronically and to preserve the confidentiality thereof, no liability or responsibility whatsoever is accepted if information or data is, for whatever reason, corrupted or does not reach its intended destination. In the event that this e mail is of a personal nature and not business related, the recipient must note that this e-mail is not authorised by, or sent on behalf of the senders employer.

This email has been scanned for email related threats and delivered safely by Mimecast.
For more information please visit <http://www.mimecast.com>

sivest_PPP

From: sivest_PPP
Sent: 08 January 2019 03:54 PM
To: Andrea Gibb; Shivani Naidoo; Liandra Scott-Shaw; 'Veronique Fyfe'
Cc: 'ammoiemang@ncpg.gov.za'; 'VCloete@environment.gov.za';
'valdaccloete@gmail.com'; 'Thulani Mthombeni'; 'Brian Fisher'
Subject: RE: Rondekop Wind Energy Facility near Sutherland: DSR Comment Period Ending
Importance: High

Dear Ms. P. Williams,

As per the below email, we would like to confirm that DENC will not be commenting at the DSR phase and will have opportunity to Comment at the DEIR phase.

Kind Regards,
Hlengiwe Ntuli

From: sivest_PPP
Sent: 12 December 2018 10:14 AM
To: Andrea Gibb <AndreaG@sivest.co.za>; Shivani Naidoo <ShivaniN@sivest.co.za>; 'Veronique Fyfe' <veronique@g7energies.com>; Liandra Scott-Shaw <LiandraS@sivest.co.za>
Cc: 'Henning Myburg' <henning@agrink.co.za>; 'Simphiwe Masilela' <ObstacleEvaluators@atns.co.za>; 'Johanna Morobane' <JohannaM@atns.co.za>; 'Phillip De Lange' <phillipd@atns.co.za>; 'Ferdie Smit' <ferdis@atns.co.za>; 'Candice Stevens' <advocacy@birdlife.org.za>; 'Samantha Ralston-Paton' <energy@birdlife.org.za>; 'Jacoline Mans' <jacolinema@daff.gov.za>; 'Paul Avenant' <paula@daff.gov.za>; 'Colonel Loy de Jager' <loydejager@hotmail.com>; 'Mmatlala Rabothata' <mrabothata@environment.gov.za>; 'Seoka Lekota' <slekota@environment.gov.za>; 'Ntsundeni Ravhogoni' <Ntsundeni.Ravhogoni@dmr.gov.za>; 'Patrick Lenyibi' <plenyibi@ncpg.gov.za>; 'Ester Makungo' <makungoe@dws.gov.za>; 'Moses Mahunonyane' <MahunonyaneM@dws.gov.za>; 'Brian Fisher' <bfisher@ncpg.gov.za>; 'Andre Crous' <andre.crous@eskom.co.za>; 'John Geeringh' <GeerinJH@eskom.co.za>; 'Lourens Leeuwner' <lourensl@ewt.org.za>; 'Allistar Gibbons' <a.gibbons@karoohoogland.gov.za>; 'Jannie Loubser' <janniel@namakwa-dm.gov.za>; 'Gert Steenkamp' <gsteenkamp@ncpg.gov.za>; 'Jaco Roelofse' <roelofse.j@vodamail.co.za>; 'Thulani Mthombeni' <tmtho@webmail.co.za>; 'Lizell Stroh' <strohl@caa.co.za>; 'Nicole Abrahams' <AbrahamsN@nra.co.za>; 'Mlungisi Ngwenya' <Mlungisi.Ngwenya@weathersa.co.za>; 'Frank Creese' <creesef@sentech.co.za>; 'Alisha Pretorius' <pretoriusa@sentech.co.za>; 'Johan Koegelenberg' <KoegelenbergJ@sentech.co.za>; 'Ramatholo Sefako' <rrs@sao.ac.za>; 'Danie Erasmus' <radiotech@saps.org.za>; 'Adriaan Tiplady' <atiplady@ska.ac.za>; 'Keverne Thurling' <Thurling@telkom.co.za>; 'Heleen van den Heever' <vdheevhd@telkom.co.za>; 'Amanda Bester' <WayleaCR@telkom.co.za>; 'Morgan Griffiths' <morgan.griffiths@wessa.co.za>; 'Administration' <salt@salt.ac.za>; 'Johan' <Johan@fleetcall.co.za>; 'Adriaan Tiplady' <atiplady@ska.ac.za>; 'Alisha Pretorius' <pretoriusa@sentech.co.za>; 'Allistar Gibbons' <a.gibbons@karoohoogland.gov.za>; 'Amanda Bester' <WayleaCR@telkom.co.za>; 'Andre Crous' <andre.crous@eskom.co.za>; 'Brian Fisher' <bfisher@ncpg.gov.za>; 'Candice Stevens' <advocacy@birdlife.org.za>; 'Charles van Reenen' <vanree_c@mtn.co.za>; 'Coert Smit' <coert@breedenet.co.za>; 'Colonel Loy de Jager' <loydejager@hotmail.com>; 'Craig Barnes' <barnesc@vodacom.co.za>; 'Danie Erasmus' <radiotech@saps.org.za>; 'Ester Makungo' <makungoe@dws.gov.za>; 'Ferdie Smit' <ferdis@atns.co.za>; 'Frank Creese' <creesef@sentech.co.za>; 'Gert Steenkamp' <gsteenkamp@ncpg.gov.za>; 'Giel Klazen' <seunklazen@gmail.com>; 'Heleen van den Heever' <vdheevhd@telkom.co.za>; 'Henning Myburg' <henning@agrink.co.za>; 'J Martiens' <sutherlandlib@ncpg.gov.za>; 'Jaco Roelofse' <roelofse.j@vodamail.co.za>; 'Jacobus Jooste' <info@karoohoogland.gov.za>; 'Jacoline Mans' <jacolinema@daff.gov.za>; 'Jan Johannes Jacobs' <jacobsjan624@gmail.com>; 'Jannie Loubser' <janniel@namakwa-dm.gov.za>; 'Jeremy Davids' <jeremydavids11@gmail.com>; 'Johan Koegelenberg' <KoegelenbergJ@sentech.co.za>; 'Johan van der Colff' <jvdc@mtnloaded.co.za>; 'Johanna Morobane' <JohannaM@atns.co.za>; 'John Geeringh' <GeerinJH@eskom.co.za>; 'Keverne Thurling' <Thurling@telkom.co.za>; 'Lizell Stroh' <strohl@caa.co.za>; 'Lourens Leeuwner'

<lourensl@ewt.org.za>; 'M Malan' <sutherland.sc@saps.gov.za>; 'Mmatlala Rabothata' <mrabothata@environment.gov.za>; 'Morgan Griffiths' <morgan.griffiths@wessa.co.za>; 'Moses Mahunonyane' <MahunonyaneM@dws.gov.za>; 'Nelly Boshielo' <Nelly.Boshielo@weathersa.co.za>; 'Nicole Abrahams' <AbrahamsN@nra.co.za>; 'Ntsundeni Ravhogoni' <Ntsundeni.Ravhogoni@dmr.gov.za>; 'Patrick Lenyibi' <plenyibi@ncpg.gov.za>; 'Paul Avenant' <paula@daff.gov.za>; 'Phillip De Lange' <phillipd@atns.co.za>; 'Ramatholo Sefako' <rrs@saa.ac.za>; 'Rasibe Sekepane' <Lungi.Mondela@dmr.gov.za>; 'Rene De Kock' <Dekockr@nra.co.za>; 'Ronell Cloete' <sutherlandlibrary@ncpg.gov.za>; 'S Frans' <franss@netstar.altech.co.za>; 'Sam Fiff' <Francis.Rahlapane@transnet.net>; 'Samantha Ralston-Paton' <energy@birdlife.org.za>; 'Seoka Lekota' <slekota@environment.gov.za>; 'Simphiwe Masilela' <ObstacleEvaluators@atns.co.za>; 'Thoko Buthelezi' <ThokoB@daff.gov.za>; 'Thulani Mthombeni' <tmtho@webmail.co.za>; 'Tshegofatso Monama' <temonama@ska.ac.za>; 'Veruschka Wentzel' <vcwentzel123@gmail.com>; 'Vincent Muila' <pieter.swart@dmr.gov.za>; 'Vivian Kiewitz' <VKiewitz@cellc.co.za>; 'Willenise Klein' <w.klein@karoohoogland.gov.za>; 'ruth.cuttings@yahoo.com' <ruth.cuttings@yahoo.com>; 'Mpho Sebole' <sebolemd@eskom.co.za>; 'Obstacles@caa.co.za' <Obstacles@caa.co.za>; 'isak@breedenet.co.za' <isak@breedenet.co.za>; 'kmotlhomi@ncpg.gov.za' <kmotlhomi@ncpg.gov.za>; 'mayorv@karoohoogland.gov.za' <mayorv@karoohoogland.gov.za>

Subject: Rondekop Wind Energy Facility near Sutherland: DSR Comment Period Ending

Importance: High

Dear Stakeholder,

SiVEST sent the Draft Scoping report for the proposed 325MW Rondekop Wind Energy facility between Matjiesfontein and Sutherland in the Northern Cape province to your department on 14th November 2018 for comment (refer to the below email). Please can you advise if comments will be submitted to us for inclusion in the final Scoping Report.

We would like to inform you that the comment period is ending on **Friday 14th December 2018** and you are advised to please send comments as soon as possible.

Should you have any comments, please feel free to contact the public participation office at the details below:

Sivest Environmental

PO Box 2921, RIVONIA, 2128

Phone: (011) 798 0600

E-mail: hlenqiwen@sivest.co.za / Sivest_ppp@sivest.co.za

Fax: (011) 803 7272

Kind Regards

Shivani Naidoo

Environmental Consultant

SiVEST Environmental Division

<< OLE Object: Picture (Device Independent Bitmap) >>

SiVEST is a Level 3 BBBEE Contributor

D +27 11 798 0600 | **T** +27 11 798 0600 **W** www.sivest.co.za

Engineering Consulting | Project Management | Environmental Consulting | Town & Regional Planning | Management Systems Consulting

Durban | Johannesburg | Pretoria | Pietermaritzburg | Richards Bay | Port Louis (Mauritius)

From: sivest_PPP

Sent: 14 November 2018 05:40 PM

To: Andrea Gibb <AndreaG@sivest.co.za>; Shivani Naidoo <ShivaniN@sivest.co.za>; 'Veronique Fyfe' <veronique@g7energies.com>

Cc: 'Henning Myburg' <henning@agrink.co.za>; 'Simphiwe Masilela' <ObstacleEvaluators@atns.co.za>; 'Johanna Morobane' <JohannaM@atns.co.za>; 'Phillip De Lange' <phillipd@atns.co.za>; 'Ferdie Smit' <ferdis@atns.co.za>; 'Candice Stevens' <advocacy@birdlife.org.za>; 'Samantha Ralston-Paton' <energy@birdlife.org.za>; 'Jacoline Mans'

<jacolinema@daff.gov.za>; 'Paul Avenant' <paula@daff.gov.za>; 'Colonel Loy de Jager' <loydejager@hotmail.com>; 'Mmatlala Rabothata' <mrabothata@environment.gov.za>; 'Seoka Lekota' <slekota@environment.gov.za>; 'Ntsundeni Ravhogoni' <Ntsundeni.Ravhogoni@dmr.gov.za>; 'Patrick Lenyibi' <plenyibi@ncpg.gov.za>; 'Ester Makungo' <makungoe@dws.gov.za>; 'Moses Mahunonyane' <MahunonyaneM@dws.gov.za>; 'Brian Fisher' <bfisher@ncpg.gov.za>; 'Andre Crous' <andre.crous@eskom.co.za>; 'John Geeringh' <GeerinJH@eskom.co.za>; 'Lourens Leeuwner' <lourensl@ewt.org.za>; 'Allistar Gibbons' <a.gibbons@karoohoogland.gov.za>; 'Jannie Loubser' <jannie@namakwa-dm.gov.za>; 'Gert Steenkamp' <gsteenkamp@ncpg.gov.za>; 'Jaco Roelofse' <roelofse.j@vodamail.co.za>; 'Thulani Mthombeni' <tmtho@webmail.co.za>; 'Lizell Stroh' <strohl@caa.co.za>; 'Nicole Abrahams' <AbrahamsN@nra.co.za>; 'Mlungisi Ngwenya' <Mlungisi.Ngwenya@weathersa.co.za>; 'Frank Creese' <creesef@sentech.co.za>; 'Alisha Pretorius' <pretoriusa@sentech.co.za>; 'Johan Koegelenberg' <KoegelenbergJ@sentech.co.za>; 'Ramatholo Sefako' <rrs@sao.ac.za>; 'Danie Erasmus' <radiotech@saps.org.za>; 'Adriaan Tiplady' <atiplady@ska.ac.za>; 'Keverne Thurling' <Thurling@telkom.co.za>; 'Heleen van den Heever' <vdheevhd@telkom.co.za>; 'Amanda Bester' <WayleaCR@telkom.co.za>; 'Morgan Griffiths' <morgan.griffiths@wessa.co.za>

Subject: Rondekop Wind Energy Facility near Sutherland: DSR Comment Period Starting

Dear Stakeholder

ENVIRONMENTAL IMPACT ASSESSMENT PROCESS (EIA) FOR THE PROPOSED 325MW RONDEKOP WIND ENERGY FACILITY BETWEEN MATJIESFONTEIN AND SUTHERLAND IN THE NORTHERN CAPE PROVINCE

SiVEST is in the process of undertaking the Environmental Impact Assessment (EIA) for the proposed development of the Rondekop Wind Energy Facility near Sutherland in the Northern Cape.

We would like to take this opportunity to inform you that, in accordance with the National Environmental Management Act, 1998 (Act No. 107 of 1998) (NEMA) (as amended), the Draft Scoping Report (DSR) for the above mentioned wind project will be available for public comment and review as from **Wednesday the 14th of November 2018 to the Friday 14th of December 2018** (before end of business day).

The DSRs as well as the accompanying appendices are available online (<http://data.g7energies.com/eia/rondekop>) and an electronic copy (on CD) has been posted to you. We kindly request that you submit your comments to the Public Participation Office at the below details, on or before Friday the 14th of December 2018 (before end of business day). SiVEST will forward any comments received after the public comment and review period directly to the relevant case officer at the Department of Environmental Affairs (DEA).

Should you have any questions or queries please do not hesitate to contact us at:

Hlengiwe Ntuli

PO Box 2921, RIVONIA, 2128

Phone: (011) 798 0600

E-mail: hlengiwen@sivest.co.za

Fax: (011) 803 7272

Kind Regards

Shivani Naidoo

Environmental Consultant

SiVEST Environmental Division

<< OLE Object: Picture (Device Independent Bitmap) >>

SiVEST is a Level 3 BBBEE Contributor

D +27 11 798 0600 | **T** +27 11 798 0600 **W** www.sivest.co.za

Engineering Consulting | Project Management | Environmental Consulting | Town & Regional Planning | Management Systems Consulting

Durban | Johannesburg | Pretoria | Pietermaritzburg | Richards Bay | Port Louis (Mauritius)

Andrea Gibb

From: Liandra Scott-Shaw
Sent: Wednesday, 09 January 2019 14:41
To: SimphiweM@atns.co.za
Cc: Andrea Gibb; Shivani Naidoo; grahamm@atns.co.za; FrancoisC@atns.co.za; obstacleEvaluator@atns.co.za
Subject: RE: 15260: Rondekop Wind Energy Facility near Sutherland: DSR Comment Period Starting
Attachments: 15260_TurbineLayout_13Sept2018.kml; A3_15260_ProjectOverview_Reduced.jpg; 2019-01-08 Altitude of turbine locations.xlsx
Categories: G7

Dear Mr Masilela

Apologies for the late response- we were waiting for Site/Ground elevation (AMSL).

Please find as per your letter request:

1. LOCATION (KML) – See attached
2. SITE/GROUND ELEVATION (AMSL) – see attached
3. HEIGHT TO TOP OF PROPOSED DEVELOPMENT (in meters) - The maximum height above ground will be up to 230 m.
4. THE NUMBER OF WIND TURBINES- Up to 48 wind turbines each between 3MW and 6.5MW in nameplate capacity are proposed

Kind regards

Liandra Scott-Shaw (*Pr.Sci.Nat*)

Environmental Scientist

SiVEST Environmental Division



SiVEST is a Level 3 BBBEE Contributor

T +27 33 347 1600 | **M** +2773 658 7955 | **E** liandras@sivest.co.za | **W** www.sivest.co.za

Engineering Consulting | Project Management | Environmental Consulting | Town & Regional Planning | Management Systems Consulting
Durban | Johannesburg | Pretoria | Pietermaritzburg | Richards Bay | Port Louis (Mauritius)

From: Liandra Scott-Shaw
Sent: Tuesday, 18 December 2018 9:32 AM
To: 'SimphiweM@atns.co.za'
Cc: Andrea Gibb; Shivani Naidoo; 'grahamm@atns.co.za'; 'FrancoisC@atns.co.za'; 'Veronique Fyfe'
Subject: 15260: Rondekop Wind Energy Facility near Sutherland: DSR Comment Period Starting

Dear Mr Masilela

Thank you for your comments.

Kind regards

Liandra Scott-Shaw (*Pr.Sci.Nat*)
Environmental Scientist
SiVEST Environmental Division



SiVEST is a Level 3 BBBEE Contributor

T +27 33 347 1600 | **M** +2773 658 7955 | **E** liandras@sivest.co.za | **W** www.sivest.co.za

Engineering Consulting | Project Management | Environmental Consulting | Town & Regional Planning | Management Systems Consulting
Durban | Johannesburg | Pretoria | Pietermaritzburg | Richards Bay | Port Louis (Mauritius)

From: Simphiwe Masilela [<mailto:SimphiweM@atns.co.za>]
Sent: 14 December 2018 11:29 AM
To: sivest_PPP <sivest_ppp@sivest.co.za>
Cc: Graham Mondzinger <grahamm@atns.co.za>; Francois Coetzee <FrancoisC@atns.co.za>
Subject: RE: Rondekop Wind Energy Facility near Sutherland: DSR Comment Period Starting



Good day Hlengiwe,

RE: RONDEKOP WIND ENERGY FACILITY

This area is situated 214KM NE of Cape Town International Airport and 208KM W of Langebaanweg Military Airport (They need to make comments as well).

The proposed falls outside the Annex14 surfaces associated with the mentioned airport, however, we need to determine whether it will affect the safety of flights.

We would have to conduct a formal Communication, Navigation and Surveillance (CNS) assessment as per South African Civil Aviation Authority (SACAA) request, the proposed should not be seen by the radar.

The line of sight may be affected upon a Terrain profile assessment, as the radar extends to a 250NM radius.

We request that you please update us should there be any new developments that may affect our interests.

We will duly conduct assessments as required when the project is ready for construction upon a formal request.

Kindly note there is a charge attached to this service.

Furthermore, we kindly request that all queries or new applications to be forwarded to the Obstacle Evaluators on the following obstacleEvaluator@atns.co.za

Please note, for us to carry out a successful assessment we require the following information:

1. LOCATION (Co-ordinates WGS84 system)
2. SITE/GROUND ELEVATION (AMSL)
3. HEIGHT TO TOP OF PROPOSED DEVELOPMENT (in meters)
4. THE NUMBER OF WIND TURBINES

Kind Regards,

Simphiwe Masilela

Obstacle Evaluator | COO - Air Traffic Services
ATNS Head Office, Bruma, Johannesburg, South Africa

T: +2711 607 1228 • F: 011 607 1466 • C:
E: SimphiweM@atns.co.za • W: www.atns.com



[View Disclaimer](#)

From: sivist_PPP [mailto:sivist_ppp@sivest.co.za]

Sent: Wednesday, November 14, 2018 5:40 PM

To: Andrea Gibb <AndreaG@sivest.co.za>; Shivani Naidoo <ShivaniN@sivest.co.za>; 'Veronique Fyfe' <veronique@g7energies.co.za>

Cc: 'Henning Myburg' <henning@agrink.co.za>; Obstacle Evaluators <ObstacleEvaluators@atns.co.za>; Johanna Morobane <JohannaM@atns.co.za>; Phillip De Lange <phillipd@atns.co.za>; Ferdi Smit <ferdis@atns.co.za>; 'Candice Stevens' <advocacy@atns.co.za>

'Samantha Ralston-Paton' <energy@birdlife.org.za>; 'Jacoline Mans' <jacolinema@daff.gov.za>; 'Paul Avenant' <paula@daff.gov.za>

'de Jager' <loydejager@hotmail.com>; 'Mmatlala Rabothata' <mrabothata@environment.gov.za>; 'Seoka Lekota' <slekota@environment.gov.za>

'Ntsundeni Ravhogoni' <Ntsundeni.Ravhogoni@dmr.gov.za>; 'Patrick Lenyibi' <plenyibi@ncpg.gov.za>; 'Ester Makungo' <makungoe@dws.gov.za>; 'Moses Mahunonyane' <MahunonyaneM@dws.gov.za>; 'Brian Fisher' <bfisher@ncpg.gov.za>; 'Andre' <andre.crous@eskom.co.za>; 'John Geeringh' <GeerinJH@eskom.co.za>; 'Lourens Leeuwner' <lourensl@ewt.org.za>; 'Allistar Gibb' <a.gibbons@karoohoogland.gov.za>; 'Jannie Loubser' <janniel@namakwa-dm.gov.za>; 'Gert Steenkamp' <gsteenkamp@ncpg.gov.za>; 'Roelofse' <roelofse.j@vodamail.co.za>; 'Thulani Mthombeni' <tmtho@webmail.co.za>; 'Lizell Stroh' <strohl@caa.co.za>; 'Nicole' <AbrahamsN@nra.co.za>; 'Mlungisi Ngwenya' <Mlungisi.Ngwenya@weathersa.co.za>; 'Frank Creese' <creesef@sentech.co.za>; 'Dan' <pretoriusa@sentech.co.za>; 'Johan Koegelenberg' <KoegelenbergJ@sentech.co.za>; 'Ramatholo Sefako' <rrs@saa.ac.za>; 'Dan' <radiotech@saps.org.za>; 'Adriaan Tiplady' <atiplady@ska.ac.za>; 'Keverne Thurling' <Thurling@telkom.co.za>; 'Heleen van den' <vdheevhd@telkom.co.za>; 'Amanda Bester' <WayleaCR@telkom.co.za>; 'Morgan Griffiths' <morgan.griffiths@wessa.co.za>

Subject: Rondekop Wind Energy Facility near Sutherland: DSR Comment Period Starting

Dear Stakeholder

ENVIRONMENTAL IMPACT ASSESSMENT PROCESS (EIA) FOR THE PROPOSED 325MW RONDEKOP WIND ENERGY FACILITY BETWEEN MATJIESFONTEIN AND SUTHERLAND IN THE NORTHERN CAPE PROVINCE

SiVEST is in the process of undertaking the Environmental Impact Assessment (EIA) for the proposed development of the Rondekop Facility near Sutherland in the Northern Cape.

We would like to take this opportunity to inform you that, in accordance with the National Environmental Management Act, 1998 (Act 107 of 1998) (NEMA) (as amended), the Draft Scoping Report (DSR) for the above mentioned wind project will be available for public comment from **Wednesday the 14th of November 2018 to the Friday 14th of December 2018** (before end of business day).

The DSRs as well as the accompanying appendices are available online (<http://data.g7energies.com/eia/rondekop>) and an electronic copy has been posted to you. We kindly request that you submit your comments to the Public Participation Office at the below details, on or before the 14th of December 2018 (before end of business day). SiVEST will forward any comments received after the public comment period directly to the relevant case officer at the Department of Environmental Affairs (DEA).

Should you have any questions or queries please do not hesitate to contact us at:

Hlengiwe Ntuli

PO Box 2921, RIVONIA, 2128

Phone: (011) 798 0600

E-mail: hlengiwen@sivest.co.za

Fax: (011) 803 7272

Kind Regards

Shivani Naidoo

Environmental Consultant

SiVEST Environmental Division



SiVEST is a Level 3 BBBEE Contributor

D +27 11 798 0600 | **T** +27 11 798 0600 **W** www.sivest.co.za

Engineering Consulting | Project Management | Environmental Consulting | Town & Regional Planning | Management Systems Consulting
Durban | Johannesburg | Pretoria | Pietermaritzburg | Richards Bay | Port Louis (Mauritius)

Disclaimer

The information contained in this communication from the sender is confidential. It is intended solely for use by the recipient and others authorized to receive it. If you are not the recipient, you are hereby notified that any disclosure, copying, distribution or taking action in relation of the contents of this message is strictly prohibited and may be unlawful.

This email has been scanned for viruses and malware, and automatically archived by **Mimecast SA (Pty) Ltd**, an innovator in Software as a Service (SaaS) business. **Mimecast Unified Email Management (UEM)** offers email continuity, security, archiving and compliance with all current legislation. For more information, [contact Mimecast](#).

The contents of this email are confidential and intended for the named recipient(s) only. The information may be privileged or otherwise protected from disclosure. The views expressed in this message are those of the sender, unless otherwise stated to be. This email is also subject to copyright. No part hereof may be reproduced, adapted, transmitted, or used in any way without the written consent of ATNS SOC Limited. Please do not hesitate to contact us immediately should you have any doubts regarding the authenticity of an email purportedly sent by the sender.

The provisions of Sections 11,12, and 13 of the Electronic Communications and Transactions Act, 25 of 2002, in so far as e-contracting is concerned are expressly excluded and contracted out of by Air Traffic

Navigation Services (ATNS) and, unless clearly stated to the contrary in the body of the data message or electronic communication no data message or electronic communication will be recognised as having legal contractual status as per the aforementioned provisions under any circumstances. All contracts concluded by ATNS and its Business Units will only be legally binding and recognised once reduced to physical writing and physically signed by a duly authorised representative of ATNS. All other provisions of the Electronic Communications and Transactions Act, 25 of 2002 are accepted.

Although ATNS has taken all reasonable precautions to ensure that this e-mail is virus free, ATNS does not accept any liability for any damage caused by any virus transmitted by this email.

Stephan Jacobs

From: sivest_PPP
Sent: Monday, 14 January 2019 4:17 PM
Cc: Andrea Gibb; Liandra Scott-Shaw; Stephan Jacobs; 'Veronique Fyfe'
Subject: Rondekop Wind Energy Facility near Sutherland: Comments and Responses Report and Way Forward

Follow Up Flag: Follow up
Flag Status: Flagged

Dear Interested and/or Affected Party (I&AP)

ENVIRONMENTAL IMPACT ASSESSMENT (EIA) PROCESS FOR THE PROPOSED 325MW RONDEKOP WIND ENERGY FACILITY (WEF) BETWEEN MATJIESFONTEIN AND SUTHERLAND IN THE NORTHERN CAPE PROVINCE (DEA Ref No: 14/12/16/3/3/2/1115)

This email is intended to provide you with information on two aspects of the above project, viz. provide you with a copy of the Comments and Response Report and an update regarding the EIA process.

COMMENTS AND RESPONSE REPORT

The public comment and review period of the Draft Scoping Report ended on 14 December 2018. All comments received during the Draft Scoping Report review period were taken into account in the Final Scoping Report, which has been subsequently submitted to Department of Environmental Affairs (DEA) on 14 January 2019.

The Comments and Response Report is attached with all comments and responses that were submitted during the Draft Scoping Report comment period.



15260 Rondekop
WEF CRR FSR.pd...

EIA PROCESS UPDATE

The Environmental Impact Assessment (EIA) Phase will commence after the acceptance of the Scoping Report by the DEA. The public will be notified of this milestone and will also be afforded sufficient opportunity to review and/or comment on the Draft EIA Report. Meeting/s will be convened to discuss the outcomes of the various specialist studies (details will be provided closer to the time).

For additional information, please contact Liandra Scott-Shaw at:
Email: sivest_ppp@sivest.co.za.

In closing, the Project Team would like to express its appreciation to stakeholders for their active participation and contributions during the Scoping Phase.

Kind regards

Liandra Scott-Shaw (*Pr.Sci.Nat*)
Environmental Scientist
SiVEST Environmental Division



SiVEST is a Level 3 BBBEE Contributor

T +27 11 798 0600 | **E** liandras@sivest.co.za | **W** www.sivest.co.za

Engineering Consulting | Project Management | Environmental Consulting | Town & Regional Planning | Management Systems Consulting

Durban | Johannesburg | Pretoria | Pietermaritzburg | Richards Bay | Port Louis (Mauritius)

Liandra Scott-Shaw

From: Liandra Scott-Shaw
Sent: Tuesday, 15 January 2019 9:24 AM
To: 'Adri La Meyer'
Cc: Andrea Gibb; Stephan Jacobs; 'Veronique Fyfe'; Hlengiwe Ntuli
Subject: RE: 15260: Rondekop Wind Energy Facility near Sutherland: FSR Submitted to DEA

Tracking:	Recipient	Delivery	Read
	'Adri La Meyer'		
	Andrea Gibb	Delivered: 2019/01/15 9:24 AM	
	Stephan Jacobs	Delivered: 2019/01/15 9:24 AM	
	'Veronique Fyfe'		
	Hlengiwe Ntuli	Delivered: 2019/01/15 9:24 AM	Read: 2019/01/15 9:29 AM

Dear Adri

Thank you and noted.

Kind regards

Liandra Scott-Shaw (*Pr.Sci.Nat*)
Environmental Scientist
SiVEST Environmental Division



SiVEST is a Level 3 BBBEE Contributor

T +27 33 347 1600 | **M** +2773 658 7955 | **E** liandras@sivest.co.za | **W** www.sivest.co.za

Engineering Consulting | Project Management | Environmental Consulting | Town & Regional Planning | Management Systems Consulting

Durban | Johannesburg | Pretoria | Pietermaritzburg | Richards Bay | Port Louis (Mauritius)

From: Adri La Meyer [mailto:Adri.LaMeyer@westerncape.gov.za]
Sent: Tuesday, 15 January 2019 9:23 AM
To: Liandra Scott-Shaw
Cc: Andrea Gibb; Stephan Jacobs; 'Veronique Fyfe'; Hlengiwe Ntuli
Subject: RE: 15260: Rondekop Wind Energy Facility near Sutherland: FSR Submitted to DEA

Dear Liandra,

Thank you for the quick response. Since the application does not fall within the Western Cape, the Department does not require further communication regarding the status of the application as we cannot comment on the application.

Kind regards,
Adri

From: Liandra Scott-Shaw <LiandraS@sivest.co.za>
Sent: 15 January 2019 09:04 AM
To: Adri La Meyer <Adri.LaMeyer@westerncape.gov.za>
Cc: Andrea Gibb <AndreaG@sivest.co.za>; Stephan Jacobs <StephanJ@sivest.co.za>; 'Veronique Fyfe' <veronique@g7energies.com>; Hlengiwe Ntuli <HlengiweN@sivest.co.za>
Subject: 15260: Rondekop Wind Energy Facility near Sutherland: FSR Submitted to DEA

Dear Adri

The application does not fall within the Western Cape Boundary (Please see attached KML).

Please don't hesitate to contact me if you require further information.

Kind regards

Liandra Scott-Shaw (*Pr.Sci.Nat*)
Environmental Scientist
SiVEST Environmental Division



SiVEST is a Level 3 BBBEE Contributor

T +27 33 347 1600 | **M** +2773 658 7955 | **E** liandras@sivest.co.za | **W** www.sivest.co.za

Engineering Consulting | Project Management | Environmental Consulting | Town & Regional Planning | Management Systems Consulting

Durban | Johannesburg | Pretoria | Pietermaritzburg | Richards Bay | Port Louis (Mauritius)

From: Adri La Meyer [<mailto:Adri.LaMeyer@westerncape.gov.za>]
Sent: Tuesday, 15 January 2019 7:18 AM
To: sivest_PPP
Cc: Andrea Gibb; Liandra Scott-Shaw; Stephan Jacobs; 'Veronique Fyfe'
Subject: RE: Rondekop Wind Energy Facility near Sutherland: FSR Submitted to DEA

Dear Andrea,

Your e-mail of 14 January 2019 refers. Could you please indicate whether the application falls within the Western Cape boundaries and if so, if the Department commented on the DSR? I am not aware of the application, but it could be that our EIA section received the request for comment, but failed to notify me.

Thank you and regards,
Adri

Adri La Meyer
Directorate: Development Facilitation
Department of Environmental Affairs and Development Planning
Western Cape Government

11th Floor, Utilitas Building, 1 Dorp Street, Cape Town, 8001
Private Bag X9086, Cape Town, 8000

Tel: 021 483 2887
Fax: 021 483 4185
E-mail: Adri.Lameyer@westerncape.gov.za
Website: www.westerncape.gov.za/eadp



Be 110% Green. Read from the screen.

From: sivest_PPP <sivest_ppp@sivest.co.za>
Sent: 14 January 2019 03:00 PM
Cc: Andrea Gibb <AndreaG@sivest.co.za>; Liandra Scott-Shaw <LiandraS@sivest.co.za>; Stephan Jacobs <StephanJ@sivest.co.za>; 'Veronique Fyfe' <veronique@g7energies.com>
Subject: Rondekop Wind Energy Facility near Sutherland: FSR Submitted to DEA

Dear Interested and/or Affected Party (I&AP),

ENVIRONMENTAL IMPACT ASSESSMENT (EIA) PROCESS FOR THE PROPOSED 325MW RONDEKOP WIND ENERGY FACILITY (WEF) BETWEEN MATJIESFONTEIN AND SUTHERLAND IN THE NORTHERN CAPE PROVINCE (DEA Ref No: 14/12/16/3/3/2/1115)

- **SUBMISSION OF FINAL SCOPING REPORT (FSR) TO THE DEPARTMENT OF ENVIRONMENTAL AFFAIRS (DEA)**

Following the public comment and review period of the Draft Scoping Report (DSR) for the above-mentioned proposed project from Wednesday the 14th of November 2018 to Friday the 14th of December 2018 (end of business day), the Draft Scoping Report (DSR) was updated, taking into consideration the issues and concerns raised by Interested and/or Affected Parties (I&APs), Organs of State / Authorities, Landowners and Stakeholders, and the Final Scoping Report (FSR) was submitted to the Department of Environmental Affairs (DEA) on Monday the 14th of January 2019.

We would like to thank you in anticipation of your active and meaningful contribution to the EIA and Public Participation processes.

Kind Regards,

Geagte Belangstellende en/of Geaffekteerde Party / Belanghebbende,

OMGEWINGSIMPAKEVALUERINGSPROSES (OIE) VIR DIE BEOOGDE 325MW RONDEKOP WINDKRAGAAANLEG TUSSEN MATJIESFONTEIN EN SUTHERLAND IN DIE NOORD-KAAPPROVINSIE (DOS Verw. No.: 14/12/16/3/3/2/1115)

- **INDIENING VAN DIE FINALE BESTEKOPNAMEVERSLAE (FBV) BY DIE DEPARTEMENT VAN OMGEWINGSAKE (DOS)**

Na aanleiding van die kommentaar deur die openbare oorsigtydperk van die Konsep Bestekopnameverslag (KBV) vir die bogenoemde projek van Woensdag 14 November 2018 tot Vrydag 14 Desember 2018 (teen sluitingstyd), was die KBV bygewerk en gefinaliseer, met inagneming van die kwessies en kommentaar wat deur belanghebbendes opgewek was, en die FBV was op Maandag 14 Januarie 2019 aan die Departement van Omgewingsake (DOS) ingedien vir oorweging.

Ons dank u byvoorbaat vir u aktiewe en betekenisvolle bydrae tot die OIE en die Openbare Deelnameproses.

Vriendelike groete,

Andrea Gibb
Senior Manager
SiVEST Environmental Division



SiVEST is a Level 3 BBBEE Contributor

D +27 11 798 0638 | **T** +27 11 798 0600 | **E** andrea@sivest.co.za | **W** www.sivest.co.za
Engineering Consulting | Project Management | Environmental Consulting | Town & Regional Planning | Management Systems Consulting
Durban | Johannesburg | Pretoria | Pietermaritzburg | Richards Bay | Port Louis (Mauritius)

Disclaimer

The information contained in this communication from the sender is confidential. It is intended solely for use by the recipient and others authorized to receive it. If you are not the recipient, you are hereby notified that any disclosure, copying, distribution or taking action in relation of the contents of this information is strictly prohibited and may be unlawful.

This email has been scanned for viruses and malware, and automatically archived by **Mimecast SA (Pty) Ltd**, an innovator in Software as a Service (SaaS) for business. **Mimecast Unified Email Management ??? (UEM)** offers email continuity, security, archiving and compliance with all current legislation. To find out more, [contact Mimecast](#).

"All views or opinions expressed in this electronic message and its attachments are the view of the sender and do not necessarily reflect the views and opinions of the Western Cape Government (the WCG). No employee of the WCG is entitled to conclude a binding contract on behalf of the WCG unless he/she is an accounting officer of the WCG, or his or her authorised representative. The information contained in this message and its attachments may be confidential or privileged and is for the use of the named recipient only, except where the sender specifically states otherwise.
If you are not the intended recipient you may not copy or deliver this message to anyone."

Disclaimer

The information contained in this communication from the sender is confidential. It is intended solely for use by the recipient and others authorized to receive it. If you are not the recipient, you are hereby notified that any disclosure, copying, distribution or taking action in relation of the contents of this information is strictly prohibited and may be unlawful.

This email has been scanned for viruses and malware, and automatically archived by **Mimecast SA (Pty) Ltd**, an innovator in Software as a Service (SaaS) for business. **Mimecast Unified Email Management ??? (UEM)** offers email continuity, security, archiving and compliance with all current legislation. To find out more, [contact Mimecast](#).

"All views or opinions expressed in this electronic message and its attachments are the view of the sender and do not necessarily reflect the views and opinions of the Western Cape Government (the WCG). No employee of the WCG is entitled to conclude a binding contract on behalf of the WCG unless he/she is an accounting officer of the WCG, or his or her authorised representative. The information contained in this message and its attachments may be confidential or privileged and is for the use of the named recipient only, except where the sender specifically states otherwise.
If you are not the intended recipient you may not copy or deliver this message to anyone."