



Scoping and Environmental Impact Assessment for the proposed Development of a 75 MW Solar Photovoltaic Facility (GEMSBOK SOLAR PV5) on Portion 8 of Gemsbok Bult Farm 120, north-east of Kenhardt, Northern Cape Province

EIA REPORT

APPENDIX G:

Copies of Correspondence from DEA and I&APs

CONTENTS

ACKNOWLEDGEMENT OF RECEIPT FROM DEA FOLLOWING THE RELEASE OF THE SCOPING REPORT	2
LETTER OF ACCEPTANCE OF SCOPING REPORT BY DEA	3
COMMENTS ON DRAFT SCOPINGREPORT FROM NATIONAL DEPARTMENT OF ENVIRONMENTAL AFFAIRS	14
COMMENTS RECEIVED FROM INTERESTED AND AFFECTED PARTIES AFTER THE RELEASE OF SCOPING REPORT FOR COMMENT	17
COMMENTS RECEIVED FROM INTERESTED AND AFFECTED PARTIES PRIOR TO THE RELEASE OFTHE SCOPING REPORT FOR COMMENT	47

ACKNOWLEDGEMENT OF RECEIPT FROM DEA FOLLOWING THE RELEASE OF THE SCOPING REPORT



environmental affairs

Department:
Environmental Affairs
REPUBLIC OF SOUTH AFRICA

Private Bag X 447, PRETORIA - 0001, Environmental House, 473 Steve Biko Road, PRETORIA

DEA Reference: 14/12/16/3/3/2/841
: 14/12/16/3/3/2/842
: 14/12/16/3/3/2/843
: 14/12/16/3/3/2/844

Enquiries: Muhammad Essop

Tel: 012 399 9406 E-mail: MEssop@environment.gov.za

Paul Lochner
Council for Scientific and Industrial Research (CSIR)
P O BOX 320
STELLENBOSCH
7599

Tel: (021) 888 2486 / 021 888 2661
Email: plochner@csir.co.za

PER EMAIL / MAIL

Dear Paul Lochner

ACKNOWLEDGEMENT OF RECEIPT OF THE FINAL SCOPING REPORTS FOR THE PROPOSED DEVELOPMENT OF A 75 MW SOLAR PHOTOVOLTAIC FACILITY (GEMSBOK SOLAR PV3, GEMSBOK SOLAR PV4, GEMSBOK SOLAR PV 5 & GEMSBOK SOLAR PV6) ON THE PORTION 8 OF GEMSBOK BULT FARM 120, 30 KM NORTH-EAST OF KENHARDT, NORTHERN CAPE PROVINCE

The Department confirms having received the Final Scoping Reports dated 07 December 2015 for the above-mentioned project on 08 December 2015.

You are hereby reminded that the activity may not commence prior to an environmental authorisation being granted by the Department.

Yours sincerely

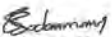
Mr Sabelo Malaza
Chief Director: Integrated Environmental Authorisations
Department of Environmental Affairs
Letter signed by: Ms Senisha Soobramany
Designation: Control Environmental Officer (Grade A): Coordination and Strategic Planning and Support
Date: 12 January 2016

LETTER OF ACCEPTANCE OF SCOPING REPORT BY DEA



environmental affairs

Department:
Environmental Affairs
REPUBLIC OF SOUTH AFRICA

Private Bag X 447 · PRETORIA · 0001 · Environment House · 473 Steve Biko Road · Arcadia · PRETORIA
Tel (+ 27 12) 399 9372

DEA Reference: 14/12/16/3/3/2/843

Enquiries: Ms. Thabile Sangweni

Telephone: (012) 399 9409 **E-mail:** TSangweni@environment.gov.za

Mr Paul Lochner
Council for Scientific and Industrial Research (CSIR)
PO Box 320
STELLENBOSCH
7599

Telephone Number: (021) 888 2486
Email Address: plochner@csir.co.za

PER EMAIL / MAIL

Dear Mr Lochner

ACCEPTANCE OF THE SCOPING REPORT FOR THE PROPOSED 75 MW SOLAR PHOTOVOLTAIC FACILITY (GEMSBOK SOLAR PV5) ON PORTION 8 OF THE GEMSBOK BULT FARM 120 NEAR KENHARDT WITHIN THE KHEIS LOCAL MUNICIPALITY IN THE NORTHERN CAPE PROVINCE

The Scoping Report (SR) and Plan of Study for Environmental Impact Assessment (PoSEIA) dated December 2015 and received by this Department on 08 December 2015 refer.

This Department has evaluated the submitted SR and the PoSEIA dated December 2015 and is satisfied that the documents comply with the minimum requirements of the Environmental Impact Assessment (EIA) Regulations, 2014. The SR is hereby accepted by the Department in terms of Regulation 22(a) of the EIA Regulations, 2014.

You may proceed with the EIA process in accordance with the tasks contemplated in the PoSEIA and the requirements of the EIA Regulations, 2014.

All comments and recommendations made by all stakeholders and Interested and Affected Parties (I&APs) in the draft SR and submitted as part of the final SR must be taken into consideration when preparing an Environmental Impact Assessment report (EIAr) in respect of the proposed development. Please ensure that all mitigation measures and recommendations in the specialist studies are addressed and included in the final EIAr and Environmental Management Programme (EMPr).

Please ensure that comments from all relevant stakeholders are submitted to the Department with the final EIAr. This includes but is not limited to the Northern Cape Department of Environmental and Nature Conservation, the Department of Agriculture, Forestry and Fisheries (DAFF), the provincial Department of Agriculture, the South African Civil Aviation Authority (SACAA), the Department of Transport, the Local Municipality, the District Municipality, the Department of Water and Sanitation (DWS), the South African National Roads Agency Limited (SANRAL), the South African Heritage Resources Agency (SAHRA), the Endangered Wildlife Trust (EWT), BirdLife SA, the Department of Mineral Resources, the Department of Rural Development and Land Reform, the Department of Environmental Affairs: Directorate Biodiversity and Conservation and the Square Kilometre Array (SKA).

Please be advised that the contact person for renewable projects at the SKA office is Dr Adrian Tiplady and he can be contacted on Tel: (011) 442 2434 or E-mail: atiplady@ska.ac.za.

You are also required to address all issues raised by Organs of State and I&APs prior to the submission of the EIAr to the Department.

Proof of correspondence with the various stakeholders must be included in the EIAr. Should you be unable to obtain comments, proof should be submitted to the Department of the attempts that were made to obtain comments.

The EAP must, in order to give effect to Regulation 8, give registered I&APs access to, and an opportunity to comment on the report in writing within 30 days before submitting the final EIAr to the Department.

In addition, the following additional information is required for the EIAr:

- i. Following a review of the application form and SR received in October 2015 and December 2015 respectively, this Department advises that the application form must be amended and resubmitted to include the correct listed activities. As such the Department advises that the following listed activities and their relevant issues be addressed:

GN R. 983 Item 12:

"The development of –

(x) buildings exceeding 100 square metres in size;

(xii) infrastructure or structures with a physical footprint of 100 square metres or more;

Where such development occurs-

(a) within a watercourse

(b) in front of a development setback; or

(c) in no development setback exists, within 32m of a watercourse, measured from the edge of a watercourses."

- The Environmental Assessment Practitioner must apply for the specific aspect of the activity, i.e. either part (a) or part (b) etc. as all of these parts of the activity cannot be authorised.

GN R. 983 Item 19:

"The infilling or depositing of any material of more than 5 cubic metres into, or the dredging, excavation, removal or moving of soil, sand, shells, shell grit, pebbles or rock of more than 5 cubic metres from-

(i) a watercourse;

(ii) the seashore; or

(iii) the littoral active zone, an estuary or a distance of 100 metres inland of the high-water of the sea or an estuary whichever distance is the greater."

- The Environmental Assessment Practitioner must apply for the specific aspect of the activity, i.e. either part (i) or part (ii) etc. as all of these parts of the activity cannot be authorised.

GN R. 983 Item 24:

"The development of-

(ii) a road with a reserve wider than 13,5 meters, or where no reserve exists where the road is wider than 8 metres."

- The Environmental Assessment Practitioner must apply for the specific aspect of the activity, i.e. either a road with a reserve wider than 13, 5 meters, or where no reserve exists as all of these parts of the activity cannot be authorised.
- ii. The EIA must include the following:
 - GN R.983 Item 19: With regards to infilling and excavation of watercourses for the construction of the PV Solar Energy facility, this Department requires the applicant to provide an indication of the preferred and alternate locations from which the material used for infilling will be sourced and where excavated material will be stored and/or disposed of. In addition, the impacts associated with this activity must be adequately assessed in the EIA.
- iii. The EIA must provide an assessment of the impacts and mitigation measures for each of the listed activities applied for.
- iv. The listed activities represented in the EIA and the application form must be the same and correct.
- v. It is imperative that the relevant authorities are continuously involved throughout the EIA process as the development property possibly falls within geographically designated areas in terms of all activities under GN R.985. Written comments must be obtained and submitted to this Department. In addition, a graphical representation of the proposed development within the respective geographical areas must be provided.
- vi. Based on the high risk of detrimental impact that the proposed facility poses on the SKA, further Electromagnetic Interference (EMI) and Radio Frequency Interference (RFI) detailed studies must be conducted as significant mitigation measures would be required to lower the risk of detrimental impact to an acceptable level. The South African SKA Project Office must be kept regularly informed of progress and be consulted on the details of the studies required.
- vii. The EMI and RFI study must also assess cumulative impacts from the other Renewable Energy Facilities in the Area.
- viii. Comments on the EMI and RFI study must be obtained from South African SKA Project Office.
- ix. The EIA must provide the technical details of the proposed facility in a table format as well as their description and/or dimensions. A sample for the minimum information required is listed under point 2 of the EIA information required for solar energy facilities below.
- x. The EIA must provide the four corner coordinate points for the proposed development site (note that if the site has numerous bend points, at each bend point coordinates must be provided) as well as the start, middle and end point of all linear activities.
- xi. The EIA must provide the following:
 - Clear indication of the envisioned area for the proposed solar energy facility; i.e. placing of photovoltaic panels and all associated infrastructure should be mapped at an appropriate scale.
 - Clear description of all associated infrastructure. This description must include, but is not limited to the following:
 - Power lines;
 - Internal roads infrastructure; and;
 - All supporting onsite infrastructure such as laydown area, guard house and control room etc.
 - All necessary details regarding all possible locations and sizes of the proposed satellite substation and the main substation.
- xii. The EIA must also include a comments and response report in accordance with Appendix 2 h (iii) of the EIA Regulations, 2014.
- xiii. The EIA must include the detail inclusive of the PPP in accordance with Regulation 41 of the EIA Regulations.
- xiv. Details of the future plans for the site and infrastructure after decommissioning in 20-30 years and the possibility of upgrading the proposed infrastructure to more advanced technologies.

- xv. Information on services required on the site, e.g. sewage, refuse removal, water and electricity. Who will supply these services and has an agreement and confirmation of capacity been obtained? Proof of these agreements must be provided.
- xvi. The EIAR must provide a detailed description of the need and desirability, not only providing motivation on the need for clean energy in South Africa of the proposed activity. The need and desirability must also indicate if the proposed development is needed in the region and if the current proposed location is desirable for the proposed activity compared to other sites.
- xvii. A copy of the final site layout map and alternatives. All available biodiversity information must be used in the finalisation of the layout map. Existing infrastructure must be used as far as possible e.g. roads. The layout map must indicate the following:
- PV positions and its associated infrastructure;
 - Permanent laydown area footprint;
 - Internal roads indicating width (construction period width and operation period width) and with numbered sections between the other site elements which they serve (to make commenting on sections possible);
 - Wetlands, drainage lines, rivers, stream and water crossing of roads and cables indicating the type of bridging structures that will be used;
 - The location of sensitive environmental features on site e.g. CBAs, heritage sites, wetlands, drainage lines etc. that will be affected by the facility and its associated infrastructure;
 - Substation(s) and/or transformer(s) sites including their entire footprint;
 - Connection routes (including pylon positions) to the distribution/transmission network;
 - All existing infrastructure on the site, especially roads;
 - Buffer areas;
 - Buildings, including accommodation; and
 - All "no-go" areas.
- xviii. An environmental sensitivity map indicating environmental sensitive areas and features identified during the EIA process.
- xix. A map combining the final layout map superimposed (overlain) on the environmental sensitivity map.
- xx. A shapefile of the preferred development layout/footprint must be submitted to this Department. The shapefile must be created using the Hartebeesthoek 94 Datum and the data should be in Decimal Degree Format using the WGS 84 Spheroid. The shapefile must include at a minimum the following extensions i.e. .shp; .shx; .dbf; .prj; and, .xml (Metadata file). If specific symbology was assigned to the file, then the .avl and/or the .lyr file must also be included. Data must be mapped at a scale of 1:10 000 (please specify if an alternative scale was used). The metadata must include a description of the base data used for digitizing. The shapefile must be submitted in a zip file using the EIA application reference number as the title. The shape file must be submitted to:

Postal Address:

Department of Environmental Affairs
Private Bag X447
Pretoria
0001

Physical address:

Environment House
473 Steve Biko Road
Pretoria

For Attention: Muhammad Essop
Integrated Environmental Authorisations
Strategic Infrastructure Developments
Telephone Number: (012) 399 9406
Email Address: MEssop@environment.gov.za

The EMPr to be submitted as part of the EIAr must include the following:

- i. All recommendations and mitigation measures recorded in the EIAr and the specialist studies conducted.
- ii. The final site layout map.
- iii. Measures as dictated by the final site layout map and micro-siting.
- iv. An environmental sensitivity map indicating environmental sensitive areas and features identified during the EIA process.
- v. A map combining the final layout map superimposed (overlain) on the environmental sensitivity map.
- vi. An alien invasive management plan to be implemented during construction and operation of the facility. The plan must include mitigation measures to reduce the invasion of alien species and ensure that the continuous monitoring and removal of alien species is undertaken.
- vii. A plant rescue and protection plan which allows for the maximum transplant of conservation important species from areas to be transformed. This plan must be compiled by a vegetation specialist familiar with the site and be implemented prior to commencement of the construction phase.
- viii. A re-vegetation and habitat rehabilitation plan to be implemented during the construction and operation of the facility. Restoration must be undertaken as soon as possible after completion of construction activities to reduce the amount of habitat converted at any one time and to speed up the recovery to natural habitats.
- ix. An open space management plan to be implemented during the construction and operation of the facility.
- x. A traffic management plan for the site access roads to ensure that no hazards would result from the increased truck traffic and that traffic flow would not be adversely impacted. This plan must include measures to minimize impacts on local commuters e.g. limiting construction vehicles travelling on public roadways during the morning and late afternoon commute time and avoid using roads through densely populated built-up areas so as not to disturb existing retail and commercial operations.
- xi. A transportation plan for the transport of components, main assembly cranes and other large pieces of equipment.
- xii. A storm water management plan to be implemented during the construction and operation of the facility. The plan must ensure compliance with applicable regulations and prevent off-site migration of contaminated storm water or increased soil erosion. The plan must include the construction of appropriate design measures that allow surface and subsurface movement of water along drainage lines so as not to impede natural surface and subsurface flows. Drainage measures must promote the dissipation of storm water run-off.
- xiii. A fire management plan to be implemented during the construction and operation of the facility.
- xiv. An erosion management plan for monitoring and rehabilitating erosion events associated with the facility. Appropriate erosion mitigation must form part of this plan to prevent and reduce the risk of any potential erosion.
- xv. An effective monitoring system to detect any leakage or spillage of all hazardous substances during their transportation, handling, use and storage. This must include precautionary measures to limit the possibility of oil and other toxic liquids from entering the soil or storm water systems.
- xvi. Measures to protect hydrological features such as streams, rivers, pans, wetlands, dams and their catchments, and other environmental sensitive areas from construction impacts including the direct or indirect spillage of pollutants.

The EAP must provide detailed motivation if any of the above requirements is not required by the proposed development and not included in the EMPr.

The EIAr must include a **cumulative impact assessment** of the facility since there are other similar facilities in the region. The specialist studies e.g. biodiversity, visual, noise, avifauna etc. must also assess the facility in terms of potential cumulative impacts. The specialist studies as outlined in the PoSEIA which is incorporated as part of the SR must also assess the facility in terms of potential cumulative impacts.

Please ensure that all the relevant Listing Notice activities are applied for, that the Listing Notice activities applied for are specific and that they can be linked to the development activity or infrastructure in the project description.

You are hereby reminded that should the EIAr fail to comply with the requirements of this acceptance letter, a negative environmental authorisation will be issued.

The applicant is hereby reminded to comply with the requirements of Regulation 45 with regard to the time period allowed for complying with the requirements of the Regulations, and Regulations 43 and 44 with regard to the allowance of a comment period for interested and affected parties on all reports submitted to the competent authority for decision-making. The reports referred to are listed in Regulation 43(1).

Furthermore, it must be reiterated that, should an application for Environmental Authorisation be subject to the provisions of Chapter II, Section 38 of the National Heritage Resources Act, Act 25 of 1999, then this Department will not be able to make nor issue a decision in terms of your application for Environmental Authorisation pending a letter from the pertinent heritage authority categorically stating that the application fulfils the requirements of the relevant heritage resources authority as described in Chapter II, Section 38(8) of the National Heritage Resources Act, Act 25 of 1999. Comments from SAHRA and/or the provincial department of heritage must be provided in the EIAr.

You are requested to submit two (2) electronic copies (CD/DVD) and two (2) hard copies of the EIAr to the Department as per Regulation 23(1) of the EIA Regulations, 2014.

Please also find attached information that must be used in the preparation of the EIAr. This will enable the Department to speedily review the EIAr and make a decision on the application.

You are hereby reminded of Section 24F of the National Environmental Management Act, Act No 107 of 1998, as amended, which stipulates that no activity may commence prior to an Environmental Authorisation being granted by the Department.

Yours faithfully

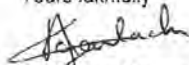

Mr Sabelo Malaza

**Chief Director: Integrated Environmental Authorisations
Department of Environmental Affairs**

Letter Signed by: Mr Coenrad Agenbach

Designation: Deputy Director: Strategic Infrastructure Developments

Date: 28/01/2016

cc:	Warren Morse	Gemsbok Solar PV5 (Pty) Ltd	Email: warren@mulilo.com
	Ms T Scheepers	Kheis Local Municipality	Email: teresascheepers@vodamail.co.za

A. EIA INFORMATION REQUIRED FOR SOLAR ENERGY FACILITIES

1. General site information

The following general site information is required:

- Descriptions of all affected farm portions
- 21 digit Surveyor General codes of all affected farm portions
- Copies of deeds of all affected farm portions
- Photos of areas that give a visual perspective of all parts of the site
- Photographs from sensitive visual receptors (tourism routes, tourism facilities, etc.)
- Solar plant design specifications including:
 - Type of technology
 - Structure height
 - Surface area to be covered (including associated infrastructure such as roads)
 - Structure orientation
 - Laydown area dimensions (construction period and thereafter)
 - Generation capacity
- Generation capacity of the facility as a whole at delivery points

This information must be indicated on the first page of the EIAr. It is also advised that it be double checked as there are too many mistakes in the applications that have been received that take too much time from authorities to correct.

2. Sample of technical details for the proposed facility

Component	Description / dimensions
Height of PV panels	
Area of PV Array	
Number of inverters required	
Area occupied by inverter / transformer stations / substations	
Capacity of on-site substation	
Area occupied by both permanent and construction laydown areas	
Area occupied by buildings	
Length of internal roads	
Width of internal roads	
Proximity to grid connection	
Height of fencing	
Type of fencing	

3. Site maps and GIS information

Site maps and GIS information should include at least the following:

- All maps/information layers must also be provided in ESRI Shapefile format
- All affected farm portions must be indicated
- The exact site of the application must be indicated (the areas that will be occupied by the application)

- A status quo map/layer must be provided that includes the following:
 - Current use of land on the site including:
 - Buildings and other structures
 - Agricultural fields
 - Grazing areas
 - Natural vegetation areas (natural veld not cultivated for the preceding 10 years) with an indication of the vegetation quality as well as fine scale mapping in respect of Critical Biodiversity Areas and Ecological Support Areas
 - Critically endangered and endangered vegetation areas that occur on the site
 - Bare areas which may be susceptible to soil erosion
 - Cultural historical sites and elements
 - Rivers, streams and water courses
 - Ridgelines and 20m continuous contours with height references in the GIS database
 - Fountains, boreholes, dams (in-stream as well as off-stream) and reservoirs
 - High potential agricultural areas as defined by the Department of Agriculture, Forestry and Fisheries
 - Buffer zones (also where it is dictated by elements outside the site):
 - 500m from any irrigated agricultural land
 - 1km from residential areas
 - Indicate isolated residential, tourism facilities on or within 1km of the site
- A slope analysis map/layer that include the following slope ranges:
 - Less than 8% slope (preferred areas for PV and infrastructure)
 - between 8% and 12% slope (potentially sensitive to PV and infrastructure)
 - between 12% and 14% slope (highly sensitive to PV and infrastructure)
 - steeper than 18 % slope (unsuitable for PV and infrastructure)
- A site development proposal map(s)/layer(s) that indicate:
 - Foundation footprint
 - Permanent laydown area footprint
 - Construction period laydown footprint
 - Internal roads indicating width (construction period width and operation period width) and with numbered sections between the other site elements which they serve (to make commenting on sections possible)
 - River, stream and water crossing of roads and cables indicating the type of bridging structures that will be used
 - Substation(s) and/or transformer(s) sites including their entire footprint.
 - Cable routes and trench dimensions (where they are not along internal roads)
 - Connection routes to the distribution/transmission network (the connection must form part of the EIA even if the construction and maintenance thereof will be done by another entity such as ESKOM)
 - Cut and fill areas at PV sites along roads and at substation/transformer sites indicating the expected volume of each cut and fill
 - Borrow pits
 - Spoil heaps (temporary for topsoil and subsoil and permanently for excess material)
 - Buildings including accommodation

With the above information authorities will be able to assess the strategic and site impacts of the application.

4. Regional map and GIS information

The regional map and GIS information should include at least the following:

- All maps/information layers must also be provided in ESRI Shapefile format
- The map/layer must cover an area of 20km around the site
- Indicate the following:
 - roads including their types (tarred or gravel) and category (national, provincial, local or private)
 - Railway lines and stations
 - Industrial areas
 - Harbours and airports
 - Electricity transmission and distribution lines and substations
 - Pipelines
 - Waters sources to be utilised during the construction and operational phases
 - A visibility assessment of the areas from where the facility will be visible
 - Critical Biodiversity Areas and Ecological Support Areas
 - Critically Endangered and Endangered vegetation areas
 - Agricultural fields
 - Irrigated areas
 - An indication of new road or changes and upgrades that must be done to existing roads in order to get equipment onto the site including cut and fill areas and crossings of rivers and streams

5. Important stakeholders

Amongst other important stakeholders, comments from the National Department of Agriculture, Forestry and Fisheries must be obtained and submitted to the Department. Any application, documentation, notification etc. should be forwarded to the following officials:

Ms Mashudu Marubini
Delegate of the Minister (Act 70 of 1970)
E-mail: MashuduMa@daff.gov.za
Tel 012- 319 7619

Ms Thoko Buthelezi
AgriLand Liaison office
E-mail: ThokoB@daff.gov.za
Tel 012- 319 7634

All hardcopy applications / documentation should be forwarded to the following address:

Physical address:
Delpen Building
Cnr Annie Botha and Union Street
Office 270
Attention: Delegate of the Minister Act 70 of 1970

Postal Address:
Department of Agriculture, Forestry and Fisheries
Private Bag X120
Pretoria
0001
Attention: Delegate of the Minister Act 70 of 1970

In addition, comments must be requested from Eskom regarding grid connectivity and capacity. Request for comment must be submitted to:

Mr John Geeringh
Eskom Transmission
Megawatt Park D1Y38
PO Box 1091
JOHANNESBURG
2000

Tel: 011 516 7233
Fax: 086 661 4064
John.geeringh@eskom.co.za

B. AGRICULTURE STUDY REQUIREMENTS

- Detailed soil assessment of the site in question, incorporating a radius of 50 m surrounding the site, on a scale of 1:10 000 or finer. The soil assessment should include the following:
 - Identification of the soil forms present on site
 - The size of the area where a particular soil form is found
 - GPS readings of soil survey points
 - The depth of the soil at each survey point
 - Soil colour
 - Limiting factors
 - Clay content
 - Slope of the site
 - A detailed map indicating the locality of the soil forms within the specified area,
 - Size of the site
- Exact locality of the site
- Current activities on the site, developments, buildings
- Surrounding developments / land uses and activities in a radius of 500 m of the site
- Access routes and the condition thereof
- Current status of the land (including erosion, vegetation and a degradation assessment)
- Possible land use options for the site
- Water availability, source and quality (if available)
- Detailed descriptions of why agriculture should or should not be the land use of choice
- Impact of the change of land use on the surrounding area
- A shape file containing the soil forms and relevant attribute data as depicted on the map.

C. ASTRONOMY GEOGRAPHIC ADVANTAGE ACT, 2007 (ACT NO. 21 OF 2007)

The purpose of the Act is to preserve the geographic advantage areas that attract investment in astronomy. The entire Northern Cape Province excluding the Sol Plaatjie Municipality had been declared an astronomy advantage area. The Northern Cape optical and radio telescope sites were declared core astronomy advantage areas. The Act allowed for the declaration of the Southern Africa Large Telescope (SALT), MeerKAT and Square Kilometre Array (SKA) as astronomy and related scientific endeavours that had to be protected.

You are requested to indicate the applicability of the Astronomy Geographic Advantage Act, Act No. 21 of 2007 on the application in the BAR/EIR. You must obtain comments from the Southern African Large Telescope (SALT) if the proposed development is situated within a declared astronomy advantage area.

**COMMENTS ON DRAFT SCOPINGREPORT FROM NATIONAL
DEPARTMENT OF ENVIRONMENTAL AFFAIRS**



environmental affairs

Department:
Environmental Affairs
REPUBLIC OF SOUTH AFRICA

Private Bag X 447· PRETORIA · 0001· Environment House · 473 Steve Biko Road, Arcadia · PRETORIA

DEA Reference: 14/12/16/3/3/2/843

Enquiries: Ms Juliet Mahlangu

Tel: 012 399 9320 E-mail: JMMahlangu@environment.gov.za

Paul Lochner
Council for Scientific and Industrial Research (CSIR)
P O BOX 320
STELLENBOSCH
7599

Tel: (021) 888 2486 / 021 888 2661
Email: plochner@csir.co.za

PER EMAIL / MAIL

Dear Paul Lochner

ACKNOWLEDGEMENT OF RECEIPT OF A NEW APPLICATION FOR ENVIRONMENTAL AUTHORISATION (SCOPING PROCESS) AND A DRAFT SCOPING REPORT FOR THE PROPOSED DEVELOPMENT OF A 75MW SOLAR PHOTOVOLTAIC FACILITY (GEMSBOK SOLAR PV5) ON PORTION 8 OF GEMSBOK BULT FARM 120, 30 KM NORTH-EAST OF KENHARDT, NORTHERN CAPE PROVINCE

The Department confirms having received the application for environmental authorisation and the Draft Scoping report for the abovementioned project on 28 October 2015. You have submitted these documents to comply with the Environmental Impact Assessment Regulations, 2014.

Further note that in terms of regulation 45 of the EIA Regulations, 2014 this application will lapse if the applicant fails to meet any of the time-frames prescribed in terms of these Regulations, unless an extension has been granted in terms of regulation 3(7).

You are hereby reminded of Section 24F of the National Environmental Management Act, Act No 107 of 1998, as amended, that no activity may commence prior to an environmental authorisation being granted by the Department.

Yours sincerely

Mr Sabelo Malaza

Chief Director: Integrated Environmental Authorisations
Department of Environmental Affairs:

Letter signed by: Ms Senisha Soobramany

Designation: Control Environmental Officer (Grade A): Integrated Environmental Authorisations

Date: 30 October 2015

CC:	Warren Morise	Gemsbok Solar PV5 (Pty) Ltd	Email: warren@muilo.com
	A Yahphi	Northern Cape Department of Environment and Nature Conservation	Email: nyaphi@ncpg.gov.za
	H T Scheepers	IKheis Local Municipality	Email: teresescheepers@vodamail.co.za



environmental affairs

Department:
Environmental Affairs
REPUBLIC OF SOUTH AFRICA

Private Bag X 447 PRETORIA · 0001 Environment House · 473 Steve Biko Road, Arcadia, PRETORIA
Tel (+ 27 12) 399 9372

DEA Reference: 14/12/16/3/3/2/843

Enquiries: Ms Thabile Sangweni

Telephone: (012) 399 9409 E-mail: TSangweni@environment.gov.za

Mr Paul Lochner
Council for Scientific and Industrial Research (CSIR)
PO Box 320
STELLENBOSCH
7599

Telephone Number: (021) 888 2486
Email Address: plochner@csir.co.za

PER E-MAIL / MAIL

Dear Mr Lochner

COMMENTS ON THE DRAFT SCOPING REPORT FOR THE PROPOSED 75 MW GEMSBOK SOLAR PV5 FACILITY AND ITS ASSOCIATED INFRASTRUCTURE ON PORTION 8 OF THE FARM GEMSBOK BULT 120 NEAR KENHARDT WITHIN THE KHEIS LOCAL MUNICIPALITY IN THE NORTHERN CAPE PROVINCE

The draft Scoping Report (SR) dated October 2015 and received by this Department on 28 October 2015 refers.

This Department has the following comments on the abovementioned application:

- i. Please ensure that all relevant listed activities are applied for, are specific and that it can be linked to the development activity or infrastructure as described in the project description.
- ii. If the activities applied for in the application form differ from those mentioned in the final SR, an amended application form must be submitted. Please note that the Department's application form template has been amended and can be downloaded from the following link <https://www.environment.gov.za/documents/forms>.
- iii. Please ensure that all issues raised and comments received during the circulation of the SR from registered I&APs and organs of state which have jurisdiction in respect of the proposed activity are adequately addressed in the Final SR. Proof of correspondence with the various stakeholders must be included in the Final SR. Should you be unable to obtain comments, proof should be submitted to the Department of the attempts that were made to obtain comments. The Public Participation Process must be conducted in terms of Regulation 39, 40 41, 42, 43 & 44 of the EIA Regulations 2014.
- iv. In accordance with Appendix 1 (3) (1) (a) of the EIA Regulations 2014, the details of—
 - (i) the EAP who prepared the report; and
 - (ii) the expertise of the EAP to carry out Scoping and Environmental Impact assessment procedures; must be submitted.
- v. This Department requires comments from SKA-SA to be included in the final SR.
- vi. This Department requires a cumulative impact assessment to be undertaken in the final SR.
- vii. This Department requires that the Socio-Economic Impact Assessment undertaken by the CSIR must be peer reviewed by an external specialist.

- viii. You are further reminded that the final SR to be submitted to this Department must comply with all the requirements in terms of the scope of assessment and content of scoping reports in accordance with Appendix 2 and Regulation 21(1) of the EIA Regulations, 2014.
- ix. Further note that in terms of Regulation 45 of the EIA Regulations 2014, this application will lapse if the applicant fails to meet any of the timeframes prescribed in terms of these Regulations, unless an extension has been granted in terms of Regulation 3(7).

You are hereby reminded of Section 24F of the National Environmental Management Act, Act No 107 of 1998, as amended, that no activity may commence prior to an environmental authorisation being granted by the Department.

Yours faithfully

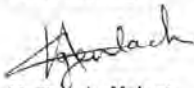

Mr Sabelo Malaza
Chief Director: Integrated Environmental Authorisations
Department of Environmental Affairs
Signed by: Mr Coenrad Agenbach
Designation: Deputy Director: Strategic Infrastructure Developments
Date: 10/11/2015

cc:	Mr Warren Morse	Gemsbok Solar PV5 (Pty) Ltd	Email: warren@mulilo.com
-----	-----------------	-----------------------------	--------------------------

**COMMENTS RECEIVED FROM INTERESTED AND AFFECTED PARTIES
AFTER THE RELEASE OF SCOPING REPORT FOR COMMENT**



water & sanitation

Department:
Water and Sanitation
REPUBLIC OF SOUTH AFRICA

Northern Cape Region
Lower Orange Water Management Area
Private Bag X5912, Upington, 8800
Tel: (054) 338-5800, Fax: (054) 334-0205, www.dwa.gov.za

F 054 334 0205

E SchwartzC@dws.gov.za

C.Schwartz

054 338 5800

By Registered Mail

CSIR

PO Box 320

Stellenbosch

7533

Attention: Paul Lochner

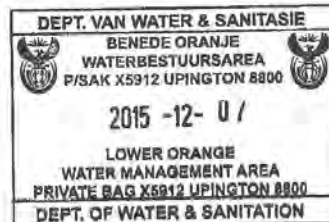

SCOPING AND ENVIRONMENTAL IMPACT ASSESSMENT REPORT FOR THE PROPOSED DEVELOPMENT OF A 75MW SOLAR PHOTOVOLTAIC FACILITY (GEMSBOK SOLAR PV5) ON PORTION 8 OF GEMSBOK BULT FARM 120, NORTHEAST OF KENHADT, NORTHERN CAPE PROVINCE.

The Department of Water & Sanitation (DWS) hereby acknowledges receipt of your scoping and environmental impact assessment report for the proposed development of a 75mw solar photovoltaic facility (Gemsbok solar PV5) on Portion 8 of Gemsbok Bult farm 120, northeast of Kenhardt, Northern Cape Province. The department has reviewed the document and the comments are as follows:

- Please note that no development should take place within 100m horizontal distance from a water course or within 1:100 year flood line. Operation and storage of equipment within the riparian zone must be limited as far as possible.
- Damaging the beds and banks of a water course has been identified as one of the potential impacts by the development. Please note that altering the bed, banks and characteristic flow of a watercourse is identified as a water use by the National Water Act and carrying out of such activity will need a Water Use Licence Application in terms of the above mentioned act.
- Any spillage of any hazardous materials including diesel that may occur during construction and operation must be dealt with and reported to this Department within 24 hours.
- Material with pollution generating potential must be limited in any construction activities. Any hazardous substances must be handled according to the relevant legislation relating to transport, storage and use of the substance.

- Storm water must be diverted from the construction works and roads and must be managed in such a manner as to disperse runoff and to prevent the concentration of storm water flow. Where necessary, works must be constructed to attenuate the velocity of the storm water discharge and to protect the banks of the watercourse.
- All sewage, grey and wash water, as well as any waste generated during the construction phase of the facilities will be collected, contained and disposed of at the permitted and / or licensed facilities of the Local Authority and this must please be confirmed in writing by the local authority.

Please feel free to contact this department, should there be any enquiries.

Yours sincerely,

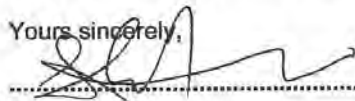

H. CEO (ACTING): ORANGE PROTO-CMA

DATE: 07/12/2015



agriculture,
forestry & fisheries

Department:
Agriculture, Forestry and Fisheries
REPUBLIC OF SOUTH AFRICA

Directorate: Forestry Management (Other Regions)
P.O. Box 2782, Uptington, 8800, Tel 054 338 5909, Fax 054 334 0030

Enquiries: J Mans
E-mail: JacolineMa@daff.gov.za
Date: 1 December 2015
Ref: F13/11/2/331

CSIR Environmental Management Services
P.O. Box 320
STELLENBOSCH
2599

ATTENTION: Minnelise Levendal (mlevendal@csir.co.za)

RE: COMMENTS ON SCOPING REPORT OF THE PROPOSED 75 MW GEMSBOK SOLAR PV5 PHOTOVOLTAIC FACILITY ON PORTION 8 OF GEMSBOK BULT FARM 120, KENHARDT (DEA REF: TO BE ALLOCATED; CSIR REF: CSIR/CAS/EMS/ER/2015/0019/B)

1. DEPARTMENTAL MANDATE

- 1.1 The Directorate: Forestry Management (Other Regions) in the Branch: Forestry and Natural Resource Management of the National Department of Agriculture, Forestry and Fisheries (DAFF) is responsible for implementation of the National Forests Act, Act 84 of 1998 (NFA) and the National Veld and Forest Fires Act, Act 101 of 1998 as amended.
- 1.2 The proposed developer must comply with the following sections of the NFA, as alluded to on page 4-9 of the Scoping Report:
 - 1.2.1 Section 12(1): "The Minister may declare-
 - (a) a particular tree,
 - (b) a particular group of trees,
 - (c) a particular woodland; or
 - (d) trees belonging to a particular species, to be a protected tree, group of trees, woodland or species.
 - 1.2.2 Section 15(1): "No person may-
 - (a) Cut, disturb, damage or destroy any protected tree; or
 - (b) Possess, collect, remove, transport, export, purchase, sell, donate or in any other manner acquire or dispose of any protected tree, or any forest product derived from a protected tree, except-
 - (i) under a license granted by the Minister; or
 - (ii) in terms of an exemption from the provision of this subsection published by the Minister in the Gazette on the advice of the Council."



- 1.2.3 Section 62(2)(c): "Any person who contravenes the prohibition on-
- (i) The cutting, disturbance, damage or destruction of temporarily protected trees or groups of trees referred to in section 14(2) or protected trees referred to in section 15(1)(a); or
 - (ii) The possession, collection, removal, transport, export, purchase or sale of temporarily protected trees or groups of trees referred to in section 14(2) or protected trees referred to in section 15(1)(b), or any forest product derived from a temporarily protected tree, group of trees or protected tree, is guilty of a first category offence.
- 1.2.4 Section 58 (1): "Any person who is guilty of a first category offence referred to in sections 62 and 63 may be sentenced to a fine or imprisonment for a period of up to three years, or to both a fine and such imprisonment."
- 1.2.5 The most recent list of protected trees under the National Forests Act, 1998 (Act No. 84 of 1998) belonging to a particular species under section 12(1) (d), was published in GN908 of 21 November 2014.

2. COMMENTS ON SCOPING REPORT

- 2.1 Page 4 of the Scoping Report indicated that the project area of the proposed Gemsbok Solar PV5 is 275 ha, but only cover an approximate area of 220 ha; hence major environmental constraints can be avoided. Page 3-5 indicated that the affected vegetation type is Bushmanland Arid Grassland. The report stated that a few species of conservation importance may be present on the sites, but this will only be confirmed during the site visit. Kindly ensure that the anticipated impacts on NFA listed protected tree species are assessed during the EIA phase and give an accurate estimation of the number of protected trees per species and size classes to be destroyed as a result of the proposed development.
- 2.2 Please note that this Department will assess the cumulative impacts on protected trees for the seven (7) x 75 MW Solar PV Facilities, since all facilities are located within the same geographical area. The total area to be cleared of vegetation is said to be \pm 2 285 ha (of the total farms area of 14 380 ha). Clearing of 2 285 ha may have significant impacts on slow growing protected tree species regarded as keystone species upon which many other plants and animals depend for survival in semi-arid regions. If unavoidable impacts are significant, an environmental offset may be required.
- 2.3 Page 6-6 stated: "Should any of the Quiver Tree (*Aloe dichotoma*) individuals ... be damaged, cut or removed off-site, a permit would first need to be obtained from the DAFF, Upington office." Kindly note Quiver Trees are protected under the provincial Northern Cape Nature Conservation Act, Act 9 of 2009 (NCNCA) and the Flora Permit for removal of Quiver Trees must be obtained from the provincial Department of Environment and Nature Conservation (DENC). There is currently a moratorium in place in the Northern Cape prohibiting the removal of *A. dichotoma* from the wild (Proclamation No. 968 of 1 April 2005). Enquiries in this regard should be addressed to the DENC.
- 2.4 Page 6-6 indicated that the full ecological impact assessment will be undertaken during the EIA phase. Kindly supply a copy of the ecological impact assessment report to the DAFF (Forestry Office in Upington) for comments once available. All possible efforts should be made to avoid sensitive areas and to minimize impacts on slow growing protected trees by placing infrastructure in the areas where it would have the least impact on such trees.

Kind Regards,

Jacoline Mans
Chief Forester- NFA Regulation

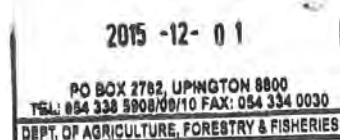



17 Baker Street
Rosebank
Johannesburg
South Africa
2196

Tel: +27 (0) 11 442 2434
Fax: +27 (0) 11 442 2454
Email: atiplady@sksa.ac.za

Minnelise Levendal

CSIR - Environmental Management Services

**PO Box 320
Stellenbosch
7599**

E-mail: mlevendal@csir.co.za

Date: 18 November

Dear Minnelise,

**Re: Development of Four Solar PV facilities (Gemsbok PV3, Gemsbok PV4, Gemsbok PV5 and
Gemsbok PV6) on Portion 3 & 8 of the Farm Gemsbok Bult 120, Kenhardt, Northern Cape**

This letter is in response to your email request, to provide an assessment on the potential development of four photo-voltaic electricity generation facilities in the Northern Cape Province and the risk they may pose on the Square Kilometre Array Project.

A high level risk assessment has been conducted at the South African SKA Project Office to determine the potential impact of such facilities on the Square Kilometre Array. This letter serves to confirm the outcomes of the risk assessment, and proposals for any future investigations associated with this facility.

- I. The location of the proposed facility has been provided in the scoping report compiled by CSIR,
- II. The nearest SKA station has been identified as SKA2360, at approximately 14km from the proposed installation;
- III. Based on distance to the nearest SKA station, and the information currently available on the detailed design of the PV installation, a single photo-voltaic electricity generation facility would pose a medium to high risk of detrimental impact on the SKA. However, multiple facilities, as is the case for this application, would result in an increase in the risk (to at least a high risk or extremely high risk) of detrimental impact on the SKA as a result of the integrated impact;
- IV. Any transmitters that are to be established, or have been established, at the site for the purposes of voice and data communication will be required to comply with the relevant AGA regulations concerning the restriction of use of the radio frequency spectrum that applies in the area concerned;
- V. As a result of the **high risk** associated with the PV facilities, the SKA project office recommends that further EMI and RFI detailed studies be conducted as significant mitigation measures would be required to lower the risk of detrimental impact to an acceptable level. Should a significant decrease in the risk not be achievable, the South African SKA Project Office will not support the proposed establishment of these facilities;



S O U T H A F R I C A S Q U A R E K I L O M E T R E A R R A Y
SKA South Africa Project Office





VI. The South African SKA Project Office would like to be kept informed of progress with this project, and reserves the right to further risk assessments at a later stage.

This technical advice is provided by the South African SKA Project Office on the basis of the protection requirements of the SKA in South Africa, and does not constitute legal approval of the renewable energy projects in terms of the Astronomy Geographic Advantage Act, the Management Authority, and its regulations or declarations.

Regards,

A handwritten signature in black ink, appearing to read 'Adrian Tiplady'.

Dr. Adrian Tiplady
Head of Strategy
SKA South Africa
Tel. 011 442 2434
Fax: 011 442 2454
atiplady@ska.ac.za



SOUTH AFRICA SQUARE KILOMETRE ARRAY
SKA South Africa Project Office





the denc

Department:
Environment & Nature Conservation
NORTHERN CAPE PROVINCE
REPUBLIC OF SOUTH AFRICA

Private Bag X 6102, Kimberley, 8300, SASKO Building, Tel: 053-807 7430, Fax: 053-831 3530

Enquiries :
Dipatlisiso :
Navrae :
Imibuzo :

Ordain Riba

Date :

Leltha :

Datum : 02/12/2015

Umhlo :

Reference:
Tshupela :
Verwysing :
Isialathiso :

NC/NAT/ZFM/KEN/GEM3/2015
DEA :14/12/16/3/3/2/843

Att: Ms Minnelise Levendal
CSIR
11 Jan Celliers Street
Stellenbosch
7599

Dear Ms Levendal

SCOPING AND ENVIRONMENTAL IMPACT ASSESSMENT FOR THE PROPOSED DEVELOPMENT OF A 75 MW SOLAR PHOTOVOLTAIC FACILITY (GEMSBOK SOLAR PV5) ON PORTION 8 OF GEMSBOK BULT FARM 120, NORTH EAST OF KENHARDT,NORTHERN CAPE PROVINCE.

The above scoping report dated **05/11/2015**, referred. The DENC reviewed the Scoping report and came to the following concerns on the report that was reviewed.

1. The nature and quantity of raw materials needed during construction phase. Their source, transportation to site, storage on site and pollution potential must be described.
2. How many of these raw material would be sourced locally (Northern Cape)?
3. How many litres would be used to wash the panels and has that number factored in that the proposed project is located in a dusty area.
4. The amount of energy needed during the construction phase, a description of the source and the availability.

5. Compliance with the environmental management framework of Siyanda District (ZFM EMF) must be indicated in the report.
6. Please explore alternatives of shared laydown areas or central laydown areas to avoid patches of compacted areas.
7. During the construction phase of the project will diesel be stored on site and if the diesel will be stored on site in what quantities will the diesel be stored?
8. Must ensure that soil compaction is only done when necessary and the rest of the undisturbed land is not used as thoroughfares so as to avoid reduction of soil infiltration capacity and increase in soil erosion.
9. Must indicate in numbers as to how many protected trees will be affected by the proposed project, the accuracy of the numbers is very vital as it gives the department an idea of what the cumulative impacts are when comparing this numbers with the other projects around the same place.
10. The applicant must ensure that concrete batching and mixing is not done around water bodies (drainage lines or washes) to avoid contamination.
11. Must ensure that the exposed topsoil stockpiled is protected and covered to avoid being blown by wind and eroded by rain.
12. Waste generated on-site must be identified, classified and disposed accordantly at a licensed landfill.
13. How would the locally employed workers be made aware of the social health risk related to temporary employment projects e.g. HIV/AIDS and alcoholism.
14. How many local and non-local people would be employed during the construction and operational phase of the proposed project?

Please do not hesitate to contact the Department if you have any queries regarding the contents of this letter.

Yours faithfully,



Mr Ordain Riba
Environmental Officer: Impact Management
02/12/2015

>> Minnelise Levendal 10/28/15 17:33 >>>

Dear Melinda

Thank you very much for acknowledging receipt of the notice of the release of the Scoping Reports for the Mulilo Phase 2 Solar Development (x 7 projects) near Kenhardt in the Northern Cape.

Please note that we mailed you seven hard copies of the Scoping Reports via registered mail (one for each project). We have also included 7 DVDs containing the Scoping Report (one for each project).

Please note that we have also sent you the Background Information Document on the project via registered mail in September 2015, but this letter was returned to us. I used the same the Private Bag Address you provided below.

Please let me know once you receive the Scoping Reports (or if you havent received it by next week)-I hope everything will be in order with the Postal system and that you will receive it.

Many thanks and best wishes,
Minnelise

>>> "Mei Melinda (UPN)" <MeiM@dws.gov.za> 27/10/2015 07:42 >>>

Good Morning Minnelise

Your notice received with regards to the Scoping Reports for the Proposed seven Solar PV projects near Kenhardt; Northern Cape is of reference. DWS requires you to forward hard copies of the above mentioned project to either of the following address:

Physical Address:

**Department Of Water and Sanitation
Louisvale Road Upington
8801**

OR

Postal Address:

**Department Of Water and Sanitation
Private Bag X 5912
Upington
8800**

Your co-operation and assistance is highly appreciated.

With kind regards,

Melinda Mei

Water Quality Management: Orange Proto-CMA

Tel: 054 338 5847

Fax: 054 334 0205

From: John Geeringh <GeerinJH@eskom.co.za>
To: Minnelise Levendal <MLEvendal@csir.co.za>
Date: 27/10/2015 14:30
Subject: RE: Part 2 Release of Scoping Reports for comment for seven solar PV Projects near Kenhardt for Mulilo
Attachments: Eskom requirements for work in or near Eskom servitudes SOLAR (3).doc; Renewable Energy Generation PlantSetbacks to Eskom Infrastructure - Signed.pdf

Please find attached the Eskom requirements for works at or near Eskom infrastructure. It will apply to all the projects listed in your mail.

Regards

John Geeringh (Pr Sci Nat)

Senior Consultant Environmental Management

Eskom GC: Land Development
Megawatt Park
D1Y39
P O Box 1091
Johannesburg
2000

Tel: 011 516 7233
Fax: 086 661 4064
Cell: 083 632 7663

 Eskom	SCOT	Technology
---	------	------------

Title: **Renewable Energy Generation Plant Setbacks to Eskom Infrastructure** Unique Identifier: **240-65559775**

Alternative Reference Number: **N/A**

Area of Applicability: **Power Line Engineering**

Documentation Type: **Guideline**

Revision: **0**

Total Pages: **8**

Next Review Date: **N/A**

Disclosure Classification: **CONTROLLED DISCLOSURE**

<p>Compiled by</p> <p></p> <p>.....</p> <p>J W Chetty Mechanical Engineer Date: <u>20/02/2014</u></p>	<p>Approved by</p> <p></p> <p>.....</p> <p>V Naidoo Chief Engineer (Lines) Date: <u>24/02/2014</u></p>	<p>Authorised by</p> <p></p> <p>.....</p> <p>R A Vajeth Acting Snr Manager (Lines) Date: <u>27/2/2014</u></p>
---	--	--

Supported by SCOT/SC



.....

R Vajeth
SCOT/SC/ Chairperson
 Date: 27/2/2014

PCM Reference: 240-65132732 **LINE ENGINEERING SERVICES**
 SCOT Study Committee Number/Name : **OVERHEAD LINES**

Wind Turbine Eskom Setbacks

Unique Identifier: 240-65559775

Revision: 0

Page: 2 of 9

CONTENTS

	Page
EXECUTIVE SUMMARY	3
1. INTRODUCTION	4
2. SUPPORTING CLAUSES	4
2.1 SCOPE	4
2.1.1 Purpose.....	4
2.1.2 Applicability.....	5
2.2 NORMATIVE/INFORMATIVE REFERENCES	5
2.2.1 Normative.....	5
2.2.2 Informative.....	5
2.3 DEFINITIONS	5
2.3.1 Disclosure Classification.....	6
2.4 ABBREVIATIONS	6
2.5 ROLES AND RESPONSIBILITIES	6
2.6 PROCESS FOR MONITORING	6
2.7 RELATED/SUPPORTING DOCUMENTS	6
3. DOCUMENT CONTENT	6
3.1 INTERNATIONAL SETBACK COMPARISON	6
3.2 ESKOM APPROACH FOR WIND FARMS	7
4. AUTHORISATION	8
5. REVISIONS	8
6. DEVELOPMENT TEAM	9

FIGURES

Figure 1: Horizontal Axis Wind Turbine	8
--	---

CONTROLLED DISCLOSURE

When downloaded from the EDMS, this document is uncontrolled and the responsibility rests with the user to ensure it is in line with the authorised version on the system.

Wind Turbine Eskom Setbacks

Unique Identifier: **240-65559775**

Revision: **0**

Page: **3 of 9**

EXECUTIVE SUMMARY

In recent decades, the use of wind turbines, concentrated solar plants and photovoltaic plants have been on the increase as it serves as an abundant source of energy. This document specifies setbacks for wind turbines and the reasons for these setbacks from infrastructure as well as setbacks for concentrated solar plants and photovoltaic plants. Setbacks for wind turbines employed in other countries were compared and a general setback to be used by Eskom was suggested for use with wind turbines and other renewable energy generation plants.

CONTROLLED DISCLOSURE

When downloaded from the EDMS, this document is uncontrolled and the responsibility rests with the user to ensure it is in line with the authorised version on the system.

Wind Turbine Eskom Setbacks

Unique Identifier: 240-65559775

Revision: 0

Page: 4 of 9

1. INTRODUCTION

During the last few decades, a large amount of wind turbines have been installed in wind farms to accommodate for the large demand of energy and depleting fossil fuels. Wind is one of the most abundant sources of renewable energy. Wind turbines harness the energy of this renewable resource for integration in electricity networks. The extraction of wind energy is its primary function and thus the aerodynamics of the wind turbine is important. There are many different types of wind turbines which will all exhibit different wind flow characteristics. The most common wind turbine used commercially is the Horizontal Axis Wind Turbine. Wind flow characteristics of this turbine are important to analyse as it may have an effect on surrounding infrastructure.

Wind turbines also cause large turbulence downwind that may affect existing infrastructure. Debris or parts of the turbine blade, in the case of a failure, may be tossed behind the turbine and may lead to damage of infrastructure in the wake path.

This document outlines the minimum distances that need to be introduced between a wind turbine and Eskom infrastructure to ensure that debris and / or turbulence would not negatively impact on the infrastructure.

Safety distances of wind turbines from other structures as implemented by other countries were also considered and the reasons for their selection were noted.

Concentrated solar plants and photovoltaic plants setbacks away from substations were also to be considered to prevent restricting possible power line access routes to the substation.

2. SUPPORTING CLAUSES

2.1 SCOPE

This document provides guidance on the safe distance that a wind turbine should be located from any Eskom power line or substation. The document specifies setback distances for transmission lines (220 kV to 765 kV), distribution lines (6.6 kV to 132 kV) and all Eskom substations. Setbacks for concentrated solar plants and photovoltaic plants are also specified away from substations.

2.1.1 Purpose

Setbacks for wind turbines and power lines / substations are required for various reasons. These include possible catastrophic failure of the turbine blade that may release fragments and which may be thrown onto nearby power lines that may result in damage with associated unplanned outages. Turbulence behind the turbine may affect helicopter flight during routine Eskom live line maintenance and

CONTROLLED DISCLOSURE

When downloaded from the EDMS, this document is uncontrolled and the responsibility rests with the user to ensure it is in line with the authorised version on the system.

Wind Turbine Eskom Setbacks

Unique Identifier: **240-65559775**

Revision: **0**

Page: **5 of 9**

inspections that may lead to safety risk of the aircraft / personnel. Concentrated solar plants and photovoltaic plants setback away from substations were required to prevent substations from being boxed in by these renewable generation plants limiting line route access to the substations.

2.1.2 Applicability

This document is applicable to the siting of all new and existing wind turbines, concentrated solar plants and photovoltaic plants near power lines and substations.

2.2 NORMATIVE/INFORMATIVE REFERENCES

2.2.1 Normative

1. <http://www.envir.ec/orb.aw/class=file/action=preview/id=1170403/Hiiumaa+turbulence+impact+EMD.pdf>.
2. <http://www.energy.ca.gov/2005publications/CEC-500-2005-184/CEC-500-2005-184.PDF>
3. <http://www.adamscountywind.com/Revised%20Site/Windmills/Adams%20County%20Ordinance/Adams%20County%20Wind%20Ord.htm>
4. http://www.dsireusa.org/incentives/incentive.cfm?Incentive_Code=PA11R&RE=1&EE=1
5. <http://www.wind-watch.org/documents/european-setbacks-minimum-distance-between-wind-turbines-and-habitations/>
6. <http://www.publications.parliament.uk/pa/ld201011/ldbills/017/11017.1-i.html>
7. http://www.caw.ca/assets/pdf/Turbine_Safety_Report.pdf
8. Rogers J, Slegers N, Costello M. (2011) A method for defining wind turbine setback standards. Wind energy 10.1002/we.468

2.2.2 Informative

None

2.3 DEFINITIONS

Definition	Description
Setback	The minimum distance between a wind turbine and boundary line/dwelling/road/infrastructure/servitude etc.
Flicker	Effect caused when rotating wind turbine blades periodically cast shadows
Tip Height	The total height of the wind turbine ie. Hub height plus half rotor diameter (see Figure1)

CONTROLLED DISCLOSURE

When downloaded from the EDMS, this document is uncontrolled and the responsibility rests with the user to ensure it is in line with the authorised version on the system.

Wind Turbine Eskom Setbacks

Unique Identifier: 240-65559775

Revision: 0

Page: 6 of 9

2.3.1 Disclosure Classification

Controlled disclosure: controlled disclosure to external parties (either enforced by law, or discretionary).

2.4 ABBREVIATIONS

Abbreviation	Description
None	

2.5 ROLES AND RESPONSIBILITIES

All personnel involved in the positioning wind turbines, concentrated solar plants and photovoltaic plants near power lines/substations must follow the setbacks outlined in this guideline.

2.6 PROCESS FOR MONITORING

Approval by Eskom in writing.

2.7 RELATED/SUPPORTING DOCUMENTS

None

3. DOCUMENT CONTENT

3.1 INTERNATIONAL SETBACK COMPARISON

Wind Turbine setbacks employed by various countries were considered. It was found that setbacks were determined for various reasons that include noise, flicker, turbine blade failure and wind effects. The distances (setbacks) varied based on these factors and were influenced by the type of infrastructure

Wind turbine setbacks varied for roads, power lines, dwellings, buildings and property and it was noted that the largest setbacks were employed for reasons of noise and flicker related issues [1-7]. Very few countries specified setbacks for power lines.

The literature survey [1-7], yielded information about studies and experiments were conducted to determine the distance that a broken fragment from a wind turbine might be thrown. Even though of low probability of hitting a power line [5.0×10^{-5}], the distances recorded were significant [750m^[8]]

Setbacks were thus introduced to prevent any damage to Eskom infrastructure.

CONTROLLED DISCLOSURE

When downloaded from the EDMIS, this document is uncontrolled and the responsibility rests with the user to ensure it is in line with the authorised version on the system.

Wind Turbine Eskom Setbacks

Unique Identifier: **240-65559775**

Revision: **0**

Page: **7 of 9**

Wind turbines may also cause changes in wind patterns with turbulent effects behind the hub. These factors dictate the wind turbine setbacks specified in this document.

Concentrated solar plants and photovoltaic plants also can limit access into the substation for power lines of all voltages. A setback distance must therefore be employed to prevent the substation from being boxed in by these generation plants. These setback distances are specified in this document.

3.2 ESKOM REQUIRED SETBACKS

- Eskom requires a setback distance of 3 times the tip height of the wind turbine from the edge of the closest Eskom servitude (including vacant servitudes) for transmission lines.
- Eskom requires a setback distance of 1 times the tip height of the wind turbine from the edge of the closest Eskom servitude (including vacant servitudes) for distribution Lines.
- Eskom must be informed of any proposed wind turbine, concentrated solar plants and photovoltaic activity within a 5 km radius of a substation. No wind turbine structure shall be built within a 2 km radius of the closest point of the substation. Where concentrated solar plants and photovoltaic structures fall within a 2 km radius of the closest point of a substation, Eskom should be informed in writing during the planning phase of the construction of such plant or structure.
- Applicants must show that Eskom radio telecommunication systems (mainly microwave systems) will not be affected in any way by wind turbines.

CONTROLLED DISCLOSURE

When downloaded from the EDMS, this document is uncontrolled and the responsibility rests with the user to ensure it is in line with the authorised version on the system.

Wind Turbine Eskom Setbacks

Unique Identifier: 240-65559775

Revision: 0

Page: 8 of 9

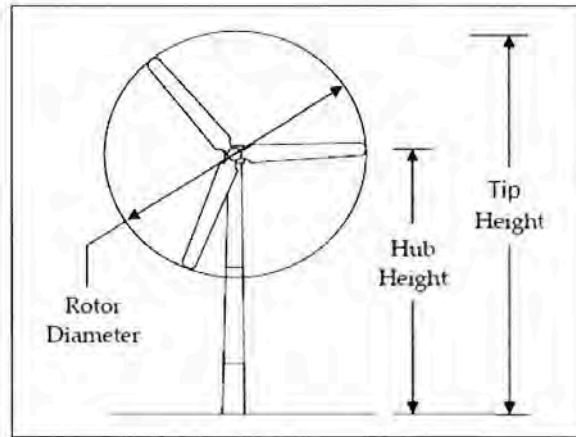

Figure 1: Horizontal Axis Wind Turbine ^[2]

4. AUTHORISATION

This document has been seen and accepted by:

Name & Surname	Designation
V Naidoo	Chief Engineer
Dr P H Pretorius	Electrical Specialist
J Geeringh	Snr Consultant Environ Mngt
B Haridass	Snr Consultant Engineer
R A Vajeth	Acting Snr Manager (Lines)

5. REVISIONS

Date	Rev.	Compiler	Remarks
November 2013	0	J W Chetty	First Publication - No renewable energy generation plant setback specification in existence

CONTROLLED DISCLOSURE

When downloaded from the EDMS, this document is uncontrolled and the responsibility rests with the user to ensure it is in line with the authorised version on the system.

Wind Turbine Eskom Setbacks

Unique Identifier: 240-65559775

Revision: 0

Page: 9 of 9

6. DEVELOPMENT TEAM

The following people were involved in the development of this document:

Jonathan W Chetty (Mechanical Engineer)

Vivendhra Naidoo (Chief Engineer)

Dr Pieter H Pretorius (Electrical Specialist)

John Geeringh (Snr Consultant Environ Mngt)

Bharat Haridass (Snr Consultant Engineer)

Riaz A Vajeth (Acting Snr Manager (Lines))

CONTROLLED DISCLOSURE

When downloaded from the EDMS, this document is uncontrolled and the responsibility rests with the user to ensure it is in line with the authorised version on the system.

Eskom requirements for work in or near Eskom servitudes.

1. Eskom's rights and services must be acknowledged and respected at all times.
2. Eskom shall at all times retain unobstructed access to and egress from its servitudes.
3. Eskom's consent does not relieve the developer from obtaining the necessary statutory, land owner or municipal approvals.
4. Any cost incurred by Eskom as a result of non-compliance to any relevant environmental legislation will be charged to the developer.
5. If Eskom has to incur any expenditure in order to comply with statutory clearances or other regulations as a result of the developer's activities or because of the presence of his equipment or installation within the servitude restriction area, the developer shall pay such costs to Eskom on demand.
6. The use of explosives of any type within 500 metres of Eskom's services shall only occur with Eskom's previous written permission. If such permission is granted the developer must give at least fourteen working days prior notice of the commencement of blasting. This allows time for arrangements to be made for supervision and/or precautionary instructions to be issued in terms of the blasting process. It is advisable to make application separately in this regard.
7. Changes in ground level may not infringe statutory ground to conductor clearances or statutory visibility clearances. After any changes in ground level, the surface shall be rehabilitated and stabilised so as to prevent erosion. The measures taken shall be to Eskom's satisfaction.
8. Eskom shall not be liable for the death of or injury to any person or for the loss of or damage to any property whether as a result of the encroachment or of the use of the servitude area by the developer, his/her agent, contractors, employees, successors in title, and assignees. The developer indemnifies Eskom against loss, claims or damages including claims pertaining to consequential damages by third parties and whether as a result of damage to or interruption of or interference with Eskom's services or apparatus or otherwise. Eskom will not be held responsible for damage to the developer's equipment.
9. No mechanical equipment, including mechanical excavators or high lifting machinery, shall be used in the vicinity of Eskom's apparatus and/or services, without prior written permission having been granted by Eskom. If such permission is granted the developer must give at least seven working days' notice prior to the commencement of work. This allows time for arrangements to be made for supervision and/or precautionary instructions to be issued by the relevant Eskom Manager

Note: Where and electrical outage is required, at least fourteen work days are required to arrange it.

10. Eskom's rights and duties in the servitude shall be accepted as having prior right at all times and shall not be obstructed or interfered with.
11. Under no circumstances shall rubble, earth or other material be dumped within the servitude restriction area. The developer shall maintain the area concerned to Eskom's satisfaction. The developer shall be liable to Eskom for the cost of any remedial action which has to be carried out by Eskom.
12. The clearances between Eskom's live electrical equipment and the proposed construction work shall be observed as stipulated by *Regulation 15 of the Electrical Machinery Regulations of the Occupational Health and Safety Act, 1993 (Act 85 of 1993)*.
13. Equipment shall be regarded electrically live and therefore dangerous at all times.
14. In spite of the restrictions stipulated by Regulation 15 of the Electrical Machinery Regulations of the Occupational Health and Safety Act, 1993 (Act 85 of 1993), as an additional safety precaution, Eskom will not approve the erection of houses, or structures occupied or frequented by human beings, under the power lines or within the servitude restriction area.
15. Eskom may stipulate any additional requirements to highlight any possible exposure to Customers or Public to coming into contact or be exposed to any dangers of Eskom plant.
16. It is required of the developer to familiarise himself with all safety hazards related to Electrical plant.
17. Any third party servitudes encroaching on Eskom servitudes shall be registered against Eskom's title deed at the developer's own cost. If such a servitude is brought into being, its existence should be endorsed on the Eskom servitude deed concerned, while the third party's servitude deed must also include the rights of the affected Eskom servitude.

John Geeringh (Pr Sci Nat)

Senior Consultant Environmental Management

Eskom GC: Land Development

From: JacolineMa <JacolineMa@daff.gov.za>
To: Minnelise Levendal <MLEvendal@csir.co.za>
Date: 28/10/2015 12:45
Subject: RE: Release of Scoping Reports for comment for seven solar PV Projects near Kenhardt for Mulilo
Attachments: Sminolta15102812020.pdf

Dear Minnelise

Attached please find comments from the Department of Forestry.

Kind Regards,

Jacoline Mans

Designation: Chief Forester (NFARegulation)

Directorate: Forestry Management (Other Regions) Northern Cape

Department of Agriculture, Forestry and Fisheries

Tel: 054 338 5909

Fax: 054 334 0030

Web: www.daff.gov.za<<http://www.daff.gov.za/>>

E-mail: JacolineMa@daff.gov.za<<mailto:JacolineMa@daff.gov.za>>

Notice

The information contained in this e-mail may be confidential, legally privileged and protected by law. Access by the intended recipient only is authorised. If you are not the intended recipient, kindly notify the sender immediately. Unauthorised use, copying or dissemination hereof is strictly prohibited.

Save for bona fide departmental purposes, the Department of Agriculture, Forestry and Fisheries does not accept responsibility for the contents or opinions expressed in this e-mail, nor does it warrant this communication to be free from errors, contamination, interference or interception.



agriculture,
forestry & fisheries

Department:
Agriculture, Forestry and Fisheries
REPUBLIC OF SOUTH AFRICA

Directorate: Forestry Management (Other Regions)
P.O. Box 2782, Upington, 8800, Tel 054 338 5909, Fax 054 334 0030

Enquiries: J Mans
E-mail: JacolineMa@daff.gov.za
Date: 28 October 2015
Ref: F13/11/2/327

CSIR – Environmental Management Services
P.O. Box 320
STELLENBOSCH
7599

ATTENTION: Minnelise Levendal (mlevendal@csir.co.za)

RE: COMMENTS ON SCOPING REPORT SUMMARY FOR THE PROPOSED DEVELOPMENT OF SEVEN PHOTOVOLTAIC FACILITIES AND ASSOCIATED ELECTRICAL INFRASTRUCTURE FOR MULILO RENEWABLE PROJECT DEVELOPMENTS (PTY) LTD, NORTH-EAST OF KENHARDT, NORTHERN CAPE PROVINCE (CSIR REF: EMS0106/MULILO/2015)

1. DEPARTMENTAL MANDATE

1.1 The Branch: **Forestry** and Natural Resource Management in the Department of Agriculture, **Forestry** and Fisheries (DAFF) is responsible for implementation of the **National Forests Act, Act 84 of 1998 (NFA)** and the **National Veld and Forest Fires Act, Act 101 of 1998** as amended. The proposed developer must comply with the following sections of the NFA:

- 1.1.1 Section 15(1): "No person may-
- (a) Cut, disturb, damage or destroy any protected tree; or
 - (b) Possess, collect, remove, transport, export, purchase, sell, donate or in any other manner acquire or dispose of any protected tree, or any forest product derived from a protected tree, except-
 - (i) under a license granted by the Minister; or
 - (ii) in terms of an exemption from the provision of this subsection published by the Minister in the Gazette on the advice of the Council."
- 1.1.2 Section 62(2)(c): "Any person who contravenes the prohibition on-
- (i) The cutting, disturbance, damage or destruction of temporarily protected trees or groups of trees referred to in section 14(2) or protected trees referred to in section 15(1)(a); or



- (ii) The possession, collection, removal, transport, export, purchase or sale of temporarily protected trees or groups of trees referred to in section 14(2) or protected trees referred to in section 15(1)(b), or any forest product derived from a temporarily protected tree, group of trees or protected tree, is guilty of a first category offence.

1.1.3 Section 58 (1): "Any person who is guilty of a first category offence referred to in sections 62 and 63 may be sentenced to a fine or imprisonment for a period of up to three years, or to both a fine and such imprisonment."

2. COMMENTS ON SCOPING REPORT SUMMARY

- 2.1 Kindly ensure that you assess the cumulative impacts on NFA listed protected tree species of the proposed seven (7) x 75 MW PV facilities and their associated infrastructure. The facilities should be placed where it would have the least impact on slow growing protected tree species.
- 2.2 For land zoned for agriculture, the Sub-division of Agricultural Land Act 70 of 1970 may also be applicable, requiring inputs from the DAFF. Any land demarcated under the Act, thus agricultural land, cannot be changed to another land use without the supported recommendation under Act 70 of 1970. A local authority cannot change the zoning of demarcated agricultural land to any other zoning without a letter from the Registrar of this Act. The contact persons are: Ms. Mashudu Marubini (Delegate of the Minister for Act 70 of 1970, MashuduMa@daff.gov.za, tel (012) 319 7619); Ms. Thoko Buthelezi (Agriland Liaison office, ThokoB@daff.gov.za, tel (012) 319 7634) or Ms. Hettie Buys Act 70/70 Registry (HettieB@daff.gov.za).
- 2.3 Kindly ensure that you register the Forestry Office in Upington as a commenting authority and supply copies (hardcopies or electronic) of the ecological impact assessment specialist report, as well as other relevant documentation, for commenting purposes.

Kind Regards,

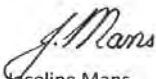

Jacoline Mans
Chief Forester: NFA Regulation



SCOPING AND ENVIRONMENTAL IMPACT ASSESSMENT (EIA) FOR THE PROPOSED DEVELOPMENT OF SEVEN SOLAR PHOTOVOLTAIC OR CONCENTRATED PHOTOVOLTAIC (CPV) SOLAR FACILITIES AND ASSOCIATED ELECTRICAL INFRASTRUCTURE NORTH-EAST OF KENHARDT, NORTHERN CAPE PROVINCE (GEMSBOK SOLAR PV3-, PV4, PV5, PV6; AND BOVEN SOLAR PV2-, 3 & 4) ON PORTIONS 3 AND 8 OF GEMSBOK BULT FARM 120 AND ON THE REMAINING EXTENT OF BOVEN RUGZEER FARM 169

CSIR REFERENCE: EMS0106/MULILO/2015

PROJECT APPLICANT: MULILO RENEWABLE PROJECT DEVELOPMENTS (PTY) LTD

COMMENT AND REGISTRATION FORM

23 October 2015

Name: MYREN C. BOCK	Telephone: 0822277042
Organisation: MJ Universal Enterprise (Pty) Ltd.	Fax: 086 607 4181
Designation: EXECUTIVE DIRECTOR	Email: myrenb91@gmail.com
Physical address: N3 LE ROUX STREET, LANGERWACHT, KAKAMAS, NORTHERN CAPE, 8870	Postal address: P.O. Box 62 KAKAMAS, NC, 8870

Please indicate if you would like to register as an Interested and Affected Party (I&AP) for the proposed projects (if you have not done so already). Registration is required in order to receive further correspondence during the Scoping and EIA Processes. Please tick the appropriate box.

YES	<input checked="" type="checkbox"/>
NO	<input type="checkbox"/>

Please indicate if you have any interest (business, financial, personal or other) in the proposed projects and/or the Applications for Environmental Authorisation:

Business

Please describe any issues or concerns you may have regarding the proposed seven Solar PV projects, which you think should be considered during the EIA Processes.

I would just like to inquire whether the applicant will make use of local, registered service providers (businesses) during the project to enhance and build local service providers and infrastructure.

Please provide details of any other individuals or organisations that should be registered as I&APs:

PLEASE COMPLETE THIS COMMENT AND REGISTRATION FORM BY 24 NOVEMBER 2015 AND SUBMIT IT TO:

Minnelise Levendal
CSIR
Postal Address: P. O. Box 320, Stellenbosch, 7599
Tel: 021 888 2495/2661
Fax: 021 888 2693
E-mail: mlevendal@csir.co.za
Project Website: <http://www.csir.co.za/eia/MuliloSolar>





the denc

Department:
Environment & Nature Conservation
NORTHERN CAPE PROVINCE
REPUBLIC OF SOUTH AFRICA

Private Bag X6102, Kimberley, 8300, Metlife Towers, T-Floor, Tel: 053 807 7300, Fax: 053 807 7324

Enquiries :
Dipatlisiso : O. Riba
Navae :
Imibuzo :

Date :
Leriba : 11th November 2015
Datum:
Umhla:

Reference :
Tshupelo : NC/NAT/ZFM/KEN/GEM3/2015
Verwysing : 14/12/16/3/3/2/843
Isalethiso :

Minnelise Levendal
CSIR
11 Jan Celliers Street
Stellenbosch
7599

Email: mlevendal@csir.co.za

SCOPING AND ENVIRONMENTAL IMPACT ASSESSMENT FOR THE PROPOSED DEVELOPMENT OF A 75 MW SOLAR PHOTOVOLTAIC FACILITY (GEMSBOK SOLAR PV5) ON PORTION 8 OF GEMSBOK BULT FARM 120, NORTH EAST OF KENHARDT, NORTHERN CAPE PROVINCE.

The Department confirms having received the **Scoping & EIA and X3 CD's** for environmental authorisation of the above mentioned project on the **05th November 2015**. As required in term of the Environmental Impact Assessment Regulations, 2014.

The application has been assigned the reference number **NC/NAT/ZFM/KEN/GEM3/2015**. Kindly quote this reference number in any future correspondence in respect of the application. Please note the responsible officer is going to be **Mr. O. Riba** and can be contacted at **060 991 4817**.

Yours faithfully

Ms. L. Toole-Bernardo
EIA: Administrator

From: "Mei Melinda (UPN)" <MeiM@dws.gov.za>
To: Minnelise Levendal <MLEvendal@csir.co.za>
CC: "Shibambu Steven (UPN)" <ShibambuS@dws.gov.za>
Date: 27/10/2015 07:52
Subject: RE: Hard Copies: Scoping Reports For seven solar PV Projects near Kenhardt for Mulilo

Good Morning Minnelise

Your notice received with regards to the Scoping Reports for the Proposed seven Solar PV projects near Kenhardt; Northern Cape is of reference. DWS requires you to forward hard copies of the above mentioned project to either of the following address:

Physical Address:

Department Of Water and Sanitation
Louisvale Road Upington
8801

OR

Postal Address:

Department Of Water and Sanitation
Private Bag X 5912
Upington
8800

Your co-operation and assistance is highly appreciated.

With kind regards,

Melinda Mei
Water Quality Management: Orange Proto-CMA
Tel: 054 338 5847
Fax: 054 334 0205
[Handwashing Day]

From: Lindi Haarhoff <HaarhL@eskom.co.za>
To: Minnelise Levendal <MLEvendal@csir.co.za>
Date: 26/10/2015 11:06
Subject: RE: Part 2 Release of Scoping Reports for comment for seven solar PV Projects near Kenhardt for Mulilo
Attachments: Root3 Profile IPP 2015.pdf

Hi Minnelise,
My contract with Eskom ended the end of February 2015, but I still need to keep an eye on my emails until December 2015. I will forward this information to the relevant person at Eskom.
I am also actively busy with a lot of IPP work for different clients and though maybe there are something I can help you with as well. I know the Eskom processes and most of the Transmission and Distribution team members. I attached my company profile for more information.
Regards,
Lindi Haarhoff
084 529 8292

SCOPING AND ENVIRONMENTAL IMPACT ASSESSMENT (EIA) FOR THE PROPOSED DEVELOPMENT OF SEVEN SOLAR PHOTOVOLTAIC OR CONCENTRATED PHOTOVOLTAIC (CPV) SOLAR FACILITIES AND ASSOCIATED ELECTRICAL INFRASTRUCTURE NORTH-EAST OF KENHARDT, NORTHERN CAPE PROVINCE (GEMSBOK SOLAR PV3-, PV4, PV5, PV6; AND BOVEN SOLAR PV2-, 3 & 4) ON PORTIONS 3 AND 8 OF GEMSBOK BULT FARM 120 AND ON THE REMAINING EXTENT OF BOVEN RUGZEER FARM 169

CSIR REFERENCE: EMS0106/MULILO/2015

PROJECT APPLICANT: MULILO RENEWABLE PROJECT DEVELOPMENTS (PTY) LTD

COMMENT AND REGISTRATION FORM

23 October 2015

Name: Lizell Ströh	Telephone: 011 5451232
Organisation: SACAA	Fax:
Designation: Obstacle Specialist	Email: stroh@caa.co.za
Physical address: Ikhaya Lokondiza Treur Close, Waterfall Park	Postal address: PRIVATE BAG X1 Halfway House, 1685

Please indicate if you would like to register as an Interested and Affected Party (I&AP) for the proposed projects (if you have not done so already). Registration is required in order to receive further correspondence during the Scoping and EIA Processes. Please tick the appropriate box.

YES
 NO

Please indicate if you have any interest (business, financial, personal or other) in the proposed projects and/or the Applications for Environmental Authorisation:

Affected Party.

Please describe any issues or concerns you may have regarding the proposed seven Solar PV projects, which you think should be considered during the EIA Processes

Solar projects height and Transmission propose layout and height.

Please provide details of any other individuals or organisations that should be registered as I&APs

PLEASE COMPLETE THIS COMMENT AND REGISTRATION FORM BY 24 NOVEMBER 2015 AND SUBMIT IT TO:

Minnelise Levendal
CSIR
Postal Address: P. O. Box 320, Stellenbosch, 7599
Tel: 021 888 2495/2661
Fax: 021 888 2693
E-mail: mlevendal@csir.co.za
Project Website: <http://www.csir.co.za/eia/MuliloSolar>



Environmental Impact Assessment for the Proposed Development of a 75 MW Solar Photovoltaic Facility (Gemsbok Solar PV 5) on Portion 8 of Gemsbok Bult Farm 120, north-east of Kenhardt, Northern Cape Province

From: Lizelle Stroh <StrohL@caa.co.za>
To: Minnelise Levendal <MLEvendal@csir.co.za>
Date: 26/10/2015 10:41
Subject: RE: Release of Scoping Reports for comment for seven solar PV Projects near Kenhardt for Mulilo
Attachments: Pylon Geographic co ordinates.xls; Solar Park footprint corners.xls

Your enquiry regarding approval from the SACAA with regard to PV farms refers.
There is a SACAA process whereby permission is applied for wrt obstacles which could pose an aviation hazard. More information can be obtained at <http://www.caa.co.za>. Click on information for industry 'Obstacles' on the LHS. Forms, Part 139-27 and submit on the form itself.

* Kindly provide a .kml (Google Earth) file reflecting the footprint of the proposed development site including the proposed overhead electric power line route that will evacuate the generated power to the national grid.

* Also indicate the highest structure of the project & the Overhead electric power transmission line.

* Note that there may be other wind farms and PV farms in the area. Unique names are preferable.

* Please always use the proposed PV farm name in the Subject box when corresponding via email with this office and indicate the name & address which should appear on the CAA approval/decline letter.

* There is an assessment fee of R690 per application.

* For billing purposes: company name VAT nr. and postal details.

* Kindly ensure that all the above data is forwarded. Incomplete data causes unnecessary delays.

Note that the lead time for approval may take up to 90 days upon receipt of the correct data.

[Description: Description: Description: Reduced Logo]

Lizell Stroh
Obstacle Specialist

PANS-OPS (Procedures for Air navigation<https://en.wikipedia.org/wiki/Air_navigation> Services - Aircraft Operations)

Air Navigation Services

Tel: +27 11 545 1232 | Fax: +27 011 545 1282 | Mobile: +27 83 461 6660 |

Email: strohl@caa.co.za<<mailto:strohl@caa.co.za>>

www.caa.co.za<<http://www.caa.co.za>>

Follow us on [Description: Description: Description: http://upload.wikimedia.org/wikipedia/commons/f/f3/Twitter_icon.png]

<https://twitter.com/SA_CAA> [Description: Description: Description: <cid:image005.png@01CFFDA9.C5C07AE0>]

<<https://www.facebook.com/pages/South-African-Civil-Aviation-Authority-SACAA/804366836280516>>

**COMMENTS RECEIVED FROM INTERESTED AND AFFECTED PARTIES
PRIOR TO THE RELEASE OF THE SCOPING REPORT FOR COMMENT**

Re: Fwd: Kontrakwerk - ivandewee@gmail.com - Gmail

Page 1 of 2

This version of Internet Explorer is no longer supported. Please upgrade to a supported browser. [Dismiss](#)

SCOPING AND ENVIRONMENTAL IMPACT ASSESSMENT (EIA) FOR THE PROPOSED DEVELOPMENT OF SEVEN SOLAR PHOTOVOLTAIC OR CONCENTRATED PHOTOVOLTAIC (CPV) SOLAR FACILITIES AND ASSOCIATED ELECTRICAL INFRASTRUCTURE NORTH-EAST OF KENHARDT, NORTHERN CAPE PROVINCE (GEMSBOK SOLAR PV3-, PV4, PV5, PV6; AND BOVEN SOLAR PV2-, 3 & 4)

CSIR REFERENCE: EMS0106/MULILO/2015

Project Applicant: Mulilo Renewable Project Developments (Pty) Ltd

COMMENT AND REGISTRATION FORM

9 September 2015

Name: Ivan de Wac	Telephone: 0710864269
Organisation: Photo building constr.	Fax: N/A dewee@gmail.com
Designation:	Email: Ivan
Physical address: 114 Jaberanda Street Kenhardt 8900	Postal address: N/A

Please indicate if you would like to register as an Interested and Affected Party (I&AP) for the proposed projects. Registration required in order to receive further correspondence during the Scoping and EIA Processes. Please tick the appropriate box.

YES NO

Please indicate if you have any interest (business, financial, personal or other) in the proposed projects and/or the Applications Environmental Authorisation:

Yes. Developments of Kenhardt solar Panel Project will be beneficial to town and people.

Please describe any issues or concerns you may have regarding the seven proposed solar photovoltaic projects, which you should be considered during the Scoping and EIA Processes.

No concerns.

Work opportunities for community and will create less electricity issues for town.
If local contractors are also included in building process then it will help service experience and create demand for skills in community.
Improved work opportunities locally.

Please provide details of any other individuals or organisations that should be registered as I&APs:

N/A

Please complete this Comment and Registration Form by no later than 10 October 2015 and submit it to:

Minnelise Levendal
CSIR
Postal Address: P. O. Box 320, Stellenbosch, 7599
Tel: 021 888 2495/2661
Fax: 021 888 2693
E-mail: mlevendal@csir.co.za
Project Website: <http://www.csir.co.za/eia/MuliloSolar>



From: John Geeringh <GeerinJH@eskom.co.za>
To: Minnelise Levendal <MLEvendal@csir.co.za>
Date: 29/09/2015 15:25
Subject: RE: Notice of EIA Process for Mulilo - Solar PV Facilities and Associated Electrical Infrastructure, Northern Cape
Attachments: Eskom requirements for work in or near Eskom servitudes SOLAR (3).doc; Renewable Energy Generation PlantSetbacks to Eskom Infrastructure - Signed.pdf

Please find attached Eskom requirements for works at or near Eskom infrastructure.

Regards

John Geeringh (Pr Sci Nat)
Senior Consultant Environmental Management

Eskom GC: Land Development
Megawatt Park
D1Y39
P O Box 1091
Johannesburg
2000

Tel: 011 516 7233
Fax: 086 661 4064
Cell: 083 632 7663

From: Minnelise Levendal [mailto:MLEvendal@csir.co.za]
Sent: 09 September 2015 04:49 PM
To: Minnelise Levendal
Subject: Notice of EIA Process for Mulilo - Solar PV Facilities and Associated Electrical Infrastructure, Northern Cape

Dear Stakeholders and Interested and Affected Parties

If you have received my previous email sent at approximately 4pm today please ignore this email. I received many return messages when I sent out the first email due to mailbox size constraints. I have therefore attached a Low Resolution Background Information Document to this email.

I hope everyone receives this email this time.

For those of you who are receiving the notification of the EIA Process for the first time-Please see my initial email below.

Please do not hesitate to contact me should you have any questions.

Best wishes, Minnelise

>>> Minnelise Levendal 09/09/2015 16:00 >>>

Dear Stakeholders and Interested and Affected Parties

Notice of scoping and environmental impact Assessment for the Proposed development of seven Solar Photovoltaic Facilities AND ASSOCIATED ELECTRICAL INFRASTRUCTURE FOR MULILO RENEWABLE PROJECT DEVELOPMENTS (PTY) LTD, north-east of Kenhardt, Northern Cape Province

Competent Authority: National Department of Environmental Affairs

csir reference: EMS0106/MULILO/2015

This e-mail correspondence serves to inform you of the initiation of a Scoping and Environmental Impact Assessment (EIA) Process for the above-mentioned proposed project, located approximately 30 km north-east of Kenhardt within the !Kheis Local Municipality, Northern Cape Province. The Project Applicant is Mulilo Renewable Project Developments (Pty) Ltd (hereinafter referred to as "Mulilo"). The CSIR has been appointed by Mulilo to undertake the required Scoping and EIA Process.

Environmental Impact Assessment for the Proposed Development of a 75 MW Solar Photovoltaic Facility (Gemsbok Solar PV 5) on Portion 8 of Gemsbok Bult Farm 120, north-east of Kenhardt, Northern Cape Province

A full Scoping and EIA Process is required for the development of seven 75 Megawatt (MW) Solar Photovoltaic (PV) or Concentrated Photovoltaic (CPV) Solar power generation facilities and associated electrical infrastructure (132 kV transmission lines for each 75 MW facility), on Portions 3 and 8 of Gemsbok Bult Farm 120 and the Remaining extent of Boven Rugzeer Farm 169. Two of the projects will be located on Portion 3-, two projects on Portion 8 of Gemsbok Bult Farm 120 and three projects on the Remaining Extent of Boven Rugzeer Farm 169. Each 75 MW Solar PV facility proposed will cover an approximate area of 200 hectares (ha) with a collective footprint of approximately 1 400 ha and a combined power generation capacity of 525 MW. The proposed projects will entail the construction of the solar field, buildings, electrical infrastructure, internal access roads, and associated infrastructure and structures.

The proposed 75 MW Solar PV facilities and transmission lines are located within the same geographical area and constitute the same type of activity; hence an integrated Public Participation Process will be undertaken. However, separate Applications for Environmental Authorisation will be lodged with the National Department of Environmental Affairs (DEA) for each proposed 75 MW Solar PV facility and transmission line. The projects and locations are listed below:

No

Solar PV Project

Project Site

1

Gemsbok Solar PV3

Portion 3 of Gemsbok Bult 120

2

Gemsbok Solar PV4

Portion 3 of Gemsbok Bult 120

3

Gemsbok Solar PV5

Portion 8 of Gemsbok Bult 120

4

Gemsbok Solar PV6

Portion 8 of Gemsbok Bult 120

5

Boven Solar PV2

Remaining Extent of Boven Rugzeer 169

6

Boven Solar PV3

Remaining Extent of Boven Rugzeer 169

7

Boven Solar PV4

Remaining Extent of Boven Rugzeer 169

The proposed projects are being assessed in terms of the National Environmental Management Act (Act 107 of 1998), as amended (NEMA), and the NEMA EIA Regulations, published in Government Notice (GN) R982, R983, R984 and R985 on 8 December 2014.

Please find attached the following:

- Background Information Document (BID);
- Letter 1 to Interested & Affected Parties (I&APs); and
- Comment and Registration Form.

The BID, which provides an overview of the proposed project, is being released to Stakeholders and I&APs for a 30-day comment period ending on 10 October 2015.

In addition, the above-mentioned project information can be accessed at the following website:
<http://www.csir.co.za/http://www.csir.co.za/eia/MuliloSolar>

Kindly ensure that all comments are submitted to the CSIR Project Manager (details provided below) by no later than 10 October 2015.

Thank you and kind regards,

Minnelise Levendal

CSIR - Environmental Management Services

P. O. Box 320, Stellenbosch, 7599

Tel: 021 888 2495/2661

Fax: 021 888 2693

Email: mlevendal@csir.co.za

Beste Belanghebbende en Geïnteresseerde Party

KENNISGEWING VAN OMGEWINGSIMPAKEVALUERINGSPROSESSE VIR DIE VOORGESTELDE ONTWIKKELING VAN SEWE SONKRAGANLEGTE EN ELEKTRIESE INFRASTRUKTUUR VIR 'MULILO RENEWABLE PROJECT DEVELOPMENTS (PTY) LTD' NOORD-OOS VAN KENHARDT, NOORD- KAAP PROVINSIE

Bevoegde Owerheid: Die Nasionale Departement van Omgewingsake

WNNR/CSIR verwysingsnommer: EMS0106/MULILO/2015

Hierdie e-pos korrespondensie is om u in kennis te stel van die aanvang van die Bestek en Omgewingsimpakevalueringproses vir die bogenoemde projekte, wat 30 km noord-oos van Kenhardt in die !Kheis munisipaliteit voorgestel word. Die Aansoeker vir die projek is Mulilo Renewable Project Developments (Pty) Ltd ("Mulilo"). Die WNNR is aangestel deur Mulilo om die Bestek en Omgewingsimpakevalueringproses vir die bogenoemde projekte te onderneem.

'n Bestek en Omgewingsimpakevalueringproses word vereis vir elk van die sewe Fotovoltaïese (PV) sonkragfasiliteite, met 'n opwekkingskapasiteit van tot 75 MW elk en elektriese infrastruktuur (132 kV kraglyn vir elke 75 MW sonkrag fasiliteit). Die beoogde projekte sal geïnstalleer en bedryf op Gedeeltes 3 en 8 van Gemsbok Bult Plaas 120 en Restant van Boven Rugzeer Plaas 169. Twee van die aanlegte sal op Gedeelte 3 -, twee aanlegte sal op Gedeelte 8 van Gemsbok Bult Plaas 120 opgerig word and drie aanlegte op Restant van Boven Rugzeer Plaas 169. Daar sal konneksiepunte wees na die substasie op die Restant van Gedeelte 3 van Gemsbok Bult 120.

Aangesien die sonkragprojekte en die voorgestelde elektriese infrastruktuur in dieselfde geografiese area gebou gaan word en dieselfde tipe projekte is, word dit voorgestel dat 'n geïntegreerde Publieke Deelname Proses onderneem gaan word. Aparte aansoeke gaan by die Nasionale Departement van Omgewingsake ingedien word vir die verskillende projekte. Die projekte sal na verwys word as:

No

Solar PV Project

Project Site

1

Gemsbok Solar PV3

Portion 3 of Gemsbok Bult 120

2

Gemsbok Solar PV4

Portion 3 of Gemsbok Bult 120

3

Gemsbok Solar PV5

Portion 8 of Gemsbok Bult 120

4

Gemsbok Solar PV6

Portion 8 of Gemsbok Bult 120

5

Boven Solar PV2

Remaining Extent of Boven Rugzeer 169

6

Boven Solar PV3

Remaining Extent of Boven Rugzeer 169

7

Boven Solar PV4

Remaining Extent of Boven Rugzeer 169

Die voorgestelde projekte sal ge-evalueer word volgens die Nasionale Omgewingsbestuur Wet, 1998 (Wet No 107 van 1998) (NEMA) en die Omgewingsimpakstudie (OIS) Regulasies soos gepubliseer in Staatskennisgewing R982 in Staatskoerant No 38282 van 08 Desember 2014.

Vind asseblief aangeheg die volgende:

- Beskrywing van die projek (word na verwys as die "BID")
- Brief aan die Belanghebbende en Geïnteresseerde Partye (B&GP'e)
- Kommentaar en Registrasievorm

Die BID, wat dien as agtergrond van die projek, bevat 'n beskrywing van die projek, die gelyste aktiwiteite en is vir 30-dae beskikbaar vir oorsig en kommentaar teen 10 Oktober 2015. 'n Harde kopie van die bogenoemde dokumente is ook gestuur aan diene vir wie ons posadresse het. Inligting van die projek is ook beskikbaar op die projekwebtuiste:
[http://www.csir.co.za<http://www.csir.co.za/>/eia/MuliloSolar](http://www.csir.co.za/http://www.csir.co.za/>/eia/MuliloSolar)

Ons versoek graag dat alle kommentaar aan die WNNR Projekbestuurder (kontakbesonderhede onder aangedui) teen 10 Oktober 2015 verskaf word.

By voorbaat dankie,

Minnelise Levendal

CSIR - Environmental Management Services

Posbus 320, Stellenbosch, 7599

Tel: 021 888 2495/2661

Faks: 021 888 2693

Epos: mlevendal@csir.co.za<mailto:mlevendal@csir.co.za>

--

This message is subject to the CSIR's copyright terms and conditions, e-mail legal notice, and implemented Open Document Format (ODF) standard.

The full disclaimer details can be found at <http://www.csir.co.za/disclaimer.html>.

This message has been scanned for viruses and dangerous content by MailScanner<<http://www.mailscanner.info/>>, and is believed to be clean.

Please consider the environment before printing this email.

I'm part of the 49Million initiative...

<http://www.49Million.co.za>

NB: This Email and its contents are subject to the Eskom Holdings SOC Limited EMAIL LEGAL NOTICE which can be viewed at http://www.eskom.co.za/Pages/Email_Legal_Spam_Disclaimer.aspx

--

This message is subject to the CSIR's copyright terms and conditions, e-mail legal notice, and implemented Open Document Format (ODF) standard.

The full disclaimer details can be found at <http://www.csir.co.za/disclaimer.html>.

This message has been scanned for viruses and dangerous content by MailScanner, and is believed to be clean.

Please consider the environment before printing this email.

Eskom requirements for work in or near Eskom servitudes.

18. Eskom's rights and services must be acknowledged and respected at all times.
19. Eskom shall at all times retain unobstructed access to and egress from its servitudes.
20. Eskom's consent does not relieve the developer from obtaining the necessary statutory, land owner or municipal approvals.
21. Any cost incurred by Eskom as a result of non-compliance to any relevant environmental legislation will be charged to the developer.
22. If Eskom has to incur any expenditure in order to comply with statutory clearances or other regulations as a result of the developer's activities or because of the presence of his equipment or installation within the servitude restriction area, the developer shall pay such costs to Eskom on demand.
23. The use of explosives of any type within 500 metres of Eskom's services shall only occur with Eskom's previous written permission. If such permission is granted the developer must give at least fourteen working days prior notice of the commencement of blasting. This allows time for arrangements to be made for supervision and/or precautionary instructions to be issued in terms of the blasting process. It is advisable to make application separately in this regard.
24. Changes in ground level may not infringe statutory ground to conductor clearances or statutory visibility clearances. After any changes in ground level, the surface shall be rehabilitated and stabilised so as to prevent erosion. The measures taken shall be to Eskom's satisfaction.
25. Eskom shall not be liable for the death of or injury to any person or for the loss of or damage to any property whether as a result of the encroachment or of the use of the servitude area by the developer, his/her agent, contractors, employees, successors in title, and assignees. The developer indemnifies Eskom against loss, claims or damages including claims pertaining to consequential damages by third parties and whether as a result of damage to or interruption of or interference with Eskom's services or apparatus or otherwise. Eskom will not be held responsible for damage to the developer's equipment.
26. No mechanical equipment, including mechanical excavators or high lifting machinery, shall be used in the vicinity of Eskom's apparatus and/or services, without prior written permission having been granted by Eskom. If such permission is granted the developer must give at least seven working days' notice prior to the commencement of work. This allows time for arrangements to be made for supervision and/or precautionary instructions to be issued by the relevant Eskom Manager

Note: Where and electrical outage is required, at least fourteen work days are required to arrange it.

27. Eskom's rights and duties in the servitude shall be accepted as having prior right at all times and shall not be obstructed or interfered with.
28. Under no circumstances shall rubble, earth or other material be dumped within the servitude restriction area. The developer shall maintain the area concerned to Eskom's satisfaction. The developer shall be liable to Eskom for the cost of any remedial action which has to be carried out by Eskom.
29. The clearances between Eskom's live electrical equipment and the proposed construction work shall be observed as stipulated by *Regulation 15 of the Electrical Machinery Regulations of the Occupational Health and Safety Act, 1993 (Act 85 of 1993)*.

30. Equipment shall be regarded electrically live and therefore dangerous at all times.
31. In spite of the restrictions stipulated by Regulation 15 of the Electrical Machinery Regulations of the Occupational Health and Safety Act, 1993 (Act 85 of 1993), as an additional safety precaution, Eskom will not approve the erection of houses, or structures occupied or frequented by human beings, under the power lines or within the servitude restriction area.
32. Eskom may stipulate any additional requirements to highlight any possible exposure to Customers or Public to coming into contact or be exposed to any dangers of Eskom plant.
33. It is required of the developer to familiarise himself with all safety hazards related to Electrical plant.
34. Any third party servitudes encroaching on Eskom servitudes shall be registered against Eskom's title deed at the developer's own cost. If such a servitude is brought into being, its existence should be endorsed on the Eskom servitude deed concerned, while the third party's servitude deed must also include the rights of the affected Eskom servitude.

John Geeringh (Pr Sci Nat)

Senior Consultant Environmental Management
Eskom GC: Land Development

 Eskom	SCOT	Technology
---	-------------	-------------------

Title: **Renewable Energy Generation Plant Setbacks to Eskom Infrastructure** Unique Identifier: **240-65559775**

Alternative Reference Number: **N/A**

Area of Applicability: **Power Line Engineering**

Documentation Type: **Guideline**

Revision: **0**

Total Pages: **8**

Next Review Date: **N/A**

Disclosure Classification: **CONTROLLED DISCLOSURE**

Compiled by



J W Chetty
Mechanical Engineer

Date: 20/02/2014

Approved by



V Naidoo
Chief Engineer (Lines)

Date: 24/02/2014

Authorised by



R A Vajeth
Acting Snr Manager (Lines)

Date: 27/2/2014

Supported by SCOT/SC



R Vajeth
SCOT/SC/ Chairperson

Date: 27/2/2014

PCM Reference: 240-65132732 **LINE ENGINEERING SERVICES**
SCOT Study Committee Number/Name : **OVERHEAD LINES**

Wind Turbine Eskom Setbacks

Unique Identifier: 240-65559775

Revision: 0

Page: 2 of 9

CONTENTS

	Page
EXECUTIVE SUMMARY	3
1. INTRODUCTION	4
2. SUPPORTING CLAUSES	4
2.1 SCOPE	4
2.1.1 Purpose.....	4
2.1.2 Applicability.....	5
2.2 NORMATIVE/INFORMATIVE REFERENCES	5
2.2.1 Normative.....	5
2.2.2 Informative.....	5
2.3 DEFINITIONS	5
2.3.1 Disclosure Classification.....	6
2.4 ABBREVIATIONS.....	6
2.5 ROLES AND RESPONSIBILITIES	6
2.6 PROCESS FOR MONITORING	6
2.7 RELATED/SUPPORTING DOCUMENTS	6
3. DOCUMENT CONTENT	6
3.1 INTERNATIONAL SETBACK COMPARISON	6
3.2 ESKOM APPROACH FOR WIND FARMS.....	7
4. AUTHORISATION	8
5. REVISIONS	8
6. DEVELOPMENT TEAM	9

FIGURES

Figure 1: Horizontal Axis Wind Turbine	8
--	---

CONTROLLED DISCLOSURE

When downloaded from the EDMS, this document is uncontrolled and the responsibility rests with the user to ensure it is in line with the authorised version on the system

Wind Turbine Eskom Setbacks

Unique Identifier: **240-65559775**

Revision: **0**

Page: **3 of 9**

EXECUTIVE SUMMARY

In recent decades, the use of wind turbines, concentrated solar plants and photovoltaic plants have been on the increase as it serves as an abundant source of energy. This document specifies setbacks for wind turbines and the reasons for these setbacks from infrastructure as well as setbacks for concentrated solar plants and photovoltaic plants. Setbacks for wind turbines employed in other countries were compared and a general setback to be used by Eskom was suggested for use with wind turbines and other renewable energy generation plants.

CONTROLLED DISCLOSURE

When downloaded from the EDMS, this document is uncontrolled and the responsibility rests with the user to ensure it is in line with the authorised version on the system.

Wind Turbine Eskom Setbacks

Unique Identifier: 240-65559775

Revision: 0

Page: 4 of 9

1. INTRODUCTION

During the last few decades, a large amount of wind turbines have been installed in wind farms to accommodate for the large demand of energy and depleting fossil fuels. Wind is one of the most abundant sources of renewable energy. Wind turbines harness the energy of this renewable resource for integration in electricity networks. The extraction of wind energy is its primary function and thus the aerodynamics of the wind turbine is important. There are many different types of wind turbines which will all exhibit different wind flow characteristics. The most common wind turbine used commercially is the Horizontal Axis Wind Turbine. Wind flow characteristics of this turbine are important to analyse as it may have an effect on surrounding infrastructure.

Wind turbines also cause large turbulence downwind that may affect existing infrastructure. Debris or parts of the turbine blade, in the case of a failure, may be tossed behind the turbine and may lead to damage of infrastructure in the wake path.

This document outlines the minimum distances that need to be introduced between a wind turbine and Eskom infrastructure to ensure that debris and / or turbulence would not negatively impact on the infrastructure.

Safety distances of wind turbines from other structures as implemented by other countries were also considered and the reasons for their selection were noted.

Concentrated solar plants and photovoltaic plants setbacks away from substations were also to be considered to prevent restricting possible power line access routes to the substation.

2. SUPPORTING CLAUSES

2.1 SCOPE

This document provides guidance on the safe distance that a wind turbine should be located from any Eskom power line or substation. The document specifies setback distances for transmission lines (220 kV to 765 kV), distribution lines (6.6 kV to 132 kV) and all Eskom substations. Setbacks for concentrated solar plants and photovoltaic plants are also specified away from substations.

2.1.1 Purpose

Setbacks for wind turbines and power lines / substations are required for various reasons. These include possible catastrophic failure of the turbine blade that may release fragments and which may be thrown onto nearby power lines that may result in damage with associated unplanned outages. Turbulence behind the turbine may affect helicopter flight during routine Eskom live line maintenance and

CONTROLLED DISCLOSURE

When downloaded from the EDMS, this document is uncontrolled and the responsibility rests with the user to ensure it is in line with the authorised version on the system.

Wind Turbine Eskom Setbacks

Unique Identifier: **240-65559775**

Revision: **0**

Page: **5 of 9**

inspections that may lead to safety risk of the aircraft / personnel. Concentrated solar plants and photovoltaic plants setback away from substations were required to prevent substations from being boxed in by these renewable generation plants limiting line route access to the substations.

2.1.2 Applicability

This document is applicable to the siting of all new and existing wind turbines, concentrated solar plants and photovoltaic plants near power lines and substations.

2.2 NORMATIVE/INFORMATIVE REFERENCES

2.2.1 Normative

1. <http://www.envir.ec/orb.aw/class=file/action=preview/id=1170403/Hiiumaa+turbulence+impact+EMD.pdf>.
2. <http://www.energy.ca.gov/2005publications/CEC-500-2005-184/CEC-500-2005-184.PDF>
3. <http://www.adamscountywind.com/Revised%20Site/Windmills/Adams%20County%20Ordinance/Adams%20County%20Wind%20Ord.htm>
4. http://www.dsireusa.org/incentives/incentive.cfm?Incentive_Code=PA11R&RE=1&EE=1
5. <http://www.wind-watch.org/documents/european-setbacks-minimum-distance-between-wind-turbines-and-habitations/>
6. <http://www.publications.parliament.uk/pa/ld201011/ldbills/017/11017.1-i.html>
7. http://www.caw.ca/assets/pdf/Turbine_Safety_Report.pdf
8. Rogers J, Slegers N, Costello M. (2011) A method for defining wind turbine setback standards. Wind energy 10.1002/we.468

2.2.2 Informative

None

2.3 DEFINITIONS

Definition	Description
Setback	The minimum distance between a wind turbine and boundary line/dwelling/road/infrastructure/servitude etc.
Flicker	Effect caused when rotating wind turbine blades periodically cast shadows
Tip Height	The total height of the wind turbine ie. Hub height plus half rotor diameter (see Figure1)

CONTROLLED DISCLOSURE

When downloaded from the EDMS, this document is uncontrolled and the responsibility rests with the user to ensure it is in line with the authorised version on the system.

Wind Turbine Eskom Setbacks

Unique Identifier: 240-65559775

Revision: 0

Page: 6 of 9

2.3.1 Disclosure Classification

Controlled disclosure: controlled disclosure to external parties (either enforced by law, or discretionary).

2.4 ABBREVIATIONS

Abbreviation	Description
None	

2.5 ROLES AND RESPONSIBILITIES

All personnel involved in the positioning wind turbines, concentrated solar plants and photovoltaic plants near power lines/substations must follow the setbacks outlined in this guideline.

2.6 PROCESS FOR MONITORING

Approval by Eskom in writing.

2.7 RELATED/SUPPORTING DOCUMENTS

None

3. DOCUMENT CONTENT

3.1 INTERNATIONAL SETBACK COMPARISON

Wind Turbine setbacks employed by various countries were considered. It was found that setbacks were determined for various reasons that include noise, flicker, turbine blade failure and wind effects. The distances (setbacks) varied based on these factors and were influenced by the type of infrastructure

Wind turbine setbacks varied for roads, power lines, dwellings, buildings and property and it was noted that the largest setbacks were employed for reasons of noise and flicker related issues [1-7]. Very few countries specified setbacks for power lines.

The literature survey [1-7], yielded information about studies and experiments were conducted to determine the distance that a broken fragment from a wind turbine might be thrown. Even though of low probability of hitting a power line [5.0×10^{-5}]^[8], the distances recorded were significant [750m]^[8]

Setbacks were thus introduced to prevent any damage to Eskom infrastructure.

CONTROLLED DISCLOSURE

When downloaded from the EDMS, this document is uncontrolled and the responsibility rests with the user to ensure it is in line with the authorised version on the system.

Wind Turbine Eskom Setbacks

Unique Identifier: **240-65559775**

Revision: **0**

Page: **7 of 9**

Wind turbines may also cause changes in wind patterns with turbulent effects behind the hub. These factors dictate the wind turbine setbacks specified in this document.

Concentrated solar plants and photovoltaic plants also can limit access into the substation for power lines of all voltages. A setback distance must therefore be employed to prevent the substation from being boxed in by these generation plants. These setback distances are specified in this document.

3.2 ESKOM REQUIRED SETBACKS

- Eskom requires a setback distance of 3 times the tip height of the wind turbine from the edge of the closest Eskom servitude (including vacant servitudes) for transmission lines.
- Eskom requires a setback distance of 1 times the tip height of the wind turbine from the edge of the closest Eskom servitude (including vacant servitudes) for distribution Lines.
- Eskom must be informed of any proposed wind turbine, concentrated solar plants and photovoltaic activity within a 5 km radius of a substation. No wind turbine structure shall be built within a 2 km radius of the closest point of the substation. Where concentrated solar plants and photovoltaic structures fall within a 2 km radius of the closest point of a substation, Eskom should be informed in writing during the planning phase of the construction of such plant or structure.
- Applicants must show that Eskom radio telecommunication systems (mainly microwave systems) will not be affected in any way by wind turbines.

CONTROLLED DISCLOSURE

When downloaded from the EDMS, this document is uncontrolled and the responsibility rests with the user to ensure it is in line with the authorised version on the system.

Wind Turbine Eskom Setbacks

Unique Identifier: 240-65559775

Revision: 0

Page: 8 of 9

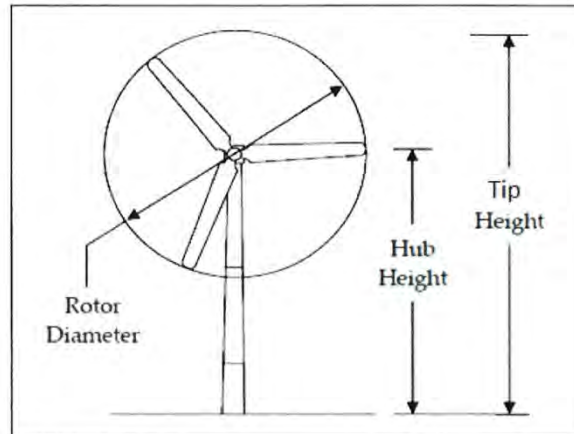

Figure 1: Horizontal Axis Wind Turbine ^[2]

4. AUTHORISATION

This document has been seen and accepted by:

Name & Surname	Designation
V Naidoo	Chief Engineer
Dr P H Pretorius	Electrical Specialist
J Geeringh	Snr Consultant Environ Mngt
B Haridass	Snr Consultant Engineer
R A Vajeth	Acting Snr Manager (Lines)

5. REVISIONS

Date	Rev.	Compiler	Remarks
November 2013	0	J W Chetty	First Publication - No renewable energy generation plant setback specification in existence

CONTROLLED DISCLOSURE

When downloaded from the EDMS, this document is uncontrolled and the responsibility rests with the user to ensure it is in line with the authorised version on the system.

Wind Turbine Eskom Setbacks

Unique Identifier: **240-65559775**

Revision: **0**

Page: **9 of 9**

6. DEVELOPMENT TEAM

The following people were involved in the development of this document:

Jonathan W Chetty (Mechanical Engineer)

Vivendhra Naidoo (Chief Engineer)

Dr Pieter H Pretorius (Electrical Specialist)

John Geeringh (Snr Consultant Environ Mngt)

Bharat Haridass (Snr Consultant Engineer)

Riaz A Vajeth (Acting Snr Manager (Lines))

CONTROLLED DISCLOSURE

When downloaded from the EDMS, this document is uncontrolled and the responsibility rests with the user to ensure it is in line with the authorised version on the system.

From: "Marina Lourens Transnet Freight Rail SLD" <Marina.Lourens@transnet.net>
To: "mlevendal@csir.co.za" <mlevendal@csir.co.za>
Date: 14/09/2015 15:10
Subject: FW:
Attachments: SBS.415_1.pdf

Hi Minnelise

Please see attached letter received from J Hanekom and supply info asap Thanks

From: Johannes Hanekom *Transnet Property CPT
Sent: 14 September 2015 02:33 PM
To: Marina Lourens Transnet Freight Rail SLD
Cc: Burton Siljeur *Transnet Property CPT
Subject: RE:

Hi Marina

Herewith the attached above mentioned for your further attention.

With thanks.

Regards

Jaco Hanekom
Senior Property Technician
Geo-Spatial: Western Region, Transnet Property
5th Floor, No. 1 Adderley Street, Cape Town

[http://www.bcx.co.za/email/sig_mailv5.gif]johannes.hanekom2@transnet.net<mailto:johannes.hanekom2@transnet.net>
[http://www.bcx.co.za/email/sig_phonev5.gif] 021 449 4529

[Transnet original 30%]

From: Marina Lourens Transnet Freight Rail SLD
Sent: 10 September 2015 07:50 AM
To: Johannes Hanekom *Transnet Property CPT
Subject:

For your info

Thanks

DISCLAIMER: The information contained in this email and its attachments is both confidential and subject to copyright. If you are not the intended recipient, you are hereby notified not to read, disclose copy or use the contents thereof in any manner whatsoever, but are kindly requested to notify the sender and delete it immediately. This e-mail message does not create any legally binding contract between Transnet SOC LTD and the recipient, unless the contrary is specifically stated. Statements and opinions expressed in e-mails may not represent those of Transnet SOC LTD. While Transnet will take reasonable precautions, it cannot give any guarantee or warrant that this email will be free of virus infections, errors, interception and, therefore, cannot be held liable for any loss or damages incurred by the recipient, as a result of any of the above-mentioned factors.

--

This message is subject to the CSIR's copyright terms and conditions, e-mail legal notice, and implemented Open Document Format (ODF) standard.

The full disclaimer details can be found at <http://www.csir.co.za/disclaimer.html>.

This message has been scanned for viruses and dangerous content by MailScanner, and is believed to be clean.

Please consider the environment before printing this email.

Geo-Spatial: Western Region **Transnet Property**



2015-09-10

Ms. Marina Lourens
2nd Floor, Salkor Building
Transnet Freight Rail
VREDENBURG
7380

Madam

PROPOSED DEVELOPMENT OF SEVEN SOLAR PHOTOVOLTAIC FACILITIES AND ASSOCIATED ELECTRICAL INFRASTRUCTURE NORTH-EAST OF KENHARDT, NORTHERN CAPE PROVINCE.

Your mail dated 10th September 2015 and correspondence related to MULILO RENEWABLE PROJECT DEVELOPMENT (PTY) LTD refers.

It seems that the proposed development will be situated on land adjacent to 4km to (both of) Rugseer (Loop 14) to 37km to (southwest of) Oorkruis (Loop 15).

This office in principle has no objection to the proposal, but in order for us to assess whether/ how Transnet will be affected, more detailed plans are required indicating the following:

1. The route and location of the proposed electrical lines.
2. Proposed entry/ exit points of the Transnet Service Road from the public access point to the site.

Please advise this office when the wayleave is finalized in order to update our G.I.S.

Kind regards

A handwritten signature in black ink, appearing to read "J.J. HANEKOM", written over a horizontal dashed line.

J.J. HANEKOM
Senior Property Technician

Transnet Property

Reference: SBS.415

Transnet SOC Ltd
Registration Number
1990/000900/30

Transnet Property
Room 505
No.1 Adderley Street
Cape Town
8001

P.O. Box 4753
Cape Town
South Africa
8000
T +27 21 449 4529

Directors: LC Mabaso (Chairperson) B Molefe* (Group Chief Executive) Y Forbes GJ Mahlalela PEB Matheka N Moola ZA Nagdee VM Nkonyane MR Seleke SD Shane BG Stagman PG Williams A Singh* (Group Chief Financial Officer)

*Executive

Group Company Secretary: ANC Ceba

www.transnet.net

Environmental Impact Assessment for the Proposed Development of a 75 MW Solar Photovoltaic Facility (Gemsbok Solar PV 5) on Portion 8 of Gemsbok Bult Farm 120, north-east of Kenhardt, Northern Cape Province

From: <myrenb91@gmail.com>
To: <mlevendal@csir.co.za>
Date: 11/09/2015 13:49
Subject: Re: background information

Good day!

Thank you for your quick and friendly response. I confirm receipt of the background information document and I believe that it will be very helpful.

Kind regards
Myren C. Bock
Sent via my BlackBerry from Vodacom - let your email find you!

--

This message is subject to the CSIR's copyright terms and conditions, e-mail legal notice, and implemented Open Document Format (ODF) standard.

The full disclaimer details can be found at <http://www.csir.co.za/disclaimer.html>.

This message has been scanned for viruses and dangerous content by MailScanner, and is believed to be clean.

Please consider the environment before printing this email.

From: nadineboer4 <nadineboer4@gmail.com>
To: <mlevendal@csir.co.za>
Date: 28/09/2015 14:10
Subject: Fwd: Kontrakwerk

Sent from my Prestigio MultiPad

----- Original Message -----

Subject: Kontrakwerk
From: nadine boer <nadineboer4@gmail.com>
To: mlevendal@scir.co.za
CC:

Hiermee wil ek Mnr I De wee kontrakteur van IR DE WEE T/A MHALO BUILDING CONSTRUCTION graag aansoek doen by MULILO son projekte soos aan adverteer in Die Gemsbok.

Vir enige navrae of vorms wat ek moet in vul heg ek aan vir u my epos adres en my kontaknommer, ivandewee@gmail.com. 0710864269
Byvoorbaat dank.

Die uwe.
I. De Wee.

--

This message is subject to the CSIR's copyright terms and conditions, e-mail legal notice, and implemented Open Document Format (ODF) standard.

The full disclaimer details can be found at <http://www.csir.co.za/disclaimer.html>.

This message has been scanned for viruses and dangerous content by MailScanner, and is believed to be clean.

Please consider the environment before printing this email.

Environmental Impact Assessment for the Proposed Development of a 75 MW Solar Photovoltaic Facility (Gemsbok Solar PV 5) on Portion 8 of Gemsbok Bult Farm 120, north-east of Kenhardt, Northern Cape Province

From: "Nico Engelbrecht" <nico@tshwalec.co.za>
To: <mlevendal@csir.co.za>
Date: 07/10/2015 15:37
Subject: Emailing: scan0129
Attachments: scan0129.pdf

Good Afternoon Minnelise,

Please find attached completed Registration form for Tshwalec & Solareff Joint Venture for the proposed development of seven solar photovoltaic electrical infrastructure

Best regards,
Nico Engelbrecht

Tshwalec Power Projects
Reg: 2006/163535/23
VAT: 4260238086
Fax: +27 86 619 4028
Office: +27 84 409 2598
Cell: +27 61 324 9905

Your message is ready to be sent with the following file or link attachments:

scan0129

Note: To protect against computer viruses, e-mail programs may prevent sending or receiving certain types of file attachments. Check your e-mail security settings to determine how attachments are handled.

--

This message is subject to the CSIR's copyright terms and conditions, e-mail legal notice, and implemented Open Document Format (ODF) standard.

The full disclaimer details can be found at <http://www.csir.co.za/disclaimer.html>.

This message has been scanned for viruses and dangerous content by MailScanner, and is believed to be clean.

Please consider the environment before printing this email.

SCOPING AND ENVIRONMENTAL IMPACT ASSESSMENT (EIA) FOR THE PROPOSED DEVELOPMENT OF SEVEN SOLAR PHOTOVOLTAIC OR CONCENTRATED PHOTOVOLTAIC (CPV) SOLAR FACILITIES AND ASSOCIATED ELECTRICAL INFRASTRUCTURE NORTH-EAST OF KENHARDT, NORTHERN CAPE PROVINCE (GEMSBOK SOLAR PV3-, PV4, PV5, PV6; AND BOVEN SOLAR PV2-, 3 & 4)

CSIR REFERENCE: EMS0106/MULILO/2015

Project Applicant: Mulilo Renewable Project Developments (Pty) Ltd

COMMENT AND REGISTRATION FORM

9 September 2015

Name: NEELS VOSLOO	Telephone: 074 1458727
Organisation: TSHWANEZ & SOLAREFF JOINT VENTURE	Fax: 086 6194 028
Designation: MEMBER	Email: nico@esthwater.co.za
Physical address: 550 NITOPYE STREET THE WILLOWS PRETORIA	Postal address: P.O. Box 74640 LYNLWOOD RIDGE PRETORIA 0040

Please indicate if you would like to register as an Interested and Affected Party (I&AP) for the proposed projects. Registration is required in order to receive further correspondence during the Scoping and EIA Processes. Please tick the appropriate box.

YES <input checked="" type="checkbox"/>	
NO <input type="checkbox"/>	

Please indicate if you have any interest (business, financial, personal or other) in the proposed projects and/or the Applications for Environmental Authorisation:

NO

Please describe any issues or concerns you may have regarding the seven proposed solar photovoltaic projects, which you think should be considered during the Scoping and EIA Processes.

NONE

Please provide details of any other individuals or organisations that should be registered as I&APs:

Please complete this Comment and Registration Form by no later than **10 October 2015** and submit it to:

Minnelise Levendal
CSIR
Postal Address: P. O. Box 320, Stellenbosch, 7599
Tel: 021 888 2495/2661
Fax: 021 888 2693
E-mail: mievendal@csir.co.za
Project Website: <http://www.csir.co.za/eia/MuliloSolar>



From: Minnelise Levendal
To: myrenb91@gmail.com
Date: 11/09/2015 13:11
Subject: Re: Registration as interested party

Dear Myren

Thank you very much for your email. I will register you on our project database as an Interested and Affected Party.

All the comments received now and the comments thereto will be included in the Scoping Report which will be released for comment in October 2015. You will be notified of the release of the report.

I will forward you the Background Information Document in my next email-this document will provide you with more details regarding the project.

Best wishes, Minnelise

Minnelise Levendal
CSIR, Consulting and Analytical Services (Environmental Management Services)
PO Box 320
Stellenbosch 7599

Tel: + 27-21 888-2495
Cell: 083 309 8159
Fax: 021-888 2693
Email: mlevendal@csir.co.za

P GO Green - Please consider the environment before printing this email

>>> <myrenb91@gmail.com> 10/09/2015 11:10 >>>
Good day!

I would like to know more as to the registration as an interested party in the projects with ref: EMS0106/MULILO/2015.

Please let me know as to how the process works and how we as local youth and local entrepreneurs can benefit from this project.

Kind regards.
MYREN C. BOCK
Sent via my BlackBerry from Vodacom - let your email find you!

--

This message is subject to the CSIR's copyright terms and conditions, e-mail legal notice, and implemented Open Document Format (ODF) standard.
The full disclaimer details can be found at <http://www.csir.co.za/disclaimer.html>.

This message has been scanned for viruses and dangerous content by MailScanner, and is believed to be clean.

Please consider the environment before printing this email.

From: Minnelise Levendal
To: ivandewee@gmail.com.
CC: nadineboer4
Date: 28/09/2015 14:56
Subject: Re: Fwd: Kontrakwerk
Attachments: Comment and Response Form_Mulilo BID_NC.pdf; CSIR Letter 1 to I&APs_MuliloSolar NC_BID 90915.pdf; LR Mulilo Solar PV BID_Eng_BID_A4_8 PAGES_LR.pdf

Hi Mnr Dewee

Baie dankie vir u navraag.

Ons maatskappy is deur die klient, Mulilo, aangestel om die EIA proses te doen om Omgewings Goedkeuring te kry. Die klient hanteer self die kontrakteur werk en aanstelling. Ek sal egter u navraag in ons verslag aanteken.

Kan u asb die aangehegte vorm voltooi en terugstuur aan my. Ek sal u dan kan registreer op die projek databasis sodat u op hoogte gehou kan word aangaande die EIA proses. Die proses om goedkeuring te kry sal eers teen volgende jaar Augustus afgehandel wees.

Groete, Minnelise

Minnelise Levendal
CSIR, Consulting and Analytical Services (Environmental Management Services)
PO Box 320
Stellenbosch 7599

Tel: + 27-21 888-2495
Cell: 083 309 8159
Fax: 021-888 2693
Email: mlevendal@csir.co.za

P GO Green - Please consider the environment before printing this email

>>> Minnelise Levendal 28/09/2015 14:48 >>>

Minnelise Levendal
CSIR, Consulting and Analytical Services (Environmental Management Services)
PO Box 320
Stellenbosch 7599

Tel: + 27-21 888-2495
Cell: 083 309 8159
Fax: 021-888 2693
Email: mlevendal@csir.co.za

P GO Green - Please consider the environment before printing this email

>>> Minnelise Levendal 28/09/2015 14:44 >>>

Hi Nadine

Ek het die epos ontvang. Baie dankie. Ek sal vir Mnr De Wee die vorm stuur.

groete, Minnelise

Minnelise Levendal
CSIR, Consulting and Analytical Services (Environmental Management Services)
PO Box 320

Stellenbosch 7599

Tel: + 27-21 888-2495
Cell: 083 309 8159
Fax: 021-888 2693
Email: mlevendal@csir.co.za

P GO Green - Please consider the environment before printing this email

>>> nadineboer4 <nadineboer4@gmail.com> 28/09/2015 14:09 >>>

Sent from my Prestigio MultiPad

----- Original Message -----

Subject: Kontrakwerk
From: nadine boer <nadineboer4@gmail.com>
To: mlevendal@csir.co.za
CC:

Hiermee wil ek Mnr I De wee kontrakteur van IR DE WEE T/A MHALO BUILDING CONSTRUCTION graag aansoek doen by MULILO son projekte soos aan adverteer in Die Gemsbok.

Vir enige navrae of vorms wat ek moet in vul heg ek aan vir u my epos adres en my kontaknommer, ivandewee@gmail.com. 0710864269

Byvoorbaat dank.

Die uwe.

I. De Wee.

--

This message is subject to the CSIR's copyright terms and conditions, e-mail legal notice, and implemented Open Document Format (ODF) standard.

The full disclaimer details can be found at <http://www.csir.co.za/disclaimer.html>.

This message has been scanned for viruses and dangerous content by [MailScanner](#)

, and is believed to be clean.

Please consider the environment before printing this email.

From: Minnelise Levendal
To: Marina Lourens Transnet Freight Rail SLD
Date: 15/09/2015 14:58
Subject: Re: FW:

Dear Marina

Thank you for the letter from Mr Hanekom which you have forwarded to me in response to the release of the Background Information Document for the Mulilo Solar PV Projects near Kenhardt.

I hereby acknowledge receipt of your email and the letter. The comments and responses thereto will be included in the Scoping Report which will be circulated for comment in October 2015. You will be notified of the release of the Scoping Report and the commenting period.

Best wishes, Minnelise

>>> "Marina Lourens Transnet Freight Rail SLD" <Marina.Lourens@transnet.net> 14/09/2015 14:58 >>>

Hi Minnelise

Please see attached letter received from J Hanekom and supply info asap Thanks

From: Johannes Hanekom *Transnet Property CPT
Sent: 14 September 2015 02:33 PM
To: Marina Lourens Transnet Freight Rail SLD
Cc: Burton Siljeur *Transnet Property CPT
Subject: RE:

Hi Marina

Herewith the attached above mentioned for your further attention.

With thanks.

Regards

Jaco Hanekom
Senior Property Technician
Geo-Spatial: Western Region, Transnet Property
5th Floor, No. 1 Adderley Street, Cape Town

johannes.hanekom2@transnet.net 021 449 4529

From: Marina Lourens Transnet Freight Rail SLD
Sent: 10 September 2015 07:50 AM
To: Johannes Hanekom *Transnet Property CPT
Subject:

For your info

Thanks

DISCLAIMER: The information contained in this email and its attachments is both confidential and subject to copyright. If you are not the intended recipient, you are hereby notified not to read, disclose copy or use the contents thereof in any manner whatsoever, but are kindly requested to notify the sender and delete it immediately. This e-mail message does not create any legally binding contract between Transnet SOC LTD and the recipient, unless the contrary is specifically stated. Statements and opinions expressed in e-mails may not represent those of Transnet SOC LTD. While Transnet will take reasonable precautions, it cannot give any

guarantee or warrant that this email will be free of virus infections, errors, interception and, therefore, cannot be held liable for any loss or damages incurred by the recipient, as a result of any of the above-mentioned factors.

--

This message is subject to the CSIR's copyright terms and conditions, e-mail legal notice, and implemented Open Document Format (ODF) standard.

The full disclaimer details can be found at <http://www.csir.co.za/disclaimer.html>.

This message has been scanned for viruses and dangerous content by [MailScanner](#)

, and is believed to be clean.

Please consider the environment before printing this email.

From: Ontvangs <ontvangs@agrink.co.za>
To: "mlevendal@csir.co.za" <mlevendal@csir.co.za>
Date: 15/09/2015 16:06
Subject: Agri Northern Cape

Goeie dag

Graag wil ons u versoek om asseblief mnr Johan van Rensburg se naam van u naamplakkers te verwyder en dit te vervang met mnr Henning Myburgh aangesien mnr Van Rensburg reeds die vorige jaar Agri Noord-Kaap se diens verlaat het. (Andersins moet u dit asseblief net rig aan "Die Hoofbestuurder" Agri Noord-Kaap, Posbus 1094, Kimberley, 8300.

Baie dankie en ons vertrou dat u u adreslys daarvolgens sal aanpas.

Vriendelike groete

L van Niekerk

L van Niekerk
ONTVANGS : AGRI NOORD-KAAP
E-pos : ontvangs@agrink.co.za
Tel : (053) 83 29595
Faks : (053) 83 27126

--

This message is subject to the CSIR's copyright terms and conditions, e-mail legal notice, and implemented Open Document Format (ODF) standard.

The full disclaimer details can be found at <http://www.csir.co.za/disclaimer.html>.

This message has been scanned for viruses and dangerous content by MailScanner, and is believed to be clean.

Please consider the environment before printing this email.



**agriculture,
forestry & fisheries**

Department:
Agriculture, forestry & fisheries
REPUBLIC OF SOUTH AFRICA

Directorate Land Use and Soil Management, Private Bag x120, Gezina Pretoria, 0031
Delpen Building, c/o Annie Botha & Union Streets, Riviera

From: Director: Land Use and Soil Management
Tel: (012) 319 7634 **Fax:** (012) 329 5938 **e-mail:** nhlakad@daff.gov.za

**CSIR
PO Box 320
Stellenbosch
7599**

30 September 2015

Dear Sir/Madam

This serves as a notice of receipt and confirms that your application has been captured in our electronic AgriLand tracking and management system. It is strongly recommended that you use the on-line AgriLand application facility in future.

Detail of your application as captured:

Application type: Rezoning: Seven Solar

Your reference number:

Property Description: **Gemsbok Bult 120 & Boven Rugzeer 169**

Dated: **9 September 2015**

Please use the following reference number in all enquiries:

AgriLand reference number: 2015_09_0252

Enquiries can be made to the above postal, fax or e-mail address.

Yours sincerely,

**HJ Buys
pp DIRECTOR: LAND USE AND SOIL MANAGEMENT**

<http://www.agis.agric.za/agriland>

From: Claude Bosman <claude@veroniva.co.za>
To: <MLEvendal@csir.co.za>
Date: 09/09/2015 17:11
Subject: BID doc - 7x75 mw solar

Hi Minnelise,

Kindly forward me the BID doc on the 7x 75MW pv projects at Kendhardt as we would then like to consider if we should register as n I&AP.

I understand you will be out the office as from tomorrow and we would greatly appreciate it, if you could forward the document today.

Many thanks,
Claude

Claude Bosman (CA) SA
Veroniva (Pty) Ltd - Renewable Energy
Tel +27 (0)82 331 4098
claude@veroniva.co.za
www.veroniva.co.za

--

This message is subject to the CSIR's copyright terms and conditions, e-mail legal notice, and implemented Open Document Format (ODF) standard.

The full disclaimer details can be found at <http://www.csir.co.za/disclaimer.html>.

This message has been scanned for viruses and dangerous content by MailScanner, and is believed to be clean.

Please consider the environment before printing this email.

From: "Melanie Miles" <MelanieM@L2B.co.za>
To: <mlevendal@csir.co.za>
Date: 16/09/2015 13:38
Subject: Sewe Fotovoltaïse Sonkragaanlegte Noord Ooos van Kenhardt

Good Afternoon,

Your company is currently conducting an Environmental Impact Assessment for the Proposed Sewe Fotovoltaïse Sonkragaanlegte Noord Ooos van Kenhardt. Please could you forward me the BID for this application and register me as a Interested & Affected party?

Please could you also send me an English version of the EIA Notice if possible?

Thanking you in anticipation of a favourable response.

Kindest Regards,

Melanie Miles
Content Researcher
MelanieM@L2B.co.za

Leads 2 Business (www.L2B.co.za)

0860836337 or 0860 TENDER
Fax: 033 343 5882

This e-mail is for the intended addressee only. If you have received it in error, please notify the sender by e-mail. Dissemination or copying is prohibited unless permitted by the sender, and then only by the intended addressee. Whilst reasonable measures are used to guard against the transmission of malicious code, no liability is accepted for its transmission. If this e-mail is not related to the business of Cedrus Internet Solutions (Pty) Ltd, it is sent by the above mentioned in their individual capacity and not on behalf of Cedrus Internet Solutions (Pty) Ltd. Please note that any views expressed in this email may be those of the originator and do not necessarily reflect those of Cedrus Internet Solutions (Pty) Ltd.

--

This message is subject to the CSIR's copyright terms and conditions, e-mail legal notice, and implemented Open Document Format (ODF) standard.

The full disclaimer details can be found at <http://www.csir.co.za/disclaimer.html>.

This message has been scanned for viruses and dangerous content by MailScanner, and is believed to be clean.

Please consider the environment before printing this email.

From: Proptrans NC <proptransnc@gmail.com>
To: <mlevendal@csir.co.za>
Date: 16/09/2015 12:23
Subject: Fwd: Accommodation

Good day.

My name is Lawrence Smith. I am the owner and founder of PROPTRANS NC. It is a start-up property and transport business based in Kenhardt. It has not done any business yet.

I just want to know where will the employees of MULILO stay during the construction of the 7 plants around Kenhardt, will you need accommodation, is there any specifications for the accommodation, how many employees will need accommodation and what is the price that you are willing to pay for accommodation and transport to and from the plants.

What is the value of the project and how do you register you as an interest party.

Thank you.

Yours truly
Lawrence Smith

--

This message is subject to the CSIR's copyright terms and conditions, e-mail legal notice, and implemented Open Document Format (ODF) standard.

The full disclaimer details can be found at <http://www.csir.co.za/disclaimer.html>.

This message has been scanned for viruses and dangerous content by MailScanner, and is believed to be clean.

Please consider the environment before printing this email.

From: "Nicole Abrahams (WR)" <AbrahamsN@nra.co.za>
To: "MLevendal@csir.co.za" <MLevendal@csir.co.za>
CC: René de Kock (WR) <Dekockr@nra.co.za>, "ColeneRunkel (WR)" <Runkelc@nra.co.za>
Date: 17/09/2015 11:20
Subject: RE: Notice of EIA Process for Mulilo - Solar PV Facilities and Associated Electrical Infrastructure, Northern Cape

Dear Ms Minnelise Levendal

The above listed proposed project bears reference.

The South African National Roads Agency SOC Limited (SANRAL) has received background information and locality plan. After a detailed review of the proposed project scope, it was established that your project will not impact on SANRAL jurisdiction in any way since its located in close proximity to R383, hence no further comments will be forthcoming from this office. Of particular interest to Sanral is when the proposed project is in close proximity of a National Road (60 m parallel to road reserve fence or if it crosses)

For any further queries do not hesitate to contact the sender.

I trust that you will find the above in order.

Regards

[cid:image001.jpg@01D0DF0B.0E0A3A50]

Ms Nicole Abrahams
Environmental Coordinator
Tel: +27 21 957 4602
Fax: +27 21 910 1699
Email: Abrahamsn@nra.co.za <mailto:Abrahamsn@nra.co.za>

Reg.No.
1998/009584/30

[cid:image002.jpg@01D0DF0B.0E0A3A50]

Sanral
Western Region
1 Havenga Street, Oakdale, 7530
Private Bag X19, Bellville, 7535
www.sanral.co.za<<http://www.sanral.co.za/>>
SANRAL Fraud Hotline: 0800204558

From: Minnelise Levendal [mailto:MLEvendal@csir.co.za]
Sent: 09 September 2015 04:49 PM
To: Minnelise Levendal
Subject: Notice of EIA Process for Mulilo - Solar PV Facilities and Associated Electrical Infrastructure, Northern Cape

Dear Stakeholders and Interested and Affected Parties

If you have received my previous email sent at approximately 4pm today please ignore this email. I received many return messages when I sent out the first email due to mailbox size constraints. I have therefore attached a Low Resolution Background Information Document to this email.

I hope everyone receives this email this time.

For those of you who are receiving the notification of the EIA Process for the first time-Please see my initial email below.

Please do not hesitate to contact me should you have any questions.

Best wishes, Minnelise

>>> Minnelise Levendal 09/09/2015 16:00 >>>

Dear Stakeholders and Interested and Affected Parties

Notice of scoping and environmental impact Assessment for the Proposed development of seven Solar Photovoltaic Facilities AND ASSOCIATED ELECTRICAL INFRASTRUCTURE FOR MULILO RENEWABLE PROJECT DEVELOPMENTS (PTY) LTD, north-east of Kenhardt, Northern Cape Province

Competent Authority: National Department of Environmental Affairs

csir reference: EMS0106/MULILO/2015

This e-mail correspondence serves to inform you of the initiation of a Scoping and Environmental Impact Assessment (EIA) Process for the above-mentioned proposed project, located approximately 30 km north-east of Kenhardt within the !Kheis Local Municipality, Northern Cape Province. The Project Applicant is Mulilo Renewable Project Developments (Pty) Ltd (hereinafter referred to as "Mulilo"). The CSIR has been appointed by Mulilo to undertake the required Scoping and EIA Process.

A full Scoping and EIA Process is required for the development of seven 75 Megawatt (MW) Solar Photovoltaic (PV) or Concentrated Photovoltaic (CPV) Solar power generation facilities and associated electrical infrastructure (132 kV transmission lines for each 75 MW facility), on Portions 3 and 8 of Gemsbok Bult Farm 120 and the Remaining extent of Boven Rugzeer Farm 169. Two of the projects will be located on Portion 3-, two projects on Portion 8 of Gemsbok Bult Farm 120 and three projects on the Remaining Extent of Boven Rugzeer Farm 169. Each 75 MW Solar PV facility proposed will cover an approximate area of 200 hectares (ha) with a collective footprint of approximately 1 400 ha and a combined power generation capacity of 525 MW. The proposed projects will entail the construction of the solar field, buildings, electrical infrastructure, internal access roads, and associated infrastructure and structures.

The proposed 75 MW Solar PV facilities and transmission lines are located within the same geographical area and constitute the same type of activity; hence an integrated Public Participation Process will be undertaken. However, separate Applications for Environmental Authorisation will be lodged with the National Department of Environmental Affairs (DEA) for each proposed 75 MW Solar PV facility and transmission line. The projects and locations are listed below:

No

Solar PV Project

Project Site

1

Gemsbok Solar PV3

Portion 3 of Gemsbok Bult 120

2

Gemsbok Solar PV4

Portion 3 of Gemsbok Bult 120

3

Gemsbok Solar PV5

Portion 8 of Gemsbok Bult 120

4

Gemsbok Solar PV6

Portion 8 of Gemsbok Bult 120

5

Boven Solar PV2

Remaining Extent of Boven Rugzeer 169

6

Boven Solar PV3

Remaining Extent of Boven Rugzeer 169

7

Boven Solar PV4

Remaining Extent of Boven Rugzeer 169

The proposed projects are being assessed in terms of the National Environmental Management Act (Act 107 of 1998), as amended (NEMA),

and the NEMA EIA Regulations, published in Government Notice (GN) R982, R983, R984 and R985 on 8 December 2014.

Please find attached the following:

- Background Information Document (BID);
- Letter 1 to Interested & Affected Parties (I&APs); and
- Comment and Registration Form.

The BID, which provides an overview of the proposed project, is being released to Stakeholders and I&APs for a 30-day comment period ending on 10 October 2015.

In addition, the above-mentioned project information can be accessed at the following website:
[http://www.csir.co.za<http://www.csir.co.za/>/eia/MuliloSolar](http://www.csir.co.za/http://www.csir.co.za/>/eia/MuliloSolar)

Kindly ensure that all comments are submitted to the CSIR Project Manager (details provided below) by no later than 10 October 2015.

Thank you and kind regards,

Minnelise Levendal

CSIR - Environmental Management Services

P. O. Box 320, Stellenbosch, 7599

Tel: 021 888 2495/2661

Fax: 021 888 2693

Email: mlevendal@csir.co.za<<mailto:mlevendal@csir.co.za>>

Beste Belanghebbende en Geïnteresseerde Party

KENNISGEWING VAN OMGEWINGSIMPAAKEVALUERINGSPROSESSE VIR DIE VOORGESTELDE ONTWIKKELING VAN SEWE SONKRAGAANLEGTE EN ELEKTRIESE INFRASTRUKTUUR VIR 'MULILO RENEWABLE PROJECT DEVELOPMENTS (PTY) LTD' NOORD-OOS VAN KENHARDT, NOORD- KAAP PROVINSIE

Bevoegde Owerheid: Die Nasionale Departement van Omgewingsake

WNNR/CSIR verwysingsnommer: EMS0106/MULILO/2015

Hierdie e-pos korrespondensie is om u in kennis te stel van die aanvang van die Bestek en Omgewingsimpakevalueringsproses vir die bogenoemde projekte, wat 30 km noord-oos van Kenhardt in die !Kheis munisipaliteit voorgestel word. Die Aansoeker vir die projek is Mulilo Renewable Project Developments (Pty) Ltd ("Mulilo"). Die WNNR is aangestel deur Mulilo om die Bestek en Omgewingsimpakevalueringsproses vir die bogenoemde projekte te onderneem.

'n Bestek en Omgewingsimpakevalueringsproses word vereis vir elk van die sewe Fotovoltaïese (PV) sonkragfasiliteite, met 'n opwekkingskapasiteit van tot 75 MW elk en elektriese infrastruktuur (132 kV kraglyn vir elke 75 MW sonkrag fasiliteit). Die beoogde

projekte sal geïnstalleer en bedryf op Gedeeltes 3 en 8 van Gemsbok Bult Plaas 120 en Restant van Boven Rugzeer Plaas 169. Twee van die aanlegte sal op Gedeelte 3 -, twee aanlegte sal op Gedeelte 8 van Gemsbok Bult Plaas 120 opgerig word and drie aanlegte op Restant van Boven Rugzeer Plaas 169. Daar sal konneksiepunte wees na die substasie op die Restant van Gedeelte 3 van Gemsbok Bult 120.

Aangesien die sonkragprojekte en die voorgestelde elektriese infrastruktuur in dieselfde geografiese area gebou gaan word en dieselfde tipe projekte is, word dit voorgestel dat 'n geïntegreerde Publieke Deelname Proses onderneem gaan word. Aparte aansoeke gaan by die Nasionale Departement van Omgewingsake ingedien word vir die verskillende projekte. Die projekte sal na verwys word as:

No

Solar PV Project

Project Site

1

Gemsbok Solar PV3

Portion 3 of Gemsbok Bult 120

2

Gemsbok Solar PV4

Portion 3 of Gemsbok Bult 120

3

Gemsbok Solar PV5

Portion 8 of Gemsbok Bult 120

4

Gemsbok Solar PV6

Portion 8 of Gemsbok Bult 120

5

Boven Solar PV2

Remaining Extent of Boven Rugzeer 169

6

Boven Solar PV3

Remaining Extent of Boven Rugzeer 169

7

Boven Solar PV4

Remaining Extent of Boven Rugzeer 169

Die voorgestelde projekte sal ge-evalueer word volgens die Nasionale Omgewingsbestuur Wet, 1998 (Wet No 107 van 1998) (NEMA) en die Omgewingsimpakstudie (OIS) Regulasies soos gepubliseer in Staatskennisgewing R982 in Staatskoerant No 38282 van 08 Desember 2014.

Vind asseblief aangeheg die volgende:

- Beskrywing van die projek (word na verwys as die "BID")
- Brief aan die Belanghebbende en Geïnteresseerde Partye (B&GP'e)
- Kommentaar en Registrasievorm

Die BID, wat dien as agtergrond van die projek, bevat 'n beskrywing van die projek, die gelyste aktiwiteite en is vir 30-dae beskikbaar vir oorsig en kommentaar teen 10 Oktober 2015. 'n Harde kopie van die bogenoemde dokumente is ook gestuur aan diegene vir wie ons posadresse het. Inligting van die projek is ook beskikbaar op die projekwebtuiste: [http://www.csir.co.za<http://www.csir.co.za/>/eia/MuliloSolar](http://www.csir.co.za/http://www.csir.co.za/>/eia/MuliloSolar)

Ons versoek graag dat alle kommentaar aan die WNNR Projekbestuurder (kontakbesonderhede onder aangedui) teen 10 Oktober 2015 verskaf word.

By voorbaat dankie,

Minnelise Levendal

CSIR - Environmental Management Services

Posbus 320, Stellenbosch, 7599

Tel: 021 888 2495/2661

Faks: 021 888 2693

Epos: mlevendal@csir.co.za<<mailto:mlevendal@csir.co.za>>

--

This message is subject to the CSIR's copyright terms and conditions, e-mail legal notice, and implemented Open Document Format (ODF) standard.

The full disclaimer details can be found at <http://www.csir.co.za/disclaimer.html>.

This message has been scanned for viruses and dangerous content by MailScanner<<http://www.mailscanner.info/>>, and is believed to be clean.

Please consider the environment before printing this email.

Disclaimer:

This message contains confidential information and is intended only for the individual named.

If you are not the named addressee you should not disseminate, distribute or copy this e-mail.

Please notify the sender immediately by e-mail if you have received this e-mail by mistake and delete this e-mail from your system. E-mail transmission cannot be guaranteed to be secure or without errors as information could be intercepted, corrupted, lost, destroyed, arrive late or incomplete, or contain viruses.

The sender therefore does not accept liability for any errors or omissions in the contents of this message, which arise as a result of e-mail transmission.

If verification is required please request a hard-copy version. The South African National Roads Agency SOC Ltd, PO Box 415, Pretoria, 0001, South Africa, Tel +27-(0)12 844 8000, www.nra.co.za<<http://www.nra.co.za>>.

This Disclaimer is deemed to form part of the content of this email in terms of Section 11 of the Electronic Communications and Transactions Act, 25 of 2002.

--

This message is subject to the CSIR's copyright terms and conditions, e-mail legal notice, and implemented Open Document Format (ODF) standard.

The full disclaimer details can be found at <http://www.csir.co.za/disclaimer.html>.

This message has been scanned for viruses and dangerous content by MailScanner, and is believed to be clean.

Please consider the environment before printing this email.



Scoping and Environmental Impact Assessment for the proposed Development of a 75 MW Solar Photovoltaic Facility (GEMSBOK SOLAR PV5) on Portion 8 of Gemsbok Bult Farm 120, north-east of Kenhardt, Northern Cape Province

EIA REPORT

APPENDIX H:

Agenda, Meeting Notes and Presentation of Pre-Application Meeting with DEA on 17 September 2015 to discuss the proposed seven Mulilo Solar Photovoltaic Facilities near Kenhardt in the Northern Cape.

AGENDA



PRE-APPLICATION MEETING FOR THE PROPOSED MULILO AND SCATECH SOLAR PHOTOVOLTAIC (PV) PROJECTS NEAR KENHARDT IN THE NORTHERN CAPE

DEA offices: Environment House, 473 Steve Biko, Arcadia, Pretoria

17 September 2015

11H00-13H00

Purpose of meeting:

This meeting constitutes the Pre-Application Meeting with DEA to discuss the Environmental Impact Assessments (EIAs) for the proposed Mulilo and Scatech Solar PV projects that are currently being undertaken by CSIR. The meeting is to confirm the proposed EIA processes, i.e. the Applications for Environmental Authorisation, Approaches to the Public Participation Process-, Scoping- and EIA Process, EIA Schedules and the Requirements of the Scoping and EIA processes.

Topic	Responsibility	Time
1. Welcome and Introductions	DEA (Mr Muhammad Essop/ Mr Coenrad Agenbach)	11:00 – 11:10
2. Overview of the Mulilo and Scatech PV solar projects near Kenhardt: <ul style="list-style-type: none"> • Background and location • Proposed EIA Approaches • Proposed Schedules • Current status of the projects 	CSIR (Ms Surina Laurie and Ms Minnelise Levendal)	11:10 – 11:30
3. Questions and Discussion regarding Point 2. <ul style="list-style-type: none"> • Confirmation of EIA Approaches • Confirmation of Schedules 	All	11:30 – 12:00
4. Questions and Discussion regarding the requirements of the Scoping and EIA processes, e.g: - <ul style="list-style-type: none"> • Application • Scoping requirements • EIA requirements • Alternatives • Public Participation Process 	All	12:00 – 12:45
5. Way forward and Closure	DEA (Mr Muhammad Essop/ Mr Coenrad Agenbach)	12:45 – 13:00

MEETING NOTES



MINUTES

MEETING NOTES FROM PRE-APPLICATION MEETING WITH DEA TO DISCUSS THE PROPOSED MULILO AND SCATEC SOLAR PHOTOVOLTAIC PROJECTS NEAR KENHARDT IN THE NORTHERN CAPE

17 September 2015, 11H00-13H00, DEA Office, Environment House, Pretoria

Attendance:

Name	Organisation
Herman Alberts (HA)	DEA
Mmamohale Kabasa (MK)	DEA
Minnelise Levendal (ML)	CSIR
Surina Laurie (SL)	CSIR

Apologies: Muhammad Essop (ME) (DEA) and Coenrad Agenbach (CA) (DEA) could not attend the meeting as they had to attend an internal strategy workshop.

Purpose of the meeting:

Pre-Application Meeting with DEA was requested to discuss the Environmental Impact Assessments (EIAs) for the proposed Mulilo and Scatec Solar Photovoltaic (PV projects), near Kenhardt in the Northern Cape, that are currently being undertaken by CSIR. The main aims are to discuss the EIA processes, i.e. the Applications for Environmental Authorisation, Approaches to the Public Participation Process, Scoping and EIA Processes, EIA Schedules and the Requirements of the Scoping and EIA processes under the 2014 NEMA EIA Regulations.

1. Welcome and introductions

HA welcomed all participants to the meeting. The participants introduced themselves.

2. Overview of the Scatec and Mulilo Solar Photovoltaic Projects

SL and ML presented an overview of the proposed projects (see Appendix 1 for the full presentation):

- **Scatec Solar Photovoltaic (PV) Facilities near Kenhardt in the Northern Cape:**
 - Three Solar PV facilities of 75 MW each are proposed and three alternative sites.

- Proposed Scoping and EIA Approach - Three separate Applications, three separate Scoping Reports and three separate EIA Reports will be prepared and submitted to DEA for decision-making. In addition to this, 3 separate Basic Assessment (BA) Reports for the electrical infrastructure will be prepared and submitted to DEA for decision-making.
- One Integrated Public Participation Process (PPP) will be followed.
- **Mulilo Solar PV Facilities near Kenhardt in the Northern Cape**
 - Seven Solar PV facilities of 75 MW each are proposed and seven alternative sites.
 - Proposed Scoping and EIA Approach – Seven separate Applications, One Integrated Scoping Report and seven separate EIA Reports will be prepared and submitted to DEA for decision-making.
 - One Integrated Public Participation Process (PPP) will be followed.
 - The Mulilo projects will be located within the same geographical area and the sites have the same environmental conditions or attributes. It is therefore proposed that one integrated Scoping Report be prepared and submitted to DEA for all seven projects. A similar approach was followed by CSIR for the Kentani Solar PV Project near Dealesville in the Free State which comprised 12 projects. Twelve Applications for Environmental Authorisation (EA) were submitted, one integrated Scoping Report was prepared and submitted and 12 different EIA reports were submitted to DEA for decision-making. This approach was accepted by DEA. A similar approach is therefore proposed for the seven Mulilo Solar PV Facilities near Kenhardt in the Northern Cape.

Background on the proposed Mulilo project:

- Mulilo is also undertaking another solar energy project, i.e. the Mulilo Nieuwehoop Solar Development ("Phase 1") comprising three projects. The Final EIA Reports have been submitted to the DEA in March 2015 for decision-making. These reports are currently being reviewed by the DEA and the outcomes of the applications are pending.
- The project under discussion for this meeting is the Mulilo "Phase 2" Nieuwehoop Solar Development which will occur directly adjacent to the Scatec project and on the same properties as the Mulilo Phase 1 project.

It should be noted that both projects (i.e. the Scatec and Mulilo Phase 2 Solar PV Projects) aim to have an Environmental Decision on the EA Applications by August/September 2016 to qualify for the Integrated Power Producer Procurement bidding window in 2016.

3. Key Questions and Discussion

CSIR question	DEA response	Action
<p>Is the Scatec proposal to produce 3 separate Applications, 3 separate Scoping-, 3 separate EIA and 3 separate BA Reports but undertaking an integrated PPP acceptable?</p> <p>This would mean that there are still ultimately 6 EA decisions that would be issued by DEA.</p>	<p>Proposal for Scatec process/approach (i.e. to undertake separate processes for all the applications) is acceptable</p>	<p>CSIR to proceed with the proposed approach to submit 6 separate Applications, 3 separate BA Reports, 3 separate Scoping- and 3 separate EIA Reports, but to undertake one integrated PPP.</p>
<p>Is the Mulilo proposal to produce 7 separate EA Applications, an integrated Scoping Report, 7 separate EIA reports but undertaking an integrated PPP acceptable?</p> <p>This would mean that there are still ultimately 7 EA Decisions that would be issued by DEA.</p>	<p>HA indicated that it will be easier to review separate Scoping Reports for administrative reasons. HA further indicated that the 7 Applications may be assigned to more than one case officer.</p> <p>Recommendation from CSIR: Can we produce and submit one integrated Scoping Report, but provide DEA with multiple copies of the report for reviewing purposes?</p> <p>HA and MK propose to clarify this issue with ME and CA. They advised CSIR to email this query to DEA.</p>	<p>CSIR to send email to DEA (HA) requesting confirmation on the question.</p> <p>HA to discuss this question with ME and CA and provide feedback to CSIR.</p> <p>Feedback from ME and CA following the Pre-Application Meeting on the recommendation from CSIR to prepare one Integrated Scoping Report, but provide multiple copies of the report to DEA for reviewing purposes.No. Seven separate applications must be submitted. This must be followed by 7 separate Scoping Reports and 7 separate EIA Reports. Specialist studies must be included in the Scoping Report and this must be site specific.</p> <p>Note that the Scoping Report is either accepted or the Application for EA is refused. This has implications for all 7 applications if 1 scoping report is submitted.</p>
<p>Is it acceptable to release Scoping Report for comment (30 days) prior to submitting the Application for EA to DEA? Can the Application for EA and Scoping Report be submitted simultaneously to DEA after commenting period?</p>	<p>This approach is acceptable.</p> <p>-30 day PPP can be done prior to submitting the Application for EA to DEA.</p> <p>-It is advisable to do most of the work upfront to meet the strict timeframes.</p>	

CSIR question	DEA response	Action
	<p>-DEA will comment on the Draft Scoping Report within the prescribed timeframe. Provided that an application has been submitted to the DEA.</p> <p>-Once the EA Application is submitted, the EAP has 44 days to submit the draft Scoping Report that has been subjected to Public Participation for at least 30 days. Within that timeframe there is a 30-day period for DEA to review and comment on the Draft Scoping Report, leaving 14 days for EAP to submit Final Scoping Report incorporating/addressing comments from DEA.</p> <p>- It is however important to note that EAP should not submit Scoping Report to DEA without an Application Form, otherwise it will not be processed.</p>	
<p>What level of detail is required in the site assessment matrix and the assessment of alternatives that need to be included in the Scoping Report under the new 20104 NEMA EIA Regulations? How do we screen alternatives in the Scoping Phase as it was normally assessed by the specialists in the EIA Phase under the 2010 EIA Regulations.</p>	<p>EAP can list advantages and disadvantages of the alternatives to identify the most feasible or preferred alternative/s in the Scoping Phase. EAP can assess alternatives in Scoping Report and motivate for the most preferred alternative/s to be taken forward into the EIA phase. The specialists to undertake assessments of the <u>preferred alternative/s</u> in EIA phase of the project.</p> <p>Ideally the EAP needs to scope out all possible alternatives during the Scoping Phase and only take forward preferred alternatives in the EIA phase. DEA may authorise any of the alternative/s assessed in the EIA, therefore it is imperative that only reasonable and feasible alternatives be taken forward into the EIA Phase.</p>	<p>Feedback from ME and CA following the Pre-Application Meeting:</p> <p>Specialist studies to be included with the Scoping Report.</p>
<p>If Scoping Report is refused, do you re-start the whole Application Process (i.e. paying the application fee, undertaking the PPP again?)</p>	<p>The Scoping Report is either accepted or the Application for EA is refused.</p> <p>Upon receipt of the Scoping Report DEA will acknowledge receipt and will comment on the Scoping Report (e.g. request any outstanding information).</p>	

CSIR question	DEA response	Action
	Should the Application for EA be refused, the Applicant will need to wait for the appeals process to conclude and can then re-apply including payment, undertake the PPP again. An amended Scoping Report must be submitted to DEA addressing all initial issues.	
Scatec proposes to make use of borrow pits, thus they require a mining permit. Is the Department of Mineral Resources (DMR) the Competent Authority to approve this activity or can this listed activity be approved by DEA as part of the EIA process?	HA and MK propose to clarify this issue with ME and CA. They advised CSIR to email this query to DEA.	<p>CSIR to send email to DEA (HA) requesting confirmation on the question.</p> <p>HA to discuss this question with ME and CA and provide feedback to CSIR.</p> <p>Feedback from DEA following the Pre-Application Meeting:</p> <p>Please note that the DMR is the CA to approve the activity relating to the borrow pits.</p>
<p>Can one Application for EA be split into separate Environmental Authorisations? The CSIR is of the opinion that Regulation 25 (2) of the NEMA EIA Regulations makes provision for the Competent Authority to issue a single or multiple Environmental Authorisations in terms of an Application.</p> <p>The CSIR would like to understand under what scenarios can this provision in the Regulations be implemented.</p>	<p>DEA to confirm whether this interpretation is correct, and if not provide the correct interpretation to clarify how this regulation can be applied.</p> <p>HA and MK propose to clarify this issue with ME and CA. They advised CSIR to email this query to DEA.</p>	<p>CSIR to send email to DEA (HA) requesting confirmation on the question.</p> <p>HA to discuss this question with ME and CA and provide feedback to CSIR.</p> <p>Feedback from ME and CA following the Pre-Application Meeting:</p> <p>This applies to projects previously approved.</p>
Regulation 21 (1) states that if a S&EIR must be applied to an application, the applicant must, within 44 days of receipt of the application by the CA, submit to the CA a Scoping Report which has been subjected to a PPP of at least 30 days and which reflects the incorporation of comments received, including any comments from the CA. What is the best way to reflect	This approach is acceptable. It must be noted that all questions and issues raised during the PPP must be addressed and included in the Report prior to submission of the Report to DEA.	

CSIR question	DEA response	Action
<p>the comments received in the Scoping Report that will be submitted to the DEA? If there are no substantial comments requiring amendments to the report, then can a separate appendix be compiled, noting all the comments received during the 30-day review of the Consultation Scoping Report and appropriate responses from the EAP. The appendix will also note the PPP undertaken for the release of the Consultation Scoping Report. This separate appendix will then be submitted to the DEA with the Scoping Report for decision-making. It is planned to only provide copies of this appendix and Scoping Report to the DEA (and not to I&APs via courier or library).</p>		

- **Recommendations from DEA on the EIA process following queries from CSIR:**
 - CSIR to submit separate EA Applications for each project.
 - Make sure that you have all the information before starting with the EIA process.
 - If timeframes under the 2014 NEMA EIA Regulations are not met, the Application will lapse and a new Application for EA would need to be submitted.
 - Letters should be distributed to Interested and Affected Parties (I&APs) via registered mail.
 - The commenting period starts on the date that the Application or Report is received by DEA. CSIR does not have to wait for a letter of acknowledgement of receipt. DEA will try to email the letter of acknowledgement to the EAP and Applicant on the same day of receipt or the following day, but delays may occur.
 - 2010 NEMA EIA Regulations allowed possibility of downgrading of EIA to BA with motivation. There is no provision for this under the 2014 NEMA EIA Regulations.
 - Environmental Authorisation issued under the 2010 NEMA Regulations will follow Appeal Process prescribed under the 2010 NEMA Regulations.
 - Background Information of project desirability should be project specific and avoid generalising to South Africa.
 - DEA advises that the necessary specialist studies be undertaken (e.g. Radio Frequency Interference (RFI) as the projects are located in close proximity to the Square Kilometre Array (SKA) Project.
 - DEA encourages that most of the work should be done upfront to adhere to timeframes.
 - Pre-Application Meetings are useful and assist undertaking efficient Application process.
 - CSIR to send Scoping and EIA Reports to DEA Biodiversity Directorate for comment.
 - DEA will provide comments on the Scoping Report. CSIR to take these comments into consideration when preparing the final Scoping Report or EIA Report. CSIR can motivate if comments are not relevant to specific project.
 - Applicant to make sure that only reasonable and feasible project developments are presented in the EIA Report. DEA may approve any one of these options, and not necessarily the preferred alternative proposed by the EAP or Applicant.

4. Way forward and Closure

- ML to draft an email to HA and MK (and copy ME and CA) to seek clarity on issues that could not be finalised at the meeting. HA and MK will then discuss these issues further with ME and CA and provide feedback to CSIR.
- ML and SL to draft the meeting notes and send to DEA for approval and sign-off.
- HA re-iterated that CSIR should not hesitate to contact or request meetings with the DEA case officer/s if they have queries regarding the EIA processes.
- The meeting notes must be included in the Scoping and EIA Reports.

ML and SL thanked DEA for the opportunity to meet with them and for providing feedback on the queries relating to the Scoping and EIA approaches and processes currently being undertaken by CSIR under the 2014 NEMA EIA Regulations for the proposed Mulilo and Scatec Solar PV Facilities near Kenhardt in the Northern Cape.

THE MEETING ADJOURNED AT 12H30.

PRESENTATION

CELEBRATING
70 Years
Ideas that work

CSIR
our future through science

**PRE-APPLICATION MEETING WITH
DEA ON MULILO AND SCATEC SOLAR
EIAs FOR SOLAR PV PROJECTS
NEAR KENHARDT IN NORHTERN
CAPE PROVINCE**

17 September 2015

MULILO “PHASE 2” SOLAR DEVELOPMENT

- **MULILO SOLAR PV PROJECTS**
 - **Seven Solar PV projects**

	Solar PV Project	Project Site
1.	Gemsbok Solar PV3	Portion 3 of Gemsbok Bult 120 Farm
2.	Gemsbok Solar PV4	Portion 3 of Gemsbok Bult 120 Farm
3.	Gemsbok Solar PV5	Portion 8 of Gemsbok Bult 120 Farm
4.	Gemsbok Solar PV6	Portion 8 of Gemsbok Bult 120 Farm
5.	Boven Solar PV2	Remaining Extent of Boven Rugzeer 169
6.	Boven Solar PV3	Remaining Extent of Boven Rugzeer 169
7.	Boven Solar Pv4	Remaining Extent of Boven Rugzeer 169

MULILO PROJECT & ALTERNATIVE SITES

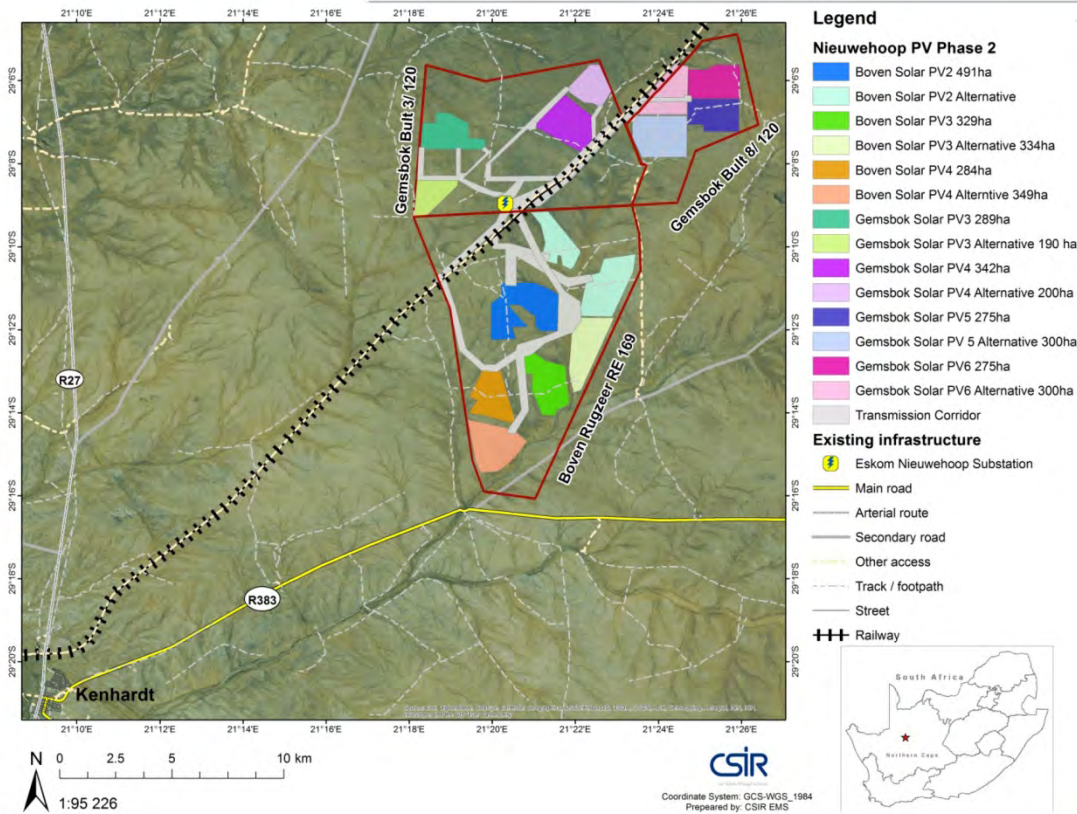

MULILO EIA PROCESSES

- Seven (7) EIA Applications
- One Integrated Public Participation Process
- One Integrated Scoping Report
- Seven EIA Reports
- Seven Environmental Decisions

Key Questions

- **Confirmation of Scatec Solar and Mulilo EIA Processes/Approaches**
- **Can PPP for Scoping Report (30 days) be undertaken before submission of Applications for EA?**
- **Should alternatives be screened out during Scoping Phase? What about specialist studies and assessments that are only done in EIA Phase?**
- **Regulation 25 of the Regulations – multiple authorisations**



FURTHER QUESTIONS AND DISCUSSION

THANK YOU!

Minnelise Levendal (mlevendal@csir.co.za)

Surina Laurie (slaurie@csir.co.za)





Scoping and Environmental Impact Assessment for the proposed Development of a 75 MW Solar Photovoltaic Facility (GEMSBOK SOLAR PV5) on Portion 8 of Gemsbok Bult Farm
120, north-east of Kenhardt, Northern Cape Province

EIA REPORT

APPENDIX I:

Maps and Title Deeds



CONTENTS

APPENDIX I.1 COMBINED LAYOUT AND SENSITIVITY MAP	1
APPENDIX I.1 COMBINED LAYOUT AND SENSITIVITY MAP (INCLUDING POWERLINE)	2
APPENDIX I.2 TITLE DEEDS	3

APPENDIX I.1 COMBINED LAYOUT AND SENSITIVITY MAP

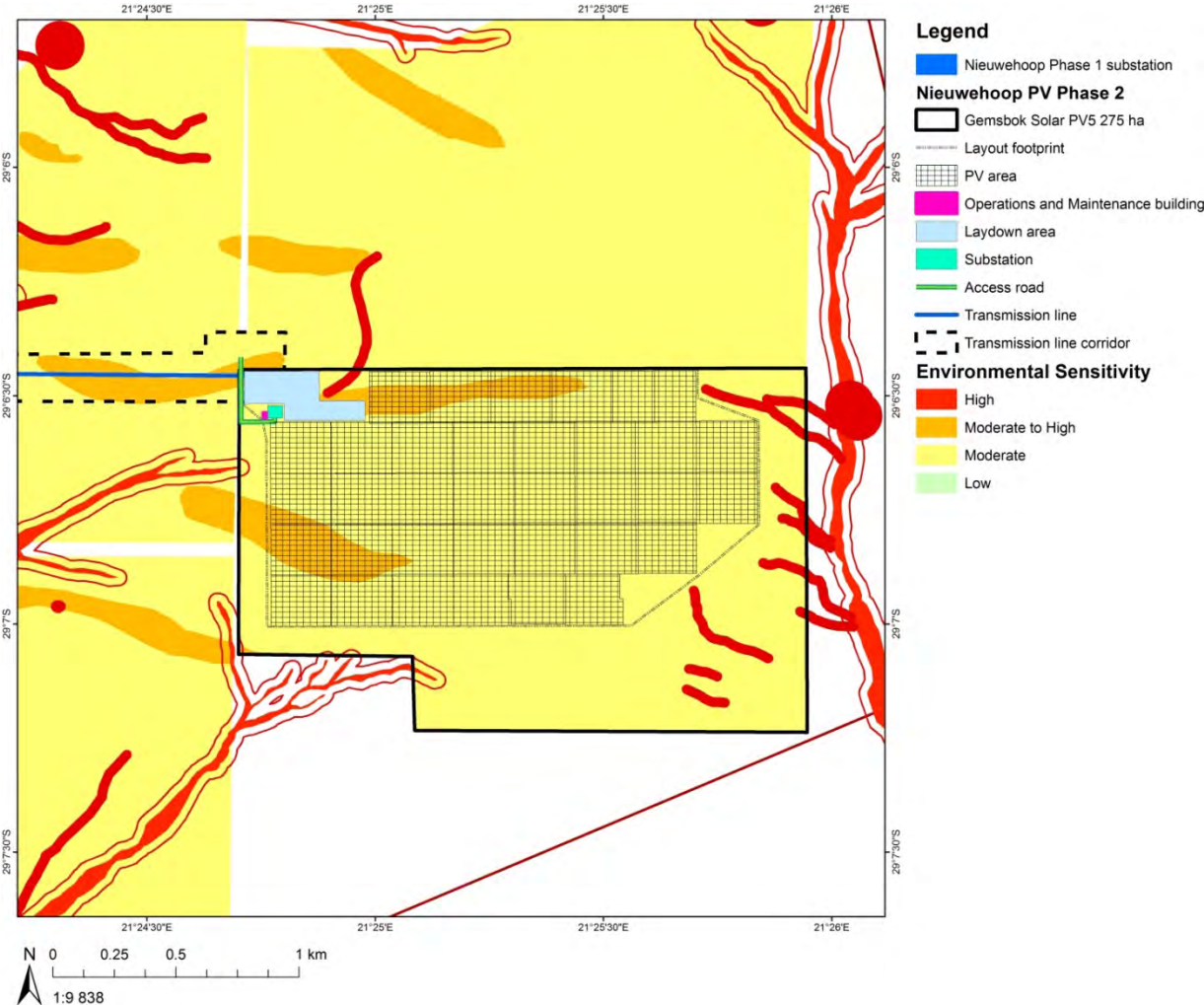

APPENDIX I.1 COMBINED LAYOUT AND SENSITIVITY MAP (INCLUDING POWERLINE)

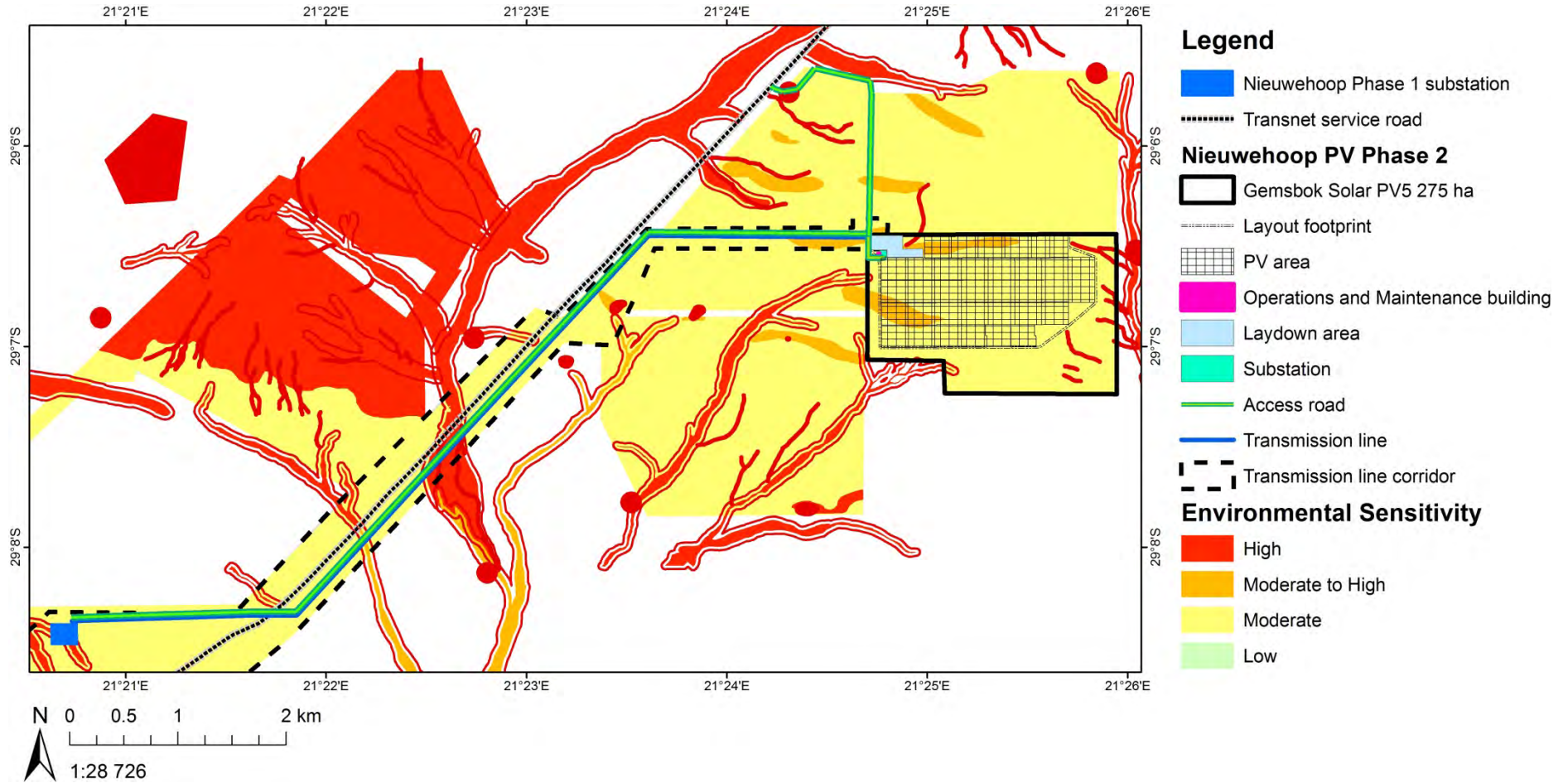

APPENDIX I.2 TITLE DEEDS

DeedsWeb

Page 1 of 2

Property Enquiry Details

 **Property enquiry results for "KENHARDT, 120" in the Deeds Registry at "CAPE TOWN"**

Property detail:

Deeds registry	CAPE TOWN
Property type	FARM
Farm name	GEMSBOK BULT
Farm number	120
Portion	8 (REMAINING EXTENT)
Province	NORTHERN CAPE
Registration division/Administrative district	KENHARDT RD
Local authority	KENHARDT DC
Previous description	PTN OF 3-ROOIDAM (*4214,4340M)
Diagram deed number	T3205/1935
Extent	2704.0658 H
LPI Code	C03600000000012000008

Title Deeds detail:

Document	Registration date	Purchase date	Amount	Image Scanned reference	Document copy?
T102836/1999	19991222	19990930	R1120127.00	20130315 09:37:39	Yes

Owners detail:

Document	Full name	Identity Number	Share	Person Enquiry?
T102836/1999	KAMKUIP BOERDERY PTY LTD	197800257407	-	Yes

Endorsements / Encumbrances:

Endorsement / Encumbrance	Holder	Amount	Image Scanned reference	Document copy?
B15323/2009	LAND & LANDBOU ONTWIKKELINGSBANK VAN SUID AFRIKA	R5859000.00	20130315 09:37:59	Yes
B30278/2010	LAND & LANDBOU ONTWIKKELINGSBANK VAN SUID AFRIKA	R5000000.00	20130408 16:02:39	Yes

<http://www.deeds.gov.za/TSODeedsWebB/deedsweb/propp farm results.jsp?office=...> 14/03/2014

DeedsWeb

Page 2 of 2

B58438/1999	LAND & LANDBOUBANK VAN SUID-AFRIKA	R500000.00	20130315 09:38:20	<u>Yes</u>
FARM KE 120/8	-	-	1985 0041 1245	<u>Yes</u>

History:

Document	Holder	Amount	Microfilm reference	Document copy?
B55372/1991	LANDBANK	-	2000 0049 3843	<u>Yes</u>
T11780/1965	ESTERHUIZEN JASPER JACOBUS	-	1991 0551 2025	<u>Yes</u>
T19001/1991	CONNAN DONALD	R672977.00	2000 0049 3813	<u>Yes</u>

[Back to top of page](#)

Requested by 18487 with user reference EMM on: Friday, 14 March 114 11:33

DeedsWeb Version 4.0.1

Copyright © 2001-2009, Chief Registrar of Deeds

http://www.deeds.gov.za/ITSDeedsWebR/deedsweb/propd_farm_results.jsp?office=... 14/03/2014



Scoping and Environmental Impact Assessment for the proposed Development of a 75 MW Solar Photovoltaic Facility (GEMSBOK SOLAR PV5) on Portion 8 of Gemsbok Bult Farm 120, north-east of Kenhardt, Northern Cape Province

EIA REPORT

APPENDIX J:

Technical Report:
Cumulative Topographical
Analysis of Proposed PV
Projects in AGA Area



THE SCIENCE OF MEASUREMENT

Technical Report:

Cumulative Topographical Analysis of Proposed PV Projects in AGA Area

Work done for: Mulilo Renewable Project Developments (Pty) Ltd.



A. J. Otto and P. S. van der Merwe



Document Number: MUL/16/01/27

Revision Number: REV2

Document Date: 09 February 2016

This document contains proprietary information and may not be disclosed without the written consent of MESA Solutions (Pty) Ltd. or the client for whom it is intended.

Document Approval

	Name	Affiliation	Designation	Signature
Submitted	A. J. Otto	MESA Solutions	Managing Director	
	P. S. van der Merwe	MESA Solutions	Managing Director	

Accepted	Warren Morse	Mulilo	Director Solar	
-----------------	--------------	--------	----------------	--

Document History

Revision	Date of Issue	Comments
REV0	27 January 2016	Final Report Submission (MUL/16/01/27/REV0).
REV1	02 February 2016	Sites ranked according to average risk to SKA locations.
REV2	09 February 2016	Additional shielding required between preferred and alternative sites for Boven-PV2 and Gemsbok-PV5 included.

Company Details

Name	MESA Solutions (Pty) Ltd.
Physical Address	Aan-de-wagen Centre Aan-de-wagen Rd. Stellenbosch 7600
Tel.	+27(0)72 317 9784 / +27(0)82 494 6204
Website	http://www.mesasolutions.co.za/

Executive Summary

MESA Solutions was asked by *Mulilo Renewable Project Developments* to do a topographical analysis of the terrain profiles between the various photovoltaic (PV) project locations in the Astronomy Geographic Advantage (AGA) area and the closest and core-site SKA telescopes. A total of ten *Mulilo* sites (*Boven PV1 to PV4*; *Gemsbok PV1 to PV6*) and three *Scatec Solar* sites (*Kenhardt PV1 to PV3*) considered in this cumulative assessment.

Propagation Analysis

A preferred and alternative site location was included for the Mulilo developments in terms of the total path loss to the SKA receivers. The recommended site locations based on the total path loss calculated are summarised below. In the event where the alternative site is recommended, the maximum difference in total path loss for the preferred site is indicated.

Site Location	Closest Telescope 1	Closest Telescope 2	SKA Core Site	Recommendation	Max. TPL Difference
Boven PV 2 Preferred	X	X	X	X	28.39 dB
Boven PV 2 Alternative	✓	✓	✓	✓	
Boven PV 3 Preferred	X	✓	~	✓	N/A
Boven PV 3 Alternative	✓	X	~	X	
Boven PV 4 Preferred	~	~	~	~	N/A
Boven PV 4 Alternative	~	~	~	~	
Gemsbok PV 3 Preferred	✓	✓	X	✓	N/A
Gemsbok PV 3 Alternative	X	X	✓	X	
Gemsbok PV 4 Preferred	~	~	~	~	N/A
Gemsbok PV 4 Alternative	~	~	~	~	
Gemsbok PV 5 Preferred	X	X	X	X	30.21 dB
Gemsbok PV 5 Alternative	✓	✓	✓	✓	
Gemsbok PV 6 Preferred	~	~	~	~	N/A
Gemsbok PV 6 Alternative	~	~	~	~	

Summary of preferred and alternate site locations based on predicted total path loss. Legend: ✓: Recommended; ~: Neutral; X: Not Recommended; N/A: Not Applicable (i.e. Preferred site is the recommended site).

Using the above recommended site locations, this study attempts to define an E-field upper limit as a function of frequency at which the plants are allowed to radiate without exceeding emission limits (SARAS protection and receiver saturation limits) at the various SKA telescope locations. The conformance of the plant can be determined by comparing representative measured results to the calculated levels provided.

From the results it is shown that:

- Radiated emissions at levels below that of CISPR 11/22 Class B are required (especially in the case of the closest telescope).
- Negligible terrain loss exists between majority of sites and closest SKA telescope.

- Predictions for the maximum allowed E-field level, as measured according to CISPR 11/22 Class B, are given below.

Maximum Allowed Radiation Levels to Meet SKA Protection Threshold (SARAS) - 10dB

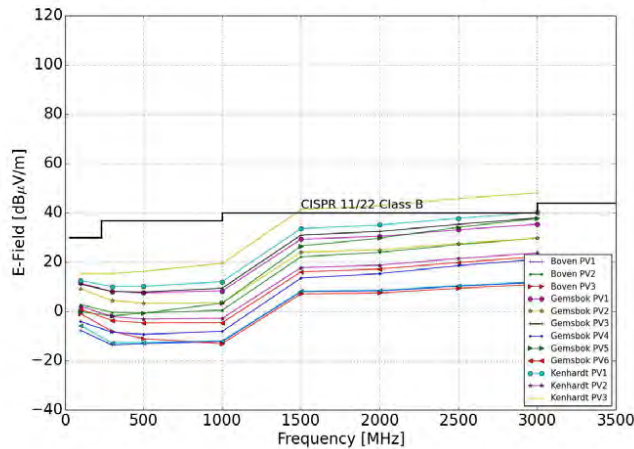

(a)

Maximum Allowed Radiation Levels to Meet SKA Protection Threshold (SARAS) - 10dB

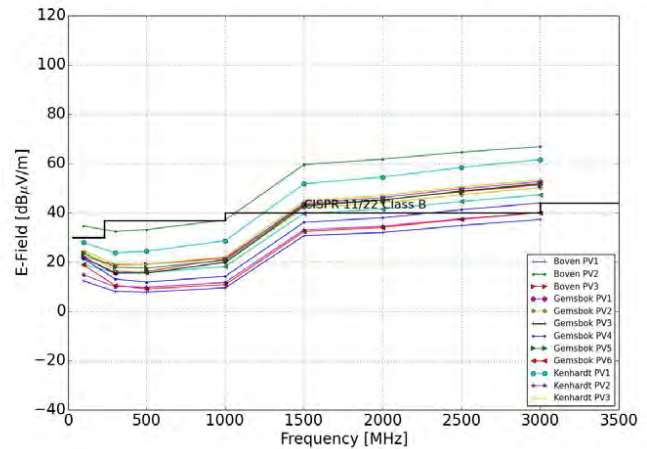

(b)

Maximum Allowed Radiation Levels to Meet SKA Protection Threshold (SARAS) - 10dB

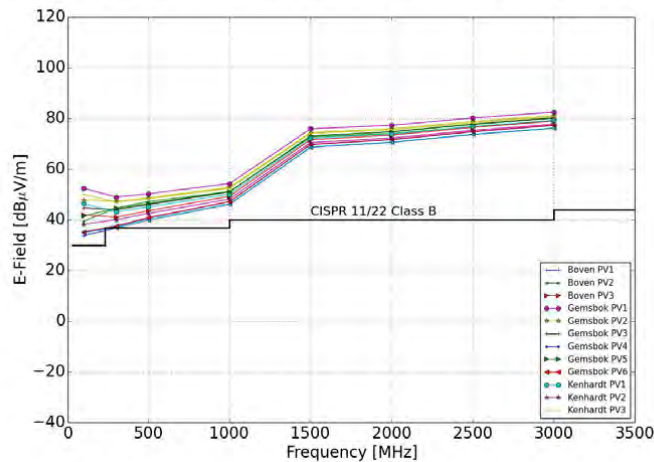

(c)

Maximum allowed measured E-Field (CISPR 22 Class B) to ensure levels are 10 dB below SARAS protection levels toward: (a) Closest SKA telescope; (b) Second closest SKA telescope; and (c) SKA core-site telescopes.

- Based on expected plant emission levels, mitigation measures will be required to comply to the SKA requirements. This is particularly relevant for the closest telescope where negligible terrain loss applies.

Mitigation Measures

It is strongly recommended that the following **mitigation practises** be incorporated into the plants design:

- The inverter units, transformers, communication and control units for an array of panels all be housed in a single shielded environment.
- For shielding of such an environment ensure:
 - RFI gasketting be placed on all seams and doors.
 - RFI Honeycomb filtering be placed on all ventilation openings.
- Cables to be laid directly in soil or properly grounded cable trays (not plastic sleeves).
- The use of bare copper directly in soil for earthing is recommended.
- Assuming a tracking PV plant design, care will have to be taken to shield the noise associated with the relays, contactors and motors of the tracking units.
- AC brushless motors to be used for tracking motors.
- Data communications to and from the plants to be via fibre optic.
- The developer has stated they are aware of these mitigation measures and the associated costs due to their experience in incorporating these recommendations in the current construction of 2 x 75MW solar plants near Copperton. They have included these mitigation costs, and an additional contingency facility in the event where additional mitigation is required, in the proposed PV projects budgets.

It is MESA’s expectations that, if the mitigation measures that are specified are implemented correctly, an improvement of between 20 and 40 dB in emission levels are likely. *It is important to note that these are purely predicted values and cannot be guaranteed or confirmed until measurements on the post-mitigated operating plants (or representative installations) are performed. Furthermore, the findings from this assessment are for the client’s own edification, and will be taken into account by SKA-SA during their own propagation analysis. This study is therefore not meant to supersede any investigation done by SKA-SA or relevant RFI working groups. It remains the responsibility of the developer to meet compliance to the SKA requirements, and MESA Solutions cannot accept responsibility for any assessments made in this report which could cause non-compliance.*

An initial risk assessment for each telescope location was determined by comparing the maximum allowable radiation limit of each plant to the CISPR standard at discrete frequencies. The three resulting risk tables were then used to calculate each plant’s average risk factor for all three locations combined. The ranking of the plants, as well as the cumulative impact of constructing all the plants up to a specific ranking, are given in the tables below. The cumulative impact is in addition to any existing RFI from the plant.

Risk	Ranking	Closest Telescope 1	Closest Telescope 2	SKA Core Site
Lowest Risk	1	Boven PV1	Boven PV1	Boven PV1
	2	Boven PV4	Scatec PV2	Boven PV4
	3	Boven PV3	Gemsbok PV6	Gemsbok PV4
	4	Gemsbok PV4	Gemsbok PV4	Gemsbok PV6
	5	Gemsbok PV6	Boven PV4	Scatec PV2
	6	Scatec PV2	Gemsbok PV2	Boven PV3
	7	Boven PV2 Alt	Gemsbok PV3	Boven PV2 Alt
	8	Gemsbok PV2	Gemsbok PV1	Scatec PV1
	9	Gemsbok PV5 Alt	Gemsbok PV5 Alt	Gemsbok PV5 Alt
	10	Gemsbok PV1	Boven PV3	Gemsbok PV3
	11	Gemsbok PV3	Scatec PV3	Scatec PV3
	12	Scatec PV1	Scatec PV1	Gemsbok PV2
Highest Risk	13	Scatec PV3	Boven PV2 Alt	Gemsbok PV1

Site locations sorted according to risk to the closest, second closest and core-site SKA telescopes.

Risk	Ranking	Average Risk	Cumulative Impact
Lowest Risk	1	Boven PV1	0.00 dB
	2	Boven PV4	3.01 dB
	3	Gemsbok PV6	4.77 dB
	4	Gemsbok PV4	6.02 dB
	5	Scatec PV2	6.99 dB
	6	Boven PV3	7.78 dB
	7	Gemsbok PV5 Alt	8.45 dB
	8	Gemsbok PV2	9.03 dB
	9	Gemsbok PV3	9.54 dB
	10	Gemsbok PV1	10.0 dB
	11	Boven PV2 Alt	10.4 dB
	12	Scatec PV1	10.8 dB
Highest Risk	13	Scatec PV3	11.1 dB

Site locations sorted according to the average risk to SKA telescopes. Included is the cumulative effect if any given plant, together with the higher ranked plants, are constructed together. (For example: if sites ranked 1 to 7 are constructed, a cumulative effect of 8.45 dB is assumed; if sites ranked 1 to 10 are constructed, a cumulative effect of 10.0 dB is assumed.)

Contents

Executive Summary	2
Nomenclature	9
1 Introduction	16
2 Site Location Data	18
2.1 Boven PV1	18
2.2 Boven PV2	19
2.3 Boven PV3	20
2.4 Boven PV4	21
2.5 Gemsbok PV1	22
2.6 Gemsbok PV2	23
2.7 Gemsbok PV3	24
2.8 Gemsbok PV4	26
2.9 Gemsbok PV5	27
2.10 Gemsbok PV6	28
2.11 Scatec PV1, PV2 and PV3	29
3 Signal Propagation Loss and Terrain Analysis	31
4 Total Path Loss	32
4.1 Boven PV1 Site Location	32
4.2 Boven PV2 Site Location	34
4.2.1 Boven PV2 Preferred Site Location	34
4.2.2 Boven PV2 Alternative Site Location	34
4.3 Boven PV3 Site Location	37
4.3.1 Boven PV3 Preferred Site Location	37
4.3.2 Boven PV3 Alternative Site Location	37
4.4 Boven PV4 Site Location	40
4.4.1 Boven PV4 Preferred Site Location	40
4.4.2 Boven PV4 Alternative Site Location	40
4.5 Gemsbok PV1 Site Location	43
4.6 Gemsbok PV2 Site Location	43
4.7 Gemsbok PV3 Site Location	46
4.7.1 Gemsbok PV3 Preferred Site Location	46
4.7.2 Gemsbok PV3 Alternative Site Location	46
4.8 Gemsbok PV4 Site Location	49
4.8.1 Gemsbok PV4 Preferred Site Location	49
4.8.2 Gemsbok PV4 Alternative Site Location	49
4.9 Gemsbok PV5 Site Location	52
4.9.1 Gemsbok PV5 Preferred Site Location	52
4.9.2 Gemsbok PV5 Alternative Site Location	52
4.10 Gemsbok PV6 Site Location	55
4.10.1 Gemsbok PV6 Preferred Site Location	55
4.10.2 Gemsbok PV6 Alternative Site Location	55
4.11 Scatec PV 1 Site Location	58
4.12 Scatec PV 2 Site Location	58
4.13 Scatec PV 3 Site Location	61
5 Preferred vs. Alternative Site Locations Based on TPL	62

6	SKA Threshold Limits	64
6.1	Cumulative Impact Assessment	64
6.2	Maximum Allowed Radiation Levels	65
6.2.1	Closest SKA Telescope	65
6.2.2	2nd Closest SKA Telescope	66
6.2.3	Core SKA Telescopes	67
7	Plant Design Overview	68
7.1	Expected Sources of Interference	68
7.2	Mitigating Measures	68
7.3	Expected RFI Reductions due to Mitigation Measures	69
8	Conclusions	70
A	Fresnel Zones and Line of Sight	72
A.1	Boven PV1 to Closest SKA	72
A.2	Boven PV1 to 2nd Closest SKA	73
A.3	Boven PV1 to Core SKA	74
A.4	Boven PV2 to Closest SKA	75
A.5	Boven PV2 to 2nd Closest SKA	76
A.6	Boven PV2 to Core SKA	77
A.7	Boven PV2 Alternative to Closest SKA	78
A.8	Boven PV2 Alternative to 2nd Closest SKA	79
A.9	Boven PV2 Alternative to Core SKA	80
A.10	Boven PV3 to Closest SKA	81
A.11	Boven PV3 to 2nd Closest SKA	82
A.12	Boven PV3 to Core SKA	83
A.13	Boven PV3 Alternative to Closest SKA	84
A.14	Boven PV3 Alternative to 2nd Closest SKA	85
A.15	Boven PV3 Alternative to Core SKA	86
A.16	Boven PV4 to Closest SKA	87
A.17	Boven PV4 to 2nd Closest SKA	88
A.18	Boven PV4 to Core SKA	89
A.19	Boven PV4 Alternative to Closest SKA	90
A.20	Boven PV4 Alternative to 2nd Closest SKA	91
A.21	Boven PV4 Alternative to Core SKA	92
A.22	Gemsbok PV1 to Closest SKA	93
A.23	Gemsbok PV1 to 2nd Closest SKA	94
A.24	Gemsbok PV1 to Core SKA	95
A.25	Gemsbok PV2 to Closest SKA	96
A.26	Gemsbok PV2 to 2nd Closest SKA	97
A.27	Gemsbok PV2 to Core SKA	98
A.28	Gemsbok PV3 to Closest SKA	99
A.29	Gemsbok PV3 to 2nd Closest SKA	100
A.30	Gemsbok PV3 to Core SKA	101
A.31	Gemsbok PV3 Alternative to Closest SKA	102
A.32	Gemsbok PV3 Alternative to 2nd Closest SKA	103
A.33	Gemsbok PV3 Alternative to Core SKA	104
A.34	Gemsbok PV4 to Closest SKA	105
A.35	Gemsbok PV4 to 2nd Closest SKA	106
A.36	Gemsbok PV4 to Core SKA	107
A.37	Gemsbok PV4 Alternative to Closest SKA	108

A.38 Gembok PV4 Alternative to 2nd Closest SKA 109

A.39 Gembok PV4 Alternative to Core SKA 110

A.40 Gembok PV5 to Closest SKA 111

A.41 Gembok PV5 to 2nd Closest SKA 112

A.42 Gembok PV5 to Core SKA 113

A.43 Gembok PV5 Alternative to Closest SKA 114

A.44 Gembok PV5 Alternative to 2nd Closest SKA 115

A.45 Gembok PV5 Alternative to Core SKA 116

A.46 Gembok PV6 to Closest SKA 117

A.47 Gembok PV6 to 2nd Closest SKA 118

A.48 Gembok PV6 to Core SKA 119

A.49 Gembok PV6 Alternative to Closest SKA 120

A.50 Gembok PV6 Alternative to 2nd Closest SKA 121

A.51 Gembok PV6 Alternative to Core SKA 122

A.52 Scatec PV1 to Closest SKA 123

A.53 Scatec PV1 to 2nd Closest SKA 124

A.54 Scatec PV1 to Core SKA 125

A.55 Scatec PV2 to Closest SKA 126

A.56 Scatec PV2 to 2nd Closest SKA 127

A.57 Scatec PV2 to Core SKA 128

A.58 Scatec PV3 to Closest SKA 129

A.59 Scatec PV3 to 2nd Closest SKA 130

A.60 Scatec PV3 to Core SKA 131

Nomenclature

AGA	Astronomy Geographic Advantage
DEM	Digital Elevation Model
FSPL	Free Space Path Loss
ITM	Irregular Terrain Model
ITWOM	Irregular Terrain With Obstruction Model
KAT	Karoo Array Telescope
LOS	Line-of-Sight
PV	Photovoltaic
RFI	Radio Frequency Interference
RFI-WG	Radio Frequency Interference Working Group
SARAS	South African Radio Astronomy Services
SKA	Square Kilometre Array
SKA-SA	Square Kilometre Array South Africa
SPLAT	Signal Propagation, Loss And Terrain - Analysis Tool
TL	Terrain Loss
TPL	Total Path Loss

List of Figures

1	Google Earth terrain profile for Boven PV1 to (a) closest and (b) second closest and (c) core SKA telescopes.	18
2	Google Earth terrain profile for Boven PV2 to (a) closest and (b) second closest and (c) core SKA telescopes.	19
3	Google Earth terrain profile for Boven PV3 to (a) closest and (b) second closest and (c) core SKA telescopes.	20
4	Google Earth terrain profile for Boven PV4 to (a) closest and (b) second closest and (c) core SKA telescopes.	22
5	Google Earth terrain profile for Gemsbok PV1 to (a) closest and (b) second closest and (c) core SKA telescopes.	23
6	Google Earth terrain profile for Gemsbok PV2 to (a) closest and (b) second closest and (c) core SKA telescopes.	24
7	Google Earth terrain profile for Gemsbok PV3 to (a) closest and (b) second closest and (c) core SKA telescopes.	25
8	Google Earth terrain profile for Gemsbok PV4 to (a) closest and (b) second closest and (c) core SKA telescopes.	26
9	Google Earth terrain profile for Gemsbok PV5 to (a) closest and (b) second closest and (c) core SKA telescopes.	27
10	Google Earth terrain profile for Gemsbok PV6 to (a) closest and (b) second closest and (c) core SKA telescopes.	29
11	Google Earth terrain profile for Scatec PV1 to PV3 to (a) closest and (b) second closest and (c) core SKA telescopes.	30
12	TPL attenuation maps for site location of Boven PV1 to the closest and core SKA telescopes for (a) 100 MHz (b) 1000 MHz (c) 2000 MHz and (d) 3000 MHz.	33
13	TPL attenuation maps for preferred site location of Boven PV2 to the closest and core SKA telescopes for (a) 100 MHz (b) 1000 MHz (c) 2000 MHz and (d) 3000 MHz.	35
14	TPL attenuation maps for alternative site location of Boven PV2 to the closest and core SKA telescopes for (a) 100 MHz (b) 1000 MHz (c) 2000 MHz and (d) 3000 MHz.	36
15	TPL attenuation maps for preferred site location of Boven PV3 to the closest and core SKA telescopes for (a) 100 MHz (b) 1000 MHz (c) 2000 MHz and (d) 3000 MHz.	38
16	TPL attenuation maps for alternative site location of Boven PV3 to the closest and core SKA telescopes for (a) 100 MHz (b) 1000 MHz (c) 2000 MHz and (d) 3000 MHz.	39
17	TPL attenuation maps for preferred site location of Boven PV4 to the closest and core SKA telescopes for (a) 100 MHz (b) 1000 MHz (c) 2000 MHz and (d) 3000 MHz.	41
18	TPL attenuation maps for alternative site location of Boven PV4 to the closest and core SKA telescopes for (a) 100 MHz (b) 1000 MHz (c) 2000 MHz and (d) 3000 MHz.	42
19	TPL attenuation maps for site location of Gemsbok PV1 to the closest and core SKA telescopes for (a) 100 MHz (b) 1000 MHz (c) 2000 MHz and (d) 3000 MHz.	44
20	TPL attenuation maps for site location of Gemsbok PV2 to the closest and core SKA telescopes for (a) 100 MHz (b) 1000 MHz (c) 2000 MHz and (d) 3000 MHz.	45
21	TPL attenuation maps for preferred site location of Gemsbok PV3 to the closest and core SKA telescopes for (a) 100 MHz (b) 1000 MHz (c) 2000 MHz and (d) 3000 MHz.	47
22	TPL attenuation maps for alternative site location of Gemsbok PV3 to the closest and core SKA telescopes for (a) 100 MHz (b) 1000 MHz (c) 2000 MHz and (d) 3000 MHz.	48
23	TPL attenuation maps for preferred site location of Gemsbok PV4 to the closest and core SKA telescopes for (a) 100 MHz (b) 1000 MHz (c) 2000 MHz and (d) 3000 MHz.	50
24	TPL attenuation maps for alternative site location of Gemsbok PV4 to the closest and core SKA telescopes for (a) 100 MHz (b) 1000 MHz (c) 2000 MHz and (d) 3000 MHz.	51
25	TPL attenuation maps for preferred site location of Gemsbok PV5 to the closest and core SKA telescopes for (a) 100 MHz (b) 1000 MHz (c) 2000 MHz and (d) 3000 MHz.	53

26	TPL attenuation maps for alternative site location of Gembok PV5 to the closest and core SKA telescopes for (a) 100 MHz (b) 1000 MHz (c) 2000 MHz and (d) 3000 MHz.	54
27	TPL attenuation maps for preferred site location of Gembok PV6 to the closest and core SKA telescopes for (a) 100 MHz (b) 1000 MHz (c) 2000 MHz and (d) 3000 MHz.	56
28	TPL attenuation maps for alternative site location of Gembok PV6 to the closest and core SKA telescopes for (a) 100 MHz (b) 1000 MHz (c) 2000 MHz and (d) 3000 MHz.	57
29	TPL attenuation maps for site location of Scatec PV1 to the closest and core SKA telescopes for (a) 100 MHz (b) 1000 MHz (c) 2000 MHz and (d) 3000 MHz.	59
30	TPL attenuation maps for site location of Scatec PV2 to the closest and core SKA telescopes for (a) 100 MHz (b) 1000 MHz (c) 2000 MHz and (d) 3000 MHz.	60
31	TPL attenuation maps for site location of Scatec PV3 to the closest and core SKA telescopes for (a) 100 MHz (b) 1000 MHz (c) 2000 MHz and (d) 3000 MHz.	61
32	Closest SKA telescope receiver: (a) Maximum allowed EIRP to ensure levels are below the SKA saturation limit of -100 dBm at the telescope receiver; (b) Maximum allowed PSD to ensure levels are 10 dB below SARAS protection levels; (c) Maximum allowed measured E-Field (CISPR 22 Class B) to ensure levels are 10 dB below SARAS protection levels.	65
33	2nd closest SKA telescope receiver: (a) Maximum allowed EIRP to ensure levels are below the SKA saturation limit of -100 dBm at the telescope receiver; (b) Maximum allowed PSD to ensure levels are 10 dB below SARAS protection levels; (c) Maximum allowed measured E-Field (CISPR 22 Class B) to ensure levels are 10 dB below SARAS protection levels.	66
34	Core SKA telescope receivers: (a) Maximum allowed EIRP to ensure levels are below the SKA saturation limit of -100 dBm at the telescope receiver; (b) Maximum allowed PSD to ensure levels are 10 dB below SARAS protection levels; (c) Maximum allowed measured E-Field (CISPR 22 Class B) to ensure levels are 10 dB below SARAS protection levels.	67
35	Proposed single axis tracking system to be used for the proposed Mulilo PV projects.	69
36	Motors used in the single axis tracking system should be AC brushless.	69
37	Fresnel zone, LOS and 60% of first Fresnel zone for site location of Boven PV1 to the closest SKA telescope for (a) 100 MHz (b) 1000 MHz (c) 2000 MHz and (d) 3000 MHz.	72
38	Fresnel zone, LOS and 60% of first Fresnel zone for site location of Boven PV1 to the second closest SKA telescope for (a) 100 MHz (b) 1000 MHz (c) 2000 MHz and (d) 3000 MHz.	73
39	Fresnel zone, LOS and 60% of first Fresnel zone for site location of Boven PV1 to the core SKA telescopes for (a) 100 MHz (b) 1000 MHz (c) 2000 MHz and (d) 3000 MHz.	74
40	Fresnel zone, LOS and 60% of first Fresnel zone for site location of Boven PV2 to the closest SKA telescope for (a) 100 MHz (b) 1000 MHz (c) 2000 MHz and (d) 3000 MHz.	75
41	Fresnel zone, LOS and 60% of first Fresnel zone for site location of Boven PV2 to the second closest SKA telescope for (a) 100 MHz (b) 1000 MHz (c) 2000 MHz and (d) 3000 MHz.	76
42	Fresnel zone, LOS and 60% of first Fresnel zone for site location of Boven PV2 to the core SKA telescopes for (a) 100 MHz (b) 1000 MHz (c) 2000 MHz and (d) 3000 MHz.	77
43	Fresnel zone, LOS and 60% of first Fresnel zone for site location of Boven PV2 Alternative to the closest SKA telescope for (a) 100 MHz (b) 1000 MHz (c) 2000 MHz and (d) 3000 MHz.	78
44	Fresnel zone, LOS and 60% of first Fresnel zone for site location of Boven PV2 Alternative to the second closest SKA telescope for (a) 100 MHz (b) 1000 MHz (c) 2000 MHz and (d) 3000 MHz.	79
45	Fresnel zone, LOS and 60% of first Fresnel zone for site location of Boven PV2 Alternative to the core SKA telescopes for (a) 100 MHz (b) 1000 MHz (c) 2000 MHz and (d) 3000 MHz.	80
46	Fresnel zone, LOS and 60% of first Fresnel zone for site location of Boven PV3 to the closest SKA telescope for (a) 100 MHz (b) 1000 MHz (c) 2000 MHz and (d) 3000 MHz.	81
47	Fresnel zone, LOS and 60% of first Fresnel zone for site location of Boven PV3 to the second closest SKA telescope for (a) 100 MHz (b) 1000 MHz (c) 2000 MHz and (d) 3000 MHz.	82
48	Fresnel zone, LOS and 60% of first Fresnel zone for site location of Boven PV3 to the core SKA telescopes for (a) 100 MHz (b) 1000 MHz (c) 2000 MHz and (d) 3000 MHz.	83
49	Fresnel zone, LOS and 60% of first Fresnel zone for site location of Boven PV3 Alternative to the closest SKA telescope for (a) 100 MHz (b) 1000 MHz (c) 2000 MHz and (d) 3000 MHz.	84

50 Fresnel zone, LOS and 60% of first Fresnel zone for site location of Boven PV3 Alternative to the second closest SKA telescope for (a) 100 MHz (b) 1000 MHz (c) 2000 MHz and (d) 3000 MHz. . . . 85

51 Fresnel zone, LOS and 60% of first Fresnel zone for site location of Boven PV3 Alternative to the core SKA telescopes for (a) 100 MHz (b) 1000 MHz (c) 2000 MHz and (d) 3000 MHz. 86

52 Fresnel zone, LOS and 60% of first Fresnel zone for site location of Boven PV4 to the closest SKA telescope for (a) 100 MHz (b) 1000 MHz (c) 2000 MHz and (d) 3000 MHz. 87

53 Fresnel zone, LOS and 60% of first Fresnel zone for site location of Boven PV4 to the second closest SKA telescope for (a) 100 MHz (b) 1000 MHz (c) 2000 MHz and (d) 3000 MHz. 88

54 Fresnel zone, LOS and 60% of first Fresnel zone for site location of Boven PV4 to the core SKA telescopes for (a) 100 MHz (b) 1000 MHz (c) 2000 MHz and (d) 3000 MHz. 89

55 Fresnel zone, LOS and 60% of first Fresnel zone for site location of Boven PV4 Alternative to the closest SKA telescope for (a) 100 MHz (b) 1000 MHz (c) 2000 MHz and (d) 3000 MHz. 90

56 Fresnel zone, LOS and 60% of first Fresnel zone for site location of Boven PV4 Alternative to the second closest SKA telescope for (a) 100 MHz (b) 1000 MHz (c) 2000 MHz and (d) 3000 MHz. . . . 91

57 Fresnel zone, LOS and 60% of first Fresnel zone for site location of Boven PV4 Alternative to the core SKA telescopes for (a) 100 MHz (b) 1000 MHz (c) 2000 MHz and (d) 3000 MHz. 92

58 Fresnel zone, LOS and 60% of first Fresnel zone for site location of Gembok PV1 to the closest SKA telescope for (a) 100 MHz (b) 1000 MHz (c) 2000 MHz and (d) 3000 MHz. 93

59 Fresnel zone, LOS and 60% of first Fresnel zone for site location of Gembok PV1 to the second closest SKA telescope for (a) 100 MHz (b) 1000 MHz (c) 2000 MHz and (d) 3000 MHz. 94

60 Fresnel zone, LOS and 60% of first Fresnel zone for site location of Gembok PV1 to the core SKA telescopes for (a) 100 MHz (b) 1000 MHz (c) 2000 MHz and (d) 3000 MHz. 95

61 Fresnel zone, LOS and 60% of first Fresnel zone for site location of Gembok PV2 to the closest SKA telescope for (a) 100 MHz (b) 1000 MHz (c) 2000 MHz and (d) 3000 MHz. 96

62 Fresnel zone, LOS and 60% of first Fresnel zone for site location of Gembok PV2 to the second closest SKA telescope for (a) 100 MHz (b) 1000 MHz (c) 2000 MHz and (d) 3000 MHz. 97

63 Fresnel zone, LOS and 60% of first Fresnel zone for site location of Gembok PV2 to the core SKA telescopes for (a) 100 MHz (b) 1000 MHz (c) 2000 MHz and (d) 3000 MHz. 98

64 Fresnel zone, LOS and 60% of first Fresnel zone for site location of Gembok PV3 to the closest SKA telescope for (a) 100 MHz (b) 1000 MHz (c) 2000 MHz and (d) 3000 MHz. 99

65 Fresnel zone, LOS and 60% of first Fresnel zone for site location of Gembok PV3 to the second closest SKA telescope for (a) 100 MHz (b) 1000 MHz (c) 2000 MHz and (d) 3000 MHz. 100

66 Fresnel zone, LOS and 60% of first Fresnel zone for site location of Gembok PV3 to the core SKA telescopes for (a) 100 MHz (b) 1000 MHz (c) 2000 MHz and (d) 3000 MHz. 101

67 Fresnel zone, LOS and 60% of first Fresnel zone for site location of Gembok PV3 Alternative to the closest SKA telescope for (a) 100 MHz (b) 1000 MHz (c) 2000 MHz and (d) 3000 MHz. 102

68 Fresnel zone, LOS and 60% of first Fresnel zone for site location of Gembok PV3 Alternative to the second closest SKA telescope for (a) 100 MHz (b) 1000 MHz (c) 2000 MHz and (d) 3000 MHz. . . . 103

69 Fresnel zone, LOS and 60% of first Fresnel zone for site location of Gembok PV3 Alternative to the core SKA telescopes for (a) 100 MHz (b) 1000 MHz (c) 2000 MHz and (d) 3000 MHz. 104

70 Fresnel zone, LOS and 60% of first Fresnel zone for site location of Gembok PV4 to the closest SKA telescope for (a) 100 MHz (b) 1000 MHz (c) 2000 MHz and (d) 3000 MHz. 105

71 Fresnel zone, LOS and 60% of first Fresnel zone for site location of Gembok PV4 to the second closest SKA telescope for (a) 100 MHz (b) 1000 MHz (c) 2000 MHz and (d) 3000 MHz. 106

72 Fresnel zone, LOS and 60% of first Fresnel zone for site location of Gembok PV4 to the core SKA telescopes for (a) 100 MHz (b) 1000 MHz (c) 2000 MHz and (d) 3000 MHz. 107

73 Fresnel zone, LOS and 60% of first Fresnel zone for site location of Gembok PV4 Alternative to the closest SKA telescope for (a) 100 MHz (b) 1000 MHz (c) 2000 MHz and (d) 3000 MHz. 108

74 Fresnel zone, LOS and 60% of first Fresnel zone for site location of Gembok PV4 Alternative to the second closest SKA telescope for (a) 100 MHz (b) 1000 MHz (c) 2000 MHz and (d) 3000 MHz. . . . 109

75 Fresnel zone, LOS and 60% of first Fresnel zone for site location of Gembok PV4 Alternative to the core SKA telescopes for (a) 100 MHz (b) 1000 MHz (c) 2000 MHz and (d) 3000 MHz. 110

76 Fresnel zone, LOS and 60% of first Fresnel zone for site location of Gembok PV5 to the closest SKA telescope for (a) 100 MHz (b) 1000 MHz (c) 2000 MHz and (d) 3000 MHz. 111

77 Fresnel zone, LOS and 60% of first Fresnel zone for site location of Gembok PV5 to the second closest SKA telescope for (a) 100 MHz (b) 1000 MHz (c) 2000 MHz and (d) 3000 MHz. 112

78 Fresnel zone, LOS and 60% of first Fresnel zone for site location of Gembok PV5 to the core SKA telescopes for (a) 100 MHz (b) 1000 MHz (c) 2000 MHz and (d) 3000 MHz. 113

79 Fresnel zone, LOS and 60% of first Fresnel zone for site location of Gembok PV5 Alternative to the closest SKA telescope for (a) 100 MHz (b) 1000 MHz (c) 2000 MHz and (d) 3000 MHz. 114

80 Fresnel zone, LOS and 60% of first Fresnel zone for site location of Gembok PV5 Alternative to the second closest SKA telescope for (a) 100 MHz (b) 1000 MHz (c) 2000 MHz and (d) 3000 MHz. 115

81 Fresnel zone, LOS and 60% of first Fresnel zone for site location of Gembok PV5 Alternative to the core SKA telescopes for (a) 100 MHz (b) 1000 MHz (c) 2000 MHz and (d) 3000 MHz. 116

82 Fresnel zone, LOS and 60% of first Fresnel zone for site location of Gembok PV6 to the closest SKA telescope for (a) 100 MHz (b) 1000 MHz (c) 2000 MHz and (d) 3000 MHz. 117

83 Fresnel zone, LOS and 60% of first Fresnel zone for site location of Gembok PV6 to the second closest SKA telescope for (a) 100 MHz (b) 1000 MHz (c) 2000 MHz and (d) 3000 MHz. 118

84 Fresnel zone, LOS and 60% of first Fresnel zone for site location of Gembok PV6 to the core SKA telescopes for (a) 100 MHz (b) 1000 MHz (c) 2000 MHz and (d) 3000 MHz. 119

85 Fresnel zone, LOS and 60% of first Fresnel zone for site location of Gembok PV6 Alternative to the closest SKA telescope for (a) 100 MHz (b) 1000 MHz (c) 2000 MHz and (d) 3000 MHz. 120

86 Fresnel zone, LOS and 60% of first Fresnel zone for site location of Gembok PV6 Alternative to the second closest SKA telescope for (a) 100 MHz (b) 1000 MHz (c) 2000 MHz and (d) 3000 MHz. 121

87 Fresnel zone, LOS and 60% of first Fresnel zone for site location of Gembok PV6 Alternative to the core SKA telescopes for (a) 100 MHz (b) 1000 MHz (c) 2000 MHz and (d) 3000 MHz. 122

88 Fresnel zone, LOS and 60% of first Fresnel zone for site location of Scatec PV1 to the closest SKA telescope for (a) 100 MHz (b) 1000 MHz (c) 2000 MHz and (d) 3000 MHz. 123

89 Fresnel zone, LOS and 60% of first Fresnel zone for site location of Scatec PV1 to the second closest SKA telescope for (a) 100 MHz (b) 1000 MHz (c) 2000 MHz and (d) 3000 MHz. 124

90 Fresnel zone, LOS and 60% of first Fresnel zone for site location of Scatec PV1 to the core SKA telescopes for (a) 100 MHz (b) 1000 MHz (c) 2000 MHz and (d) 3000 MHz. 125

91 Fresnel zone, LOS and 60% of first Fresnel zone for site location of Scatec PV2 to the closest SKA telescope for (a) 100 MHz (b) 1000 MHz (c) 2000 MHz and (d) 3000 MHz. 126

92 Fresnel zone, LOS and 60% of first Fresnel zone for site location of Scatec PV2 to the second closest SKA telescope for (a) 100 MHz (b) 1000 MHz (c) 2000 MHz and (d) 3000 MHz. 127

93 Fresnel zone, LOS and 60% of first Fresnel zone for site location of Scatec PV2 to the core SKA telescopes for (a) 100 MHz (b) 1000 MHz (c) 2000 MHz and (d) 3000 MHz. 128

94 Fresnel zone, LOS and 60% of first Fresnel zone for site location of Scatec PV3 to the closest SKA telescope for (a) 100 MHz (b) 1000 MHz (c) 2000 MHz and (d) 3000 MHz. 129

95 Fresnel zone, LOS and 60% of first Fresnel zone for site location of Scatec PV3 to the second closest SKA telescope for (a) 100 MHz (b) 1000 MHz (c) 2000 MHz and (d) 3000 MHz. 130

96 Fresnel zone, LOS and 60% of first Fresnel zone for site location of Scatec PV3 to the core SKA telescopes for (a) 100 MHz (b) 1000 MHz (c) 2000 MHz and (d) 3000 MHz. 131

List of Tables

1	Specifications of location Boven PV1 solar farm relative to the SKA core and closest telescopes. . . .	18
2	Specifications of preferred location Boven PV2 solar farm relative to the SKA core and closest telescopes.	19
3	Specifications of alternative location Boven PV2 solar farm relative to the SKA core and closest telescopes.	20
4	Specifications of preferred location Boven PV3 solar farm relative to the SKA core and closest telescopes.	21
5	Specifications of alternative location Boven PV3 solar farm relative to the SKA core and closest telescopes.	21
6	Specifications of preferred location Boven PV4 solar farm relative to the SKA core and closest telescopes.	21
7	Specifications of alternative location Boven PV4 solar farm relative to the SKA core and closest telescopes.	21
8	Specifications of location Gemsbok PV1 solar farm relative to the SKA core and closest telescopes. .	22
9	Specifications of location Gemsbok PV2 solar farm relative to the SKA core and closest telescopes. .	23
10	Specifications of preferred location Gemsbok PV3 solar farm relative to the SKA core and closest telescopes.	24
11	Specifications of alternative location Gemsbok PV3 solar farm relative to the SKA core and closest telescopes.	25
12	Specifications of preferred location Gemsbok PV4 solar farm relative to the SKA core and closest telescopes.	26
13	Specifications of alternative location Gemsbok PV4 solar farm relative to the SKA core and closest telescopes.	27
14	Specifications of preferred location Gemsbok PV5 solar farm relative to the SKA core and closest telescopes.	28
15	Specifications of alternative location Gemsbok PV5 solar farm relative to the SKA core and closest telescopes.	28
16	Specifications of preferred location Gemsbok PV6 solar farm relative to the SKA core and closest telescopes.	28
17	Specifications of alternative location Gemsbok PV6 solar farm relative to the SKA core and closest telescopes.	28
18	Specifications of location Scatec PV1 solar farm relative to the SKA core and closest telescopes. . . .	29
19	Specifications of location Scatec PV2 solar farm relative to the SKA core and closest telescopes. . . .	30
20	Specifications of location Scatec PV3 solar farm relative to the SKA core and closest telescopes. . . .	31
21	SPLAT! parameters for predicted 100 MHz to 3 GHz emissions from proposed PV projects to SKA core and closest telescope.	32
22	SPLAT! Free Space Path Loss (FSPL), Terrain Loss (TL) and Total Path Loss (TPL) for vertical polarisation site Boven PV1 emissions.	32
23	SPLAT! Free Space Path Loss (FSPL), Terrain Loss (TL) and Total Path Loss (TPL) for vertical polarisation preferred site Boven PV2 emissions.	34
24	SPLAT! Free Space Path Loss (FSPL), Terrain Loss (TL) and Total Path Loss (TPL) for vertical polarisation alternative site Boven PV2 emissions.	34
25	SPLAT! Free Space Path Loss (FSPL), Terrain Loss (TL) and Total Path Loss (TPL) for vertical polarisation preferred site Boven PV3 emissions.	37
26	SPLAT! Free Space Path Loss (FSPL), Terrain Loss (TL) and Total Path Loss (TPL) for vertical polarisation alternative site Boven PV3 emissions.	37
27	SPLAT! Free Space Path Loss (FSPL), Terrain Loss (TL) and Total Path Loss (TPL) for vertical polarisation preferred site Boven PV4 emissions.	40
28	SPLAT! Free Space Path Loss (FSPL), Terrain Loss (TL) and Total Path Loss (TPL) for vertical polarisation alternative site Boven PV4 emissions.	40

29 SPLAT! Free Space Path Loss (FSPL), Terrain Loss (TL) and Total Path Loss (TPL) for vertical polarisation **preferred** site Gemsbok PV1 emissions. 43

30 SPLAT! Free Space Path Loss (FSPL), Terrain Loss (TL) and Total Path Loss (TPL) for vertical polarisation **preferred** site Gemsbok PV2 emissions. 43

31 SPLAT! Free Space Path Loss (FSPL), Terrain Loss (TL) and Total Path Loss (TPL) for vertical polarisation **preferred** site Gemsbok PV3 emissions. 46

32 SPLAT! Free Space Path Loss (FSPL), Terrain Loss (TL) and Total Path Loss (TPL) for vertical polarisation **alternative** site Gemsbok PV3 emissions. 46

33 SPLAT! Free Space Path Loss (FSPL), Terrain Loss (TL) and Total Path Loss (TPL) for vertical polarisation **preferred** site Gemsbok PV4 emissions. 49

34 SPLAT! Free Space Path Loss (FSPL), Terrain Loss (TL) and Total Path Loss (TPL) for vertical polarisation **alternative** site Gemsbok PV4 emissions. 49

35 SPLAT! Free Space Path Loss (FSPL), Terrain Loss (TL) and Total Path Loss (TPL) for vertical polarisation **preferred** site Gemsbok PV5 emissions. 52

36 SPLAT! Free Space Path Loss (FSPL), Terrain Loss (TL) and Total Path Loss (TPL) for vertical polarisation **alternative** site Gemsbok PV5 emissions. 52

37 SPLAT! Free Space Path Loss (FSPL), Terrain Loss (TL) and Total Path Loss (TPL) for vertical polarisation **preferred** site Gemsbok PV6 emissions. 55

38 SPLAT! Free Space Path Loss (FSPL), Terrain Loss (TL) and Total Path Loss (TPL) for vertical polarisation **alternative** site Gemsbok PV6 emissions. 55

39 SPLAT! Free Space Path Loss (FSPL), Terrain Loss (TL) and Total Path Loss (TPL) for vertical polarisation **preferred** site Scatec PV1 emissions. 58

40 SPLAT! Free Space Path Loss (FSPL), Terrain Loss (TL) and Total Path Loss (TPL) for vertical polarisation **preferred** site Scatec PV2 emissions. 58

41 SPLAT! Free Space Path Loss (FSPL), Terrain Loss (TL) and Total Path Loss (TPL) for vertical polarisation **preferred** site Scatec PV3 emissions. 62

42 Summary of preferred and alternate site locations based on predicted total path loss. Legend: ✓: Recommended; ~ : Neutral; X : Not Recommended. 63

1 Introduction

MESA Solutions was asked to investigate the cumulative effect and possible impact of a number of photovoltaic (PV) plants on the Square Kilometre Array (SKA) project. It is proposed that development of these plants take place in the Astronomy Geographic Advantage (AGA) area described in [1]. The proposed sites include ten developments by *Mulilo Renewable Project Developments*, as well as three developments by *Scatec Solar*. From the terrain evaluation we are able to determine what influences, if any, natural topographical features will have on the total expected interference attenuation based on the location of the site. This determines the maximum allowable emission levels which the facility may generate in order to still comply with SKA threshold limits as specified in [2]. An initial study investigating the effect of three of the ten sites, namely *Boven PV1*, *Gemsbok PV1* and *Gemsbok PV2*, on the closest and core SKA telescopes were undertaken in [3].

The following additional sites considered in this cumulative study include:

Mulilo Renewable Project Developments

- Boven PV2
- Boven PV3
- Boven PV4
- Gemsbok PV3
- Gemsbok PV4
- Gemsbok PV5
- Gemsbok PV6

Scatec Solar

- Kenhardt PV1
- Kenhardt PV2
- Kenhardt PV3

For each of the additional Mulilo sites, a preferred and an alternative site location is considered in terms of the total path loss to the closest and core SKA telescopes. The purpose is to identify the recommended site location based on minimum potential impact.

The aim of this investigation is to define emission limits at relevant discrete frequencies to which *in situ* measurements, conducted once the project is built, have to adhere. Compliance to these limits, given the propagation analysis presented, will ensure that emissions will not exceed the SARAS protection or receiver saturation threshold levels. The report is not a prediction of what interference levels will be at each of the telescopes, but rather stipulates a requirement for the developer to ensure conformance. Ultimately, the conformance of the plant can be determined by comparing representative measured results to the calculated levels provided.

In the case where there are more than one PV plant (source of interference) emitting at a specific frequency, the cumulative impact should be considered by taking into account:

$$P_{\text{Cumulative}} = 10 \log_{10}(N) \quad (1)$$

where $N=13$ is the number of PV plants considered in this investigation. This could result in an accumulative effect of up to $P_{\text{Cumulative}}=11.1$ dB for power transmitted at a specific frequency. The cumulative impact is in addition to any existing RFI from the plant.

It is important to note that the findings from this assessment are for the client's own edification, and will be taken into account by SKA-SA during their own propagation analysis. This study is therefore not meant to supersede any investigation done by SKA-SA or relevant RFI working groups. It remains the responsibility of the developer to meet compliance to the SKA requirements, and MESA Solutions cannot accept responsibility for any assessments made in this report which could cause non-compliance.

2 Site Location Data

The proximity of the proposed PV plant locations to the closest and core-site SKA telescopes are shown in Figs. 1 to 11, while separation distances, azimuth angles, transmitter and receiver heights for preferred and alternative site locations are given in Tables 1 to 20.

2.1 Boven PV1

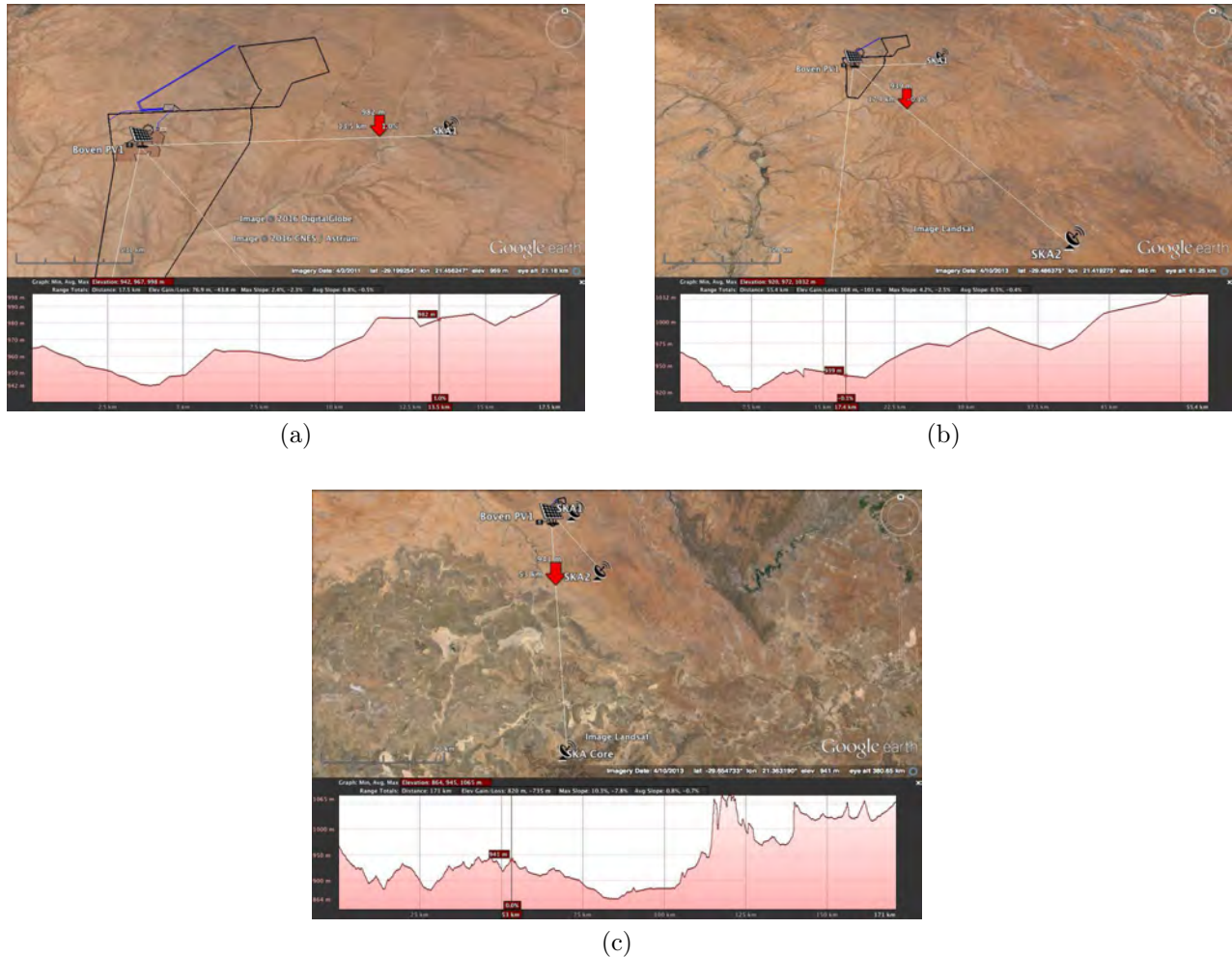

Figure 1: Google Earth terrain profile for Boven PV1 to (a) closest and (b) second closest and (c) core SKA telescopes.

Boven PV1	Closest Telescope 1	Closest Telescope 2	SKA Core Site
Distance	17.37 km	55.45 km	171.10 km
Azimuth	90.92 °	165.13 °	175.10 °
PV Tx Height	3 m	3 m	3 m
SKA Rx Height	15 m	15 m	15 m

Table 1: Specifications of location Boven PV1 solar farm relative to the SKA core and closest telescopes.

2.2 Boven PV2

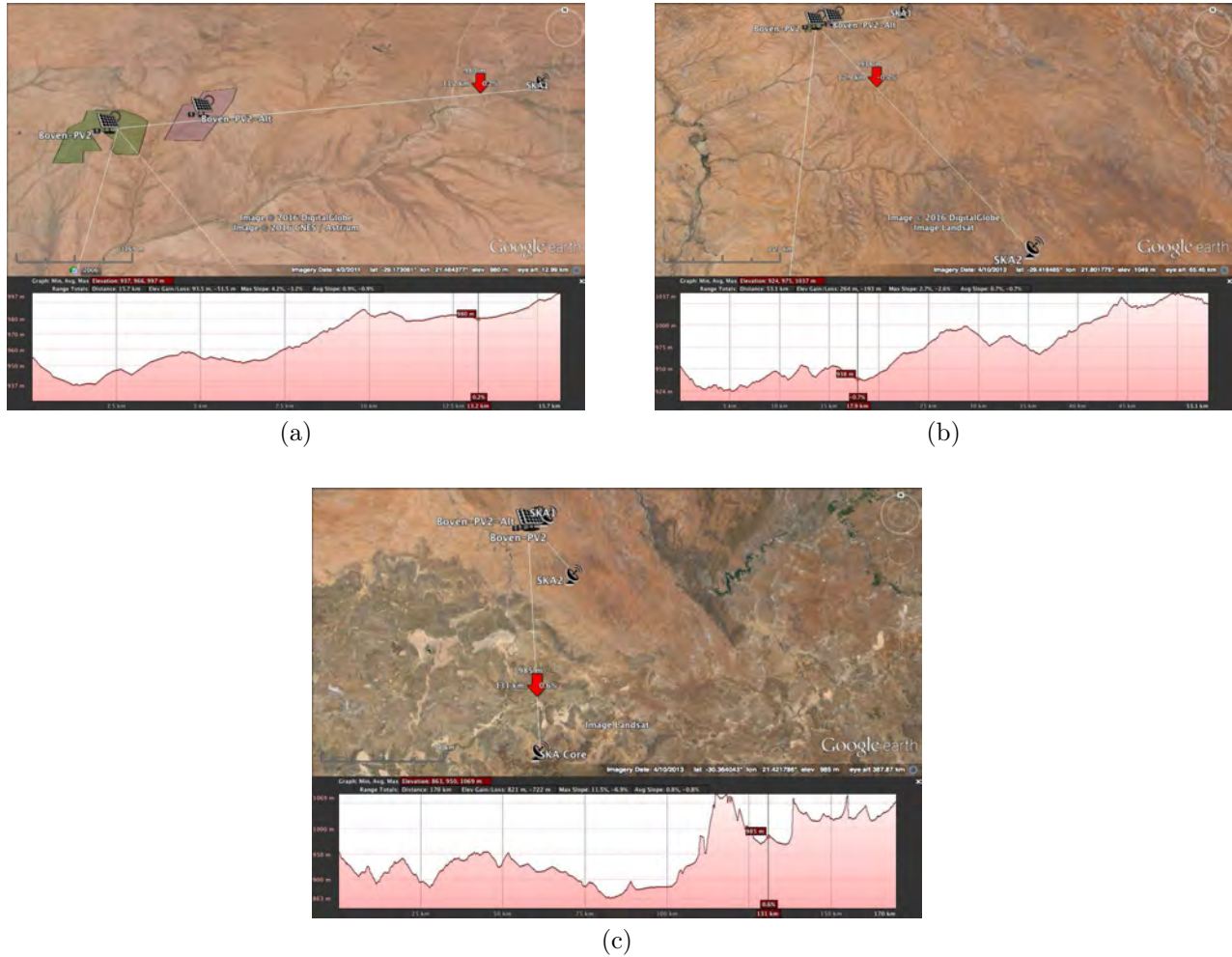

Figure 2: Google Earth terrain profile for Boven PV2 to (a) closest and (b) second closest and (c) core SKA telescopes.

Boven PV2 Pref	Closest Telescope 1	Closest Telescope 2	SKA Core Site
Distance	15.00 km	52.46 km	169.08 km
Azimuth	80.68 °	140.60 °	177.13 °
PV Tx Height	3 m	3 m	3 m
SKA Rx Height	15 m	15 m	15 m

Table 2: Specifications of preferred location Boven PV2 solar farm relative to the SKA core and closest telescopes.

Boven PV2 Alt	Closest Telescope 1	Closest Telescope 2	SKA Core Site
Distance	12.52 km	52.07 km	170.30 km
Azimuth	84.93 °	143.50 °	177.93 °
PV Tx Height	3 m	3 m	3 m
SKA Rx Height	15 m	15 m	15 m

Table 3: Specifications of **alternative** location Boven PV2 solar farm relative to the SKA core and closest telescopes.

2.3 Boven PV3

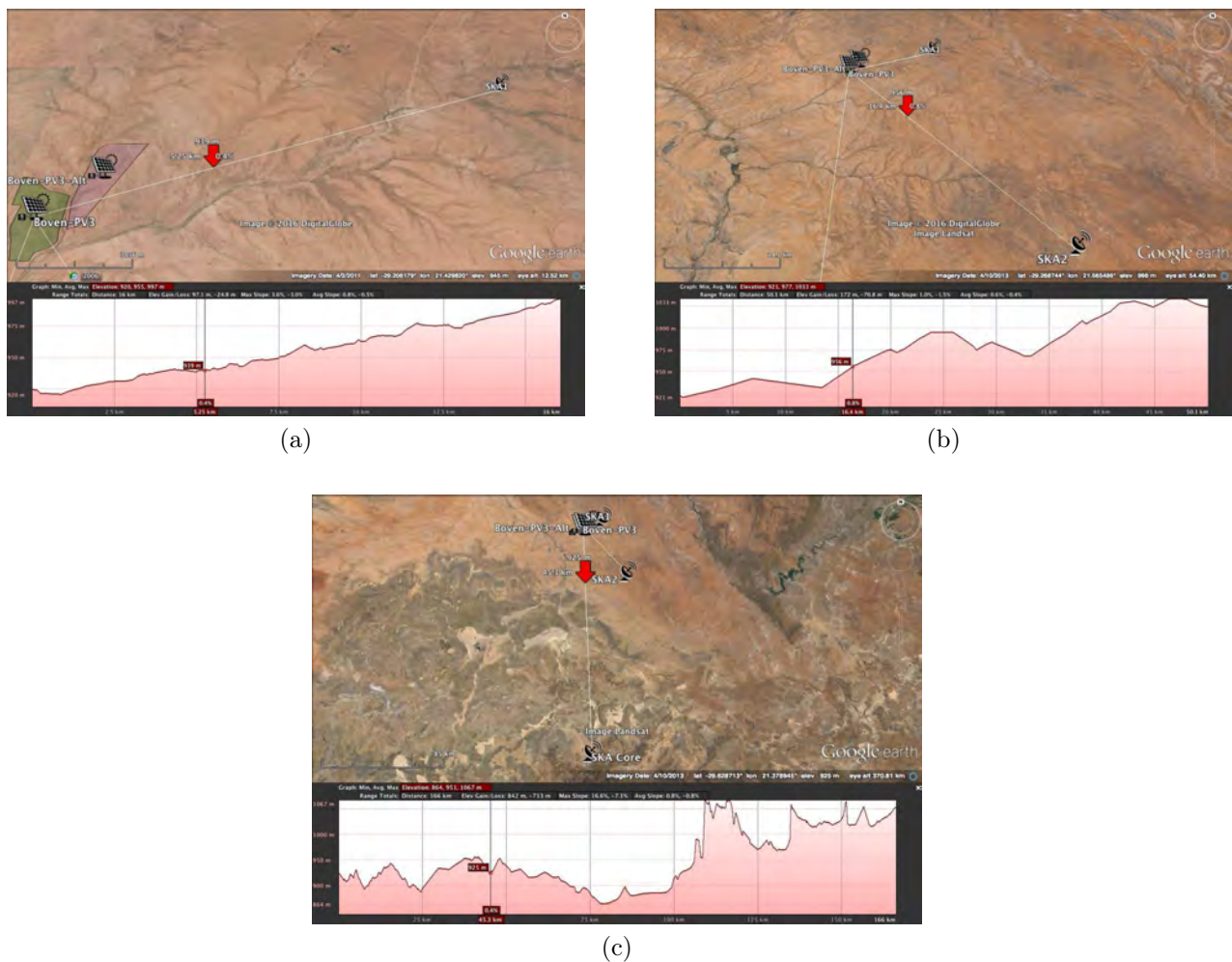

Figure 3: Google Earth terrain profile for Boven PV3 to (a) closest and (b) second closest and (c) core SKA telescopes.

Boven PV3 Pref	Closest Telescope 1	Closest Telescope 2	SKA Core Site
Distance	15.69 km	50.06 km	166.01 km
Azimuth	69.50 °	138.46 °	177.11 °
PV Tx Height	3 m	3 m	3 m
SKA Rx Height	15 m	15 m	15 m

 Table 4: Specifications of **preferred** location Boven PV3 solar farm relative to the SKA core and closest telescopes.

Boven PV3 Alt	Closest Telescope 1	Closest Telescope 2	SKA Core Site
Distance	13.79 km	50.41 km	167.63 km
Azimuth	73.94 °	140.96 °	177.63 °
PV Tx Height	3 m	3 m	3 m
SKA Rx Height	15 m	15 m	15 m

 Table 5: Specifications of **alternative** location Boven PV3 solar farm relative to the SKA core and closest telescopes.

2.4 Boven PV4

Boven PV4 Pref	Closest Telescope 1	Closest Telescope 2	SKA Core Site
Distance	17.94 km	51.16 km	165.60 km
Azimuth	70.38 °	136.24 °	176.36 °
PV Tx Height	3 m	3 m	3 m
SKA Rx Height	15 m	15 m	15 m

 Table 6: Specifications of **preferred** location Boven PV4 solar farm relative to the SKA core and closest telescopes.

Boven PV4 Alt	Closest Telescope 1	Closest Telescope 2	SKA Core Site
Distance	18.72 km	49.62 km	163.48 km
Azimuth	64.21 °	134.58 °	176.32 °
PV Tx Height	3 m	3 m	3 m
SKA Rx Height	15 m	15 m	15 m

 Table 7: Specifications of **alternative** location Boven PV4 solar farm relative to the SKA core and closest telescopes.

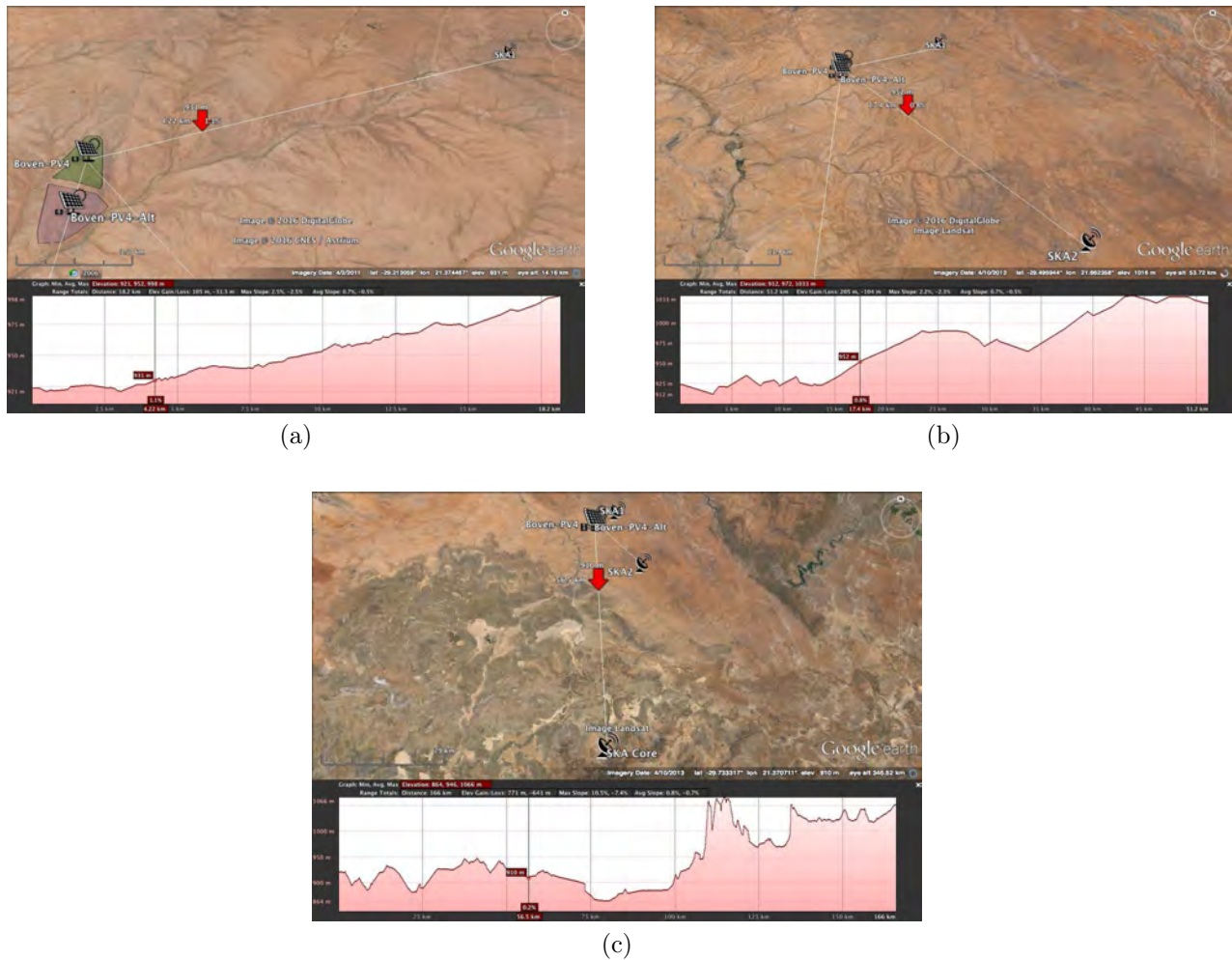

Figure 4: Google Earth terrain profile for Boven PV4 to (a) closest and (b) second closest and (c) core SKA telescopes.

2.5 Gemsbok PV1

Gemsbok PV1	Closest Telescope 1	Closest Telescope 2	SKA Core Site
Distance	19.12 km	60.45 km	176.67 km
Azimuth	113.77 °	166.26 °	174.59 °
PV Tx Height	3 m	3 m	3 m
SKA Rx Height	15 m	15 m	15 m

Table 8: Specifications of location Gemsbok PV1 solar farm relative to the SKA core and closest telescopes.

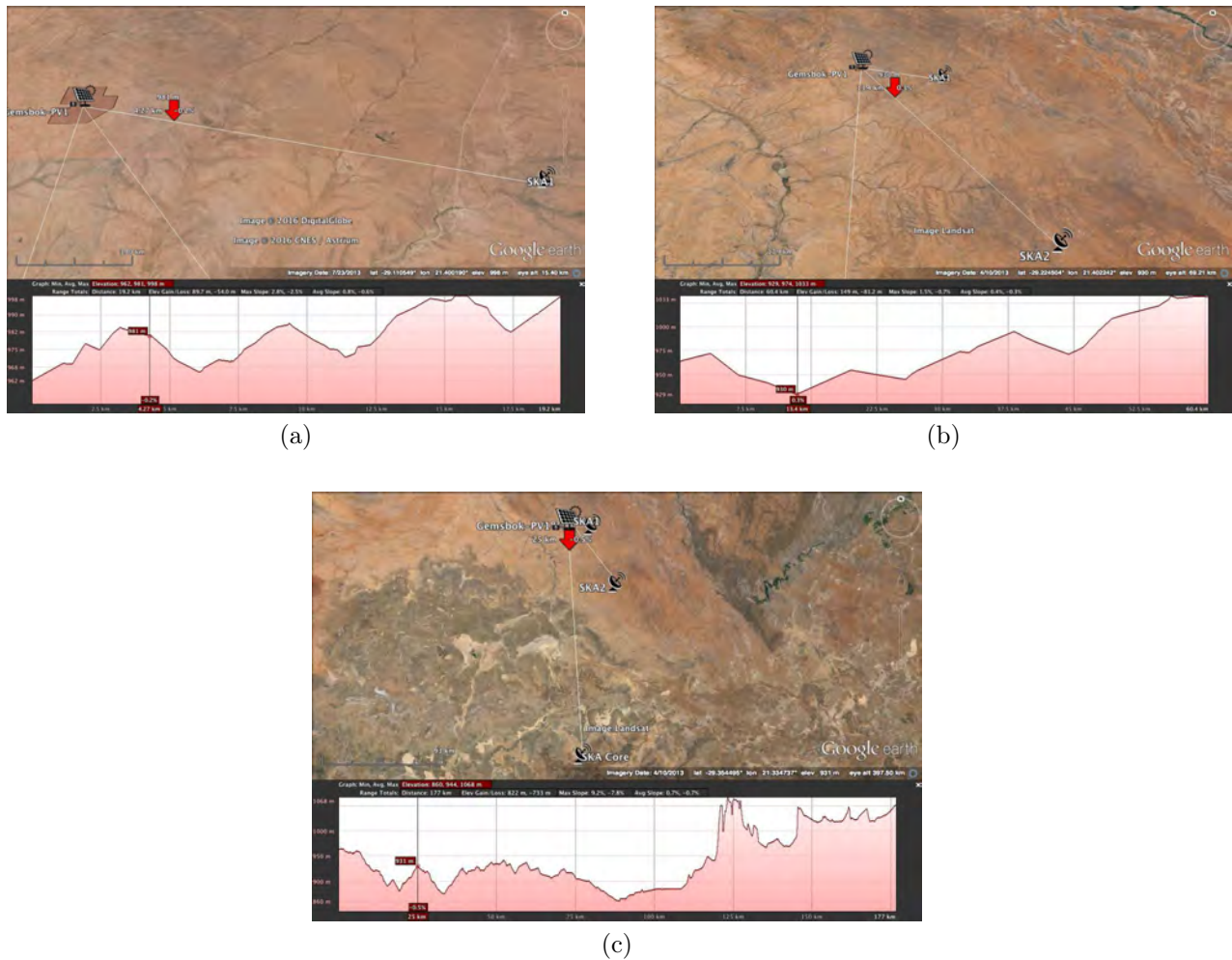

Figure 5: Google Earth terrain profile for Gemsbok PV1 to (a) closest and (b) second closest and (c) core SKA telescopes.

2.6 Gemsbok PV2

Gemsbok PV2	Closest Telescope 1	Closest Telescope 2	SKA Core Site
Distance	16.14 km	58.41 km	176.19 km
Azimuth	115.27 °	167.15 °	175.95 °
PV Tx Height	3 m	3 m	3 m
SKA Rx Height	15 m	15 m	15 m

Table 9: Specifications of location Gemsbok PV2 solar farm relative to the SKA core and closest telescopes.

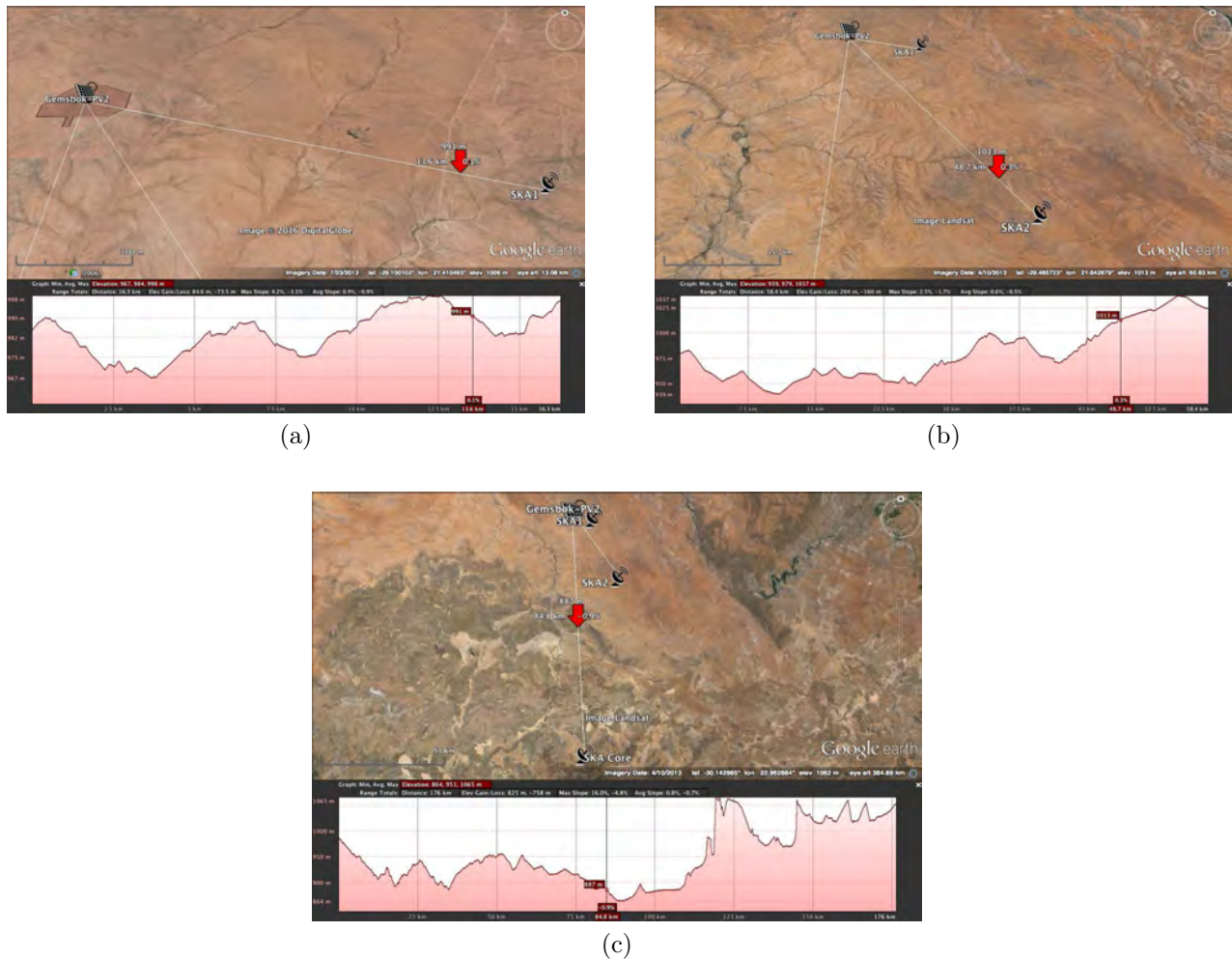
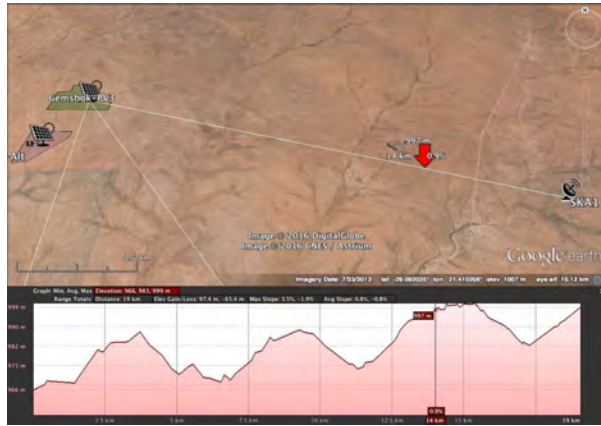

Figure 6: Google Earth terrain profile for Gemsbok PV2 to (a) closest and (b) second closest and (c) core SKA telescopes.

2.7 Gemsbok PV3

Gemsbok PV3 Pref	Closest Telescope 1	Closest Telescope 2	SKA Core Site
Distance	19.46 km	61.16 km	177.36 km
Azimuth	106.87 °	142.65 °	176.05 °
PV Tx Height	3 m	3 m	3 m
SKA Rx Height	15 m	15 m	15 m

Table 10: Specifications of preferred location Gemsbok PV3 solar farm relative to the SKA core and closest telescopes.



(a)

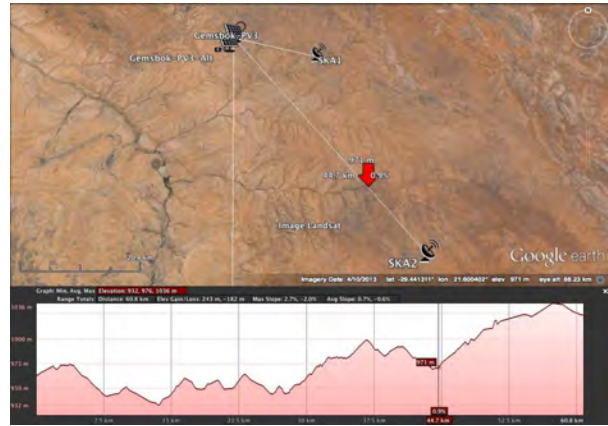

(b)



(c)

Figure 7: Google Earth terrain profile for Gemsbok PV3 to (a) closest and (b) second closest and (c) core SKA telescopes.

Gemsbok PV3 Alt	Closest Telescope 1	Closest Telescope 2	SKA Core Site
Distance	19.53 km	59.47 km	174.71 km
Azimuth	98.67 °	140.55 °	175.77 °
PV Tx Height	3 m	3 m	3 m
SKA Rx Height	15 m	15 m	15 m

Table 11: Specifications of **alternative** location Gemsbok PV3 solar farm relative to the SKA core and closest telescopes.

2.8 Gemsbok PV4

Gemsbok PV4 Pref	Closest Telescope 1	Closest Telescope 2	SKA Core Site
Distance	15.24 km	58.87 km	177.62 km
Azimuth	113.85 °	146.57 °	177.54 °
PV Tx Height	3 m	3 m	3 m
SKA Rx Height	15 m	15 m	15 m

Table 12: Specifications of preferred location Gemsbok PV4 solar farm relative to the SKA core and closest telescopes.

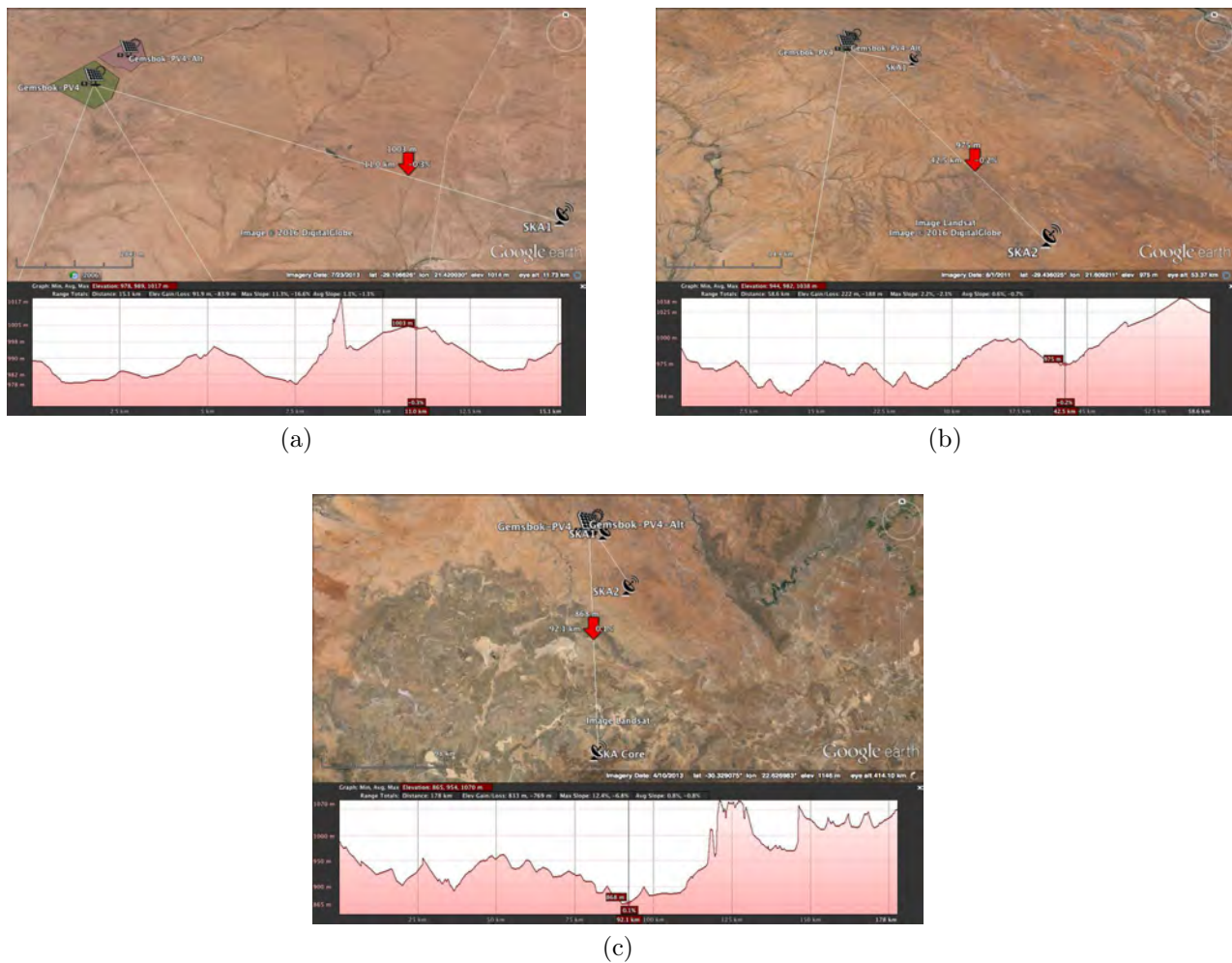

Figure 8: Google Earth terrain profile for Gemsbok PV4 to (a) closest and (b) second closest and (c) core SKA telescopes.

Gembok PV4 Alt	Closest Telescope 1	Closest Telescope 2	SKA Core Site
Distance	15.31 km	59.95 km	179.43 km
Azimuth	121.55 °	148.25 °	177.85 °
PV Tx Height	3 m	3 m	3 m
SKA Rx Height	15 m	15 m	15 m

Table 13: Specifications of **alternative** location Gembok PV4 solar farm relative to the SKA core and closest telescopes.

2.9 Gembok PV5

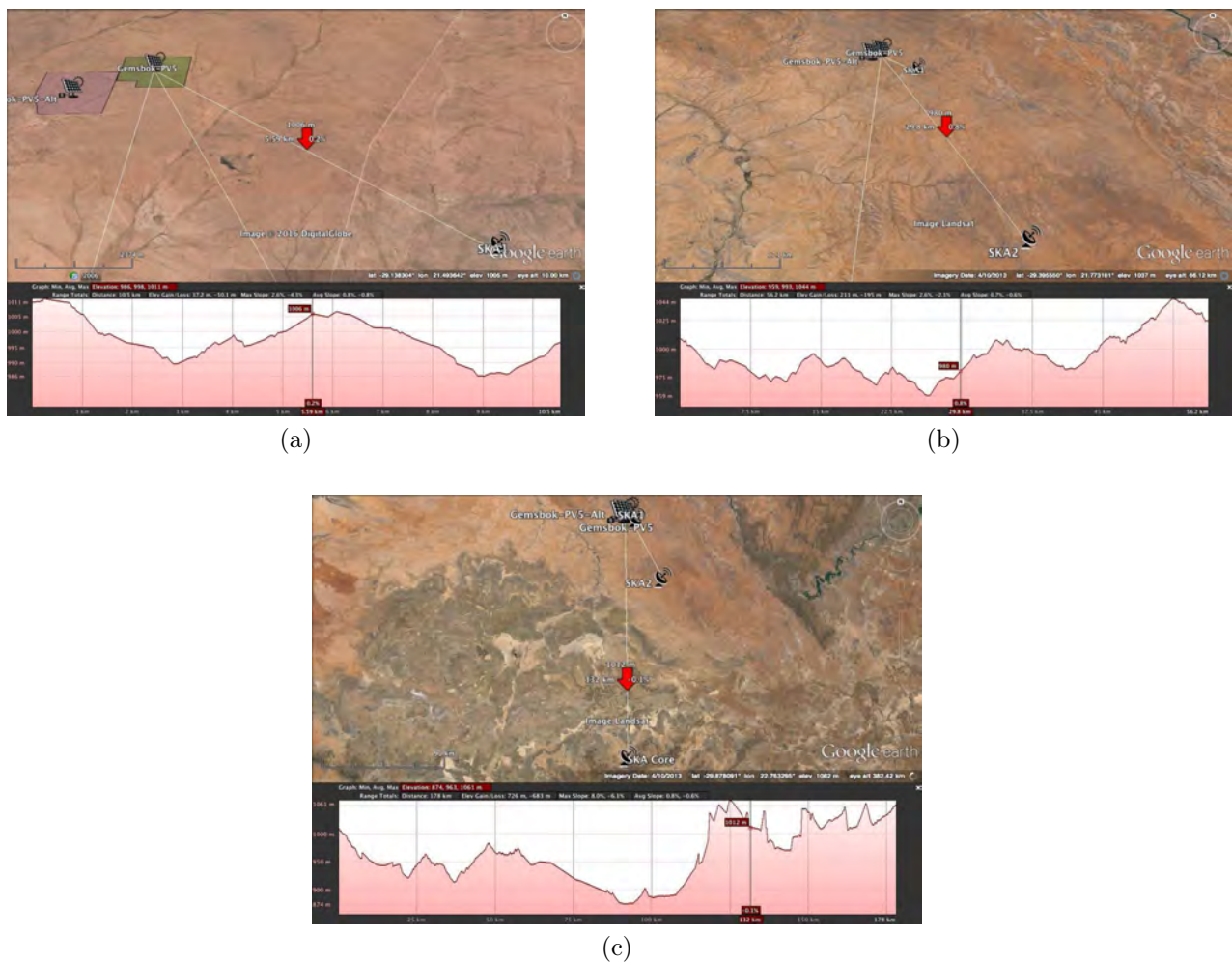

Figure 9: Google Earth terrain profile for Gembok PV5 to (a) closest and (b) second closest and (c) core SKA telescopes.

Gemsbok PV5 Pref	Closest Telescope 1	Closest Telescope 2	SKA Core Site
Distance	10.59 km	56.39 km	178.01 km
Azimuth	129.26 °	151.72 °	179.37 °
PV Tx Height	3 m	3 m	3 m
SKA Rx Height	15 m	15 m	15 m

 Table 14: Specifications of **preferred** location Gemsbok PV5 solar farm relative to the SKA core and closest telescopes.

Gemsbok PV5 Alt	Closest Telescope 1	Closest Telescope 2	SKA Core Site
Distance	11.83 km	56.56 km	177.00 km
Azimuth	118.57 °	149.27 °	178.67 °
PV Tx Height	3 m	3 m	3 m
SKA Rx Height	15 m	15 m	15 m

 Table 15: Specifications of **alternative** location Gemsbok PV5 solar farm relative to the SKA core and closest telescopes.

2.10 Gemsbok PV6

Gemsbok PV6 Pref	Closest Telescope 1	Closest Telescope 2	SKA Core Site
Distance	11.48 km	57.56 km	179.32 km
Azimuth	134.26 °	152.32 °	179.37 °
PV Tx Height	3 m	3 m	3 m
SKA Rx Height	15 m	15 m	15 m

 Table 16: Specifications of **preferred** location Gemsbok PV6 solar farm relative to the SKA core and closest telescopes.

Gemsbok PV6 Alt	Closest Telescope 1	Closest Telescope 2	SKA Core Site
Distance	12.50 km	57.86 km	178.64 km
Azimuth	125.74 °	150.31 °	178.76 °
PV Tx Height	3 m	3 m	3 m
SKA Rx Height	15 m	15 m	15 m

 Table 17: Specifications of **alternative** location Gemsbok PV6 solar farm relative to the SKA core and closest telescopes.

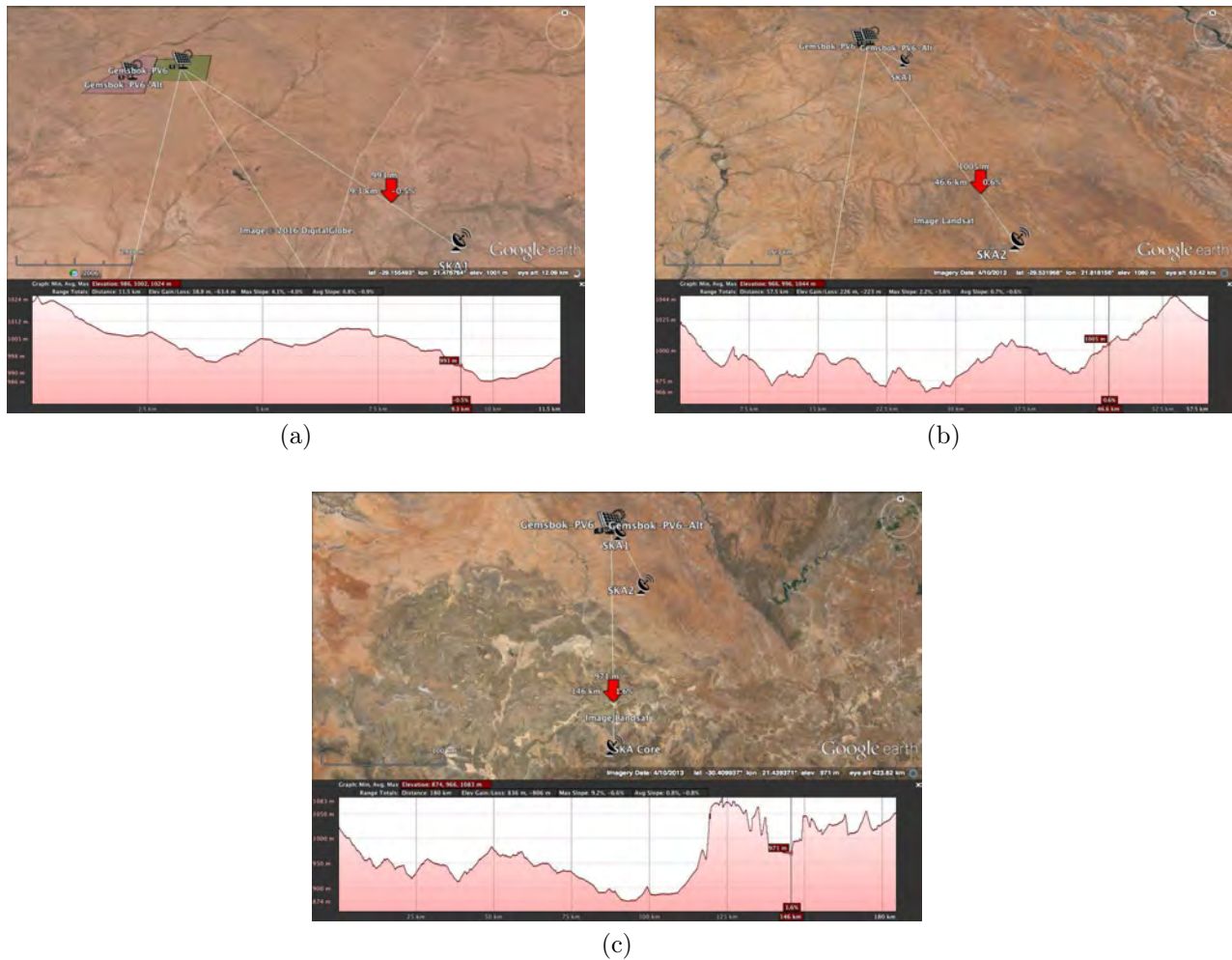

Figure 10: Google Earth terrain profile for Gemsbok PV6 to (a) closest and (b) second closest and (c) core SKA telescopes.

2.11 Scatec PV1, PV2 and PV3

Scatec PV1 Pref	Closest Telescope 1	Closest Telescope 2	SKA Core Site
Distance	20.92 km	56.60 km	169.79 km
Azimuth	86.21 °	163.45 °	173.55 °
PV Tx Height	3 m	3 m	3 m
SKA Rx Height	15 m	15 m	15 m

Table 18: Specifications of location Scatec PV1 solar farm relative to the SKA core and closest telescopes.

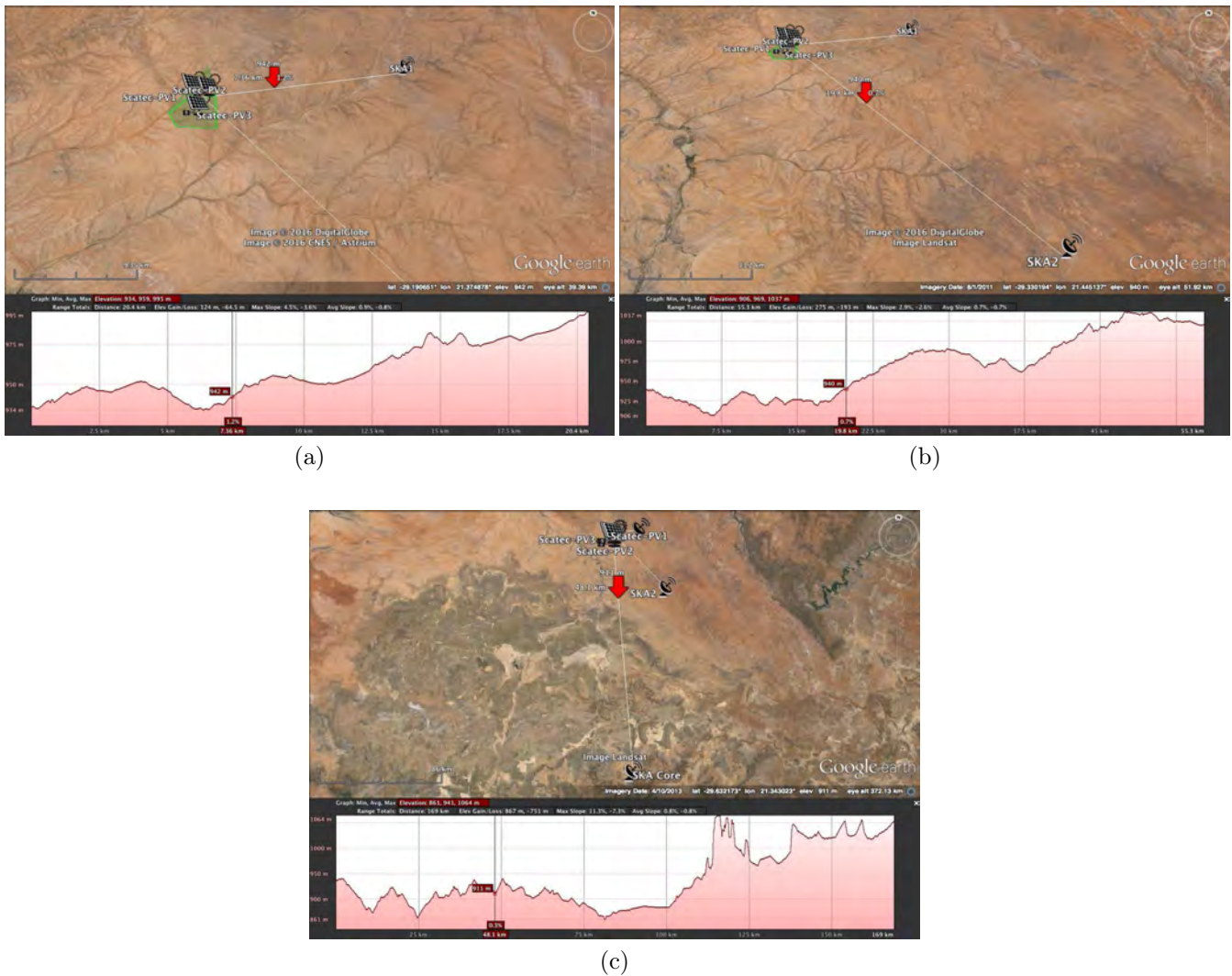

Figure 11: Google Earth terrain profile for Scatec PV1 to PV3 to (a) closest and (b) second closest and (c) core SKA telescopes.

Scatec PV2 Pref	Closest Telescope 1	Closest Telescope 2	SKA Core Site
Distance	19.43 km	55.30 km	169.33 km
Azimuth	83.77 °	163.86 °	174.24 °
PV Tx Height	3 m	3 m	3 m
SKA Rx Height	15 m	15 m	15 m

Table 19: Specifications of location Scatec PV2 solar farm relative to the SKA core and closest telescopes.

Scatec PV3 Pref	Closest Telescope 1	Closest Telescope 2	SKA Core Site
Distance	20.57 km	54.09 km	167.02 km
Azimuth	75.12 °	162.75 °	173.91 °
PV Tx Height	3 m	3 m	3 m
SKA Rx Height	15 m	15 m	15 m

Table 20: Specifications of location Scatec PV3 solar farm relative to the SKA core and closest telescopes.

3 Signal Propagation Loss and Terrain Analysis

The default propagation analysis software used by MESA Solutions is called SPLAT!, which is a **Signal Propagation, Loss And Terrain** analysis tool based on the *Longley-Rice Irregular Terrain Model (ITM)*, as well as the *Irregular Terrain With Obstructions Model (ITWOM 3.0)*. The software takes into account actual terrain elevation data, to ultimately predict the total path loss (TPL) between a transmitter and a receiver. As part of the analysis, certain assumptions are made regarding the source characteristics. For this investigation the various parameters defining the SPLAT! propagation model are listed in Table 21. The digital elevation model (DEM) makes use of 3-arc-second (90 m) elevation resolution data.

For this investigation, the frequency range of interest is defined from 100 MHz to 3 GHz. While the upper frequency limit of the standard in [2] is specified to at least 10 GHz, the span is limited to what is practically measurable and representative of the majority of expected interference. In the analysis the allowable SKA radiation limits defined by SARAS in [1], including an additional 10 dB safety margin, are used as the reference level. This defines the maximum allowable levels of radiated interference than can be tolerated at the telescope.

This maximum level, which is given as a power spectral density (PSD) in dBm/Hz , is compensated for by the TPL as predicted by SPLAT!, to provide an equivalent PSD associated with the closest and core-site telescopes. This PSD for each case is then converted to an equivalent electric field (E-field) as measured at either 10 m (frequency < 1 GHz) or 3 m (frequency > 1 GHz) away from the plant. The 3 and 10 m separation distances is in accordance with measurement specifications defined in the latest international special committee on radio interference's (CISPR) 11/22 Class B standard. This standard is used for reference purposes as it is internationally know and used for industry qualification. This calculation is done for a number of representative frequencies within the band of interest and defines an E-field upper limit which the plant is allowed to radiate without exceeding emission limits at the various telescope locations. Ultimately, conformance of the plant can then be determined by comparing representative measured results to the calculated levels provided.

SPLAT! Analysis Parameters	
Frequency [MHz]	100 - 3000
Earth Dielectric Constant (Relative Permittivity [F/m])	4.000
Earth Conductivity [S/m]	0.001
Atmospheric Bending Constant	301
Radio Climate	4 (Desert)
Polarisation (Vertical=1; Horizontal=0)	1
Fraction of Time	0.05
Fraction of Situations	0.05

Table 21: SPLAT! parameters for predicted 100 MHz to 3 GHz emissions from proposed PV projects to SKA core and closest telescope.

4 Total Path Loss

Shown in Tables 22 to 41 are the values for the free space path loss (FSPL), terrain loss (TL), and total path loss (TPL) at each of the frequencies chosen for the investigation. The 0 dB TL at 100 MHz is a purely mathematical limitation of the software indicating a negligible contribution at that frequency over this particular terrain. The attenuation maps for 100, 1000, 2000 and 3000 MHz calculated at each of the site location are given in Figs. 12 to 31.

4.1 Boven PV1 Site Location

Frequency	Closest Telescope 1			Closest Telescope 2			SKA Core Site		
	FSPL	TL	TPL	FSPL	TL	TPL	FSPL	TL	TPL
100MHz	97.24dB	7.21dB	104.45dB	107.32dB	17.22dB	124.54dB	117.11dB	28.82dB	145.93dB
300MHz	106.78dB	0.0dB	106.78dB	116.86dB	11.61dB	128.47dB	126.65dB	30.53dB	157.18dB
500MHz	111.22dB	0.0dB	111.22dB	121.3dB	10.71dB	132.01dB	131.09dB	33.05dB	164.14dB
1000MHz	117.24dB	0.0dB	117.24dB	127.32dB	11.7dB	139.02dB	137.11dB	38.43dB	175.54dB
1500MHz	120.76dB	0.0dB	120.76dB	130.84dB	12.67dB	143.51dB	140.63dB	40.79dB	181.42dB
2000MHz	123.26dB	0.0dB	123.26dB	133.34dB	13.63dB	146.97dB	143.13dB	42.36dB	185.49dB
2500MHz	125.19dB	0.0dB	125.19dB	135.28dB	14.53dB	149.81dB	145.07dB	43.52dB	188.59dB
3000MHz	126.78dB	0.0dB	126.78dB	136.86dB	15.39dB	152.25dB	146.65dB	44.46dB	191.11dB

Table 22: SPLAT! Free Space Path Loss (FSPL), Terrain Loss (TL) and Total Path Loss (TPL) for vertical polarisation site Boven PV1 emissions.

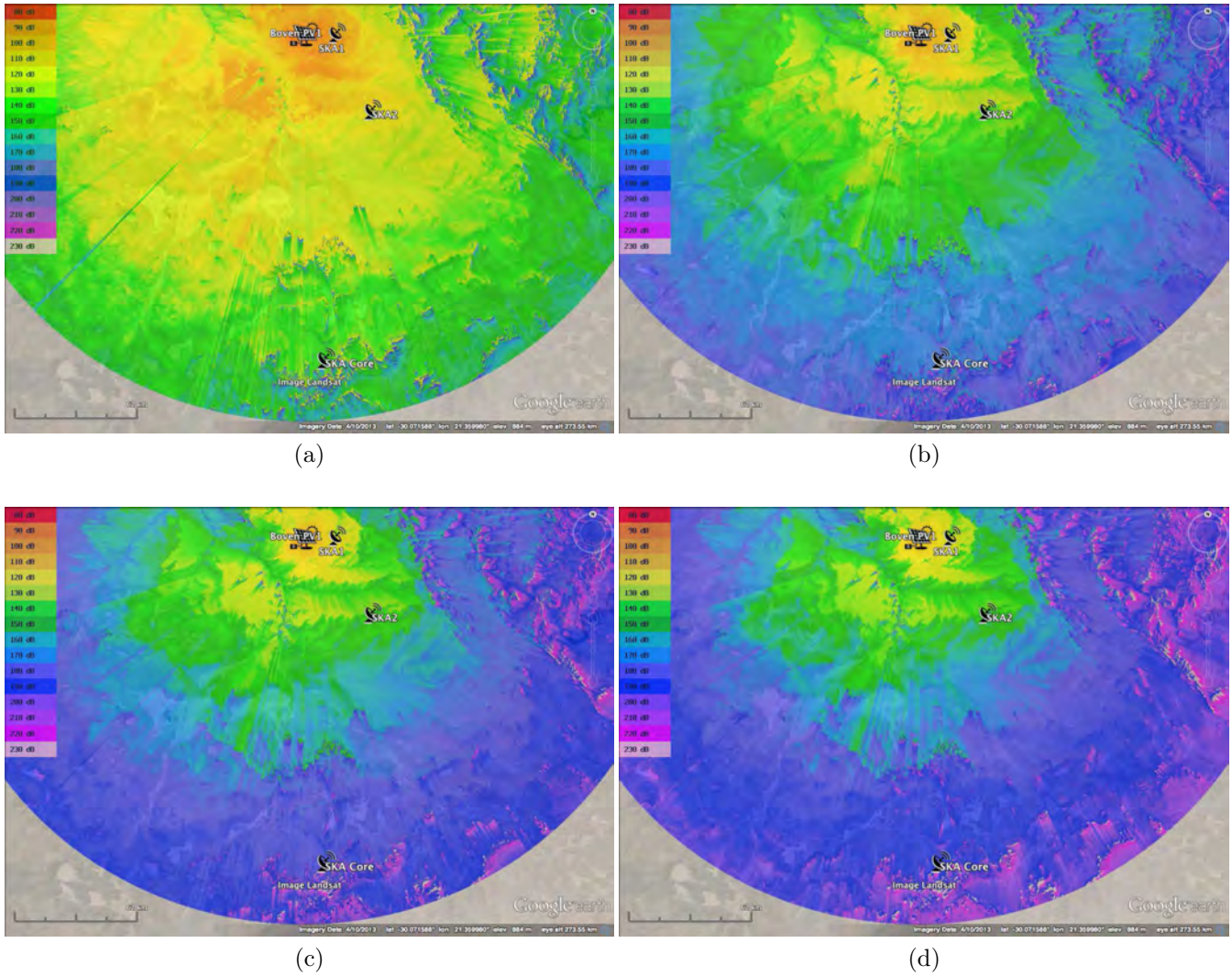

Figure 12: TPL attenuation maps for site location of Boven PV1 to the closest and core SKA telescopes for (a) 100 MHz (b) 1000 MHz (c) 2000 MHz and (d) 3000 MHz.

4.2 Boven PV2 Site Location

4.2.1 Boven PV2 Preferred Site Location

Frequency	Closest Telescope 1			Closest Telescope 2			SKA Core Site		
	FSPL	TL	TPL	FSPL	TL	TPL	FSPL	TL	TPL
100MHz	96.35dB	9.89dB	106.24dB	106.96dB	19.16dB	126.12dB	117.03dB	28.24dB	145.27dB
300MHz	105.89dB	1.91dB	107.8dB	116.5dB	13.49dB	129.99dB	126.57dB	30.09dB	156.66dB
500MHz	110.33dB	0.0dB	110.33dB	120.94dB	12.54dB	133.48dB	131.01dB	32.71dB	163.72dB
1000MHz	116.35dB	0.0dB	116.35dB	126.96dB	13.45dB	140.41dB	137.03dB	38.18dB	175.21dB
1500MHz	119.87dB	0.0dB	119.87dB	130.48dB	14.41dB	144.89dB	140.55dB	40.57dB	181.12dB
2000MHz	122.37dB	0.0dB	122.37dB	132.98dB	15.38dB	148.36dB	143.05dB	42.15dB	185.2dB
2500MHz	124.31dB	0.0dB	124.31dB	134.92dB	16.31dB	151.23dB	144.99dB	43.32dB	188.31dB
3000MHz	125.89dB	0.0dB	125.89dB	136.5dB	17.18dB	153.68dB	146.57dB	44.26dB	190.83dB

Table 23: SPLAT! Free Space Path Loss (FSPL), Terrain Loss (TL) and Total Path Loss (TPL) for vertical polarisation preferred site Boven PV2 emissions.

4.2.2 Boven PV2 Alternative Site Location

Frequency	Closest Telescope 1			Closest Telescope 2			SKA Core Site		
	FSPL	TL	TPL	FSPL	TL	TPL	FSPL	TL	TPL
100MHz	94.37dB	20.47dB	114.84dB	106.75dB	40.07dB	146.82dB	117.06dB	34.54dB	151.6dB
300MHz	103.91dB	16.13dB	120.04dB	116.29dB	36.53dB	152.82dB	126.61dB	38.39dB	165.0dB
500MHz	108.35dB	15.23dB	123.58dB	120.73dB	36.68dB	157.41dB	131.04dB	40.36dB	171.4dB
1000MHz	114.37dB	15.55dB	129.92dB	126.75dB	39.76dB	166.51dB	137.06dB	43.52dB	180.58dB
1500MHz	117.89dB	17.09dB	134.98dB	130.27dB	42.09dB	172.36dB	140.59dB	44.88dB	185.47dB
2000MHz	120.39dB	18.56dB	138.95dB	132.77dB	43.98dB	176.75dB	143.08dB	45.91dB	188.99dB
2500MHz	122.33dB	19.72dB	142.05dB	134.71dB	44.87dB	179.58dB	145.02dB	46.76dB	191.78dB
3000MHz	123.91dB	20.82dB	144.73dB	136.29dB	45.56dB	181.85dB	146.61dB	47.49dB	194.1dB

Table 24: SPLAT! Free Space Path Loss (FSPL), Terrain Loss (TL) and Total Path Loss (TPL) for vertical polarisation alternative site Boven PV2 emissions.

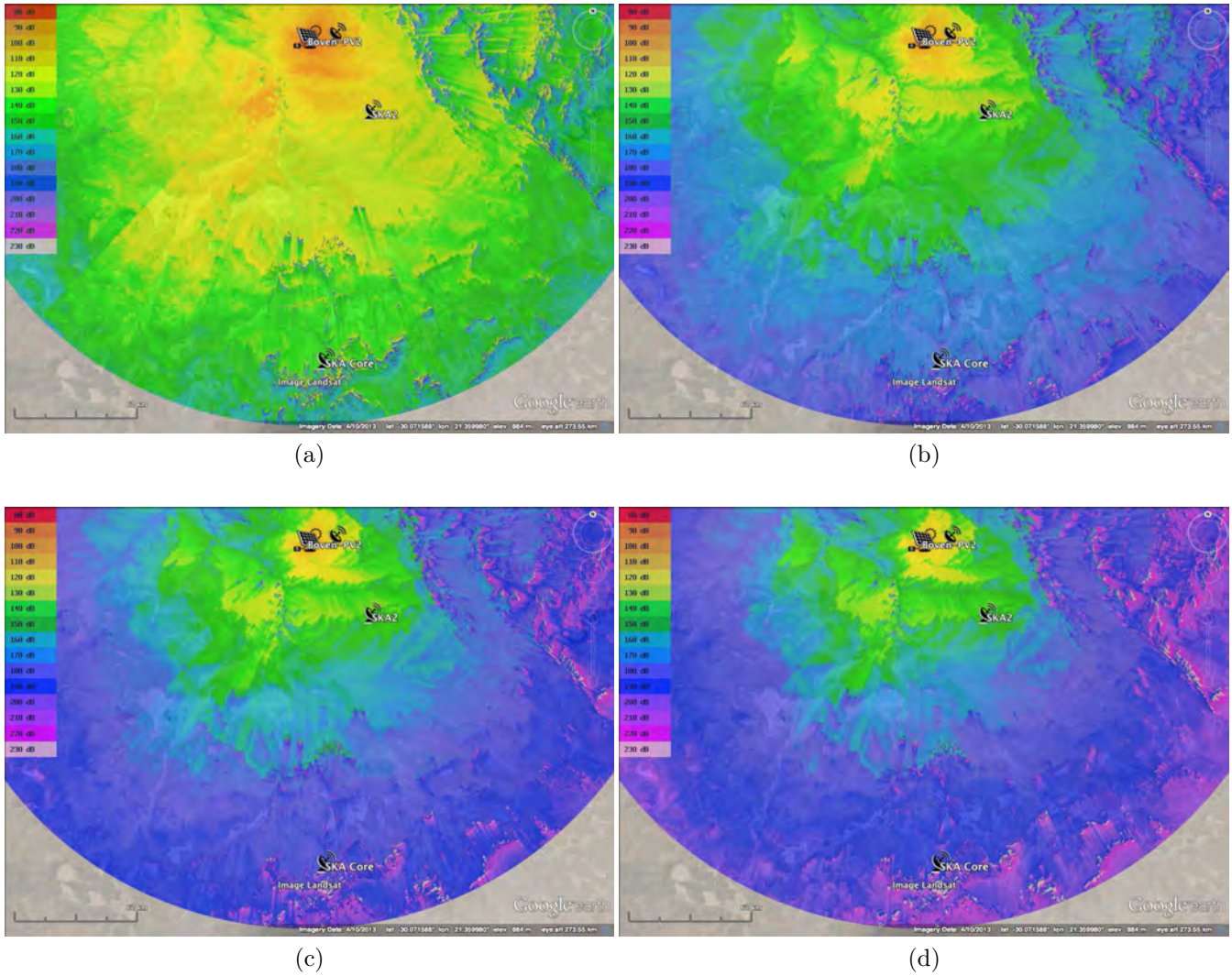

Figure 13: TPL attenuation maps for preferred site location of Boven PV2 to the closest and core SKA telescopes for (a) 100 MHz (b) 1000 MHz (c) 2000 MHz and (d) 3000 MHz.

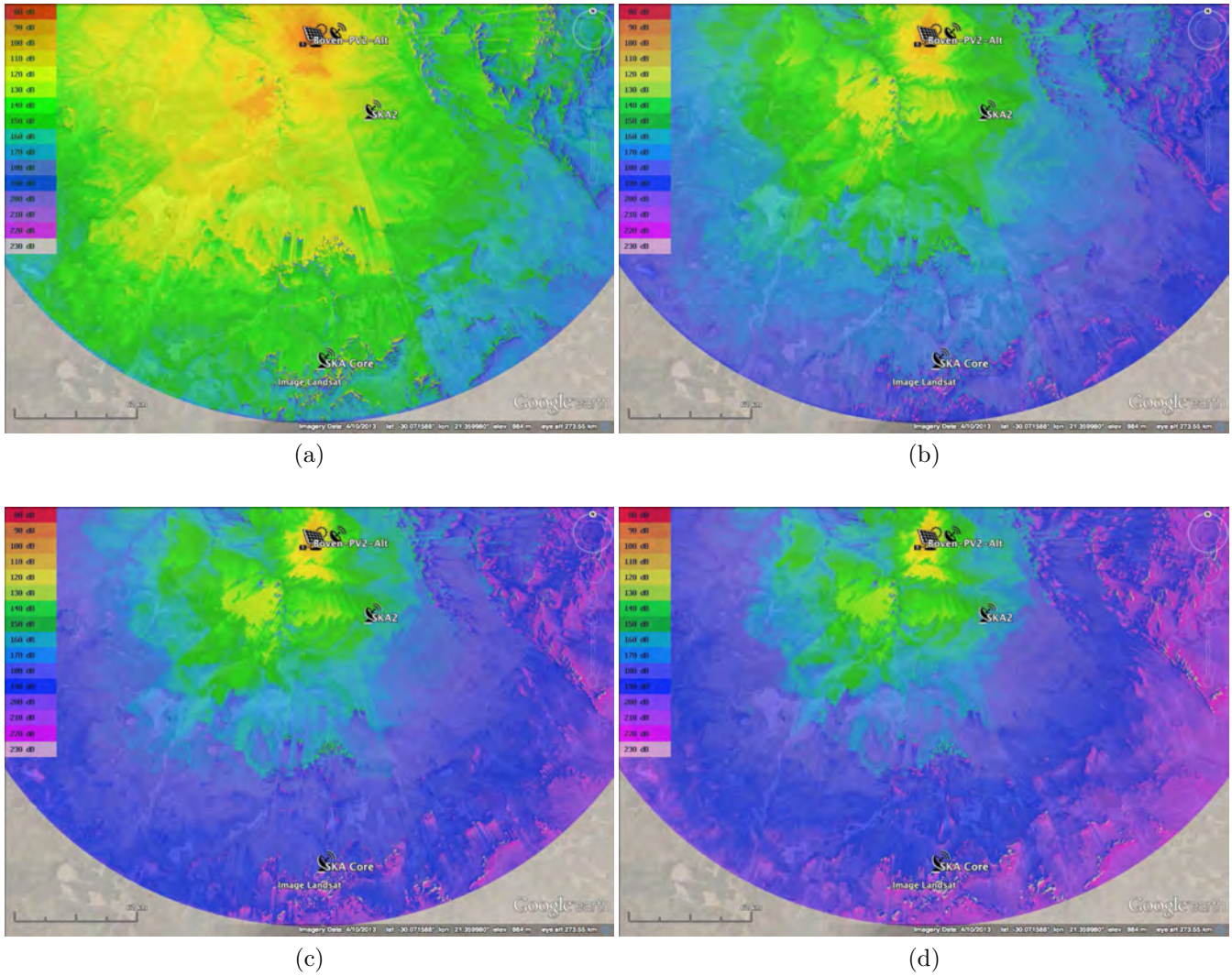

Figure 14: TPL attenuation maps for **alternative** site location of Boven PV2 to the closest and core SKA telescopes for (a) 100 MHz (b) 1000 MHz (c) 2000 MHz and (d) 3000 MHz.

4.3 Boven PV3 Site Location

4.3.1 Boven PV3 Preferred Site Location

Frequency	Closest Telescope 1			Closest Telescope 2			SKA Core Site		
	FSPL	TL	TPL	FSPL	TL	TPL	FSPL	TL	TPL
100MHz	96.4dB	14.84dB	111.24dB	106.43dB	27.93dB	134.36dB	116.85dB	37.22dB	154.07dB
300MHz	105.94dB	6.35dB	112.29dB	115.98dB	23.3dB	139.28dB	126.39dB	35.02dB	161.41dB
500MHz	110.38dB	2.78dB	113.16dB	120.41dB	22.83dB	143.24dB	130.83dB	36.95dB	167.78dB
1000MHz	116.4dB	0.0dB	116.4dB	126.43dB	24.64dB	151.07dB	136.85dB	41.82dB	178.67dB
1500MHz	119.92dB	0.0dB	119.92dB	129.96dB	26.23dB	156.19dB	140.37dB	44.02dB	184.39dB
2000MHz	122.42dB	0.0dB	122.42dB	132.46dB	27.74dB	160.2dB	142.87dB	45.49dB	188.36dB
2500MHz	124.36dB	0.0dB	124.36dB	134.39dB	29.1dB	163.49dB	144.81dB	46.61dB	191.42dB
3000MHz	125.94dB	0.0dB	125.94dB	135.98dB	30.29dB	166.27dB	146.39dB	47.51dB	193.9dB

Table 25: SPLAT! Free Space Path Loss (FSPL), Terrain Loss (TL) and Total Path Loss (TPL) for vertical polarisation preferred site Boven PV3 emissions.

4.3.2 Boven PV3 Alternative Site Location

Frequency	Closest Telescope 1			Closest Telescope 2			SKA Core Site		
	FSPL	TL	TPL	FSPL	TL	TPL	FSPL	TL	TPL
100MHz	95.25dB	19.28dB	114.53dB	106.47dB	29.2dB	135.67dB	116.93dB	35.52dB	152.45dB
300MHz	104.79dB	13.64dB	118.43dB	116.01dB	22.11dB	138.12dB	126.47dB	34.12dB	160.59dB
500MHz	109.23dB	11.02dB	120.25dB	120.45dB	20.61dB	141.06dB	130.9dB	36.33dB	167.23dB
1000MHz	115.25dB	8.35dB	123.6dB	126.47dB	21.35dB	147.82dB	136.93dB	41.43dB	178.36dB
1500MHz	118.77dB	7.28dB	126.05dB	129.99dB	22.42dB	152.41dB	140.45dB	43.71dB	184.16dB
2000MHz	121.27dB	6.94dB	128.21dB	132.49dB	23.61dB	156.1dB	142.95dB	45.19dB	188.14dB
2500MHz	123.21dB	7.07dB	130.28dB	134.42dB	24.82dB	159.24dB	144.88dB	46.32dB	191.2dB
3000MHz	124.79dB	7.19dB	131.98dB	136.01dB	26.06dB	162.07dB	146.47dB	47.21dB	193.68dB

Table 26: SPLAT! Free Space Path Loss (FSPL), Terrain Loss (TL) and Total Path Loss (TPL) for vertical polarisation alternative site Boven PV3 emissions.

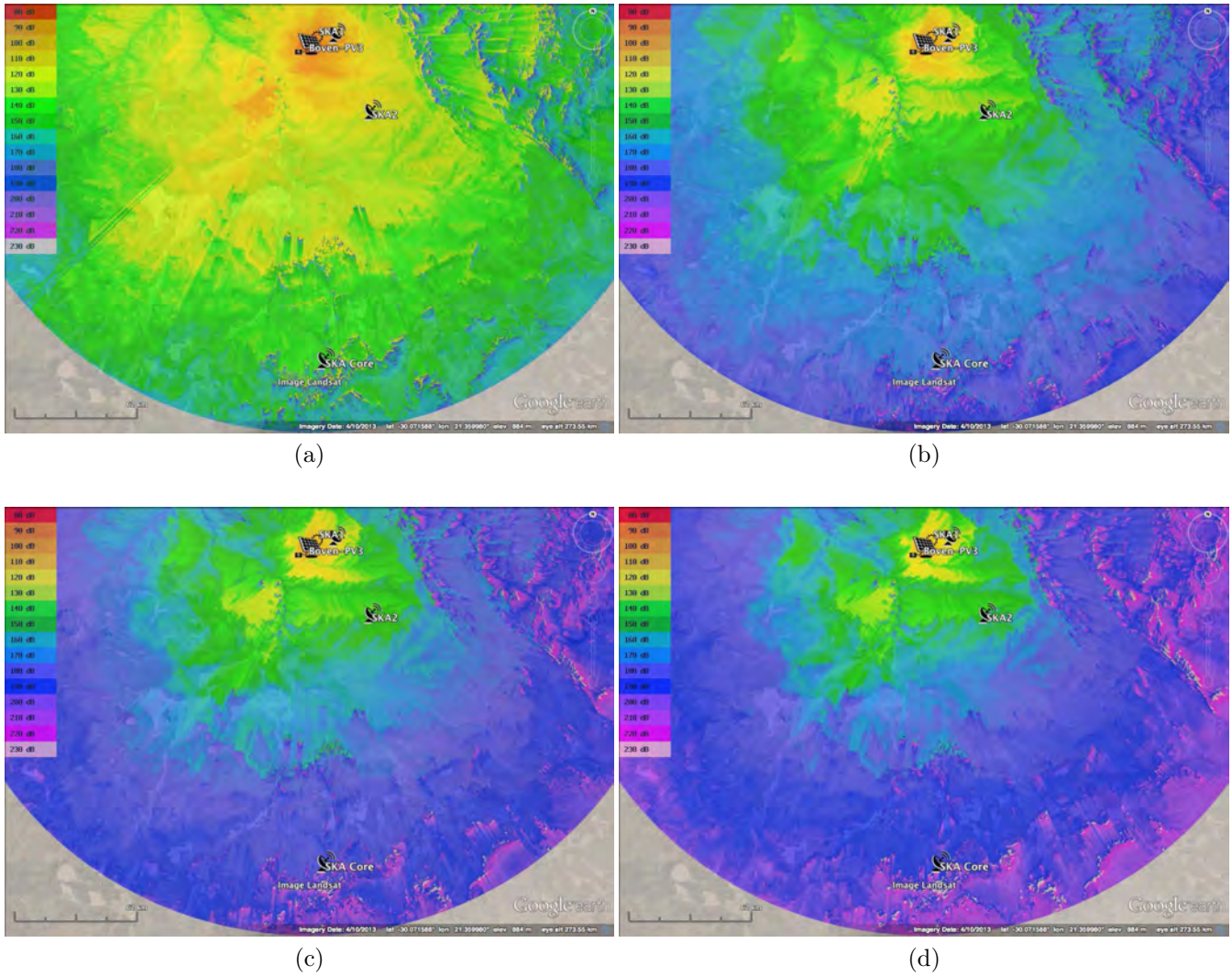

Figure 15: TPL attenuation maps for preferred site location of Boven PV3 to the closest and core SKA telescopes for (a) 100 MHz (b) 1000 MHz (c) 2000 MHz and (d) 3000 MHz.

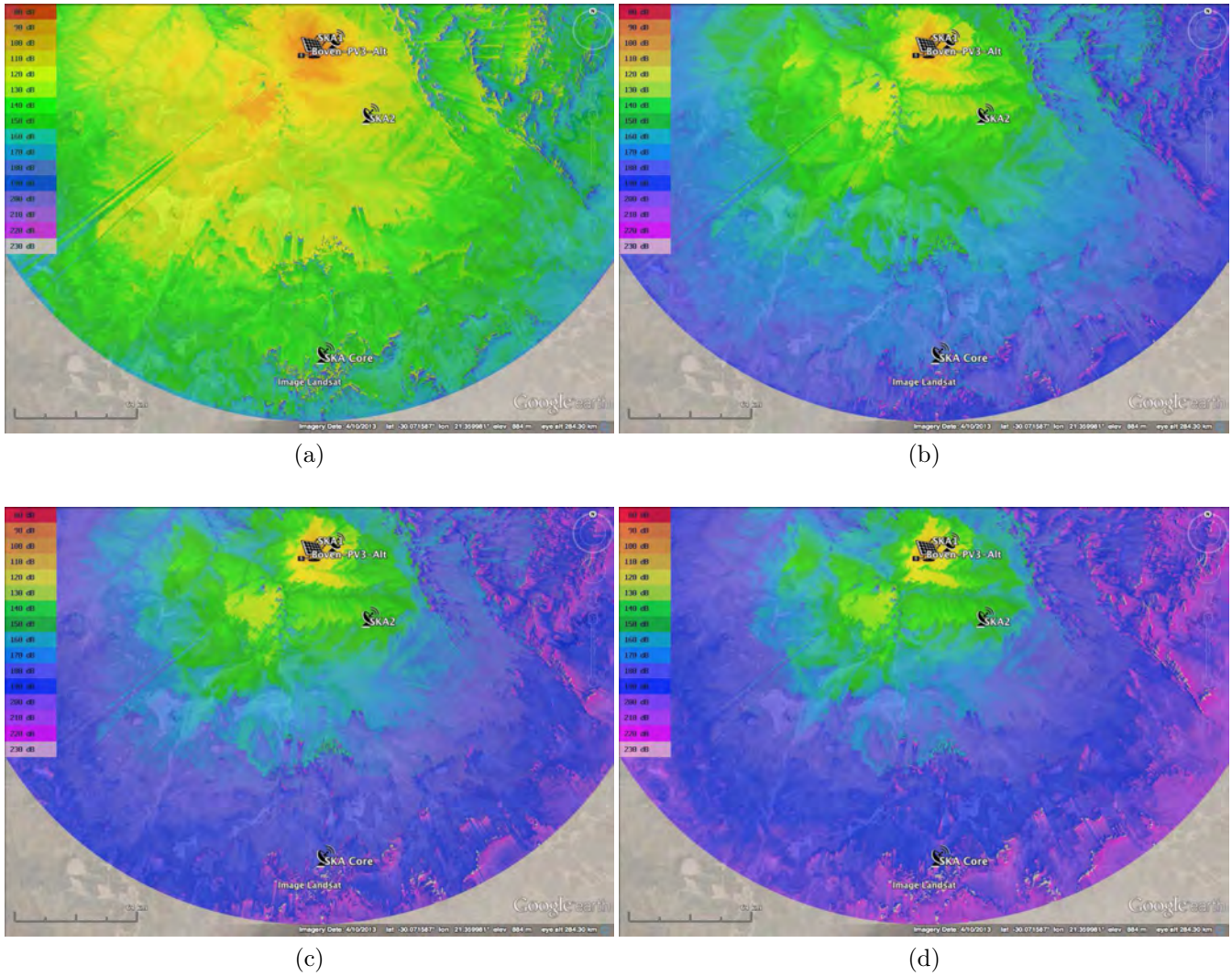

Figure 16: TPL attenuation maps for **alternative** site location of Boven PV3 to the closest and core SKA telescopes for (a) 100 MHz (b) 1000 MHz (c) 2000 MHz and (d) 3000 MHz.

4.4 Boven PV4 Site Location

4.4.1 Boven PV4 Preferred Site Location

Frequency	Closest Telescope 1			Closest Telescope 2			SKA Core Site		
	FSPL	TL	TPL	FSPL	TL	TPL	FSPL	TL	TPL
100MHz	97.5dB	8.88dB	106.38dB	106.62dB	24.55dB	131.17dB	116.83dB	30.34dB	147.17dB
300MHz	107.04dB	0.51dB	107.55dB	116.16dB	19.93dB	136.09dB	126.37dB	30.91dB	157.28dB
500MHz	111.48dB	0.0dB	111.48dB	120.6dB	19.39dB	139.99dB	130.81dB	33.43dB	164.24dB
1000MHz	117.5dB	0.0dB	117.5dB	126.62dB	21.0dB	147.62dB	136.83dB	38.85dB	175.68dB
1500MHz	121.02dB	0.0dB	121.02dB	130.14dB	22.44dB	152.58dB	140.35dB	41.2dB	181.55dB
2000MHz	123.52dB	0.0dB	123.52dB	132.64dB	23.77dB	156.41dB	142.85dB	42.75dB	185.6dB
2500MHz	125.45dB	0.0dB	125.45dB	134.58dB	24.99dB	159.57dB	144.79dB	43.92dB	188.71dB
3000MHz	127.04dB	0.0dB	127.04dB	136.16dB	26.09dB	162.25dB	146.37dB	44.86dB	191.23dB

Table 27: SPLAT! Free Space Path Loss (FSPL), Terrain Loss (TL) and Total Path Loss (TPL) for vertical polarisation preferred site Boven PV4 emissions.

4.4.2 Boven PV4 Alternative Site Location

Frequency	Closest Telescope 1			Closest Telescope 2			SKA Core Site		
	FSPL	TL	TPL	FSPL	TL	TPL	FSPL	TL	TPL
100MHz	97.85dB	14.26dB	112.11dB	106.31dB	28.21dB	134.52dB	116.71dB	33.63dB	150.34dB
300MHz	107.39dB	6.09dB	113.48dB	115.85dB	23.98dB	139.83dB	126.25dB	32.17dB	158.42dB
500MHz	111.83dB	2.74dB	114.57dB	120.29dB	23.59dB	143.88dB	130.69dB	34.53dB	165.22dB
1000MHz	117.85dB	0.0dB	117.85dB	126.31dB	25.52dB	151.83dB	136.71dB	39.82dB	176.53dB
1500MHz	121.37dB	0.0dB	121.37dB	129.83dB	27.17dB	157.0dB	140.23dB	42.14dB	182.37dB
2000MHz	123.87dB	0.0dB	123.87dB	132.33dB	28.64dB	160.97dB	142.73dB	43.67dB	186.4dB
2500MHz	125.81dB	0.0dB	125.81dB	134.27dB	29.94dB	164.21dB	144.66dB	44.83dB	189.49dB
3000MHz	127.39dB	0.0dB	127.39dB	135.85dB	31.1dB	166.95dB	146.25dB	45.75dB	192.0dB

Table 28: SPLAT! Free Space Path Loss (FSPL), Terrain Loss (TL) and Total Path Loss (TPL) for vertical polarisation alternative site Boven PV4 emissions.

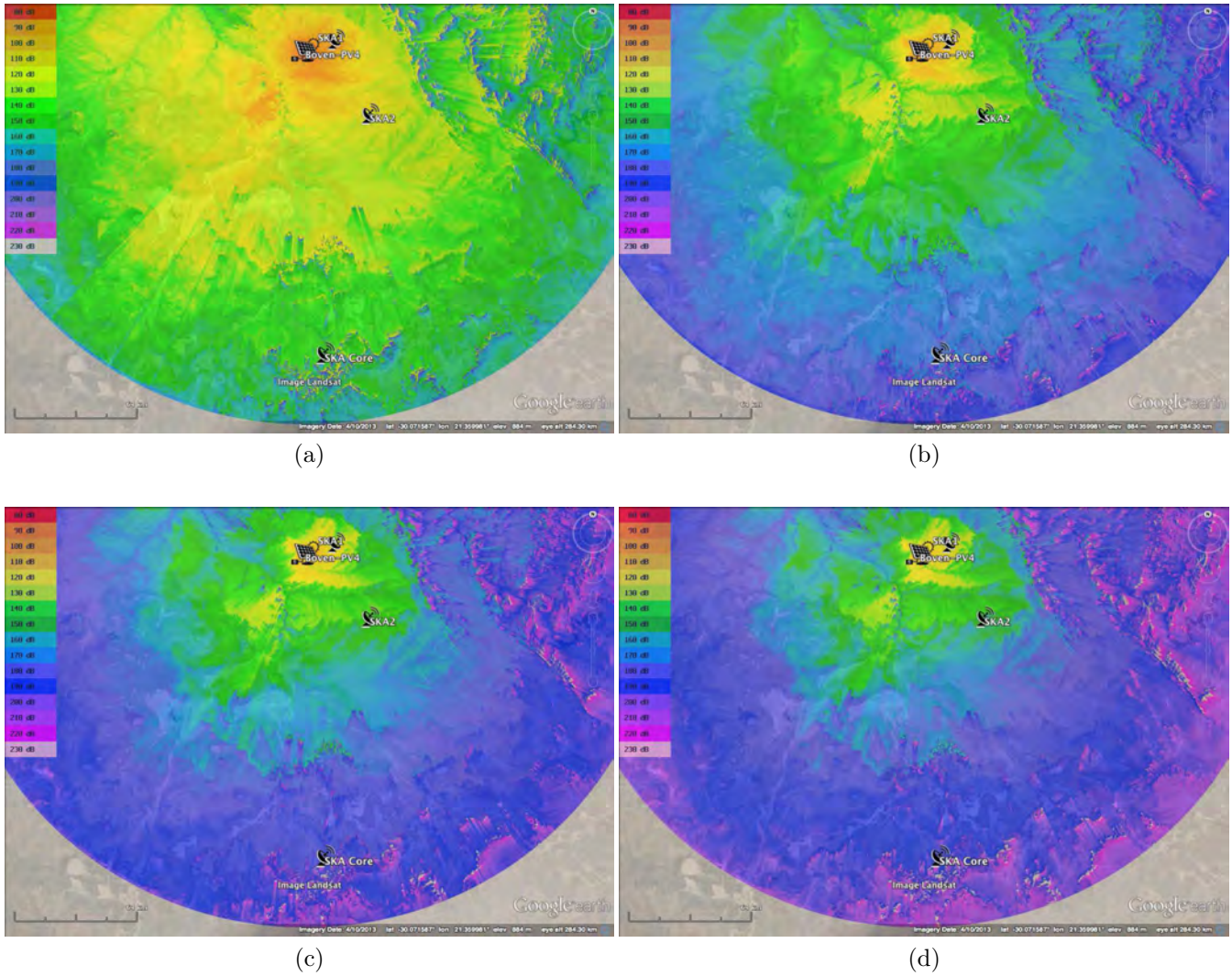

Figure 17: TPL attenuation maps for preferred site location of Boven PV4 to the closest and core SKA telescopes for (a) 100 MHz (b) 1000 MHz (c) 2000 MHz and (d) 3000 MHz.

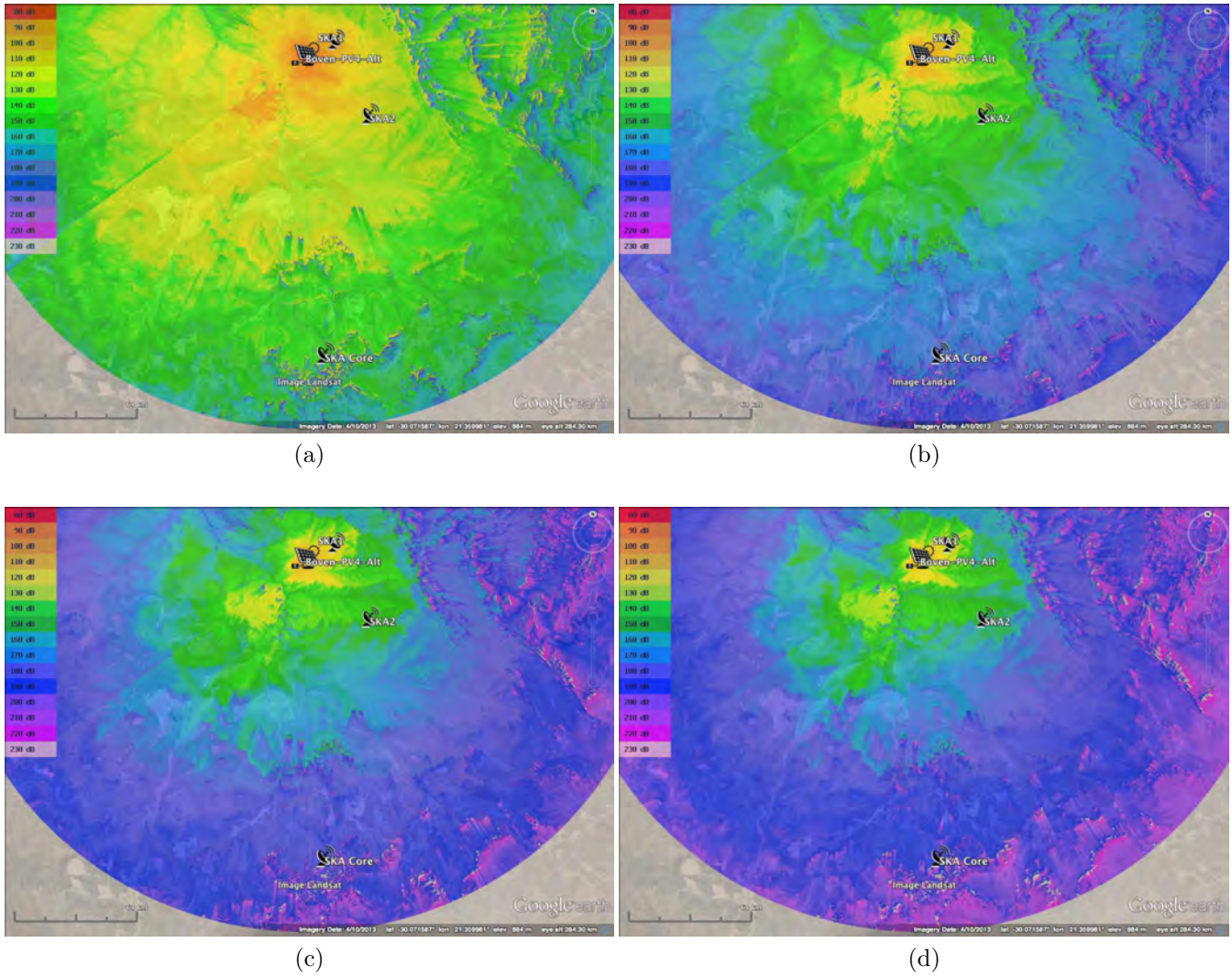

Figure 18: TPL attenuation maps for **alternative** site location of Boven PV4 to the closest and core SKA telescopes for (a) 100 MHz (b) 1000 MHz (c) 2000 MHz and (d) 3000 MHz.

4.5 Gemsbok PV1 Site Location

Frequency	Closest Telescope 1			Closest Telescope 2			SKA Core Site		
	FSPL	TL	TPL	FSPL	TL	TPL	FSPL	TL	TPL
100MHz	98.07dB	25.55dB	123.62dB	108.07dB	25.82dB	133.89dB	117.38dB	47.18dB	164.56dB
300MHz	107.62dB	20.83dB	128.45dB	117.61dB	18.67dB	136.28dB	126.93dB	42.44dB	169.37dB
500MHz	112.05dB	19.71dB	131.76dB	122.05dB	18.41dB	140.46dB	131.36dB	43.12dB	174.48dB
1000MHz	118.07dB	19.69dB	137.76dB	128.07dB	22.52dB	150.59dB	137.38dB	46.33dB	183.71dB
1500MHz	121.6dB	20.46dB	142.06dB	131.59dB	25.11dB	156.7dB	140.91dB	47.79dB	188.7dB
2000MHz	124.09dB	21.31dB	145.4dB	134.09dB	27.08dB	161.17dB	143.41dB	48.88dB	192.29dB
2500MHz	126.03dB	22.05dB	148.08dB	136.03dB	28.68dB	164.71dB	145.34dB	49.78dB	195.12dB
3000MHz	127.62dB	22.7dB	150.32dB	137.61dB	29.94dB	167.55dB	146.93dB	50.54dB	197.47dB

Table 29: SPLAT! Free Space Path Loss (FSPL), Terrain Loss (TL) and Total Path Loss (TPL) for vertical polarisation preferred site Gemsbok PV1 emissions.

4.6 Gemsbok PV2 Site Location

Frequency	Closest Telescope 1			Closest Telescope 2			SKA Core Site		
	FSPL	TL	TPL	FSPL	TL	TPL	FSPL	TL	TPL
100MHz	96.6dB	24.61dB	121.21dB	107.77dB	28.62dB	136.39dB	117.36dB	42.67dB	160.03dB
300MHz	106.14dB	18.66dB	124.8dB	117.31dB	19.64dB	136.95dB	126.9dB	40.76dB	167.66dB
500MHz	110.58dB	17.02dB	127.6dB	121.75dB	18.42dB	140.17dB	131.34dB	41.51dB	172.85dB
1000MHz	116.6dB	16.31dB	132.91dB	127.77dB	21.37dB	149.14dB	137.36dB	44.85dB	182.21dB
1500MHz	120.12dB	16.69dB	136.81dB	131.29dB	23.52dB	154.81dB	140.88dB	46.39dB	187.27dB
2000MHz	122.62dB	17.31dB	139.93dB	133.79dB	25.19dB	158.98dB	143.38dB	47.52dB	190.9dB
2500MHz	124.56dB	17.93dB	142.49dB	135.73dB	26.59dB	162.32dB	145.32dB	48.44dB	193.76dB
3000MHz	126.14dB	18.52dB	144.66dB	137.31dB	27.83dB	165.14dB	146.9dB	49.22dB	196.12dB

Table 30: SPLAT! Free Space Path Loss (FSPL), Terrain Loss (TL) and Total Path Loss (TPL) for vertical polarisation preferred site Gemsbok PV2 emissions.

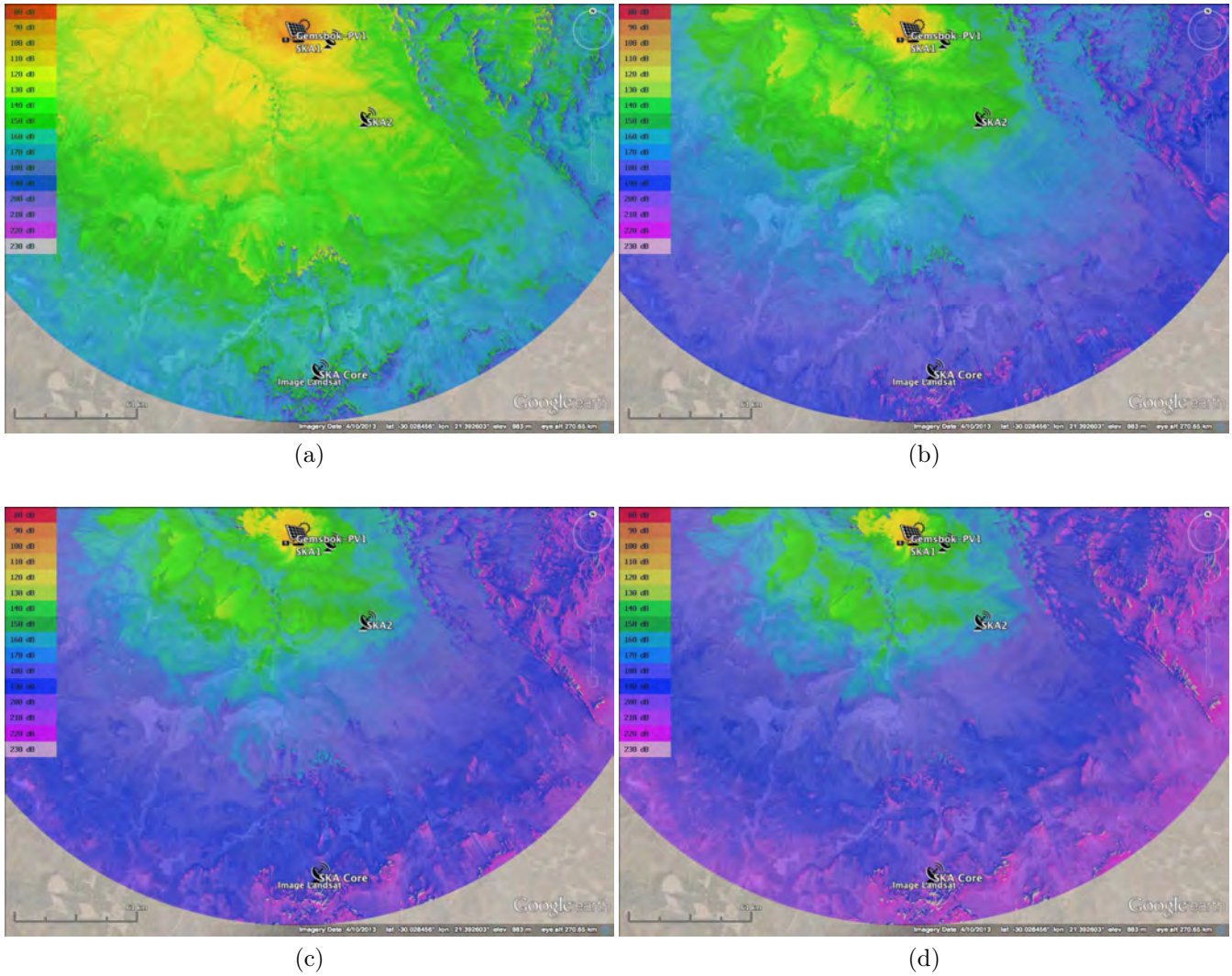

Figure 19: TPL attenuation maps for site location of Gemsbok PV1 to the closest and core SKA telescopes for (a) 100 MHz (b) 1000 MHz (c) 2000 MHz and (d) 3000 MHz.

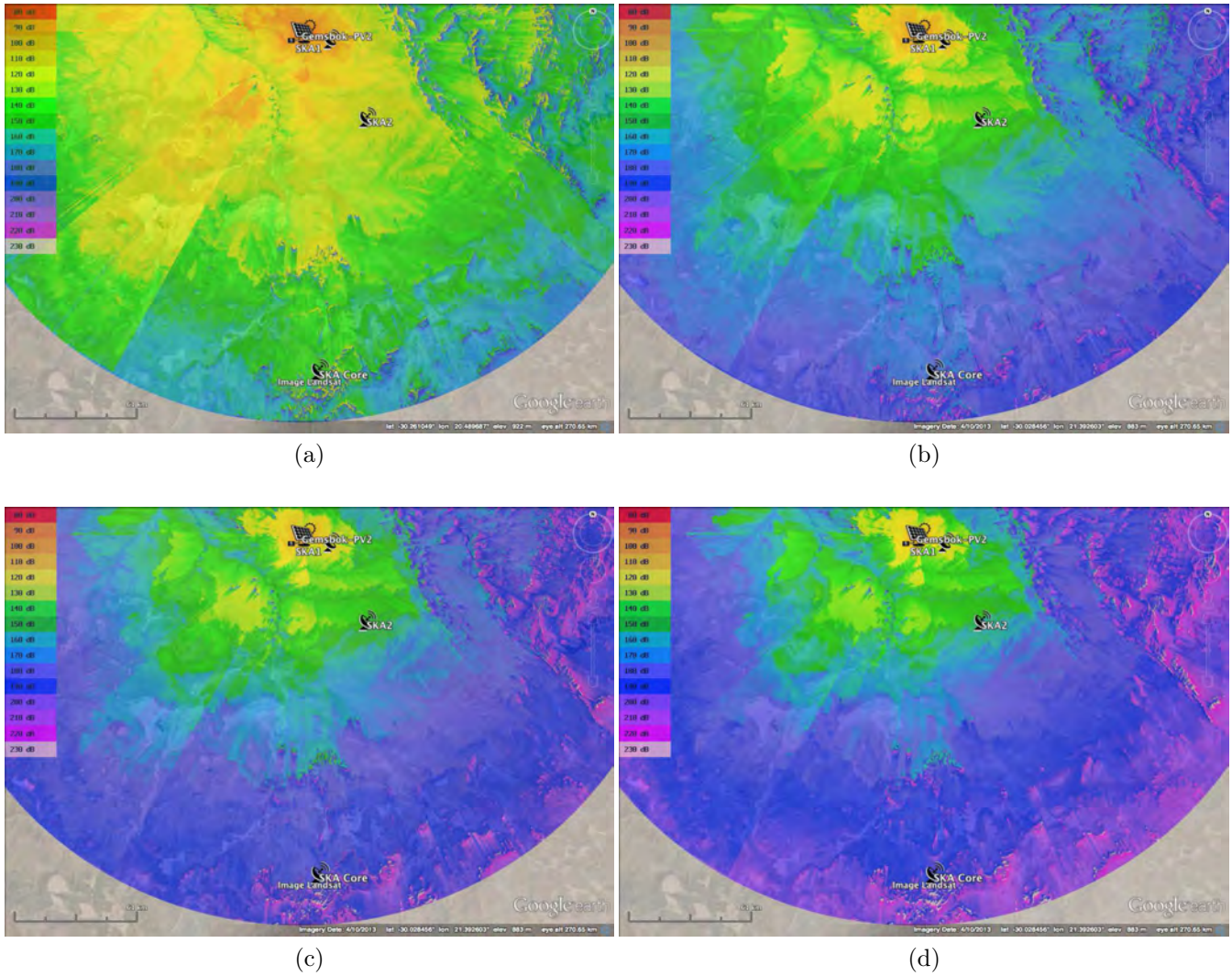

Figure 20: TPL attenuation maps for site location of Gemsbok PV2 to the closest and core SKA telescopes for (a) 100 MHz (b) 1000 MHz (c) 2000 MHz and (d) 3000 MHz.

4.7 Gemsbok PV3 Site Location

4.7.1 Gemsbok PV3 Preferred Site Location

Frequency	Closest Telescope 1			Closest Telescope 2			SKA Core Site		
	FSPL	TL	TPL	FSPL	TL	TPL	FSPL	TL	TPL
100MHz	97.99dB	25.22dB	123.21dB	108.12dB	25.82dB	133.94dB	117.42dB	39.45dB	156.87dB
300MHz	107.53dB	20.88dB	128.41dB	117.66dB	18.16dB	135.82dB	126.96dB	37.44dB	164.4dB
500MHz	111.97dB	20.06dB	132.03dB	122.1dB	17.61dB	139.71dB	131.4dB	38.83dB	170.23dB
1000MHz	117.99dB	20.88dB	138.87dB	128.12dB	21.2dB	149.32dB	137.42dB	43.0dB	180.42dB
1500MHz	121.51dB	22.26dB	143.77dB	131.64dB	23.86dB	155.5dB	140.94dB	44.94dB	185.88dB
2000MHz	124.01dB	23.39dB	147.4dB	134.14dB	25.99dB	160.13dB	143.44dB	46.29dB	189.73dB
2500MHz	125.95dB	24.34dB	150.29dB	136.08dB	27.72dB	163.8dB	145.38dB	47.34dB	192.72dB
3000MHz	127.53dB	25.35dB	152.88dB	137.66dB	29.22dB	166.88dB	146.96dB	48.2dB	195.16dB

Table 31: SPLAT! Free Space Path Loss (FSPL), Terrain Loss (TL) and Total Path Loss (TPL) for vertical polarisation **preferred** site Gemsbok PV3 emissions.

4.7.2 Gemsbok PV3 Alternative Site Location

Frequency	Closest Telescope 1			Closest Telescope 2			SKA Core Site		
	FSPL	TL	TPL	FSPL	TL	TPL	FSPL	TL	TPL
100MHz	98.2dB	18.49dB	116.69dB	107.92dB	23.74dB	131.66dB	117.29dB	44.43dB	161.72dB
300MHz	107.75dB	12.49dB	120.24dB	117.46dB	15.51dB	132.97dB	126.84dB	42.4dB	169.24dB
500MHz	112.18dB	10.59dB	122.77dB	121.9dB	14.23dB	136.13dB	131.27dB	43.11dB	174.38dB
1000MHz	118.2dB	9.57dB	127.77dB	127.92dB	16.2dB	144.12dB	137.29dB	46.37dB	183.66dB
1500MHz	121.73dB	9.76dB	131.49dB	131.44dB	18.4dB	149.84dB	140.81dB	47.85dB	188.66dB
2000MHz	124.22dB	10.06dB	134.28dB	133.94dB	20.27dB	154.21dB	143.31dB	48.95dB	192.26dB
2500MHz	126.16dB	10.56dB	136.72dB	135.87dB	21.9dB	157.77dB	145.25dB	49.85dB	195.1dB
3000MHz	127.75dB	11.06dB	138.81dB	137.46dB	23.32dB	160.78dB	146.84dB	50.62dB	197.46dB

Table 32: SPLAT! Free Space Path Loss (FSPL), Terrain Loss (TL) and Total Path Loss (TPL) for vertical polarisation **alternative** site Gemsbok PV3 emissions.

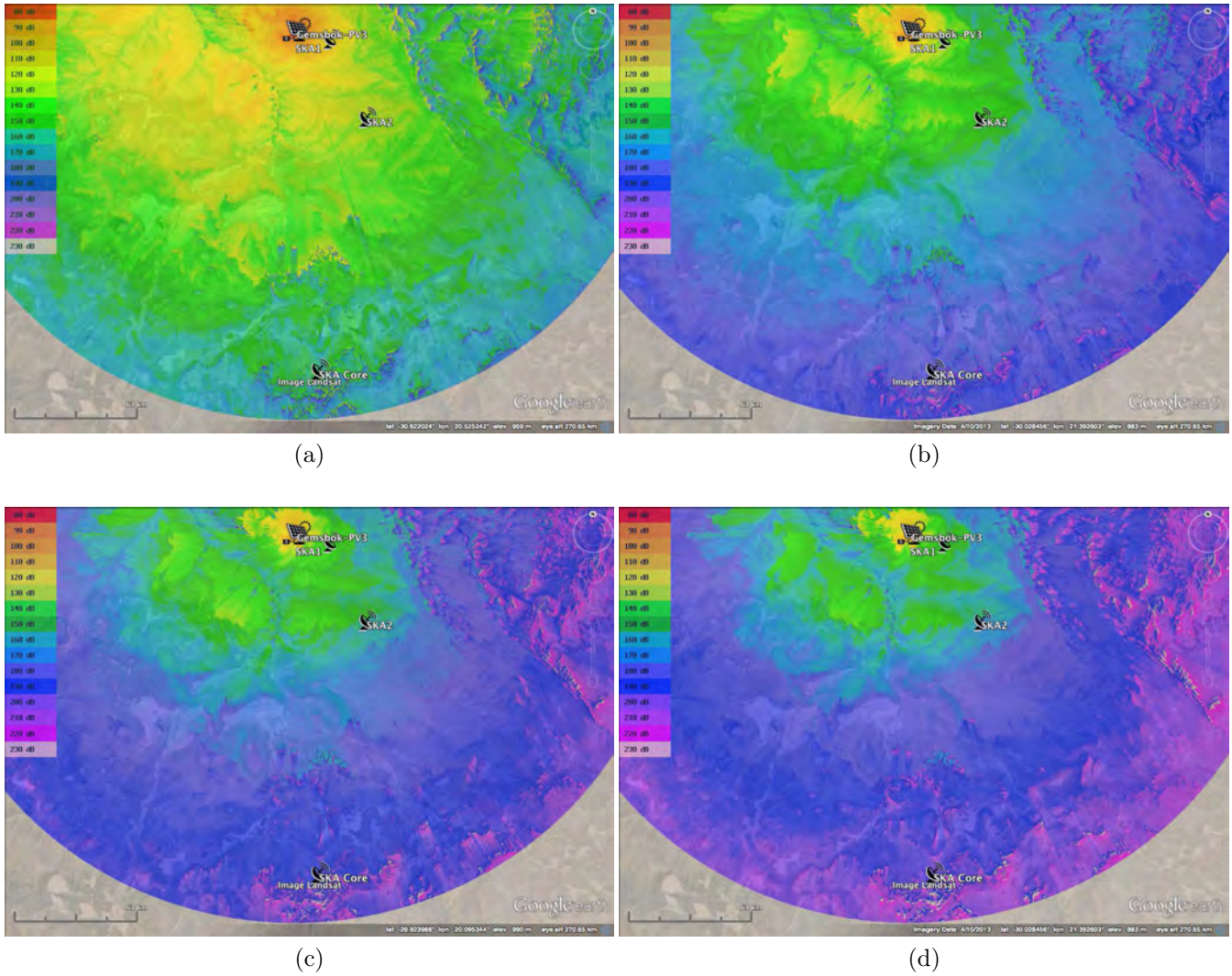

Figure 21: TPL attenuation maps for preferred site location of Gembok PV3 to the closest and core SKA telescopes for (a) 100 MHz (b) 1000 MHz (c) 2000 MHz and (d) 3000 MHz.

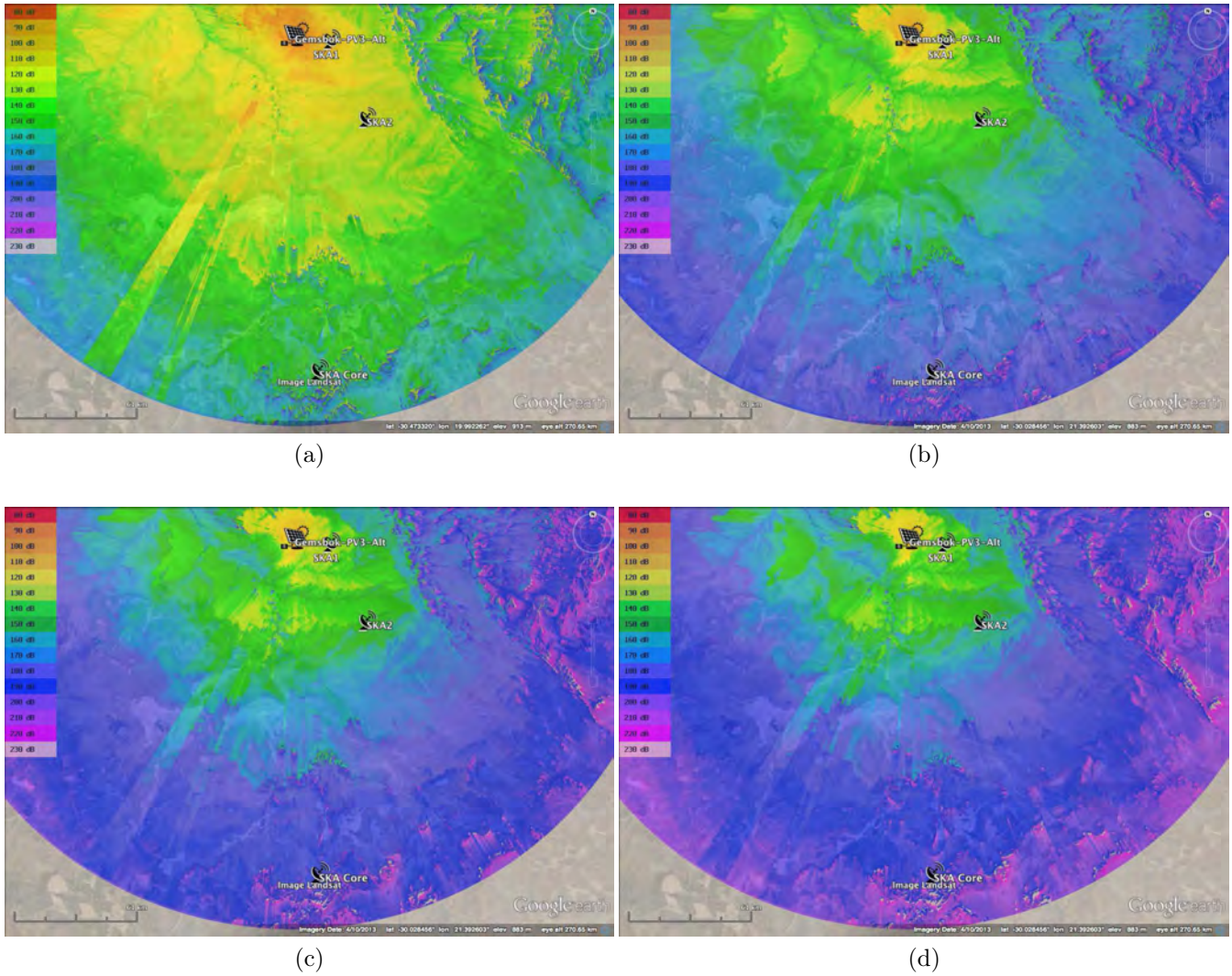

Figure 22: TPL attenuation maps for **alternative** site location of Gemsbok PV3 to the closest and core SKA telescopes for (a) 100 MHz (b) 1000 MHz (c) 2000 MHz and (d) 3000 MHz.

4.8 Gemsbok PV4 Site Location

4.8.1 Gemsbok PV4 Preferred Site Location

Frequency	Closest Telescope 1			Closest Telescope 2			SKA Core Site		
	FSPL	TL	TPL	FSPL	TL	TPL	FSPL	TL	TPL
100MHz	95.97dB	12.08dB	108.05dB	107.81dB	25.75dB	133.56dB	117.43dB	29.85dB	147.28dB
300MHz	105.51dB	6.43dB	111.94dB	117.35dB	16.16dB	133.51dB	126.97dB	30.72dB	157.69dB
500MHz	109.95dB	4.92dB	114.87dB	121.79dB	14.32dB	136.11dB	131.41dB	33.51dB	164.92dB
1000MHz	115.97dB	5.38dB	121.35dB	127.81dB	15.86dB	143.67dB	137.43dB	39.08dB	176.51dB
1500MHz	119.49dB	6.82dB	126.31dB	131.33dB	17.61dB	148.94dB	140.95dB	41.51dB	182.46dB
2000MHz	121.99dB	8.29dB	130.28dB	133.83dB	19.13dB	152.96dB	143.45dB	43.1dB	186.55dB
2500MHz	123.93dB	9.6dB	133.53dB	135.77dB	20.44dB	156.21dB	145.39dB	44.28dB	189.67dB
3000MHz	125.51dB	10.59dB	136.1dB	137.35dB	21.62dB	158.97dB	146.97dB	45.23dB	192.2dB

Table 33: SPLAT! Free Space Path Loss (FSPL), Terrain Loss (TL) and Total Path Loss (TPL) for vertical polarisation **preferred** site Gemsbok PV4 emissions.

4.8.2 Gemsbok PV4 Alternative Site Location

Frequency	Closest Telescope 1			Closest Telescope 2			SKA Core Site		
	FSPL	TL	TPL	FSPL	TL	TPL	FSPL	TL	TPL
100MHz	95.99dB	13.57dB	109.56dB	107.95dB	23.3dB	131.25dB	117.51dB	29.92dB	147.43dB
300MHz	105.54dB	8.15dB	113.69dB	117.49dB	13.5dB	130.99dB	127.05dB	30.93dB	157.98dB
500MHz	109.97dB	6.76dB	116.73dB	121.93dB	11.53dB	133.46dB	131.49dB	33.66dB	165.15dB
1000MHz	115.99dB	6.87dB	122.86dB	127.95dB	12.79dB	140.74dB	137.51dB	39.17dB	176.68dB
1500MHz	119.51dB	8.7dB	128.21dB	131.47dB	14.43dB	145.9dB	141.03dB	41.6dB	182.63dB
2000MHz	122.01dB	9.91dB	131.92dB	133.97dB	15.87dB	149.84dB	143.53dB	43.17dB	186.7dB
2500MHz	123.95dB	10.9dB	134.85dB	135.91dB	17.15dB	153.06dB	145.47dB	44.34dB	189.81dB
3000MHz	125.54dB	11.74dB	137.28dB	137.49dB	18.3dB	155.79dB	147.05dB	45.28dB	192.33dB

Table 34: SPLAT! Free Space Path Loss (FSPL), Terrain Loss (TL) and Total Path Loss (TPL) for vertical polarisation **alternative** site Gemsbok PV4 emissions.

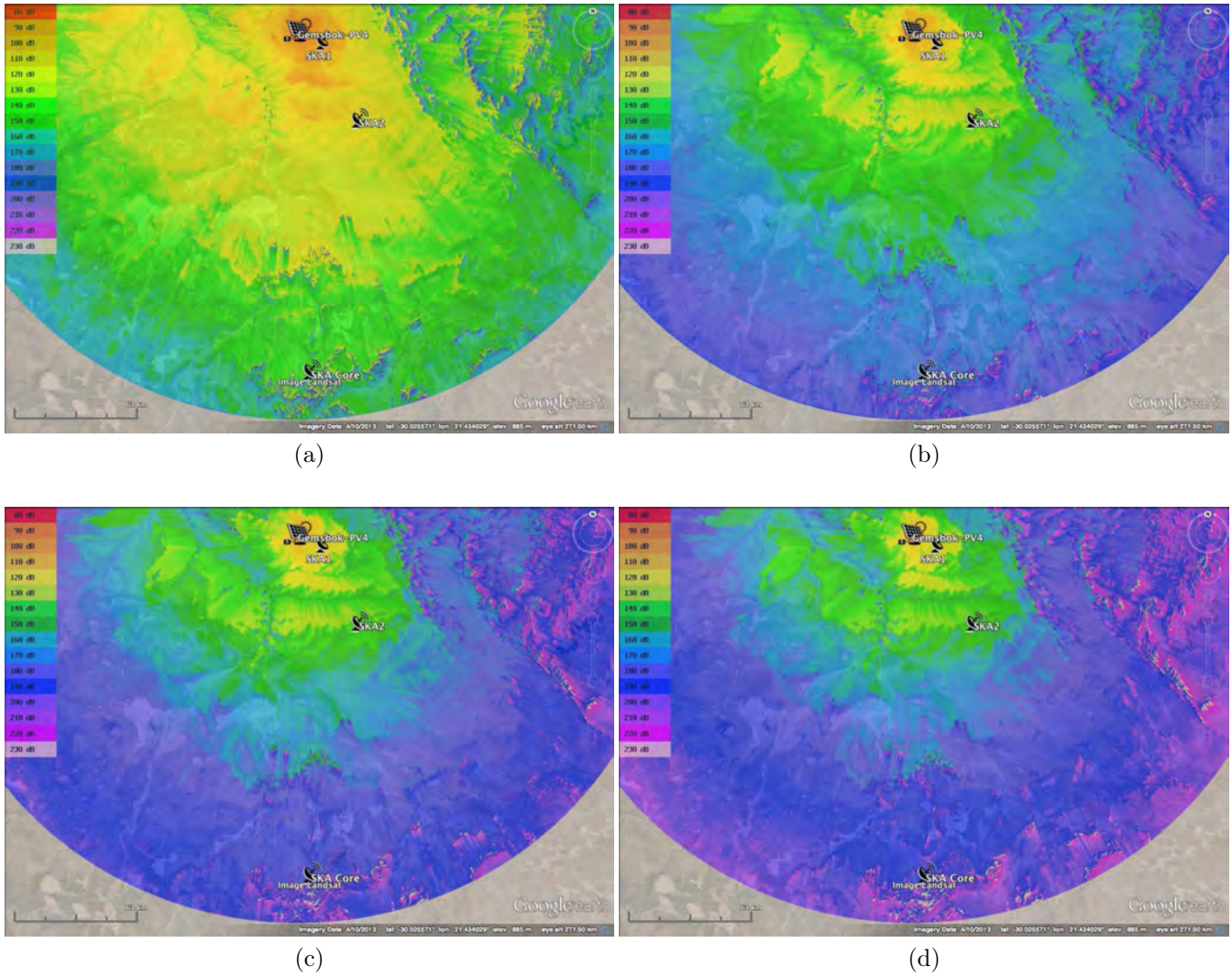

Figure 23: TPL attenuation maps for preferred site location of Gembok PV4 to the closest and core SKA telescopes for (a) 100 MHz (b) 1000 MHz (c) 2000 MHz and (d) 3000 MHz.

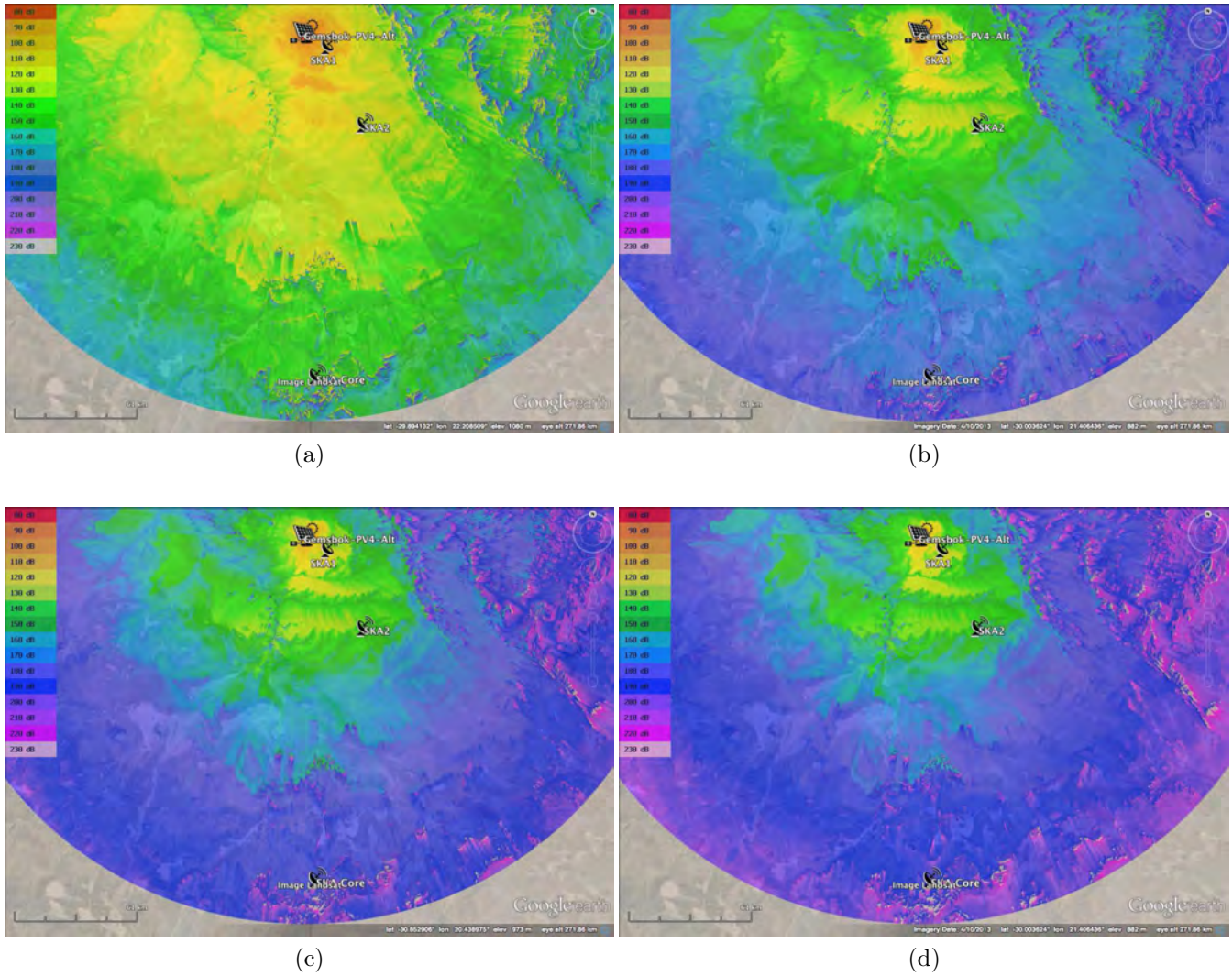

Figure 24: TPL attenuation maps for **alternative** site location of Gembok PV4 to the closest and core SKA telescopes for (a) 100 MHz (b) 1000 MHz (c) 2000 MHz and (d) 3000 MHz.

4.9 Gemsbok PV5 Site Location

4.9.1 Gemsbok PV5 Preferred Site Location

Frequency	Closest Telescope 1			Closest Telescope 2			SKA Core Site		
	FSPL	TL	TPL	FSPL	TL	TPL	FSPL	TL	TPL
100MHz	92.9dB	7.24dB	100.14dB	107.45dB	20.82dB	128.27dB	117.45dB	28.14dB	145.59dB
300MHz	102.44dB	0.0dB	102.44dB	116.99dB	13.65dB	130.64dB	126.99dB	30.17dB	157.16dB
500MHz	106.88dB	0.0dB	106.88dB	121.43dB	12.2dB	133.63dB	131.43dB	33.06dB	164.49dB
1000MHz	112.9dB	0.0dB	112.9dB	127.45dB	13.15dB	140.6dB	137.45dB	38.71dB	176.16dB
1500MHz	116.42dB	0.0dB	116.42dB	130.97dB	14.19dB	145.16dB	140.97dB	41.19dB	182.16dB
2000MHz	118.92dB	0.0dB	118.92dB	133.47dB	15.32dB	148.79dB	143.47dB	42.78dB	186.25dB
2500MHz	120.86dB	0.0dB	120.86dB	135.41dB	16.45dB	151.86dB	145.41dB	43.96dB	189.37dB
3000MHz	122.44dB	0.0dB	122.44dB	136.99dB	17.68dB	154.67dB	146.99dB	44.91dB	191.9dB

Table 35: SPLAT! Free Space Path Loss (FSPL), Terrain Loss (TL) and Total Path Loss (TPL) for vertical polarisation preferred site Gemsbok PV5 emissions.

4.9.2 Gemsbok PV5 Alternative Site Location

Frequency	Closest Telescope 1			Closest Telescope 2			SKA Core Site		
	FSPL	TL	TPL	FSPL	TL	TPL	FSPL	TL	TPL
100MHz	93.79dB	18.23dB	112.02dB	107.45dB	28.16dB	135.61dB	117.39dB	36.27dB	153.66dB
300MHz	103.33dB	15.23dB	118.56dB	116.99dB	21.32dB	138.31dB	126.94dB	38.02dB	164.96dB
500MHz	107.77dB	15.77dB	123.54dB	121.43dB	20.35dB	141.78dB	131.37dB	39.27dB	170.64dB
1000MHz	113.79dB	18.96dB	132.75dB	127.45dB	22.65dB	150.1dB	137.39dB	43.16dB	180.55dB
1500MHz	117.31dB	22.04dB	139.35dB	130.97dB	24.96dB	155.93dB	140.91dB	44.95dB	185.86dB
2000MHz	119.81dB	24.86dB	144.67dB	133.47dB	26.79dB	160.26dB	143.41dB	46.22dB	189.63dB
2500MHz	121.75dB	27.33dB	149.08dB	135.41dB	28.31dB	163.72dB	145.35dB	47.22dB	192.57dB
3000MHz	123.33dB	29.32dB	152.65dB	136.99dB	29.63dB	166.62dB	146.94dB	48.04dB	194.98dB

Table 36: SPLAT! Free Space Path Loss (FSPL), Terrain Loss (TL) and Total Path Loss (TPL) for vertical polarisation alternative site Gemsbok PV5 emissions.

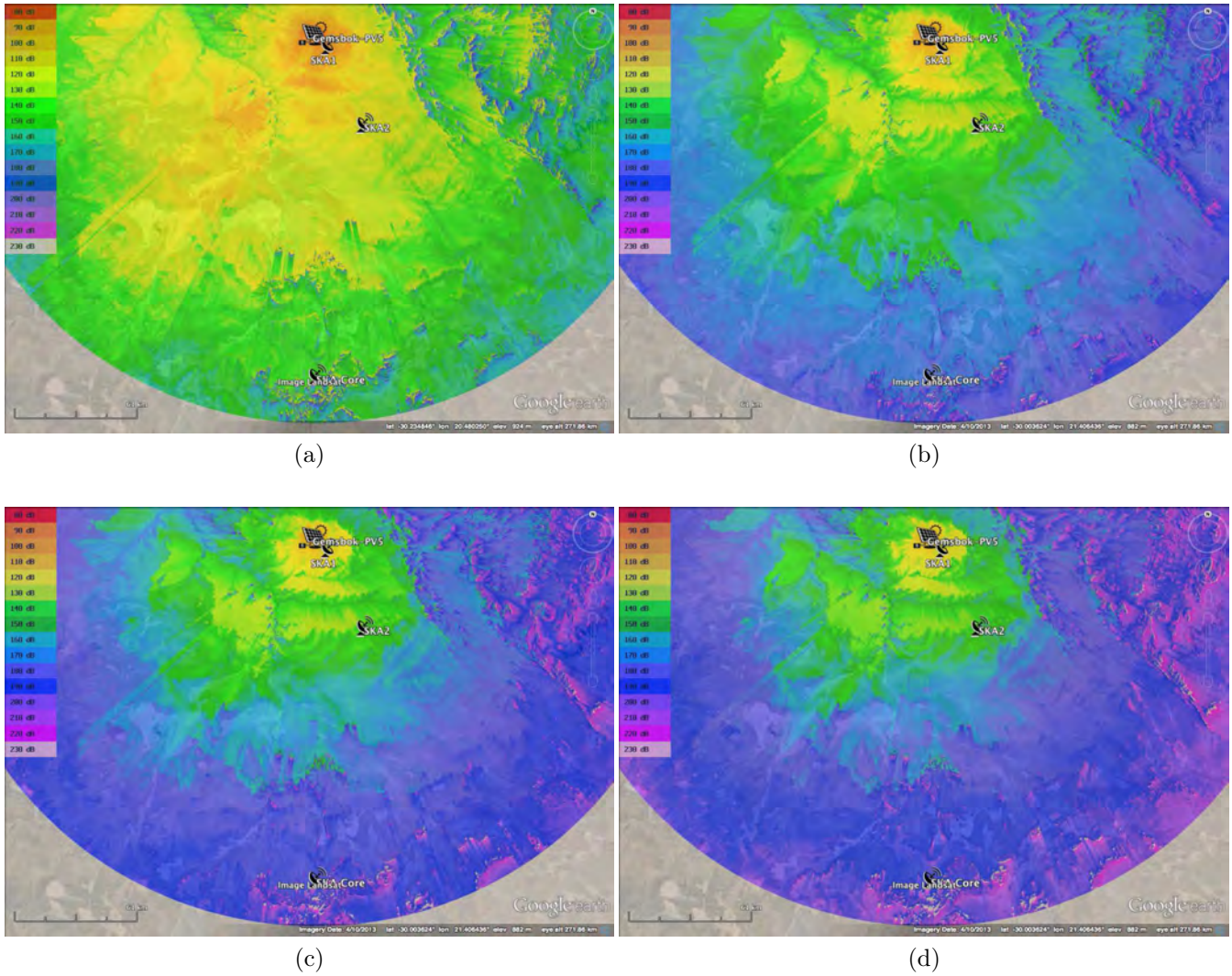

Figure 25: TPL attenuation maps for preferred site location of Gemsbok PV5 to the closest and core SKA telescopes for (a) 100 MHz (b) 1000 MHz (c) 2000 MHz and (d) 3000 MHz.

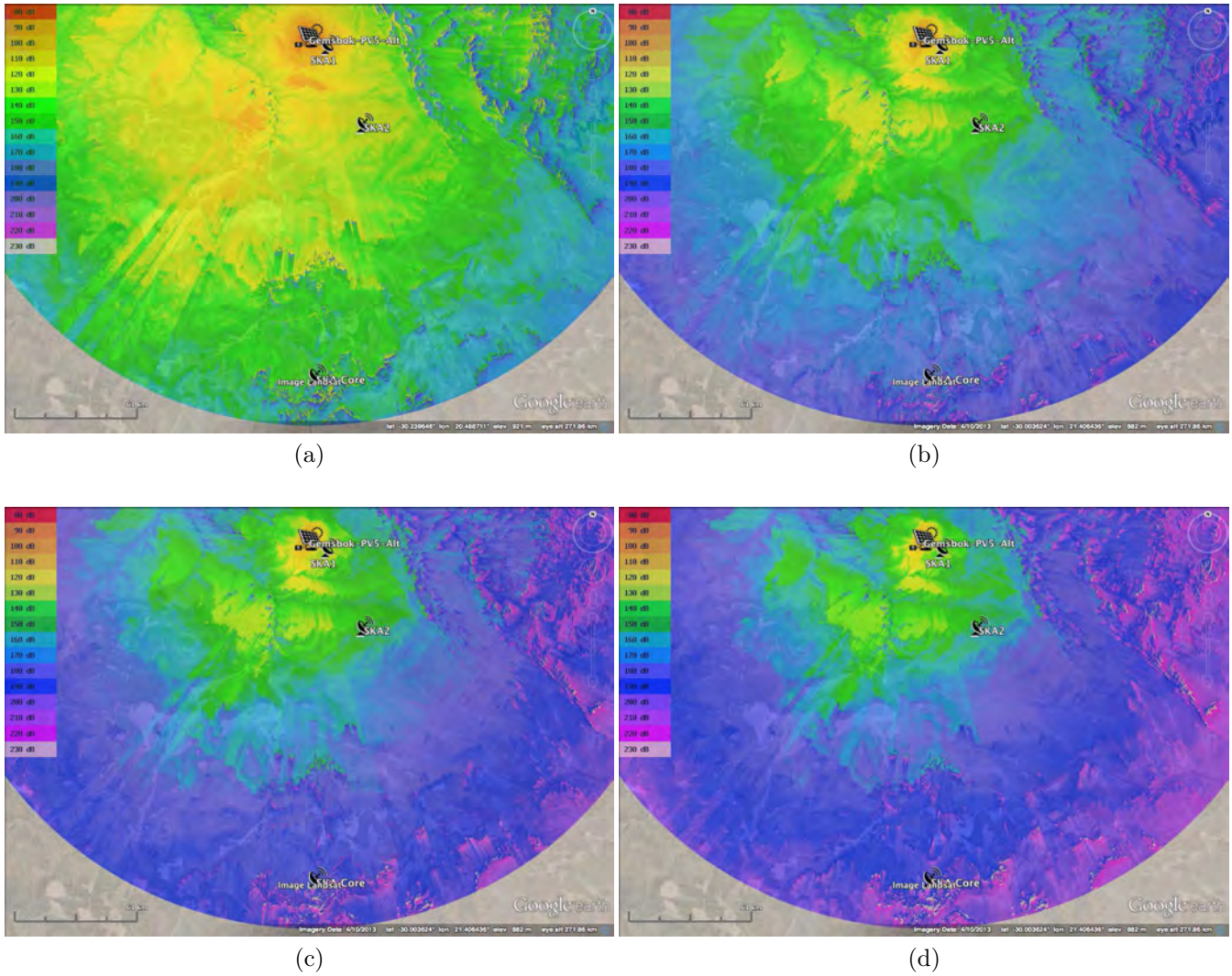

Figure 26: TPL attenuation maps for **alternative** site location of Gembok PV5 to the closest and core SKA telescopes for (a) 100 MHz (b) 1000 MHz (c) 2000 MHz and (d) 3000 MHz.

4.10 Gemsbok PV6 Site Location

4.10.1 Gemsbok PV6 Preferred Site Location

Frequency	Closest Telescope 1			Closest Telescope 2			SKA Core Site		
	FSPL	TL	TPL	FSPL	TL	TPL	FSPL	TL	TPL
100MHz	93.64dB	19.39dB	113.03dB	107.64dB	23.34dB	130.98dB	117.52dB	29.84dB	147.36dB
300MHz	103.18dB	13.52dB	116.7dB	117.18dB	13.78dB	130.96dB	127.06dB	30.93dB	157.99dB
500MHz	107.62dB	11.93dB	119.55dB	121.62dB	11.78dB	133.4dB	131.5dB	33.61dB	165.11dB
1000MHz	113.64dB	11.22dB	124.86dB	127.64dB	12.63dB	140.27dB	137.52dB	39.09dB	176.61dB
1500MHz	117.16dB	11.7dB	128.86dB	131.16dB	14.04dB	145.2dB	141.04dB	41.54dB	182.58dB
2000MHz	119.66dB	12.51dB	132.17dB	133.66dB	15.39dB	149.05dB	143.54dB	43.12dB	186.66dB
2500MHz	121.6dB	13.19dB	134.79dB	135.6dB	16.69dB	152.29dB	145.48dB	44.3dB	189.78dB
3000MHz	123.18dB	13.98dB	137.16dB	137.18dB	17.89dB	155.07dB	147.06dB	45.24dB	192.3dB

Table 37: SPLAT! Free Space Path Loss (FSPL), Terrain Loss (TL) and Total Path Loss (TPL) for vertical polarisation **preferred** site Gemsbok PV6 emissions.

4.10.2 Gemsbok PV6 Alternative Site Location

Frequency	Closest Telescope 1			Closest Telescope 2			SKA Core Site		
	FSPL	TL	TPL	FSPL	TL	TPL	FSPL	TL	TPL
100MHz	94.3dB	15.79dB	110.09dB	107.68dB	27.14dB	134.82dB	117.49dB	32.67dB	150.16dB
300MHz	103.84dB	11.16dB	115.0dB	117.23dB	17.25dB	134.48dB	127.03dB	32.01dB	159.04dB
500MHz	108.28dB	10.33dB	118.61dB	121.66dB	15.36dB	137.02dB	131.47dB	34.33dB	165.8dB
1000MHz	114.3dB	10.76dB	125.06dB	127.68dB	17.13dB	144.81dB	137.49dB	39.51dB	177.0dB
1500MHz	117.82dB	12.25dB	130.07dB	131.21dB	18.9dB	150.11dB	141.01dB	41.82dB	182.83dB
2000MHz	120.32dB	13.61dB	133.93dB	133.7dB	20.34dB	154.04dB	143.51dB	43.39dB	186.9dB
2500MHz	122.26dB	14.71dB	136.97dB	135.64dB	21.62dB	157.26dB	145.45dB	44.56dB	190.01dB
3000MHz	123.84dB	15.65dB	139.49dB	137.23dB	22.76dB	159.99dB	147.03dB	45.5dB	192.53dB

Table 38: SPLAT! Free Space Path Loss (FSPL), Terrain Loss (TL) and Total Path Loss (TPL) for vertical polarisation **alternative** site Gemsbok PV6 emissions.

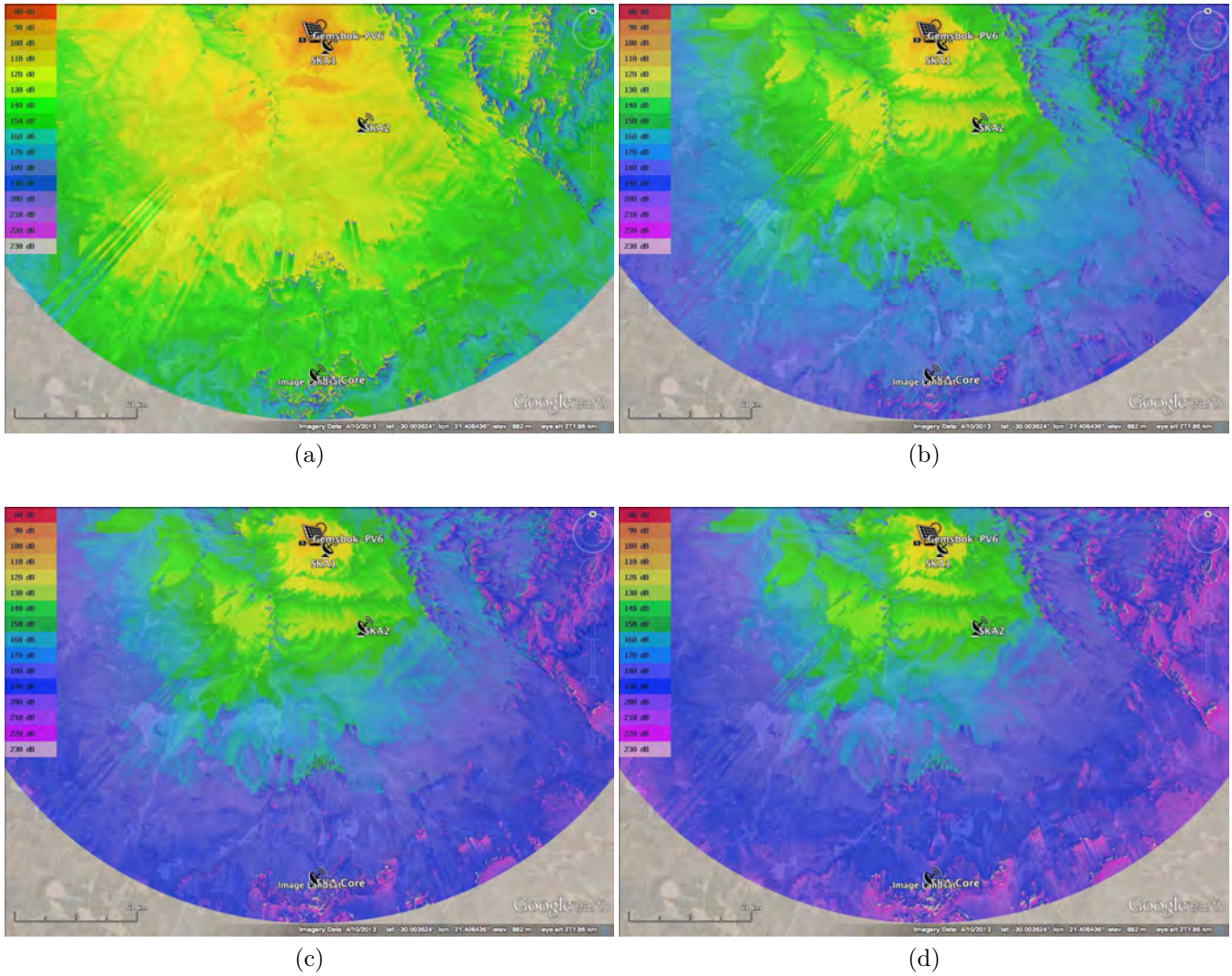

Figure 27: TPL attenuation maps for **preferred** site location of Gemsbok PV6 to the closest and core SKA telescopes for (a) 100 MHz (b) 1000 MHz (c) 2000 MHz and (d) 3000 MHz.

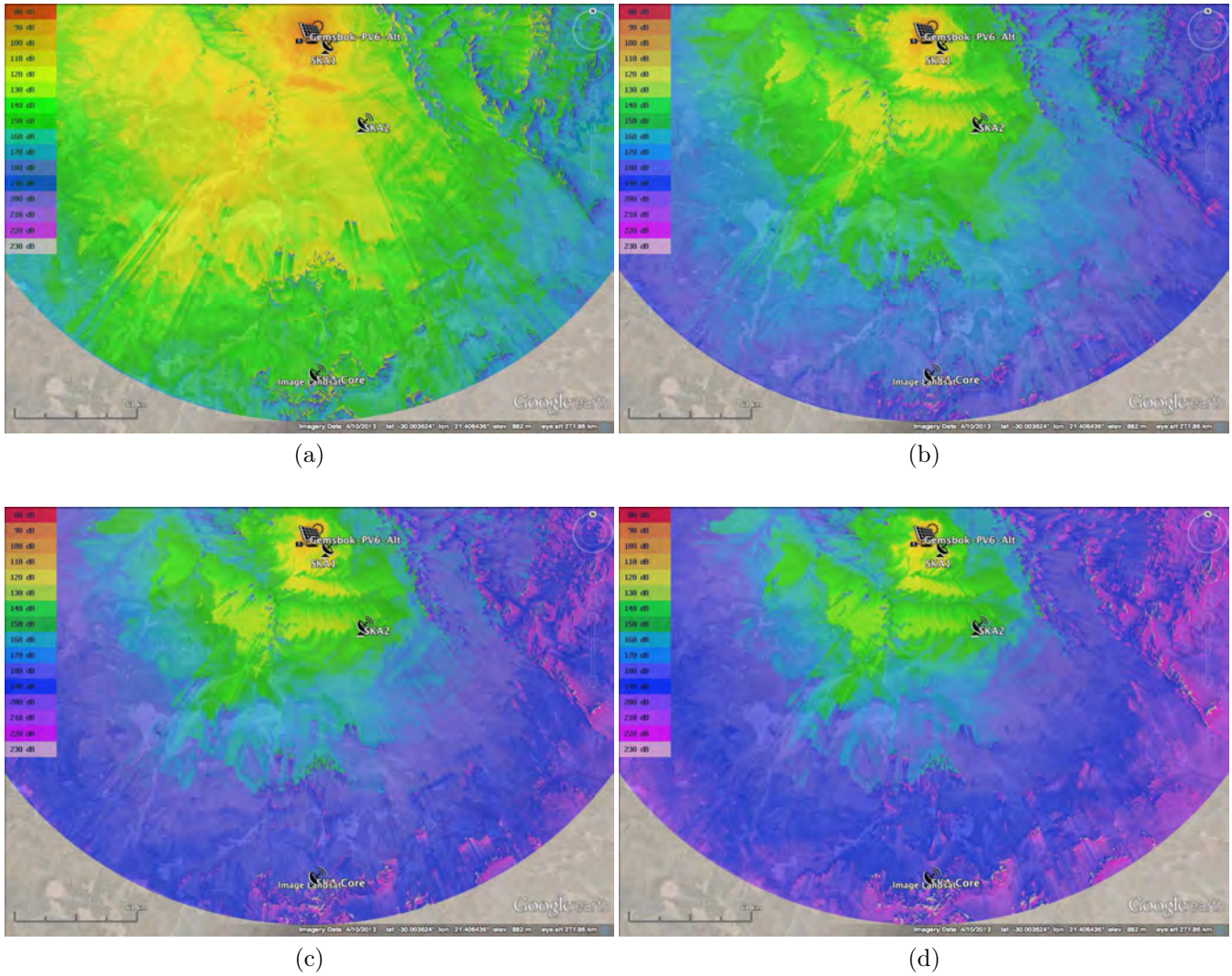

Figure 28: TPL attenuation maps for **alternative** site location of Gembok PV6 to the closest and core SKA telescopes for (a) 100 MHz (b) 1000 MHz (c) 2000 MHz and (d) 3000 MHz.

4.11 Scatec PV 1 Site Location

Frequency	Closest Telescope 1			Closest Telescope 2			SKA Core Site		
	FSPL	TL	TPL	FSPL	TL	TPL	FSPL	TL	TPL
100MHz	98.85dB	25.85dB	124.7dB	107.5dB	32.55dB	140.05dB	117.04dB	41.49dB	158.53dB
300MHz	108.4dB	22.11dB	130.51dB	117.04dB	27.16dB	144.2dB	126.58dB	36.97dB	163.55dB
500MHz	112.83dB	21.54dB	134.37dB	121.48dB	27.13dB	148.61dB	131.02dB	38.31dB	169.33dB
1000MHz	118.85dB	22.67dB	141.52dB	127.5dB	30.64dB	158.14dB	137.04dB	42.46dB	179.5dB
1500MHz	122.37dB	24.04dB	146.41dB	131.02dB	33.55dB	164.57dB	140.56dB	44.38dB	184.94dB
2000MHz	124.87dB	25.12dB	149.99dB	133.52dB	35.96dB	169.48dB	143.06dB	45.72dB	188.78dB
2500MHz	126.81dB	25.97dB	152.78dB	135.46dB	37.92dB	173.38dB	145.0dB	46.77dB	191.77dB
3000MHz	128.4dB	26.75dB	155.15dB	137.04dB	39.58dB	176.62dB	146.58dB	47.63dB	194.21dB

Table 39: SPLAT! Free Space Path Loss (FSPL), Terrain Loss (TL) and Total Path Loss (TPL) for vertical polarisation preferred site Scatec PV1 emissions.

4.12 Scatec PV 2 Site Location

Frequency	Closest Telescope 1			Closest Telescope 2			SKA Core Site		
	FSPL	TL	TPL	FSPL	TL	TPL	FSPL	TL	TPL
100MHz	98.21dB	16.04dB	114.25dB	107.3dB	19.65dB	126.95dB	117.02dB	33.37dB	150.39dB
300MHz	107.75dB	10.55dB	118.3dB	116.84dB	13.63dB	130.47dB	126.56dB	33.87dB	160.43dB
500MHz	112.19dB	8.9dB	121.09dB	121.28dB	12.7dB	133.98dB	131.0dB	35.77dB	166.77dB
1000MHz	118.21dB	8.42dB	126.63dB	127.3dB	13.91dB	141.21dB	137.02dB	40.56dB	177.58dB
1500MHz	121.73dB	8.83dB	130.56dB	130.82dB	15.07dB	145.89dB	140.54dB	42.73dB	183.27dB
2000MHz	124.23dB	9.49dB	133.72dB	133.32dB	16.21dB	149.53dB	143.04dB	44.18dB	187.22dB
2500MHz	126.17dB	10.26dB	136.43dB	135.25dB	17.3dB	152.55dB	144.98dB	45.28dB	190.26dB
3000MHz	127.75dB	10.93dB	138.68dB	136.84dB	18.3dB	155.14dB	146.56dB	46.16dB	192.72dB

Table 40: SPLAT! Free Space Path Loss (FSPL), Terrain Loss (TL) and Total Path Loss (TPL) for vertical polarisation preferred site Scatec PV2 emissions.

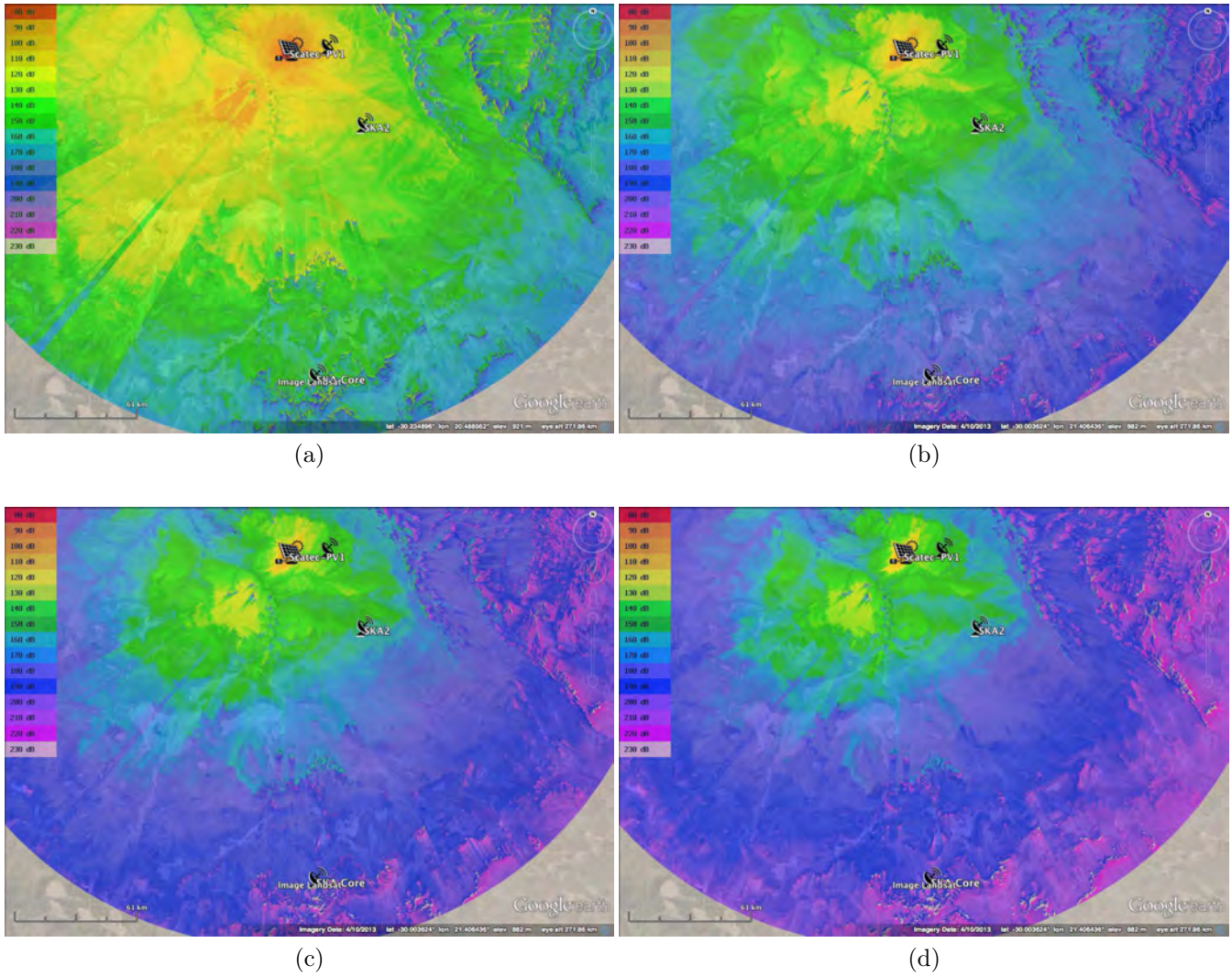

Figure 29: TPL attenuation maps for site location of Scatec PV1 to the closest and core SKA telescopes for (a) 100 MHz (b) 1000 MHz (c) 2000 MHz and (d) 3000 MHz.

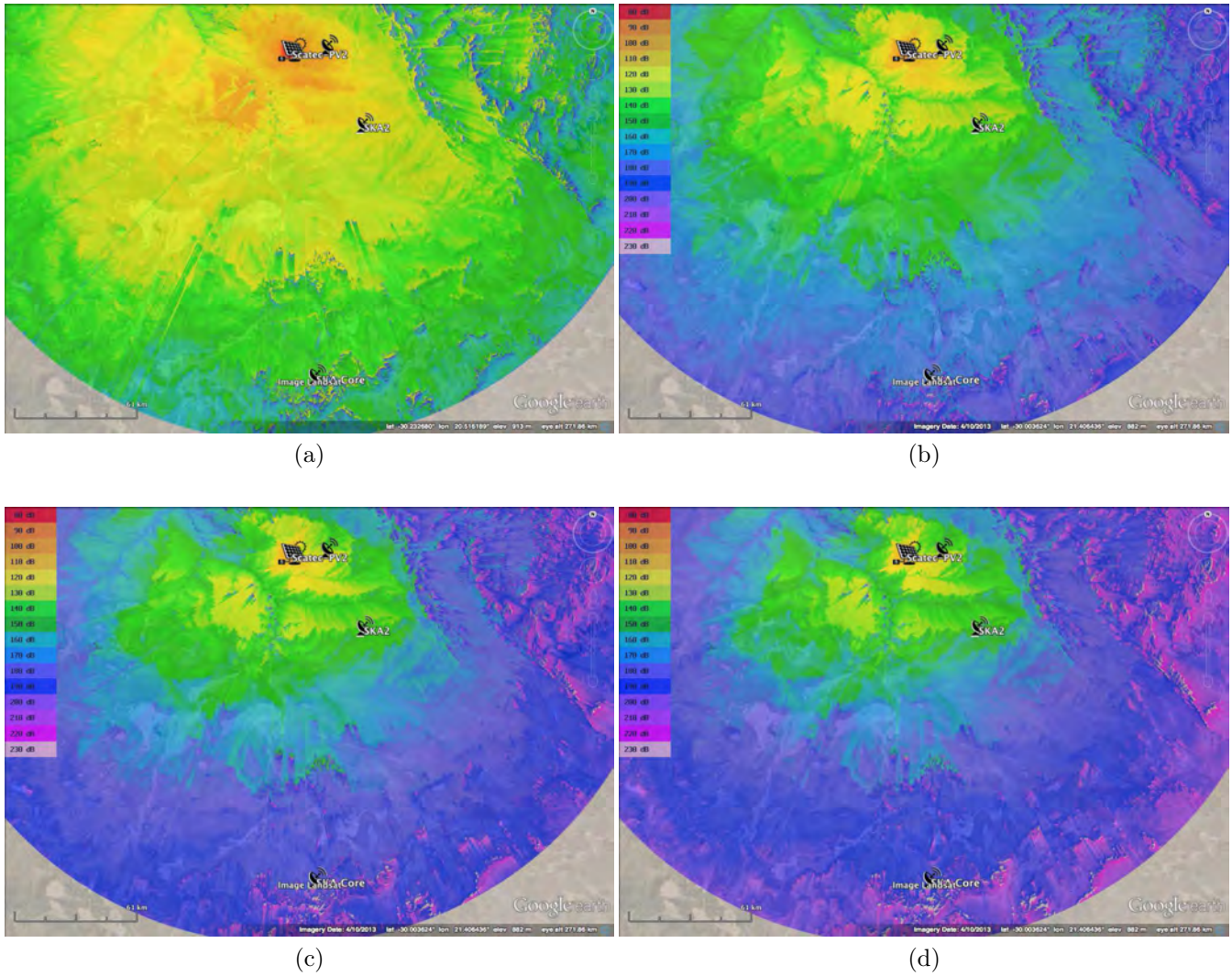

Figure 30: TPL attenuation maps for site location of Scatec PV2 to the closest and core SKA telescopes for (a) 100 MHz (b) 1000 MHz (c) 2000 MHz and (d) 3000 MHz.

4.13 Scatec PV 3 Site Location

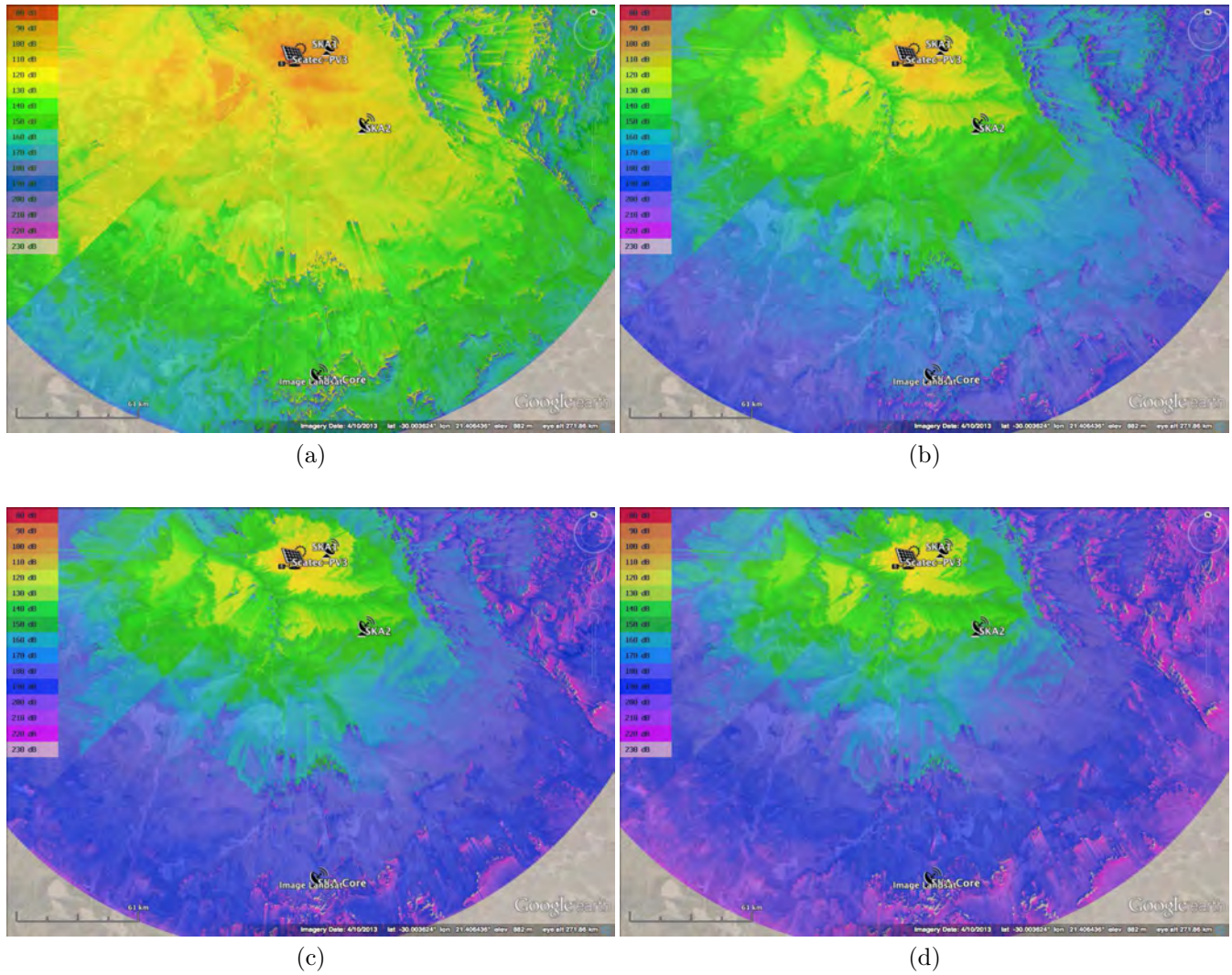

Figure 31: TPL attenuation maps for site location of Scatec PV3 to the closest and core SKA telescopes for (a) 100 MHz (b) 1000 MHz (c) 2000 MHz and (d) 3000 MHz.

Frequency	Closest Telescope 1			Closest Telescope 2			SKA Core Site		
	FSPL	TL	TPL	FSPL	TL	TPL	FSPL	TL	TPL
100MHz	98.71dB	28.91dB	127.62dB	107.1dB	29.76dB	136.86dB	116.9dB	45.22dB	162.12dB
300MHz	108.25dB	27.45dB	135.7dB	116.65dB	22.96dB	139.61dB	126.44dB	41.0dB	167.44dB
500MHz	112.69dB	27.82dB	140.51dB	121.08dB	22.11dB	143.19dB	130.88dB	41.68dB	172.56dB
1000MHz	118.71dB	30.21dB	148.92dB	127.1dB	24.49dB	151.59dB	136.9dB	44.96dB	181.86dB
1500MHz	122.23dB	31.86dB	154.09dB	130.63dB	26.93dB	157.56dB	140.42dB	46.44dB	186.86dB
2000MHz	124.73dB	33.11dB	157.84dB	133.12dB	28.84dB	161.96dB	142.92dB	47.53dB	190.45dB
2500MHz	126.67dB	34.08dB	160.75dB	135.06dB	30.38dB	165.44dB	144.86dB	48.43dB	193.29dB
3000MHz	128.25dB	34.86dB	163.11dB	136.65dB	31.62dB	168.27dB	146.44dB	49.2dB	195.64dB

Table 41: SPLAT! Free Space Path Loss (FSPL), Terrain Loss (TL) and Total Path Loss (TPL) for vertical polarisation preferred site Scatec PV3 emissions.

5 Preferred vs. Alternative Site Locations Based on TPL

Recommendations based on the TPL, assessed in Section 4 for the preferred and alternative site locations, are made in Table 42. In this table, the following legend applies:

- ✓: Recommended
- ~: Neutral
- X: Not recommended
- N/A: Not applicable (i.e. the preferred site is recommended)

The locations are considered in terms of the closest and core-site telescopes, with the final recommendation made in the last column of the table. The recommended site locations and associated TPL will subsequently be used in the calculations for allowable emission limits. In the event where the alternative site is recommended, the maximum difference in total path loss for the preferred site is indicated.

Site Location	Closest Telescope 1	Closest Telescope 2	SKA Core Site	Recommendation	Max. TPL Difference
Boven PV 2 Preferred	X	X	X	X	28.39 dB
Boven PV 2 Alternative	✓	✓	✓	✓	
Boven PV 3 Preferred	X	✓	~	✓	N/A
Boven PV 3 Alternative	✓	X	~	X	
Boven PV 4 Preferred	~	~	~	~	N/A
Boven PV 4 Alternative	~	~	~	~	
Gemsbok PV 3 Preferred	✓	✓	X	✓	N/A
Gemsbok PV 3 Alternative	X	X	✓	X	
Gemsbok PV 4 Preferred	~	~	~	~	N/A
Gemsbok PV 4 Alternative	~	~	~	~	
Gemsbok PV 5 Preferred	X	X	X	X	30.21 dB
Gemsbok PV 5 Alternative	✓	✓	✓	✓	
Gemsbok PV 6 Preferred	~	~	~	~	N/A
Gemsbok PV 6 Alternative	~	~	~	~	

Summary of preferred and alternate site locations based on predicted total path loss. Legend: ✓: Recommended; ~ : Neutral; X : Not Recommended; N/A: Not Applicable (i.e. Preferred site is the recommended site).

6 SKA Threshold Limits

SKA threshold limits are defined as *Protection Limits* (dBm/Hz as defined by SARAS) and *Receiver Saturation Limits* (-100 dBm). Using the attenuation maps and topographical profiles calculated in Section 4 , we next compare the acceptable levels as measured at 10 m from each plant (according to CISPR 11/22 class B) that will produce radiated emission levels 10 dB below the SKA threshold as defined by SARAS. The 10 dB theoretical value is a safety margin to ensure that each of the plants complies with the SKA threshold, and attempts to take into account any multi-path effects (6 dB variation) and any measurement uncertainties. The required level 10 dB below the threshold takes into account the TPL calculated by SPLAT! and are indicated as *Required Radiation Levels After Propagation Loss*. The required PSD of the radiated emission levels experienced at each telescope are given by Eq. 2 below. The required levels are represented by the *black squares* in Figs. 32 (b) to 34 (b) for projects to the closest and core SKA telescope sites respectively.

$$PSD_{\text{Required}} [dBm/Hz] = PSD_{\text{SARAS Continuum}} [dBm/Hz] - 10 \text{ dB} \quad (2)$$

Considering the TPL, the required PSD at the source of the interference, indicated as *Required Radiation Levels Before Propagation Loss at PV Plant* in Figs. 32 (b) to 34 (b), is given by:

$$PSD_{\text{Source}} [dBm/Hz] = PSD_{\text{Required}} [dBm/Hz] + TPL [dB] \quad (3)$$

The effective isotropic radiated power (EIRP) level at the source, that will result in an E-field E_0 as measured according to the CISPR 11/22 Class B standard with a RBW and separation distance of 120 kHz and 10 m for $f < 1$ GHz, and 1 MHz and 3 m for $f > 1$ GHz respectively, is given by:

$$EIRP [dBm] = PSD_{\text{Source}} [dBm/Hz] + 10 \log_{10}(RBW) [Hz] \quad (4)$$

The electric field (E_0) levels associated with the EIRP defined in Eq. 4, again as measured according to the CISPR 11/22 Class B standard, are shown in Figs. 32 (c) to 34 (c) and given by:

$$E_0 [dB\mu V/m] = EIRP - 20 \log_{10} D + 104.8 \quad (5)$$

The maximum EIRP levels of the source, to ensure the *Receiver Saturation Limit* of -100 dBm is met, are shown in Figs. 32 (a) to 34 (a) and given by:

$$EIRP_{\text{max}} [dBm] = -100 \text{ dBm} + TPL [dB] \quad (6)$$

6.1 Cumulative Impact Assessment

In the case where there are more than one source of interference for a specific frequency, the cumulative effect should be considered by taking into account:

$$P_{\text{Cumulative}} = 10 \log_{10} (N) \quad (7)$$

where $N = 13$ is the number of PV plants. This implies an increase in interference levels of up to 11.1 dB and is therefore subtracted from the maximum allowable radiated limits in Figs 32 to 34.

6.2 Maximum Allowed Radiation Levels

Below are given the maximum allowed radiation levels to meet both SKA *Saturation* and *Protection Threshold* (SARAS) limits for the two closest and core site telescopes for each of the proposed sites. It should be noted that the radiation levels have been determined for the recommended site locations indicated in Table 42.

6.2.1 Closest SKA Telescope

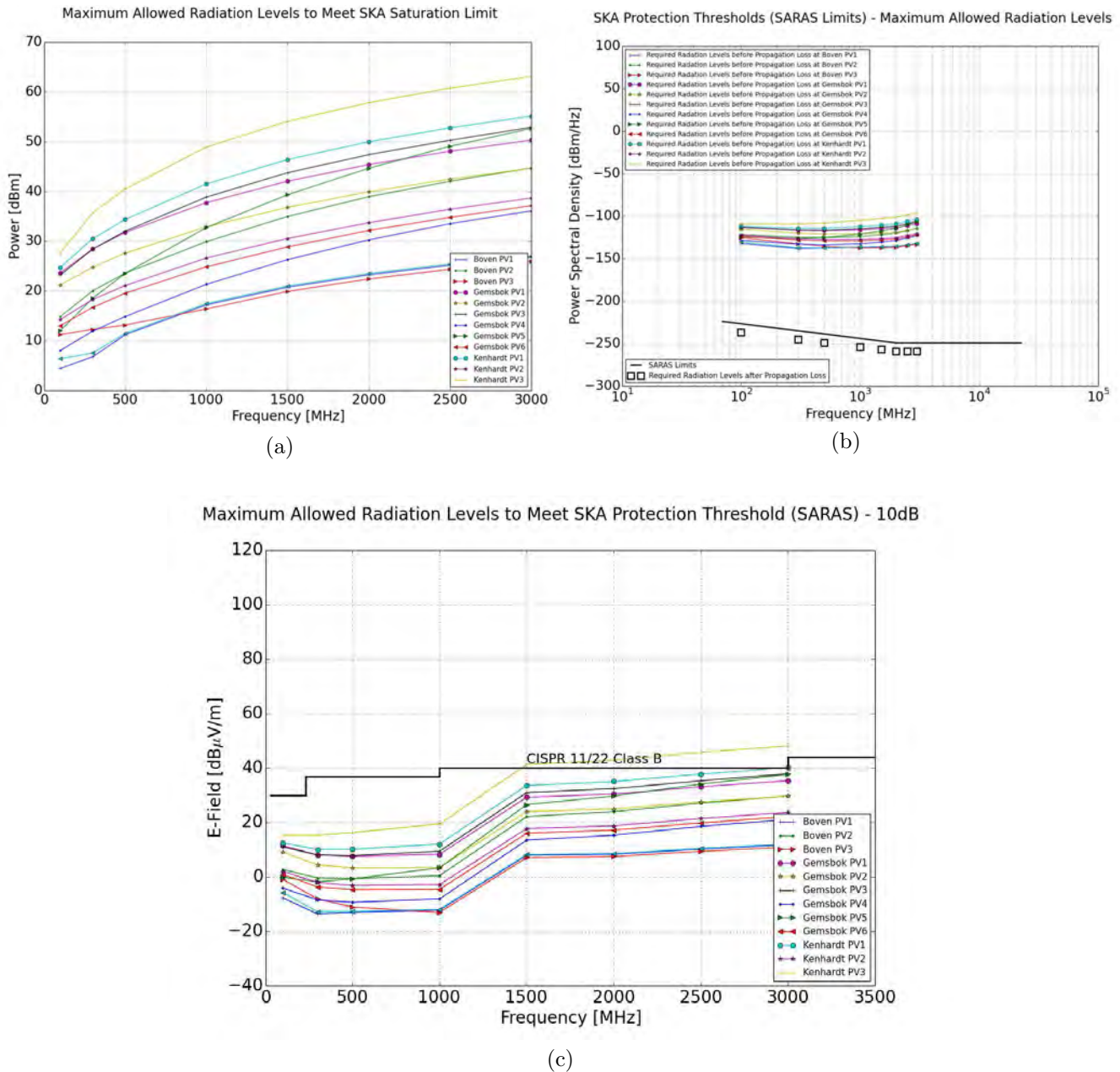

Figure 32: Closest SKA telescope receiver: (a) Maximum allowed EIRP to ensure levels are below the SKA saturation limit of -100 dBm at the telescope receiver; (b) Maximum allowed PSD to ensure levels are 10 dB below SARAS protection levels; (c) Maximum allowed measured E-Field (CISPR 22 Class B) to ensure levels are 10 dB below SARAS protection levels.

6.2.2 2nd Closest SKA Telescope

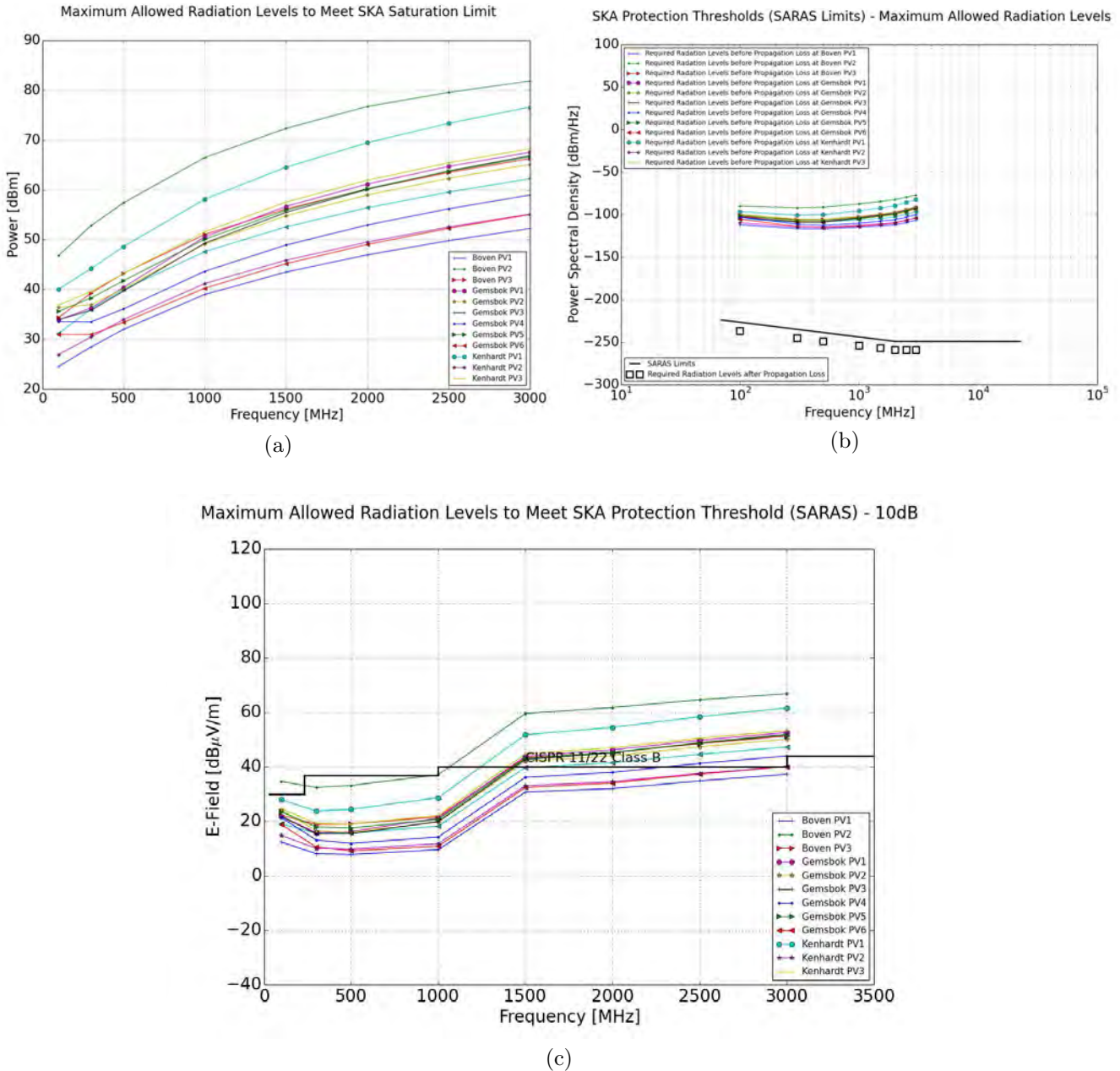

Figure 33: 2nd closest SKA telescope receiver: (a) Maximum allowed EIRP to ensure levels are below the SKA saturation limit of -100 dBm at the telescope receiver; (b) Maximum allowed PSD to ensure levels are 10 dB below SARAS protection levels; (c) Maximum allowed measured E-Field (CISPR 22 Class B) to ensure levels are 10 dB below SARAS protection levels.

6.2.3 Core SKA Telescopes

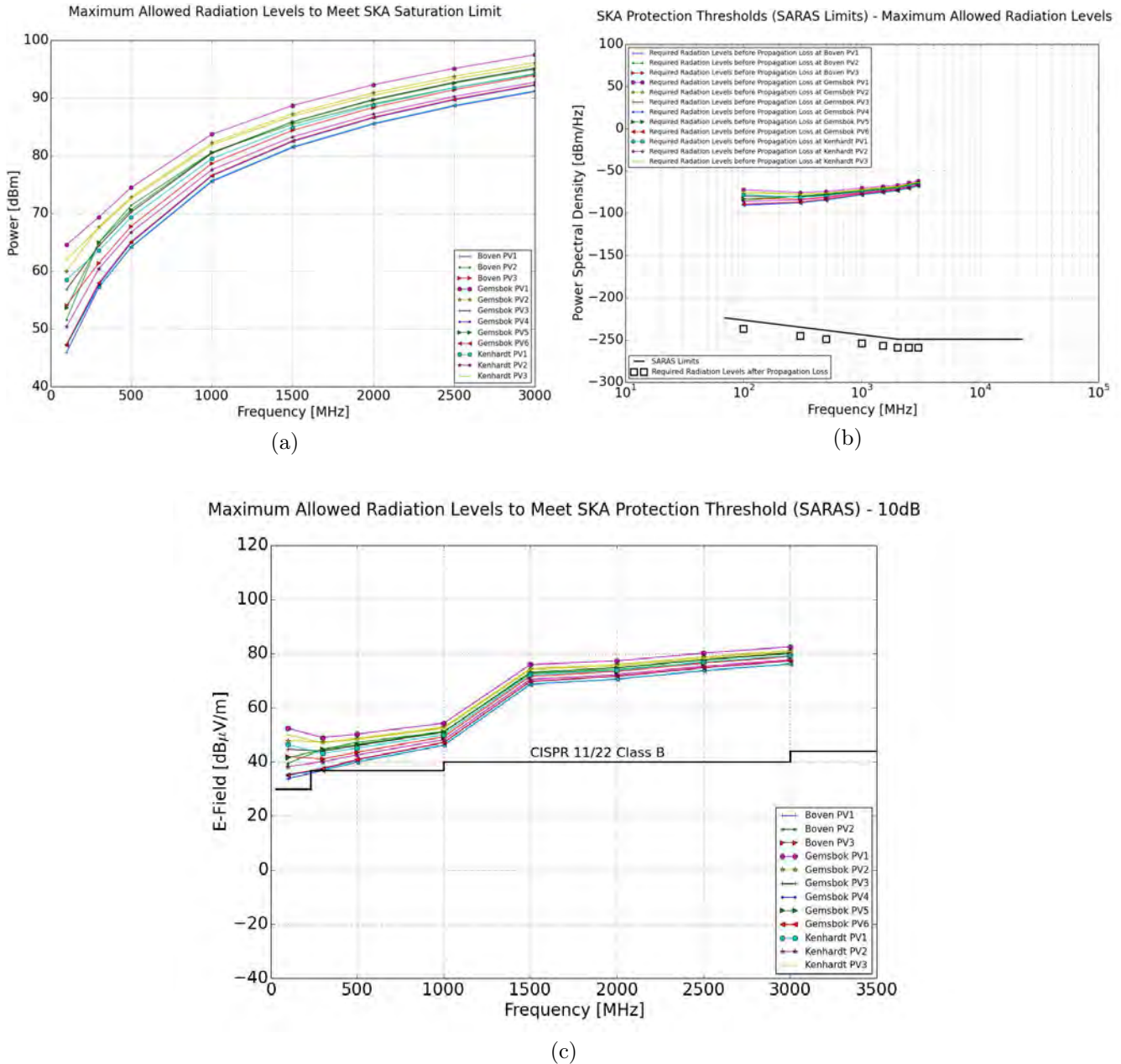

Figure 34: Core SKA telescope receivers: (a) Maximum allowed EIRP to ensure levels are below the SKA saturation limit of -100 dBm at the telescope receiver; (b) Maximum allowed PSD to ensure levels are 10 dB below SARAS protection levels; (c) Maximum allowed measured E-Field (CISPR 22 Class B) to ensure levels are 10 dB below SARAS protection levels.

7 Plant Design Overview

The proposed PV projects will use a similar design for each of the ten plants to that evaluated in [4]. The reason for this is that most new solar projects in South Africa incorporate single axis tracking technology, shown in Figs. 35 and 36, due to the increased yield and cost advantages. However, certain factors have to be taken into consideration for such a design. RFI associated with the regular switching of relays and contactors to operate the single axis tracking motors has subsequently been found by MESA Solutions to be contributors of significant levels of broadband interference. Assuming a tracking PV plant design, significant care and effort will be required to shield the broadband interference generated during operation of the tracking motors.

7.1 Expected Sources of Interference

As discussed in [4], the biggest RFI producing culprits for a plant layout incorporating a similar tracking philosophy were identified to be the inverter units and solar power tracker and monitoring controllers. Coupled to this is the way cabling is distributed throughout the plant. The combination of all three factors will influence the level of interference each plant is likely to produce.

- **Inverters**

- The inverters are considered to be the main source of interference due to their switching operation through which the direct current (DC) from the panels is converted to alternating current (AC) supplied to the transformers. This interference can be in the form of CM current present on the cables connected to the units, or through direct radiation.

- **Solar Power Tracker and Monitoring Controller**

- RFI associated with the regular switching of relays and contactors to operate the single axis tracking motors has recently been found to be prominent sources of interference. These relays will switch the motors on and off on a regular basis during the day, resulting in broadband interference with substantial frequency content. Furthermore, RFI generated by the tracking controller is typically due to the default system operation implementing a wireless mesh network for communication purposes between units. A number of other electrical components, which are also likely sources of interference, form part of the controller.

- **Cable Routing and Earthing**

- The way noise-producing equipment in the plant are interconnected has a significant influence on the level of RFI emitted. Cabling is the means by which interference in the form of common mode current (CM) is distributed. When sections of cabling become resonant, the interference is radiated into the environment. Depending on a number of factors such as height of transmission, frequency, emission level at source and topography, the interference will have a certain severity at the nearest SKA telescope as well as the core-site.

7.2 Mitigating Measures

Mulilo Renewable Project Developments has undertaken to incorporate all of MESA Solution’s recommendations in [4]. In addition to these recommendations, extra shielding, if required, on the inverter enclosures for all three plants will be incorporated. These measures include adding RFI gasketing to all seams and doors, as well as RFI *honeycomb* filtering to all ventilation openings. From recent measurement experience it is recommended that all the inverter and transformer technology be housed in a single shielded environment with the filters and gasketing as proposed. If installed correctly these additional measures are very effective and will be verified with post-installation measurements either on a representative unit or on the actual installation. The level of shielding that will be required is dependent on the severity of the emissions and their impact on the relevant SKA telescopes. It is recommended that alternating current (AC) brushless motors be used for tracking motors, while



Figure 35: Proposed single axis tracking system to be used for the proposed Mulilo PV projects.



Figure 36: Motors used in the single axis tracking system should be AC brushless.

the data communications to and from the plants are to be via fibre optic. Significant effort will be required to shield the switching noise from relays and contactors during operation of the tracking motors.

Based on MESA’s recommendations in [4], all wireless communication between tracking controllers will be replaced with fixed line communication using CAT7 shielded cables. This will be integrated in a similar cabling and earthing layout to what was evaluated in [4]. All cables are distributed either below ground directly in the soil, or through earthed cable trays. Depending on the soil conditions and conductive properties, any interference currents will be reduced over distance due to the strong capacitive coupling between the cable and soil. This capacitive coupling would have been significantly less if the cables were placed in plastic sleeving, and is not recommended.

The use of bare copper directly in soil, ensures that earthing reference potentials throughout the distributed system are equal and constant. It therefore provides a well defined earthing system for the entire plant layout, which simplifies installation of any additional connections should they be required. The developer has stated that they are aware of these mitigation measures and the associated costs due to their experience in incorporating these recommendations in the current construction of 2 x 75MW solar plants near Copperton. They have included these mitigation costs, and an additional contingency facility in the event where additional mitigation is required, in these proposed PV project budgets.

7.3 Expected RFI Reductions due to Mitigation Measures

By simply following good practices such as implementing an adequate earthing philosophy, and paying attention to the cabling interconnections and layout below ground, a reduction of at least 20 dB in the typical plant emissions across the frequency range of interest can be achieved. With added attention to detail, particularly regarding the shielding of enclosures, defining cable interfaces by correctly terminating cable screens or armouring, and the

use of galvanic earthed cable trays for short cable runs above ground, a total reduction of 40 dB is likely. A further 20 dB reduction would require detailed analysis of the required enclosure shielding and gasketing, more stringent filtering at all cable interfaces, and implementing additional cable screening that could include using fully enclosed metallic cable conduits. It is therefore MESA's expectations that if the mitigation measures specified are implemented correctly, an improvement of between 20 and 40 dB in emissions levels are likely. **It is important to note that this is purely predicted values and cannot be guaranteed or confirmed until measurements on operating plants (or representative installations) with recommended mitigation measures have been performed.**

8 Conclusions

MESA Solutions was asked by *Mulilo Renewable Project Developments* to do a cumulative topographical analysis of the terrain profile between ten proposed *Mulilo* PV projects, as well as three proposed *Scatec Solar* PV projects, towards the closest and core-site SKA Telescopes. The purpose of the investigation is to define a level that can be verified through measurements which will result in an equivalent emission level that is 10 dB below the SKA threshold limit. This measurement level is influenced by the TPL between both telescope locations. However, the TPL is a function of topography and frequency as well as characteristics such as the transmitter and receiver heights. The measurement level is related to the well-known CISPR 11/22 Class B standard that is defined at a measurement distance of 10 m for frequencies below 1 GHz and at 3 m for frequencies above 1 GHz.

From the results in Section 6 it is clear that radiated emissions at levels below that of CISPR 11/22 Class B are required (especially in the case of the closest telescope). This is mainly due to the absence of any TL over this short distance. This requirement relaxes slightly toward the second closest telescope, while allowable measured levels increase to slightly above the CISPR limit due to the additional TL toward the core. The possibility exists that, due to the large number of sites that are proposed in that area, the overall lower levels would have to be achieved to limit interference to the closest telescopes as much as possible.

It is strongly recommended that the following **mitigation practises** be incorporated into the plants design:

- The inverter units, transformers, communication and control units for an array of panels all be housed in a single shielded environment.
- For shielding of such an environment ensure:
 - RFI gasketing be placed on all seams and doors.
 - RFI Honeycomb filtering be placed on all ventilation openings.
- Cables to be laid directly in soil or properly grounded cable trays (not plastic sleeves).
- The use of bare copper directly in soil for earthing is recommended.
- Assuming a tracking PV plant design, care will have to be taken to shield the noise associated with the relays, contactors and motors of the tracking units.
- AC brushless motors to be used for tracking motors.
- Data communications to and from the plants to be via fibre optic.
- The developer has stated they are aware of these mitigation measures and the associated costs due to their experience in incorporating these recommendations in the current construction of 2 x 75MW solar plants near Copperton. They have included these mitigation costs, and an additional contingency facility in the event where additional mitigation is required, in the proposed PV projects budgets.

It is MESA's expectations that, if the mitigation measures that are specified are implemented correctly, an improvement of between 20 and 40 dB in emissions levels are likely. *It is important to note that this is purely predicted values and cannot be guaranteed or confirmed until measurements on the operating plants (or representative installations) are performed. It remains the developers responsibility to ensure that compliance to SKA requirements is met and MESA Solutions cannot accept responsibility for any assessments made in this report which could cause non-compliance.*

MESA Solutions

Drs A. J. Otto and P. S. van der Merwe
January 2016

References

- [1] *Astronomy Geographic Advantage Act, 2007*, No. 21 of 2007, Government Gazette, Vol. 516, No. 31157, Cape Town, Republic of South Africa, 17 June 2008.
- [2] P. Dewdney and G. Han Tan, *SKA EMI/EMC Standards and Procedures*, Technical Report SKA-TEL-SKO-0000202, Revision 1, Square Kilometre Array (SKA) Organisation, Jodrell Bank Observatory, UK, 10 January 2015.
- [3] A. J. Otto and P. S. van der Merwe, *Topographical Analysis of Proposed Nieuwehoop PV Projects*, Technical Report, MUL/NH/15/07/28, MESA Solutions (Pty) Ltd., Stellenbosch, Western Cape, South Africa, 7600, 31 July 2015.
- [4] A. J. Otto and P. S. van der Merwe, *Basic Site Assessment of Proposed Prieska Photovoltaic Plant*, Technical Report, SUN/14/08/22, Revision 0, MESA Solutions Pty (Ltd), Stellenbosch, South Africa, 22 August 2014.

Appendix

A Fresnel Zones and Line of Sight

The Fresnel zones and elevation profiles, including the earth curvature, are shown in Figs. 37 to 96. In all case the profiles are given towards the two closest and core-site SKA telescopes. A more detailed terrain profile shows features not visible in a normal Google Earth profile. This profile is then compensated for the earth curvature, clearly visible for the longer distance toward the core site. Important to note is the scale used in these figures. The elevation change is in meters but the separation distance varies in kilometres. The earth curvature representation is therefore somewhat enhanced.

A.1 Boven PV1 to Closest SKA

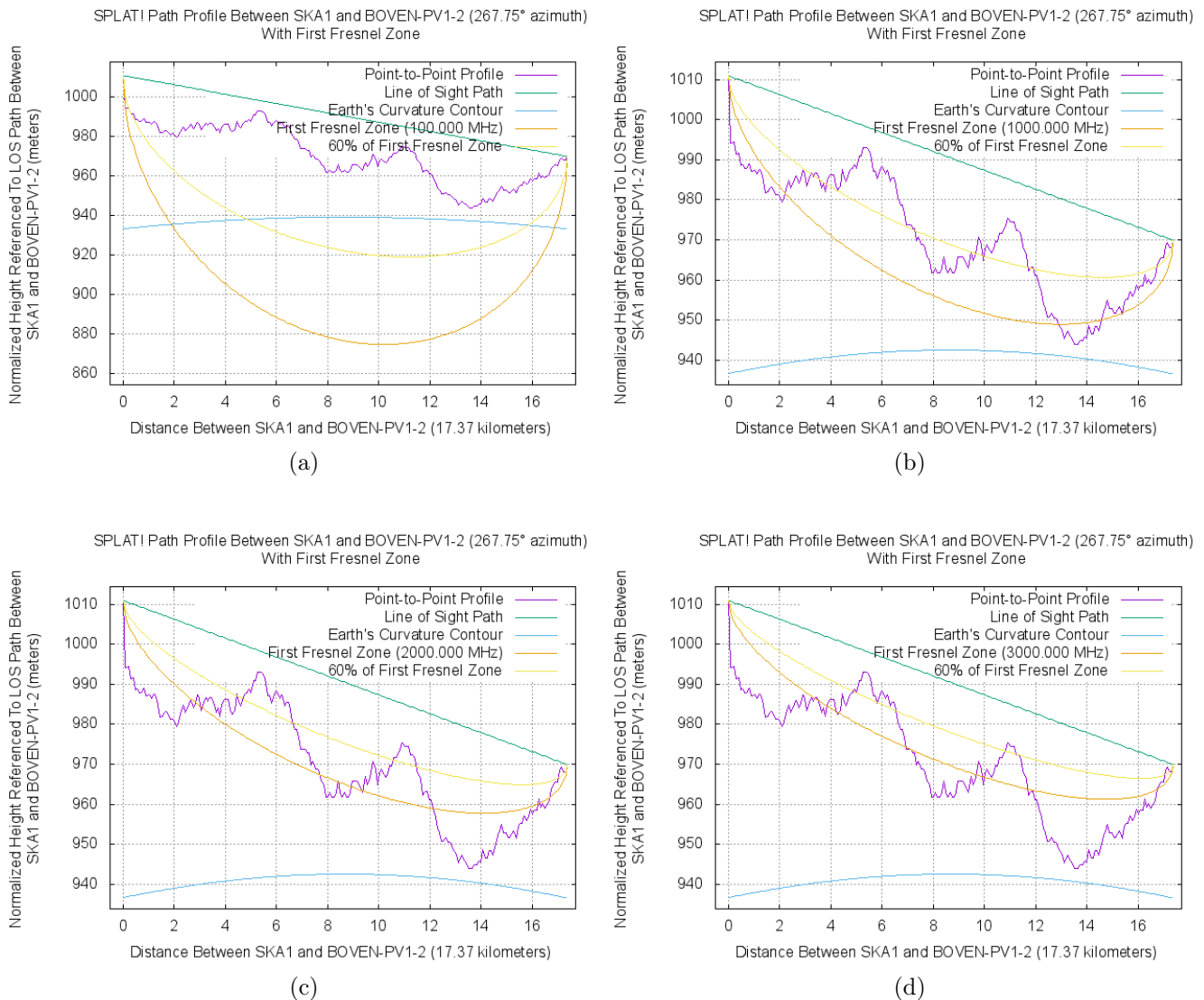

Figure 37: Fresnel zone, LOS and 60% of first Fresnel zone for site location of Boven PV1 to the closest SKA telescope for (a) 100 MHz (b) 1000 MHz (c) 2000 MHz and (d) 3000 MHz.

A.2 Boven PV1 to 2nd Closest SKA

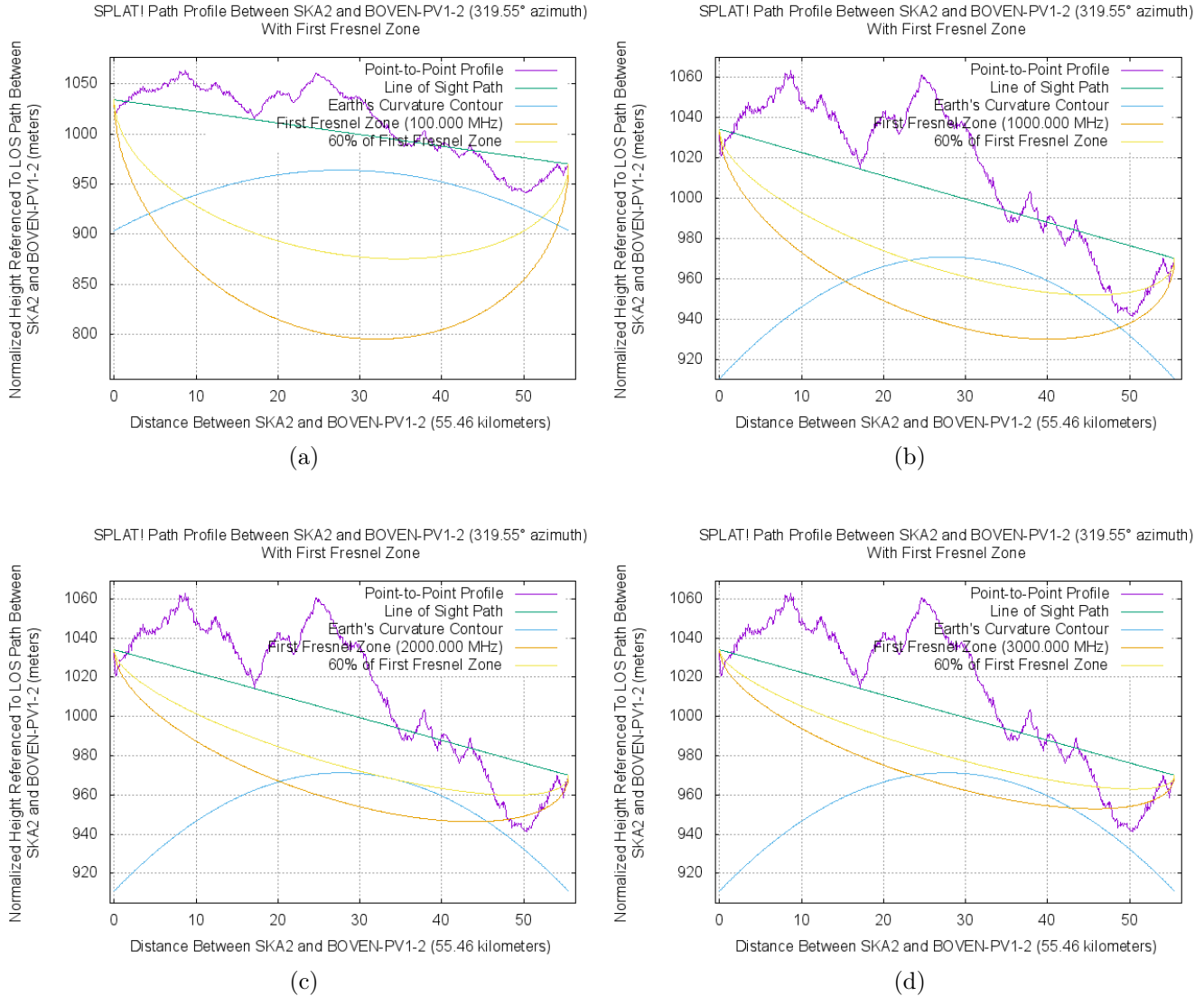

Figure 38: Fresnel zone, LOS and 60% of first Fresnel zone for site location of Boven PV1 to the second closest SKA telescope for (a) 100 MHz (b) 1000 MHz (c) 2000 MHz and (d) 3000 MHz.

A.3 Boven PV1 to Core SKA

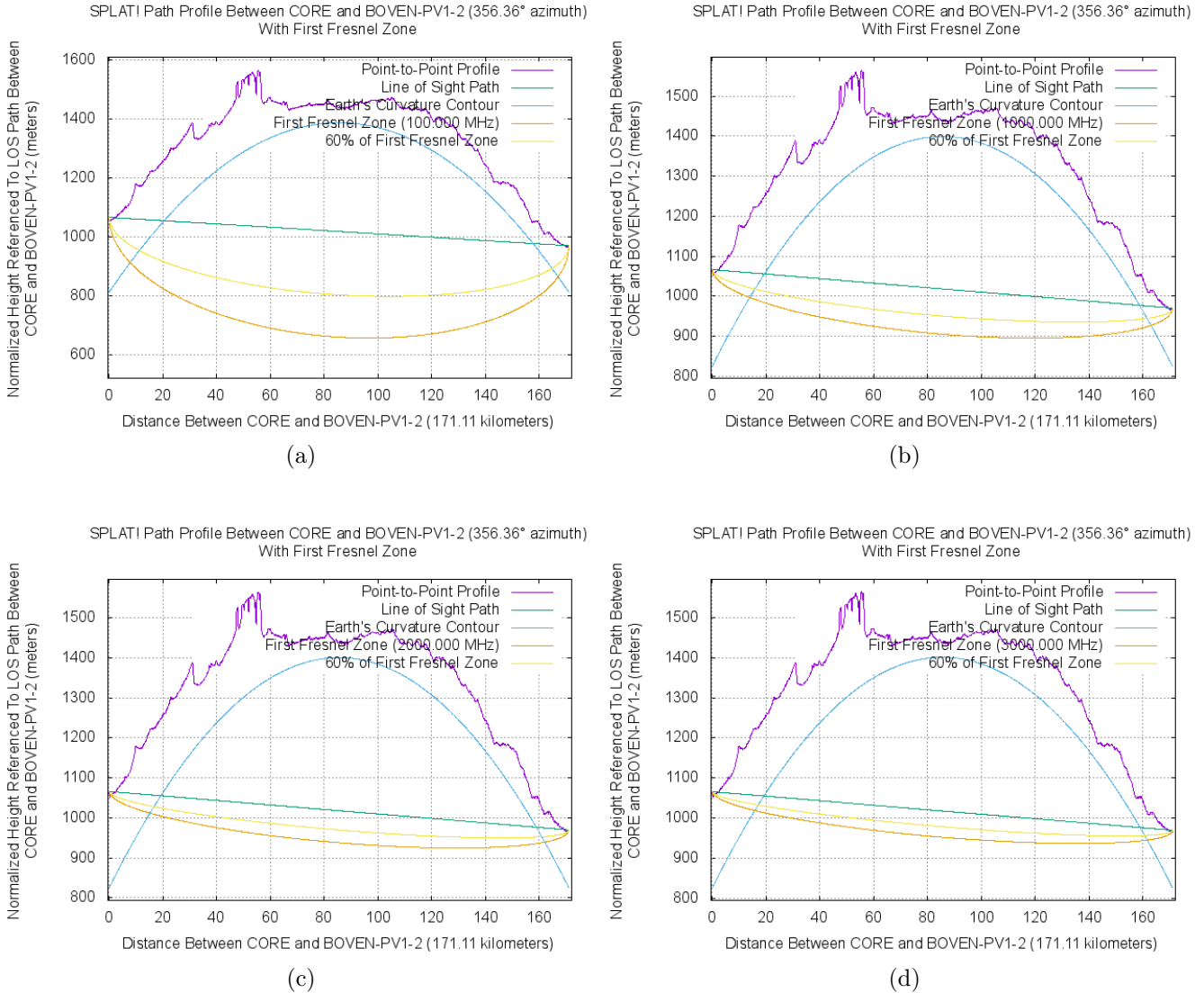

Figure 39: Fresnel zone, LOS and 60% of first Fresnel zone for site location of Boven PV1 to the core SKA telescopes for (a) 100 MHz (b) 1000 MHz (c) 2000 MHz and (d) 3000 MHz.

A.4 Boven PV2 to Closest SKA

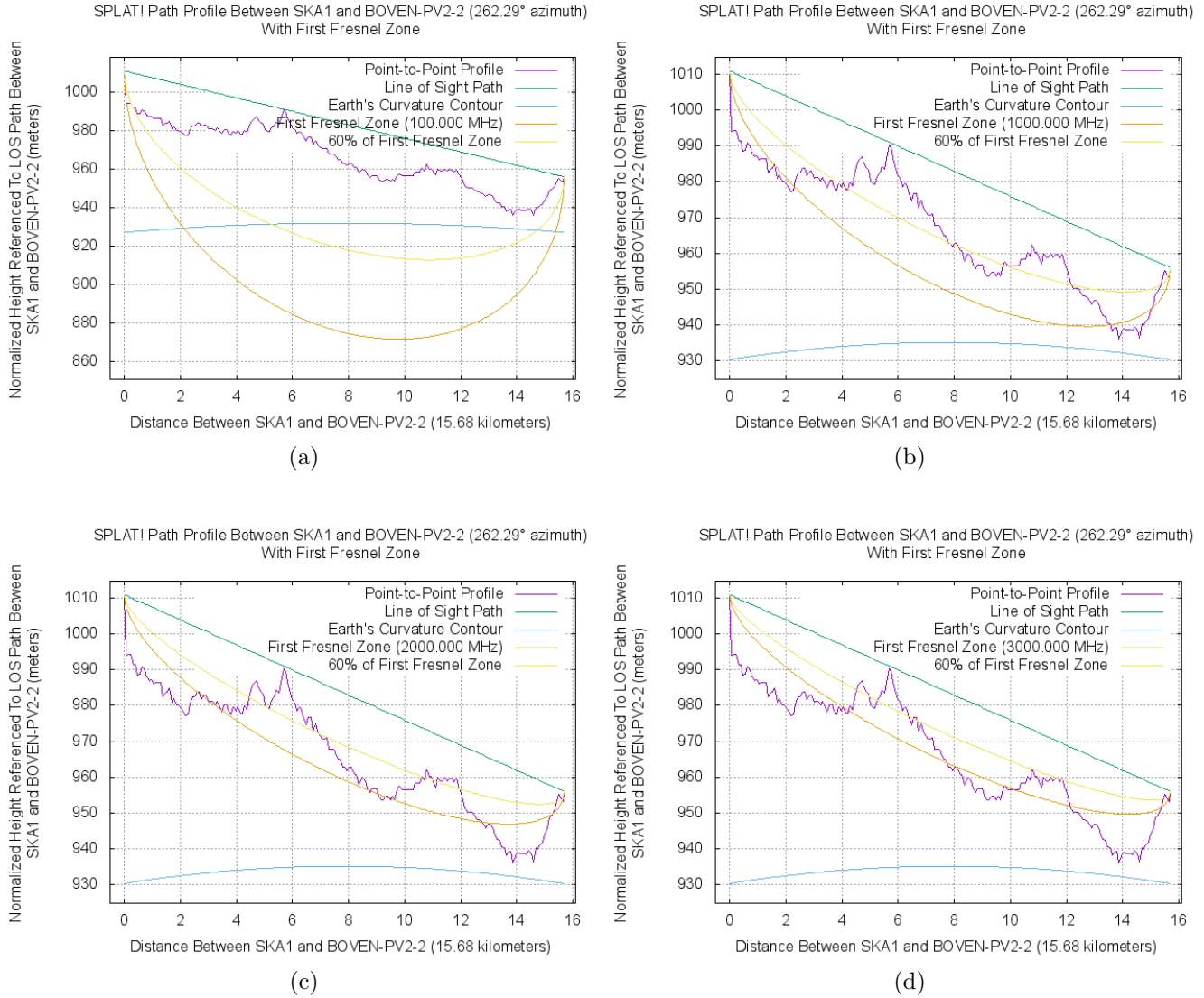

Figure 40: Fresnel zone, LOS and 60% of first Fresnel zone for site location of Boven PV2 to the closest SKA telescope for (a) 100 MHz (b) 1000 MHz (c) 2000 MHz and (d) 3000 MHz.

A.5 Boven PV2 to 2nd Closest SKA

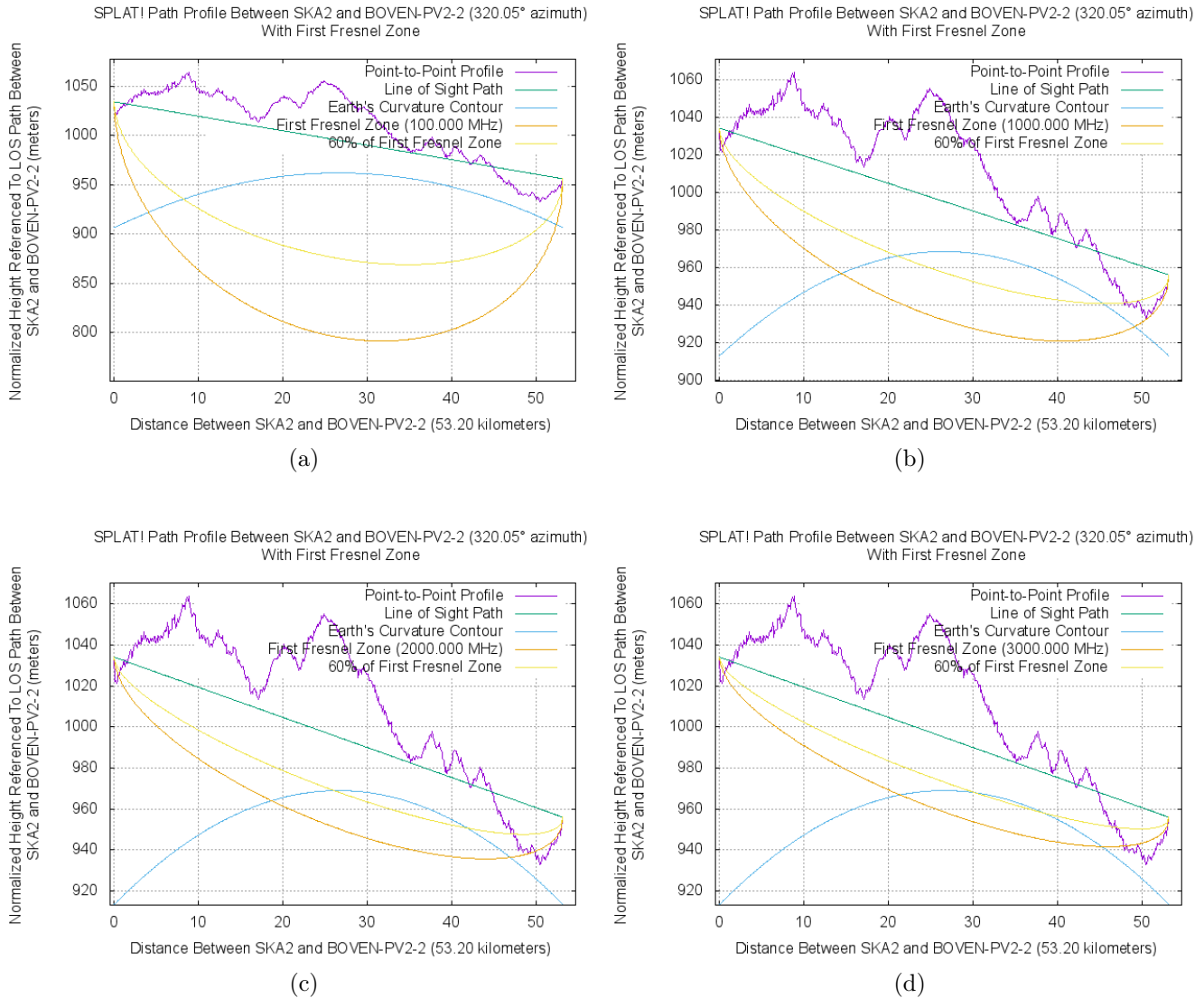

Figure 41: Fresnel zone, LOS and 60% of first Fresnel zone for site location of Boven PV2 to the second closest SKA telescope for (a) 100 MHz (b) 1000 MHz (c) 2000 MHz and (d) 3000 MHz.

A.6 Boven PV2 to Core SKA

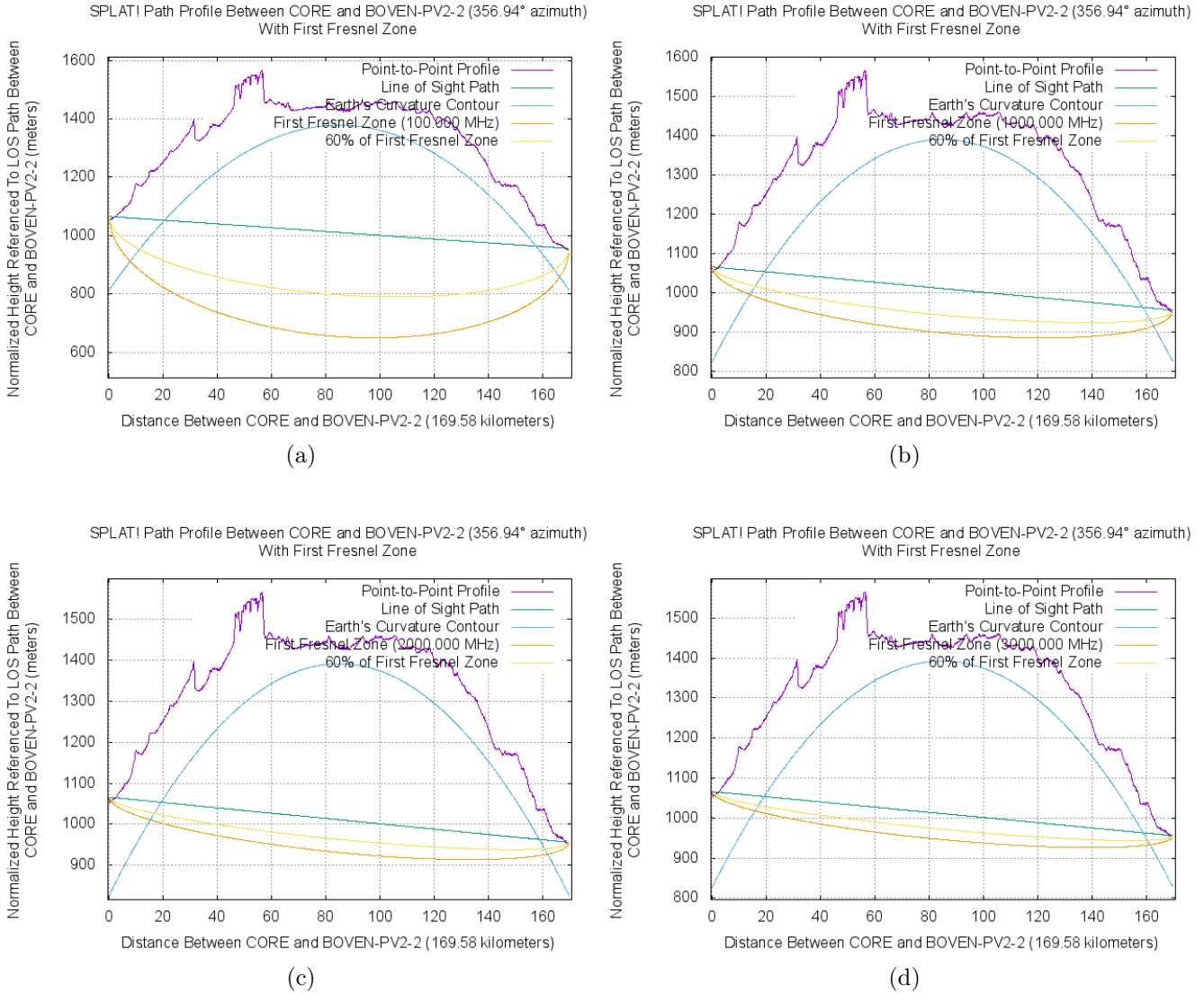

Figure 42: Fresnel zone, LOS and 60% of first Fresnel zone for site location of Boven PV2 to the core SKA telescopes for (a) 100 MHz (b) 1000 MHz (c) 2000 MHz and (d) 3000 MHz.

A.7 Boven PV2 Alternative to Closest SKA

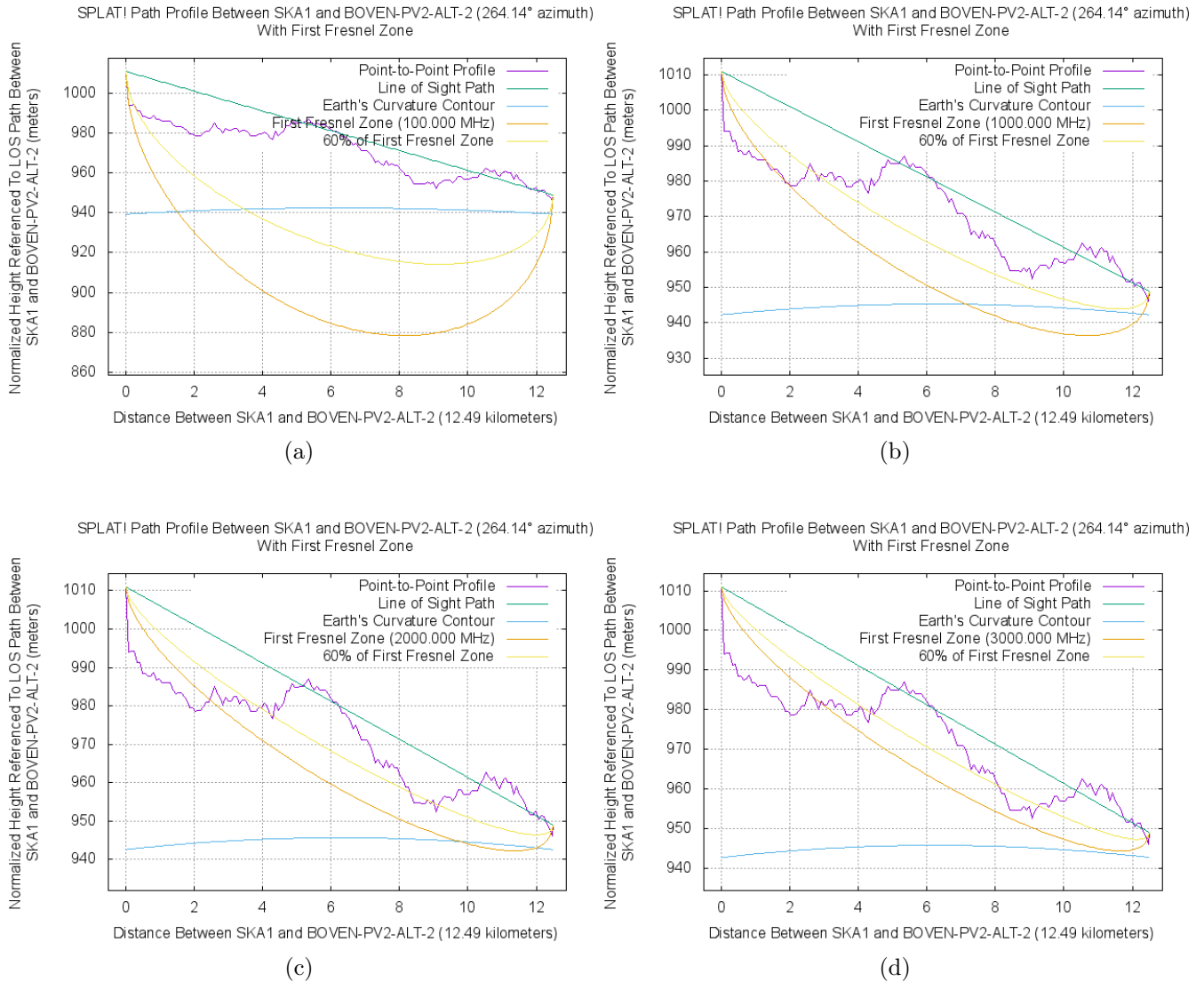

Figure 43: Fresnel zone, LOS and 60% of first Fresnel zone for site location of Boven PV2 Alternative to the closest SKA telescope for (a) 100 MHz (b) 1000 MHz (c) 2000 MHz and (d) 3000 MHz.

A.8 Boven PV2 Alternative to 2nd Closest SKA

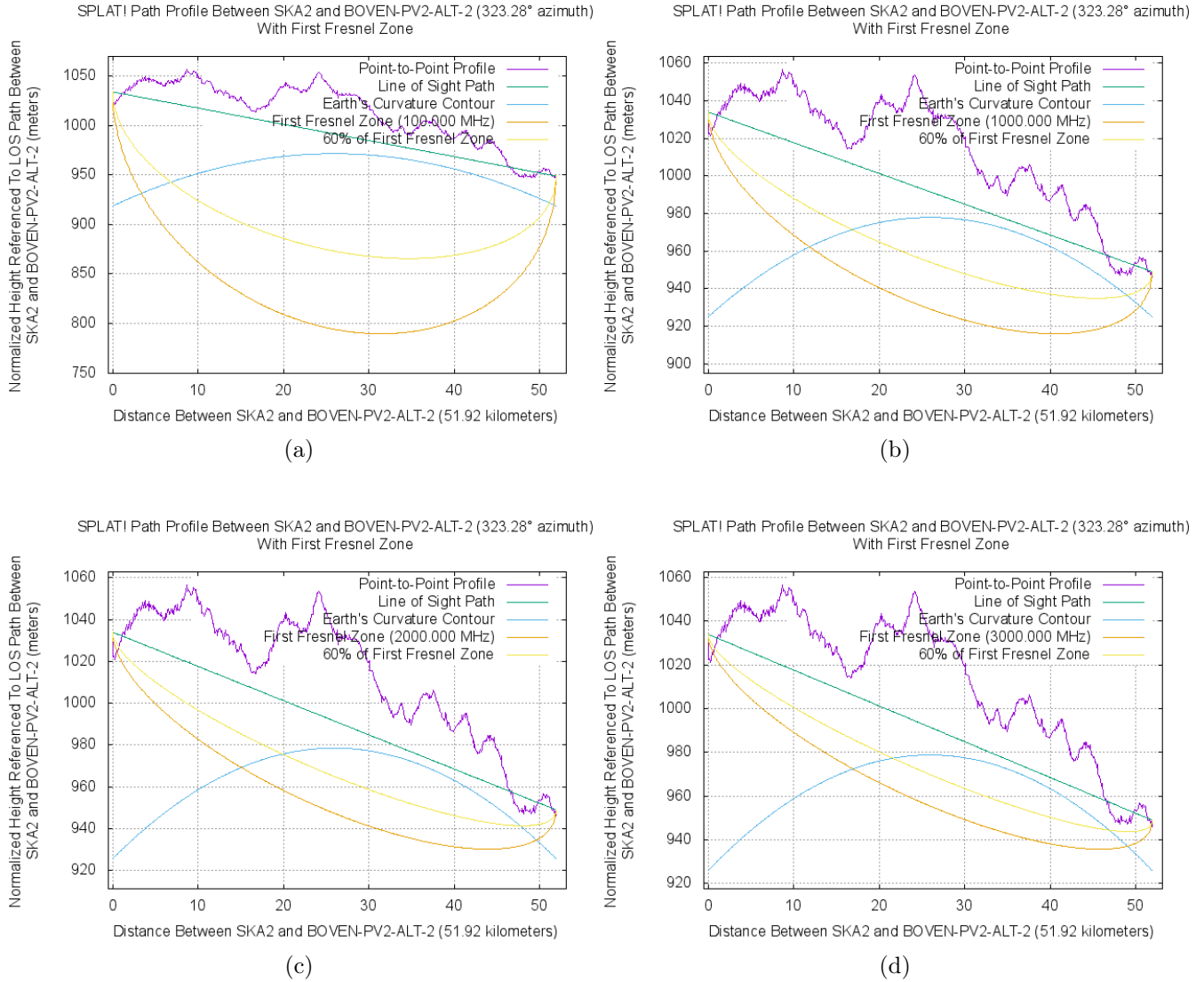

Figure 44: Fresnel zone, LOS and 60% of first Fresnel zone for site location of Boven PV2 Alternative to the second closest SKA telescope for (a) 100 MHz (b) 1000 MHz (c) 2000 MHz and (d) 3000 MHz.

A.9 Boven PV2 Alternative to Core SKA

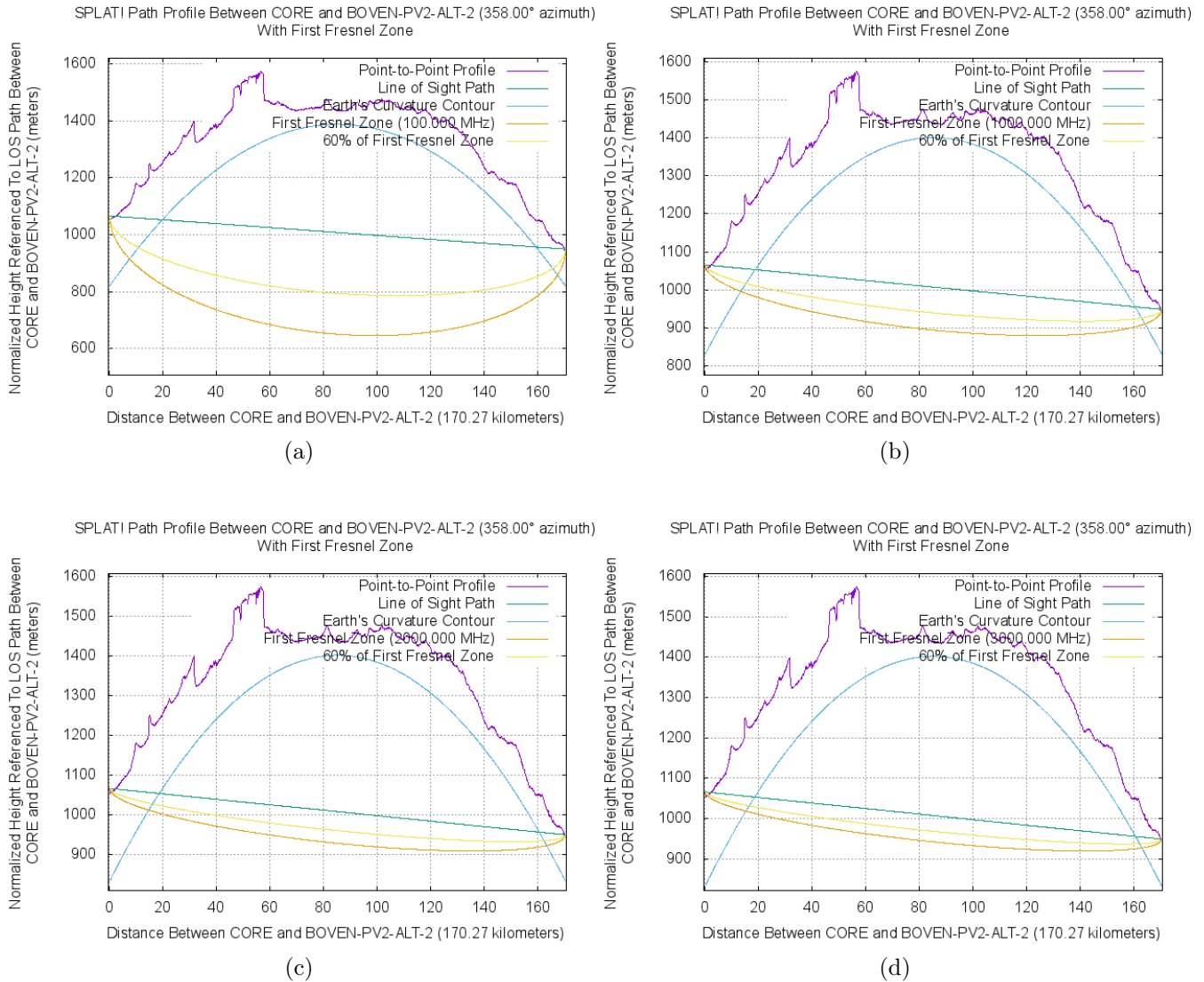

Figure 45: Fresnel zone, LOS and 60% of first Fresnel zone for site location of Boven PV2 Alternative to the core SKA telescopes for (a) 100 MHz (b) 1000 MHz (c) 2000 MHz and (d) 3000 MHz.

A.10 Boven PV3 to Closest SKA

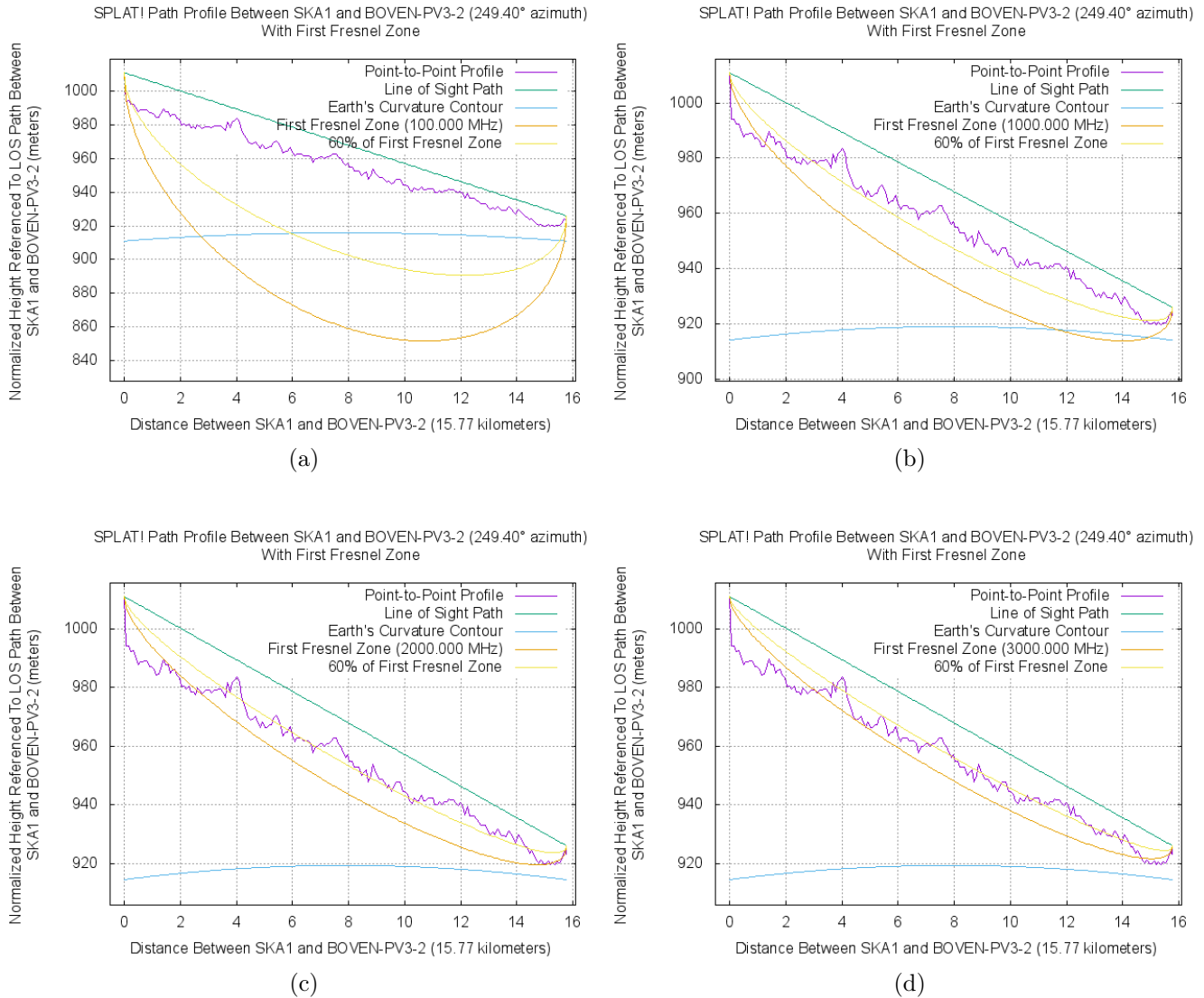

Figure 46: Fresnel zone, LOS and 60% of first Fresnel zone for site location of Boven PV3 to the closest SKA telescope for (a) 100 MHz (b) 1000 MHz (c) 2000 MHz and (d) 3000 MHz.

A.11 Boven PV3 to 2nd Closest SKA

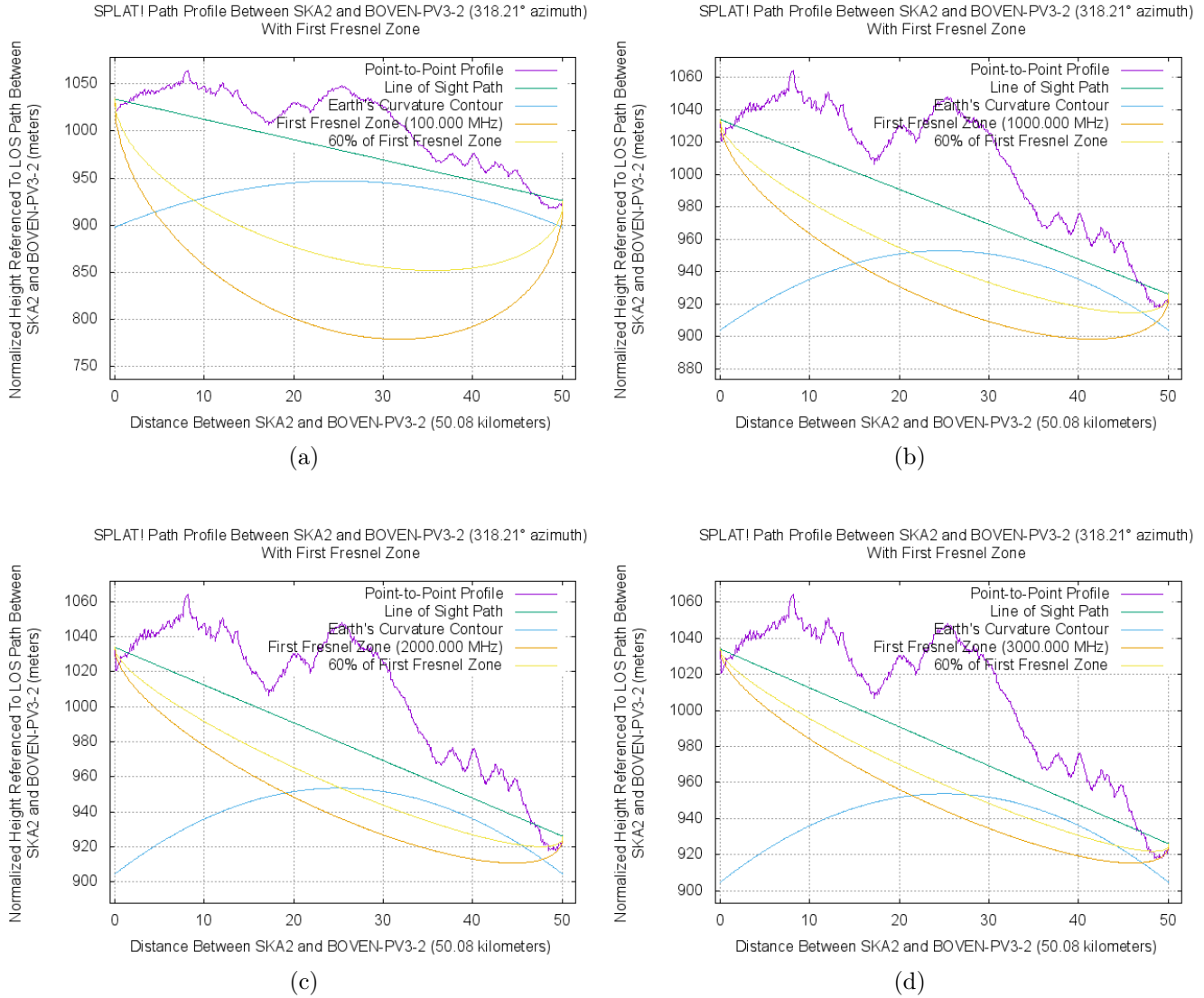

Figure 47: Fresnel zone, LOS and 60% of first Fresnel zone for site location of Boven PV3 to the second closest SKA telescope for (a) 100 MHz (b) 1000 MHz (c) 2000 MHz and (d) 3000 MHz.

A.12 Boven PV3 to Core SKA

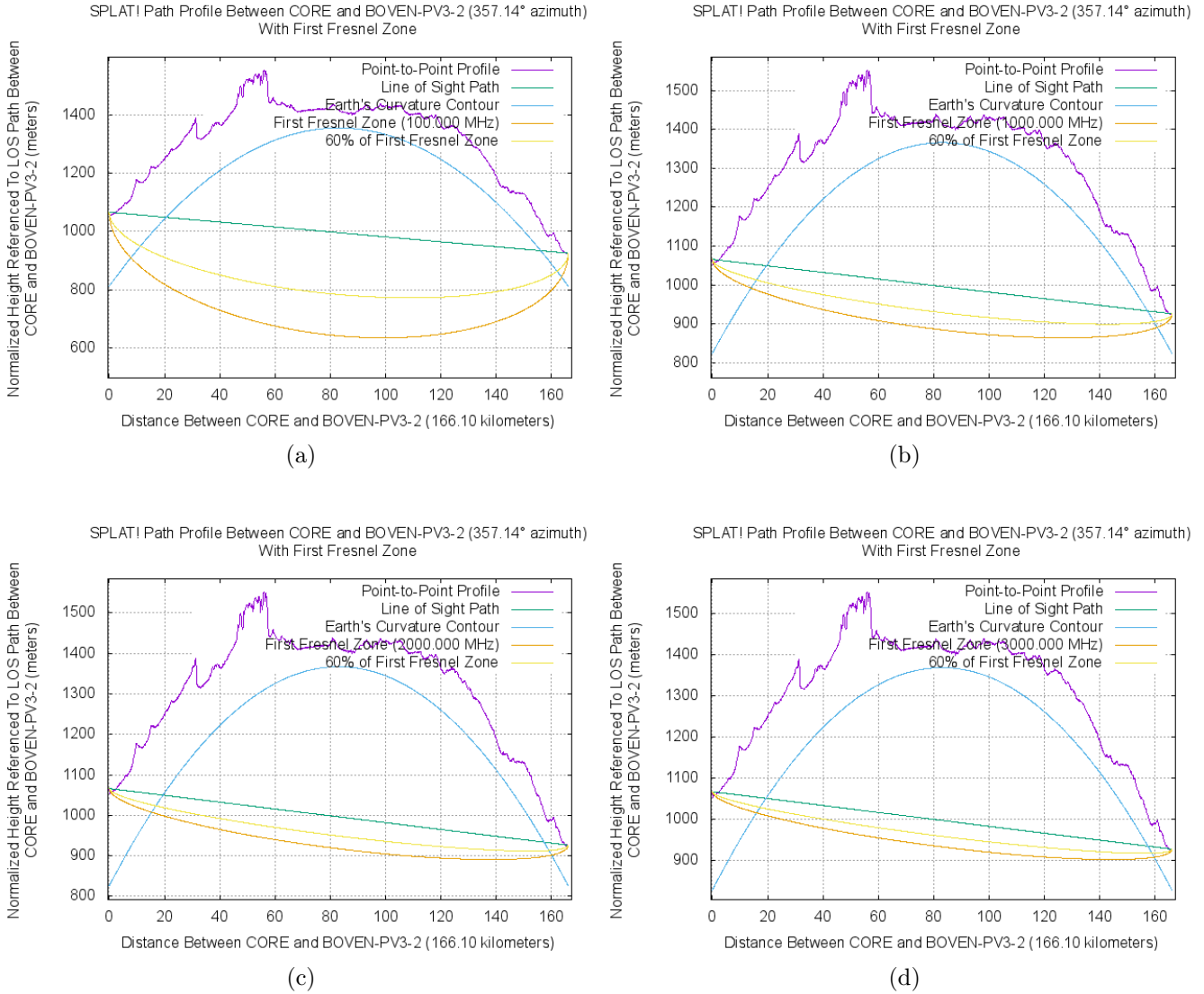

Figure 48: Fresnel zone, LOS and 60% of first Fresnel zone for site location of Boven PV3 to the core SKA telescopes for (a) 100 MHz (b) 1000 MHz (c) 2000 MHz and (d) 3000 MHz.

A.13 Boven PV3 Alternative to Closest SKA

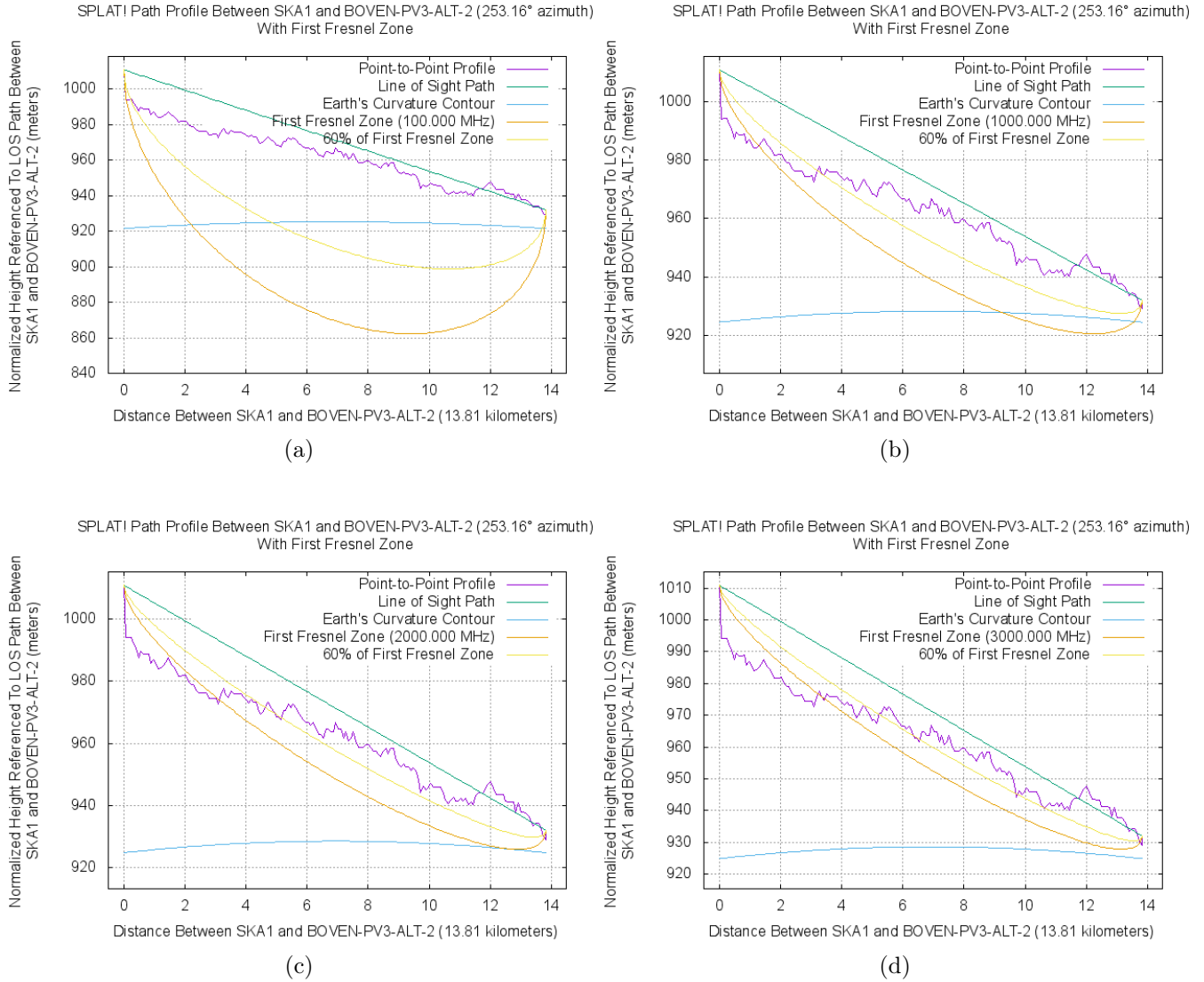

Figure 49: Fresnel zone, LOS and 60% of first Fresnel zone for site location of Boven PV3 Alternative to the closest SKA telescope for (a) 100 MHz (b) 1000 MHz (c) 2000 MHz and (d) 3000 MHz.

A.14 Boven PV3 Alternative to 2nd Closest SKA

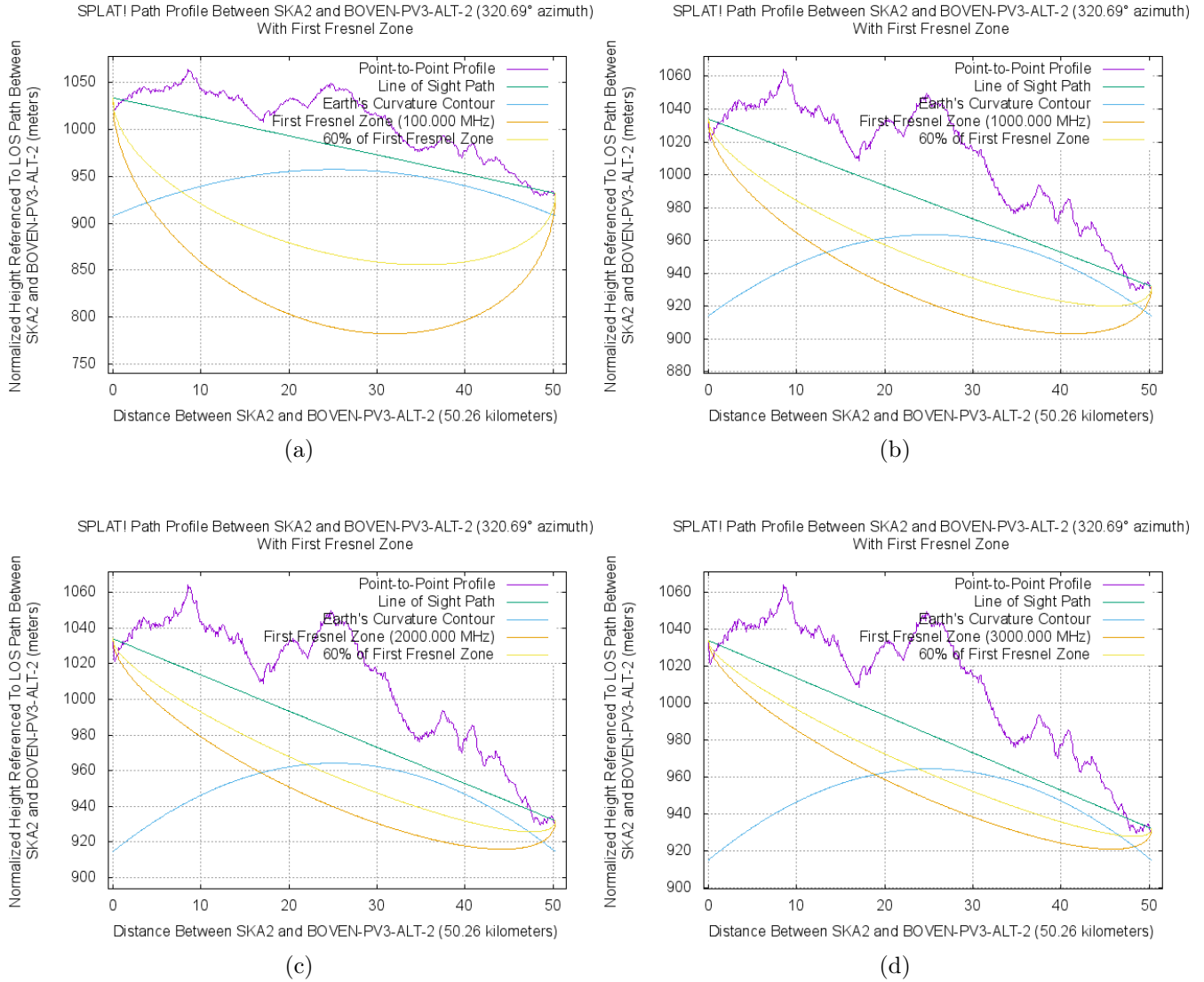

Figure 50: Fresnel zone, LOS and 60% of first Fresnel zone for site location of Boven PV3 Alternative to the second closest SKA telescope for (a) 100 MHz (b) 1000 MHz (c) 2000 MHz and (d) 3000 MHz.

A.15 Boven PV3 Alternative to Core SKA

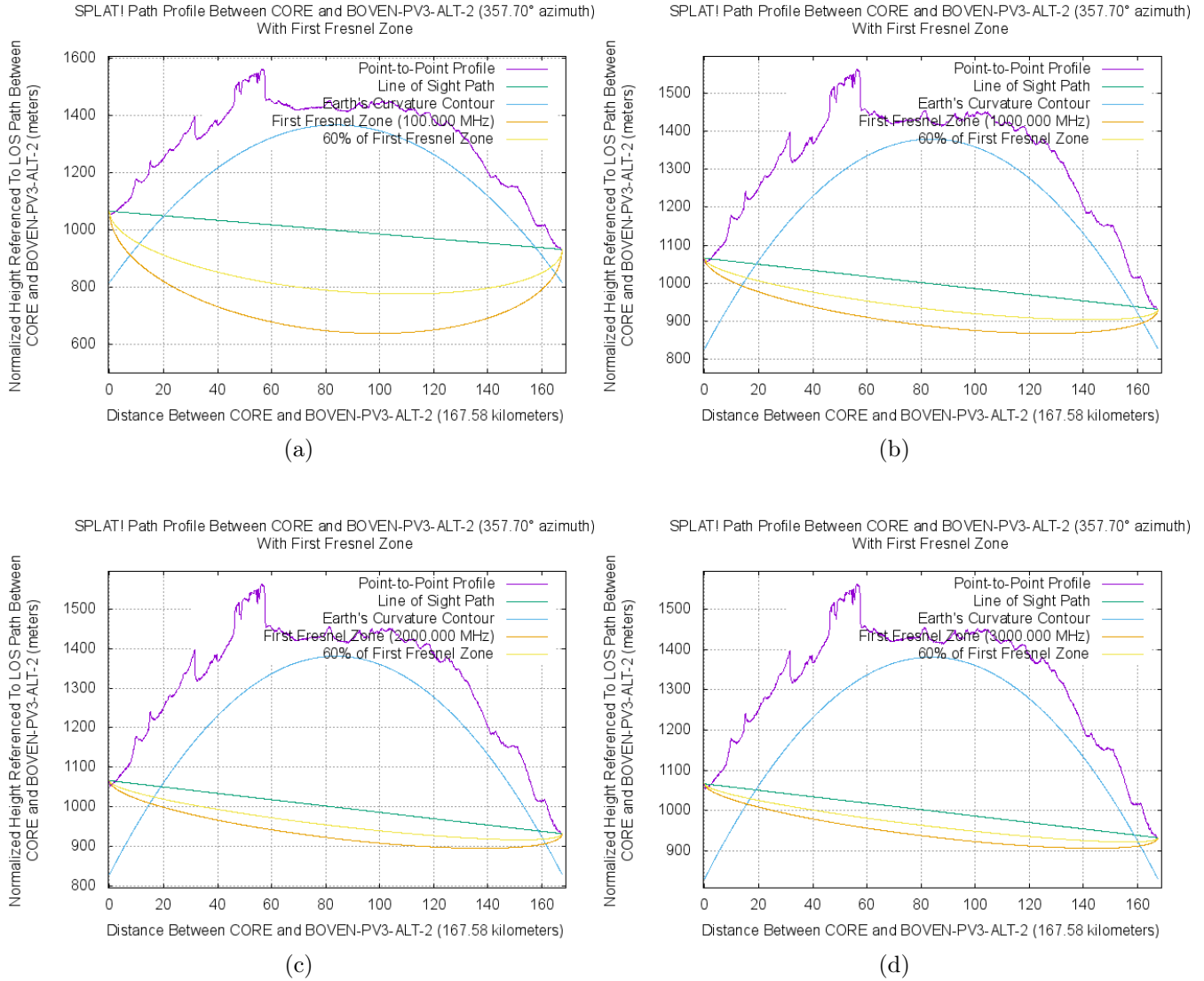

Figure 51: Fresnel zone, LOS and 60% of first Fresnel zone for site location of Boven PV3 Alternative to the core SKA telescopes for (a) 100 MHz (b) 1000 MHz (c) 2000 MHz and (d) 3000 MHz.

A.16 Boven PV4 to Closest SKA

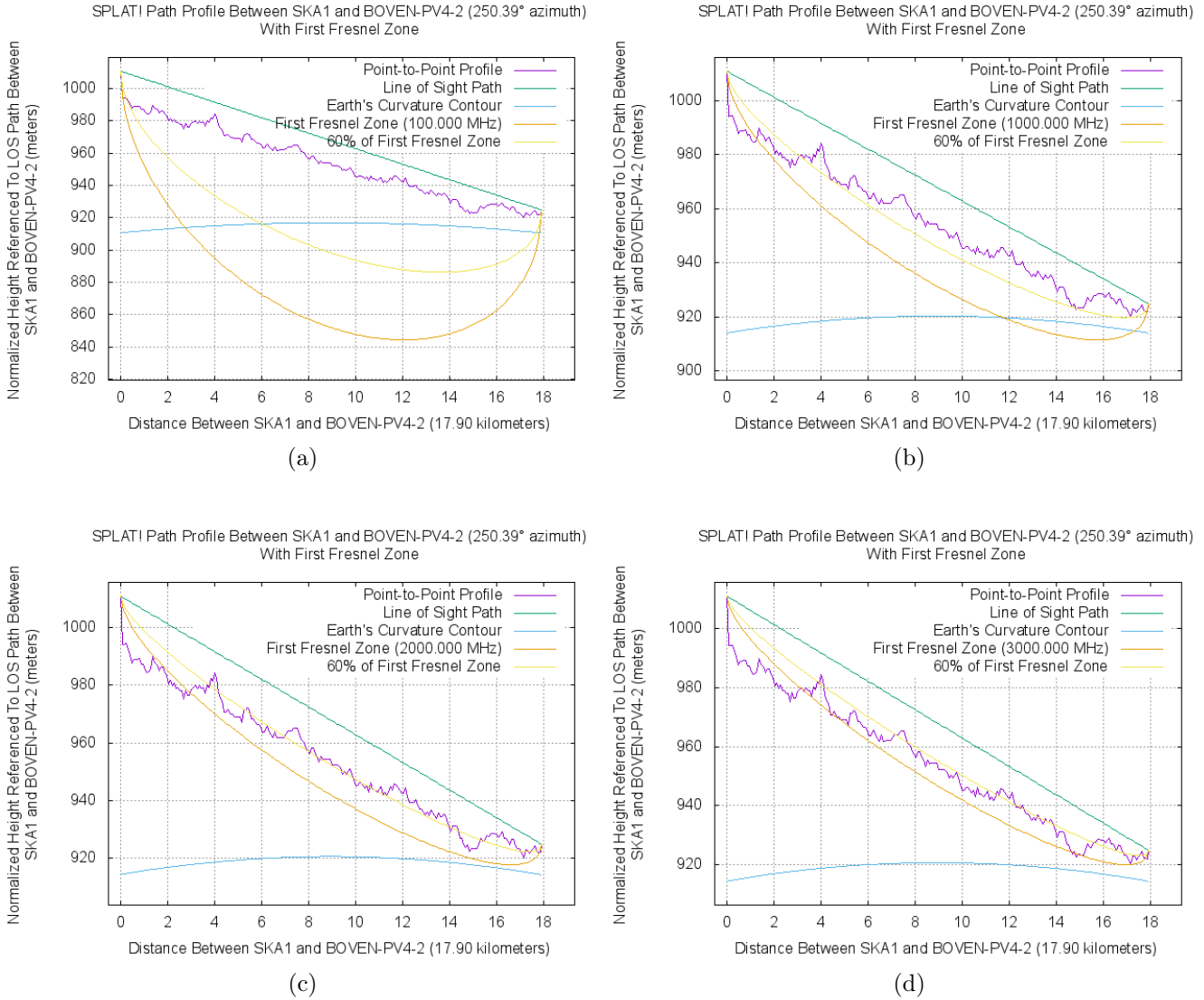

Figure 52: Fresnel zone, LOS and 60% of first Fresnel zone for site location of Boven PV4 to the closest SKA telescope for (a) 100 MHz (b) 1000 MHz (c) 2000 MHz and (d) 3000 MHz.

A.17 Boven PV4 to 2nd Closest SKA

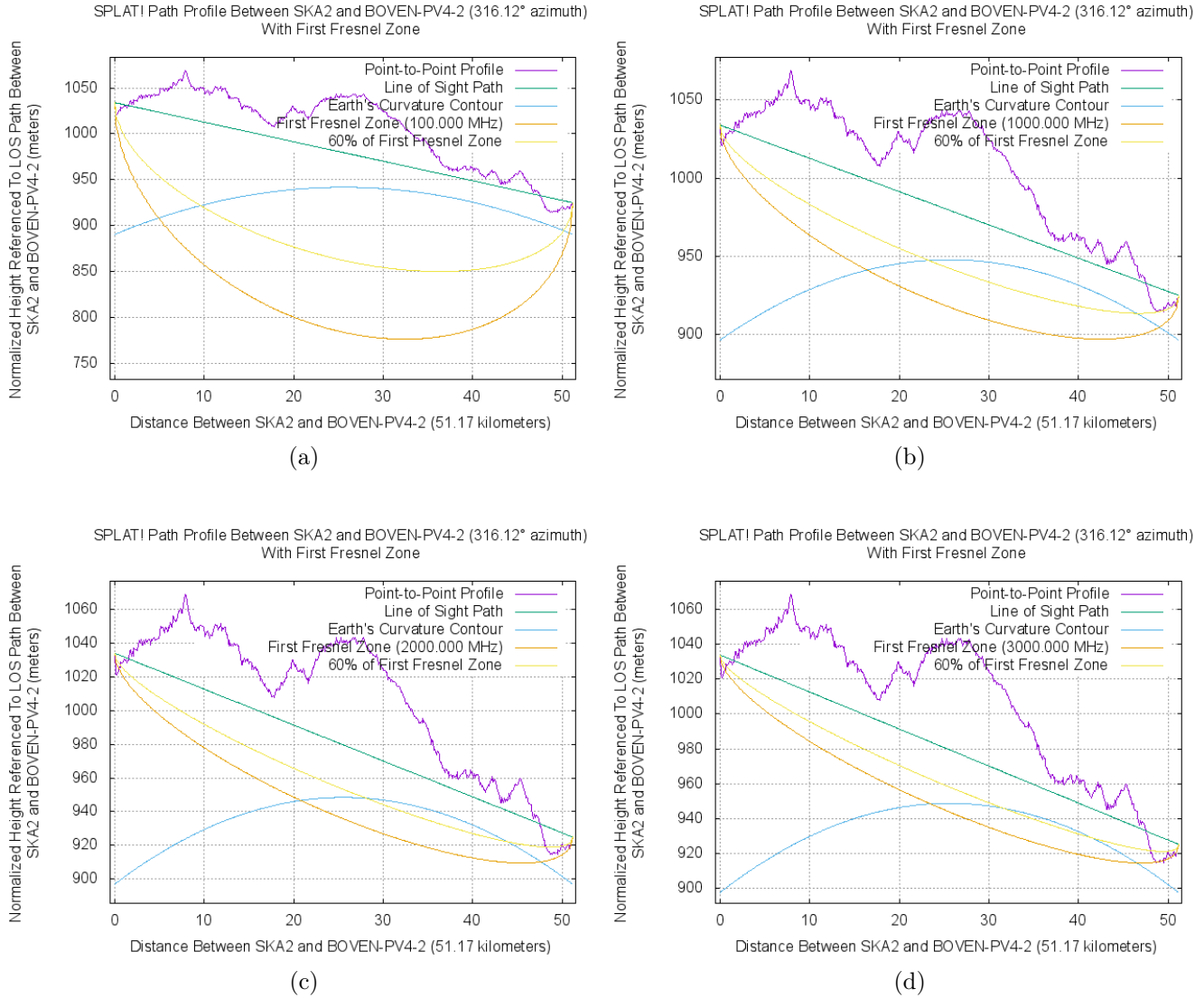

Figure 53: Fresnel zone, LOS and 60% of first Fresnel zone for site location of Boven PV4 to the second closest SKA telescope for (a) 100 MHz (b) 1000 MHz (c) 2000 MHz and (d) 3000 MHz.

A.18 Boven PV4 to Core SKA

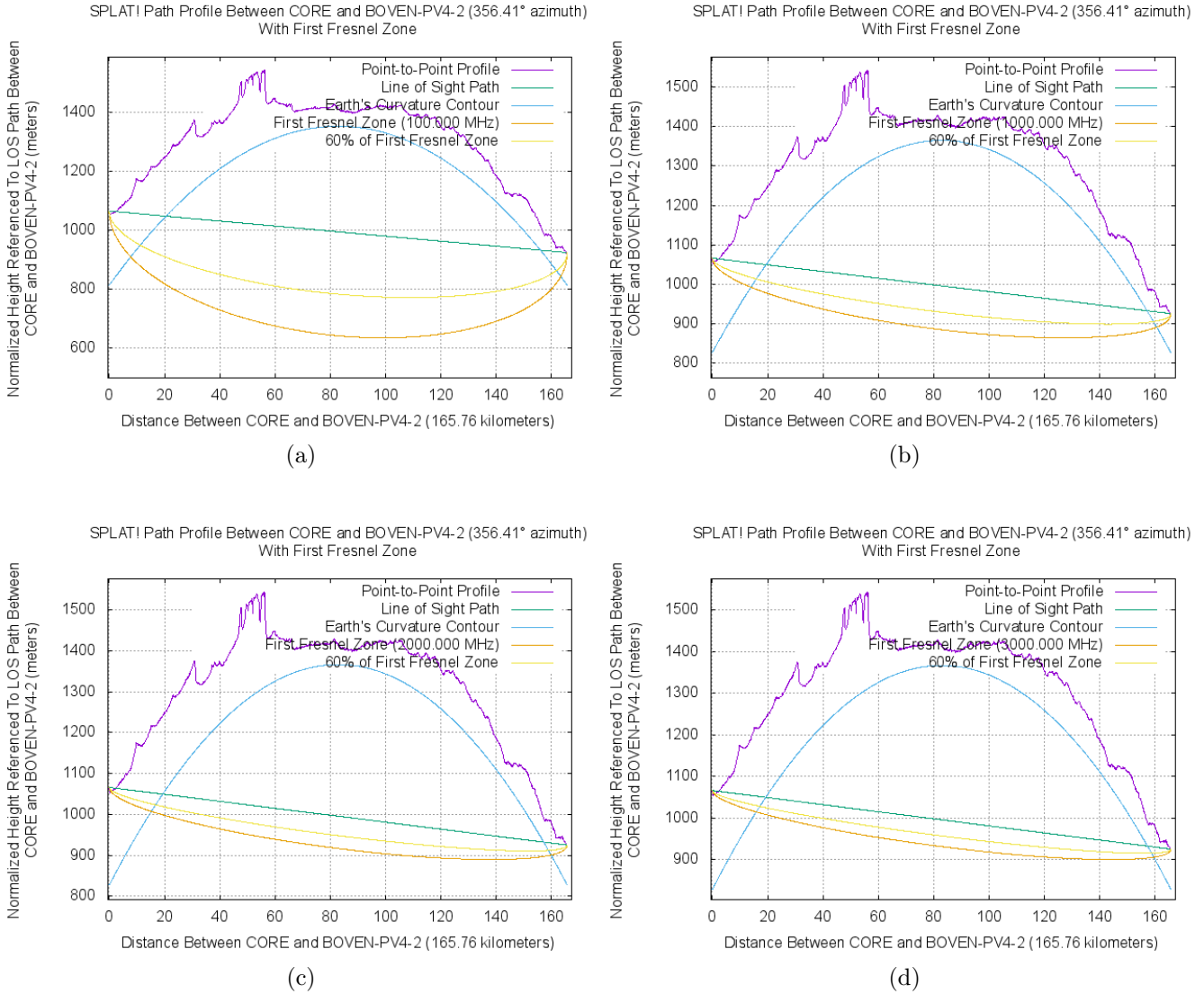

Figure 54: Fresnel zone, LOS and 60% of first Fresnel zone for site location of Boven PV4 to the core SKA telescopes for (a) 100 MHz (b) 1000 MHz (c) 2000 MHz and (d) 3000 MHz.

A.19 Boven PV4 Alternative to Closest SKA

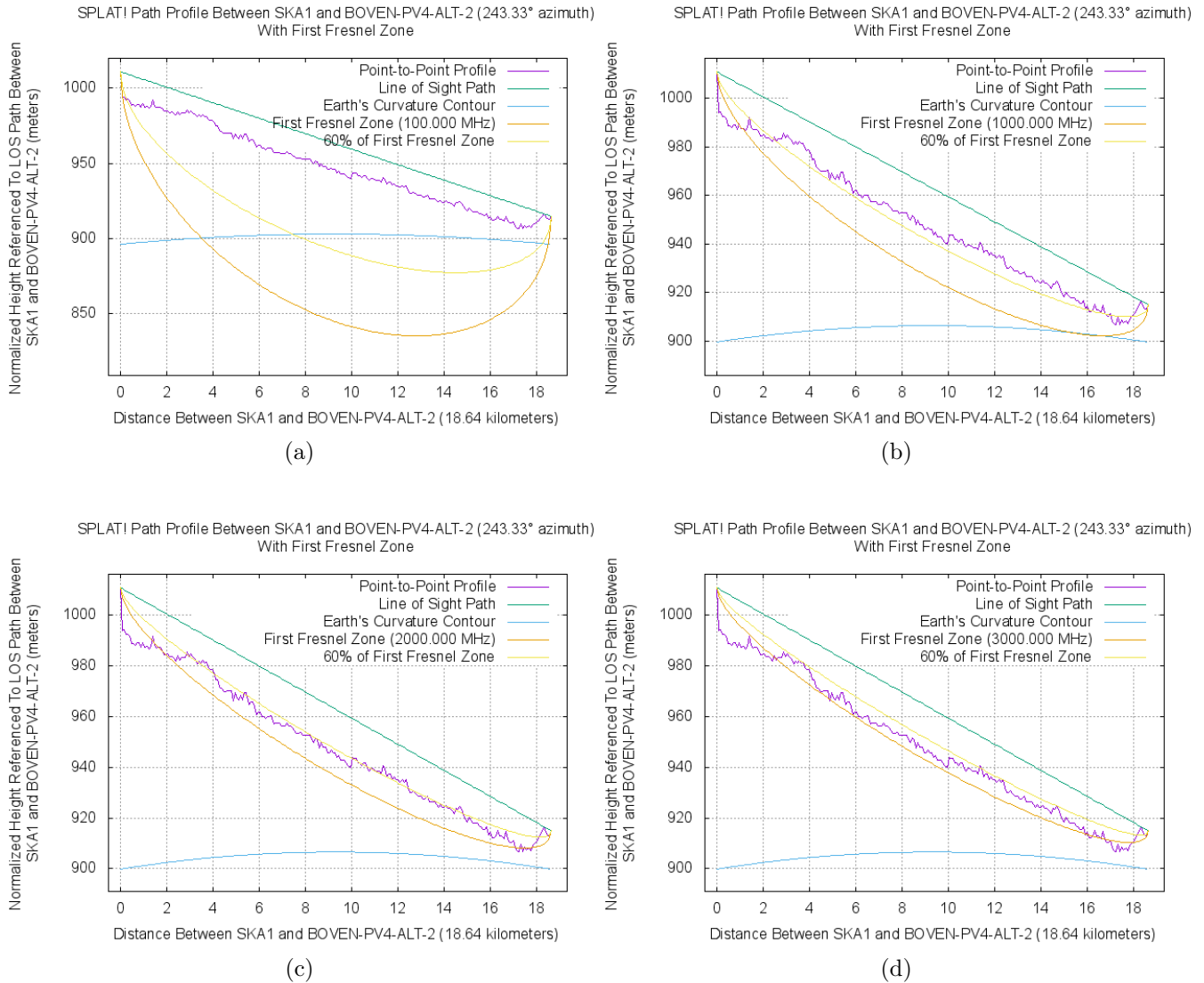

Figure 55: Fresnel zone, LOS and 60% of first Fresnel zone for site location of Boven PV4 Alternative to the closest SKA telescope for (a) 100 MHz (b) 1000 MHz (c) 2000 MHz and (d) 3000 MHz.

A.20 Boven PV4 Alternative to 2nd Closest SKA

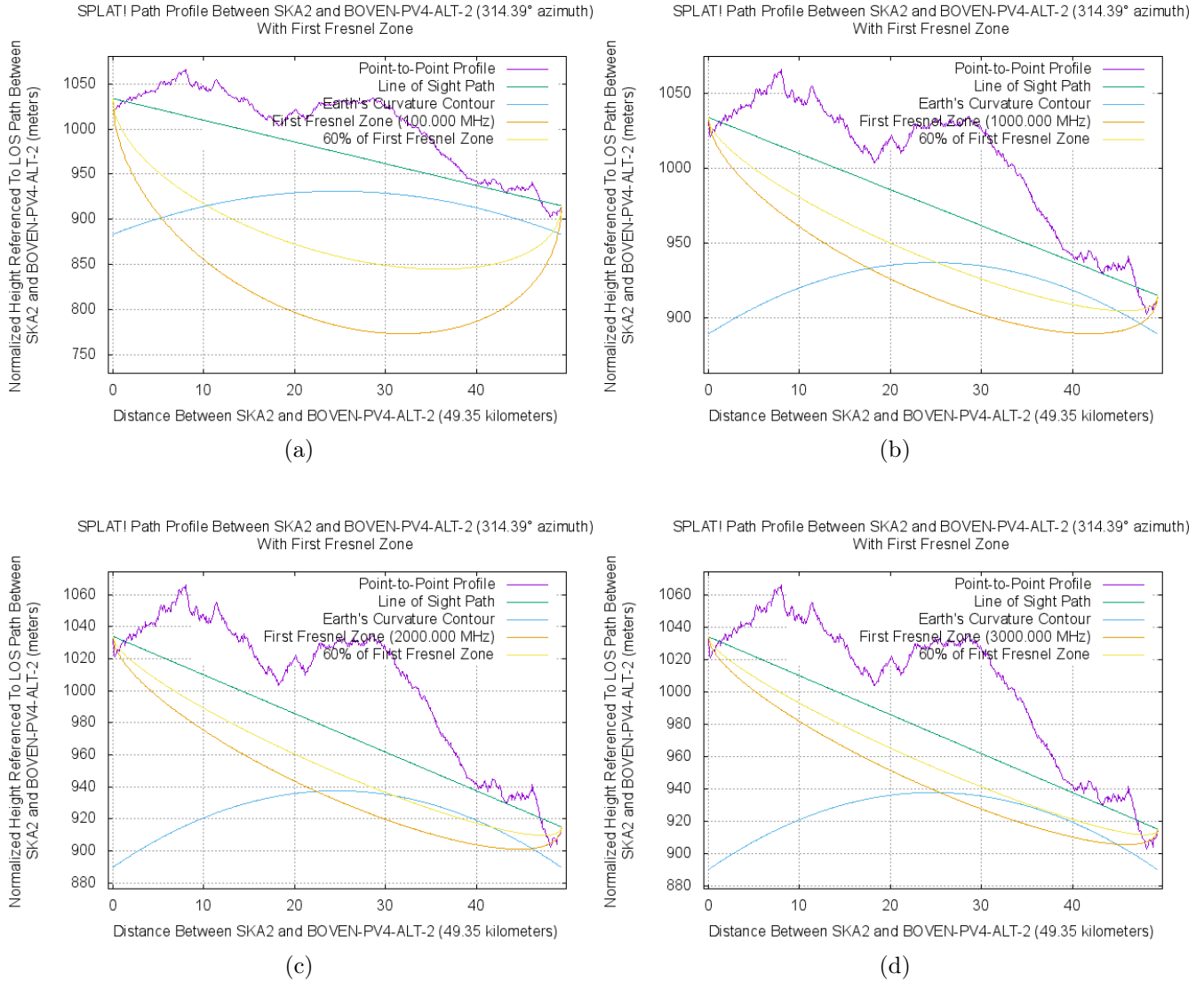

Figure 56: Fresnel zone, LOS and 60% of first Fresnel zone for site location of Boven PV4 Alternative to the second closest SKA telescope for (a) 100 MHz (b) 1000 MHz (c) 2000 MHz and (d) 3000 MHz.

A.21 Boven PV4 Alternative to Core SKA

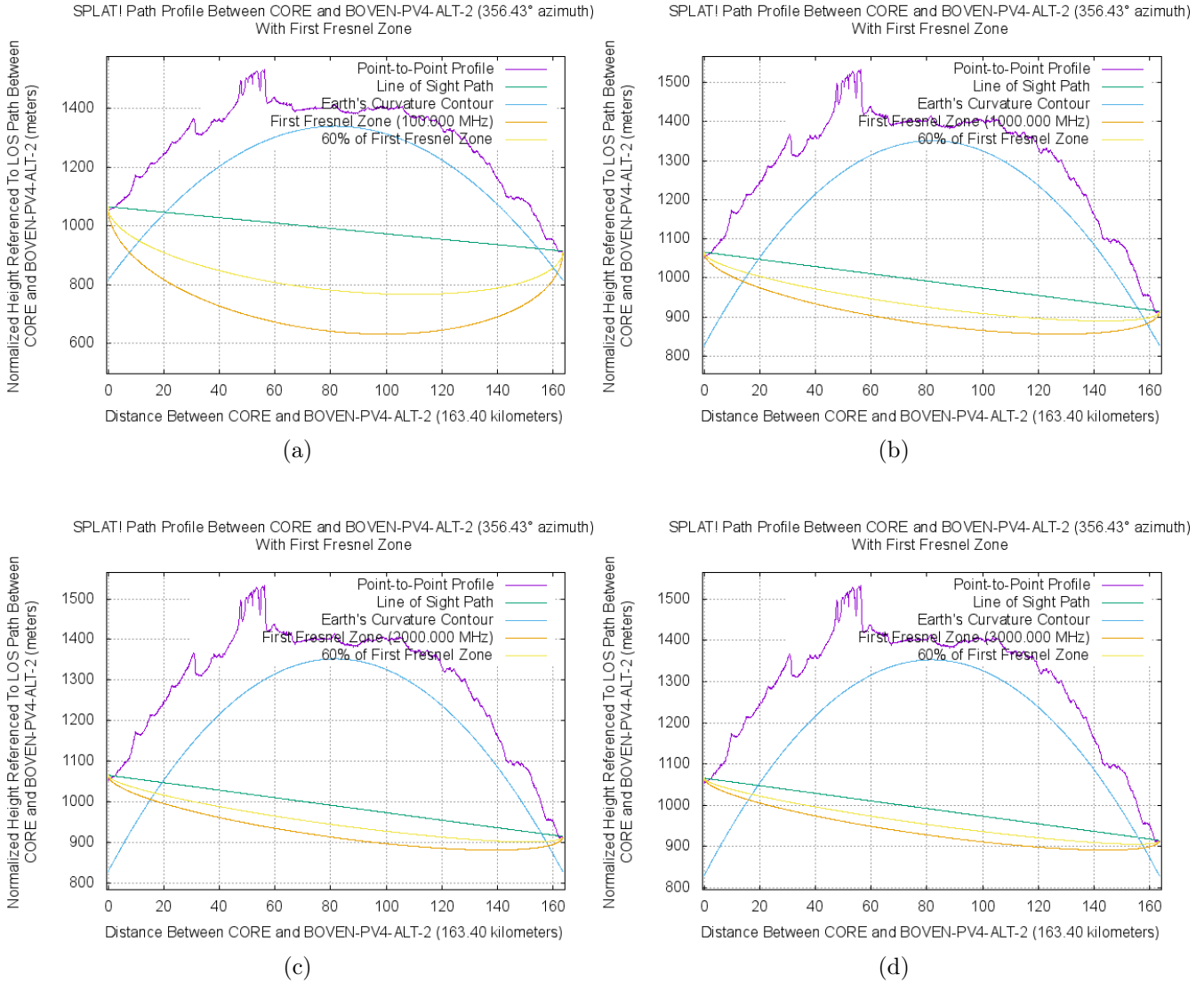

Figure 57: Fresnel zone, LOS and 60% of first Fresnel zone for site location of Boven PV4 Alternative to the core SKA telescopes for (a) 100 MHz (b) 1000 MHz (c) 2000 MHz and (d) 3000 MHz.

A.22 Gemsbok PV1 to Closest SKA

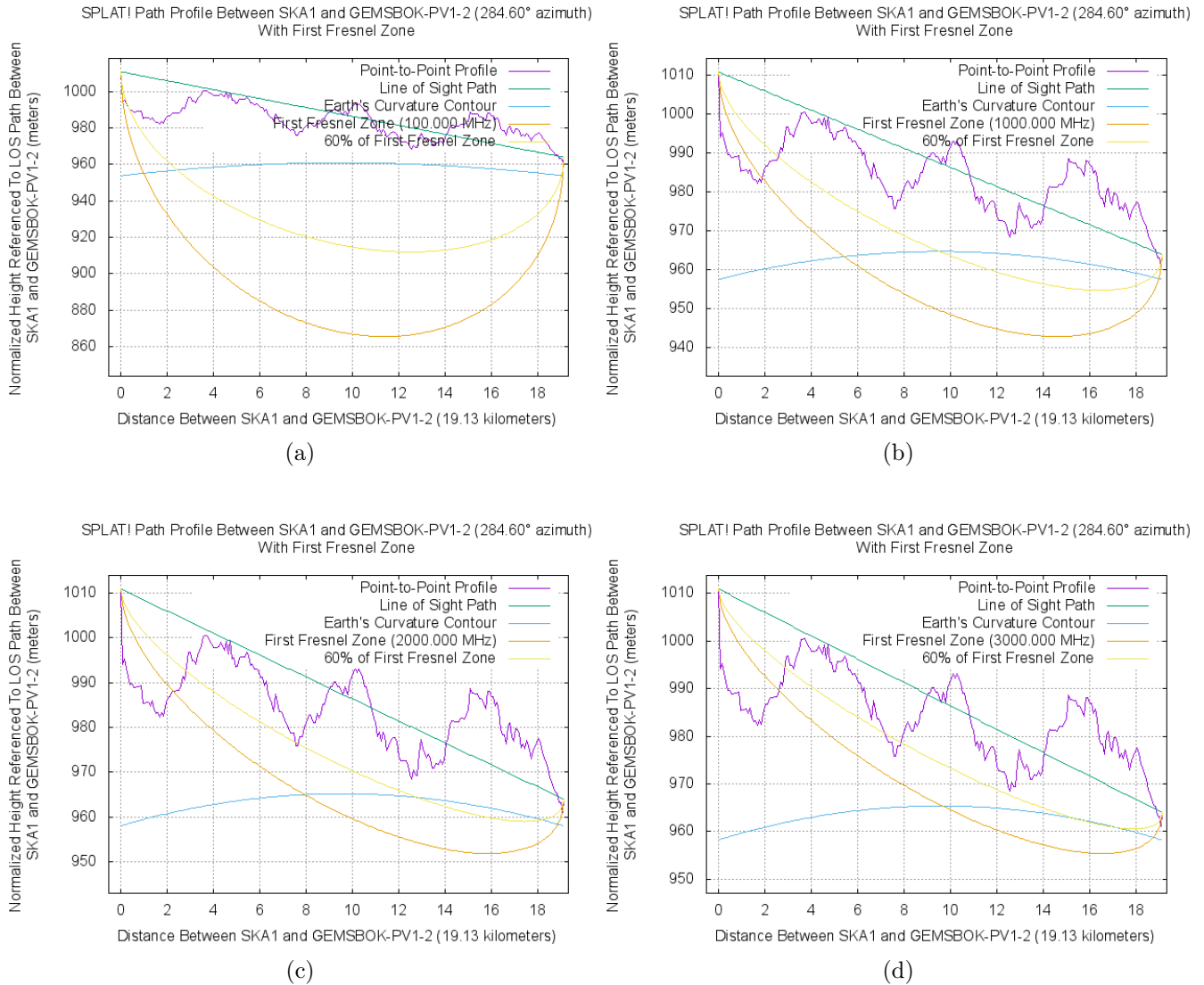

Figure 58: Fresnel zone, LOS and 60% of first Fresnel zone for site location of Gemsbok PV1 to the closest SKA telescope for (a) 100 MHz (b) 1000 MHz (c) 2000 MHz and (d) 3000 MHz.

A.23 Gemsbok PV1 to 2nd Closest SKA

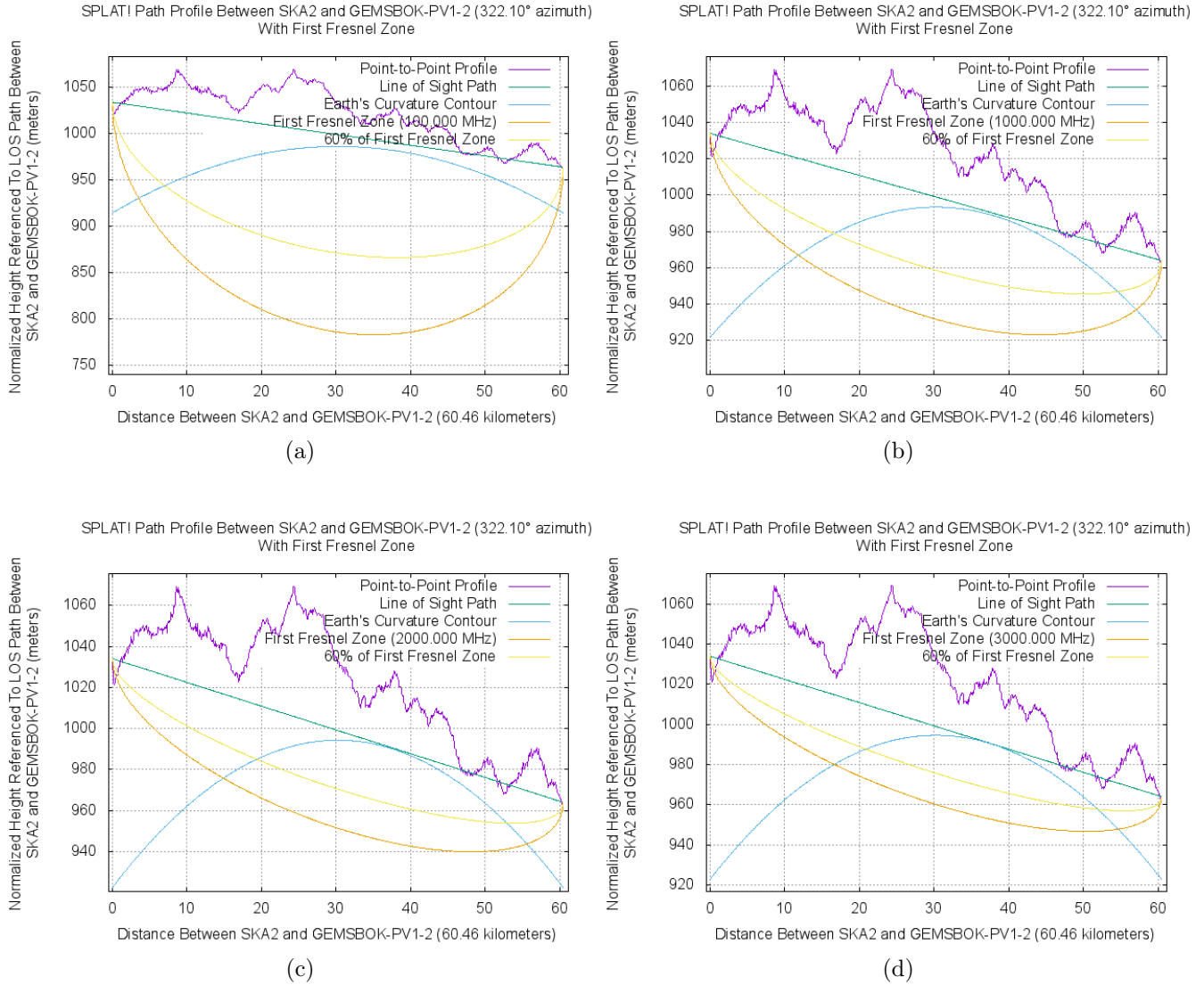

Figure 59: Fresnel zone, LOS and 60% of first Fresnel zone for site location of Gemsbok PV1 to the second closest SKA telescope for (a) 100 MHz (b) 1000 MHz (c) 2000 MHz and (d) 3000 MHz.

A.24 Gemsbok PV1 to Core SKA

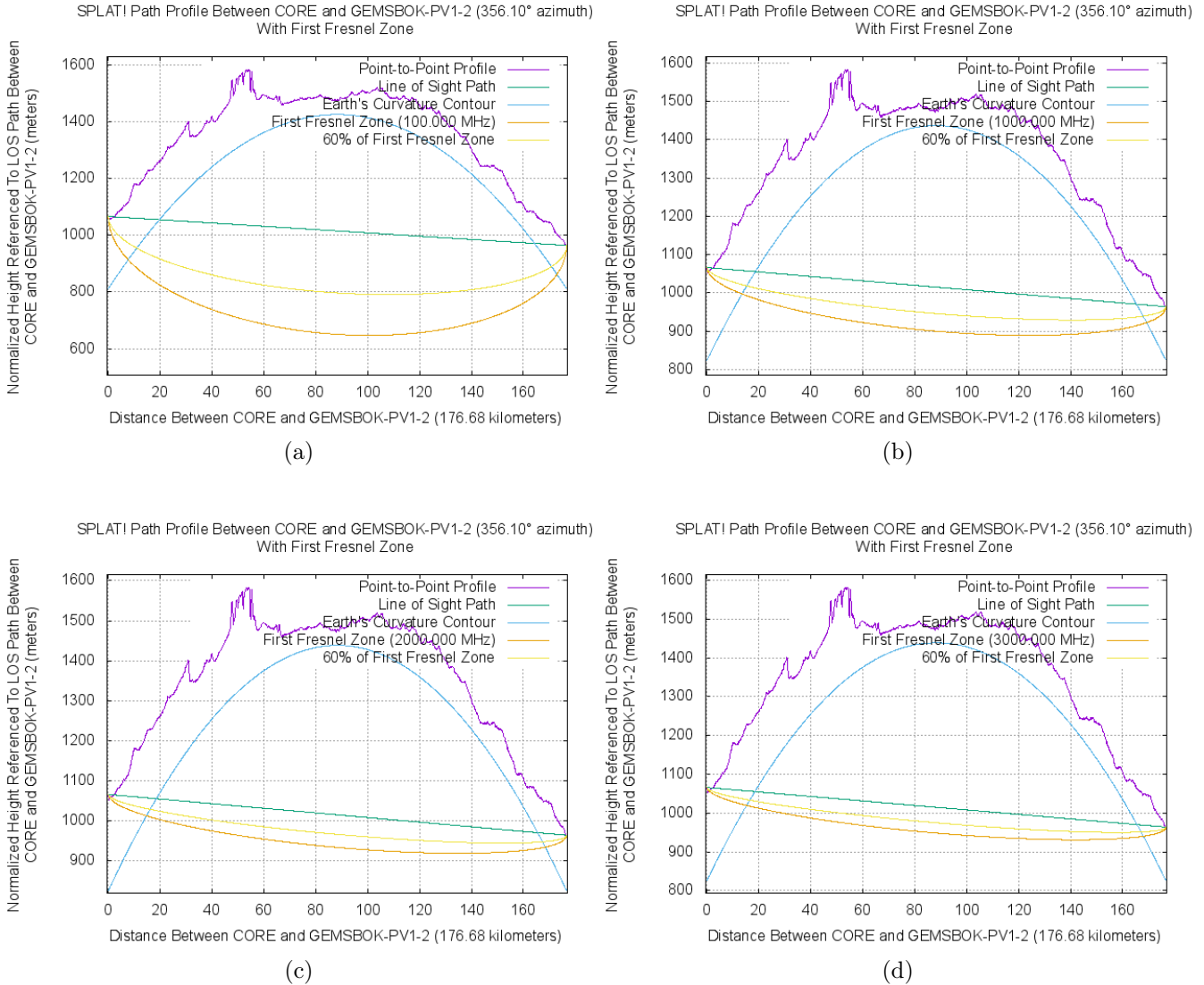

Figure 60: Fresnel zone, LOS and 60% of first Fresnel zone for site location of Gemsbok PV1 to the core SKA telescopes for (a) 100 MHz (b) 1000 MHz (c) 2000 MHz and (d) 3000 MHz.

A.25 Gemsbok PV2 to Closest SKA

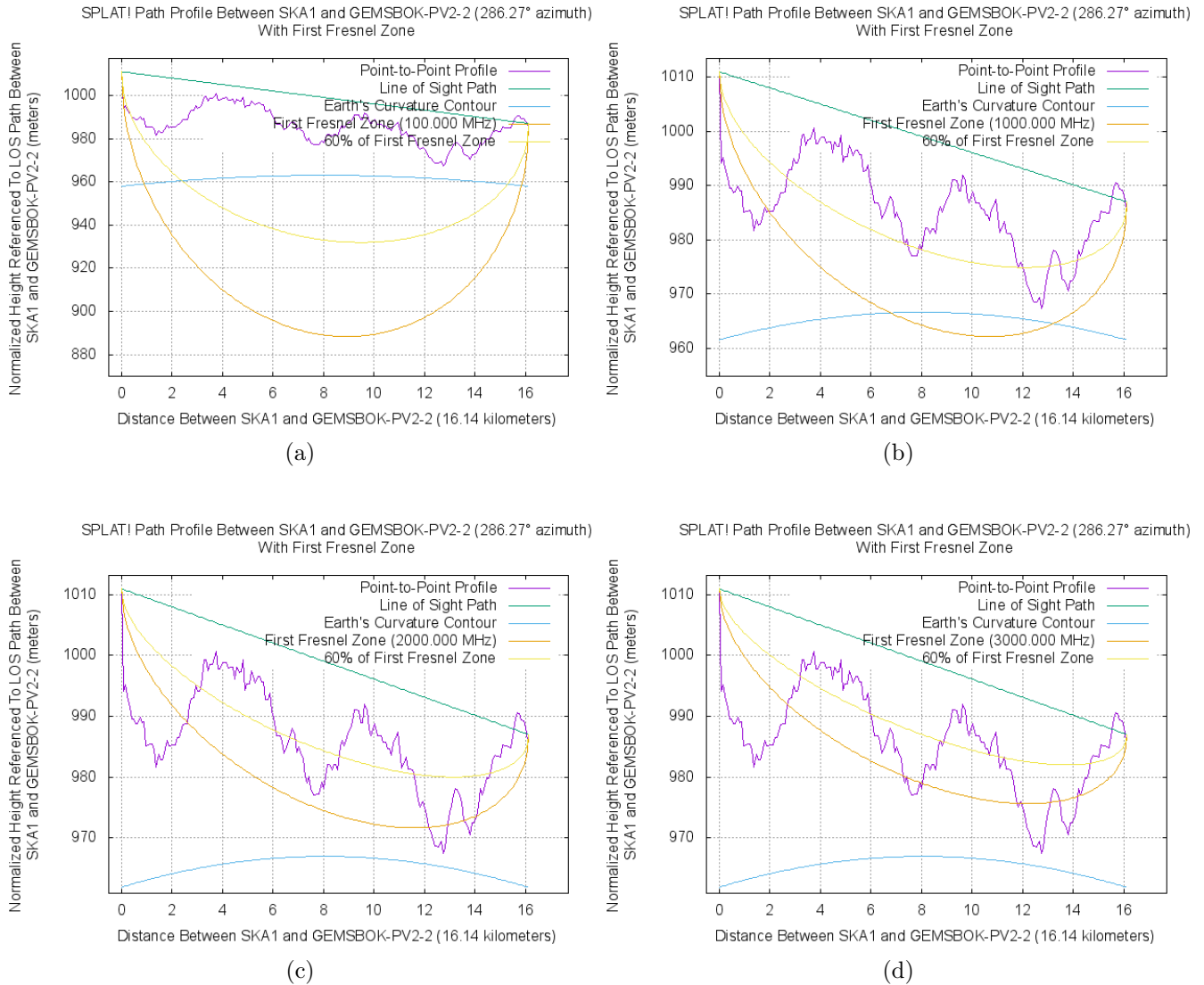

Figure 61: Fresnel zone, LOS and 60% of first Fresnel zone for site location of Gemsbok PV2 to the closest SKA telescope for (a) 100 MHz (b) 1000 MHz (c) 2000 MHz and (d) 3000 MHz.

A.26 Gemsbok PV2 to 2nd Closest SKA

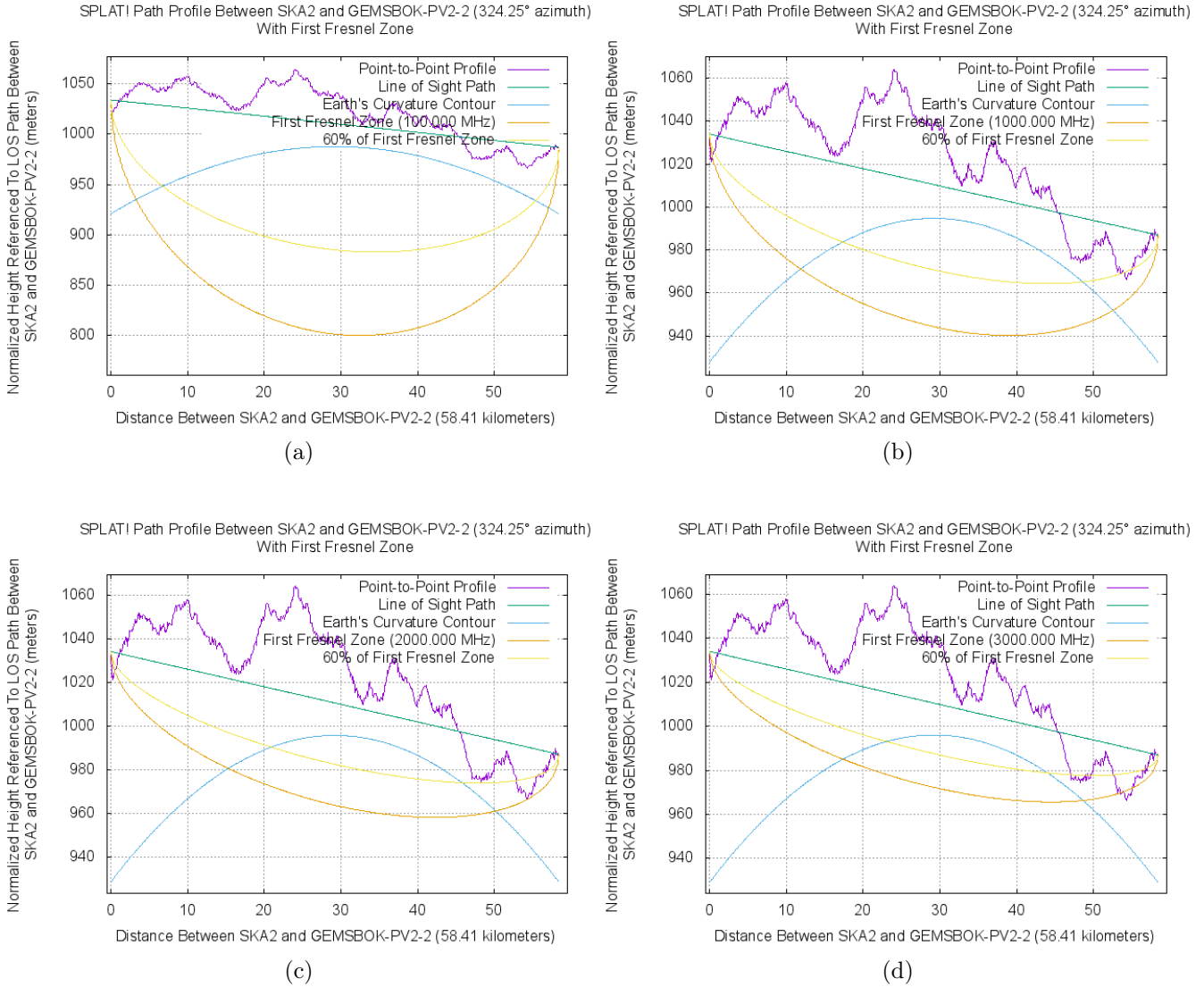

Figure 62: Fresnel zone, LOS and 60% of first Fresnel zone for site location of Gemsbok PV2 to the second closest SKA telescope for (a) 100 MHz (b) 1000 MHz (c) 2000 MHz and (d) 3000 MHz.

A.27 Gemsbok PV2 to Core SKA

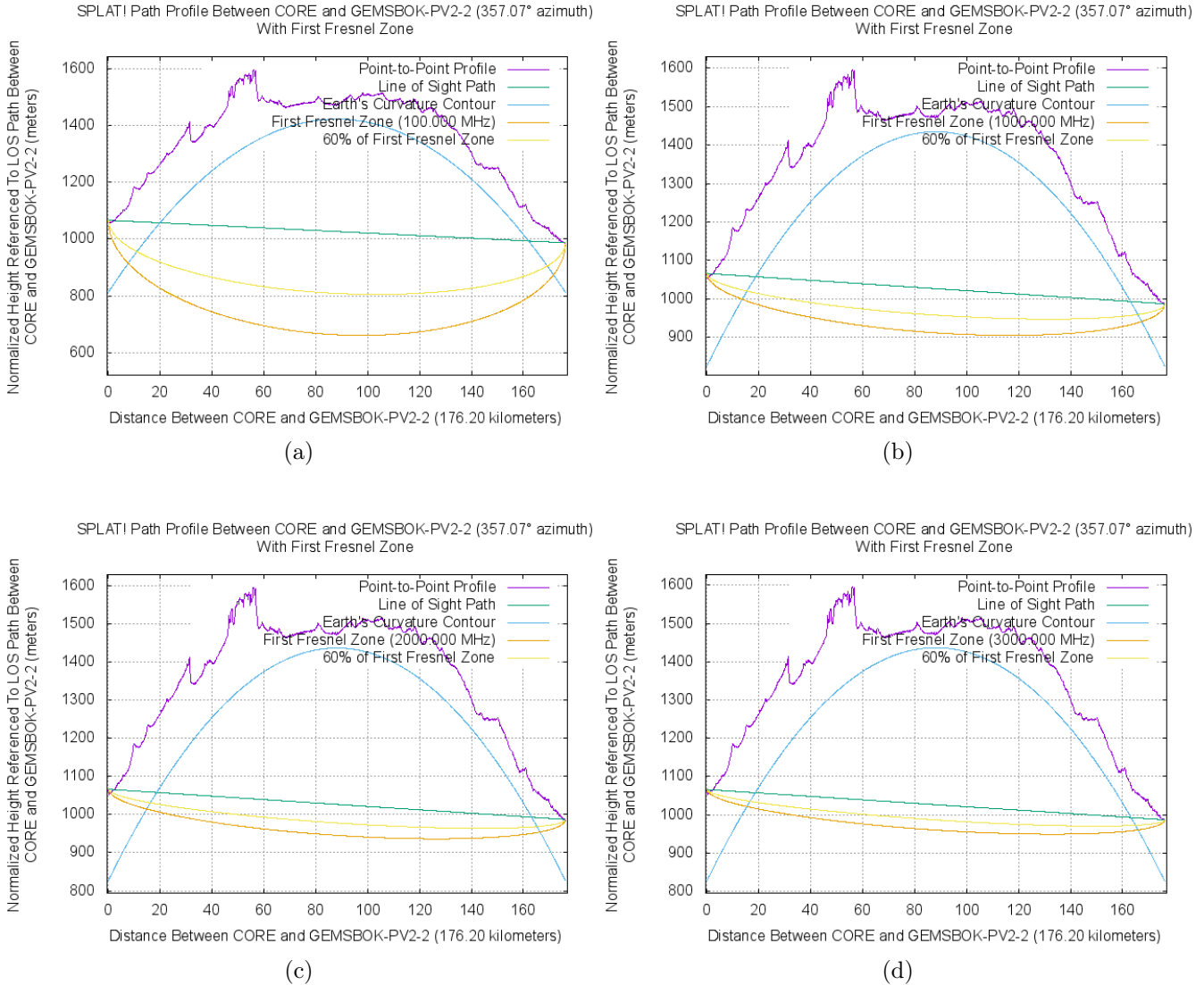

Figure 63: Fresnel zone, LOS and 60% of first Fresnel zone for site location of Gemsbok PV2 to the core SKA telescopes for (a) 100 MHz (b) 1000 MHz (c) 2000 MHz and (d) 3000 MHz.

A.28 Gemsbok PV3 to Closest SKA

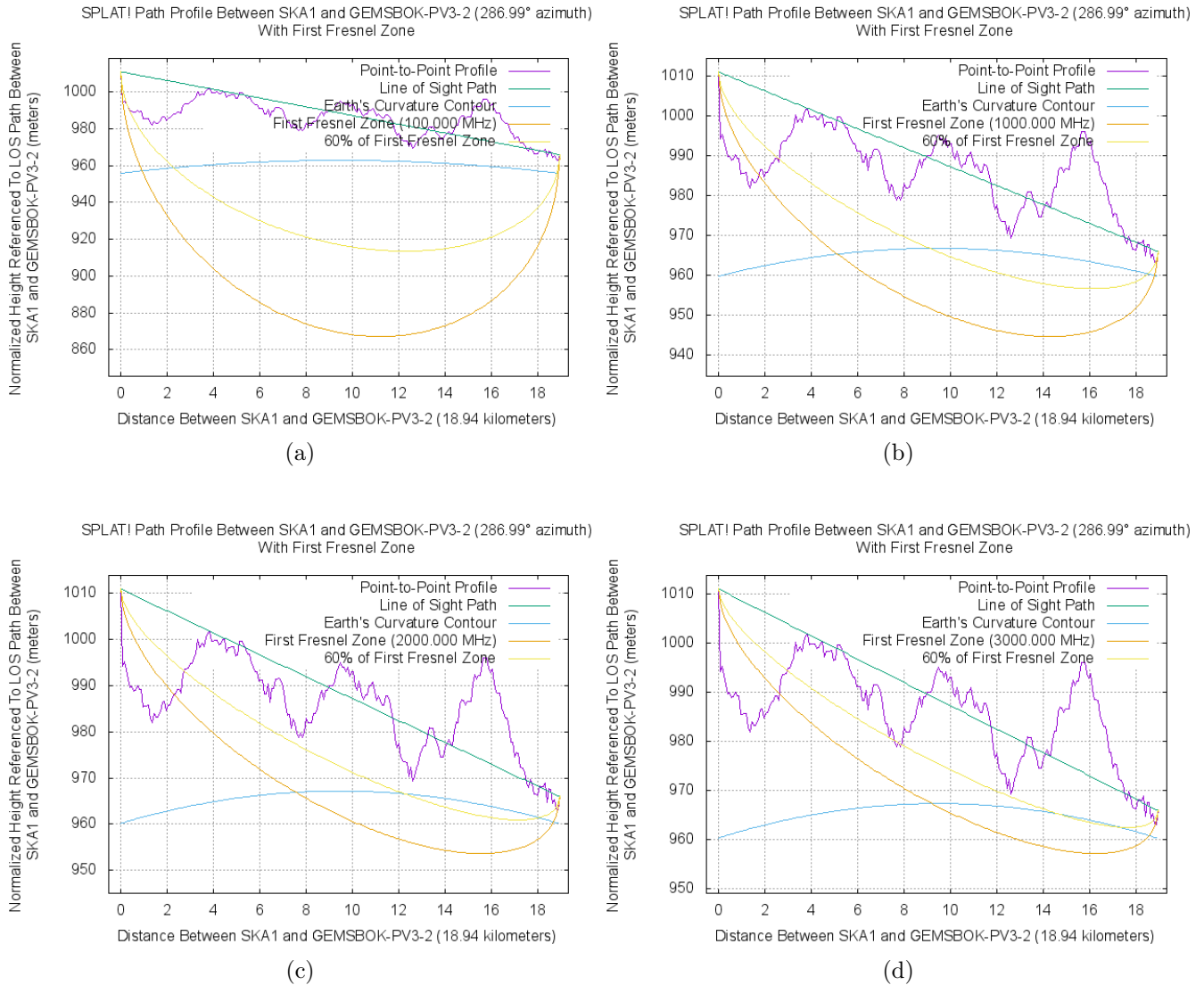

Figure 64: Fresnel zone, LOS and 60% of first Fresnel zone for site location of Gemsbok PV3 to the closest SKA telescope for (a) 100 MHz (b) 1000 MHz (c) 2000 MHz and (d) 3000 MHz.

A.29 Gemsbok PV3 to 2nd Closest SKA

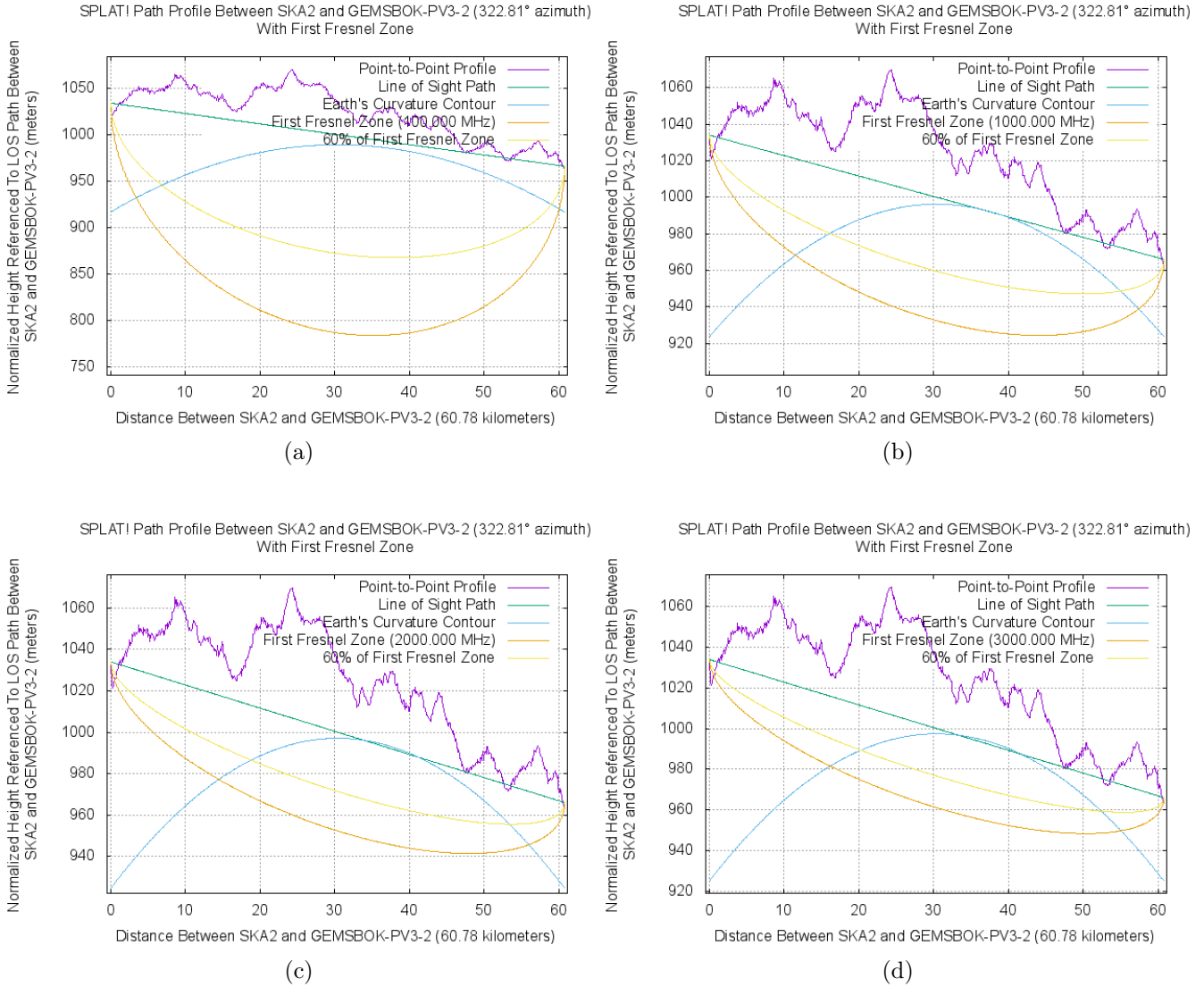

Figure 65: Fresnel zone, LOS and 60% of first Fresnel zone for site location of Gemsbok PV3 to the second closest SKA telescope for (a) 100 MHz (b) 1000 MHz (c) 2000 MHz and (d) 3000 MHz.

A.30 Gemsbok PV3 to Core SKA

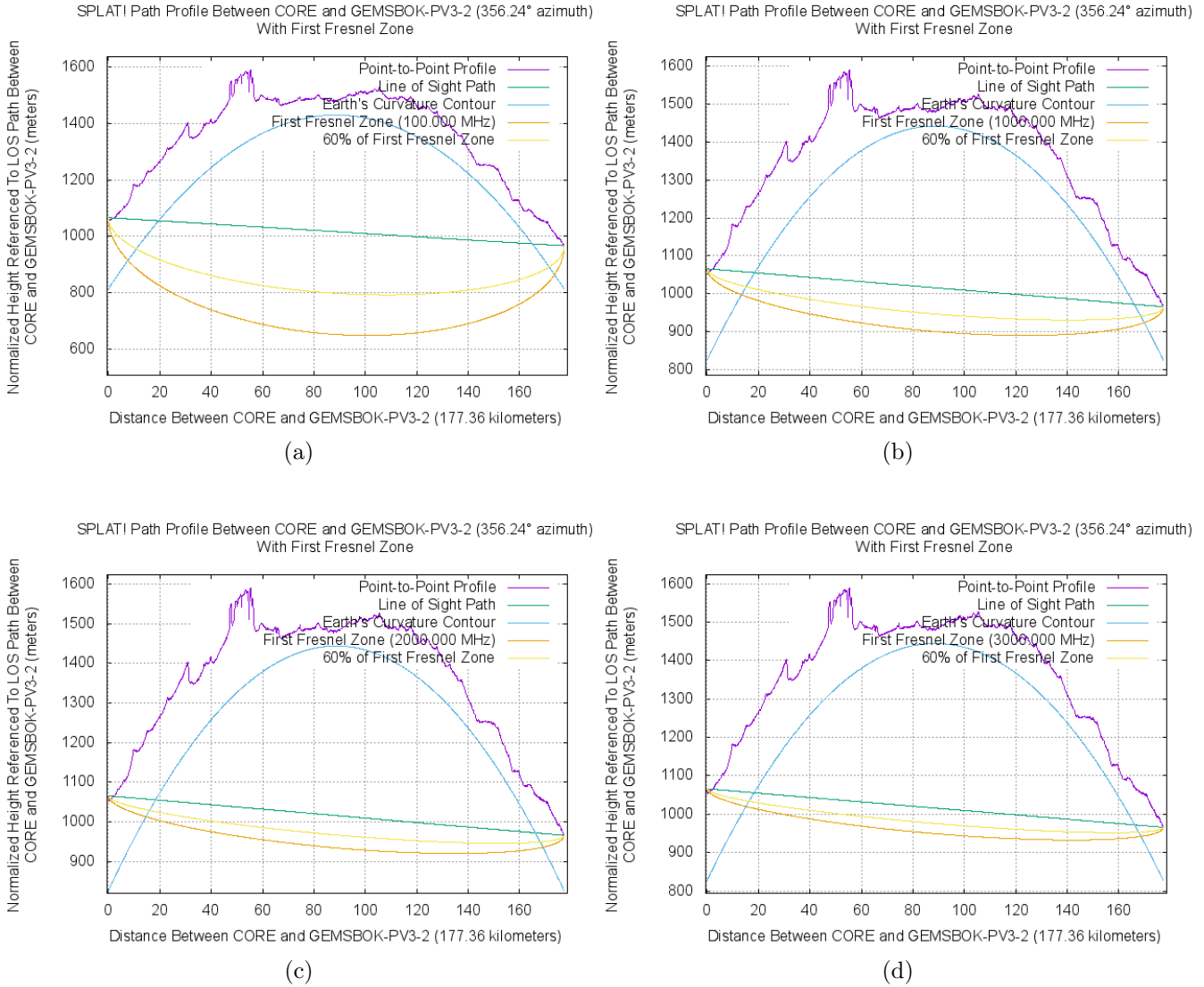

Figure 66: Fresnel zone, LOS and 60% of first Fresnel zone for site location of Gemsbok PV3 to the core SKA telescopes for (a) 100 MHz (b) 1000 MHz (c) 2000 MHz and (d) 3000 MHz.

A.31 Gemsbok PV3 Alternative to Closest SKA

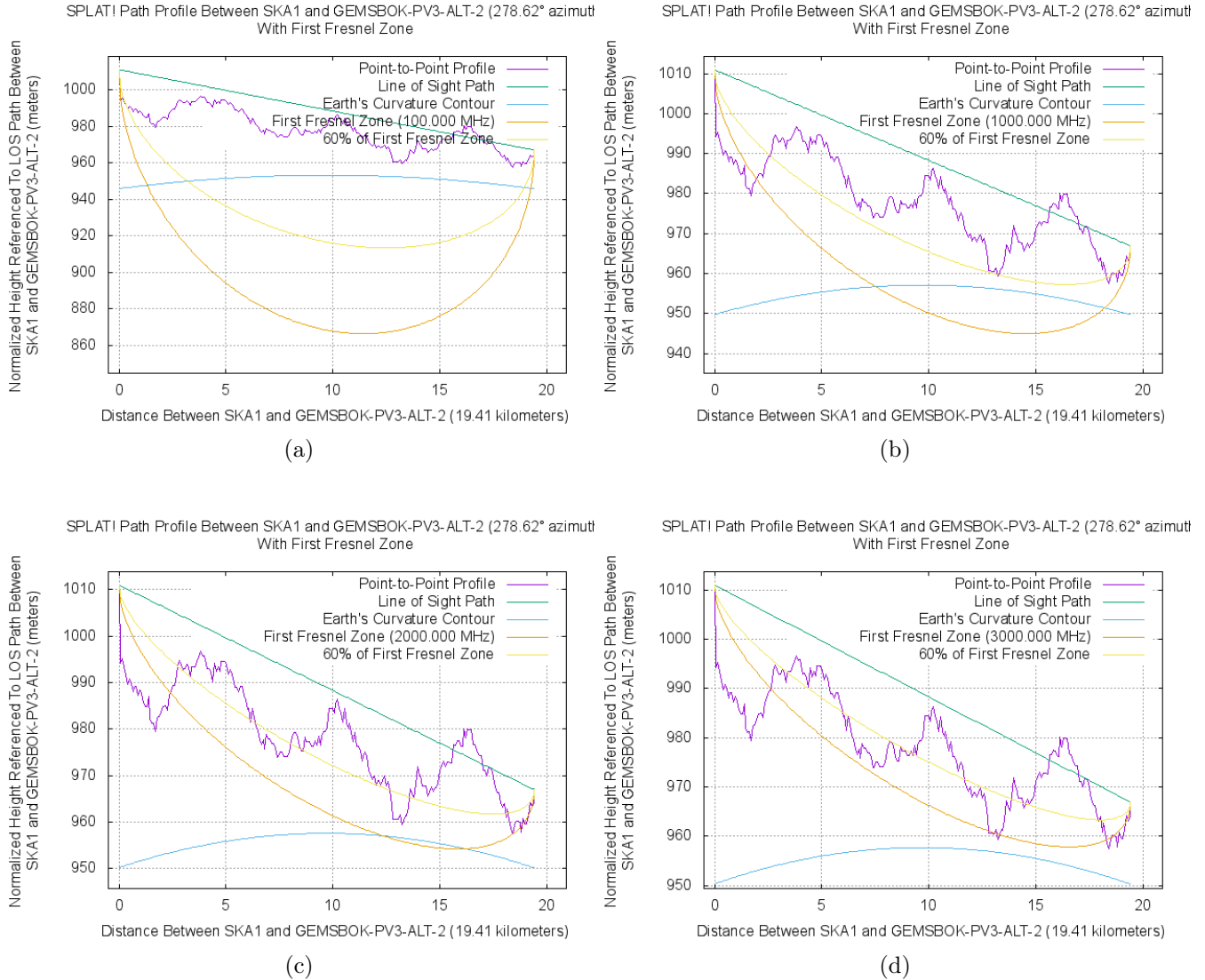

Figure 67: Fresnel zone, LOS and 60% of first Fresnel zone for site location of Gemsbok PV3 Alternative to the closest SKA telescope for (a) 100 MHz (b) 1000 MHz (c) 2000 MHz and (d) 3000 MHz.

A.32 Gemsbok PV3 Alternative to 2nd Closest SKA

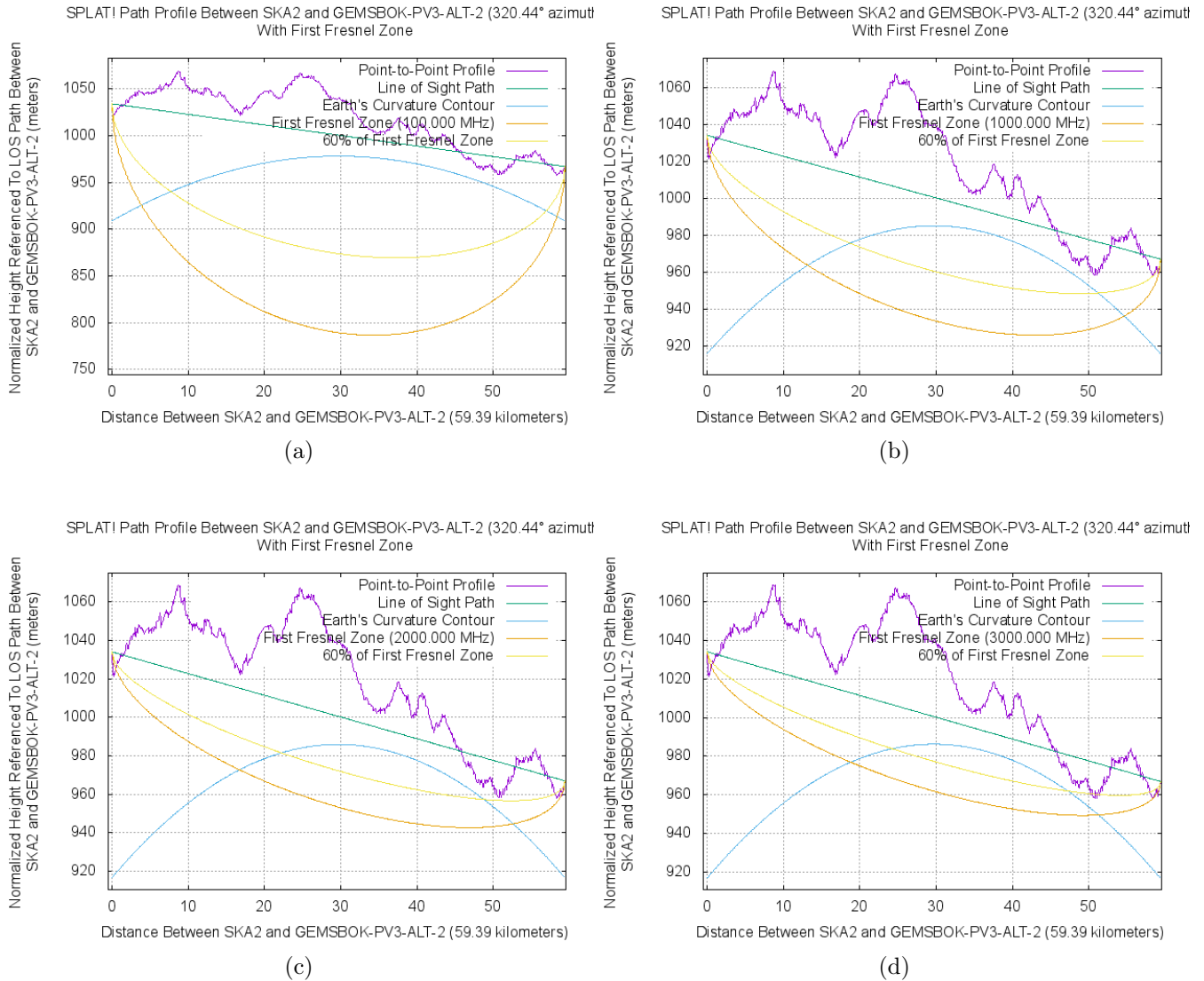

Figure 68: Fresnel zone, LOS and 60% of first Fresnel zone for site location of Gemsbok PV3 Alternative to the second closest SKA telescope for (a) 100 MHz (b) 1000 MHz (c) 2000 MHz and (d) 3000 MHz.

A.33 Gemsbok PV3 Alternative to Core SKA

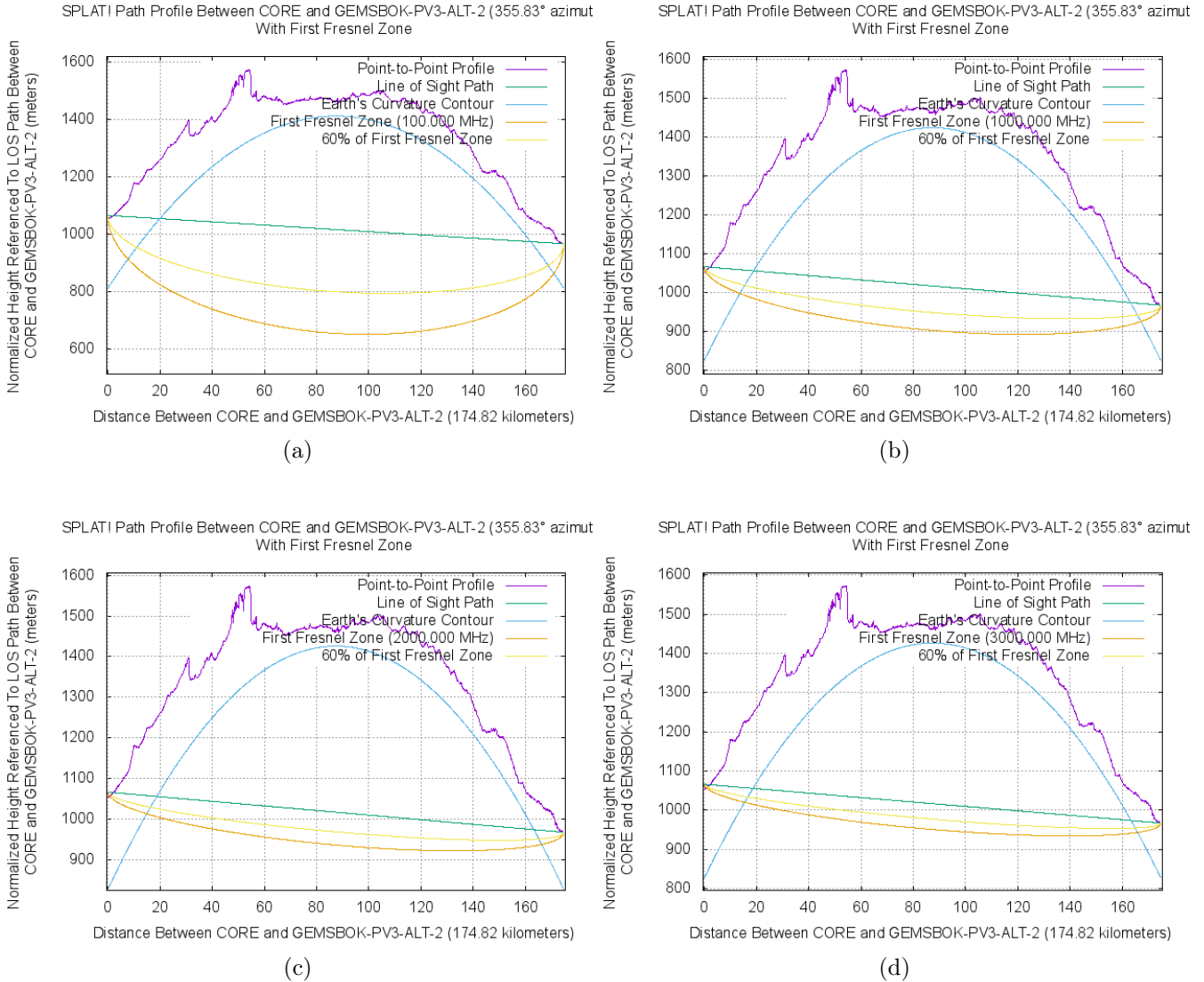

Figure 69: Fresnel zone, LOS and 60% of first Fresnel zone for site location of Gemsbok PV3 Alternative to the core SKA telescopes for (a) 100 MHz (b) 1000 MHz (c) 2000 MHz and (d) 3000 MHz.

A.34 Gemsbok PV4 to Closest SKA

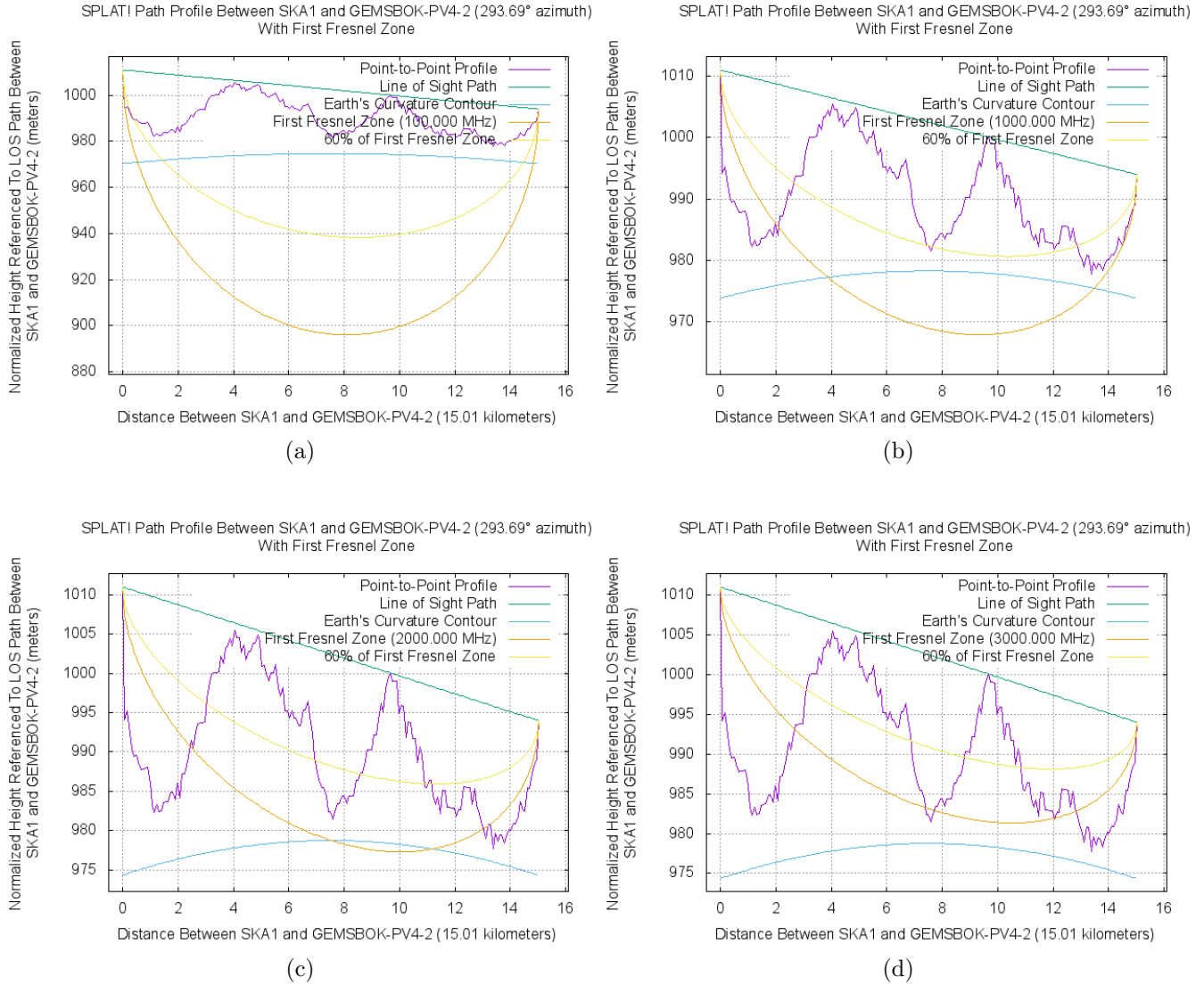

Figure 70: Fresnel zone, LOS and 60% of first Fresnel zone for site location of Gemsbok PV4 to the closest SKA telescope for (a) 100 MHz (b) 1000 MHz (c) 2000 MHz and (d) 3000 MHz.

A.35 Gemsbok PV4 to 2nd Closest SKA

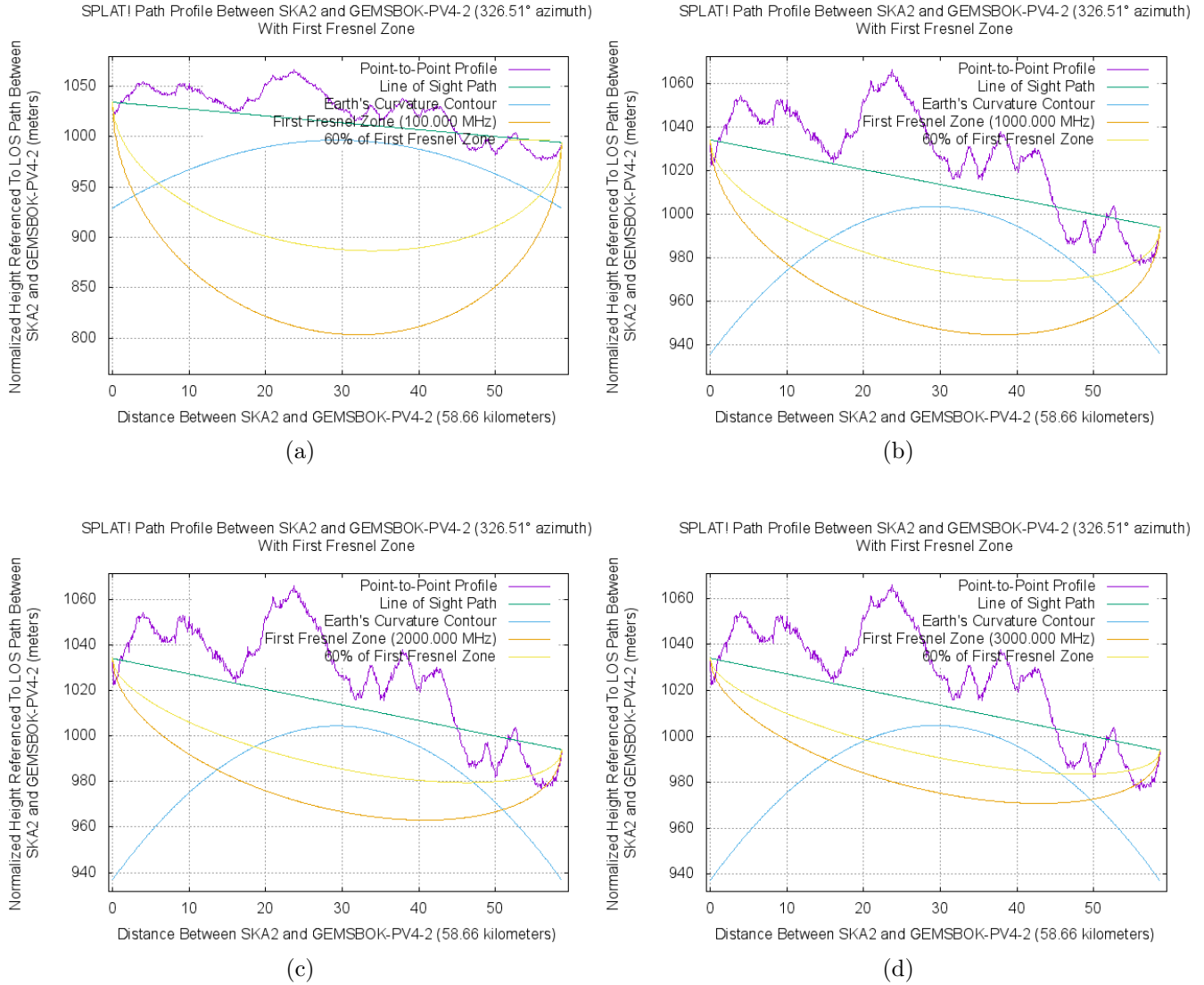

Figure 71: Fresnel zone, LOS and 60% of first Fresnel zone for site location of Gemsbok PV4 to the second closest SKA telescope for (a) 100 MHz (b) 1000 MHz (c) 2000 MHz and (d) 3000 MHz.

A.36 Gemsbok PV4 to Core SKA

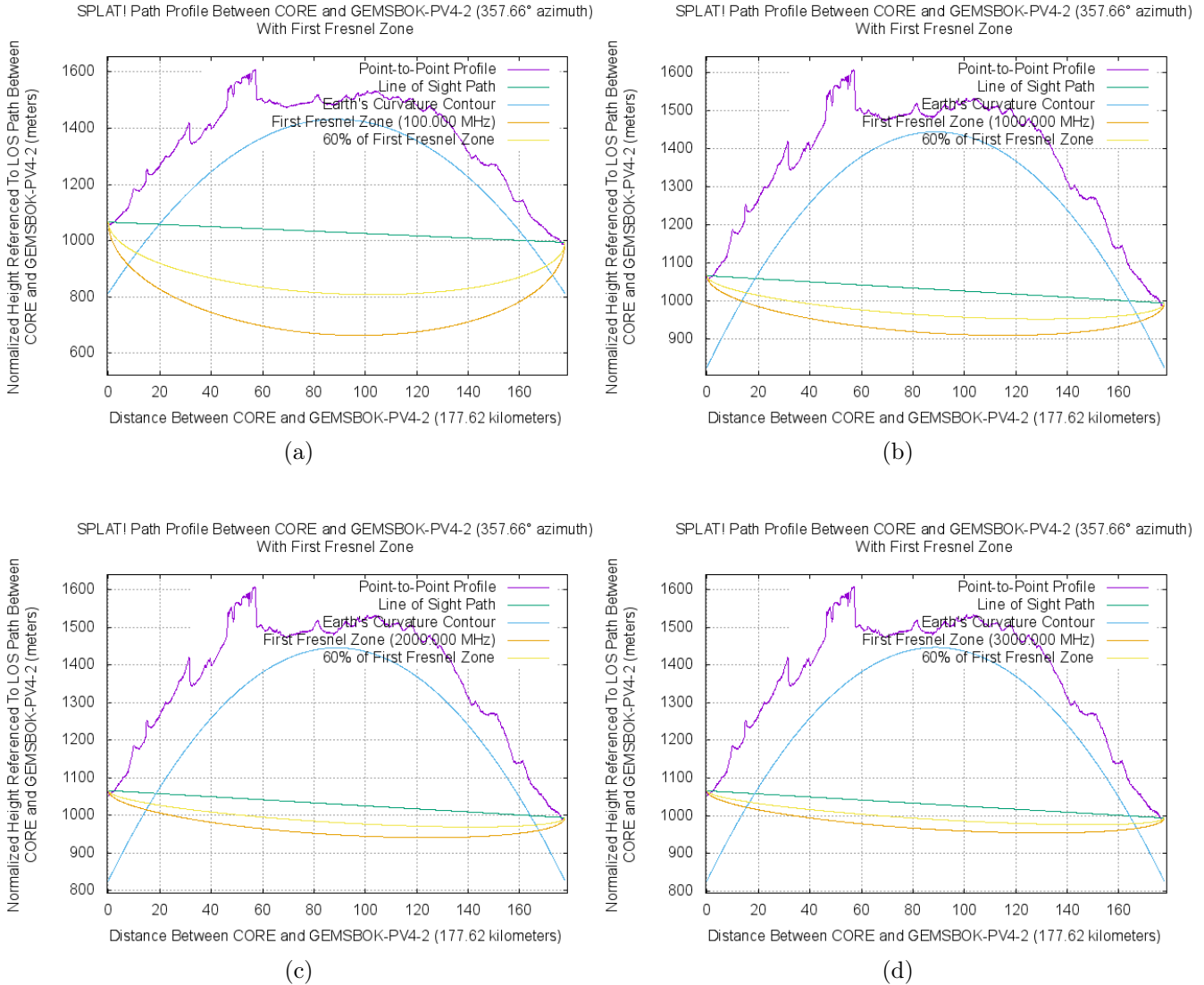

Figure 72: Fresnel zone, LOS and 60% of first Fresnel zone for site location of Gemsbok PV4 to the core SKA telescopes for (a) 100 MHz (b) 1000 MHz (c) 2000 MHz and (d) 3000 MHz.

A.37 Gemsbok PV4 Alternative to Closest SKA

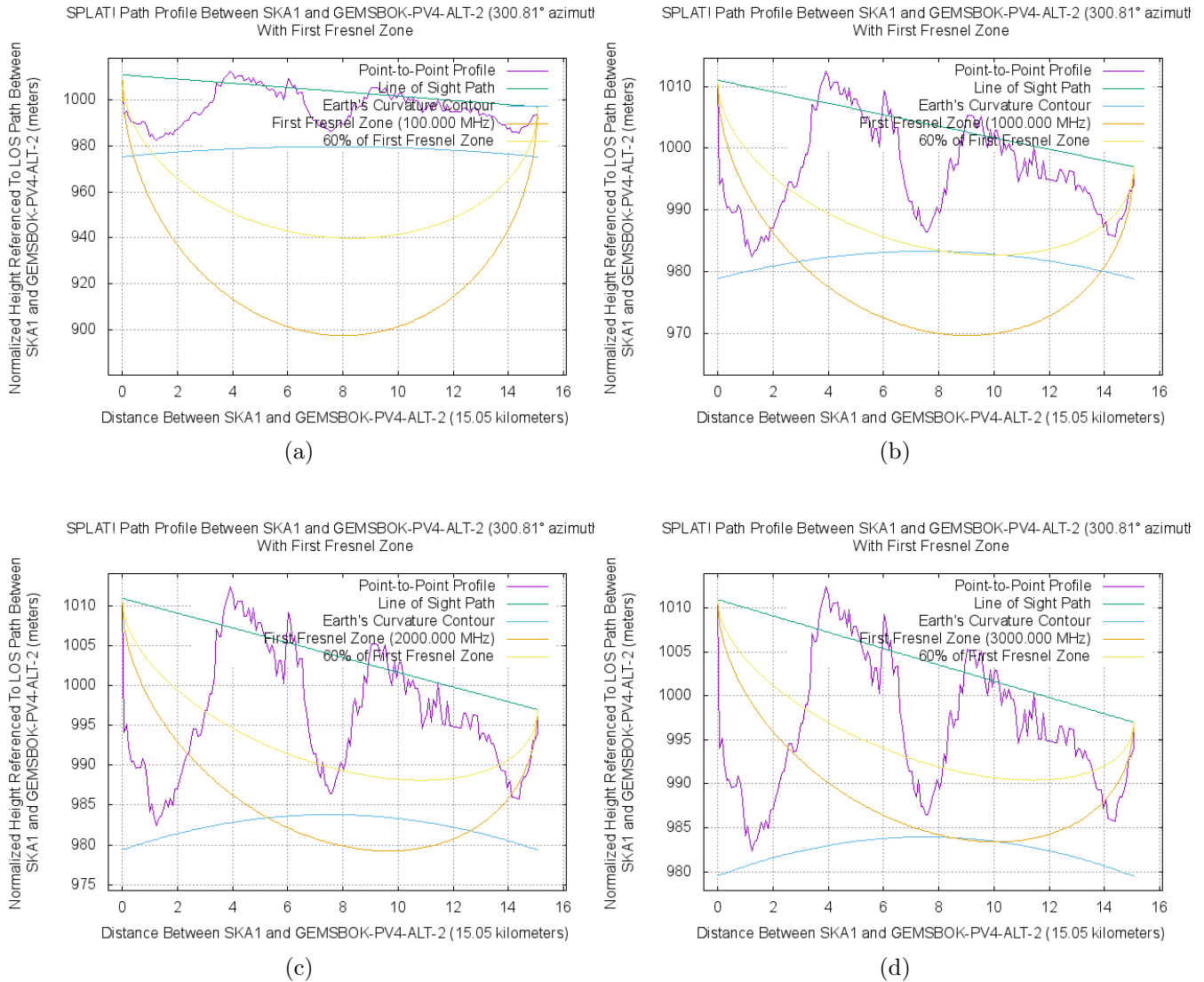

Figure 73: Fresnel zone, LOS and 60% of first Fresnel zone for site location of Gemsbok PV4 Alternative to the closest SKA telescope for (a) 100 MHz (b) 1000 MHz (c) 2000 MHz and (d) 3000 MHz.

A.38 Gemsbok PV4 Alternative to 2nd Closest SKA

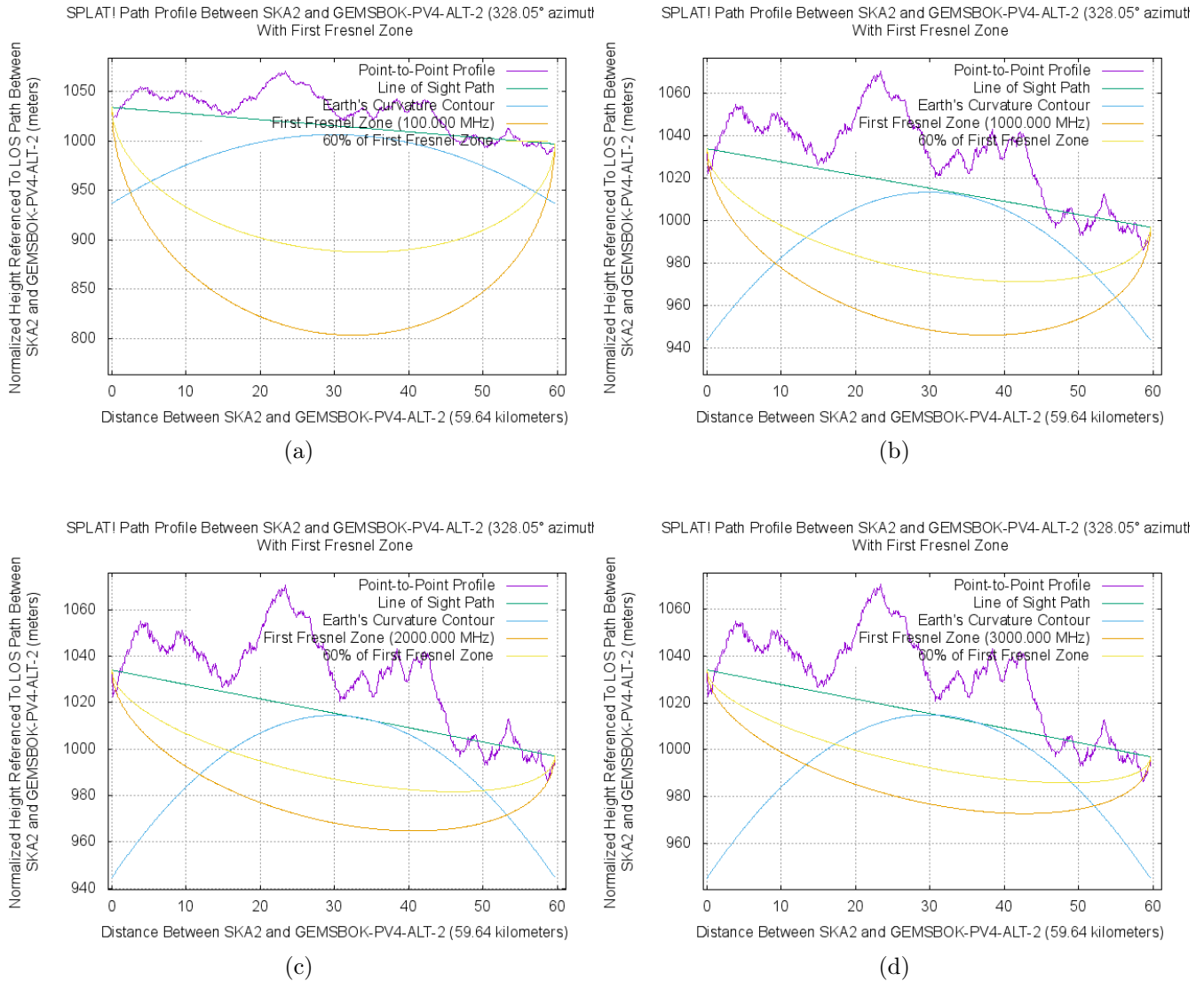

Figure 74: Fresnel zone, LOS and 60% of first Fresnel zone for site location of Gemsbok PV4 Alternative to the second closest SKA telescope for (a) 100 MHz (b) 1000 MHz (c) 2000 MHz and (d) 3000 MHz.

A.39 Gemsbok PV4 Alternative to Core SKA

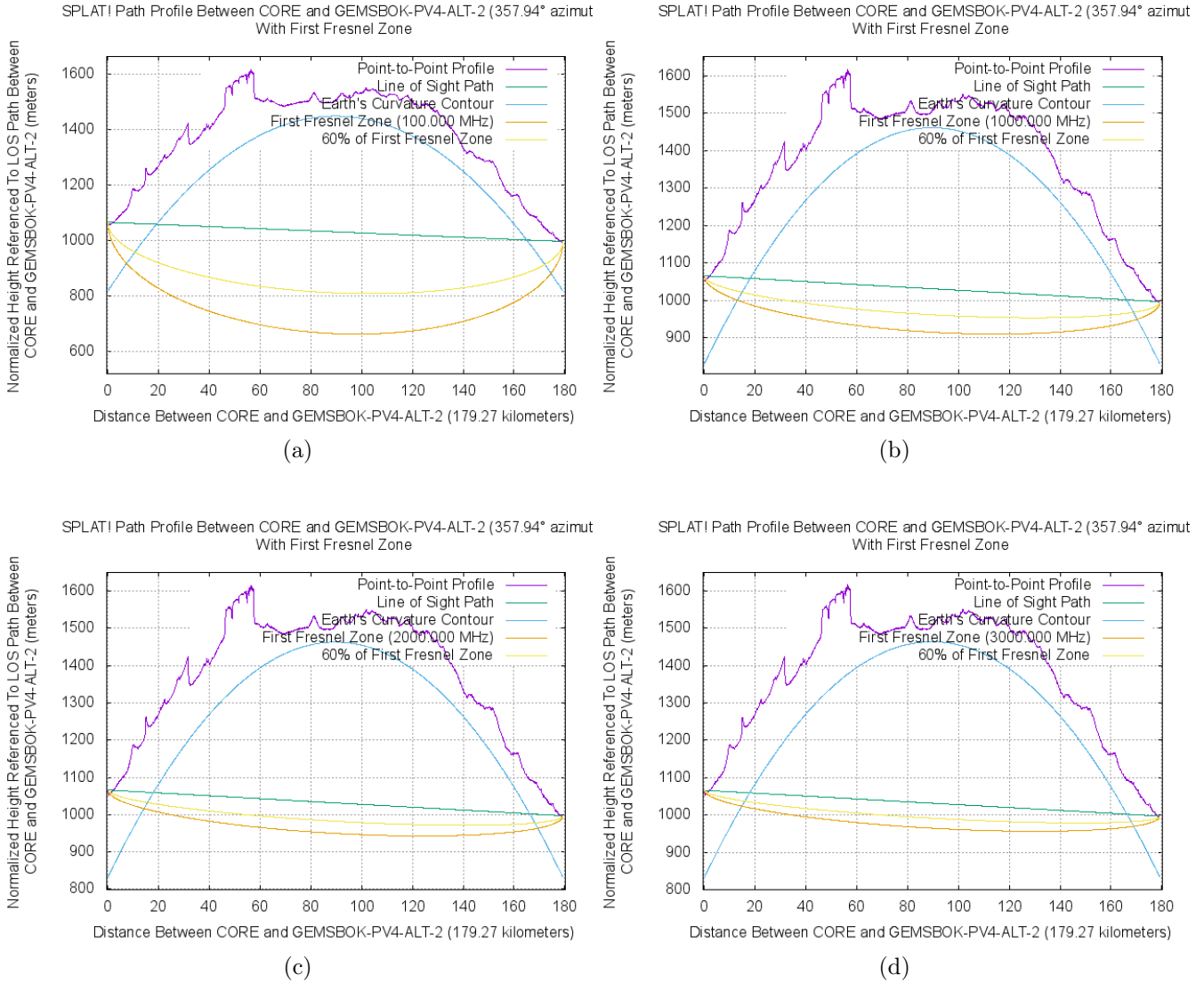

Figure 75: Fresnel zone, LOS and 60% of first Fresnel zone for site location of Gemsbok PV4 Alternative to the core SKA telescopes for (a) 100 MHz (b) 1000 MHz (c) 2000 MHz and (d) 3000 MHz.

A.40 Gemsbok PV5 to Closest SKA

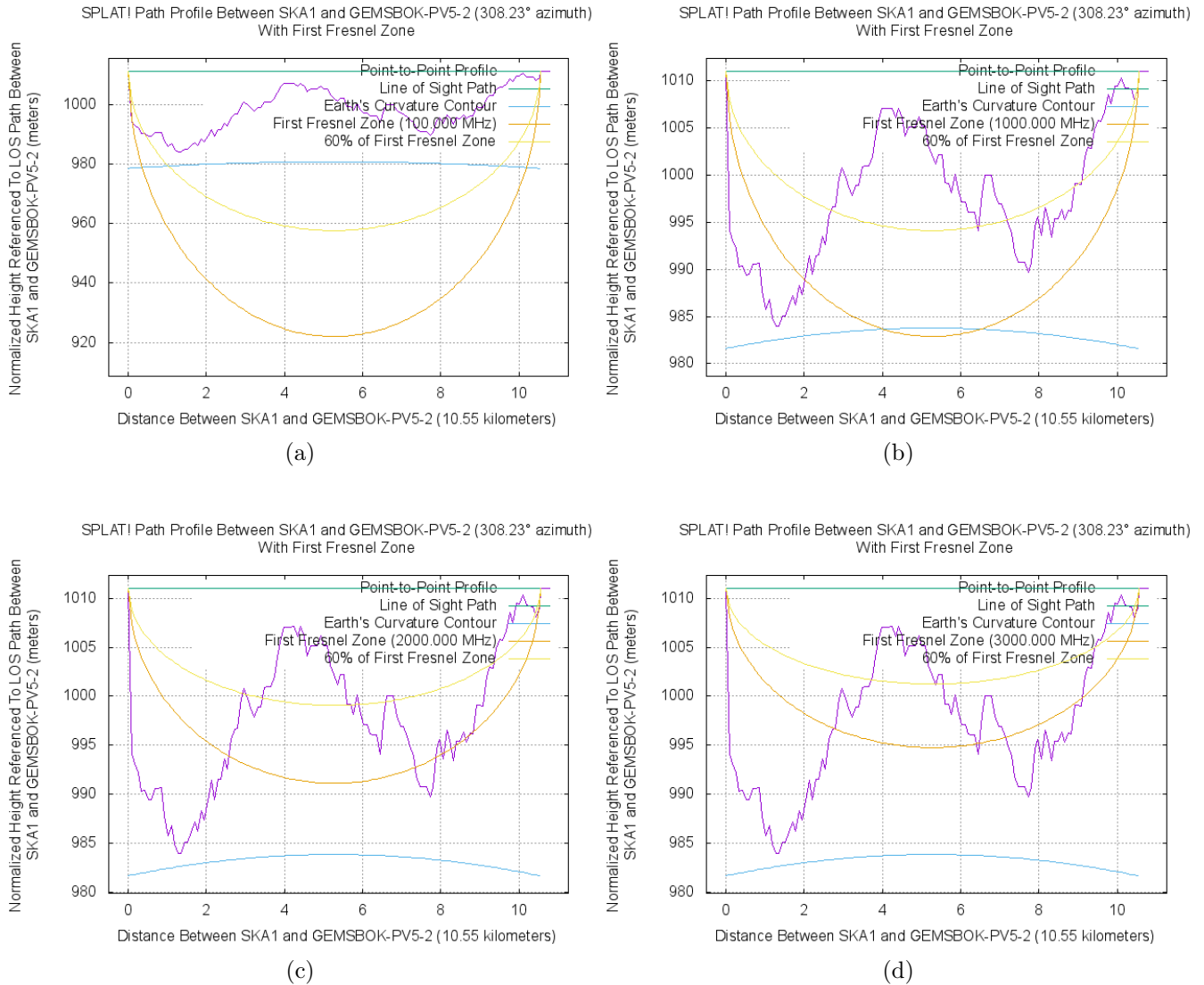

Figure 76: Fresnel zone, LOS and 60% of first Fresnel zone for site location of Gemsbok PV5 to the closest SKA telescope for (a) 100 MHz (b) 1000 MHz (c) 2000 MHz and (d) 3000 MHz.

A.41 Gemsbok PV5 to 2nd Closest SKA

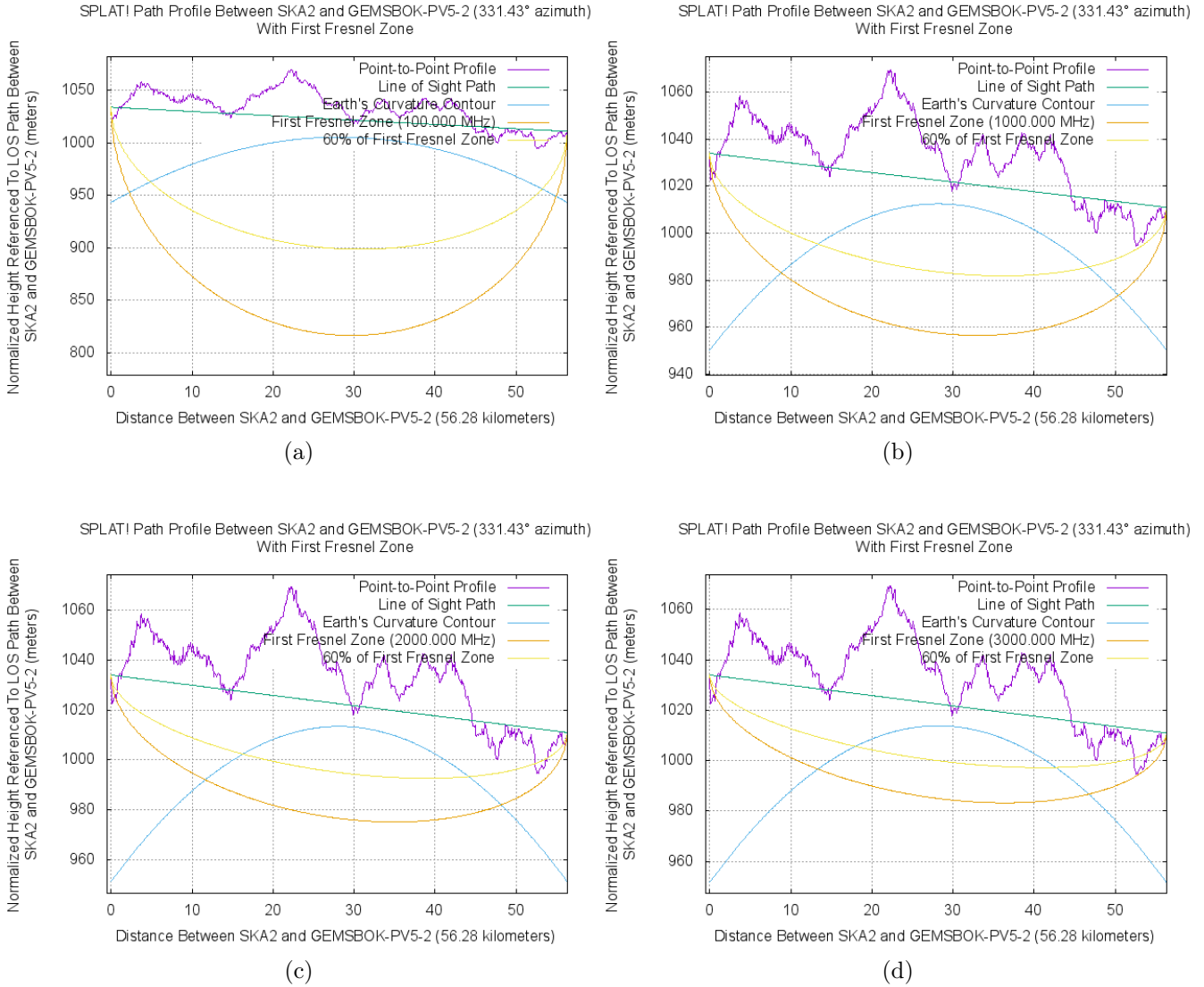

Figure 77: Fresnel zone, LOS and 60% of first Fresnel zone for site location of Gemsbok PV5 to the second closest SKA telescope for (a) 100 MHz (b) 1000 MHz (c) 2000 MHz and (d) 3000 MHz.

A.42 Gemsbok PV5 to Core SKA

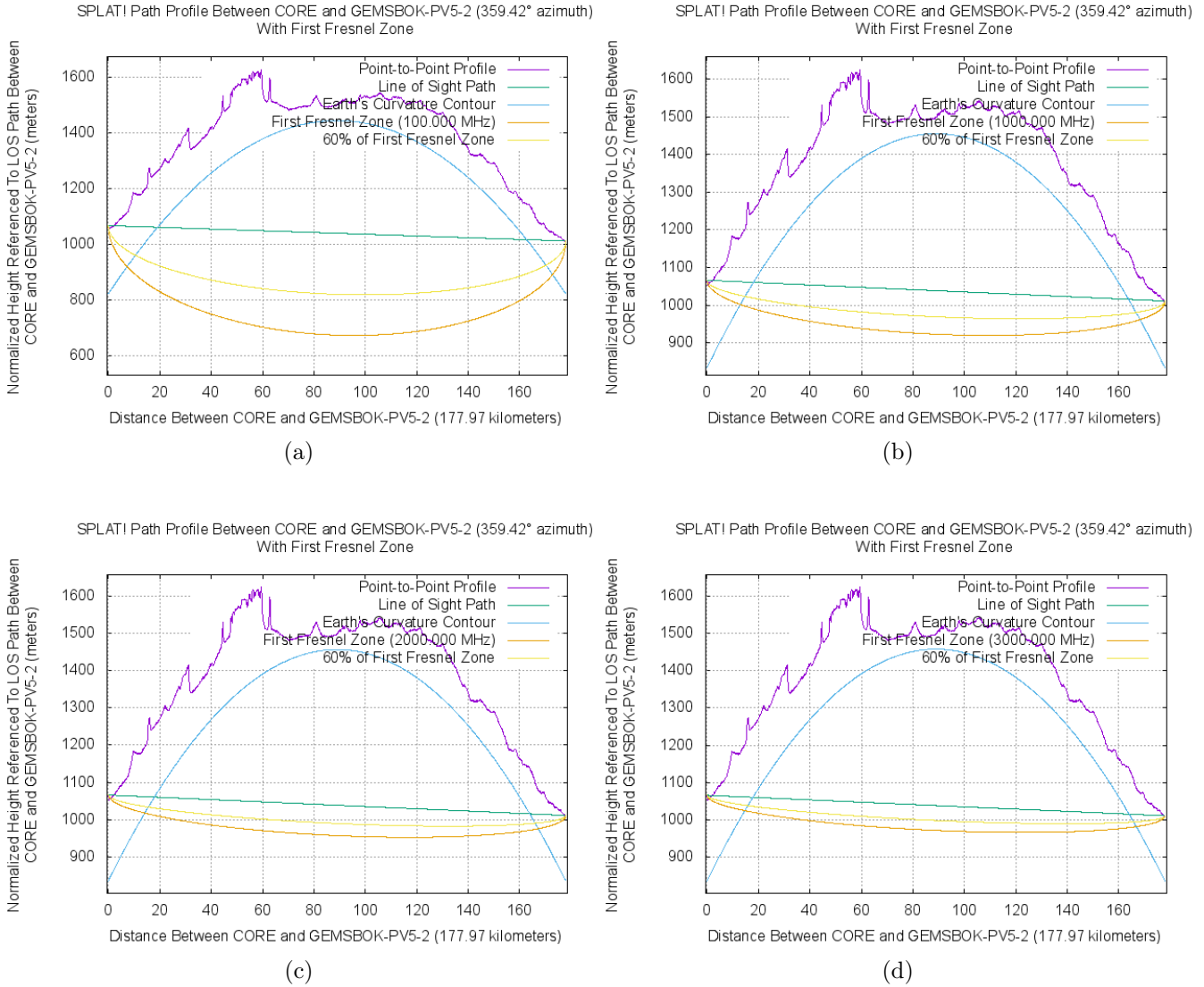

Figure 78: Fresnel zone, LOS and 60% of first Fresnel zone for site location of Gemsbok PV5 to the core SKA telescopes for (a) 100 MHz (b) 1000 MHz (c) 2000 MHz and (d) 3000 MHz.

A.43 Gemsbok PV5 Alternative to Closest SKA

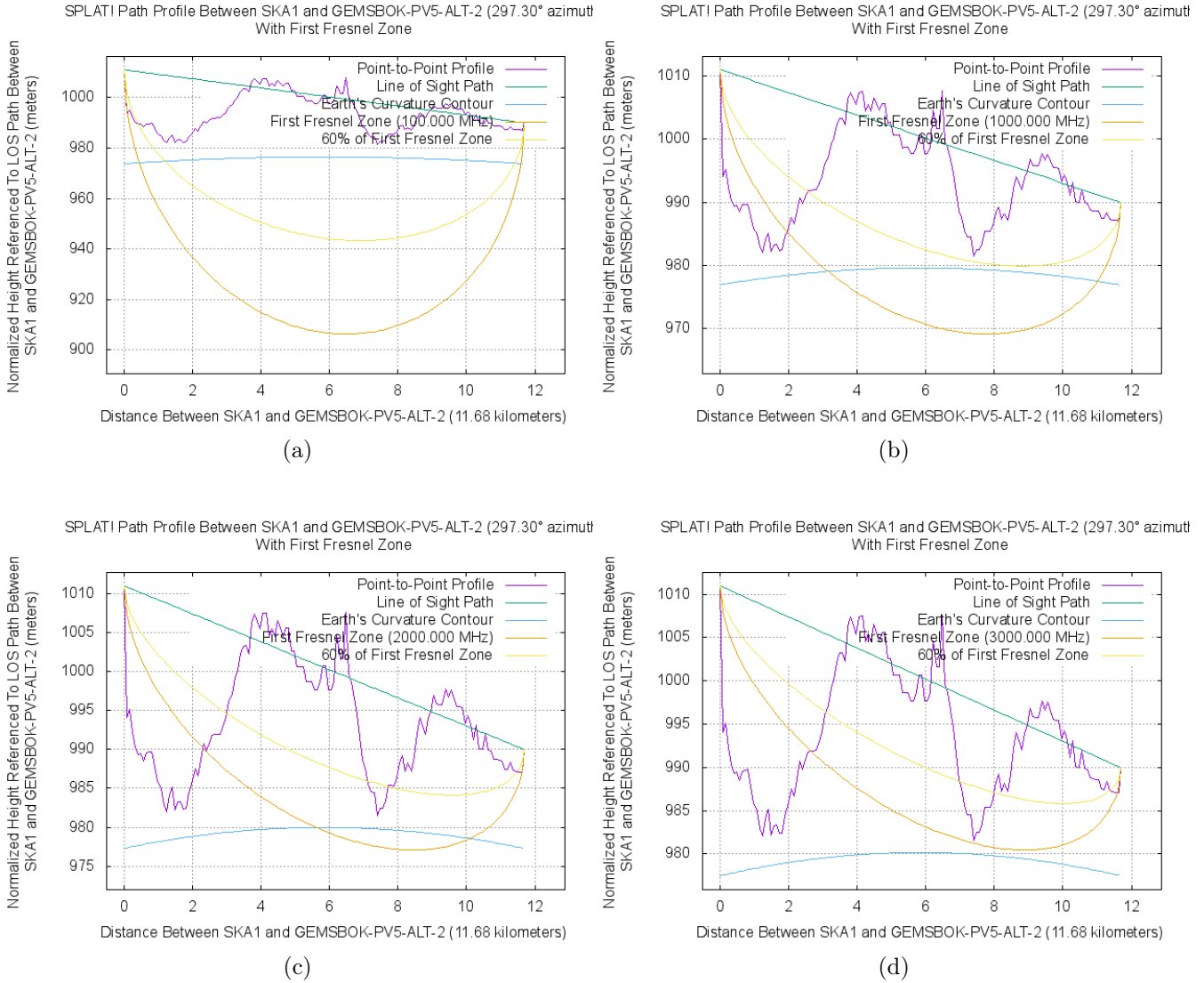

Figure 79: Fresnel zone, LOS and 60% of first Fresnel zone for site location of Gemsbok PV5 Alternative to the closest SKA telescope for (a) 100 MHz (b) 1000 MHz (c) 2000 MHz and (d) 3000 MHz.

A.44 Gemsbok PV5 Alternative to 2nd Closest SKA

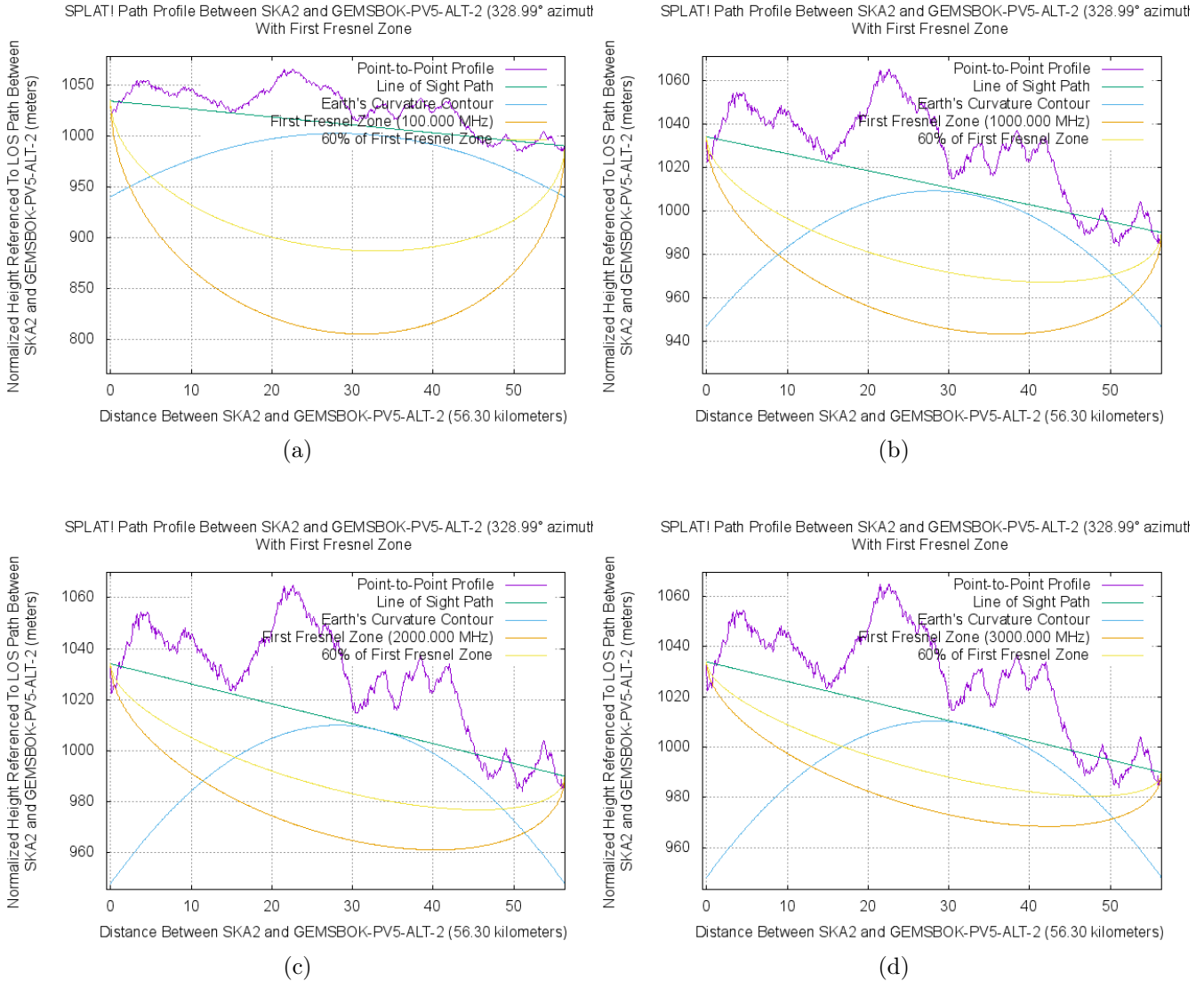

Figure 80: Fresnel zone, LOS and 60% of first Fresnel zone for site location of Gemsbok PV5 Alternative to the second closest SKA telescope for (a) 100 MHz (b) 1000 MHz (c) 2000 MHz and (d) 3000 MHz.

A.45 Gemsbok PV5 Alternative to Core SKA

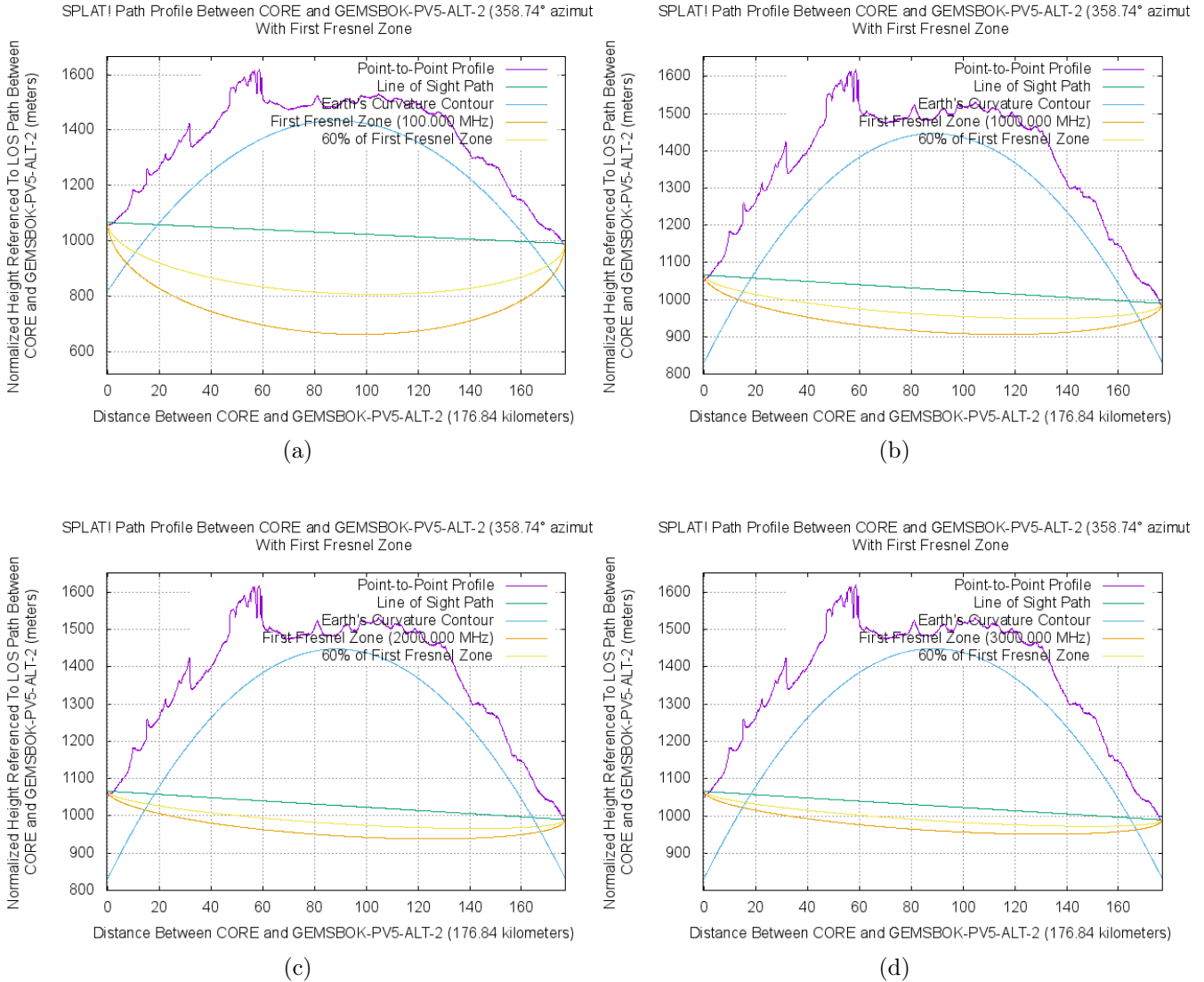

Figure 81: Fresnel zone, LOS and 60% of first Fresnel zone for site location of Gemsbok PV5 Alternative to the core SKA telescopes for (a) 100 MHz (b) 1000 MHz (c) 2000 MHz and (d) 3000 MHz.

A.46 Gemsbok PV6 to Closest SKA

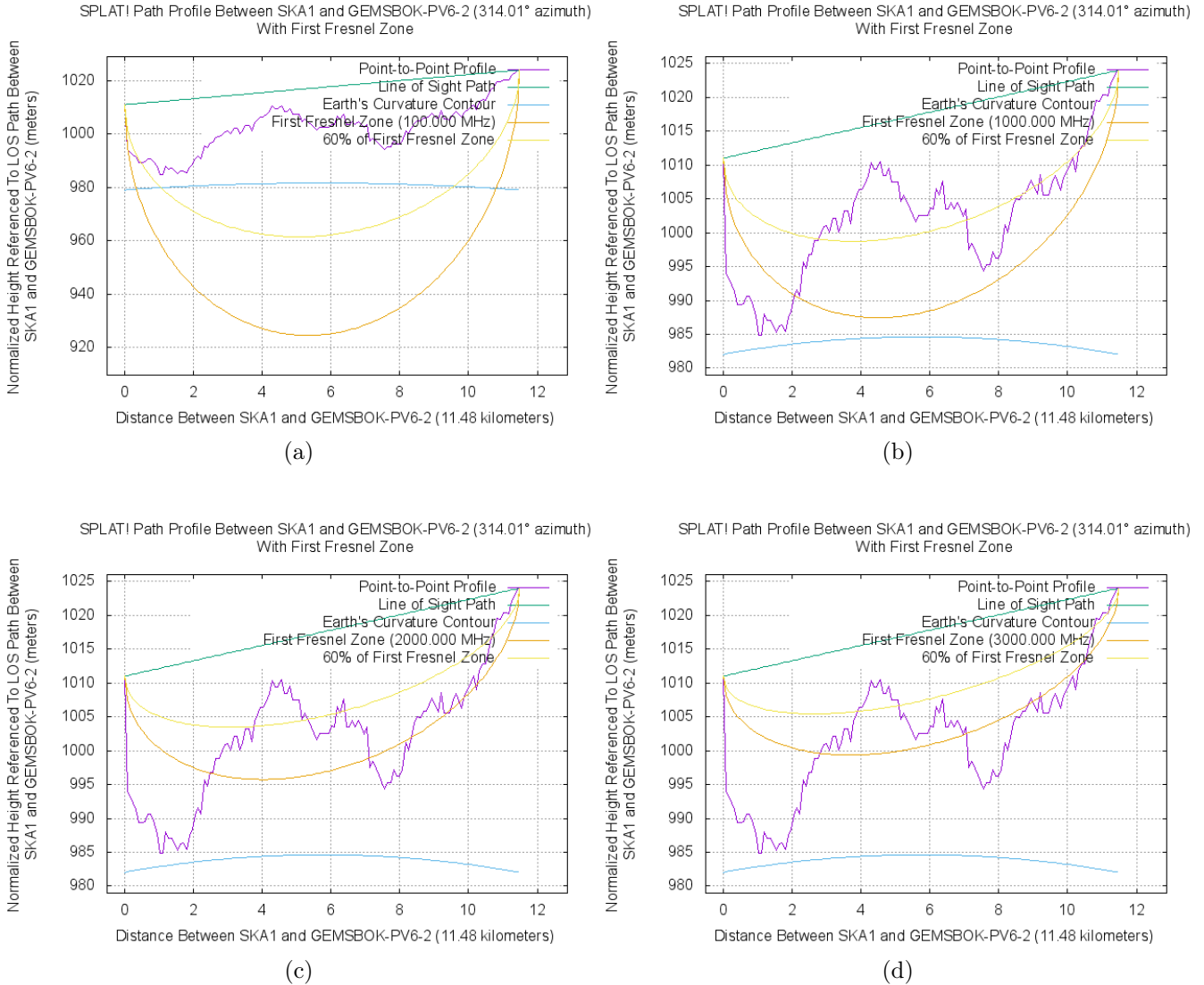

Figure 82: Fresnel zone, LOS and 60% of first Fresnel zone for site location of Gemsbok PV6 to the closest SKA telescope for (a) 100 MHz (b) 1000 MHz (c) 2000 MHz and (d) 3000 MHz.

A.47 Gemsbok PV6 to 2nd Closest SKA

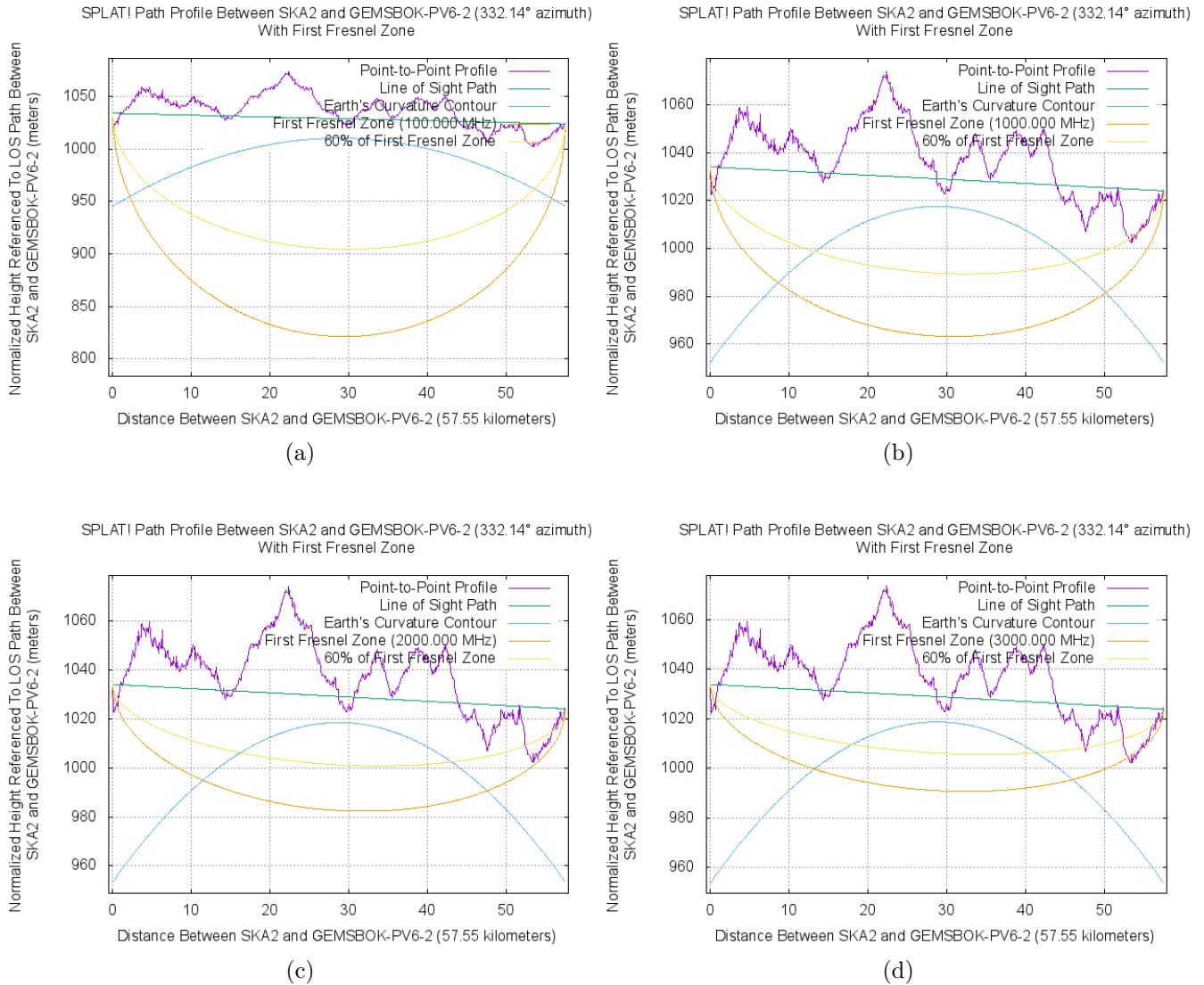

Figure 83: Fresnel zone, LOS and 60% of first Fresnel zone for site location of Gemsbok PV6 to the second closest SKA telescope for (a) 100 MHz (b) 1000 MHz (c) 2000 MHz and (d) 3000 MHz.

A.48 Gemsbok PV6 to Core SKA

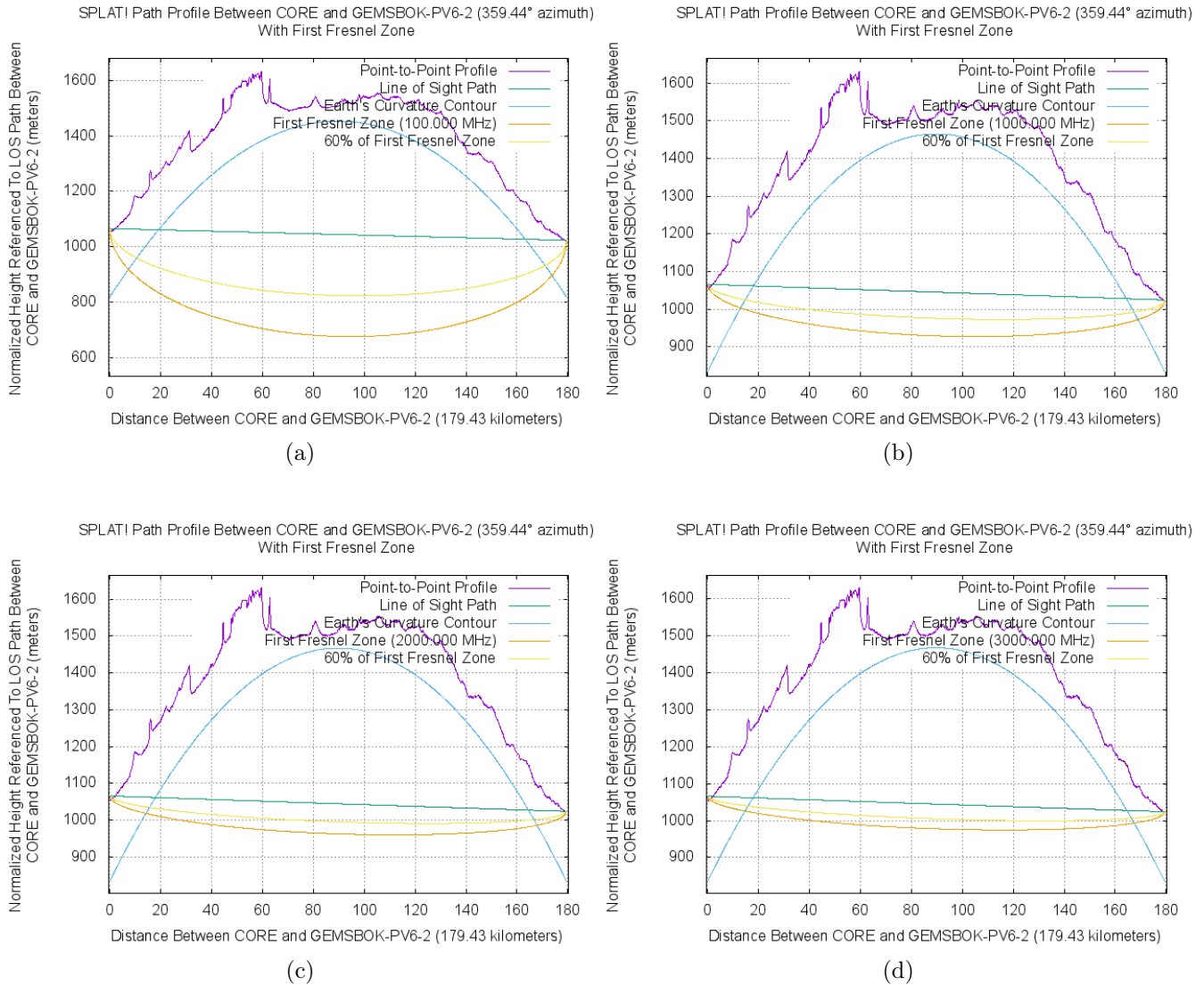

Figure 84: Fresnel zone, LOS and 60% of first Fresnel zone for site location of Gemsbok PV6 to the core SKA telescopes for (a) 100 MHz (b) 1000 MHz (c) 2000 MHz and (d) 3000 MHz.

A.49 Gemsbok PV6 Alternative to Closest SKA

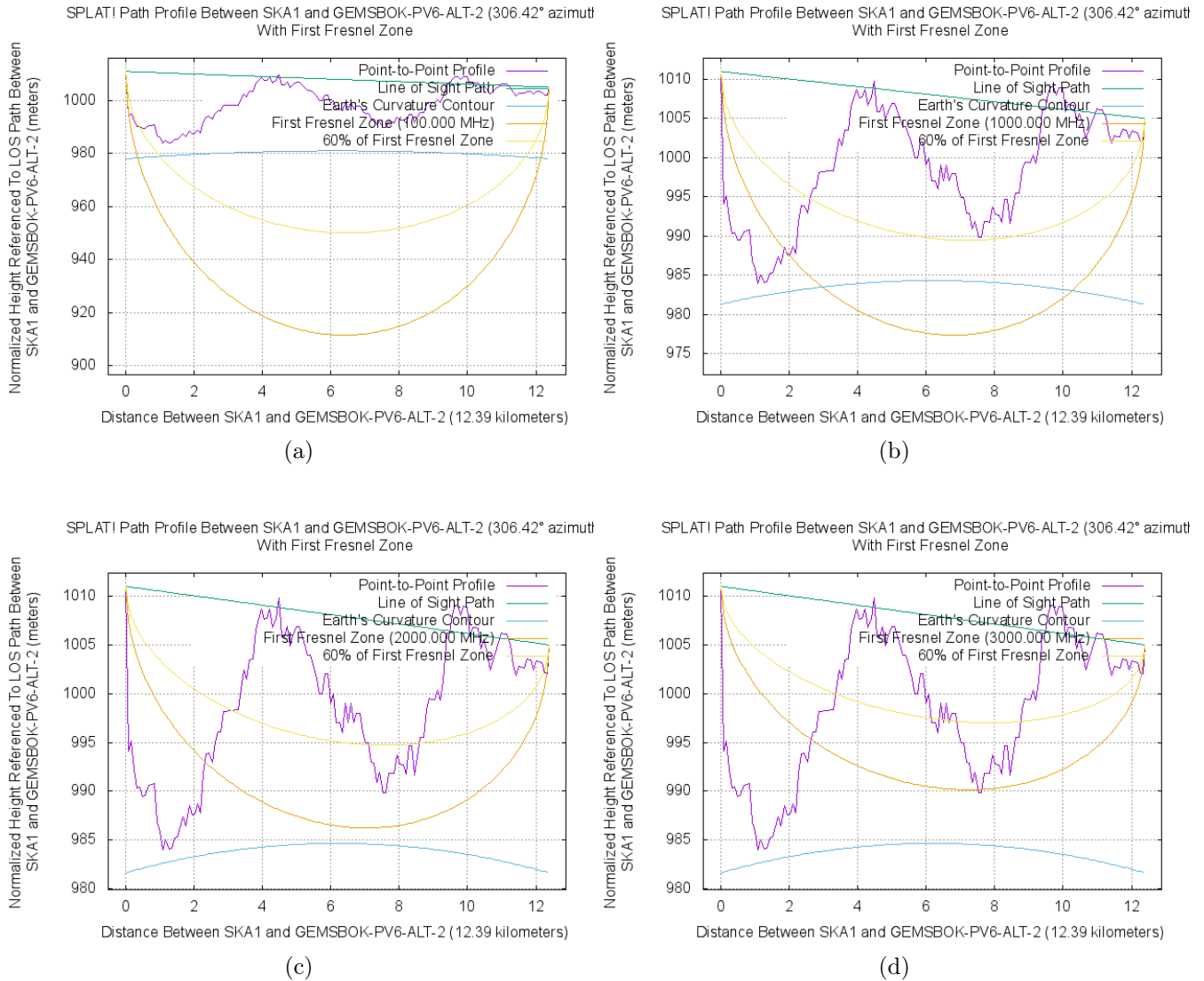

Figure 85: Fresnel zone, LOS and 60% of first Fresnel zone for site location of Gemsbok PV6 Alternative to the closest SKA telescope for (a) 100 MHz (b) 1000 MHz (c) 2000 MHz and (d) 3000 MHz.

A.50 Gemsbok PV6 Alternative to 2nd Closest SKA

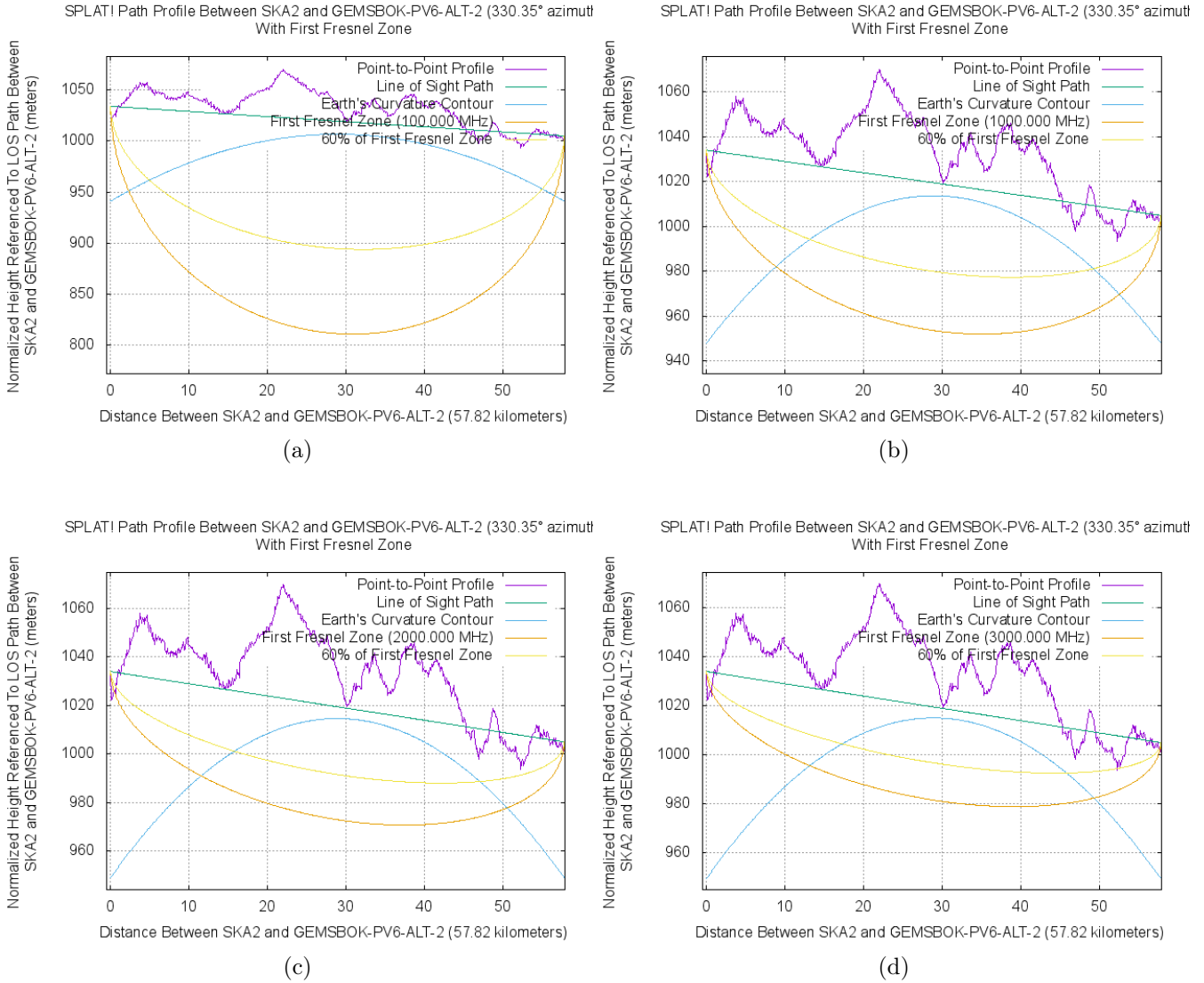

Figure 86: Fresnel zone, LOS and 60% of first Fresnel zone for site location of Gemsbok PV6 Alternative to the second closest SKA telescope for (a) 100 MHz (b) 1000 MHz (c) 2000 MHz and (d) 3000 MHz.

A.51 Gemsbok PV6 Alternative to Core SKA

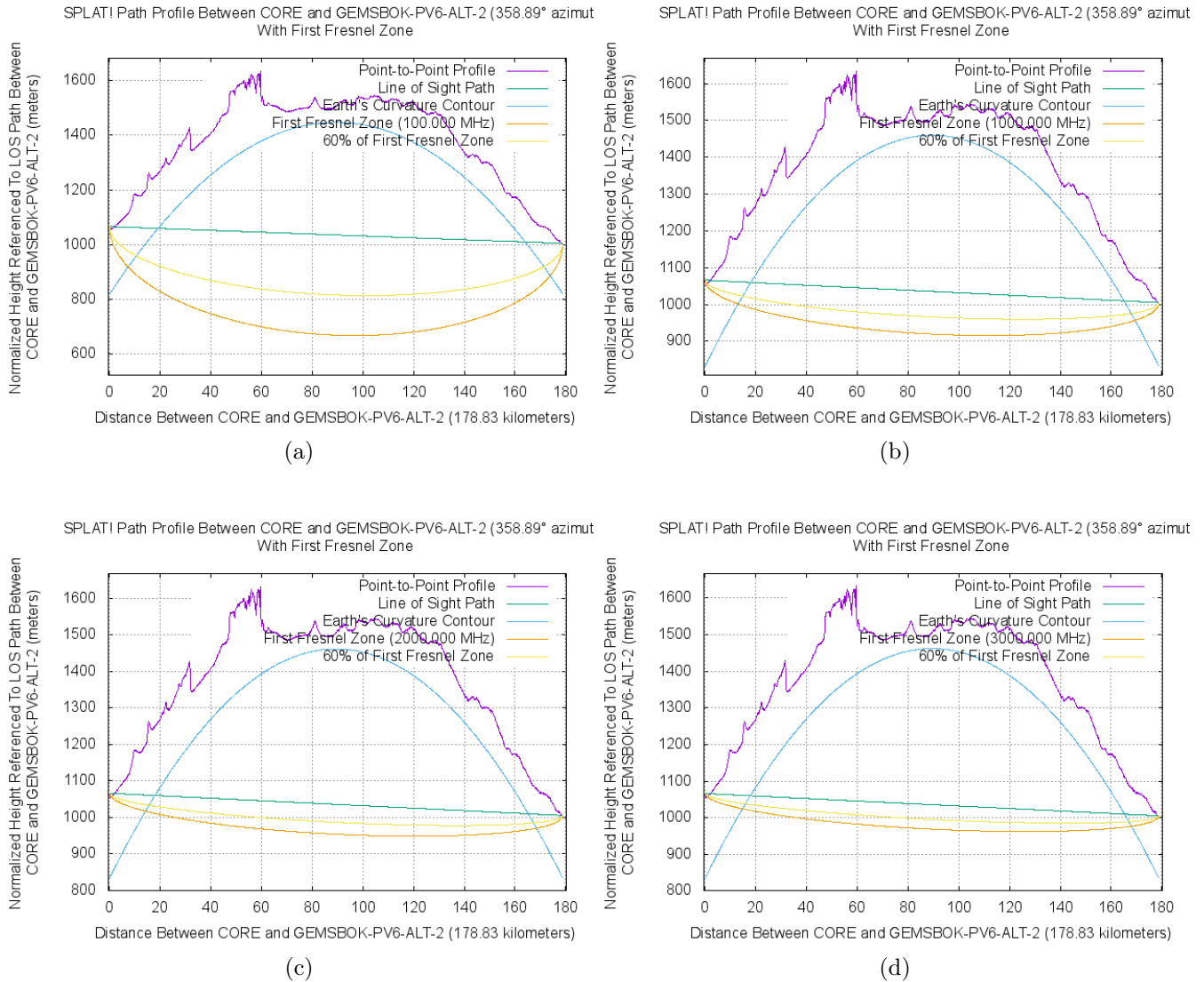

Figure 87: Fresnel zone, LOS and 60% of first Fresnel zone for site location of Gemsbok PV6 Alternative to the core SKA telescopes for (a) 100 MHz (b) 1000 MHz (c) 2000 MHz and (d) 3000 MHz.

A.52 Scatec PV1 to Closest SKA

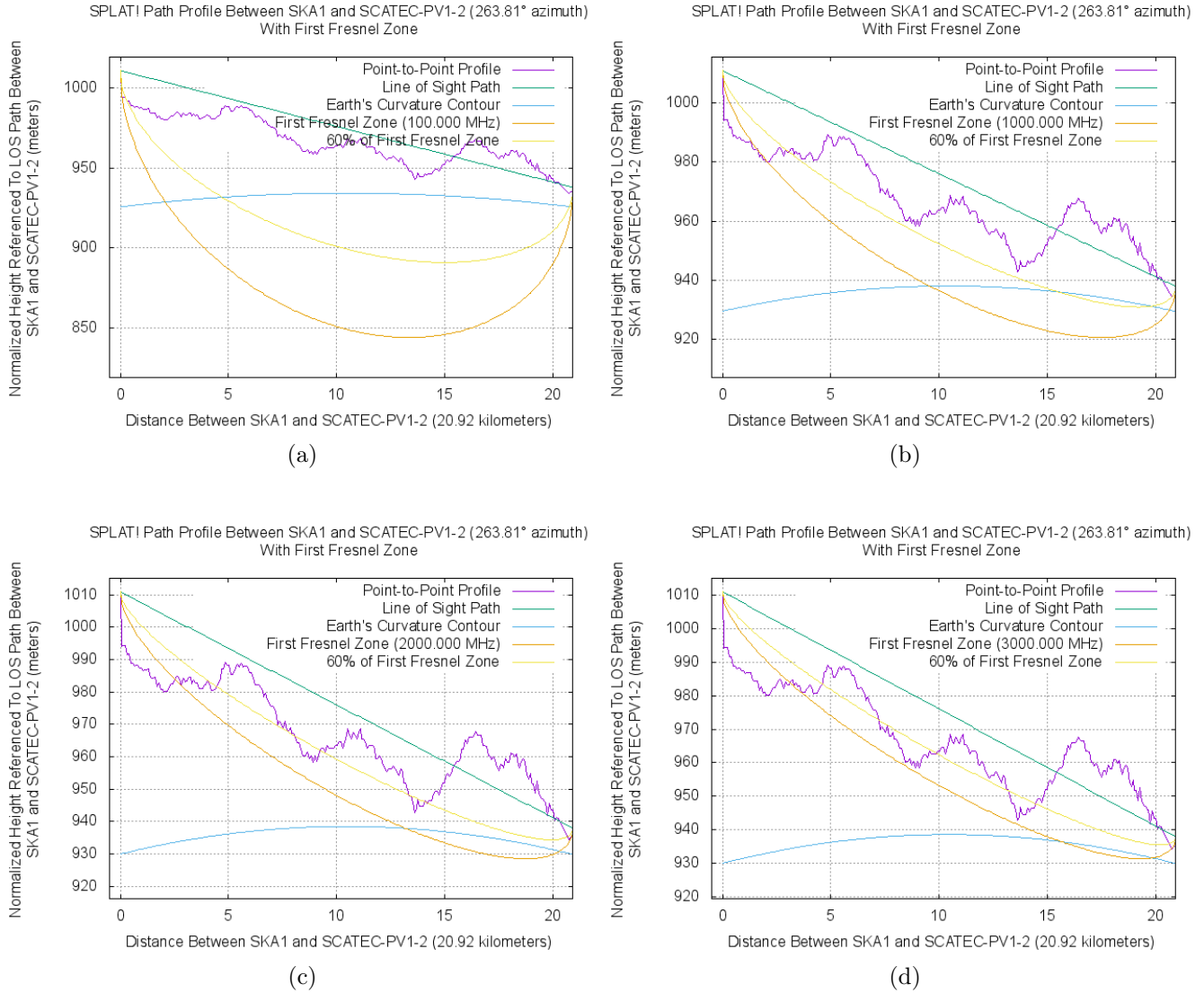

Figure 88: Fresnel zone, LOS and 60% of first Fresnel zone for site location of Scatec PV1 to the closest SKA telescope for (a) 100 MHz (b) 1000 MHz (c) 2000 MHz and (d) 3000 MHz.

A.53 Scatec PV1 to 2nd Closest SKA

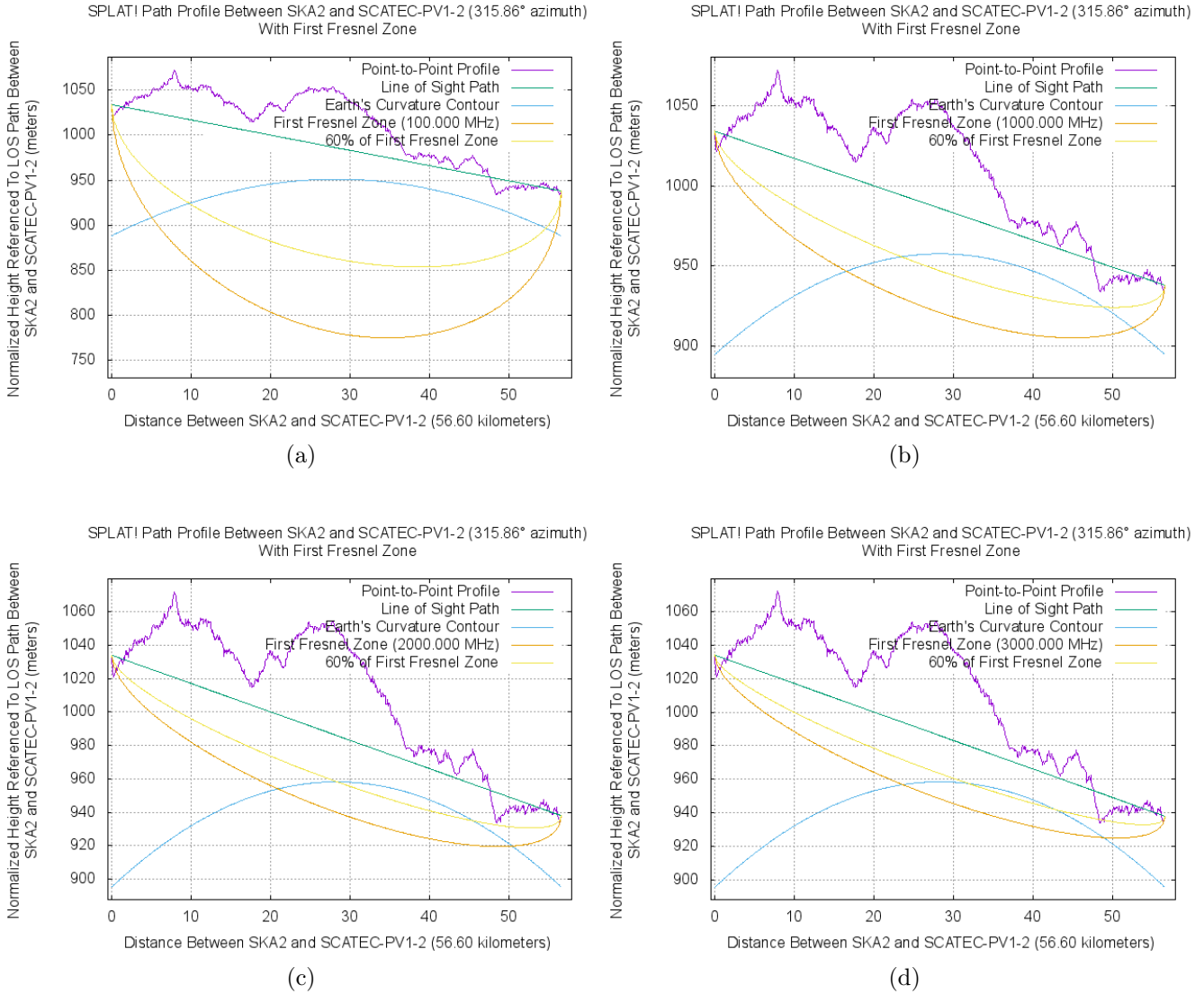

Figure 89: Fresnel zone, LOS and 60% of first Fresnel zone for site location of Scatec PV1 to the second closest SKA telescope for (a) 100 MHz (b) 1000 MHz (c) 2000 MHz and (d) 3000 MHz.

A.54 Scatec PV1 to Core SKA

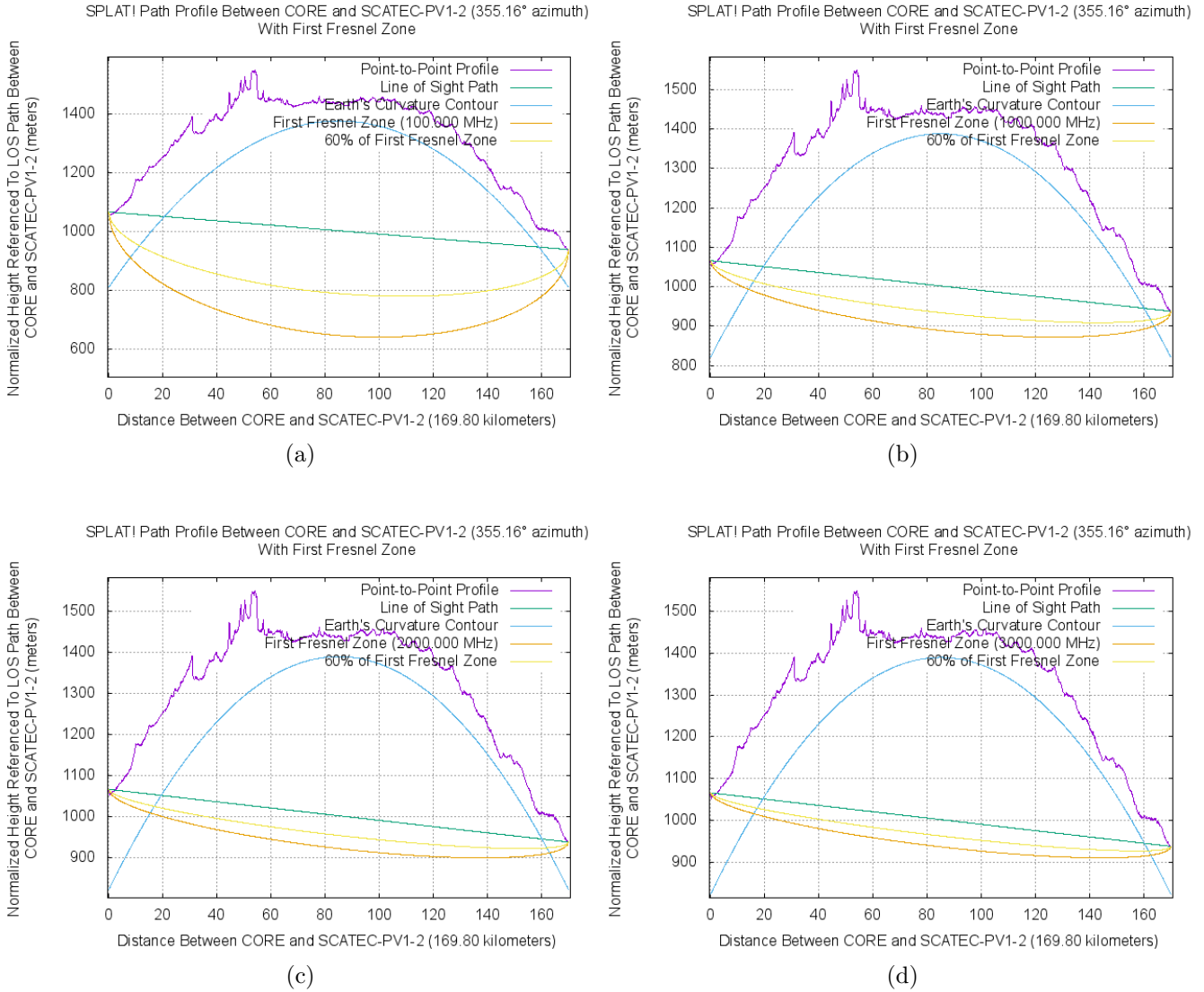

Figure 90: Fresnel zone, LOS and 60% of first Fresnel zone for site location of Scatec PV1 to the core SKA telescopes for (a) 100 MHz (b) 1000 MHz (c) 2000 MHz and (d) 3000 MHz.

A.55 Scatec PV2 to Closest SKA

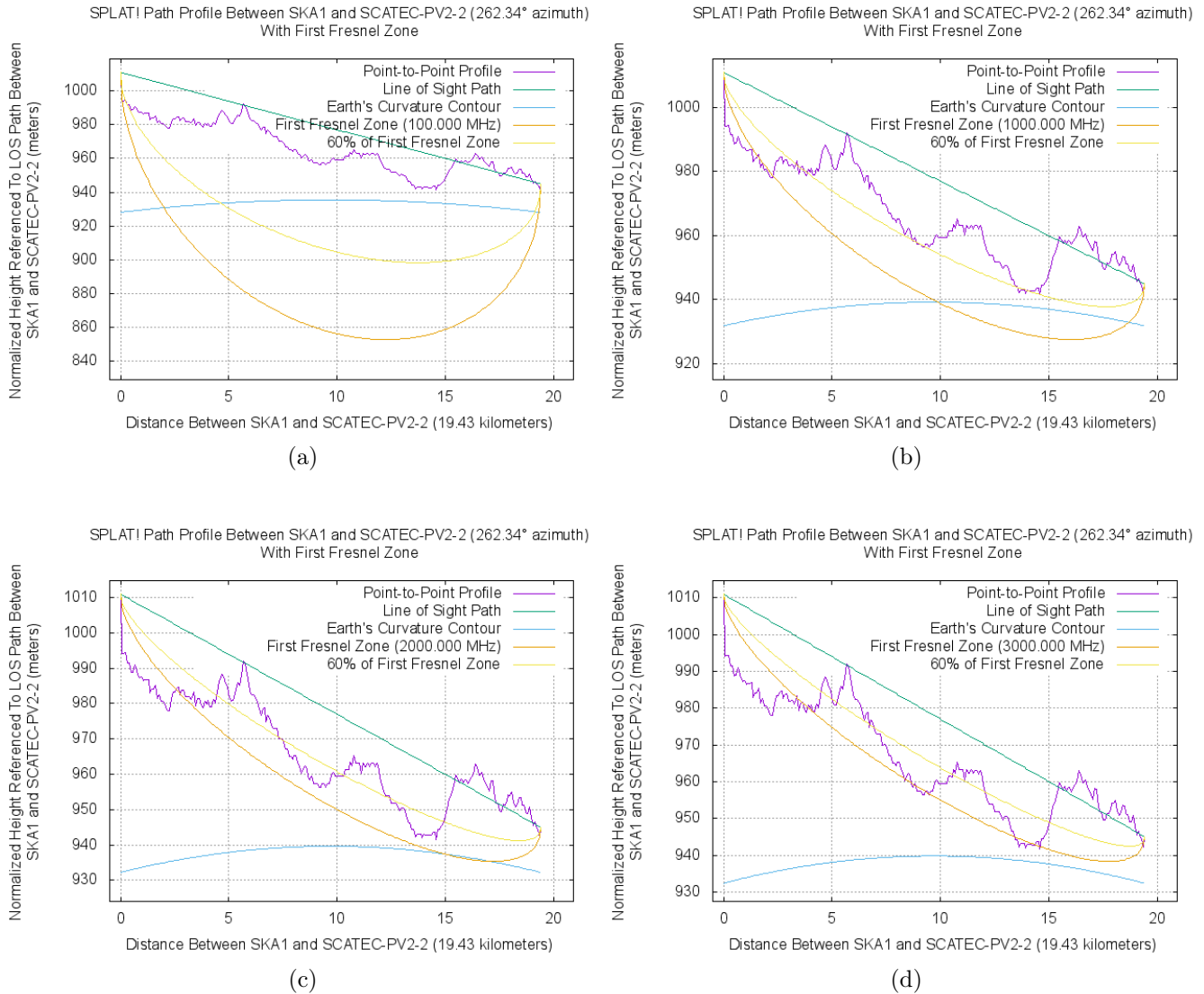

Figure 91: Fresnel zone, LOS and 60% of first Fresnel zone for site location of Scatec PV2 to the closest SKA telescope for (a) 100 MHz (b) 1000 MHz (c) 2000 MHz and (d) 3000 MHz.

A.56 Scatec PV2 to 2nd Closest SKA

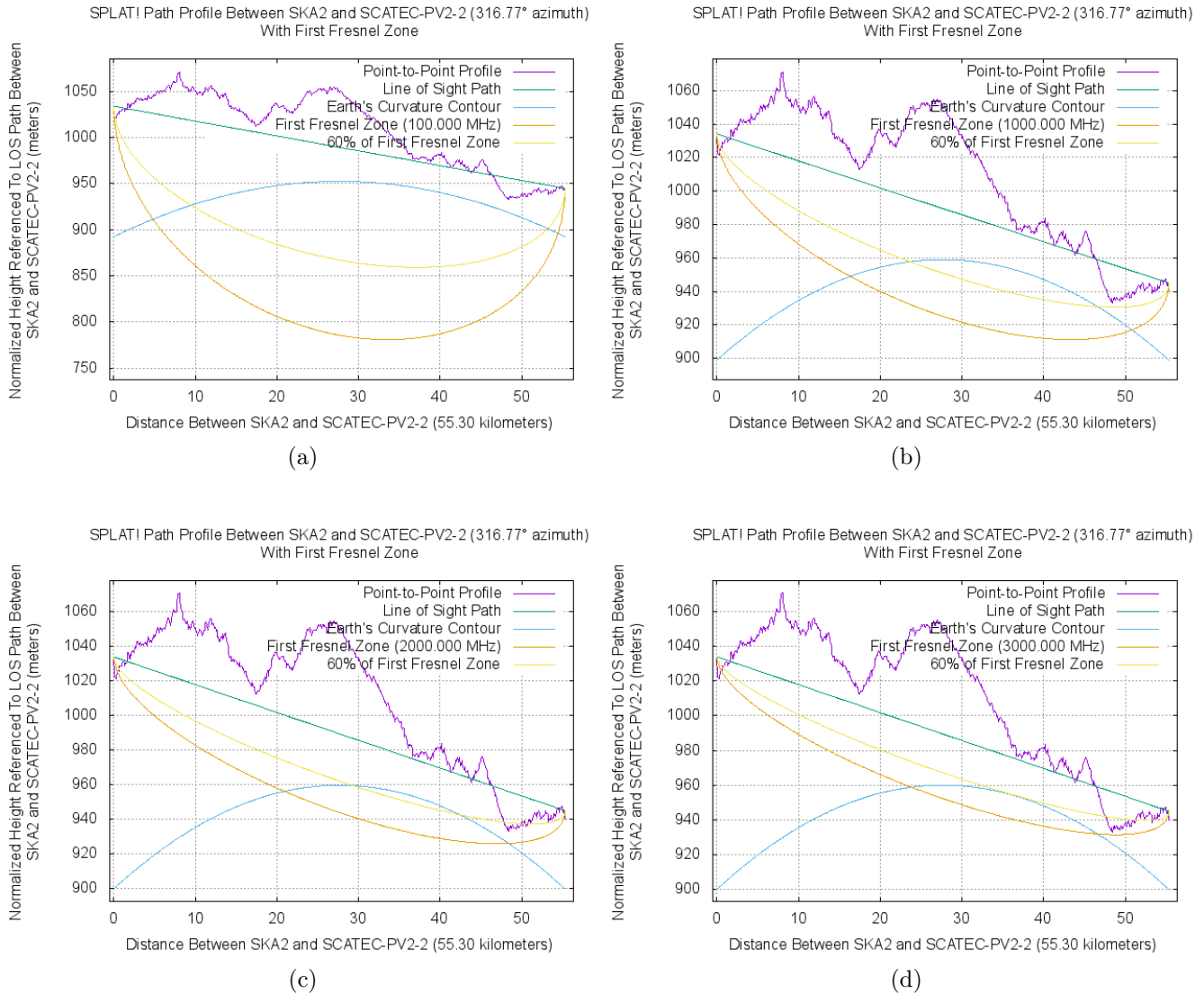

Figure 92: Fresnel zone, LOS and 60% of first Fresnel zone for site location of Scatec PV2 to the second closest SKA telescope for (a) 100 MHz (b) 1000 MHz (c) 2000 MHz and (d) 3000 MHz.

A.57 Scatec PV2 to Core SKA

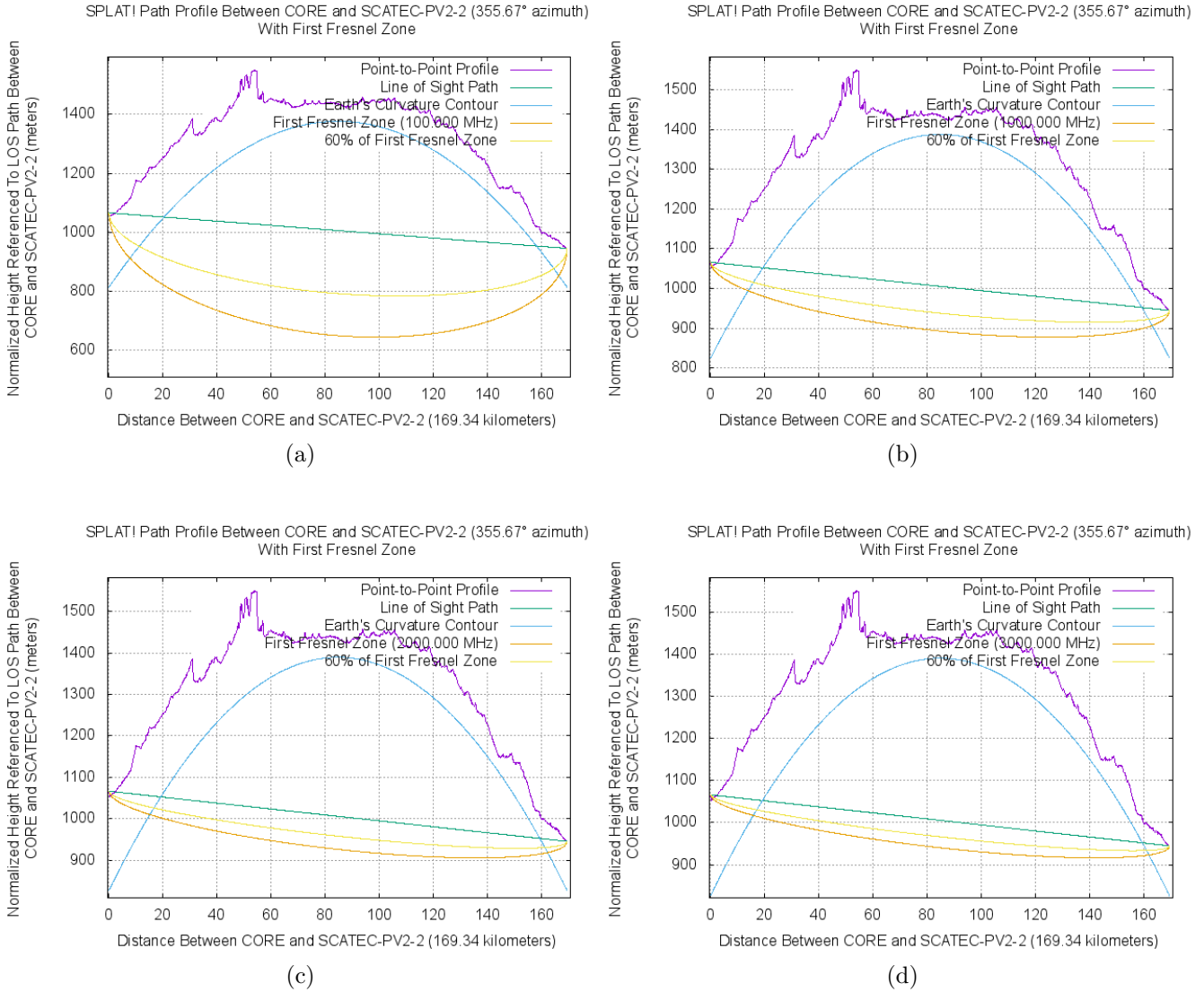

Figure 93: Fresnel zone, LOS and 60% of first Fresnel zone for site location of Scatec PV2 to the core SKA telescopes for (a) 100 MHz (b) 1000 MHz (c) 2000 MHz and (d) 3000 MHz.

A.58 Scatec PV3 to Closest SKA

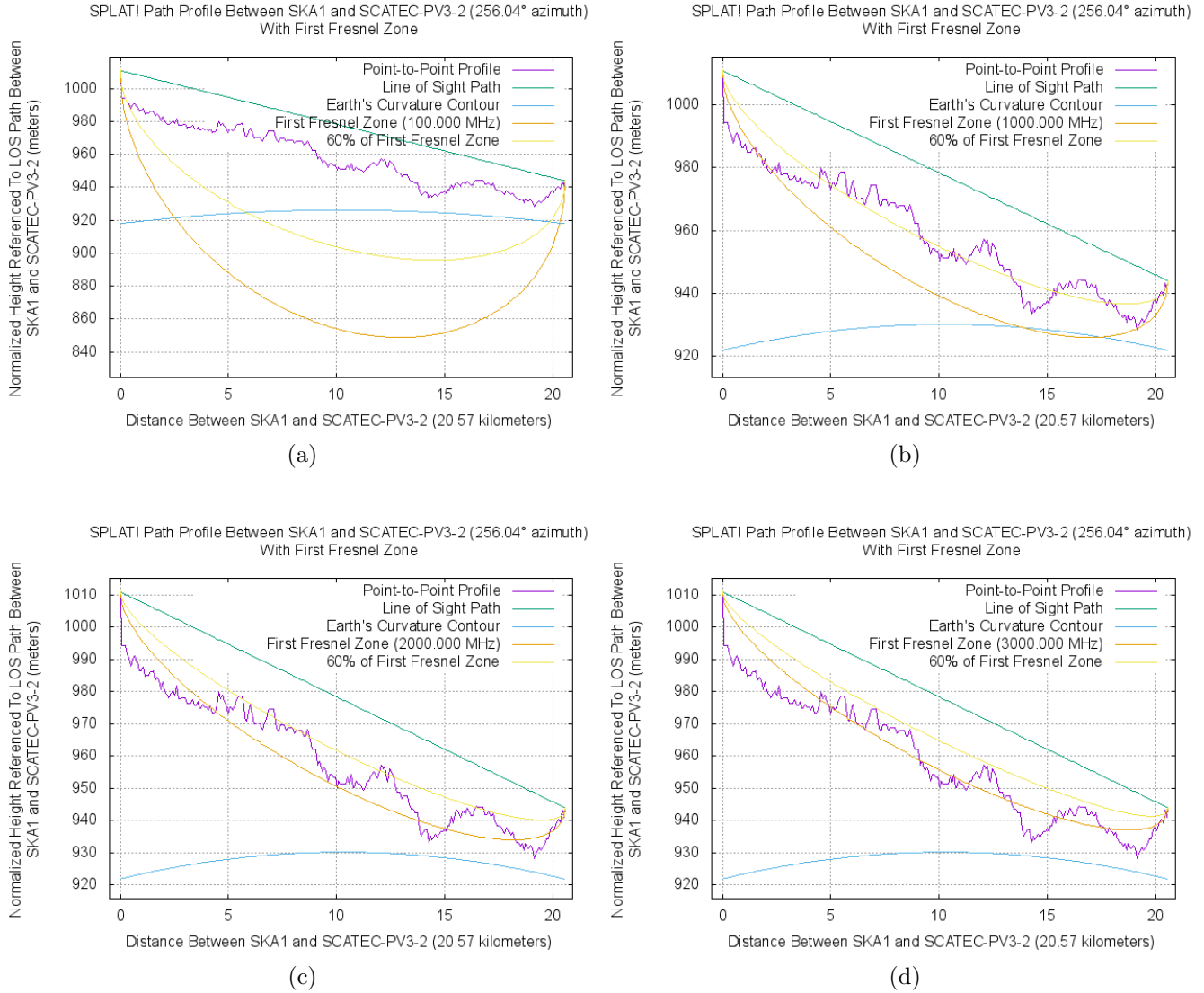

Figure 94: Fresnel zone, LOS and 60% of first Fresnel zone for site location of Scatec PV3 to the closest SKA telescope for (a) 100 MHz (b) 1000 MHz (c) 2000 MHz and (d) 3000 MHz.

A.59 Scatec PV3 to 2nd Closest SKA

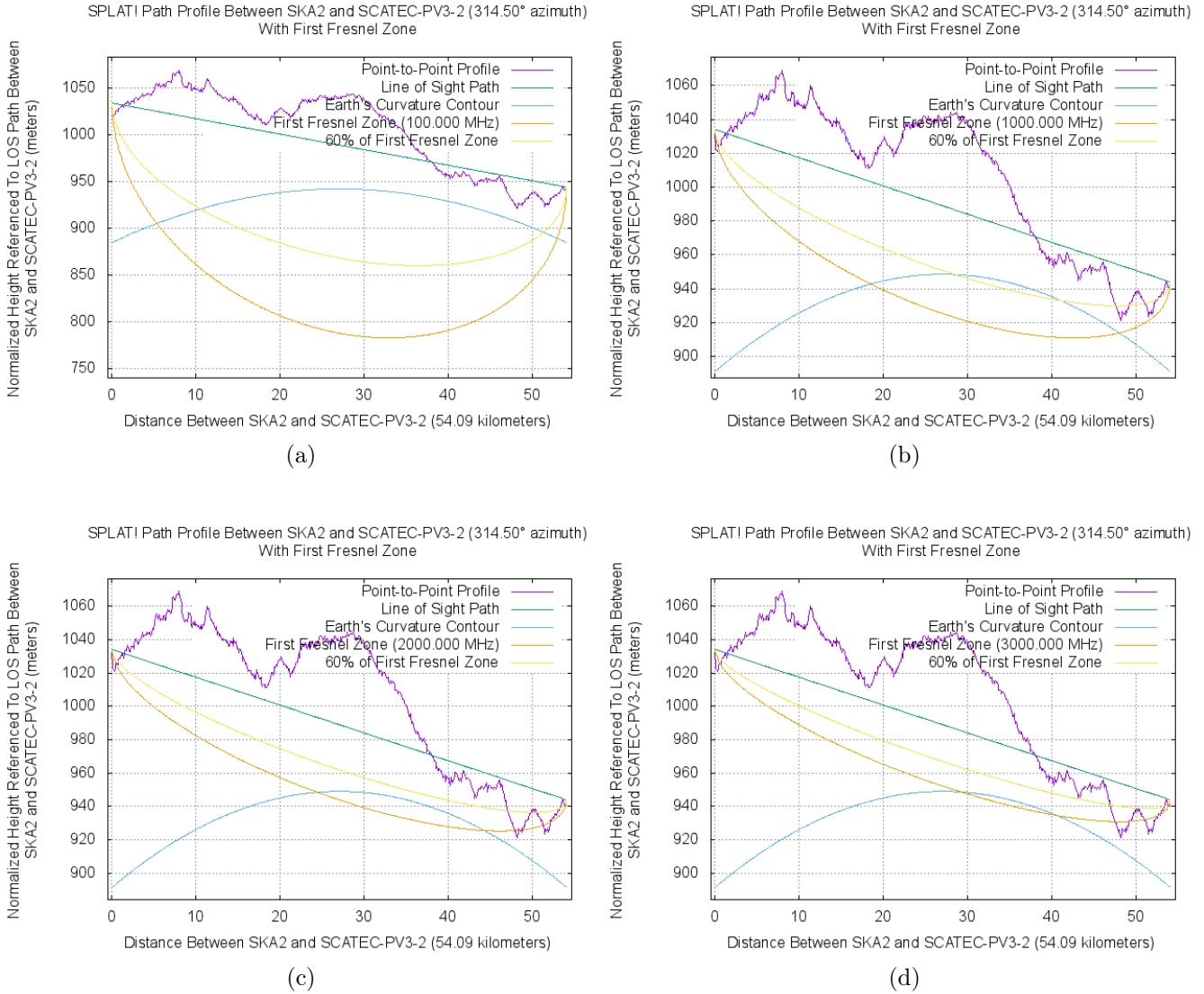

Figure 95: Fresnel zone, LOS and 60% of first Fresnel zone for site location of Scatec PV3 to the second closest SKA telescope for (a) 100 MHz (b) 1000 MHz (c) 2000 MHz and (d) 3000 MHz.

A.60 Scatec PV3 to Core SKA

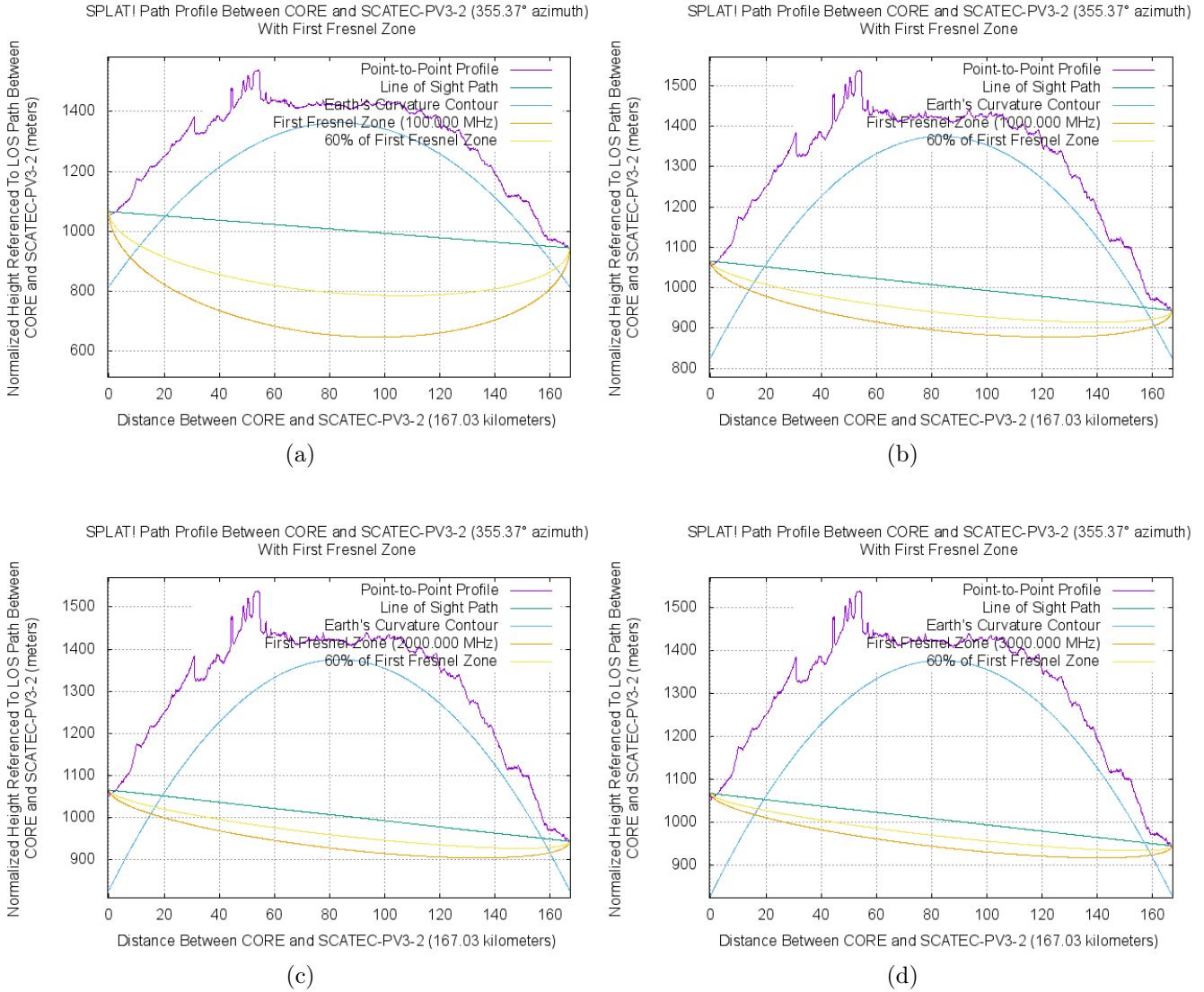

Figure 96: Fresnel zone, LOS and 60% of first Fresnel zone for site location of Scatec PV3 to the core SKA telescopes for (a) 100 MHz (b) 1000 MHz (c) 2000 MHz and (d) 3000 MHz.