

Figure A3.2: Google Earth© satellite image showing the project area for the southern cluster of Kudu Solar Photovoltaic Facilities and associated infrastructure near Philipstown and De Aar, Northern Cape. The two recorded fossil sites indicated by the numbered yellow circles (583, 586) both fall *outside* the PV buildable areas/development footprints and are of low scientific / conservation value so no mitigation is proposed with regard to them. *N.B.* North is towards the LHS.

Table A3.1: Palaeontological heritage data for Kudu Solar Photovoltaic Facilities

Kudu Solar PV Facility project	Recorded fossil heritage	Recommended mitigation
PV1	None	Application of Chance Fossil Finds Protocol during Construction Phase
PV2	None	Application of Chance Fossil Finds Protocol during Construction Phase
PV3	None	Application of Chance Fossil Finds Protocol during Construction Phase
PV4	None	Application of Chance Fossil Finds Protocol during Construction Phase
PV5	None	Application of Chance Fossil Finds Protocol during Construction Phase
PV6	None	Application of Chance Fossil Finds Protocol during Construction Phase
PV7	None	Application of Chance Fossil Finds Protocol during Construction Phase
PV8	None	Application of Chance Fossil Finds Protocol during Construction Phase
PV9	None	Application of Chance Fossil Finds Protocol during Construction Phase
PV10	None	Application of Chance Fossil Finds Protocol during Construction Phase
PV11	None	Application of Chance Fossil Finds Protocol during Construction Phase
PV12	None	Application of Chance Fossil Finds Protocol during Construction Phase

PALAEOLOGICAL SSV SITE VISIT APRIL 2022		
LOC	GPS data	Comments
583	30.245804° S, 24.315688° E	Excavated block of speckled, grey-green Tierberg Formation siltstone containing vague, pale horizontal burrows (scale in cm and half-cm), farm Bas Berg RE 88. Provisional Field Rating IIC Local Resource. Located <i>outside</i> PV project development area. No mitigation recommended.
586	30.241383° S, 24.327129° E	Simple horizontal burrows preserved in dark material contrasting with the pale yellowish-grey matrix which is probably of baked Tierberg Formation mudrock, float block on farm Bas Berg 3/88. Provisional Field Rating IIC Local Resource. Located <i>outside</i> PV project development area. No mitigation recommended.



CHAPTER 13: Socio-Economic Assessment



SOCIO-ECONOMIC ASSESSMENT

KUDU PV 1 SOLAR ENERGY FACILITY

NORTHERN CAPE PROVINCE

VERSION 0: APRIL 2023

VERSION 1: JULY 2023

Prepared

By

Tony Barbour and Schalk van der Merwe

Tony Barbour

ENVIRONMENTAL CONSULTING

10 Firs Avenue, Claremont, 7708, South Africa

(Cell) 082 600 8266

(E-Mail) tony@tonybarbour.co.za. www.tonybarbour.co.za

EXECUTIVE SUMMARY

INTRODUCTION AND LOCATION

The CSIR was appointed to manage the Environmental Impact Assessment (EIA) process for the proposed Kudu Photovoltaic (PV) Solar Energy Facility (SEF) Cluster located approximately 60km north of the town of De Aar in the Northern Cape Province. The project site is situated within the Renosterberg Local Municipality (RLM), which is located within the Pixley Ka Seme District Municipality (PKSDM). The Kudu PV1 SEF (50 MW) forms part of a cluster consisting of 12 PV SEFs (PV1-PV12) with a combined generation capacity of 2 180 MW.

Tony Barbour was appointed to undertake a specialist Socio-economic Assessment as part of the EIA process. This report assesses the social impacts associated with the 50 MW Kudu PV 1 SEF.

SUMMARY OF KEY FINDINGS

KEY FINDINGS

The key findings of the study are summarised under the following sections:

- Fit with policy and planning.
- Construction phase impacts.
- Operational phase impacts.
- Cumulative impacts.
- Decommissioning phase impacts.
- No-development option.

POLICY AND PLANNING ISSUES

The development of and investment in renewable energy is supported by the National Development Plan (NDP), New Growth Path Framework and National Infrastructure Plan, which all refer to and support renewable energy. The PKSDM Spatial Development Framework (SDF) and Integrated Development Plan (IDP) also support the development of renewable energy. The development of the proposed SEF is therefore supported by key policy and planning documents.

CONSTRUCTION PHASE

Potential positive impacts

- Creation of employment and business opportunities, and the opportunity for skills development and on-site training.

The construction phase is expected to extend over a period of 12 to 18 months and create approximately 150 employment opportunities. The total wage bill for the construction phase is estimated to be in the region of R 30 million (2023 Rand value). A percentage of the wage bill will be spent in the local economy which will also create opportunities for local businesses in the local towns in the area and the RLM and Emthanjeni Local Municipality (ELM).

Members from the local communities in De Aar, Philipstown and Petrusville may potentially qualify for low skilled and semi-skilled and some skilled employment opportunities. Most of these employment opportunities will accrue to Historically Disadvantaged (HD) members of the community. Given relatively high local unemployment levels and limited job opportunities in the area, this will represent a significant, if localised, social benefit. However, in the absence of specific commitments from the developer to employ local contractors the potential for meaningful skills to local employment targets the benefits for members from the local communities may be limited. In addition, the low education and skills levels in the area may also hamper potential opportunities for local communities.

The capital expenditure associated with the construction phase will be approximately R 1.5 – 2 billion (2023 Rand value). This will create opportunities for local companies and the regional and local economy. Due the lack of diversification in the local economy the potential for local companies is likely to be limited. The majority of benefits are therefore likely to accrue to contractors and engineering companies based outside the RLM and ELM. The local service sector will also benefit from the construction phase. The potential opportunities would be linked to accommodation, catering, cleaning, transport, and security, etc. associated with the construction workers on the site.

Potential negative impacts

- Impacts associated with the presence of construction workers on local communities.
- Impacts related to the potential influx of job seekers.
- Increased risks to livestock and farming infrastructure associated with the construction related activities and presence of construction workers on the site.
- Increased risk of grass fires associated with construction related activities.
- Noise, dust, and safety impacts of construction related activities and vehicles.
- Impact on productive farmland.

The findings of the SIA indicate that the significance of all the potential negative impacts with mitigation are likely to be **Low Negative**. The potential negative impacts can therefore be effectively mitigated if the recommended mitigation measures are implemented. Table 1 summarises the significance of the impacts associated with the construction phase.

Table 1: Summary of social impacts during construction phase

Impact	Significance No Mitigation/Enhancement	Significance With Mitigation/Enhancement
Creation of employment and business opportunities	Medium (+)	Medium (+)
Presence of construction workers and potential impacts on family structures and social networks	Medium (-)	Low (-)
Influx of job seekers	Low (-)	Low (-)
Safety risk, stock theft and damage to farm infrastructure associated with presence of construction workers	Medium (-)	Low (-)
Increased risk of grass fires	Medium (-)	Low (-)
Impact of heavy vehicles and construction activities	Medium (-)	Low (-)
Loss of farmland	Medium (-)	Low (-)

OPERATIONAL PHASE

Potential positive impacts

- Establishment of infrastructure to improve energy security and support renewable sector.
- Creation of employment opportunities.
- Benefits associated with socio-economic contributions to community development.
- Benefits for local landowners.

The proposed project will supplement South Africa's energy and assist to improve energy security. In addition, it will also reduce the country's reliance on coal as an energy source. This represents a positive social benefit.

Potential negative impacts

- Visual impacts and associated impacts on sense of place.
- Potential impact on property values.
- Potential impact on tourism.

The findings of the SIA indicate that the significance of all the potential negative impacts with the exception of visual impacts will be **Low Negative** with mitigation. The majority of potential negative impacts can therefore be effectively mitigated. The significance of the impacts associated with the operational phase are summarised in Table 2.

Table 2: Summary of social impacts during operational phase

Impact	Significance No Mitigation/Enhancement	Significance With Mitigation/Enhancement
Establishment of infrastructure to improve energy security and support renewable sector	High (+)	High (+)
Creation of employment and business opportunities during maintenance	Low (+)	Medium (+)
Benefits associated with socio-economic contributions to community development	Medium (+)	High (+)
Benefits for landowners	Low (+)	High (+)
Visual impact and impact on sense of place	Low (-)	Low (-)
Impact on property values	Low (-)	Low (-)
Impact on tourism	Low (-)	Low (-)

CUMULATIVE IMPACTS

Cumulative impact on sense of place

The establishment of the proposed PV SEF and other renewable energy facilities in the area will create the potential for combined and sequential visibility impacts. This impact is rated as **Moderate Negative**.

Cumulative impact on local services and accommodation

The significance of this impact with effective mitigation was rated as **Low Negative**.

Cumulative impact on local economy

The significance of this impact with enhancement was rated as **Moderate Positive**.

DECOMMISSIONING

Given the moderate number of people employed during the operational phase (~ 30), the potential negative social impacts associated with the decommissioning phase can also be effectively managed with the implementation of a retrenchment and downscaling programme. With mitigation, the impacts are assessed to be **Low Negative**.

NO-DEVELOPMENT OPTION

The No-Development option would represent a lost opportunity for South Africa to improve energy security and supplement its current energy needs with clean, renewable energy. Given South Africa's current energy security challenges and its

position as one of the highest per capita producers of carbon emissions in the world, this would represent a significant negative social cost. The No-Development option is not supported by the findings of the SIA.

ASSESSMENT OF BESS SITE

Based on the findings of the SIA the proposed BESS site and both proposed technology alternatives are suitable from a social impact assessment point of view.

CONCLUSIONS AND RECOMMENDATIONS

The findings of the SIA indicate that the proposed Kudu PV 1 SEF will result in several social and socio-economic benefits, including creation of employment and business opportunities during both the construction and operational phases. The project will also create economic development opportunities for the local community. The enhancement measures listed in the report should be implemented in order to maximise the potential benefits. The significance of this impact is rated as **High Positive**. The proposed development also represents an investment in clean, renewable energy infrastructure, which, given the negative environmental and socio-economic impacts associated a coal-based energy economy and the challenges created by climate change, represents a significant positive social benefit for society as a whole. The Renewable Energy Independent Power Producers Procurement Programme (REIPPPP) has resulted in significant socio-economic benefits, both at a national level and at a local, community level. These benefits are linked to foreign Direct Investment, local employment and procurement and investment in local community initiatives.

The findings also indicate that the potential negative impacts associated with both the construction and operational phase are likely to be **Low Negative** with mitigation. The potential negative impacts can therefore be effectively mitigated if the recommended mitigation measures are implemented.

Statement and reasoned opinion

The establishment of the proposed Kudu PV 1 SEF and associated infrastructure is therefore supported by the findings of the SIA.

TABLE OF CONTENTS

EXECUTIVE SUMMARY	I
SECTION 1: INTRODUCTION	1
1.1 INTRODUCTION	1
1.2 TERMS OF REFERENCE AND APPROACH	1
1.3 PROJECT DESCRIPTION	2
1.4 ASSUMPTIONS AND LIMITATIONS	5
1.4.1 Assumptions	5
1.4.2 Limitations	5
1.5 SPECIALIST DETAILS	5
1.6 DECLARATION OF INDEPENDENCE	5
1.7 REPORT STRUCTURE	6
SECTION 2: POLICY AND PLANNING ENVIRONMENT	7
2.1 INTRODUCTION	7
2.2 NATIONAL POLICY ENVIRONMENT	7
2.2.1 National Energy Act (Act No 34 of 2008)	7
2.2.2 White Paper on the Energy Policy of the Republic of South Africa	8
2.2.3 White Paper on Renewable Energy	8
2.2.4 Integrated Resource Plan (2019)	9
2.2.5 National Development Plan	11
2.2.6 The New Growth Path Framework	12
2.2.7 National Infrastructure Plan	12
2.2.8 Astronomy Geographic Advantage Act	13
2.3 PROVINCIAL AND LOCAL LEVEL POLICY AND PLANNING	13
2.3.1 Northern Cape Province Provincial Growth and Development Strategy	13
2.3.2 Northern Cape Provincial Spatial Development Framework	14
2.2.3 Northern Cape Provincial Climate Change Response Strategy	16
2.2.4 Northern Cape Province Green Document	16
2.3.4 Pixley ka Seme District Municipality Integrated Development Plan	17
2.3.5 Pixley ka Seme District Municipality Spatial Development Framework	18
2.3.6 Renosterberg Local Municipality Integrated Development Plan	20
2.3.7 Emthanjeni Local Municipality Integrated Development Plan	22
2.4 OVERVIEW OF THE RENEWABLE ENERGY SECTOR IN SOUTH AFRICA	23
2.4.1 Independent Power Producers Procurement Programme (IPPPP): An Overview	23
2.4.2 Green Jobs Study	31
2.4.3 Powering the Future: Renewable Energy Roll-out in South Africa	33
2.4.4 WWF SA Renewable Energy Vision 2030	34
2.4.5 The impact of the green economy on jobs in South Africa	36
2.4.6 The potential for local community benefits	36
SECTION 3: OVERVIEW OF STUDY AREA	38
3.1 INTRODUCTION	38
3.2 ADMINISTRATIVE CONTEXT	38
3.3 PROVINCIAL CONTEXT	39
3.4 MUNICIPAL OVERVIEW	43
3.5 MUNICIPAL SERVICES	45
3.6 HEALTH AND COMMUNITY FACILITIES	45
3.7 ECONOMIC OVERVIEW	45

3.8 OVERVIEW OF STUDY AREA	46
3.8.1 General context	46
3.8.2 Site and adjacent properties	50
3.8.3 Relationship to receptors	53
3.8.4 Other renewable energy facilities	54
SECTION 4: OVERVIEW OF KEY SOCIAL ISSUES	56
4.1 INTRODUCTION	56
4.2 ASSESSMENT OF POLICY AND PLANNING FIT	56
4.3 CONSTRUCTION PHASE SOCIO-ECONOMIC IMPACTS	57
4.3.1 Creation of local employment, skills development, training, and business opportunities	57
4.3.2 Impact of construction workers on local communities	59
4.3.3 Influx of job seekers	60
4.3.4 Risk to safety, livestock, and farm infrastructure	61
4.3.5 Increased risk of grass fires	63
4.3.6 Nuisance impacts associated with construction related activities	64
4.3.7 Impacts associated with loss of farmland	65
4.4 OPERATIONAL PHASE SOCIAL IMPACTS	67
4.4.1 Improve energy security and support the renewable energy sector	67
4.4.2 Creation of employment opportunities	69
4.4.3 Generate income for affected landowners	69
4.4.4 Benefits associated with the socio-economic development contributions	70
4.4.5 Visual impact and impact on sense of place	71
4.4.6 Potential impact on property values	72
4.4.7 Potential impact on tourism	73
4.5 ASSESSMENT OF DECOMMISSIONING PHASE	74
4.6 CUMULATIVE IMPACT ON SENSE OF PLACE	75
4.7 CUMULATIVE IMPACT ON LOCAL SERVICES AND ACCOMMODATION	76
4.8 CUMULATIVE IMPACT ON LOCAL ECONOMY	77
4.9 ASSESSMENT OF NO-DEVELOPMENT OPTION	78
4.10 ASSESSMENT OF BESS	79
SECTION 5: KEY FINDINGS AND RECOMMENDATIONS	80
5.1 INTRODUCTION	80
5.2 SUMMARY OF KEY FINDINGS	80
5.2.1 Policy and planning issues	80
5.2.2 Construction phase impacts	80
5.2.3 Operational phase impacts	82
5.2.4 Assessment of cumulative impacts	83
5.2.5 Decommissioning phase	83
5.2.6 Assessment of no-development option	83
5.2.7 Assessment of BESS site	84
5.3 CONCLUSIONS	84
ANNEXURE A	86
ANNEXURE B	87
ANNEXURE C	91
ANNEXURE D	92

CONTENTS OF THE SPECIALIST REPORT – CHECKLIST

Regulation GNR 326 of 4 December 2014, as amended 7 April 2017, Appendix 6	Section of Report
(a) details of the specialist who prepared the report; and the expertise of that specialist to compile a specialist report including a <i>curriculum vitae</i> ;	Section 1.6, Annexure C
(b) a declaration that the specialist is independent in a form as may be specified by the competent authority;	Section 1.7, Annexure D
(c) an indication of the scope of, and the purpose for which, the report was prepared;	Section 1.1, Section 1.2
(cA) an indication of the quality and age of base data used for the specialist report;	Section 1.2, Section 3
(cB) a description of existing impacts on the site, cumulative impacts of the proposed development and levels of acceptable change;	Section 4
(d) the duration, date and season of the site investigation and the relevance of the season to the outcome of the assessment;	N/A for SIA
(e) a description of the methodology adopted in preparing the report or carrying out the specialised process inclusive of equipment and modelling used;	Section 1.2, Annexure B
(f) details of an assessment of the specific identified sensitivity of the site related to the proposed activity or activities and its associated structures and infrastructure, inclusive of a site plan identifying site alternatives;	Section 4, Section 5
(g) an identification of any areas to be avoided, including buffers;	N/A
(h) a map superimposing the activity including the associated structures and infrastructure on the environmental sensitivities of the site including areas to be avoided, including buffers;	Section 3
(i) a description of any assumptions made and any uncertainties or gaps in knowledge;	Section 1.5
(j) a description of the findings and potential implications of such findings on the impact of the proposed activity, including identified alternatives on the environment, or activities;	Section 4, Section 5,
(k) any mitigation measures for inclusion in the EMPr;	Section 4
(l) any conditions for inclusion in the environmental authorisation;	Section 4, Section 5
(m) any monitoring requirements for inclusion in the EMPr or environmental authorisation;	N/A
(n) a reasoned opinion— i. as to whether the proposed activity, activities or portions thereof should be authorised; iA. Regarding the acceptability of the proposed activity or activities; and ii. if the opinion is that the proposed activity, activities or portions thereof should be authorised, any avoidance, management and mitigation measures that should be included in the EMPr or Environmental Authorization, and where applicable, the closure plan;	Section 5.3
(o) a summary and copies of any comments received during any consultation process and where applicable all responses thereto; and	N/A
(p) any other information requested by the competent authority	N/A
Where a government notice gazetted by the Minister provides for any protocol or minimum information requirement to be applied to a specialist report, the requirements as indicated in such notice will apply.	

ACRONYMS

BESS	Battery Energy Storage System
DEA	Department of Environmental Affairs
DEA&DP	Department of Environmental Affairs and Development Planning
DM	District Municipality
EIA	Environmental Impact Assessment
ELM	Emthanjeni Local Municipality
HD	Historically Disadvantaged
IDP	Integrated Development Plan
IPP	Independent Power Producer
kV	Kilovolts
LED	Local Economic Development
LM	Local Municipality
MW	Megawatt
NC	Northern Cape
NCPPGDS Strategy	Northern Cape Province Provincial Growth and Development Strategy
NCSDF	Northern Cape Spatial Development Framework
PGDS	Provincial Growth and Development Strategy
PKSDM	Pixley Ka Seme District Municipality
RLM	Renosterberg Local Municipality
SDF	Spatial Development Framework
SED	Socio-economic Development
SEF	Solar Energy Facility
SIA	Social Impact Assessment

SECTION 1: INTRODUCTION

1.1 INTRODUCTION

The CSIR was appointed to manage the Environmental Impact Assessment (EIA) process for the proposed Kudu PV Solar Energy Facility (SEF) Cluster located approximately 60km north of the town of De Aar in the Northern Cape Province (Figure 1.1). The project site is situated within the Renosterberg Local Municipality (RLM), which is located within the Pixley Ka Seme District Municipality (PKSDM). The Kudu PV SEF Cluster consists of 12 PV SEFs (PV1-PV12).

Tony Barbour was appointed to undertake a specialist Socio-Economic Impact Assessment (SIA) as part of the EIA process. This report assesses the socio-economic impacts associated with the 50 MW Kudu PV 1 SEF.

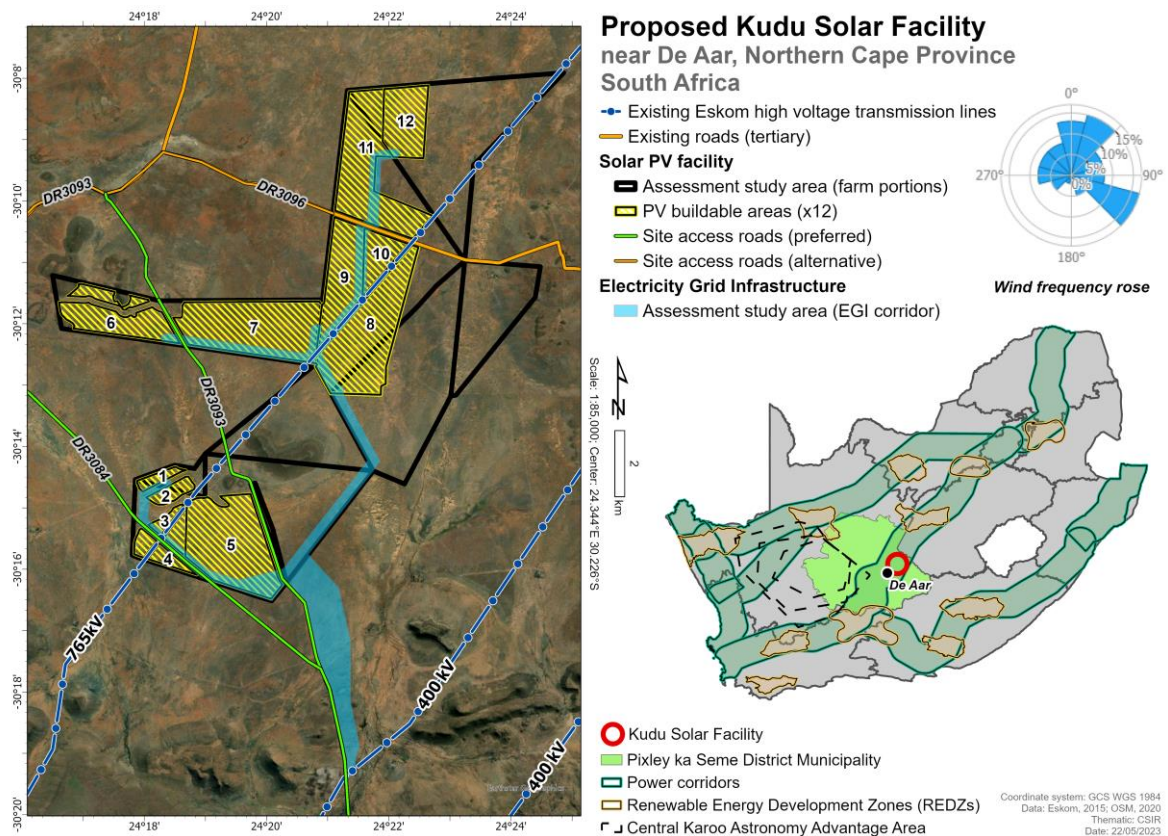

Figure 1.1: Location of the Kudu PV1 SEF within the SEF cluster

1.2 TERMS OF REFERENCE AND APPROACH

The approach to the SIA study is based on the Western Cape Department of Environmental Affairs and Development Planning (WC DEA&DP) Guidelines for Social Impact Assessment (February 2007). These guidelines are based on international best practice and are used throughout South Africa. The key activities in the SIA process embodied in the guidelines include:

- Describing and obtaining an understanding of the proposed intervention (type, scale, and location), the settlements, and communities likely to be affected by the proposed project.
- Collecting baseline data on the current social and economic environment.
- Identifying the key potential social issues associated with the proposed project. This requires a site visit to the area and consultation with affected individuals and communities. As part of the process a basic information document was prepared and made available to key interested and affected parties. The aim of the document was to inform the affected parties of the nature and activities associated with the construction and operation of the proposed development to enable them to better understand and comment on the potential social issues and impacts.
- Assessing and documenting the significance of social impacts associated with the proposed intervention.
- Identifying and assessing alternatives and recommending alternatives and mitigation measures.

In this regard the study involved:

- Review of socio-economic data for the study area.
- Review of relevant planning and policy frameworks for the area.
- Review of information from similar studies, including the SIAs undertaken for other renewable energy projects.
- Site visit and interviews with key stakeholders.
- Identifying the key potential social issues associated with the proposed project.
- Identifying and assessing the significance of social impacts associated with the proposed project.
- Identification of enhancement and mitigation measures aimed at maximizing opportunities and avoiding and or reducing negative impacts.

Annexure A contains a list of the secondary information reviewed and interviews conducted. Annexure B summarises the assessment methodology used to assign significance ratings to the assessment process.

1.3 PROJECT DESCRIPTION

ABO Wind is intending to develop the proposed Kudu PV SEF Cluster. As noted above, the project will entail the proposed development of up to 12 Solar PV SEFs and associated electrical infrastructure. The proposed projects are not located within any of the Renewable Energy Development Zones (REDZs) that were gazetted in Government Notice (GN) 114 in February 2018 and GN 144 in February 2021. Therefore, full Scoping and EIA Processes are needed.

Separate SIA reports are compiled for each proposed Kudu SEF. This report focuses on Kudu Solar Facility 1 (hereinafter referred to as "Kudu Solar Facility" or "the proposed project" or "Kudu SEF").

During the scoping phase, the specialists considered the entire study area, which included the Original Scoping Buildable Areas that included the development of up to 15 Solar PV Facilities. However, following the identification of sensitivities and the Bidding Window 6 Request for Proposal capacity limits, the proposed projects were re-clustered and a total of up to 12 Solar PV Facilities are now being proposed. The 50 MW Kudu SEF will consist of:

- Solar PV array comprising fixed-tilt, single axis tracking, dual axis tracking, mono-facial or bi-facial PV technology (Photograph 1.1).
- Access roads. Existing roads will be used as main access where possible, and may need to be widened or expanded.
- New internal service roads will need to be established and these would either comprise farm (compacted dirt/gravel) roads or be paved.
- Underground cabling, with the potential for above-ground routing where needed (22-33 kV).
- On-site substation complex at each PV Facility including the following:
 - On-site Independent Power Producer (IPP) or Facility Substation (+-1 ha).
 - Battery Energy Storage System (discussed below).
 - Switching Station and Collector Station (this is the subject of a separate Environmental Assessment process).
- Overhead powerlines (132 kV) (this is the subject of a separate Environmental Assessment (EA) process).
- Laydown areas.
- Temporary site compound.
- Auxiliary buildings to be developed include, but are not limited to Operations and Maintenance (O&M) buildings, site offices, staff lockers, bathrooms, warehouses/workshops, guardhouses, etc.
- Battery energy storage systems (BESS) of 500 MW (or 500 MWh), which could be either lithium-ion or redox flow technology only (Photograph 1.2).

It is the developer's intention to bid the proposed project under the Department of Mineral Resources and Energy's (DMRE's) Renewable Energy Independent Power Producer Procurement (REIPPP) Programme (or similar programme), with the aim of evacuating the generated power into the national grid. This will aid in the diversification and stabilisation of the country's electricity supply, in line with the objectives of the Integrated Resource Plan (IRP).

Refer to Chapter 2 of the EIA Report for an illustration of the detailed layout of the proposed project.



Photograph 1.1: Typical PV SEF facility



Photograph 1.2: Example of BESS located in storage containers

1.4 ASSUMPTIONS AND LIMITATIONS

1.4.1 Assumptions

Technical suitability

It is assumed that the development site represents a technically suitable site for the establishment of the proposed PV SEF and associated infrastructure.

Strategic importance of the project

The strategic importance of promoting renewable and other forms of energy is supported by the national and provincial energy policies.

Fit with planning and policy requirements

Legislation and policies reflect societal norms and values. The legislative and policy context therefore plays an important role in identifying and assessing the potential social impacts associated with a proposed development. In this regard, a key component of the SIA process is to assess the proposed development in terms of its fit with key planning and policy documents. As such, if the findings of the study indicate that the proposed development in its current format does not conform to the spatial principles and guidelines contained in the relevant legislation and planning documents, and there are no significant or unique opportunities created by the development, the development cannot be supported.

1.4.2 Limitations

Demographic data

Some of the provincial documents do not contain data from the 2011 Census and or 2016 Household Community Survey. However, where required the relevant 2011 and 2016 data has been provided.

1.5 SPECIALIST DETAILS

Tony Barbour, the lead author of this report, is an independent specialist with 30 years' experience in the field of environmental management. In terms of SIA experience Tony Barbour has undertaken in the region of 300 SIAs and is the author of the Guidelines for Social Impact Assessments for EIA's adopted by the DEA&DP in the Western Cape in 2007. Annexure C contains a copy of Tony Barbour's CV.

Schalk van der Merwe, the co-author of this report, has an MPhil in Environmental Management from the University of Cape Town and has worked closely with Tony Barbour over the last seventeen years.

1.6 DECLARATION OF INDEPENDENCE

This confirms that Tony Barbour and Schalk van der Merwe, the specialist consultants responsible for undertaking the study and preparing the SIA Report, are independent and do not have any vested or financial interests in the proposed power line being either approved or rejected. Annexure D contains a signed declaration of independence.

1.7 REPORT STRUCTURE

The report is divided into five sections, namely:

- Section 1: Introduction.
- Section 2: Summary of key policy and planning documents.
- Section 3: Overview of the study area.
- Section 4: Identification and assessment of key social issues.
- Section 5: Summary of key findings and recommendations.

SECTION 2: POLICY AND PLANNING ENVIRONMENT

2.1 INTRODUCTION

Legislation and policy embody and reflect key societal norms, values, and developmental goals. The legislative and policy context therefore plays an important role in identifying, assessing, and evaluating the significance of potential social impacts associated with any given proposed development. An assessment of the “policy and planning fit¹” of the proposed development therefore constitutes a key aspect of the Social Impact Assessment (SIA). In this regard, assessment of “planning fit” conforms to international best practice for conducting SIAs.

Section 2 provides an overview of the policy and planning environment affecting the proposed project. For the purposes of meeting the objectives of the SIA the following policy and planning documents were reviewed:

- National Energy Act (2008).
- White Paper on the Energy Policy of the Republic of South Africa (December 1998).
- White Paper on Renewable Energy (November 2003).
- Integrated Resource Plan (IRP) for South Africa (2019).
- National Infrastructure Plan (NIP) (2012 and 2021).
- National Development Plan (2011).
- Northern Cape Provincial Growth and Development Strategy (2004-2014).
- Northern Cape Climate Change Response Strategy.
- Northern Cape Spatial Development Framework (2012).
- Northern Cape Province Green Document (2017/2018).
- Pixley ka Seme District Municipality Integrated Development Plan (2019-2020).
- Pixley ka Seme District Municipality Spatial Development Framework (2017).
- Emthanjeni Local Municipality Integrated Development Plan (2021-2022).
- Renosterberg Local Municipality Integrated Development Plan².

The section also provides a review of the renewable energy sector in South Africa.

2.2 NATIONAL POLICY ENVIRONMENT

2.2.1 National Energy Act (Act No 34 of 2008)

The National Energy Act was promulgated in 2008 (Act No 34 of 2008). One of the objectives of the Act was to promote diversity of supply of energy and its sources. In this regard, the preamble makes direct reference to renewable resources, including solar and wind:

“To ensure that diverse energy resources are available, in sustainable quantities, and at affordable prices, to the South African economy, in support of economic

¹ Planning fit” can simply be described as the extent to which any relevant development satisfies the core criteria of appropriateness, need, and desirability, as defined or circumscribed by the relevant applicable legislation and policy documents at a given time.

² At the time of undertaking the study a copy of the 2017-2022 Renosterberg Local Municipality Integrated Development Plan (IDP) could not be sourced.

growth and poverty alleviation, taking into account environmental management requirements (...); to provide for (...) increased generation and consumption of renewable energies..." (Preamble).

2.2.2 White Paper on the Energy Policy of the Republic of South Africa

Investment in renewable energy initiatives, such as the proposed SEF, is supported by the White Paper on Energy Policy for South Africa (December 1998). In this regard, the document notes:

"Government policy is based on an understanding that renewables are energy sources in their own right, are not limited to small-scale and remote applications, and have significant medium and long-term commercial potential".

"Renewable resources generally operate from an unlimited resource base and, as such, can increasingly contribute towards a long-term sustainable energy future".

The support for renewable energy policy is guided by a rationale that South Africa has a very attractive range of renewable resources, particularly **solar** and wind and that renewable applications are in fact the least cost energy service in many cases; more so when social and environmental costs are taken into account.

Government policy on renewable energy is thus concerned with meeting the following challenges:

- Ensuring that economically feasible technologies and applications are implemented.
- Ensuring that an equitable level of national resources is invested in renewable technologies, given their potential, and compared to investments in other energy supply options; and,
- Addressing constraints on the development of the renewable industry.

The White Paper also acknowledges that South Africa has neglected the development and implementation of renewable energy applications, despite the fact that the country's renewable energy resource base is extensive, and many appropriate applications exist.

The White Paper also notes that renewable energy applications have specific characteristics that need to be considered. Advantages include:

- Minimal environmental impacts in operation in comparison with traditional supply technologies; and
- Generally lower running costs, and high labour intensities.

Disadvantages identified at the time include:

- Higher capital costs in some cases.
- Lower energy densities.
- Lower levels of availability, depending on specific conditions, especially with sun and wind-based systems.

2.2.3 White Paper on Renewable Energy

The White Paper on Renewable Energy (November 2003) (further referred to as the White Paper) supplements the *White Paper on Energy Policy*, which recognizes that

the medium and long-term potential of renewable energy is significant. This Paper sets out Government's vision, policy principles, strategic goals and objectives for promoting and implementing renewable energy in South Africa.

The White Paper notes that while South Africa is well endowed with renewable energy resources that have the potential to become sustainable alternatives to fossil fuels, these have thus far remained largely untapped. As signatory to the Kyoto Protocol³, Government is determined to make good the country's commitment to reducing greenhouse gas emissions. To this purpose, Government has committed itself to the development of a framework in which a national renewable energy framework can be established and operate.

South Africa is also a signatory of the Copenhagen Accord, a document that delegates at the 15th session of the Conference of Parties (COP 15) to the United Nations Framework Convention on Climate Change agreed to "take note of" at the final plenary on 18 December 2009. The accord endorses the continuation of the Kyoto Protocol and confirms that climate change is one of the greatest challenges facing the world. In terms of the accord South Africa committed itself to a reduction target of 34% compared to business as usual. In this regard, the IRP 2010 aims to allocate 43% of new energy generation facilities in South Africa to renewables.

Apart from the reduction of greenhouse gas emissions, the promotion of renewable energy sources is aimed at ensuring energy security through the diversification of supply (in this regard, also refer to the objectives of the National Energy Act).

Government's long-term goal is the establishment of a renewable energy industry producing modern energy carriers that will offer in future years a sustainable, fully non-subsidised alternative to fossil fuels.

2.2.4 Integrated Resource Plan (2019)

South Africa's National Development Plan (NDP) 2030 offers a long-term plan for the country. It defines a desired destination where inequality and unemployment are reduced, and poverty is eliminated so that all South Africans can attain a decent standard of living. Electricity is one of the core elements of a decent standard of living. In formulating its vision for the energy sector, the NDP took as a point of departure the Integrated Resource Plan (IRP) 2010–2030 promulgated in March 2011. The IRP is an electricity infrastructure development plan based on least-cost electricity supply and demand balance, taking into account security of supply and the environment (minimize negative emissions and water usage).

On 27 August 2018, the then Minister of Energy published a draft IRP which was issued for public comment (Draft IRP). Following a lengthy public participation and consultation process the Integrated Resource Plan 2019 (IRP 2019) was gazetted by the Minister of Mineral Resources and Energy, Gwede Mantashe, on 18 October

³ The Kyoto Protocol is a protocol to the United Nations Framework Convention on Climate Change (UNFCCC), aimed at fighting global warming. The UNFCCC is an international environmental treaty with the goal of achieving "stabilization of greenhouse gas concentrations in the atmosphere at a level that would prevent dangerous anthropogenic interference with the climate system". The Protocol was initially adopted on 11 December 1997 in Kyoto, Japan and entered into force on 16 February 2005. As of November 2009, 187 states have signed and ratified the protocol (Wikipedia).

2019, updating the energy forecast for South Africa from the current period to the year 2030. The IRP is an electricity capacity plan which aims to provide an indication of the country's electricity demand, how this demand will be supplied and what it will cost.

The IRP notes that South Africa is a signatory to the Paris Agreement on Climate Change and has ratified the agreement. The energy sector contributes close to 80% towards the country's total Green House Gas (GHG) emissions of which 50% are from electricity generation and liquid fuel production alone. A transmission from a fossil fuel-based energy sources is therefore critical to reducing GHG emissions. In September 2021 South Africa released its latest emission targets, indicating that it intended to limit Green House Gas (GHG) emissions to 398-510 MrCo2e by 2025, and 350-420 MrCo2e by 2030. These emissions are significantly lower than 2016 emission targets and will see South Africa's emissions decline in absolute terms from 2025, a decade earlier than planned (World Resource Institute, 2021).

The IRP (2019) notes that 39 730 MW of new generation capacity must be developed. Of the 39 730 MW determined, about 18 000 MW has been committed to date. This new capacity is made up of 6 422 MW under the REIPPP with a total of 3 876 MW operational on the grid. Under the Eskom build programme, the following capacity has been commissioned: 1 332 MW of Ingula pumped storage, 1 588MW of Medupi, 800 MW of Kusile and 100MW of Sere Wind Farm. In addition, IPPs have commissioned 1 005 MW from two Open Cycle Gas Turbine (OCGT) peaking plants (IRP 2019, page 14).

In terms of IRP (2019) provision has been made for the following new additional capacity by 2030:

- 1 500 MW of coal.
- 2 500 MW of hydro.
- 6 000 MW of solar PV.
- 14 400 MW of wind.
- 1 860 MW of nuclear.
- 2 088 MW for storage.
- 3 000 MW of gas/diesel.
- 4 000 MW from other distributed generation, co-generation, biomass and landfill technologies.

Figure 2.1 provides a summary of the allocations and commitments between the various energy sectors.

	Coal	Coal (Decommissioning)	Nuclear	Hydro	Storage	PV	Wind	CSP	Gas & Diesel	Other (Distributed Generation, CoGen, Biomass, Landfill)	
Current Base	37,149		1 860	2,100	2 912	1 474	1 980	300	3 830	499	
2019	2,155	-2,373					244	300		Allocation to the extent of the short term capacity and energy gap.	
2020	1,433	-557				114	300				
2021	1,433	-1403				300	818				
2022	711	-844			513	400	1,000	1,600			
2023	750	-555				1000	1,600		500		
2024			1,860				1,600		1000		500
2025						1000	1,600				500
2026		-1,219					1,600				500
2027	750	-847					1,600		2000		500
2028		-475				1000	1,600				500
2029		-1,694			1575	1000	1,600			500	
2030		-1,050		2,500		1000	1,600			500	
TOTAL INSTALLED CAPACITY by 2030 (MW)	33,364		1,860	4,600	5,000	8,288	17,742	600	6,380		
% Total Installed Capacity (% of MW)	43		2.36	5.84	6.35	10.52	22.53	0.76	8.1		
% Annual Energy Contribution (% of MWh)	58.8		4.5	8.4	1.2*	6.3	17.8	0.6	1.3		

<ul style="list-style-type: none"> Installed Capacity Committed/Already Contracted Capacity Capacity Decommissioned New Additional Capacity Extension of Koeberg Plant Design Life Includes Distributed Generation Capacity for own use 	<ul style="list-style-type: none"> 2030 Coal Installed Capacity is less capacity decommissioned between years 2020 and 2030. Koeberg power station rated/installed capacity will revert to 1,926MW (original design capacity) following design life extension work. Other/ Distributed generation includes all generation facilities in circumstances in which the facility is operated solely to supply electricity to an end-use customer within the same property with the facility. Short term capacity gap is estimated at 2,000MW.
---	--

Figure 2.1: Summary of energy allocations and commitments based on the 2019 IRP

As indicated above, the changes from the Draft IRP capacity allocations see an increase in solar PV and wind, and a significant decrease in gas and diesel; and new inclusions include nuclear and storage.

In terms of renewable energy, six bidding rounds have been completed for renewable energy projects under the RE IPP Procurement Programme. The most dominant technology in the IRP2019 is renewable energy from wind and solar PV technologies, with wind being identified as the stronger of the two technologies. There is a consistent annual allocation of 1 600 MW for wind technology commencing in the year 2022 up to 2030. The solar PV allocation of 1 000 MWs per year is incremental over the period 2022 to 2030, with no allocation in the years 2024 (being the year the Koeberg nuclear extension is expected to be commissioned) and the years 2026 and 2027 (presumably since 2 000 MW of gas is expected in the year 2027). The IRP 2019 states that although there are annual build limits, in the long run such limits will be reviewed to take into account demand and supply requirements.

2.2.5 National Development Plan

The National Development Plan (NDP) contains a plan aimed at eliminating poverty and reducing inequality by 2030. The NDP identifies 9 key challenges and associated remedial plans. Managing the transition towards a low carbon national economy is identified as one of the 9 key national challenges. Expansion and acceleration of commercial renewable energy is identified as a key intervention strategy.

2.2.6 The New Growth Path Framework

The aim of the New Economic Growth Path Framework is to enhance growth, employment creation and equity. Central to the New Growth Path is a massive investment in infrastructure as a critical driver of jobs across the economy. In this regard, the framework identifies investments in five key areas namely: energy, transport, communication, water, and housing.

The New Growth Path also identifies five other priority areas as part of the programme, through a series of partnerships between the State and the private sector. The Green Economy as one of the five priority areas to create jobs, including expansions in construction and the production of technologies for solar, wind and biofuels. In this regard, clean manufacturing and environmental services are projected to create 300 000 jobs over the next decade.

2.2.7 National Infrastructure Plan

Government adopted a National Infrastructure Plan (NIP) in 2012. The aim of the plan is to transform the economic landscape while simultaneously creating significant numbers of new jobs and strengthening the delivery of basic services. The aim of the NIP is support investments is to improve South Africans' access to healthcare facilities, schools, water, sanitation, housing and electrification. The plan also notes that investment in the construction of ports, roads, railway systems, **electricity plants**, hospitals, schools, and dams will contribute to improved economic growth.

As part of the National Infrastructure Plan, Cabinet established the Presidential Infrastructure Coordinating Committee (PICC). The Committee identified and developed 18 strategic integrated projects (SIPs). The SIPs cover social and economic infrastructure across all nine provinces (with an emphasis on lagging regions) and included three energy SIPs, namely SIP 8, 9 and 10.

- SIP 8: Green energy in support of the South African economy.
- SIP 9: Electricity generation to support socio-economic development.
- SIP 10: Electricity transmission and distribution for all.

The NIP 2050 was gazetted for public comment on 10 August 2021⁴. The first phase of the NIP 2050 focuses on four critical network sectors that provide a platform, namely, energy, freight transport, water, and digital infrastructure. In line with the NDP, the vision for the energy sector is to promote:

- Economic growth and development through adequate investment in energy infrastructure" (generation, transmission, and distribution) and reliable and efficient energy service at competitive rates, while supporting economic growth through job creation by stimulating supply chains.
- Social equity through expanded access to energy at affordable tariffs and through targeted, sustainable subsidies for needy households.
- Environmental sustainability through efforts to reduce pollution, reduce water usage and mitigate the effects of climate change.

The NIP 2050 notes that by 2030, the NDP set a target that more than 90% of the population should enjoy access to grid connected or off-grid electricity by 2030. To

⁴ Gazette No. 44951

realise this vision, South Africa's energy system will be supported by effective policies, institutions, governance systems, regulation and, where appropriate, competitive markets. In terms of energy mix, NIP 2050 notes that coal will contribute significantly less to primary-energy needs in the future, while gas will have an important enabling role, energy supply will be **increasingly dominated by renewable energy resources– especially wind and solar which are least cost and where South Africa has a comparative advantage.**

NIP 2050 also notes that South Africa is a signatory of the Paris Agreement which aims to achieve Net Zero greenhouse gas emissions by 2050. To achieve this will require a shift to a least cost energy path that is increasingly reliant on renewables. For South Africa this is imperative for the following reasons:

- SA cannot afford to overspend while dramatically expanding capacity
- Renewables can be built quickly and in modular form thereby avoiding many of the challenges associated with mega projects.
- Trade partners are expected to increasingly impose border carbon taxes harming SA exports.
- SA will need to commit to emission reductions as a global citizen.

2.2.8 Astronomy Geographic Advantage Act

The purpose of the Act (Act No 21 of 2007) is to preserve the geographic advantage areas that attract investment in astronomy. The entire Northern Cape Province, excluding the Tsantsabane Municipality, has been declared an astronomy advantage area. The Northern Cape optical and radio telescope sites were declared core astronomy advantage areas. The Act allowed for the declaration of the Southern Africa Large Telescope (SALT), Meerkat and Square Kilometre Array (SKA) as astronomy and related scientific endeavours that has to be protected.

2.3 PROVINCIAL AND LOCAL LEVEL POLICY AND PLANNING

2.3.1 Northern Cape Province Provincial Growth and Development Strategy

The Northern Cape Provincial Growth and Development Strategy (NCPGDS) (2004-2014)⁵ identifies poverty reduction as the most significant challenge facing the government and its partners. All other societal challenges that the province faces emanate predominantly from the effects of poverty. The NCPGDS notes that the only effective way to reduce poverty is through long-term sustainable economic growth and development. The sectors where economic growth and development can be promoted include:

- Agriculture and Agro-processing.
- Fishing and Mariculture.
- Mining and mineral processing.
- Transport.
- Manufacturing.
- Tourism.

However, the NCPGDS also notes that economic development in these sectors also requires:

⁵ An updated PGDS has not been prepared.

- Creating opportunities for lifelong learning.
- Improving the skills of the labour force to increase productivity.
- Increasing accessibility to knowledge and information.

The achievement of these primary development objectives depends on the achievement of a number of related objectives that, at a macro-level, describe necessary conditions for growth and development. These are:

- Developing requisite levels of human and social capital.
- Improving the efficiency and effectiveness of governance and other development institutions.
- Enhancing infrastructure for economic growth and social development.

Of specific relevance to the SIA the NCPGDS makes reference to the need to ensure the availability of inexpensive energy. The section notes that in order to promote economic growth in the Northern Cape the availability of electricity to key industrial users at critical localities at rates that enhance the competitiveness of their industries must be ensured. At the same time, the development of new sources of energy through the promotion of the adoption of energy applications that display a synergy with the province's natural resource endowments must be encouraged. In this regard the NCPGDS notes "the development of energy sources such as solar energy, the natural gas fields, bio-fuels, etc., could be some of the means by which new economic opportunity and activity is generated in the Northern Cape". The NCPGDS also highlights the importance of close co-operation between the public and private sectors in order for the economic development potential of the Northern Cape to be realised.

The NCPGDS also highlights the importance of enterprise development and notes that the current level of private sector development and investment in the Northern Cape are low. In addition, the province also lags in the key policy priority areas of Small Micro Medium Enterprises (SMME) Development and Black Economic Empowerment. The proposed SEF therefore has the potential to create opportunities to promote private sector investment and the development of SMMEs in the Northern Cape Province.

In this regard, care will need to be taken to ensure that the proposed development and associated renewable energy facilities do not negatively impact on the region's natural environment. In this regard, the NCPGDS notes that the sustainable utilisation of the natural resource base on which agriculture depends is critical in the Northern Cape with its fragile eco-systems and vulnerability to climatic variation. The document also indicates that due to the province's exceptional natural and cultural attributes, it has the potential to become the preferred adventure and ecotourism destination in South Africa.

2.3.2 Northern Cape Provincial Spatial Development Framework

Northern Cape Provincial Spatial Development Framework (NCSDf) (2012) lists a number of sectoral strategies and plans that are to be read and treated as key components of the Provincial SDF (PSDF). Of these there are a number that are relevant to the proposed SEFs. These include:

- Sectoral Strategy 1: Provincial Growth and Development Strategy of the Provincial Government.
- Sectoral Strategy 2: Comprehensive Growth and Development Programme of the Department of Agriculture, Land Reform and Rural Development.

- Sectoral Strategy 5: Local Economic Development (LED) Strategy of the Department of Economic Development and Tourism.
- Sectoral Strategy 11: SMME Development Strategy of the Department of Economic Development and Tourism.
- Sectoral Strategy 12: Tourism Strategy of the Department of Economic Development and Tourism.
- Sectoral Strategy 19: Provincial renewable energy strategy (to be facilitated by the Department of Economic Development and Tourism).

Section C8.2.3, Energy Objectives, sets out the energy objectives for the Northern Cape Province. The section makes specific reference to renewable energy. Of relevance the objectives listed in 2012 include:

- Promote the development of renewable energy supply schemes. Large-scale renewable energy supply schemes are strategically important for increasing the diversity of domestic energy supplies and avoiding energy imports while minimizing detrimental environmental impacts.
- There is a national electricity supply shortage, and the country is now in a position where it needs to commission additional plants urgently. Consequently, renewable energy projects are a high priority.
- Develop and institute innovative new energy technologies to improve access to reliable, sustainable, and affordable energy services with the objective to realize sustainable economic growth and development. The goals of securing supply, providing energy services, tackling climate change, avoiding air pollution, and reaching sustainable development in the province offer both opportunities and synergies which require joint planning between local and provincial government as well as the private sector.
- Develop and institute energy supply schemes with the aim to contribute to the achievement of the targets set by the White Paper on Renewable Energy (2003). This target relates to the delivery of 10 000 GWh of energy from renewable energy sources (mainly biomass, wind, solar, and small-scale hydro) by 2013⁶.

Section C8.3.3, Energy Policy, sets out the policy guidelines for the development of the energy sector, with specific reference to the renewable energy sector.

- The construction of telecommunication infrastructure must be strictly regulated in terms of the spatial plans and guidelines put forward in the PSDF. They must be carefully placed to avoid visual impacts on landscapes of significant symbolic, aesthetic, cultural or historic value and should blend in with the surrounding environment to the extent possible.
- Renewable energy sources such as wind, solar, thermal, biomass and domestic hydroelectricity are to constitute 25% of the province's energy generation capacity by 2020. The following key policy principles for renewable energy apply:
 - Full cost accounting: Pricing policies will be based on an assessment of the full economic, social and environmental costs and benefits of energy production and utilisation.
 - Equity: There should be equitable access to basic services to meet human needs and ensure human well-being. Each generation has a duty to avoid impairing the ability of future generations to ensure their own well-being.

⁶ Note: The PSDF is dated 2012. The targets for renewable energy have been updated in terms of the 2019 IRP (see above).

- Global and international cooperation and responsibilities: Government recognises its shared responsibility for global and regional issues and act with due regard to the principles contained in relevant policies and applicable regional and international agreements.
- Allocation of functions: Government will allocate functions within the framework of the Constitution to competent institutions and spheres of government that can most effectively achieve the objectives of the energy policy.
- The implementation of sustainable renewable energy is to be promoted through appropriate financial and fiscal instruments.
- An effective legislative system to promote the implementation of renewable energy is to be developed, implemented, and continuously improved.
- Public awareness of the benefits and opportunities of renewable energy must be promoted.
- The development of renewable energy systems is to be harnessed as a mechanism for economic development throughout the province in accordance with the Sustainable Development Initiative (SDI) approach (refer to Toolkit D10) or any comparable approach.
- Renewable energy must, first, and foremost, be used to address the needs of the province before being exported.

2.2.3 Northern Cape Provincial Climate Change Response Strategy

The key aspects of the Provincial Climate Change Response Strategy (PCCRS) are summarised in the MEC's (NCPG: Environment and Nature Conservation) 2011 budget speech: "The Provincial Climate Change Response Strategy will be underpinned by specific critical sector climate change adaptation and mitigation strategies that include the Water, Agriculture and Human Health sectors as the 3 key Adaptation Sectors, the Industry and Transport alongside the Energy sector as the 3 key Mitigation Sectors with the Disaster Management, Natural Resources and Human Society, livelihoods and Services sectors as 3 remaining key Sectors to ensure proactive long term responses to the frequency and intensity of extreme weather events such as flooding and wild fire, with heightened requirements for effective disaster management".

Key points from MEC's address include the NCPG's commitment to develop and implement policy in accord with the National Green Paper for the National Climate Change Response Strategy (2010), and an acknowledgement of the NCP's extreme vulnerability to climate-change driven desertification. The development and promotion of a provincial green economy, including green jobs, is identified as an important provincial intervention in addressing climate change. The renewable energy sector, including solar and wind energy (but also biofuels and energy from waste), is explicitly indicated as an important element of the Provincial Climate Change Response Strategy. The MEC also indicated that the NCP was involved in the processing a number of Wind Energy Facility (WEF) and SEF EIA applications.

2.2.4 Northern Cape Province Green Document

The NCP Green Document (2017-2018) was prepared by the Northern Cape Department of Economic Development and Tourism and provides an impact assessment of IPPs on the communities in the province located within a 50 km radius from existing facilities. The document notes that the NCP is nationally a leader in commercial-scale renewable energy projects. By 2018 a total of 23 IPP

projects in the province had been integrated into the national grid⁷. These projects include Solar PV, Concentrated Solar and WEFs. The document notes that through their economic development obligations these projects have already made a significant positive contribution to affected communities. Much of the effort has been directed at supporting local education. The document also notes that, as these projects are committed to 20-year minimum lifespans and collectively hold a tremendous potential for socio-economic upliftment.

Key issues identified with regard to improving the potential beneficial impact of IPPs in the NCP (as at 2018) include:

- Local community members abusing project benefits for personal gain.
- Difficulty in outreach to local community beneficiaries due to high local illiteracy levels.
- A lack of business skills generally hampers the successful establishment of local small enterprises which could benefit from projects.
- Community benefit obligations are currently met in a piecemeal and uncoordinated fashion.
- Anticipated community benefits are often frustrated by inadequate engagement and insufficient ongoing consultation.
- The scarcity of people skilled in maths and sciences in local communities hampers meaningful higher-level local skills development and employment.
- Insufficient support from local municipalities for IPP development.

2.3.4 Pixley ka Seme District Municipality Integrated Development Plan

The vision for the PKSDM is “Developed and Sustainable District for Future Generations” (2019-2020).

To mission statement that underpins the vision is:

- Supporting our local municipalities to create a home for all in our towns, settlements, and rural areas to render dedicated services.
- Providing political and administrative leadership and direction in the development planning process.
- Promoting economic growth that is shared across and within communities.
- Promoting and enhancing integrated development planning in the operations of our municipalities.
- Aligning development initiatives in the district to the National Development Plan.

The Strategic Objectives to address the vision that are relevant to the project includes the promotion of economic growth in the district and enhance service delivery. Chapter 4, Development of Strategies, highlights the key strategies of the PKSDM. The promotion of economic development is the most relevant strategy for the project. The IDP also notes that the growth and development context in the district has also changed radically since 2013 (after it had been stagnant for decades) owing mainly to private and public investments in the area as a hub for renewable energy generation and astronomy.

The IDP notes that the economy in the Pixley ka Seme municipal area is characterized by:

⁷ This total would be higher in 2022.

- High levels of poverty and low levels of education.
- Low levels of development despite the strategic location in terms of the national transport corridors.
- High rate of unemployment, poverty and social grant dependence.
- Prone to significant environmental changes owing to long-term structural changes (such as climate change, energy crises and other shifts).

Of specific relevance the IDP highlights the potential for renewable energy to help address some of these challenges.

2.3.5 Pixley ka Seme District Municipality Spatial Development Framework

The SDF (2017) notes that the vision for the PKSDM is “Pixley Ka Seme DM, pioneers of development, a home and future for all”. The Mission Statement that underpins the vision refers to:

- Effective and efficient service delivery.
- Optimal human and natural resource development.
- Local economic growth and development, job creation and poverty alleviation.
- A vibrant tourism industry.
- To participate in the fight to reduce the infection rate and lessen the impact of HIV/ Aids and other communicable diseases.
- A safe, secure and community friendly environment.

The SDF identifies the opportunities and constraints associated with the district. The opportunities that are of relevance to the project are discussed below.

Renewable energy and the identification of a renewable energy hub in the region. The natural environment and maintenance and conservation of the pristine natural environment to support sustainable farming into the future is also identified as an opportunity. The SDF notes that Pixley Ka Seme District area with its abundance of sunshine and vast tracts of available land has attracted considerable interest from solar energy investors. The high solar index of the area provides many opportunities in terms of the development of renewable energy. This has been acknowledged by the Northern Cape Government with the identification of the Renewable Energy Hub. Section 5.6.1 of the SDF refers to the establishment of a Renewable Energy Hub stretching from the west coast up to De Aar region (Figure 2.3). A number of special economic development zones are located within the area, including the De Aar (No.6, Figure 2.2). The PKSDM also falls within the Solar Development Corridor as identified in the Northern Cape Provincial Spatial Development Framework. The corridor extends from Kakamas to Upington and down to De Aar in the south-east (Figure 2.3). The proposed project is located within the corridor.

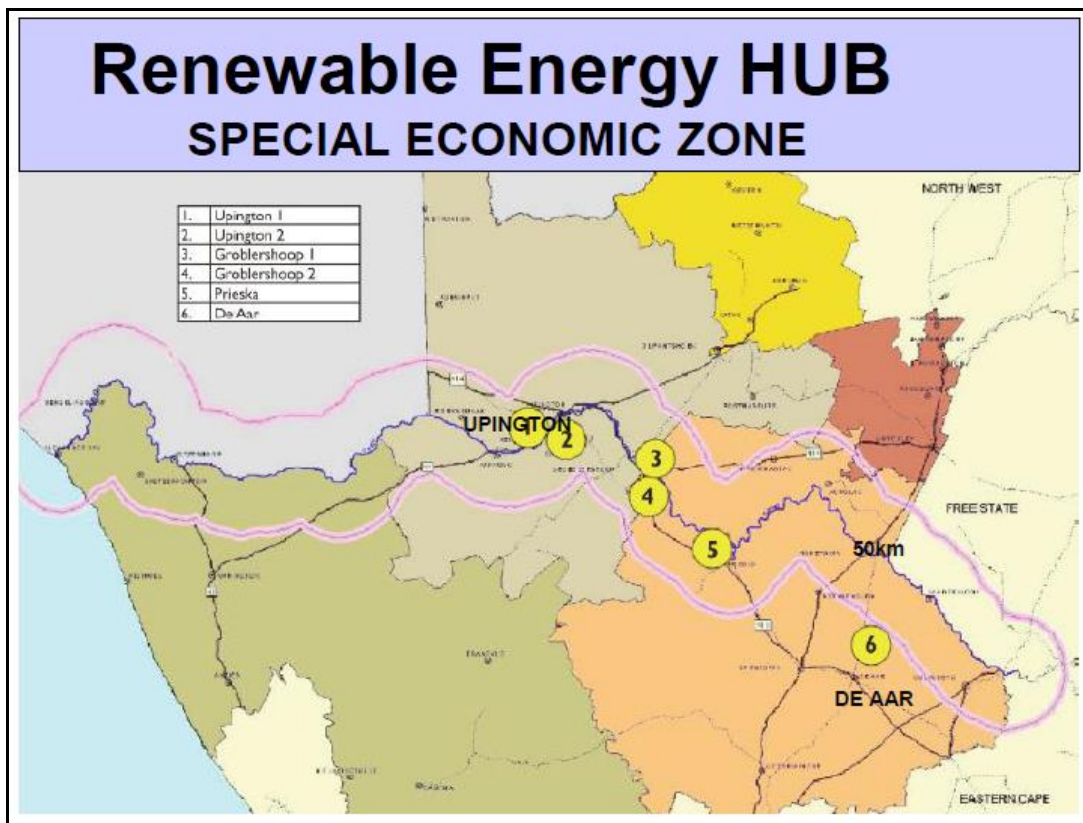

Source: Northern PKSDM SDF

Figure 2.2: Northern Cape Renewable Energy Hub

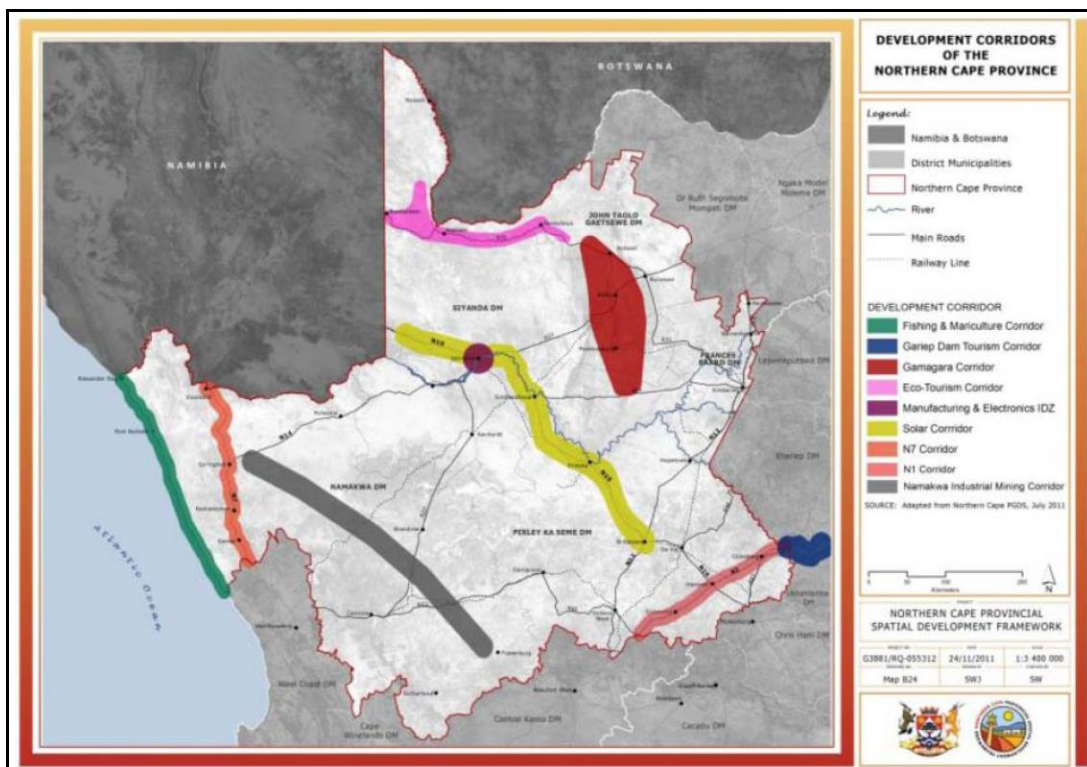

Source: Northern Cape SDF

Figure 2.3: Northern Cape Development Corridors-Solar Corridor (yellow)

The SDF does however also note that the area is known for its clean air and open skies with limited light pollution. Potential visual impacts are therefore an issue that needs to be considered.

In this regard the SDF notes that the topography of Pixley Ka Seme region is one of its main assets with vast open spaces and unspoilt panoramic visual vistas stretching over great distances. This asset makes for excellent scenic drives throughout the whole of the region from the flat plains to crossing the main rivers of South Africa. Visual vistas, ridges and "koppies" are assets within the region and they must be handled with sensitivity.

The relevant constraints include high levels of poverty and unemployment, backlog in basic services, including electricity and housing in rural areas, the limited supply of water and overall scarcity of water in the region to support economic development.

The development challenges that face the Pixley Ka Seme District Municipality include high unemployment and poverty rates and low income which are placing increasing demand on service delivery because very few people are able to pay for services. Declining population numbers, and alcohol and substance abuse are also key challenges.

In terms of services, inadequate schools in farming areas results in children having to travel long distances to areas where they go to school. There are also insufficient health centres and lack of amenities and recreational services. Where these services do exist, they are often poorly managed and maintained. The level of key services, such as refuse removal, are also low, while many rural and a number of urban households rely on boreholes for their water supply.

Climate change is also identified as a key risk. The SDF notes that the Karoo is predicted to experience more drought periods, coupled with increased evaporation and temperatures and this will negatively impact already restricted water supply. It is likely that the greatest impacts will be on water supply.

2.3.6 Renosterberg Local Municipality Integrated Development Plan

As indicated above, a copy of the latest five-year IDP (2017-2021) for the RLM was not available at the time preparing this report. This is likely linked to the dissolution of RLM by the Northern Cape Provincial Government on 7 September 2020⁸. A statement by the Premier of the Northern Cape, Dr, Zamai Saul (7 September 2020) noted that the "Renosterberg Local Municipality has been plagued with political and administrative challenges and failing to fulfil the prescripts of Chapter 7 as enshrined in Section 152 of the Constitution". The statement also notes that the intervention efforts made by the Department of Cooperative Governance, Human Settlements and Traditional Affairs (CoGHSTA), Provincial Treasury and the PKSDM and the respective MECs to monitor and provide support to RLM had not succeeded. The Municipal Council has also failed to implement and support the National Treasury discretionary Financial Recovery Plan that commenced in 2018 and was on-going until November 2019.

⁸ [Premier Zamani Saul: Dissolution of Renosterberg Municipal Council South African Government \(www.gov.za\)](http://www.gov.za)

The information on the RLM is therefore based on the information contained in the Pixley Ka Seme District SDF 2013 - 2018 Sixth Draft May 2014.

The locality of the RLM along the southern bank of the Gariiep (Orange) River provides a sustainable water resource and creates a number of development opportunities in terms of tourism and agriculture. Development opportunities are also supported by close locality of Phillipstown to the N10 and N1 as major transport routes that cross the Pixley District Municipal Area. The municipal area consists of the towns of Petrusville, Phillipstown and Vanderkloof (Figure 2.4). The administrative centre is Petrusville.

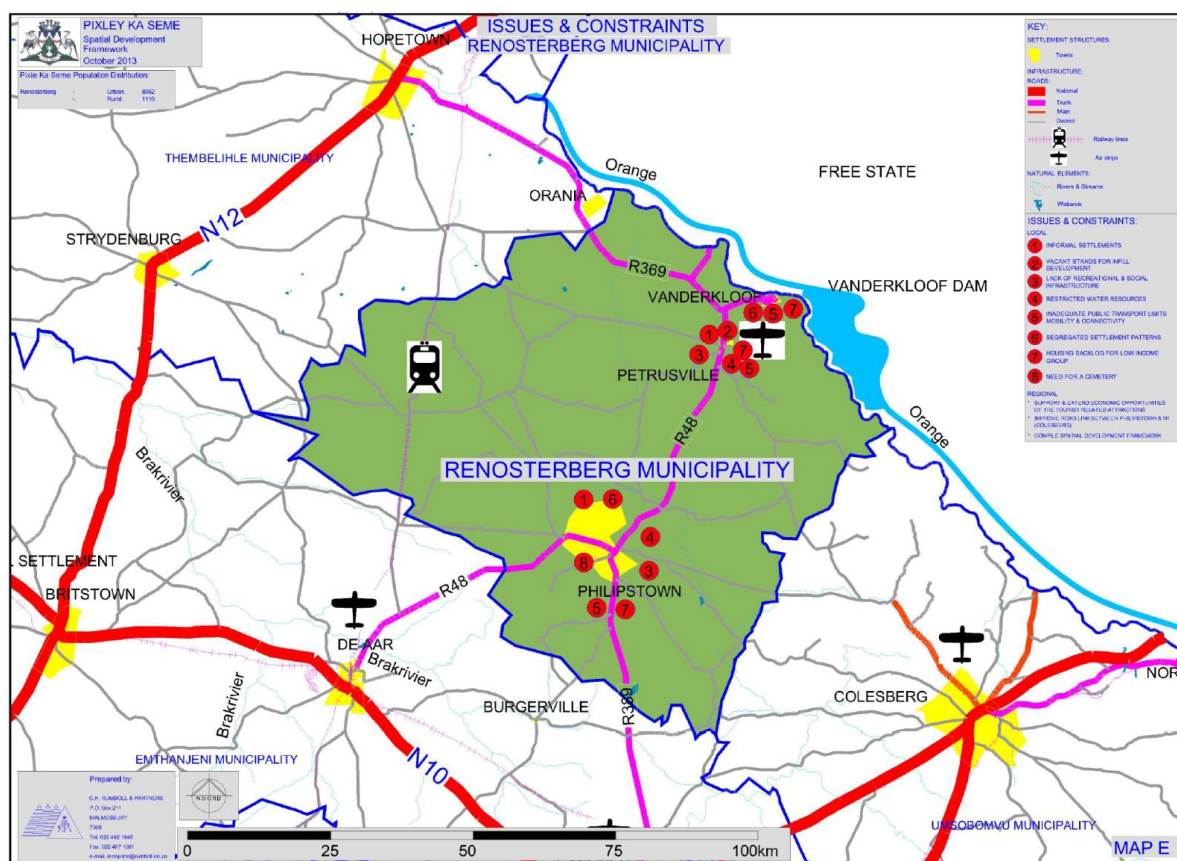

Source: PKSSDF (2017)

Figure 2.4: Renosterberg Local Municipality

The small town of Petrusville is located on the northern part of the of the Renosterberg Municipal area, near the Vanderkloof Dam and functions as a service centre for the surrounding farming areas. The economic opportunities for the town are linked to expanding its role at the areas administrative centre and capitalising on the proximity of the Vanderkloof Dam and the N1 (to the east) and N12 (to the west). The socio-economic challenges include water shortages during the dry months, shortage of lower income housing and lack of recreational and social facilities. The construction of a pipeline from the Vanderkloof Dam has been identified as a solution to address the water issue.

Philipstown is located on the southern section of the Renosterberg Municipal area, to the northeast of De Aar. The economic opportunities for the town are linked to the proximity of the N1 (to the east), N12 (to the west) and N10 (to the south). The socio-economic challenges include high levels of youth unemployment, water

shortages during the dry months, shortage of lower income housing and lack of recreational and social facilities. The construction of a pipeline from the Vanderkloof Dam has been identified as a solution to address the water issue. The tourism potential of the town and surrounding area is linked to farm stays and hunting. There are also a number of San Rock Art sites in the area.

Vanderkloof is located on the southern bank of the Vanderkloof Dam in the northern section of the Renosterberg Municipal area. The main focus of the town is for residential and recreational purposes and the town is a well-established holiday resort town. The tourism potential of the town and the surrounding area are linked to the water sports activities in the Vanderkloof Dam (boating, swimming, fishing etc), and the Vanderkloof and Rolfontein Nature Reserves. The socio-economic challenges include a shortage of lower income housing units.

2.3.7 Emthanjeni Local Municipality Integrated Development Plan

The IDP for the Emthanjeni Local Municipality (ELM) (2019-2021) notes that the municipality borders onto the southern boundary of the Renosterberg Local Municipality (RLM) and is a category B municipality consisting of three towns, namely, De Aar, Britstown and Hanover. The vision of the RLM is "Leading sustainable development for inclusive economic growth". The mission statement linked to the vision is "To create a viable economic development plan that is relevant to the characteristics of the Emthanjeni Municipal area, designed to create and maintain a sound and healthy local economy, drawing upon local strengths and resources". This will be achieved through:

- Strategic partnerships and collaboration.
- Effective stakeholder communications.
- Supporting existing businesses and encourage the expansion and repositioning of desirable commercial and industrial uses.
- To increase the number of farms or agricultural land in the community.

The Integrated Development Plan (IDP) refers to the national economic pillars adopted on the National Framework for Local Economic Development in South Africa which launched in 2014. The pillars are aligned to the main thrusts and opportunities within RLM to ensure an integrated approach for optimal rate of implementation and economic development in the municipality. The five pillars are:

- Pillar 1: Building a Diverse Economic Base.
- Pillar 2: Developing learning and skilful economies.
- Pillar 3: Developing Inclusive Economies.
- Pillar 4: Enterprise Development and Support.
- Pillar 5: Economic Governance and Infrastructure.

Pillars 1, 2, 3 and 4 are relevant to the proposed development.

Pillar 1: Building a Diverse Economic Base

The first pillar focuses on building a diverse economic base and growing the local economy through industrial and sector-specific (e.g., Tourism, Mining, Agriculture, Manufacturing, etc.).

Pillar 2: Developing learning and skilful economies

The IDP notes that addressing the skills gap and improving skills levels is critical to the to the successful implementation of all the other pillars, as increased skills lead to increased opportunities for stimulating local economies.

Pillar 3: Developing Inclusive Economies

Creating decent work and sustainable livelihoods improves the living standards and ensures a dignified existence for individuals.

Pillar 4: Enterprise Development and Support

The IDP highlights the importance of supporting economic development and creating a diverse economic sector. The need to support SMMEs is also noted.

The development of the project will support these pillars, specifically the SED and ED spend linked to the project. The IDP also lists 7 Key Performance Areas (KPA) of which KPA 1: Basic Services and Infrastructure Development, KPA 5: Local Economic Development and KPA 7: Social Development, are relevant to the project.

The IDP highlights the importance to the renewable energy sector and refers to a number of IPP projects located in the RLM and PKSDM.

2.4 OVERVIEW OF THE RENEWABLE ENERGY SECTOR IN SOUTH AFRICA

The section below provides an overview of the potential benefits associated with the renewable energy sector in South Africa. Given that South Africa supports the development of renewable energy at national level, the intention is not to provide a critical review of renewable energy. The focus is therefore on the contribution of renewable energy, specifically in terms of supporting economic development.

The following documents were reviewed:

- Independent Power Producers Procurement Programme (IPPPP): An Overview (December 2021), Department of Energy, National Treasury and DBSA.
- Green Jobs Study (2011), IDC, DBSA Ltd and TIPS.
- Powering the Future: Renewable Energy Roll-out in South Africa (2013), Greenpeace South Africa.
- WWF SA, Renewable Energy Vision 2030, South Africa, 2014.
- Jacqueline M. Borel-Saladin, Ivan N. Turok, (2013). The impact of the green economy on jobs in South Africa), South African Journal of Science, *Volume 109 /Number 9/10, September/October 2013*.
- The potential for local community benefits from wind farms in South Africa, Louise Tait (2012), Master's Thesis, Energy Research Centre University of Cape Town.

2.4.1 Independent Power Producers Procurement Programme (IPPPP): An Overview

The document presents an overview of the Renewable Energy Independent Power Producer Procurement Programme (REIPPPP) undertaken by the Department of Energy, National Treasury, and the Development Bank of South Africa in December 2021. The programme's primary mandate is to secure electrical energy from the private sector for renewable and non-renewable energy sources. With regard to renewables, the programme is designed to reduce the country's reliance on fossil fuels, stimulate an indigenous renewable energy industry and contribute to socio-economic development and environmentally sustainable growth. The IPPPP has been designed not only to procure energy but has also been structured to contribute to the broader national development objectives of job creation, social upliftment and broadening of economic ownership.

The Integrated Resource Plan for electricity (IRP) provides South Africa's long-term plan for electricity generation. It primarily aims to ensure security of electricity

supply, minimise the cost of that supply, limit water usage and reduce greenhouse gas (GHG) emissions, while allowing for policy adjustment in support of broader socio-economic developmental imperatives. The IRP 2019 was promulgated in October 2019 and replaced the IRP 2010 as the country's official electricity infrastructure plan.

It calls for 37 696 MW of new and committed capacity to be added between 2019 and 2030 from a diverse mix of energy sources and technologies as ageing coal plants are decommissioned and the country transitions to a larger share of renewable energy. By 2030, the electricity generation mix is set to comprise of 33 364 MW (42.6%) coal, 17 742 MW (22.7%) wind, 8 288 MW (10.6%) solar photovoltaic (PV), 6 830 MW (8.7%) gas or diesel, 5 000 MW (6.4%) energy storage, 4 600 MW (5.9%) hydro, 1 860 MW (2.4%) nuclear and 600 MW (0.8%) concentrating solar power (CSP). Additionally, a short-term gap of at least 2000 MW is to be filled between 2019 and 2022, thereby further raising new capacity requirements, while distributed or embedded generation for own-use is positioned to add 4 000 MW between 2023 and 2030. The IRP is intended to be frequently updated, which could impact future capacity allocations from various energy sources and technologies.

Energy supply

By the end of December 2021, the REIPPPP had made the following significant impacts.

- 6 323 MW of electricity had been procured from 92 RE Independent Power Producers (IPPs) in BW1-4.
- 5 661 MW of electricity generation capacity from 85 IPP projects has been connected to the national grid.
- 71 073 GWh of energy has been generated by renewable energy sources procured under the REIPPPP since the first project became operational in November 2013.

Renewable energy IPPs have proved to be very reliable. Of the 85 projects that have reached COD, 77 projects have been operational for longer than a year. The energy generated over the past 12-month period for these 77 projects is 14 117 GWh, which is 95% of their annual energy contribution projections (P50) of 14 924 GWh over a 12-month delivery period. Thirty-one (31) of the 77 projects (40%) have individually exceeded their P50 projections.

Comparatively, the following statistics were presented at the REIPPPP Bid Window 6 Bidders Conference on 7 July 2022 by the IPP Office based on data as of March 2022 following seven bid rounds (IPP Office, 2022⁹):

- 92 IPPs have been selected as preferred bidders.
- 6 323 MW of electricity capacity procured.
- 5 826 MW already operational from 87 IPPs.
- 74 805 GWh energy generated by Renewable Energy sources.

Energy costs

⁹ IPP Office (2022). RENEWABLE ENERGY INDEPENDENT POWER PRODUCER PROCUREMENT PROGRAMME (REIPPPP) BID WINDOW 6 BIDDERS' CONFERENCE, 7 JULY 2022 [online]. Accessed July 2022. <https://www.ipp-renewables.co.za/PressCentre/GetPressRelease?fileid=16a21004-f9fd-ec11-9578-2c59e59ac9cd&fileName=BW6%20Bidders%20Conference%20Consolidated.pdf>.

In line with international experience, the price of renewable energy is increasingly cost competitive when compared with conventional power sources. The REIPPPP has effectively captured this global downward trend with prices decreasing in every bid window. Energy procured by the REIPPPP is progressively more cost effective and has approached a point where the wholesale pricing for new coal-and renewable-generated energy intersect.

Through the competitive bidding process, the IPPPP effectively leveraged rapid, global technology developments and price trends, buying clean energy at lower and lower rates with every bid cycle, resulting in SA getting the benefit of renewable energy at some of the lowest tariffs in the world. The price for wind power has dropped by 50% to R0.94/kWh, while solar PV has dropped with 75% to R1.14/kWh between BW1 and BW4. This compares with the industry estimates in April 2020 of R1.45/kWh for Medupi. Considering the on-going delays incompletion, indications are that these costs may even be significantly higher.

Prices contracted under the REIPPPP for all technologies are well below the published REFIT prices. The REIPPPP has effectively translated policy and planning into delivery of clean energy at very competitive prices. As such it is contributing to the national aspirations of secure, affordable energy, lower carbon intensity and a transformed 'green' economy.

Investment

The document notes that the REIPPPP has attracted significant investment in the development of the REIPPs into the country. The total investment (total project costs¹⁰), including interest during construction, of projects under construction and projects in the process of closure is R209.6 billion (this includes total debt and equity of R209 billion, as well as early revenue and VAT facility of R0.5 billion).

The REIPPPP has attracted R42 billion in foreign investment and financing in the seven bid windows (BW1 – BW4). This is almost double the inward FDI attracted into South Africa during 2015 (R22.6 billion). The document notes that the share of foreign investment and equity showed an increase in the most recent bid window (2S2), suggesting that the REIPPPP continued to generate investor confidence despite the poor economic conditions in South Africa in recent years.

Comparatively, based on the information presented at the REIPPPP Bid Window 6 Bidders Conference on 7 July 2022 by the IPP Office (IPP Office, 2022), approximately R209.6 billion investment has been attracted for energy infrastructure in all bid windows; and as of March 2022 an actual R1.9 billion contribution was realised for socio-economic development.

South African citizen shareholding

The importance of retaining local shareholding in IPPs is key condition of the procurement requirements. The RFP notes that bidders are required to have South African Equity Participation of 40% in order to be evaluated. South African (local) equity shareholding across BW1-4 equates to 52% (R31.4 billion) of the total equity shareholding (R61.0 billion) was held by South Africans across BW1 to BW4, 1S2 and 2S2. This equates to substantially more than the 40% requirement. Foreign equity amounts to R29.6 billion and contributes 49% of total equity.

¹⁰ Total project costs means the total capital expenditure to be incurred up to the commercial operations date in the design, construction, development, installation, and or commissioning of the project)

The REIPPPP also contributes to Broad Based Black Economic Empowerment (BBBEE) and the creation of black industrialists. In this regard, Black South Africans own, on average, 34% of projects that have reached financial close (BW1-BW4), which is 4% higher than the 30% target. This includes black people in local communities that have ownership in the IPP projects that operate in or near their communities and represents the majority share of total South African Entity Participation.

On average, black local communities own 9% of projects that have reached financial close. This is well above the 5% target. In addition, an average of 21% shareholding by black people in engineering, procurement, and construction (EPC) contractors has been attained for projects that have reached financial closure. This is higher than 20% target. The shareholding by black people in operating companies of IPPs has averaged 30% (against the targeted 20%) for the 85 projects in operation (i.e. in BW1-4).

The target for shareholding by black people in top management has been set at 40%, with an average 68% achieved to date. The target has therefore been significantly exceeded.

Community shareholding and community trusts

The regulations require a minimum ownership of 2.5% by local communities in IPP projects as a procurement condition. This is to ensure that a substantial portion of the investments has been structured and secured as local community equity. An individual community's dividends earned will depend on the terms of each transaction corresponding with the relevant equity share. To date all shareholding for local communities have been structured through the establishment of community trusts. For projects in BW1 to BW4, qualifying communities will receive R25.5 billion net income over the life of the projects (20 years). The report notes that the bulk of the money will however only start flowing into the communities from 2028 due to repayment obligations in the preceding years (repayment obligations are mostly to development funding institutions). However, despite the delay, this represents a significant injection of capital into mainly rural areas of South Africa. If the net projected income for the first seven bid windows (BW1-BW4) was structured as equal payments overtime, it would represent an annual net income of R1.27 billion per year.

Income to all shareholders only commences with operation of the facility. Revenue generated to date by the 85 operational IPPs amounts to R149.9 billion.

Procurement spend

In addition to the financial investments into the economy and favourable equity structures aimed at supporting BEE, the REIPPPP also targets broader economic and socio-economic investment. This is through procurement spend and local content.

The total projected procurement spend for BW1 to BW4 during the construction phase was R71.1 billion, while the projected operations procurement spend over the 20 years operational life is estimated at 75.2 billion. The combined (construction and operations) procurement value is projected as R146.3 billion of which R92.1 billion has been spent to date. For construction, of the R71.1 billion already spent to date, R71 billion is from the 85 projects which have already been completed. These 85 projects had planned to spend R64.2 billion. The actual procurement construction costs have therefore exceeded the planned costs by 11% for completed projects.

Preferential procurement

The share of procurement that is sourced from Broad Based Black Economic Empowered (BBBEE) suppliers, Qualifying Small Enterprises (QSE), Exempted Micro Enterprises (EME) and women owned vendors are tracked against commitments and targeted percentages. The IA target requirement for BBBEE is 60% of total procurement spend. However, the actual share of procurement spend by IPPs from BBBEE suppliers for construction and operations combined is currently reported as 83%, which is significantly higher than the target of 60%, but also the 71% that had been committed by IPPs. BBBEE, as a share of procurement spend for projects in construction, is also reported as 84% with operations slightly lower at 74%.

The majority of the procurement spend to date has been for construction purposes. Of the R76 billion spent on procurement during construction, R64.3 billion has reportedly been procured from BBBEE suppliers, achieving 84.6% of total procured. Actual BBBEE spend during construction for BW1 and BW2 alone was R25.5 billion, 81% more than the 14.1 billion planned by the IPPs. The R64.3 billion spent on BBBEE during construction is 30% more than the R49.7 billion that had originally been anticipated by all IPPs procured in BW1-4.

Total procurement spend by IPPs from QSE and EMEs has amounted to R28.1 billion (construction and operations) to date, which exceeds commitments by 250% and is 30% of total procurement spend to date (while the required target is 10%). QSE and EME's procurement spend for construction was 31% of construction procurement to date and 26% of operational procurement, exceeding the 10% targets set. QSE and EME share of construction procurement spend totals R23.8 billion, which is 5.4 times the planned spend for construction of R4.4 billion during this procurement phase.

In terms of procurement from women-owned vendors to date, 5% of total construction procurement spend has been from woman-owned vendors (against a targeted 5%), and 6% of operational procurement spend has been realised from woman-owned vendors to date, thereby exceeding the targeted 5%. In terms of construction spend, R 4.1 billion was undertaken by women-owned vendors, which is almost double the R 1.8 billion expected to be spent for the construction of projects that have reached financial close.

The REIPPPP has therefore created significant employment opportunities for black South African citizens and local communities beyond planned targets. This highlights the importance of the programme in terms of employment equity and the creation of more equal societies.

Local Content¹¹

The report notes that the REIPPPP programme represents the country's most comprehensive strategy to date in achieving the transition to a greener economy. Local content minimum thresholds and targets were set higher for each subsequent bid window. The report notes that for a programme of this magnitude, with construction procurement spend alone estimated at R71.1 billion, the result is a substantial stimulus for establishing local manufacturing capacity. The local content strategy has created the required incentives for a number of international technology and component manufactures to establish local manufacturing facilities.

¹¹ Local content is expressed as a % of the total project value and not procurement or total project costs.

The documents notes that for the portfolio as a whole, the expectation would reasonably be for local content spend to fall between 25% and 65% of the total project value (considering the range of targets and minimum requirements). Local content commitments by IPPs amount to R66.3 billion or 45% of total project value (R148.2 billion for all bid windows).

Actual local content spend reported for IPPs that have started construction amounts to R63.3 billion against a corresponding project value (as realised to date) of R127.2 billion. This means that 50% of the project value has been locally procured, exceeding the 45% commitment from IPPs and the thresholds for BW1 – BW4 (25-45%).

To date, the R63.3 billion local content spend reported by active IPPs is already 96% of the R66 billion local content expected. This is with 6 projects still in construction, and 85 of the 91 active projects having reached COD (i.e. 93% of the active portfolio complete). For the 85 projects that have reached COD, local content spend has been R58.72 billion of a committed R58.67 billion, which is 0.1% more than the planned local spend.

Leveraging employment opportunities

To date, a total of 63 291 job years¹² have been created for South African citizens, of which 48 110 job years were in construction and 15 182 in operations. These job years should rise further past the planned target as more projects enter the construction phase. Employment opportunities across BW1-4 are 143% of the planned number during the construction phase (i.e. 33 707 job years), with 6 projects still in construction and employing people. The number of employment opportunities is therefore likely to continue to grow beyond the original expectations. By the end of December 2021, 85 projects had successfully completed construction and moved into operation. These projects created 44 172 job years of employment, compared to the anticipated 30 488. This was 45% more than planned.

The report notes that employment thresholds and targets were consistently exceeded across the entire portfolio. The average share of South African citizens of total South Africa based employees for BW1 – BW4 was 91% during construction (against a target of 80%), while it was 96% during operations for BW1 – BW4 (against a target of 80%). The report notes that the construction phase offers a high number of opportunities over shorter durations, while the operations phase requires fewer people, but over an extended operating period.

To date, 48 110 job years for SA citizens were achieved during construction, which is 43% above the planned 33 707 job years for active projects. These job years are expected to rise further since 6 projects are still in construction.

In terms of benefits for local communities, significantly more people from local communities were employed during construction than was initially planned. For active projects, the expectation for local community participation was 13 284 job years. To date 25 272 job years have been realised (i.e. 90% more than initially planned), with 6 projects still in, or entering, construction. The number of black SA citizens employed during construction also exceeded the planned numbers by 74%.

¹² The equivalent of a full-time employment opportunity for one person for one year

Black South African citizens, youths and rural or local communities have been the major beneficiaries during the construction phases, as they respectively represent 81%, 44% and 48% of total job opportunities created by IPPs to date. However, woman and disabled people could still be significantly empowered as they represent a mere 10% and 0.4% of total jobs created to date, respectively. Nonetheless, the fact that the REIPPPP has raised employment opportunities for black South African citizens and local communities beyond planned targets, indicates the importance of the programme to employment equity and the drive towards more equal societies.

The share of black citizens employed during construction (81%) and the early stages of operations (85%) has significantly exceeded the 50% target and the 30% minimum threshold. Likewise, the share of skilled black citizens (as a percentage of skilled employees) for both construction (71%) and operations (82%) has also exceeded the 30% target and minimum threshold of 18%. The share of local community members as a share of SA-based employees was 48% and 70% for construction and operations respectively – significantly exceeding the minimum threshold of 12% and the target of 20%.

Socio-economic development (SED) contributions

An important focus of the REIPPPP is to ensure that the build programme secures sustainable value for the country and enables local communities to benefit directly from the investments attracted into the area. In this regard, IPPs are required to contribute a percentage of projected revenues accrued over the 20-year project operational life toward SED initiatives. These contributions accrue over the 20-year project operation life and are used to invest in housing and infrastructure as well as healthcare, education, and skills development.

The minimum compliance threshold for SED contributions is 1% of the revenue with 1.5% the targeted level over the 20-year project operational life. For the current portfolio of projects, the average commitment level is 2%, which is 101% higher than the minimum threshold level. To date (across BW1-4) a total contribution of R22.8 billion has been committed to SED initiatives. Assuming an even, annual revenue spread, the average contribution per year would be R1.1 billion. Of the total commitment, R18.5 billion is specifically allocated for local communities where the IPPs operate. With every new IPP on the grid, revenues and the respective SED contributions will increase.

As a percentage of revenue, SED obligations become effective only when operations commence, and revenue is generated. Of the 91 IPPs that have reached financial close (BW1–BW4), 85 are operational. The SED contributions associated with these 85 projects has amounted to R 1.8 billion to date.

In terms of ED and SED spend, education, social welfare, and health care initiatives have a SED focus. SED spend on education has been almost double the expenditure on enterprise development. This is despite enterprise development being a stand-alone commitment category in terms of the IA. This is, in part, due to the fact that some early childhood development programmes have also been incorporated in educational programmes. IPPs have supported 1 388 education institutions with a total of R437 million in contributions, from 2015 to the end of June 2021. A total of 1 276 bursaries, amounting to R210.8 million, have been awarded by 67 IPPs from 2015 until the end of June 2021. The largest portion of the bursaries were awarded to African and Coloured students (97.4%), with women and girls receiving 56.3% of total bursaries. The Northern Cape province benefitted most from the bursaries awarded, with 57.2%, followed by the Eastern Cape (20.2%) and Western Cape

(14.1%). Enterprise development and social welfare are the focus areas that have received the second highest share of the contributions to date.

Enterprise development contributions

The target for IPPs to spend on enterprise development is 0.6% of revenues over the 20-year project operational life. However, for the current portfolio, IPPs have committed an average of 0.63% or 0.03% more than the target. Enterprise development contributions committed for BW1-4, amount to R7.2 billion. Assuming an equal distribution of revenue over the 20-year project operational life, enterprise development contributions would be R358 million per annum. Of the total commitment, R5.6 billion is specifically committed directly within the local communities where the IPPs operate, contributing significantly to local enterprise development. A total contribution of R504.1 million has already been made to the local communities (i.e. 94% of the total R537.9 million enterprise development contributions made to date).

Contribution to cleaner energy and water savings

As part of the global commitment, South Africa is targeting an emissions trajectory that peaks at 34% below a "business as usual" case in 2020, 42% below in 2025 and from 2035 declines in absolute terms. The REIPPPP contributes constructively to economic stability, energy security and environmental sustainability.

The emission reductions for the programme during the preceding 12 months (June 2019-June 2020) is calculated as 15.1 million tonnes CO₂ (MtonCO₂) based on the 14 835 GWh energy that has been generated and supplied to the grid over this period. This represents 75% of the total projected annual emission reductions (20.5 MtonCO₂) achieved with only partial operations. A total of 72.1 Mton CO₂ equivalent reduction has been realised from programme inception to date.

The March 2019 Report also notes that since operation, the IPPs have saved 42.8 million kilolitres of water related to fossil fuel power generation. This saving will have increased with the increase in energy generated by renewable energy since 2019. The REIPPPP therefore contributes significantly towards meeting South Africa's GHG emission targets and, at the same time, supporting energy security, economic stability, and environmental sustainability.

2.4.2 Green Jobs Study

The study notes that South Africa has one of the most carbon-intensive economies in the world, therefore making the greening of the electricity mix a national imperative. Within this context the study notes that the green economy could be an extremely important trigger and lever for enhancing a country's growth potential and redirecting its development trajectory in the 21st century. The attractiveness of wind and solar technologies is not only supported by local conditions, but also by the relatively mature stage of their technological development.

The aim of the Green Jobs study was to provide information on the net direct job creation anticipated to emerge in the formal economy across a wide range of technologies/activities that may be classified as green or contributing to the greening of the economy. The study looked at the employment potential for a number of green sectors, including power generation, over three consecutive timeframes, namely, the short term (2011 – 12), medium term (2013 – 17) and long term (2018 – 25). The analysis attempts to estimate the employment potential associated with: building, construction and installation activities; operations and maintenance services; as well as the possible localisation spin-offs for the manufacturing sector as the domestic production of equipment, parts and components benefits from preferential local procurement.

It is also worth noting that the study only considered direct jobs in the formal economy. Multiplier effects were not taken into account. As a result, the analysis only captures a portion of the potential employment impact of a greening economy. International studies have indicated that there are considerable backward and forward linkages through various value chains of production, as well as of indirect and induced employment effects. The employment figures can therefore be regarded as conservative.

The analysis reveals the potential of an unfolding green economy to lead to the creation of approximately 98 000 new direct jobs, on average, in the short term, almost 255 000 in the medium term and around 462 000 employment opportunities in the formal economy in the long term. The number of jobs linked to the power generation was estimated to be ~ 12 500 in the short term, 57 500 in the medium term and 130 000 in the long term. Power generation jobs therefore account for 28% of the employment opportunities created in the long term. However, the report notes that the contribution made by a progressively expanding green energy generation segment increases from 14% of the total in the short term, or just over 13 500 jobs, to more than 28% in the long term (166 400) (Table 2.3). The study also found that energy generation is expected to become an increasingly important contributor to green job creation over time, as projects are constructed or commissioned.

Table 2.3: Net direct employment potential estimated for the four broad types of activity and their respective segments in the long term, and an indication of the roll-out over the three timeframes

Broad green economy category	Segment	Technology/product	Total net direct employment potential in the long-term	Net direct manufacturing employment potential in the long-term	Total net direct employment potential (ST, MT, LT)	Net direct manufacturing employment potential (ST, MT, LT)	
ENERGY GENERATION	Renewable (non-fuel) electricity	Wind power	Onshore wind power	5 156	2 105	VL, L, M	L, M, H
			Offshore wind power				
		Solar power	Concentrated solar power	3 014	608	N, VL, M	N, VL, M
			Photovoltaic power	13 541	8 463	M, H, H	H, VH, VH
		Marine power	Marine power	197	0	N, N, VL	N, N, N
		Hydro power	Large hydro power	272	111	VL, VL, VL	VL, M, VL
	Micro-/small-hydro power		100	0	VL, VL, VL	N, N, N	
	Fuel-based renewable electricity	Waste-to-energy	Landfills	1 178	180	VL, VL, L	VL, VL, L
			Biomass combustion	37 270	154	VL, H, VH	VL, VL, L
			Anaerobic digestion	1 429	591	VL, VL, L	VL, L, M
			Pyrolysis/Gasification	4 348	2 663	VL, L, M	VL, H, H
			Co-generation	10 789	1 050	L, M, H	M, H, H
	Liquid fuel	Bio-fuels	Bio-ethanol	52 729	6 641	M, H, VH	L, H, VH
			Bio-diesel				
ENERGY GENERATION SUB-TOTAL			130 023	22 566			
ENERGY & RESOURCE EFFICIENCY	Green buildings	Insulation, lighting, windows	7 340	838	L, M, M	L, M, M	
		Solar water heaters	17 621	1 225	L, H, H	L, M, H	
		Rain water harvesting	1 275	181	VL, VL, L	VL, VL, L	
	Transportation	Bus Rapid Transport	41 641	350	VH, VH, VH	H, M, L	
	Industrial	Energy efficient motors	-566	4	VL, VL, VL	VL, VL, VL	
		Mechanical insulation	666	89	VL, VL, VL	VL, VL, VL	
ENERGY & RESOURCE EFFICIENCY SUB-TOTAL			67 977	2 686			
EMMISSIONS AND POLLUTION MITIGATION	Pollution control	Air pollution control	900	166	N, VL, VL	N, L, L	
		Electrical vehicles	11 428	10 642	VL, L, H	N, H, VH	
		Clean stoves	2 783	973	VL, VL, L	VL, L, M	
		Acid mine water treatment	361	0	VL, VL, VL	N, N, N	
	Carbon Capture and Storage		251	0	N, VL, VL	N, N, N	
	Recycling		15 918	9 016	M, H, H	H, VH, VH	
EMMISSIONS AND POLLUTION MITIGATION SUB-TOTAL			31 641	20 797			
NATURAL RESOURCE MANAGEMENT	Biodiversity conservation & eco-system restoration		121 553	0	H, VH, VH	N, N, N	
	Soil & land management		111 373	0	VH, VH, VH	N, N, N	
NATURAL RESOURCE MANAGEMENT SUB-TOTAL			232 926	0			
TOTAL			462 567	46 049			

(Source: Green Jobs Study, 2011)

Notes:

- VH = very high (total employment potential > 20 000 direct jobs; manufacturing employment potential > 3 000 direct jobs);
- H = high (total employment potential > 8 000 but < 20 000; manufacturing employment potential > 1 000 but < 3 000);
- M = medium (total employment potential > 3 000 but < 8 000; manufacturing employment potential > 500 but < 1 000);
- L = low (total employment potential > 1 000 but < 3 000; manufacturing employment potential > 150 but < 500);
- VL = very low (total employment potential > 0 but < 1 000; manufacturing employment potential > 0 but < 150);
- N = negligible/none (total employment potential = 0; manufacturing employment potential = 0).

Of relevance the study also notes that the largest gains are likely to be associated with operations and maintenance (O&M) activities, particularly those involved in the various natural resource management initiatives. In this regard, operations and maintenance employment linked to renewable energy generation plants will also be substantial in the longer term. The employment growth momentum related to building, construction and installation activities peaks in the medium term, largely propelled by mass transportation infrastructure, stabilising thereafter as green building methods become progressively entrenched.

In addition, as projects related to a greening economy are progressively commissioned, the potential for local manufacturing also become increasingly viable. Employment gains in manufacturing are also expected to be relatively more stable than construction activities, since the sector should continue exhibiting growth potential as new and replacement components are produced, as additional markets are penetrated and as new green technologies are introduced. Manufacturing segments with high employment potential in the long term would include suppliers of components for wind and solar farms. The study does note that a shortage of skills in certain professional fields pertinent to renewable energy generation presents a challenge that must be overcome.

The study also identifies a number of advantages associated with renewable energy with a large 'technical' generation potential. In this regard, renewable energy, such as solar and wind, does not emit carbon dioxide (CO₂) in generating electricity and is associated with exceptionally low lifecycle emissions. The construction period for renewable energy projects is much shorter than those of conventional power stations, while an income stream may, in certain instances, be provided to local communities through employment and land rental. The study also notes that the greenhouse gases (GHG) associated with the construction phase are offset within a short period of time compared with the project's lifespan. Renewable power therefore provides an ideal means for reaching emission reduction targets in a relatively easy manner. In addition, and of specific relevance to South Africa, renewable energy source is not dependent on water (as compared to the massive water requirements of conventional power stations), has a limited footprint and therefore does not impact on large tracts of land, poses limited pollution and health risks, specifically when compared to coal and nuclear energy plants.

Of relevance, the study also notes that renewable energy projects in rural areas create an opportunity to benefit the local and regional economy through the creation of jobs and tax revenues.

2.4.3 Powering the Future: Renewable Energy Roll-out in South Africa

The study notes that South Africa has higher CO₂ emissions per GDPppp (2002 figures) from energy and cement production than China or the USA (Letete, T et al, n.d.). Energy accounts for 83% of the total GHG emissions (excluding land use, land use change and forestry) with fuel combustion in the energy industry accounting for 65% of the energy emissions of South Africa (DEA, 2011).

Within a broader context of climate change, coal energy does not only have environmental impacts, it also has socio-economic impacts. Acid mine drainage from abandoned mines in South Africa impacts on water quality and poses the biggest threat to the country's limited water resources. Huge volumes of water are also required to wash coal and cool operating power stations. Eskom uses an estimated 10 000 litres of water per second due to its dependency on coal (Greenpeace, 2012).

The report notes that the concerns relating to whether South Africa can afford renewable energy arise out of the perception that renewable energy (RE) is expensive while fossil and nuclear technologies are cheap. The premise also ignores life cycle costing of the technologies which is favourable to renewable technologies where the sources of fuel are free or cheap.

2.4.4 WWF SA Renewable Energy Vision 2030

In its vision the WWF motivated for a more ambitious plan, suggesting that the IRP should provide for an 11-19% share of electricity capacity by 2030, depending on the country's growth rate over the next fifteen years. The vision is to increase renewable energy at the expense of new coal-fired and nuclear capacity. The report notes that in addition to the obvious environmental benefits of this scenario, it will enable South Africa to add flexibility to energy supply capacity on an on-demand basis.

The report notes that REIPPPP introduced in 2011, has by all accounts been highly successful in quickly and efficiently delivering clean energy to the grid. Increasingly competitive bidding rounds have led to substantial price reductions. In this regard, the study indicates that in three years, wind and solar PV have reached pricing parity with supply from new coal-fired power stations from a levelised cost of electricity (LCOE) perspective.

In bidding window 3 of August 2013, the average tariffs bid for wind and solar PV were R0,66/kWh and R0.88/kWh respectively, well below the recent estimates of R1.05/kWh for supply from the coal-fired Medupi and Kusile power stations (Papapetrou 2014).

The report also notes that the REIPPPP has several contracting rounds for new renewables supply. A robust procurement process, extension of a 20-year sovereign guarantee on the power purchase agreement (PPA) and, especially, ideal solar power conditions, have driven the investment case for RE in South Africa. In this regard, South Africa has been identified as one of the worlds' leading clean energy investment destinations (Figure 2.5).

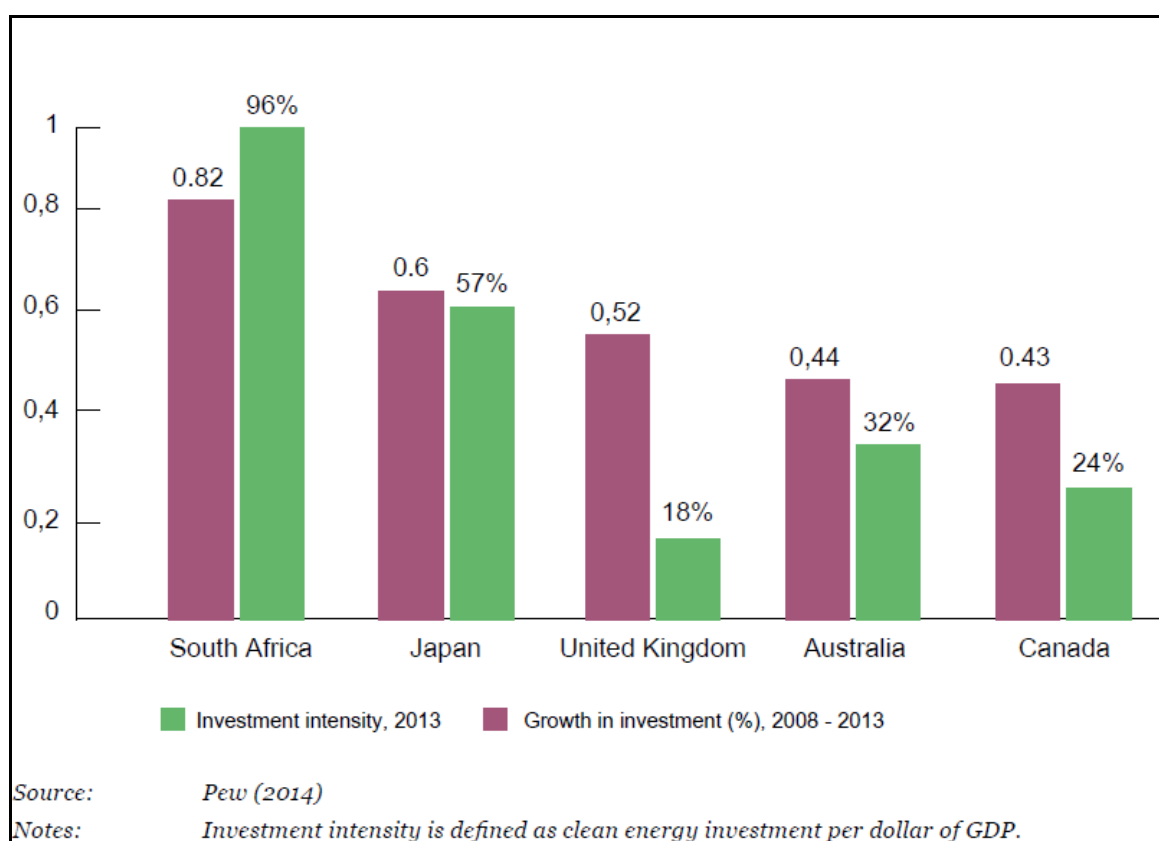

Figure 2.5: South Africa leads as a clean energy investment destination

The WWF study considers a low and high growth renewable energy scenario. The capital requirements for the low growth scenario are estimated at R474 billion over the period 2014-2030 (2014 Rand value), rising to R1.084 trillion in the high-growth scenario, in which 35 GW of capacity is built. Each annual round of purchasing 2 200 MW of RE capacity would cost approximately R77 billion in 2014 Rand value terms. In relative economic terms, this equates to 2% of the GDP per annum or approximately one quarter of Government’s planned annual investment in infrastructure over the medium term. In the low economic growth scenario, which is arguably the more realistic one, the average annual new liability over the period is approximately R40 billion.

The study also points out that infrastructure spend is more beneficial than other government expenditure due to the infrastructure multiplier effect. This refers to the beneficial impact of infrastructure on economic growth in both the short term, resulting from expansion in aggregate demand, as well as in the longer term (six to eight years) due to enhanced productive capacity in the economy. A recent USA study on highway expenditure revealed the infrastructure multiplier to be a factor of two on average, and greater during economic downturns (Leduc & Wilson 2013). This means that one dollar spent on infrastructure raises GDP by two dollars. If the same were to hold true, as similar analysis suggests it would (Kumo 2012, Ngandu et al 2010), this indicates that the construction of renewable energy plants could be a valuable economic growth driver at a time when fears of recession abound.

The report concludes that the WWF is optimistic that South Africa can achieve a much more promising clean energy future than current plans allow for. With an

excellent solar resource and several good wind-producing pockets, the country is an ideal candidate for a renewable energy revolution.

The report indicates that the levelised cost of producing renewable energy already competes favourably with the three main alternatives, namely coal, gas and nuclear. In addition, renewable energy would contribute to a more climate-resilient future and insulate South Africa from dependence on expensive and unreliable fuel sources priced in dollars. Critical from a planning perspective, the report notes that renewable energy can also provide added flexibly on an 'as needed' basis, as electricity demand grows. This is vital in a highly uncertain environment.

2.4.5 The impact of the green economy on jobs in South Africa

The paper notes that greening the economy is particularly important in South Africa for two basic reasons: (1) the exceptional level of unemployment that the country is experiencing and (2) the high carbon impact of the economy.

In terms of employment, the paper refers to the IDC *Green Jobs Report* (2011). In summary, the short-term (next 2 years)¹³ estimate of total net employment potential is 98 000 jobs, and the long-term (next 8 years) employment potential is 462 567 jobs. Natural resource management is predicted to lead to the greatest number of these at 232 926 long-term jobs. Green energy generation is estimated to produce 130 023 long-term jobs, with energy and resource efficiency measures adding another 67 977 long-term jobs.

The paper notes that the Green Jobs Report was prepared by seventeen primary researchers from three prominent organisations, namely the IDC, the Development Bank of South Africa, and Trade and Industrial Policy Strategies. Many role players from other organisations were also consulted, including the World-Wide Fund for Nature, the Green Building Council, the Economic Development Department and private companies involved in green industries.

Despite questions surrounding the employment estimates contained in the Green Jobs Report, green economic activity does appear to generate more local jobs than fossil-fuel-based industries. Some of the estimates also indicate the potential for significant employment. The paper concludes that the figures represent a promising starting point that warrants further research and policy involvement in greening the economy in South Africa.

2.4.6 The potential for local community benefits

In her thesis, Tait¹⁴ notes that the distributed nature of renewable energy generation can induce a more geographically dispersed pattern of development. As a result, RE sites can be highly suited to rural locations with otherwise poor potential to attract local inward investment therefore enabling to target particularly vulnerable areas.

In her conclusion, Tait notes that the thesis has found positive evidence for the establishment of community benefit schemes in the wind sector in South Africa. These benefits would also apply to solar projects. The BBBEE requirements for

¹³ Note, the Green Jobs study was prepared in 2011 and therefore predates the REIPPPP.

¹⁴ The potential for local community benefits from wind farms in South Africa, Louise Tait (2012), Master's Thesis, Energy Research Centre University of Cape Town. Similar benefits are also likely to be associated with solar energy projects.

developers as set out in the DoE's IPPPP for renewables is the primary driver for such schemes. The procurement programme, in keeping with the objective of maximising the economic development potential from this new sector, includes a specific focus on local communities in which wind farms are located.

The procurement programme, typical of all Government tendering processes, includes a BBBEE scorecard on which renewable energy projects are evaluated. However, the renewables scorecard appears to play an important part in a renewed focus on the broad-based Aspects of the legislation, as enforced by a recent national review of the BBBEE Act. In this regard, the renewables scorecard includes specifications for local communities in respect of broad-based ownership schemes, socio-economic development and enterprise development contributions. This approach to legislating social responsibilities of business in all sectors definitely has a South African flavour, borne out of the political history of the country and the imperatives for social transformation laid out in the constitution.

While Tait notes that it is still early days for the development of this sector and one cannot determine the impact that such benefit schemes may have, it is clear though that targeted development expenditure will be directed to multiple rural communities and there seems to be a strong potential to deliver socio-economic benefits.

SECTION 3: OVERVIEW OF STUDY AREA

3.1 INTRODUCTION

Section 3 provides a baseline description of the study area with regard to:

- The administrative context.
- Provincial context.
- Overview of district and local municipalities.
- Site and the surrounding land uses.

3.2 ADMINISTRATIVE CONTEXT

The study area is located within the Renosterberg Local Municipality (RLM), which falls within the Pixley ka Seme District Municipality (PKSDM) in the Northern Cape Province (Figure 3.1). The PKSDM is made up of eight category B local municipalities which include Emthanjeni, Kareeberg, Thembelihle, Renosterberg, Siyathemba, Ubuntu, Siyancuma and Umsobomvu municipalities. De Aar is the administrative seat of the PKSDM. The administrative seat of the RLM is Petrusville.



Source: SA municipalities website

Figure 3.1: Location of the Renosterberg Local Municipality within the Pixley Ka Seme District Municipality

3.3 PROVINCIAL CONTEXT¹⁵

The proposed site located in the Northern Cape Province, which is the largest province in South Africa and covers an area of 361 830 km² and, constitutes approximately 30% of South Africa. The province is divided into five district municipalities (DM), namely, Frances Baard, Karoo, Namakwa, Pixley Ka Seme and ZF Mgcawu District Municipality (known before 1 July 2013 as Siyanda DM). The site itself is located in the Pixley Ka Seme DM.

Population

Despite having the largest surface area, the Northern Cape has the smallest population of 1 193 780 (Community Household Survey, 2016) or 2.2% of the population of South Africa. Of the five districts, Frances Baard has the largest population (32.5%), followed by ZF Mgcawu District Municipality (21.2%), John Taolo Gaetsewe (20.3%), Pixley ka Seme (16.4%) and Namakwa (9.7%). The majority of the population in the Northern Cape Province are Black African (48.1%), followed by Coloureds (43.7%) and Whites (7.7%).

In terms of age, 36.5% of the Northern Cape population is between 15 and 34 years old, which is the highest age distribution, followed by 29.2% of those aged 35–64 years, while only 6.6% comprised those aged 65 years and older. Similarly, this pattern is also seen across all districts in the province. The district profile shows that the highest proportions of persons aged 15–34 years were recorded in Pixley Ka Seme, ZF Mgcawu and John Taolo Gaetsewe districts. The figures for these three districts were also above the provincial average of 36.5%. The proportion of persons aged 65 years and older was higher in Namakwa (9.5%) and Frances Baard (8.2%).

Education

Based on the information contained in the NCPSDF the average adult education attainment levels in the Northern Cape are lower than the adult education attainment levels of South Africa as a whole. Approximately 19.7% of the Northern Cape adults have no schooling in comparison to South Africa's 18.1%. The Northern Cape has the second lowest percentage of adult individuals (5.5%) that obtained a tertiary education in South Africa. The LED Strategy for the Northern Cape indicates that Pixley ka Seme has the lowest adult education attainment levels in the Northern Cape with 27.3% of the adult population having no form of schooling, whilst John Taolo Gaetsewe is second with 25.4% having no schooling. The highest number of the adult population with tertiary education (6.4%) is located in Frances Baard.

The Northern Cape also has the smallest portion (11.1%) of highly skilled formal employees in South Africa, while Gauteng has the highest (14.3%). Linked to this the Northern Cape has the second largest portion of semi and unskilled formal employees in the country. A lack of skilled people often results in both the public and the private sector being unable to implement planned growth strategies and achieve the desired productivity, service delivery and service quality (NCPSDF, 2012).

¹⁵ The information in this section is based on the Northern Cape Provincial Growth and Development Strategy 2004-2014. This document does not include 2011 Census Data. Where possible data from the 2011 Census and 2016 Community Household Survey has been used to update the information.

Economic development

Over the past 8 years there has been little to no variance in the Human Development Index (HDI) figures for the Northern Cape, indicating no increase or decrease in the overall standard of living¹⁶. This trend is unlikely to change in the foreseeable future, mainly due to the marginal economic base of the poorer areas, and the consolidation of the economic base in the relatively better-off areas. It is important to note that the HDI for the Northern Cape (0.55) is substantially below the South African figure of 0.72. The HDI of 0.55 displays a pattern of semi-development, and there is a definite inequality between the different population groups, with the Whites having a higher development lifestyle than the African or Coloured groups.

The percentage of Northern Cape people living below the poverty line has decreased from 40% in 1995 to 27% in 2011, while the poverty gap has decreased from 11% in 1995 to 8% in 2011 (Figure 3.2). The goal set by the province is to decrease the percentage of people living below the poverty line to 20% by 2015 (NCSDF, 2012). The alleviation of poverty is one of the key challenges for economic development. Higher levels of economic growth are a key challenge for poverty eradication. Investment in people is pivotal to the eradication of poverty and inequality. Investment in people is also, to a large extent, about delivering social and economic infrastructure for education, welfare, health, housing, as well as transport and bulk infrastructure.

¹⁶ The Human Development Index (HDI) was developed by the United Nations Development Programme (UNDP) based on the philosophy that the goal of development was to ensure that individuals live long, informed and comfortable lives. The HDI consists of three components: Longevity, which is measured by life expectancy at birth; Educational attainment, which is measured by two education variables, namely adult literacy and combined gross primary, secondary and tertiary enrolment ratio, and; Income, which is measured by gross domestic product (GDP) per capita. Performance in each dimension is expressed as a value between 0 and 1, and the HDI index gives an internationally accepted measure of the wellness (quality of life) of the population of the area under consideration. The closer the HDI is to 1.0, the higher the level of "living condition". For example, Sweden has an index of 0.91 defined as high, South Africa at 0.72 is defined as middle and Lesotho at 0.47 is defined as low.

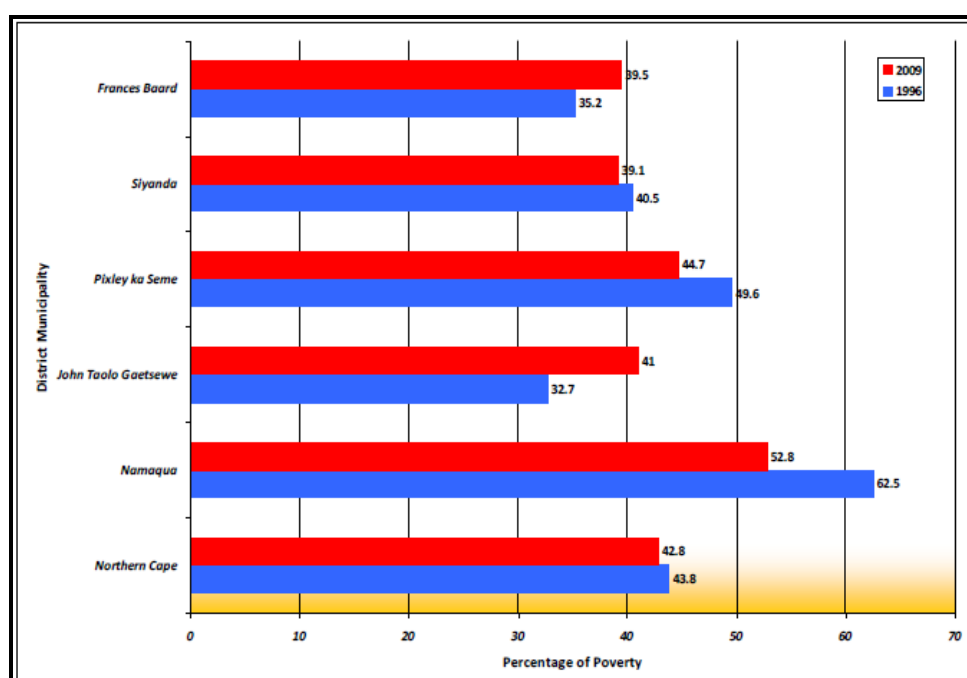

Figure 3.2: Percentage of people living in poverty in the Northern Cape (Source: Global Insight, 2009 as cited in the PGDS, July 2011)¹⁷.

In terms of per capita income, the Northern Cape Province has the third highest per capita income of all nine provinces, however, income distribution is extremely skewed, with a high percentage of the population living in extreme poverty. The measure used in the PGDS document to measure poverty is the percentage of people living below the poverty line or breadline is used¹⁸.

Economic sectors

The Northern Cape economy has shown significant recovery since 2000/2001 when it had a negative economic growth rate of -1.5% (LED Strategy). The provincial economy reached a peak of 3.7% in 2003/2004 and remained the lowest of all provinces. The Northern Cape is the smallest contributing province to South Africa's economy (only 2% to South Africa GDP per region in 2007).

The mining sector is the largest contributor to the provincial GDP, contributing 28.9% to the GDP in 2002 and 27.6% in 2008. The mining sector is also important at a national level. In this regard, the Northern Cape produces approximately 37% of South Africa's diamond output, 44% of its zinc, 70% of its silver, 84% of its iron-ore, 93% of its lead and 99% if its manganese.

Agriculture and agri-processing sectors are also key economic sectors. Approximately 2% of the province is used for crop farming, mainly under irrigation in the Orange River Valley and Vaalharts Irrigation Scheme. Approximately 96% of the land is used for stock farming, including beef cattle and sheep or goats, as well as game farming. The agricultural sector contributed 5.8% to the Northern Cape

¹⁷ Siyanda DM is now called the ZF Mgcawu DM.

¹⁸ In terms of the poverty line, a person is considered poor if his or her consumption or income level falls below some minimum level necessary to meet basic needs. The minimum level is usually called the poverty line. In South Africa the poverty income level is set at R800/month for an individual or R 3 200 per month for a household of four.

GDP per region in 2007 which was approximately R1.3 billion, and it employs approximately 19.5% of the total formally employed individuals (NCSDf, 2012). The sector is experiencing significant growth in value-added activities, including game-farming. Food production and processing for the local and export market is also growing significantly.

The main agricultural produce of the Northern Cape include:

- High-value horticultural products such as table grapes, sultanas and wine grapes, dates, nuts, cotton, fodder, and cereal crops are grown along the Orange River.
- Wheat, fruit, groundnuts, maize, and cotton in the Vaalharts irrigation scheme in the vicinity of Hartswater and Jan Kempdorp.
- Vegetables and cereal crops at the confluence of the Vaal River and the Orange Rivers in the vicinity of Douglas.
- Wool, mohair, karakul, Karoo lamb, ostrich meat and leather, and venison throughout most of the province.

Economic development in the Northern Cape is hampered by the vastness of the area and the remoteness of its communities in rural areas. Development is also hampered by the low education and skills levels in the province. As a result, unemployment in the Northern Cape presents a major challenge.

Employment

According to Statistics South Africa Labour (2012) the community and social services sector is the largest employer in the province at 29%, followed by the agricultural sector (16.5%), wholesale and retail trade (14%), finance (8%), manufacturing (6%) and mining (6%), etc. (Figure 3.3).

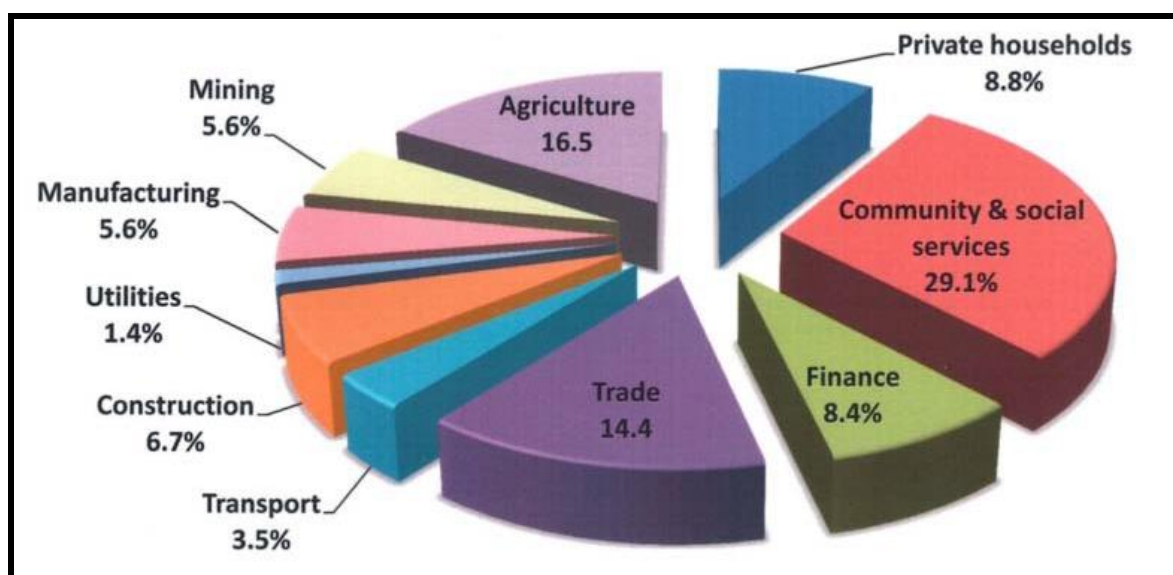

Figure 3.3: Employment by Economic Sector and Industry (Source: Statistics South Africa 2012).

3.4 MUNICIPAL OVERVIEW

Population

The population of the RLM in 2016 was 11 818. The RLM is therefore a sparsely populated municipality. Of this total, 37% were under the age of 18, 56.8% were between 18 and 64, and the remaining 6.1% were 65 and older. The RLM therefore has a relatively large young population. This creates challenges in terms of creating employment opportunities. In terms of race groups, Coloureds made up 57% of the population, followed by Black Africans (32.8%) and Whites (9.8%). The main first language spoken in the RLM was Afrikaans (69.9%), followed by IsiXhosa (26.3%) and Sesotho (1%).

The high percentage of young people in the RLM means that a large percentage of the population is dependent on a smaller productive sector. The dependency ratio is the ratio of non-economically active dependents (usually people younger than 15 or older than 64) to the working age population group (15-64). The higher the dependency ratio the larger the percentage of the population dependent on the economically active age group. This in turn translates reduced revenue for local authorities to meet the growing demand for services. The national dependency ratio in 2011 was 52.7%, similar to that of the Northern Cape Province (55.7%). The dependency ratio for the RLM (2011) was 64%. The traditional approach is based on people younger than 15 or older than 64. The 2016 information provides information for the age group under 18. The total number of people falling within this age group will therefore be higher than the 0-15 age group. However, most people between the age of 15 and 17 are not economically active (i.e., they are likely to be at school).

Using information on people under the age of 18 is therefore likely to represent a more accurate reflection of the dependency ratio. Based on these figures, the dependency ratio for the RLM in 2016 was 75.8%. This figure is significantly higher than the national and provincial levels in 2011 (52.7% and 55.7% respectively). The higher dependency ratio reflects the limited employment opportunities in the area and represent a significant risk to the district and local municipality. The high dependency ratio also highlights the importance to maximising local employment opportunities and the key role played by training and skills development programmes.

Households and house types

Based on the information from the 2016 Community Survey there were a total of 3 563 households in the RLM. Most of the households reside in formal houses (71.4%). The figure for the RLM is lower than the district (78.1%) and Provincial (74.4%) figures. Approximately 14.7% of the households in the RLM reside in shacks and 7.5% in backyard flats. A relatively high percentage of the households therefore live in informal structures.

Based on the information from the 2016 Community Household Survey 34.4% of the households in the RLM are headed by females. The figure for RLM was lower than the District and Provincial figures of 37% and 39% respectively. The high number of female-headed households at the local municipal reflects the lack on formal employment and economic opportunities in the RLM. As a result, job seekers from the RLM need to leave the areas to seek work in the larger centres. The majority of the job seekers are likely to be males. This is due to traditional rural patriarchal societies where the role of the women is usually linked to maintaining

the house and raising the children, while the men tend to be the ones that migrate to other areas in search of employment.

Household income

Based on the data from the 2011 Census, 11.7% of the population of the RLM had no formal income, 3.8% earned less than R4 800, 6.3% earned between R5 000 and R10 000 per annum, 23.8% between R10 000 and R20 000 per annum and 23.4% between R20 000 and R40 000 per annum (2011). The poverty gap indicator produced by the World Bank Development Research Group measures poverty using information from household per capita income/consumption. This indicator illustrates the average shortfall of the total population from the poverty line. This measurement is used to reflect the intensity of poverty, which is based on living on less than R3 200 per month for an average sized household (~ R40 000 per annum). Based on this measure, in the region of 70% of the households in the RLM live close to or below the poverty line. This figure is higher than the provincial level of 62.9%. The low-income levels reflect the limited employment opportunities in the area and dependence on the agricultural sector. This is also reflected in the high unemployment rates.

The low-income levels are a major concern given that an increasing number of individuals and households are likely to be dependent on social grants. The low-income levels also result in reduced spending in the local economy and less tax and rates revenue for the RLM. This in turn impacts on the ability of the RLM to maintain and provide services.

Employment

The official unemployment figure in 2011 for the RLM was 14.3%. The figures also indicate that the majority of the population are not economically active, namely 41.8%. These figures are similar to the official unemployment rate for the Northern Cape Province (14.5%) and Pixley ka Seme District (14.8%). This reflects the limited employment opportunities in the area, which in turn are reflected in the low income and high poverty levels. Unemployment Rate in South Africa averaged 26.32% from 2000 until 2021, reaching an all-time high of 34.90 % in the third quarter of 2021 (StatSA). Even more concerning, the Youth Unemployment Rate in South Africa averaged 54.21% from 2013 until 2021, reaching an all-time high of 64.40 % in the second quarter of 2021. The current rates in the RLM are therefore likely to be significantly higher than the 2011 rates. These rates will also have been exacerbated by the impact of COVID-19 pandemic.

Education

In terms of education levels, the percentage of the population over 20 years of age in the RLM with no schooling was 11.2% in 2011, compared to 7.9% for the Northern Cape Province and 11.9% for the district. The percentage of the population over the age of 20 with matric was 33.6%, which was significantly higher than the provincial and district figures of 29.1% and 25.3% respectively. Only 1.4% and 2% of the population over the age of 20 years in the RLM had an undergraduate and postgraduate qualification, respectively. Despite the higher matric qualification rate, the relatively poor education levels in the RLM pose potential challenge for economic development.

3.5 MUNICIPAL SERVICES

Access to electricity

Based on the information from the 2016 Community Survey 91.6% of households in the RLM had access to electricity. Of this total 65.6% had inhouse prepaid meters and 24.2% have conventional in-house meters.

Access to water

Based on the information from the 2016 Community Survey 91.9% of households were supplied by a regional or local service provider, while 7.5% relied on their own supply, which reflects the rural nature of the municipality. The provincial and district figures for water provided by a service provider were 88.6% and 90.7% respectively.

Sanitation

Based on the information from the 2016 Community Survey, 89.8% of households have access to flush toilets, while 7.4% had not access to access to toilet facilities. The figures in terms of access to flush toilets are higher than provincial (71.4%) and District (82.8%) figures. For Ward 6, 72.7% of households had access to flush toilets and 7.2% had no access to toilets. Approximately 16% relied on pit latrines.

Refuse collection

Based on the information from the 2016 Community Survey, 54.7% of households have their refuse collected on a regular basis by a local authority or private company, while 25.2% relied on communal dumps, 8.1% use their own dumps, and 9.4% are not serviced. The provincial and district figures for refuse collection provided by a service provider on a regular basis were 64.9% and 78.1% respectively. The figures for the RLM are therefore lower that the district and provincial service levels.

3.6 HEALTH AND COMMUNITY FACILITIES

The PKSDM is served by 3 District Hospitals, 8 Community Health Centres, 28 Primary Health Care Clinics, 4 satellite clinics and 1 mobile clinic, distributed over the district. The RLM has 1 District Hospital and 6 Primary Health Care clinics. There are no community health centres within RLM that provide a 24hour service. A new hospital was built in De Aar and was opened in 2017. The Central Karoo Hospital serves as the referral hospital for the district. Minor operations are performed at the facility. Specialists visit the district on a monthly basis from Kimberley Hospital Complex. In terms of education the RLM has 16 schools of which 13 are no-fee schools. The RLM also has libraries.

3.7 ECONOMIC OVERVIEW

Agriculture

Agriculture is the key economic sector in the PKSDM and RLM. Many of the towns within the district municipal area function mainly as agricultural service centres, with the level of services provided at the centres to a large extent reliable on the intensity of the farming practices in the surrounding area. Despite the largely semi-arid and arid environment in the district, the fertile land that lies alongside the Orange, Vaal and Riet Rivers supports the production of some of the country's finest quality agricultural products, including grapes and vegetables. The main livestock farming in the region include cattle, sheep, and goat farming. Game

breeding has also been identified as one of the opportunities which could be linked with the tourism sector for Game reserves and hunting activities. However, despite the key role played by agriculture there is limited value adding to the farming products within the district and the area is prone to droughts and climate change.

Mining

The main deposits in Pixley ka Seme include alluvial diamond mining along the Orange River and various semi-precious stones, such as tiger-eye and zinc deposits. The region also has various saltpans for the potential of salt production. Uranium deposits also occur in the district.

Tourism

The tourism sector in the district contributes 15.6% to the provincial gross value added (GVA). The municipalities Emthanjeni, Kareeberg, Umsobomvu and Siyancuma municipalities are the biggest contributors to the provincial gross value added (GVA). The PKSDM IDP notes that the tourism opportunities in the district will increase due to the Karoo Array Telescope (KAT), a project being driven at a national level. Of relevance, the PKSDM notes that care needs to be taken with developments that have the potential to negatively impact on the Karoo landscapes.

Renewable energy

Of key relevance the PKSDM IDP identifies renewable energy as key economic sector and refers to the substantial socio-economic development (SED) and enterprise development (ED) contributions leveraged by the IPPPP commitments. The IDP notes that the towns of Prieska and Carnarvon have in recent years changed character from small rural towns to potentially regional hubs as a result of investments in renewable energy generation and the Square Kilometre Array (SKA) radio telescope project, respectively.

3.8 OVERVIEW OF STUDY AREA

3.8.1 General context

The Kudu 1 PV project is one of 12 Kudu PV projects being concurrently proposed (separate applications) and is located approximately 27 km¹⁹ northwest and 38 km southeast of the small towns of Philipstown and Petrusville respectively in the south-eastern Northern Cape Province (NCP) (Figure 3.4). Petrusville and Philipstown are the largest towns in the Renosterberg Local Municipality (RLM). De Aar, (Emthanjeni LM) located approximately 50 km to the southwest of the site, is the nearest large town. The nearest higher order service centres are Kimberley (~170 km to the north-northeast) and Bloemfontein (~220 km to the northeast).

¹⁹ All distances linear.

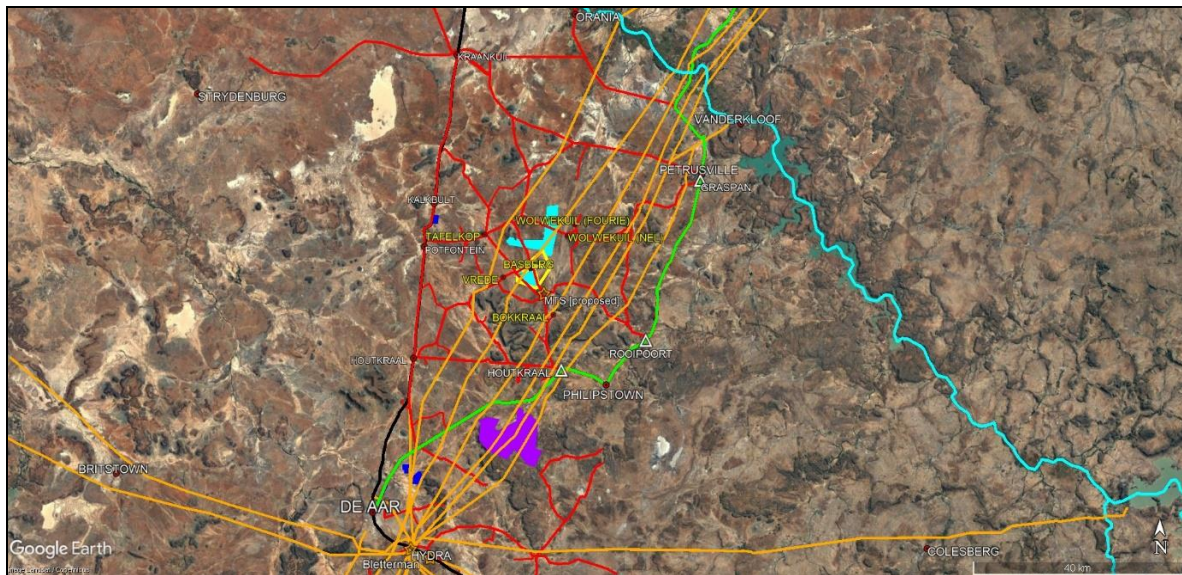

Figure 3.4: Kudu 1 PV site properties (yellow outlines) in relation to other proposed Kudu 1-12 PV sites (light blue fill), settlements, provincial boundaries (light blue lines), existing transmission lines (orange), the R48 (green) and study area gravel road network (red), railway line (black) and operational REFs (dark blue fill).

The study area (approximately 8 150 hectares (ha)) for all the proposed Kudu Solar Facilities is the full extent of the eight affected farm properties on which the proposed PV Facilities are planned to be constructed. These farm properties are listed below, along with the associated Surveyor General (SG) Codes:

- Remaining Extent of the Farm Bas Berg No. 88 (C05700000000008800000).
- Remaining Extent of Portion 3 of the Farm Bas Berg No. 88 (C05700000000008800003).
- Portion 4 (Portion of Portion 3) of the Farm Bas Berg No. 88 (C05700000000008800004).
- Remaining Extent of Portion 2 (Middel Plaats) (a Portion of Portion 1) of the Farm Grasspan No. 40 (C05700000000004000002).
- Remaining Extent of the Farm Annex Wolve Kuil No. 41 (C05700000000004100000).
- Portion 1 (Wolve Kuil West) of the Farm Annex Wolve Kuil No. 41 (C05700000000004100001).
- Portion 2 of the Farm Wolve Kuil No. 43 (C05700000000004300002).
- Remaining Extent of the Farm Wolve Kuilen No. 42 (C05700000000004200000).

Note that the farm names listed above are extracted from the title deeds, and that all reference to these farm portions throughout this report refer to it as such.

The study area is primarily accessed off the R48 via a network of intersecting public gravel roads. The R48 links Petrusville to De Aar via Philipstown. The road currently carries significant ore truck traffic and stretches of the road are in a poor condition. The key intersecting public gravel roads providing access to the study area (from north to south) are the Graspan-, Rooipoort- and Houtkraal Roads (Photograph 3.1). The relevant roads are connected by a network of further gravel roads. Many properties are accessible (albeit via detours) by more than one road.

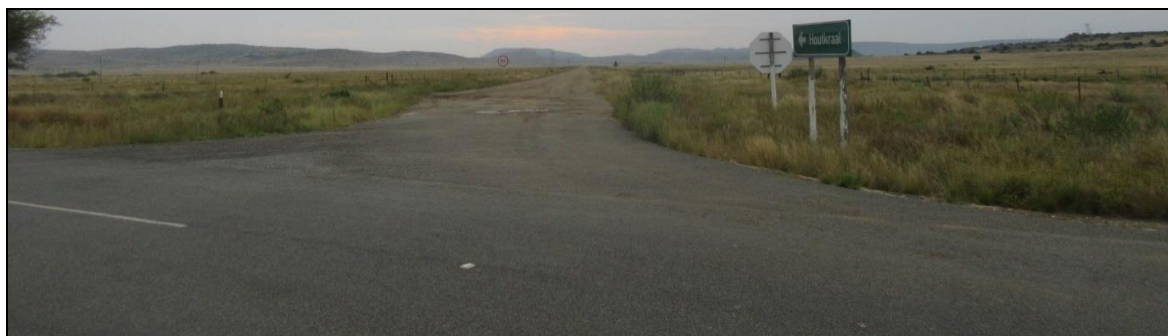

Photograph 3.1: Intersection of R48 (De Aar Road) and Houtkraal public gravel road.

The study area is located on the Great Escarpment in the arid Central Karoo region. Annual rainfall is around 300 mm, and the area is prone to droughts. The landscape is general flat, punctuated by small ranges of koppies and low mountains (Photograph 3.2). The veld consists of karroid scrub on plains and shrubland on the slopes of koppies. The scrub is characterized by the predominance of grasses in good rainfall years, increasing the risk of veld fires. The landscape is essentially treeless, with trees confined to ephemeral drainage courses and farmyards.



Photograph 3.2: Veld on Basberg, Basberg Mountain in the background

The study area properties are used primarily for farming livestock, predominantly sheep (Photograph 3.3). The area is a wool farming area. Carrying capacities are modest, around 3 ha per sheep.²⁰ Most operations rely on networks of boreholes and watering points. No significant cropping activities are associated with the study area, although a few livestock operations grow modest quantities of irrigated fodder for own use. Economic farming units in the study area are large, typically consisting of several properties. Some farmers lease additional land. The study area settlement is consequently sparse, and mainly concentrated on a few base farms, typically near public roads. Labourers typically live on the base properties. Caretaker staff reside on a few secondary properties. Farmsteads and labourers' houses on several properties have become redundant and are no longer inhabited.

²⁰ <https://gis.elsenburg.com/apps/cfm/#>



Photograph 3.3: Sheep grazing on Basberg

Game occurs on most study area properties. Several properties offer annual (winter) hunting opportunities. Trophy hunting in the Petrusville-Philipstown area is currently only associated with mixed livestock operations based on Wolwekuil (42/1), Vlakplaas and Jakkalskuil, none of which are in significant proximity to the PV 1 site. Each of these properties offer accommodation for hunting parties. Jakkalskuil is the only operation primarily focused on international hunters. No safari tourism is associated with any of these three operations. No farm stay accommodation or other tourism is associated with the study area. No protected natural areas are located in or in significant proximity of the study area.

The study area is traversed by a broad northeast-southwest aligned transmission line corridor between Eskom's large Perseus (Dealesville) and Hydra (De Aar) substations. The corridor measures around 25 km in width and accommodates 7 lines in effectively 6 alignments. Most study area landowners are affected by at least one line (Photograph 3.4).



Photograph 3.4: 765 kV line traversing Basberg approximately 500 m west of the farmstead.

3.8.2 Site and adjacent properties

The Kudu 1 PV site is proposed on portions of two properties, namely Bas Berg 88/RE and 88/3 (i.e., Remaining Extent of the Farm Bas Berg No. 88; and Remaining Extent of Portion 3 of the Farm Bas Berg No. 88). The properties of the proposed project site border onto 11 properties (Figure 3.5). Figure 3.5 also illustrates some of the other nearby proposed projects, such as the concurrently proposed Crossroads PV Phase 1 project, which is not the subject of this assessment, and thus outside of this current EIA process for the proposed Kudu Solar Facilities.

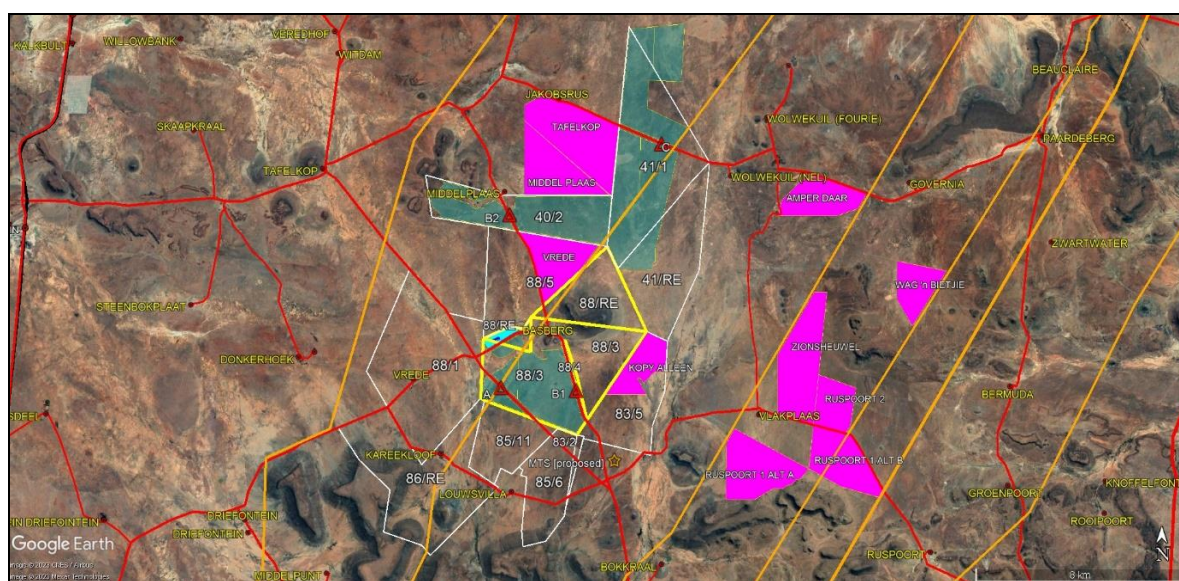

Figure 3.5: Kudu 1 PV site (bold light blue fill), project substation (dark blue fill), and site properties (bold yellow outlines) in relation to adjacent properties (white outlines), proposed Kudu access points (red triangles), other Kudu PV projects (light blue fill), concurrently proposed Crossroads PV Phase 1 sites²¹ (pink fill), existing transmission lines (orange), and the study area existing road network (red).

The site properties as well as adjacent Bas Berg 88/4 are owned by XXXX²² (Table 3.1). The remaining 10 adjacent properties are owned by 4 landowners, namely XXXX, XXXX, XXXX and XXXX - with XXXX accounting for 3 of the properties, and XXXX 5. XXXX is not based in the study area. Her properties have been leased out to XXXX of near-adjacent Bokkraal since 1994. The four adjacent landowners are based on site-adjacent (XXXX, XXXX) or near-adjacent farms (XXXX, XXXX).

²¹ Sites for Crossroads Phases 2 and 3 have not been finalized yet. Only Crossroads Phase 1 is currently being assessed concurrently (separate developers, separate processes) with the Kudu projects. Please refer to Figure 3.7. for an overview of historic, current and envisaged REF projects in the broader study area.

²² Note that the names and surnames of the landowners have been replaced by 'XXXX' in this document in order to comply with the POPI Act.

Table 3.1: Overview of Kudu 1 site property and adjacent properties (site, then clockwise from north)

PROPERTY	OWNER ²³	LAND USE	RES ²⁴ [km]	COMMENT ²⁵
Bas Berg 88/RE	XXXX	Livestock [leased out to XXXX, Bokkraal]	n.a.	1 x 765 kV [existing]; Proposed Kudu 1 and 2 PVs
Bas Berg 88/3			Basberg [1.3; 1.9]	1 x 765 kV [existing]; Proposed Kudu 1-5 PVs
Bas Berg 88/4			n.a.	~31 ha parcel
Grass Pan 40/2	XXXX	Livestock	n.a.	1 x 765 kV [existing]; Proposed Kudu 6 and 7 PVs
Annexe Wolve Kuיל 41/1	XXXX	Livestock	n.a.	1 x 765 kV [existing]; Proposed Kudu 8-11 PVs
Annexe Wolve Kuיל 41/RE	XXXX	Livestock	n.a.	Proposed Kudu 8 PV
Kopy Alleen 83/5	XXXX	Livestock	n.a.	Proposed Kopy Alleen PV (part of the Crossroads PV Development)
Kopy Alleen 83/2	XXXX	Livestock	n.a.	~40 ha parcel
Karee Kloof 85/6		Livestock	n.a.	
Karee Kloof 85/11		Livestock	n.a.	1 x 765 kV [existing]
Swartkoppies 86/RE	XXXX	Livestock	Kareekloof [4.4; 4.6]	1 x 765 kV [existing]
Bas Berg 88/1	XXXX	Livestock	Vrede [3; 3.4]	
Bas Berg 88/5		Livestock	n.a.	1 x 765 kV [existing]; Proposed Vrede PV (part of the Crossroads PV Development)

Of the twelve relevant properties, dwellings are only located on Bas Berg 88/3 (Basberg), Swartkoppies 86/RE (XXXX, Kareekloof), and Bas Berg 88/1 (XXXX, Vrede). The Basberg farmstead is not inhabited but is used by the owner during occasional visits (Photograph 3.5). A caretaker (employee of Bokkraal) and his family reside on Basberg (Photograph 3.6). Kareekloof and Vrede are base farms of larger farming operations (Photograph 3.7).

²³ Shading indicates owner directly affected by either Crossroads PV Phase 1 or ABO Kudu suite projects.

²⁴ Shading indicates inhabited dwellings within 5 km of the PV site and substation, respectively.

²⁵ Shading indicates properties on which REFs are currently proposed.



Photograph 3.5: Uninhabited farmstead and outbuildings on Basberg



Photograph 3.6: Inhabited labourer's dwelling on Basberg



Photograph 3.7: Farm yard on Vrede.

All the site and adjacent properties are used for farming livestock. As indicated above, the XXXX properties are leased to XXXX and farmed as part of his operation based on Bokkraal located approximately midway between the site and the R48 (Houtkraal Road intersection). The XXXX operation provides full-time employment for 18 people and seasonal opportunities to local shearing teams three times a year. No trophy hunting, tourist accommodation or other tourism facilities or activities are associated with any of the site or adjacent properties.

The site properties as well as 5 adjacent ones are currently affected by transmission line infrastructure. Apart from XXXX, all affected landowners are affected by other concurrent PV proposals on one or more of their properties. The site properties are also proposed to accommodate other Kudu PVs, namely PV 2 on Bas Berg 88/RE, and PVs 2-5 on Bas Berg 88/3. Five site-adjacent properties are currently proposed to accommodate other Kudu or Crossroads Phase 1 PV SEFs, namely Grass Pan 40/2 (Kudu 6 and 7 PV), Annexe Wolve Kuil 41/RE (Kudu 8 PV),

Annexe Wolve Kuil 41/1 (Kudu 8-11 PVs) (all three XXXX); Kopy Alleen 83/5 (Kopy Alleen PV, XXXX) and Bas Berg 88/5 (Vrede PV, XXXX).

3.8.3 Relationship to receptors

The site property is used for livestock farming (sheep). The Kudu PV 1 site would occupy approximately 34 ha (1.4%) of the two (~2485 ha) XXXX properties. Cumulatively, Kudu PV1-5 would occupy approximately 762 ha (30.7%) of the XXXX properties. The PV 1-5 sites would occupy level ground with grazing veld. A large portion of the remainder of the properties is occupied by Basberg Mountain. The XXXX properties account for approximately 26% of the XXXX operation's grazing (XXXX, pers. comm).

Inhabited dwellings within 5 km of the site are only located on only three properties, namely the site property Bas Berg 88/3 (Basberg, 1.3 km), and adjacent Vrede (3 km) and Kareekloof (4.4 km). Only one labourer's dwelling is inhabited on Basberg, while Vrede and Kareekloof are base farms. The Vrede PV is proposed on a portion of the larger Vrede property (which is part of the separate proposed Crossroads PV development). Only one receptor (Basberg, 1.9 km) is located within a 3 km of the proposed project substation site. No visually sensitive land uses are located in significant proximity to the site. No accommodation or other tourism facilities are associated with the immediate study area.

The proposed project study area / preferred site can be accessed via various existing main roads and unnamed farm gravel roads. The potential access routes are discussed below and illustrated in Figure 3.6 (note that these are not alternatives in terms of the EIA Process, but only options investigated by the Project Applicant and traffic specialist):

- Access Route Option 1:
 - Route A: Along TR3801, DR3093, and DR3096;
 - Route B: Along TR3801, DR3093 and DR3084;
- Access Route Option 2 (Figure 2.10):
 - Route A: Along MR790, DR3093 and DR3084;
 - Route B: Along MR790 and DR3093;
 - Route C: Along MR790, DR3093 and DR3096;
- Access Route Option 3:
 - Route A: Along TR3801, TR3802, and DR3096;
 - Route B: Along TR3801, TR3802, DR3096 and DR3093; and
 - Route C: Along TR3801, TR3802, DR3096, DR3093 and DR3084.

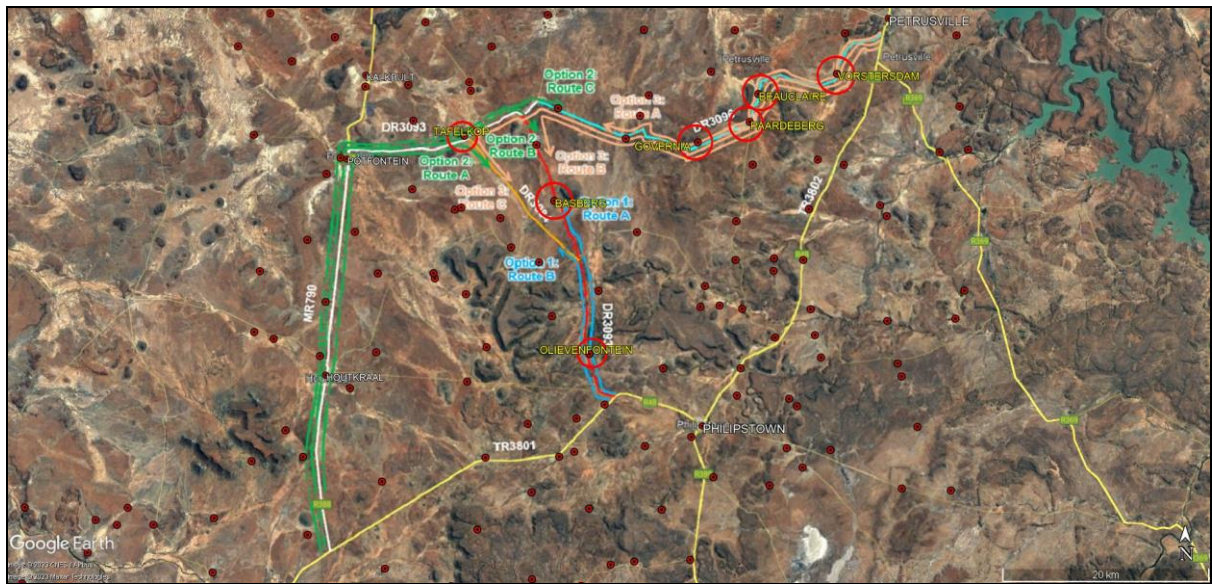

Figure 3.6: Access Route Options (Source: Traffic Impact Assessment for the proposed Kudu Solar Facilities, Sturgeon Consulting, 2023). Red dots indicate dwellings recorded on the relevant 1: 50 000 map rasters; red circles indicate inhabited dwellings <500 m of the road.

Inhabited farmyards located within 500 m of proposed routes are associated with Option 2 A and B (Tafelkop) and Option 3 A and 3 B (Vorstersdam, Beauclaire, Paardeberg, Gouvernia and Wolwekuil 42/RE). With the exception of Gouvernia and Wolwekuil 42/RE, inhabited dwellings on the relevant properties are located within 100 m of the roads. Option 1 would be located within 500 m of inhabited caretaker labourer’s dwellings on Olievenfontein (1A and 1B) and Basberg (1A). The farmsteads on the properties are however not inhabited.

3.8.4 Other renewable energy facilities

The Kudu 1 PV site is not located within a Renewable Energy Development Zone (REDZ). The DFF&E’s Renewable Energy website indicates historic clustering around and north of De Aar. Historic proposals within a 30 km radius of the centre of the PV site are also concentrated around Kalkbult along the De Aar-Kimberley railway line to the NW of the site, and to the south of Philipstown SE of the site (Figure 3.7).

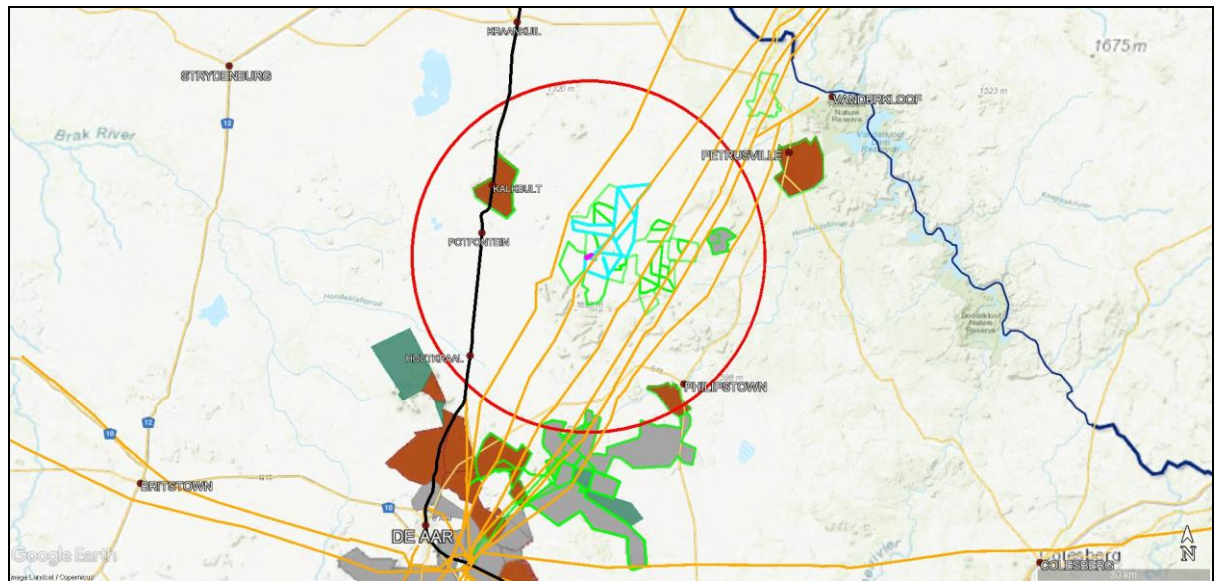

Figure 3.7: Historic REF applications within a 30 km radius (red circle) of the centre of the Kudu 1 PV site (pink outline). Also indicated are the Kudu PV project site properties (light blue); other historic, current and envisaged REF projects (affected property outlines, green); the De Aar-Kimberley railway line (black), and existing transmission lines (orange) (Source: DFFE, CSIR).

Only three operational REFs are located within this 30 km radius, namely the Kalkbult PV SEF adjacent to the railway line approximately 17.5 km NW of the site, and the Long Yuan/ De Aar Phase 1 and Phase 2 WEFs approximately 25 km to the south of the site. The De Aar WEF is located on elevated terrain. Aviation lights are visible at night on most of the R48 between Petrusville and De Aar. As indicated, the Kudu 1 PV project is one of 12 Kudu PV projects currently proposed in the Petrusville-Philipstown area west of the R48. Figure 3.7 reflects REF projects of varying status. Key active projects in the immediate study area include Crossroads Phases 1-3 PV. As indicated, Crossroads Energy is concurrently proposing 9 PV projects in the study area (Crossroads Phase 1 PV). Two more Crossroads Phases (not yet in assessment stage) are envisaged by the relevant developer.

SECTION 4: OVERVIEW OF KEY SOCIAL ISSUES

4.1 INTRODUCTION

Section 4 provides an assessment of the key social issues identified during the study. The identification of key issues was based on:

- Review of project related information.
- Review of key policy and planning documents.
- Site visit to the study area.
- Interviews with key stakeholders.
- Experience with similar projects.

The assessment section is divided into the following sections:

- Assessment of compatibility with relevant policy and planning context ("planning fit").
- Assessment of social issues associated with the construction phase.
- Assessment of social issues associated with the operation phase.
- Assessment of decommissioning phase.
- Assessment of the "no development" alternative.
- Assessment of cumulative impacts.

From a stakeholder engagement perspective, comments related to socio-economic impacts associated with the proposed project were raised by Interested and Affected Parties during the review period of the Draft EIA Report. These comments are similar to those submitted and considered during the Scoping Phase, and therefore similar responses apply (as captured in Appendix F.11 of the Final EIA Report). Concerns were raised about the potential benefits that the proposed Kudu Solar Facilities will have on the farming community in the surrounding region (Benefits to the Farming Community); queries on the socio-economic benefits of the development for farmers and their employees in the greater region, as well as the equitability of involving only two landowners in the proposed developments; not distributing the benefits compared to other proposed projects; cognisance of the perceived negative realities of the project to the social and socio-economic impact and challenges of the Bo-Karoo and its inhabitants; and loss of grazing land. Responses have been provided in Appendix H.7 of the Final EIA Report.

4.2 ASSESSMENT OF POLICY AND PLANNING FIT

The development of and investment in renewable energy is supported by the National Development Plan (NDP), New Growth Path Framework and National Infrastructure Plan, which all refer to and support renewable energy. The PKSDM Spatial Development Framework (SDF) and Integrated Development Plan (IDP) also support the development of renewable energy. The development of the proposed SEF is therefore supported by key policy and planning documents.

4.3 CONSTRUCTION PHASE SOCIO-ECONOMIC IMPACTS

Potential positive impacts

- Creation of employment and business opportunities, and opportunity for skills development and on-site training.

Potential negative impacts

- Impacts associated with the presence of construction workers on local communities.
- Impacts related to the potential influx of job-seekers.
- Increased risks to livestock and farming infrastructure associated with the construction related activities and presence of construction workers on the site.
- Increased risk of grass fires associated with construction related activities.
- Nuisance impacts, such as noise, dust, and safety, associated with construction related activities and vehicles.
- Impact on productive farmland.

4.3.1 Creation of local employment, skills development, training, and business opportunities

The construction phase will extend over a period of approximately 12 to 18 months and create in the region of 150 employment opportunities. Members from the local communities in the area, specifically De Aar, would be in a position to qualify for most of the low skilled and semi-skilled employment opportunities. Most of these employment opportunities will accrue to Historically Disadvantaged (HD) members of the community. Based on information from similar projects the total wage bill will be in the region of R 30 million (2023 Rand values). A percentage of the wage bill will be spent in the local economy which will also create opportunities for local businesses in the local towns in the area.

Given relatively high local unemployment levels and limited job opportunities in the area, this will represent a significant, if localised, social benefit. The capital expenditure associated with the construction phase will be approximately R 1.5 to 2 billion (2023 Rand value).

Due the lack of diversification in the local economy the potential for local companies is likely to be limited. The majority of benefits are therefore likely to accrue to contractors and engineering companies based outside the RLM and ELM. The local service sector will also benefit from the construction phase. The potential opportunities would be linked to accommodation, catering, cleaning, transport, and security, etc. associated with the construction workers on the site.

The hospitality industry in the area will also benefit from the provision of accommodation and meals for professionals (engineers, quantity surveyors, project managers, product representatives etc.) and other (non-construction) personnel involved on the project. Experience from other construction projects indicates that the potential opportunities are not limited to on-site construction workers but also to consultants and product representatives associated with the project.

Table 4.1: Impact assessment of employment and business creation opportunities during the construction phase

Nature: Creation of employment and business opportunities during the construction phase				
Impact Criteria		Significance Without Enhancement	Significance With Enhancement	Confidence
Status	Positive	Low	Moderate	High
Spatial Extent	Regional			
Duration	Medium Term			
Consequence	Moderate			
Probability	Likely			
Reversibility	N/A			
Irreplaceability	N/A			
Can impact be enhanced?	Yes			
<p>Enhancement:</p> <p>Employment</p> <ul style="list-style-type: none"> Preparation and implementation of a Stakeholder Engagement Plan (SEP) prior to and during the construction phase. Where reasonable and practical, the proponent should appoint local contractors and implement a 'locals first' policy, especially for semi and low-skilled job categories. However, due to the low skills levels in the area, the majority of skilled posts are likely to be filled by people from outside the area. Where feasible, efforts should be made to employ local contractors that are compliant with Broad Based Black Economic Empowerment (BBBEE) criteria. Before the construction phase commences the proponent should meet with representatives from the RLM and ELM to establish the existence of a skills database for the area. If such as database exists, it should be made available to the contractors appointed for the construction phase. The local authorities, community representatives, and organisations on the interested and affected party database should be informed of the final decision regarding the project and the potential job opportunities for locals and the employment procedures that the proponent intends following for the construction phase of the project. Where feasible, training and skills development programmes for locals should be initiated prior to the initiation of the construction phase. The recruitment selection process should seek to promote gender equality and the employment of women wherever possible. <p>Business</p> <ul style="list-style-type: none"> The proponent should liaise with the RLM and ELM with regards the establishment of a database of local companies, specifically BBBEE companies, which qualify as potential service providers (e.g., construction companies, catering companies, waste collection companies, security companies etc.) prior to the commencement of the tender process for construction service providers. These companies should be notified of the tender process and invited to bid for project-related work. <p>Note that while preference to local employees and companies is recommended, it is recognised that a competitive tender process may not guarantee the employment of local labour for the construction phase.</p>				

Assessment of No-Go option:

There is no impact as the current status quo would be maintained.

4.3.2 Impact of construction workers on local communities

The presence of construction workers poses a potential risk to family structures and social networks. While the presence of construction workers does not in itself constitute a social impact, the manner in which construction workers conduct themselves can impact on local communities. The most significant negative impact is associated with the disruption of existing family structures and social networks. This risk is linked to potentially risky behaviour, mainly of male construction workers, including:

- An increase in alcohol and drug use.
- An increase in crime levels.
- The loss of girlfriends and/or wives to construction workers.
- An increase in teenage and unwanted pregnancies.
- An increase in prostitution.
- An increase in sexually transmitted diseases (STDs), including HIV.

The objective will be to source as many of the low and semi-skilled workers locally. These workers will be from the local community and form part of the local family and social networks. This will reduce the risk and mitigate the potential impacts on the local community. However, based on experience with renewable energy projects in the area the potential for local employment, specifically for semi- and skilled workers, is likely to be limited. The majority of semi and skilled workers will therefore need to be accommodated in the nearby towns of Philipstown, Petrusville and De Aar.

The total number of construction workers employed, and duration of the construction phase will depend on the timing and phasing of the construction of the Kudu PV SEF Cluster. This will have a bearing on the potential impact on local communities and services. This issue is discussed under cumulative impacts. The assessment below relates to a single PV SEF.

While the risks associated with construction workers at a community level will be low, at an individual and family level they may be significant, especially in the case of contracting a sexually transmitted disease or an unplanned pregnancy. However, given the nature of construction projects, it is not possible to totally avoid these potential impacts at an individual or family level.

Table 4.2: Assessment of impact of the presence of construction workers in the area on local communities

Nature: Potential impacts on family structures and social networks associated with the presence of construction workers				
Impact Criteria		Significance Without Enhancement	Significance With Enhancement	Confidence
Status	Negative	Very Low	Very Low	High
Spatial Extent	Regional			
Duration	Medium Term			
Consequence	Slight			
Probability	Unlikely			
Reversibility	Moderate			

Irreplaceability	Low		
Can impact be mitigated?	Yes		
Mitigation:			
<ul style="list-style-type: none"> • Preparation and implementation of a Stakeholder Engagement Plan (SEP) prior to and during the construction phase. • Preparation and implementation of a Community Health, Safety and Security Plan (CHSSP) prior to and during the construction phase. • The SEP and CHSSP should include a Grievance Mechanism that enables stakeholders to report resolve incidents. • Where possible, the proponent should make it a requirement for contractors to implement a 'locals first' policy for construction jobs, specifically for semi and low-skilled job categories. • The proponent should consider the option of establishing a Monitoring Committee (MC) for the construction phase that include representatives from local landowners, farming associations, and the local municipality. This MC should be established prior to commencement of the construction phase and form part of the SEP. • The proponent and contractor should develop a Code of Conduct (CoC) for construction workers. The code should identify which types of behaviour and activities are not acceptable. Construction workers in breach of the code should be subject to appropriate disciplinary action and/or dismissed. All dismissals must comply with the South African labour legislation. The CoC should be signed by the proponent and the contractors before the contractors move onto site. The CoC should form part of the CHSSP. • The proponent and the contractor should implement an HIV/AIDS, COVID-19 and Tuberculosis (TB) awareness programme for all construction workers at the outset of the construction phase. The programmes should form part of the CHSSP. • The contractor should provide transport for workers to and from the site on a daily basis. This will enable the contractor to effectively manage and monitor the movement of construction workers on and off the site. • The contractor must ensure that all construction workers from outside the area are transported back to their place of residence within 2 days for their contract coming to an end. • No construction workers, except for security personnel, should be permitted to stay over-night on the site. 			

Assessment of No-Go option

There is no impact as the current status quo would be maintained.

4.3.3 Influx of job seekers

Large construction projects tend to attract people to the area in the hope that they will secure a job, even if it is a temporary job. These job seekers can in turn become "economically stranded" in the area or decide to stay on irrespective of finding a job or not. While the proposed project on its own does not constitute a large construction project, the establishment of a number of renewable energy projects in the area may attract job seekers to the area. As in the case of construction workers employed on the project, the actual presence of job seekers in the area does not in itself constitute a social impact. However, the way in which they conduct themselves can impact on the local community. The main areas of concern associated with the influx of job seekers include:

- Impacts on existing social networks and community structures.
- Competition for housing, specifically low-cost housing.
- Competition for scarce jobs.
- Increase in incidences of crime.

These issues are similar to the concerns associated with the presence of construction workers and are discussed in Section 4.3.2. The potential for

economically motivated in-migration and subsequent labour stranding is likely to be negligible. This is due to the isolated location of the area and the limited economic and employment opportunities in the nearby towns of Philipstown, Petrusville and De Aar.

The potential for an influx of job seekers may also be affected by the timing and phasing of the timing and phasing of the construction of the Kudu PV SEF Cluster. This issue is discussed under cumulative impacts. The assessment below relates to a single PV SEF.

Table 4.3: Assessment of impact of job seekers on local communities

Nature: Potential impacts on family structures, social networks and community services associated with the influx of job seekers					
Impact Criteria		Significance Without Enhancement	Significance With Enhancement	Confidence	
Status	Negative	Very Low	Very Low	High	
Spatial Extent	Regional				
Duration	Medium Term				
Consequence	Slight				
Probability	Unlikely				
Reversibility	Moderate				
Irreplaceability	Low				
Can impact be mitigated?	Yes				
Mitigation:					
<ul style="list-style-type: none"> • Preparation and implementation of a Stakeholder Engagement Plan (SEP) prior to and during the construction phase. • Preparation and implementation of a Community Health, Safety and Security Plan (CHSSP) prior to and during the construction phase. • The proponent, in consultation with the LM, should investigate the option of establishing a Monitoring Committee (MC) to monitor and identify potential problems that may arise due to the influx of job seekers to the area. • The proponent should implement a "locals first" policy, specifically with regard to unskilled and low skilled opportunities. • The proponent should implement a policy that no employment will be available at the gate. 					

Assessment of No-Go option

There is no impact as the current status quo would be maintained.

4.3.4 Risk to safety, livestock, and farm infrastructure

The presence on and movement of construction workers on and off the site poses a potential safety threat to local farmers and farm workers in the vicinity of the site. In addition, farm infrastructure, such as fences and gates, may be damaged and stock losses may also result from gates being left open and/or fences being damaged, or stock theft linked either directly or indirectly to the presence of construction workers on the site. The potential risk to farmers and farming operations was identified as an issue by local landowners interviewed.

The potential risks (safety, livestock, and farm infrastructure) can be effectively mitigated by careful planning and managing the movement of construction workers on and off the site during the construction phase.

Table 4.4: Assessment of risk to safety, livestock, and damage to farm infrastructure

Nature: Potential risk to farmers and farm workers, livestock and damage to farm infrastructure associated with the presence and activities of construction workers on site				
Impact Criteria		Significance Without Mitigation	Significance With Mitigation	Confidence
Status	Negative	Moderate	Low	High
Spatial Extent	Local			
Duration	Medium Term			
Consequence	Substantial			
Probability	Unlikely			
Reversibility	High			
Irreplaceability	Replaceable			
Can impact be mitigated?	Yes			
Mitigation:				
<ul style="list-style-type: none"> • Preparation and implementation of a Stakeholder Engagement Plan (SEP) prior to and during the construction phase. • Preparation and implementation of a Community Health, Safety and Security Plan (CHSSP) prior to and during the construction phase. • The proponent should enter into an agreement with the local farmers in the area whereby damages to farm property as a result of the construction phase will be compensated for. The agreement should be signed before the construction phase commences. • All farm gates must be closed after passing through. • Contractors appointed by the proponent should provide daily transport for low and semi-skilled workers to and from the site. • The proponent should establish a MC and CoC for workers (see above). • The proponent should hold contractors liable for compensating farmers and communities in full for any stock losses and/or damage to farm infrastructure that can be linked to project construction workers. This should be contained in the CoC to be signed between the proponent, the contractors, and neighbouring landowners. The agreement should also cover losses and costs associated with fires caused by construction workers or construction related activities (see below). • The proponent should implement a Grievance Mechanism that provides local farmers with an effective and efficient mechanism to address issues related to damage to farm infrastructure, stock theft and poaching etc. • The Environmental Management Programme (EMPr) must outline procedures for managing and storing waste on site, specifically plastic waste that poses a threat to livestock if ingested. • Contractors appointed by the proponent must ensure that all workers are informed at the outset of the construction phase of the conditions contained in the CoC, specifically consequences of stock theft and trespassing on adjacent farms. • Contractors appointed by the proponent must ensure that construction workers who are found guilty (by the courts) of stealing livestock and/or damaging farm infrastructure are dismissed and charged. This should be contained in the CoC. All dismissals must be in 				

- accordance with South African labour legislation.
- It is recommended that no construction workers, with the exception of security personnel, should be permitted to stay over-night on the site.

Assessment of No-Go option

There is no impact as the current status quo would be maintained.

4.3.5 Increased risk of grass fires

The presence of construction workers and construction-related activities on the site poses an increased risk of grass fires that could, in turn pose, a threat to livestock, crops, wildlife and farm infrastructure. The potential risk of grass fires will be higher during the dry, windy winter months from May to October. The impacts will be largely local and can be effectively mitigated.

The potential risk of grass fires and the impact on grazing and farming operations was raised as a concern by local farmers.

Table 4.5: Assessment of impact of increased risk of grass fires

Nature: Potential loss of livestock, crops and houses, damage to farm infrastructure and threat to human life associated with increased incidence of grass fires				
Impact Criteria		Significance Without Mitigation	Significance With Mitigation	Confidence
Status	Negative	Moderate	Low	High
Spatial Extent	Local			
Duration	Medium Term			
Consequence	Substantial			
Probability	Unlikely			
Reversibility	High			
Irreplaceability	Replaceable			
Can impact be mitigated?	Yes			
Mitigation:				
<ul style="list-style-type: none"> • Preparation and implementation of a Stakeholder Engagement Plan (SEP) prior to and during the construction phase. • Preparation and implementation of a Community Health, Safety and Security Plan (CHSSP) prior to and during the construction phase. • The proponent should enter into an agreement with the local farmers in the area whereby damages to farm property as a result of the construction phase will be compensated for. The agreement should be signed before the construction phase commences. • Contractor should ensure that open fires on the site for cooking or heating are not allowed except in designated areas. • Smoking on site should be confined to designated areas. • Contractor should ensure that construction related activities that pose a potential fire risk, such as welding, are properly managed and are confined to areas where the risk of fires has been reduced. Measures to reduce the risk of fires include avoiding working in high wind conditions when the risk of fires is greater. In this regard special care should be taken during the high risk dry, windy summer months. 				

- Contractor should provide adequate fire-fighting equipment on-site, including a fire fighting vehicle and fire extinguishers placed at designated locations across the site.
- Contractor should provide fire-fighting training to selected construction staff.
- No construction staff, with the exception of security staff, to be accommodated on site overnight.
- As per the conditions of the Code of Conduct, in the event of a fire being caused by construction workers and or construction activities, the appointed contractors must compensate farmers for any damage caused by the project to their farms. The contractor should also compensate the fire-fighting costs borne by farmers and local authorities.

Assessment of No-Go option

There is no impact as it maintains the current status quo.

4.3.6 Nuisance impacts associated with construction related activities

Construction related activities, including the movement of heavy construction vehicles of and on the site, has the potential to create dust, noise and safety impacts and damage roads. The impacts will be largely local and can be effectively mitigated. The number of potentially sensitive social receptors, such as farmsteads, will also be low due to the sparse settlement patterns and small number of farmsteads in the area.

Damage to local public and internal farm roads was raised as concern by local farmers and will need to be addressed during the construction phase. Local landowners also indicated that dust generated by the construction traffic associated with the establishment of the Kalkbult SEF along the De Aar-Kimberley railway line impacted on the veld.

Table 4.6: Assessment of the impacts associated with construction related activities

Nature: Potential noise, dust and safety impacts associated with construction related activities				
Impact Criteria		Significance Without Mitigation	Significance With Mitigation	Confidence
Status	Negative	Moderate	Low	High
Spatial Extent	Local			
Duration	Medium Term			
Consequence	Substantial			
Probability	Unlikely			
Reversibility	High			
Irreplaceability	Replaceable			
Can impact be mitigated?	Yes			
Mitigation:				
<ul style="list-style-type: none"> • Preparation and implementation of a Stakeholder Engagement Plan (SEP) prior to and during the construction phase. • Preparation and implementation of a Community Health, Safety and Security Plan (CHSSP) prior to and during the construction phase. • Timing of construction activities should be planned to avoid / minimise impact on key 				

farming activities.

- The proponent should establish a MC to monitor the construction phase and the implementation of the recommended mitigation measures. The MC should be established before the construction phase commences, and should include key stakeholders, including representatives from local farmers and the contractor(s). The MC should also address issues associated with damage to roads and other construction related impacts.
- Ongoing communication with landowners and road users during construction period. This should be outlined in the SEP.
- The proponent should implement a Grievance Mechanism that provides local farmers and other road users with an effective and efficient mechanism to address issues related to construction related impacts, including damage to local gravel farm roads.
- Implementation of a road maintenance programme throughout the construction phase to ensure that the affected private roads are maintained in a good condition and repaired once the construction phase is completed (for roads where the developer/contractor has legal mandate to undertake such maintenance).
- Repair of all affected road portions at the end of construction period where required (for roads where the developer/contractor has legal mandate to undertake such repairs). In the event of damage to public roads affected by construction traffic the proponent should engage with the relevant road authorities to ensure that damage is repaired before the operational phase commences.
- Dust suppression measures must be implemented on un-surfaced roads, such as wetting on a regular basis and ensuring that vehicles used to transport building materials are fitted with tarpaulins or covers.
- All vehicles must be roadworthy, and drivers must be qualified and made aware of the potential road safety issues and need for strict speed limits.

Assessment of No-Go option

There is no impact as it maintains the current status quo.

4.3.7 Impacts associated with loss of farmland

The activities associated with the construction phase and establishment of the proposed project and associated infrastructure will result in the disturbance and loss of land available for grazing. The impact on farmland associated with the construction phase can be mitigated by minimising the footprint of the construction related activities and ensuring that disturbed areas are fully rehabilitated on completion of the construction phase. In addition, the landowner will be compensated for the loss of land.

The impact on farmland associated with Kudu PV 1-5 was noted as a concern by the affected landowner, XXXX, who leases her properties to XXXX of near-adjacent Bokkraal. PVs 1-4 would each occupy relatively modest portions of the XXXX properties (<5%). PV 5 would however occupy 21.6% of the combined properties. Cumulatively, PV 1-5 would result in the loss of 30.7% of the XXXX properties. The cumulative loss of farmland was not raised as an issue by the owner. However, she did indicate that the portion to the north of the farmstead around Basberg Mountain should not be developed due to visual and sense of place reasons (XXXX, pers. comm). The latter has been taken into consideration by ABO Wind and no Kudu Solar Facilities have been proposed in this area. It must also be re-iterated that at the commencement of this Scoping and EIA Process, approximately 14 Kudu Solar Facilities were proposed. However, following the identification of sensitivities, the Bidding Window 6 Request for Proposal capacity limits, as well as discussions with the said landowner of the Basberg properties, the proposed projects were re-

clustered, and two originally proposed Kudu Solar Facilities on Farm 88/3 were removed from the development proposal, and a total of up to 12 Solar PV Facilities are now being proposed. Therefore, such concerns have been taken into consideration by the Project Developer. Also note that the impact of the proposed project on sense of place and the rural character, and cultural landscape have been assessed in the separate Visual Impact Assessment and Heritage Impact Assessment, respectively.

The lessee, XXXX, is however concerned about the loss of good grazing to his operation. The concern is that alternative land to rent is scarce in the broader study area (XXXX, pers. comm).

In this regard the general concerns raised by affected landowners pertaining to the Kudu SEFs relate to the loss of good grazing areas and the impact that this would have on farming activities in an area where there is limited land to buy and or lease.

Table 4.7: Assessment of impact on farmland due to construction related activities

Nature: The activities associated with the construction phase, such as establishment of access roads and the construction camp, movement of heavy vehicles and preparation of foundations for the project etc. will damage farmlands and result in a loss of farmlands for grazing.				
Impact Criteria		Significance Without Mitigation	Significance With Mitigation	Confidence
Status	Negative	Moderate	Low	High
Spatial Extent	Local			
Duration	Medium Term			
Consequence	Substantial			
Probability	Likely			
Reversibility	High			
Irreplaceability	Replaceable			
Can impact be mitigated?	Yes			
Mitigation:				
<ul style="list-style-type: none"> • The loss of high-quality agricultural land should be avoided and or minimised by careful planning of the final layout of the proposed SEF facility. The recommendations of the agricultural / soil assessment should be implemented. • Affected landowners should be consulted about the timing of construction related activities in advance. • The footprint associated with the construction related activities (access roads, construction platforms, workshop etc.) should be minimised. • An Environmental Control Officer (ECO) should be appointed to monitor the establishment phase of the construction phase. • All areas disturbed by construction related activities, such as access roads on the site, construction platforms, workshop area etc., should be rehabilitated at the end of the construction phase. • The implementation of a rehabilitation programme should be included in the terms of reference for the contractor/s appointed. The specifications for the rehabilitation programme should be included in the EMPr. • The implementation of the Rehabilitation Programme should be monitored by the ECO. 				

Assessment of No-Go option

There is no impact as it maintains the current status quo.

4.4 OPERATIONAL PHASE SOCIAL IMPACTS

Potential positive impacts

- The establishment of infrastructure to improve energy security and support the renewable sector.
- Creation of employment opportunities.
- Benefits to the affected landowners.
- Benefits associated with the socio-economic contributions to community development.

Potential negative impacts

- Visual impacts and associated impacts on sense of place.
- Impact on property values.
- Impact on tourism.

4.4.1 Improve energy security and support the renewable energy sector

The primary goal of the proposed project is to improve energy security in South Africa by generating additional energy. The proposed PV SEF also reduces the carbon footprint associated with energy generation. The project should therefore be viewed within the context of the South Africa's current reliance on coal powered energy to meet the majority of its energy needs, and secondly, within the context of the success of the REIPPPP.

Improved energy security

South Africa's energy crisis, which started in 2007 and is ongoing, has resulted in widespread rolling blackouts (referred to as load shedding) due to supply shortfalls. The load shedding has had a significant impact on all sectors of the economy and on investor confidence. The mining and manufacturing sector have been severely impacted and will continue to be impacted until such time as there is a reliable supply to energy. The Minister of Mineral Resources and Energy, Gwede Mantashe, indicated in February 2023 that the cost of load shedding was estimated at R1 billion a day²⁶. The South African Reserve Bank indicated in February 2023 that stage 3 and stage 6 loadshedding cost the South African economy between R204 million and R899 million a day.²⁷

A survey of 3 984 small business owners in 2019 found that 44% said that they had been severely affected by load shedding with 85% stating that it had reduced their revenue, with 40% of small businesses losing 20% or more of revenue during due to load shedding period²⁸.

Impact of a coal powered economy

As highlighted in Section 2 of this report, the Green Jobs study (2011) notes that South Africa has one of the most carbon-intensive economies in the world, thus making the greening of the electricity mix a national imperative. The study notes

²⁶ <https://www.citizen.co.za/news/load-shedding-cost-economy-billion/>

²⁷ <https://businesstech.co.za/news/energy/662515/stage-6-load-shedding-costs-south-africa-r900-million-a-day-sarb/>

²⁸ "How does load shedding affect small business in SA?". The Yoco Small Business Pulse (3: Q1 2019):

that renewable energy provides an ideal means for reaching emission reduction targets in a relatively easy manner. In addition, and of specific relevance to South Africa renewable energy is not as dependent on water compared to the massive water requirements of conventional power stations, has a limited footprint, and therefore does not impact on large tracts of land, poses limited pollution and health risks, specifically when compared to coal and nuclear energy plants.

The Greenpeace Report (powering the future: Renewable Energy Roll-out in South Africa, 2013), also notes that within a broader context of climate change, coal energy does not only have environmental impacts, but it also has socio-economic impacts. These include acid mine drainage from abandoned mines in South Africa and the risk this poses on the country's limited water resources.

Benefits associated with REIPPPP

The overview of the IPPPP (December 2021) indicates that the REIPPPP has attracted R42 billion in foreign investment and financing in the seven bid windows (BW1 – BW4). This is almost double the inward FDI attracted into South Africa during 2015 (R22.6 billion). In terms of local equity shareholding, 52% (R31.4 billion) of the total equity shareholding (R61 billion) was held by South African's across BW1 to BW4, 1S2 and 1S2. This equates to substantially more than the 40% requirement. Foreign equity amounts to R 29.5 billion and contributes 49% to total equity. As far as Broad Based Black Economic Empowerment is concerned, Black South Africans own, on average, 34% of projects that have reached financial close, which is higher than the 30%

In terms of employment, to date, a total of 63 291 job years²⁹ have been created for South African citizens, of which 48 110 job years were in construction and 15 182 in operations. By the end of December 2021, 85 projects had been completed and moved into operation. These projects created 44 172 job years of employment, compared to the anticipated 30 488. This represented 45% more than planned. The REIPPPP has therefore created significant employment opportunities for black South African citizens and local communities beyond planned targets. This highlights the importance of the programme in terms of employment equity and the creation of more equal societies.

Table 4.8: Improve energy security and support the renewable sector

Nature: Development of infrastructure to improve energy security and support renewable sector				
Impact Criteria		Significance Without Enhancement	Significance With Enhancement	Confidence
Status	Positive	Moderate	Moderate	High
Spatial Extent	National			
Duration	Long Term			
Consequence	Substantial			
Probability	Very Likely			
Reversibility	N/A			
Irreplaceability	N/A			
Can impact be	Yes			

²⁹ The equivalent of a full-time employment opportunity for one person for one year

Enhanced?	
Enhancement:	
<ul style="list-style-type: none"> • Maximise the number of employment opportunities for local community members. • Implement training and skills development programs for members from the local community. • Maximise opportunities for local content and procurement. 	

Assessment of No-Go option

There is no impact as it maintains the current status quo.

4.4.2 Creation of employment opportunities

The proposed development will of a single PV SEF will create in the region of 8 full time employment opportunities during the operational phase, of which 70% will be unskilled, 25% semi-skilled, and 5% skilled. Based on similar projects the annual operating budget will be in the region of R30 million (2023 Rand values), including wages.

Table 4.9: Assessment of employment and business creation opportunities

Nature: Creation of employment and business opportunities associated with the operational phase				
Impact Criteria		Significance Without Enhancement	Significance With Enhancement	Confidence
Status	Positive	Low	Low	High
Spatial Extent	Regional			
Duration	Long Term			
Consequence	Moderate			
Probability	Likely			
Reversibility	N/A			
Irreplaceability	N/A			
Can impact be enhanced?	Yes			
Enhancement:				
The enhancement measures listed in Section 4.3.1, i.e., to enhance local employment and business opportunities during the construction phase, also apply to the operational phase. In addition, the proponent should investigate providing training and skills development to enable locally based service providers to provide the required services for the operational phase.				

Assessment of No-Go option

There is no impact as it maintains the current status quo.

4.4.3 Generate income for affected landowners

The proponent will enter into rental agreements with the affected landowners for the use of the land for the establishment of the proposed PV SEF. In terms of the rental agreement the affected landowner will be paid an annual amount dependent upon the area affected. The additional income will reduce the risk to their livelihoods posed by droughts and fluctuating market prices for sheep and farming

inputs, such as fuel, feed etc. Given the low carrying capacity of the veld the additional income represents a significant benefit for the affected landowner.

However, a concern was raised that the Kudu projects benefit too few landowners (2 as opposed to 6 to 9 for the Crossroads Phase 1 Cluster). The potential benefits were therefore spread out amongst the local farming community. The projects will however create a number of broader socio-economic opportunities as discussed below.

Table 4.10: Assessment of benefits associated with income generated for the directly affected land owner(s)

Nature: The generation of additional income represents a significant benefit for the local affected farmer(s) and reduces the risks to their livelihoods posed by droughts and fluctuating market prices for sheep and farming inputs, such as feed etc.				
Impact Criteria		Significance Without Enhancement	Significance With Enhancement	Confidence
Status	Positive	Low	Moderate	High
Spatial Extent	Local			
Duration	Long Term			
Consequence	Moderate			
Probability	Very Likely			
Reversibility	N/A			
Irreplaceability	N/A			
Can impact be Enhanced?	Yes			
Enhancement:				
<ul style="list-style-type: none"> • Implement agreements with affected landowners. • The loss of high-quality agricultural land should be avoided and or minimised by careful planning in the final layout of the proposed PV SEF facility. The recommendations of the agricultural / soil assessment should be implemented. 				

Assessment of No-Go option

There is no impact as it maintains the current status quo.

4.4.4 Benefits associated with the socio-economic development contributions

The REIPPPP has been designed not only to procure energy but has also been structured to contribute to the broader national development objectives of job creation, social upliftment and broadening of economic ownership. Socio-economic development (SED) contributions are an important focus of the REIPPPP and are aimed at ensuring that local communities benefit directly from the investments attracted into the area. These contributions are linked to Community Trusts and accrue over the project operation life and, in so doing, create an opportunity to generate a steady revenue stream over an extended period. This revenue can be used to fund development initiatives in the area and support the local community. The long-term duration of the revenue stream also allows local municipalities and communities to undertake long term planning for the area.

Table 4.11: Assessment of benefits associated with socio-economic development contributions

Nature: Benefits associated with support for local communities from SED contributions.				
Impact Criteria		Significance Without Enhancement	Significance With Enhancement	Confidence
Status	Positive	Moderate	High	High
Spatial Extent	Regional			
Duration	Long Term			
Consequence	Substantial			
Probability	Very Likely			
Reversibility	N/A			
Irreplaceability	N/A			
Can impact be Enhanced?	Yes			
Enhancement:				
<ul style="list-style-type: none"> The RLM or PKSDM should be consulted as to the structure and identification of potential trustees to sit on the Trust. The key departments in the RLM or PKSDM that should be consulted include the Municipal Managers Office, IDP Manager and LED Manager, where possible. Clear criteria for identifying and funding community projects and initiatives in the area should be identified. The criteria should be aimed at maximising the benefits for the community as a whole and not individuals within the community. Strict financial management controls, including annual audits, should be instituted to manage the funds generated for the Community Trust from the REF plant. 				

Assessment of No-Go option

There is no impact as it maintains the current status quo. However, the potential opportunity costs in terms of the supporting the social and economic development in the area would be lost. This would also represent a negative impact.

4.4.5 Visual impact and impact on sense of place

The proposed PV SEF has the potential to impact on the area's existing rural sense of place. Based on an initial assessment of the location the potential impact on the areas sense of place associated with a single PV SEF is likely to be limited. The Visual Impact Assessment (VIA) undertaken for Kudu PV1 by Oberholzer and Lawson (May 2023) has assigned a **Low** overall impact significance to the proposed facility both during the construction and operational phases. This is linked to the low occurrence of sensitive visual receptors.

The affected landowner, XXXX, did however indicate that the portion to the north of the farmstead around Basberg Mountain should not be developed due to visual and sense of place reasons (XXXX, pers. comm). This issue has been addressed by the developer.

Table 4.12: Visual impact and impact on sense of place

Nature: Visual impact associated with the proposed facility and associated infrastructure and the potential impact on the areas rural sense of place.					
Impact Criteria		Significance Without Mitigation	Significance With Mitigation	Confidence	
Status	Negative	Low	Low	High	
Spatial Extent	Regional				
Duration	Long Term				
Consequence	Moderate				
Probability	Unlikely				
Reversibility	High				
Irreplaceability	Low				
Can impact be Mitigated?	Yes				
Mitigation:					
<ul style="list-style-type: none"> The recommendations contained in the VIA should also be implemented. 					

Assessment of No-Go option

There is no impact as it maintains the current status quo.

4.4.6 Potential impact on property values

The potential visual impacts associated with the proposed PV SEF have the potential to impact on property values. Based on the results of a literature review undertaken for wind farms (for comparative purposes), the potential impact on property values in rural areas is likely to be limited. In this regard a study undertaken in Australia in 2016 (Urbis Pty Ltd) found that:

- Appropriately located wind farms within rural areas, removed from higher density residential areas, are unlikely to have a measurable negative impact on surrounding land values.
- There is limited available sales data to make a conclusive finding relating to value impacts on residential or lifestyle properties located close to wind farm turbines, noting that wind farms in New South Wales (Australia) have been constructed in predominantly rural areas.

The impact of SEFs on property values is likely to be lower than the impact of WEFs due to the reduced visual impact. The impact of the proposed PV SEF on property values is therefore likely to be low.

Table 4.13: Assessment of potential impact on property values and operations

Nature: Potential impact of the SEF on property values. This is usually linked to the visual impact associated with the proposed facility and associated infrastructure and the potential impact on the areas rural sense of place.					
Impact Criteria		Significance Without Mitigation	Significance With Mitigation	Confidence	
Status	Negative	Low	Low	High	
Spatial Extent	Regional				
Duration	Long Term				
Consequence	Moderate				
Probability	Very Unlikely				
Reversibility	High				
Irreplaceability	Low				
Can impact be Mitigated?	Yes				
Mitigation: The recommendations contained in the VIA should also be implemented.					

Assessment of No-Go option

There is no impact as it maintains the current status quo.

4.4.7 Potential impact on tourism

The potential visual impacts associated with the PV SEF have the potential to impact on tourism facilities and tourism in the area. Based on the findings of the literature review there is limited evidence to suggest that the proposed SEF would impact on the tourism in the PKSDM and RLM at a local and regional level. At a local level there are a limited number of tourism facilities located in the study area. Based on the findings of the site visit there are no local tourism facilities in the areas that would be impacted. The limited number of facilities are also likely to benefit from providing accommodation to contractors and workers during both the construction and operational phase.

Table 4.14: Impact on tourism in the region

Nature: Potential impact of SEF on local tourism. This is usually linked to the visual impact associated with the proposed facility and associated infrastructure and the potential impact on the areas rural sense of place.					
Impact Criteria		Significance Without Mitigation	Significance With Mitigation	Confidence	
Status	Negative	Low	Low	High	
Spatial Extent	Regional				
Duration	Long Term				
Consequence	Moderate				
Probability	Very Unlikely				
Reversibility	High				

Irreplaceability	Low			
Can impact be Mitigated?	Yes			
Mitigation: The recommendations contained in the VIA should also be implemented.				

Assessment of No-Go option

There is no impact as it maintains the current status quo.

4.5 ASSESSMENT OF DECOMMISSIONING PHASE

Typically, the major social impacts associated with the decommissioning phase are linked to the loss of jobs and associated income. This has implications for the households who are directly affected, the communities within which they live, and the relevant local authorities. However, in the case of the proposed facility the decommissioning phase is likely to involve the disassembly and replacement of the existing components with more modern technology. This is likely to take place in the 20 - 25 years post commissioning. The decommissioning phase is therefore likely to create additional construction type jobs, as opposed to the jobs losses typically associated with decommissioning.

Given the small number of people employed during the operational phase (~ 8), the social impacts associated with the decommissioning phase can be effectively managed with the implementation of a retrenchment and downscaling programme. With mitigation, the impacts are assessed to be Low (negative). Decommissioning will also create temporary employment opportunities, which would represent a positive temporary impact. The significance would be Low with enhancement due to limited opportunities and short duration.

Table 4.15: Impact of decommissioning

Nature: Social impacts associated with retrenchment including loss of jobs, and source of income. Decommissioning will also create temporary employment opportunities, which would represent a positive temporary impact				
Impact Criteria		Significance Without Mitigation	Significance With Mitigation	Confidence
Status	Negative	Moderate	Low	High
Spatial Extent	Local			
Duration	Short Term			
Consequence	Substantial			
Probability	Likely			
Reversibility	High			
Irreplaceability	Low			
Can impact be Mitigated?	Yes			
Mitigation:				
<ul style="list-style-type: none"> The proponent should ensure that retrenchment packages are provided for all staff retrenched when the plant is decommissioned. All structures and infrastructure associated with the proposed facility should be dismantled 				

and transported off-site on decommissioning.

- Revenue generated from the sale of scrap metal during decommissioning should be allocated to aid in funding closure and rehabilitation of disturbed areas.

Assessment of No-Go option

There is no impact as it maintains the current status quo.

4.6 CUMULATIVE IMPACT ON SENSE OF PLACE

The potential cumulative impacts on the areas sense of place will be largely linked to potential visual impacts. In this regard the Scottish Natural Heritage (2005) describes a range of potential cumulative landscape impacts associated with wind farms on landscapes. These issues are also likely to be relevant to solar facilities and associated infrastructure. The relevant issues identified by Scottish Natural Heritage study include:

- Combined visibility (whether two or more wind farms will be visible from one location).
- Sequential visibility (e.g. the effect of seeing two or more wind farms along a single journey, e.g. road or walking trail).
- The visual compatibility of different wind farms in the same vicinity.
- Perceived or actual change in land use across a character type or region.
- Loss of a characteristic element (e.g. viewing type or feature) across a character type caused by developments across that character type.

The guidelines also note that cumulative impacts need to be considered in relation to dynamic as well as static viewpoints. The experience of driving along a tourist road, for example, needs to be considered as a dynamic sequence of views and visual impacts, not just as the cumulative impact of several developments on one location. The viewer may only see one renewable energy facility and the associated infrastructure at a time, but if each successive stretch of the road is dominated by views of renewable energy facilities, then that can be argued to be a cumulative visual impact (National Wind Farm Development Guidelines, July 2010).

As indicated above, the potential impact of a single PV SEF and associated infrastructure on the areas sense of place is likely to be limited. However, the establishment of 12 PV SEFs associated with the Kudu PV SEF Cluster will create cumulative impacts on the area's sense of place. The findings of the Visual Impact Assessment (VIA) undertaken for Kudu 1 PV by Oberholzer and Lawson (May 2023) found that the significance of the cumulative impact of the 12 Kudu projects was **moderate** seen in combination with other projects proposed in the area. The VIA however noted that proposed similar facilities on adjacent properties would reduce the visual sensitivity of the Kudu 1 PV site as the area would be seen as a node for solar energy.

Table 4.16: Cumulative impacts on sense of place and the landscape

Nature: Visual impacts associated with the establishment of more than one SEF and the potential impact on the area's rural sense of place and character of the landscape.				
Impact Criteria		Significance Without Mitigation	Significance With Mitigation	Confidence
Status	Negative	Moderate	Moderate	High
Spatial Extent	Regional			
Duration	Long Term			
Consequence	Substantial			
Probability	Likely			
Reversibility	High			
Irreplaceability	Low			
Can impact be Mitigated?	Yes			
Mitigation: The recommendations contained in the VIA should be implemented.				

Assessment of No-Go option

There is no impact as it maintains the current status quo.

4.7 CUMULATIVE IMPACT ON LOCAL SERVICES AND ACCOMMODATION

The establishment of a number of PV SEFs (up to 12) has the potential to place pressure on local services and accommodation, specifically during the construction phase. The objective will be to source as many low and semi-skilled workers for the construction phase from the RLM and ELM. This will reduce the pressure on local services and accommodation and the nearby towns of Philipstown, Petrusville and De Aar. The total number of construction workers that require accommodation will depend on the timing and phasing of the construction of the individual PV SEFs associated with the Kudu PV Cluster. Based on the findings of the site visit there is limited accommodation available in Philipstown and Petrusville. Accommodation is available in De Aar and the town has experience with the construction of renewable energy facilities. However, there is unlikely to be sufficient accommodation in De Aar and the surrounding towns if the construction phase of 3 or more renewable energy facilities overlaps. This issue will need to be addressed in the planning of the construction phase.

However, the potential impact should also be viewed within the context of the positive cumulative impacts for the local economy associated with the establishment of the proposed facility and associated renewable energy projects in the RLM and ELM. These benefits will create opportunities for investment in the RLM and ELM., including the opportunity to up-grade and expand existing services and the construction of new houses. Socio-economic development (SED) contributions also represent an important focus of the REIPPPP and is aimed at ensuring that the build programme secures sustainable value for the country and enables local communities to benefit directly from the investments attracted into the area. The SED contributions will extend over a period of 20-25 years and provide revenue that can be used by the RLM and ELM to invest in up-grading local services where required. It should also be noted that it is the function of national, provincial, and

local government to address the needs created by development and provide the required services. The additional demand for services and accommodation created by the establishment of renewable energy projects should therefore be addressed in the Integrated Development Planning process undertaken by the RLM and ELM.

Table 4.17: Cumulative impacts on local services

Nature: The establishment of a number of renewable energy facilities and associated projects, such as the proposed SEF, in the RLM has the potential to place pressure on local services, specifically medical, education and accommodation.				
Impact Criteria		Significance Without Mitigation	Significance With Mitigation	Confidence
Status	Negative	Low	Low	High
Spatial Extent	Regional			
Duration	Long Term			
Consequence	Moderate			
Probability	Unlikely			
Reversibility	High			
Irreplaceability	Low			
Can impact be Mitigated?	Yes			
Mitigation: The proponent should liaise with the RLM and ELM to address potential impacts on local services.				

Assessment of No-Go option

There is no impact as it maintains the current status quo.

4.8 CUMULATIVE IMPACT ON LOCAL ECONOMY

In addition to the potential negative impacts, the establishment of 12 PV SEFs and associated infrastructure will also create several socio-economic opportunities for the RLM and ELM. The positive cumulative opportunities include creation of employment, skills development and training opportunities, and downstream business opportunities.

The review of the REIPPPP (December 2021) indicates that the SED contributions associated with 85 operational projects has amounted to R 1.8 billion to date. In terms of Enterprise Development (ED), R 7.2 billion has been committed for BW1-4. Assuming an equal distribution of revenue over the 20-year project operational life, enterprise development contributions would be R358 million per annum. Of the total commitment, R5.6 billion is specifically committed directly within the local communities where the IPPs operate, contributing significantly to local enterprise development. Up until the end of December 2021 a total of R 504.1 million had already been made to the local communities located in the vicinity of the 68 operating IPPs. This represents 94% of the total R537.9 million enterprise development contributions made to date.

The potential cumulative benefits for the local and regional economy are therefore associated with both the construction and operational phase of renewable energy projects and associated infrastructure and extend over a period of 20-25 years. However, steps must be taken to maximise employment opportunities for members

from the local communities in the area and support skills development and training programmes.

Table 4.18: Cumulative impacts on local economy

Nature: The establishment of renewable energy facilities and associated projects, such as the SEF, in the RLM will create employment, skills development and training opportunities, creation of downstream business opportunities.				
Impact Criteria		Significance Without Enhancement	Significance With Enhancement	Confidence
Status	Positive	Moderate	Moderate	High
Spatial Extent	Regional			
Duration	Long Term			
Consequence	Substantial			
Probability	Likely			
Reversibility	High			
Irreplaceability	Low			
Can impact be Mitigated?	Yes			
Enhancement: The proponent should liaise with the RLM and ELM to identify potential opportunities for the local economy and businesses.				

Assessment of No-Go option

There is no impact as it maintains the current status quo.

4.9 ASSESSMENT OF NO-DEVELOPMENT OPTION

The primary goal of the proposed project is to assist in providing additional capacity to Eskom to assist in addressing the current energy supply constraints. The project also aims to reduce the carbon footprint associated with energy generation. As indicated above, energy supply constraints and the associated load shedding have had a significant impact on the economic development of the South African economy. South Africa also relies on coal-powered energy to meet more than 90% of its energy needs. South Africa is therefore one of the highest per capita producers of carbon emissions in the world and Eskom, as an energy utility, has been identified as the world's second largest producer of carbon emissions.

The No-Development option would represent a lost opportunity for South Africa to improve energy security and supplement its current energy needs with clean, renewable energy. Given South Africa's current energy security challenges and its position as one of the highest per capita producers of carbon emissions in the world, this would represent a significant negative social cost.

Table 4.19: Assessment of no-development option

Nature: The no-development option would result in the lost opportunity for South Africa to improve energy security and assist to support with the development of clean, renewable energy.					
Impact Criteria		Significance Without Mitigation ³⁰	Significance With Enhancement ³¹	Confidence	
Status	Negative / Positive	Moderate (-)	Moderate (+)	High	
Spatial Extent	National				
Duration	Long Term				
Consequence	Substantial				
Probability	Likely				
Reversibility	N/A				
Irreplaceability	N/A				
Can impact be Enhanced?	Yes				
Enhancement: The proposed SEF should be developed, and the mitigation and enhancement measures identified in the SIA and other specialist studies should be implemented.					

4.10 ASSESSMENT OF BESS

The proposed BESS site is not located within significant proximity to any social receptors. The study area is very sparsely populated. No inhabited dwellings are located within 2 km of the site. The proposed site is therefore suitable from a social impact assessment point of view. Both proposed technology options (Redox flow and Lithium ion) are acceptable from a Social Assessment perspective. Please also refer to the High-Level Safety, Health and Environment Risk Assessment contained in the EIA report.

³⁰ Assumes project is not developed
³¹ Assumes project is developed

SECTION 5: KEY FINDINGS AND RECOMMENDATIONS

5.1 INTRODUCTION

Section 5 lists the key findings of the study and recommendations. These findings are based on:

- A review of key planning and policy documents pertaining to the area.
- A review of social and economic issues associated with similar developments.
- Site visit and interviews with key stakeholders
- A review of relevant literature on social and economic impacts.
- The experience of the authors with other renewable energy projects in the Northern Cape Province.

5.2 SUMMARY OF KEY FINDINGS

The key findings of the study are summarised under the following sections:

- Fit with policy and planning.
- Construction phase impacts.
- Operational phase impacts.
- Cumulative Impacts.
- Decommissioning phase impacts.
- No-development option.

5.2.1 Policy and planning issues

The development of and investment in renewable energy is supported by the National Development Plan (NDP), New Growth Path Framework and National Infrastructure Plan, which all refer to and support renewable energy. The PKSDM Spatial Development Framework (SDF) and Integrated Development Plan (IDP) also support the development of renewable energy. The development of the proposed SEF is therefore supported by key policy and planning documents.

5.2.2 Construction phase impacts

The key social issues associated with the construction phase include:

Potential positive impacts

- Creation of employment and business opportunities, and the opportunity for skills development and on-site training.

The construction phase is expected to extend over a period of 12 to 18 months and create approximately 150 employment opportunities. The total wage bill for the construction phase is estimated to be in the region of R 30 million (2023 Rand value). A percentage of the wage bill will be spent in the local economy which will also create opportunities for local businesses in the local towns in the area and the RLM and ELM.

Members from the local communities in De Aar, Philipstown and Petrusville may potentially qualify for low skilled and semi-skilled and some skilled employment opportunities. Most of these employment opportunities will accrue to Historically Disadvantaged (HD) members of the community. Given relatively high local unemployment levels and limited job opportunities in the area, this will represent a significant, if localised, social benefit. However, in the absence of specific commitments from the developer to employ local contractors the potential for meaningful skills to local employment targets the benefits for members from the local communities may be limited. In addition, the low education and skills levels in the area may also hamper potential opportunities for local communities.

The capital expenditure associated with the construction phase will be approximately R 1.5 – 2 billion (2023 Rand value). This will create opportunities for local companies and the regional and local economy. Due the lack of diversification in the local economy the potential for local companies is likely to be limited. The majority of benefits are therefore likely to accrue to contractors and engineering companies based outside the RLM and ELM. The local service sector will also benefit from the construction phase. The potential opportunities would be linked to accommodation, catering, cleaning, transport, and security, etc. associated with the construction workers on the site.

Potential negative impacts

- Impacts associated with the presence of construction workers on local communities.
- Impacts related to the potential influx of job seekers.
- Increased risks to livestock and farming infrastructure associated with the construction related activities and presence of construction workers on the site.
- Increased risk of grass fires associated with construction related activities.
- Noise, dust, and safety impacts of construction related activities and vehicles.
- Impact on productive farmland.

The findings of the SIA indicate that the significance of all the potential negative impacts with mitigation are likely to be **Low Negative**. The potential negative impacts can therefore be effectively mitigated if the recommended mitigation measures are implemented. Table 5.1 summarises the significance of the impacts associated with the construction phase.

Table 5.1: Summary of social impacts during construction phase

Impact	Significance No Mitigation/Enhancement	Significance With Mitigation/Enhancement
Creation of employment and business opportunities	Medium (+)	Medium (+)
Presence of construction workers and potential impacts on family structures and social networks	Medium (-)	Low (-)
Influx of job seekers	Low (-)	Low (-)
Safety risk, stock theft and damage to farm infrastructure associated with presence of construction workers	Medium (-)	Low (-)
Increased risk of grass fires	Medium (-)	Low (-)
Impact of heavy vehicles and construction activities	Medium (-)	Low (-)
Loss of farmland	Medium (-)	Low (-)

5.2.3 Operational phase impacts

Potential positive impacts

- Establishment of infrastructure to improve energy security and support renewable sector.
- Creation of employment opportunities.
- Benefits associated with socio-economic contributions to community development.
- Benefits for local landowners.

The proposed project will supplement South Africa's energy and assist to improve energy security. In addition, it will also reduce the country's reliance on coal as an energy source. This represents a positive social benefit.

Potential negative impacts

- Visual impacts and associated impacts on sense of place.
- Potential impact on property values.
- Potential impact on tourism.

The findings of the SIA indicate that the significance of all the potential negative impacts with the exception of visual impacts will be **Low Negative** with mitigation. The majority of potential negative impacts can therefore be effectively mitigated. The significance of the impacts associated with the operational phase are summarised in Table 5.2.

Table 5.2: Summary of social impacts during operational phase

Impact	Significance No Mitigation/Enhancement	Significance With Mitigation/Enhancement
Establishment of infrastructure to improve energy security and support renewable sector	High (+)	High (+)
Creation of employment and business opportunities during maintenance	Low (+)	Medium (+)
Benefits associated with socio-economic contributions to community development	Medium (+)	High (+)
Benefits for landowners	Low (+)	High (+)
Visual impact and impact on sense of place	Low (-)	Low (-)
Impact on property values	Low (-)	Low (-)
Impact on tourism	Low (-)	Low (-)

5.2.4 Assessment of cumulative impacts

Cumulative impact on sense of place

The establishment of the proposed PV SEF and other renewable energy facilities in the area will create the potential for combined and sequential visibility impacts. This impact is rated as **Moderate Negative**.

Cumulative impact on local services and accommodation

The significance of this impact with effective mitigation was rated as **Low Negative**.

Cumulative impact on local economy

The significance of this impact with enhancement was rated as **Moderate Positive**.

5.2.5 Decommissioning phase

Given the moderate number of people employed during the operational phase (~ 8), the potential negative social impacts associated with the decommissioning phase can be effectively managed with the implementation of a retrenchment and downscaling programme. With mitigation, the impacts are assessed to be **Low Negative**.

5.2.6 Assessment of no-development option

The No-Development option would represent a lost opportunity for South Africa to improve energy security and supplement its current energy needs with clean, renewable energy. Given South Africa's current energy security challenges and its position as one of the highest per capita producers of carbon emissions in the

world, this would represent a significant negative social cost. The No-Development option is not supported by the findings of the SIA.

5.2.7 Assessment of BESS site

Based on the findings of the SIA the proposed BESS site and technology alternatives are suitable from a social impact assessment point of view.

5.3 CONCLUSIONS

The findings of the SIA indicate that the proposed Kudu PV 1 SEF will result in several social and socio-economic benefits, including creation of employment and business opportunities during both the construction and operational phases. The project will also create economic development opportunities for the local community. The enhancement measures listed in the report should be implemented in order to maximise the potential benefits. The significance of this impact is rated as **High Positive**. The proposed development also represents an investment in clean, renewable energy infrastructure, which, given the negative environmental and socio-economic impacts associated a coal-based energy economy and the challenges created by climate change, represents a significant positive social benefit for society as a whole. The Renewable Energy Independent Power Producers Procurement Programme (REIPPPP) has resulted in significant socio-economic benefits, both at a national level and at a local, community level. These benefits are linked to foreign Direct Investment, local employment and procurement and investment in local community initiatives.

The findings also indicate that the potential negative impacts associated with both the construction and operational phase are likely to be **Low Negative** with mitigation. The potential negative impacts can therefore be effectively mitigated if the recommended mitigation measures are implemented.

Statement and reasoned opinion

The establishment of the proposed Kudu PV 1 SEF and associated infrastructure is therefore supported by the findings of the SIA.

ANNEXURE A

INTERVIEWS

- XXXX (telephonic 2023-03-29). Vlakplaas.
- XXXX (2023-03-24). Jakkalskuil, Ventersdam.
- XXXX (2023-03-24). Ruspoort.
- XXXX (2023-03-24). Wolwekuil.
- XXXX (telephonic 2023-03-16). Basberg.
- XXXX (2023-03-23). Wolwekuil.
- XXXX (2023-03-23). Tafelkop.
- XXXX (2023-03-23). Bokkraal.
- XXXX (2023-03-23). Vrede.

REFERENCES

- National Energy Act (2008).
- White Paper on the Energy Policy of the Republic of South Africa (December 1998).
- White Paper on Renewable Energy (November 2003).
- Integrated Resource Plan (IRP) for South Africa (2019).
- National Infrastructure Plan (NIP) (2012 and 2021).
- National Development Plan (2011).
- Northern Cape Provincial Growth and Development Strategy (2004-2014).
- Northern Cape Climate Change Response Strategy.
- Northern Cape Spatial Development Framework (2012).
- Northern Cape Province Green Document (2017/2018).
- Pixley ka Seme District Municipality Integrated Development Plan (2019-2020).
- Pixley ka Seme District Municipality Spatial Development Framework (2017).
- Emthanjeni Local Municipality Integrated Development Plan (2021-2022).
- Renosterberg Local Municipality Integrated Development Plan (2017-2022).

ANNEXURE B

METHODOLOGY FOR THE ASSESSMENT OF POTENTIAL IMPACTS

The impact assessment includes:

- *the nature, status, significance and consequences of the impact and risk;*
- *the extent and duration of the impact and risk;*
- *the probability of the impact and risk occurring;*
- *the degree to which impacts and risks can be mitigated;*
- *the degree to which the impacts and risks can be reversed; and*
- *the degree to which the impacts and risks can cause loss of irreplaceable resources.*

Terminology used in impact assessment can overlap. To avoid ambiguity, please note the following clarifications (that are based on NEMA and the EIA Regulations):

- *The term environment is understood to have a broad interpretation that includes both the natural (biophysical) environment and the socio-economic environment. The term socio-ecological system is also used to describe the natural and socio-economic environment and the interactions amongst these components.*
- *Significance = Consequence x Probability, which means that significance is equivalent to risk.*
- *The impact can have a positive or negative status. The significance of a negative impact may be called a risk, and the significance of a positive impact may be called an opportunity.*

The following principles are to underpin the application of this methodology:

- *Transparent and repeatable process - specialists are to describe the thresholds and limits they apply in their assessment, wherever possible.*
- *Adapt parameters to context (where justified) – the methodology proposes some thresholds (e.g. for spatial extent, in Step 3 below), however, if the nature of the impact requires a different definition of the categories of spatial extent, then this can be provided and described.*
- *Combination of a quantitative and qualitative assessment – where possible, specialists are to provide quantitative assessments (e.g. areas of habitat affected, decibels of noise, number of jobs), however, it is recognised that not all impacts can be quantified, and then qualitative assessments are to be provided.*

As per the DFFE Guideline 5: Assessment of Alternatives and Impacts, the following methodology is applied to the prediction and assessment of impacts and risks. Potential impacts and risks have been rated in terms of the direct, indirect and cumulative:

- *Direct impacts are impacts that are caused directly by the activity and generally occur at the same time and at the place of the activity. These impacts are usually associated with the construction, operation or maintenance of an activity and are generally obvious and quantifiable.*
- *Indirect impacts of an activity are indirect or induced changes that may occur as a result of the activity. These types of impacts include all the potential impacts that do not manifest immediately when the activity is undertaken or which occur at a different place as a result of the activity.*
- *Cumulative impacts are impacts that result from the incremental impact of the proposed activity on a common resource when added to the impacts of other past, present or reasonably foreseeable future activities. Cumulative impacts can occur from the collective*

impacts of individual minor actions over a period of time and can include both direct and indirect impacts.

The impact assessment methodology includes the aspects described below.

- **Step 1: Nature** of impact/risk - *The type of effect that a proposed activity will have on the environment.*
- **Step 2: Status** - *Whether the impact/risk on the overall environment will be:*
 - *Positive - environment overall will benefit from the impact/risk;*
 - *Negative - environment overall will be adversely affected by the impact/risk; or*
 - *Neutral - environment overall not be affected.*
- **Step 3: Qualitatively** determine the **consequence** of the impact/risk by identifying the **a) SPATIAL EXTENT; b) DURATION; c) REVERSIBILITY; AND d) IRREPLACEABILITY.**
 - **A) Spatial extent** – *The size of the area that will be affected by the impact/risk:*
 - *Site specific;*
 - *Local (<10 km from site);*
 - *Regional (<100 km of site);*
 - *National; or*
 - *International (e.g. Greenhouse Gas emissions or migrant birds).*
 - **B) Duration** – *The timeframe during which the impact/risk will be experienced:*
 - *Very short term (instantaneous);*
 - *Short term (less than 1 year);*
 - *Medium term (1 to 10 years);*
 - *Long term (the impact will cease after the operational life of the activity (i.e. the impact or risk will occur for the project duration)); or*
 - *Permanent (mitigation will not occur in such a way or in such a time span that the impact can be considered transient (i.e. the impact will occur beyond the project decommissioning)).*
 - **C) Reversibility** of the Impacts - *the extent to which the impacts/risks are reversible assuming that the project has reached the end of its life cycle (decommissioning phase):*
 - *High reversibility of impacts (impact is highly reversible at end of project life i.e. this is the most favourable assessment for the environment);*
 - *Moderate reversibility of impacts;*
 - *Low reversibility of impacts; or*
 - *Impacts are non-reversible (impact is permanent, i.e. this is the least favourable assessment for the environment).*
 - **D) Irreplaceability** of Receiving Environment/Resource Loss caused by impacts/risks – *the degree to which the impact causes irreplaceable loss of resources assuming that the project has reached the end of its life cycle (decommissioning phase):*
 - *High irreplaceability of resources (project will destroy unique resources that cannot be replaced, i.e. this is the least favourable assessment for the environment);*
 - *Moderate irreplaceability of resources;*

- *Low irreplaceability of resources; or*
- *Resources are replaceable (the affected resource is easy to replace/rehabilitate, i.e. this is the most favourable assessment for the environment).*

*Some of the criteria are quantitative (e.g. spatial extent and duration) and some may be described in a quantitative or qualitative manner (e.g. reversibility and irreplaceability). The specialist then combines these criteria in a qualitative manner to determine the **consequence**.*

The consequence terms ranging from slight to extreme must be calibrated per Specialist Study so that there is transparency and consistency in the way a risk/impact is measured. For example, from a biodiversity and ecology perspective, the consequence ratings could be defined according to a reduction in population or occupied area in relation to Species of Conservation Concern (SCC) status, ranging from slight consequence for defined areas of Least Concern, to extreme consequence for defined areas that are Critically Endangered. For example, from a social perspective, a slight consequence could refer to small and manageable impacts, or impacts on small sections of the community; a moderate consequence could refer to impacts which affect the bulk of the local population negatively or may produce a net negative impact on the community; and an extreme consequence could refer to impacts which could result in social or political violence or institutional collapse.

- **Consequence** – *The anticipated consequence of the risk/impact is generally defined as follows:*
 - *Extreme (extreme alteration of natural or socio-economic systems, patterns or processes, i.e. where environmental or socio-economic functions and processes are altered such that they permanently cease);*
 - *Severe (severe alteration of natural or socio-economic systems, patterns or processes, i.e. where environmental or socio-economic functions and processes are altered such that they temporarily or permanently cease);*
 - *Substantial (substantial alteration of natural or socio-economic systems, patterns or processes, i.e. where environmental or socio-economic functions and processes are altered such that they temporarily or permanently cease);*
 - *Moderate (notable alteration of natural or socio-economic systems, patterns or processes, i.e. where the natural or socio-economic environment continues to function but in a modified manner; or*
 - *Slight (negligible and transient alteration of natural or socio-economic systems, patterns or processes, i.e. where natural systems/environmental or socio-economic functions, patterns, or processes are not affected in a measurable manner, or if affected, that effect is transient and the system recovers).*

- **Step 4:** *Rate the **probability** of the impact/risk using the criteria below:*
 - **Probability** – *The probability of the impact/risk occurring:*
 - *Extremely unlikely (little to no chance of occurring);*
 - *Very unlikely (<30% chance of occurring);*
 - *Unlikely (30-50% chance of occurring)*
 - *Likely (51 – 90% chance of occurring); or*
 - *Very Likely (>90% chance of occurring regardless of prevention measures).*

- **Step 5:** *Use both the **consequence** and **probability** to determine the **significance** of the identified impact/risk (qualitatively as shown in Figure 1). Significance definitions and rankings are provided below:*

Probability	Very Likely					Very High Risk/Impact
	Likely					High Risk/Impact
	Unlikely				Moderate Risk/Impact	
	Very Unlikely		Low Risk/Impact			
	Extremely Unlikely	Very Low Risk/Impact				
		Slight	Moderate	Substantial	Severe	Extreme
		Consequence**				
		**[Qualitatively determined based on Spatial Extent, Duration, Reversibility and Irreplaceability]				

Figure 1. Guide to assessing risk/impact significance as a result of consequence and probability.

- **Significance** – Will the impact cause a notable alteration of the environment?
 - Very low (the risk/impact may result in very minor alterations of the environment and can be easily avoided by implementing appropriate mitigation measures, and will not have an influence on decision-making);
 - Low (the risk/impact may result in minor alterations of the environment and can be easily avoided by implementing appropriate mitigation measures, and will not have an influence on decision-making);
 - Moderate (the risk/impact will result in moderate alteration of the environment and can be reduced or avoided by implementing the appropriate mitigation measures, and will only have an influence on the decision-making if not mitigated);
 - High (the risk/impact will result in major alteration to the environment even with the implementation on the appropriate mitigation measures and will have an influence on decision-making); and
 - Very high (the risk/impact will result in very major alteration to the environment even with the implementation on the appropriate mitigation measures and will have an influence on decision-making (i.e. the project cannot be authorised unless major changes to the engineering design are carried out to reduce the significance rating)).

With the implementation of mitigation measures, the residual impacts/risks are ranked as follows in terms of significance:

- Very low = 5;
- Low = 4;
- Moderate = 3;
- High = 2; and
- Very high = 1.

The specialists must provide a written supporting motivation of the assessment ratings provided.

- **Step 6: Determine the Confidence Level** – The degree of confidence in predictions based on available information and specialist knowledge:
 - Low;
 - Medium; or

- *High.*

ANNEXURE C

Tony Barbour

ENVIRONMENTAL CONSULTING AND RESEARCH

10 Firs Avenue, Claremont, 7708, South Africa
(Tel) 27-21-761 2355 - (Fax) 27-21-761 2355 - (Cell) 082 600 8266
(E-Mail) tbarbour@telkomsa.net

Tony Barbour's has 26 years' experience in the field of environmental consulting and management. His experience includes working for ten years as a consultant in the private sector followed by four years at the University of Cape Town's Environmental Evaluation Unit. He has worked as an independent consultant since 2004, with a key focus on Social Impact Assessment. His other areas of interest include Strategic Environmental Assessment and review work.

EDUCATION

- BSc (Geology and Economics) Rhodes (1984);
- B Economics (Honours) Rhodes (1985);
- MSc (Environmental Science), University of Cape Town (1992)

EMPLOYMENT RECORD

- Independent Consultant: November 2004 – current;
- University of Cape Town: August 1996-October 2004: Environmental Evaluation Unit (EEU), University of Cape Town. Senior Environmental Consultant and Researcher;
- Private sector: 1991-August 2000: 1991-1996: Ninham Shand Consulting (Now Aurecon, Cape Town). Senior Environmental Scientist; 1996-August 2000: Steffen, Robertson and Kirsten (SRK Consulting) – Associate Director, Manager Environmental Section, SRK Cape Town.

LECTURING

- University of Cape Town: Resource Economics; SEA and EIA (1991-2004);
- University of Cape Town: Social Impact Assessment (2004-current);
- Cape Technikon: Resource Economics and Waste Management (1994-1998);
- Peninsula Technikon: Resource Economics and Waste Management (1996-1998).

RELEVANT EXPERIENCE AND EXPERTISE

Tony Barbour has undertaken in the region of 260 SIA's, including SIA's for infrastructure projects, dams, pipelines, and roads. All of the SIAs include interacting with and liaising with affected communities. In addition, he is the author of the Guidelines for undertaking SIA's as part of the EIA process commissioned by the Western Cape Provincial Environmental Authorities in 2007. These guidelines have been used throughout South Africa.

Tony was also the project manager for a study commissioned in 2005 by the then South African Department of Water Affairs and Forestry for the development of a Social Assessment and Development Framework. The aim of the framework was to enable the Department of Water Affairs and Forestry to identify, assess and manage social impacts associated with large infrastructure projects, such as dams. The study also included the development of guidelines for Social Impact Assessment, Conflict Management, Relocation and Resettlement and Monitoring and Evaluation.

Countries with work experience include South Africa, Namibia, Angola, Botswana, Zambia, Lesotho, Swaziland, Ghana, Senegal, Nigeria, Mozambique, Mauritius, Kenya, Ethiopia, Oman, South Sudan, Sudan and Armenia.

ANNEXURE D



environmental affairs

Department:
Environmental Affairs
REPUBLIC OF SOUTH AFRICA

DETAILS OF THE SPECIALIST, DECLARATION OF INTEREST AND UNDERTAKING UNDER OATH

File Reference Number:	(For official use only)
NEAS Reference Number:	DEA/EIA/
Date Received:	

Application for authorisation in terms of the National Environmental Management Act, Act No. 107 of 1998, as amended and the Environmental Impact Assessment (EIA) Regulations, 2014, as amended (the Regulations)

PROJECT TITLE

Scoping and Environmental Impact Assessment Processes for the Proposed Development of 12 Solar Photovoltaic (PV) Facilities and associated infrastructure (i.e. Kudu Solar Facility 1 - 12), near De Aar, Northern Cape

Kindly note the following:

1. This form must always be used for applications that must be subjected to Basic Assessment or Scoping & Environmental Impact Reporting where this Department is the Competent Authority.
2. This form is current as of 01 September 2018. It is the responsibility of the Applicant / Environmental Assessment Practitioner (EAP) to ascertain whether subsequent versions of the form have been published or produced by the Competent Authority. The latest available Departmental templates are available at <https://www.environment.gov.za/documents/forms>.
3. A copy of this form containing original signatures must be appended to all Draft and Final Reports submitted to the department for consideration.
4. All documentation delivered to the physical address contained in this form must be delivered during the official Departmental Officer Hours which is visible on the Departmental gate.
5. All EIA related documents (includes application forms, reports or any EIA related submissions) that are faxed; emailed; delivered to Security or placed in the Departmental Tender Box will not be accepted, only hardcopy submissions are accepted.

Departmental Details

Postal address:
Department of Environmental Affairs
Attention: Chief Director: Integrated Environmental Authorisations
Private Bag X447
Pretoria
0001

Physical address:
Department of Environmental Affairs
Attention: Chief Director: Integrated Environmental Authorisations
Environment House
473 Steve Biko Road
Arcadia

Queries must be directed to the Directorate: Coordination, Strategic Planning and Support at:
Email: EIAAdmin@environment.gov.za

ENVIRONMENTAL IMPACT ASSESSMENT REPORT: Scoping and Environmental Impact Assessment (EIA) Process for the Proposed Development of a Solar Photovoltaic (PV) Facility (Kudu Solar Facility 1) and associated infrastructure, near De Aar, Northern Cape Province

1. SPECIALIST INFORMATION

Specialist Company Name:	Tony Barbour Environmental Consulting		
B-BBEE	Contribution level (indicate 1 to 8 or non-compliant)	4	Percentage Procurement recognition
			100%
Specialist name:	Tony Barbour		
Specialist Qualifications:	BEcon (Hons). MSc (Environmental Science)		
Professional affiliation/registration:	IAIA		
Physical address:	10 Firs Avenue, Claremont		
Postal address:	10 Firs Avenue, Claremont		
Postal code:	7708	Cell:	082 600 8266
Telephone:	021-7971361	Fax:	
E-mail:	tony@tonybarbour.co.za , tbarbour@telkomsa.net		

2. DECLARATION BY THE SPECIALIST

I, Tony Barbour, declare that –

- I act as the independent specialist in this application;
- I will perform the work relating to the application in an objective manner, even if this results in views and findings that are not favourable to the applicant;
- I declare that there are no circumstances that may compromise my objectivity in performing such work;
- I have expertise in conducting the specialist report relevant to this application, including knowledge of the Act, Regulations and any guidelines that have relevance to the proposed activity;
- I will comply with the Act, Regulations and all other applicable legislation;
- I have no, and will not engage in, conflicting interests in the undertaking of the activity;
- I undertake to disclose to the applicant and the competent authority all material information in my possession that reasonably has or may have the potential of influencing - any decision to be taken with respect to the application by the competent authority; and - the objectivity of any report, plan or document to be prepared by myself for submission to the competent authority;
- all the particulars furnished by me in this form are true and correct; and
- I realise that a false declaration is an offence in terms of regulation 48 and is punishable in terms of section 24F of the Act.



Signature of the Specialist

Tony Barbour Environmental Consulting

Name of Company:

4 July 2023

Date

Details of Specialist, Declaration and Undertaking Under Oath

3. UNDERTAKING UNDER OATH/ AFFIRMATION

I, Tony Barbour, swear under oath / affirm that all the information submitted or to be submitted for the purposes of this application is true and correct.



Signature of the Specialist

Tony Barbour Environmental Consulting

Name of Company

4 July 2023

Date



Signature of the Commissioner of Oaths

4 July 2023

Date





environmental affairs

Department:
Environmental Affairs
REPUBLIC OF SOUTH AFRICA

DETAILS OF THE SPECIALIST, DECLARATION OF INTEREST AND UNDERTAKING UNDER OATH

File Reference Number:	(For official use only)
NEAS Reference Number:	DEA/EIA/
Date Received:	

Application for authorisation in terms of the National Environmental Management Act, Act No. 107 of 1998, as amended and the Environmental Impact Assessment (EIA) Regulations, 2014, as amended (the Regulations)

PROJECT TITLE

Scoping and Environmental Impact Assessment Processes for the Proposed Development of 12 Solar Photovoltaic (PV) Facilities and associated infrastructure (i.e. Kudu Solar Facility 1 - 12), near De Aar, Northern Cape

Kindly note the following:

1. This form must always be used for applications that must be subjected to Basic Assessment or Scoping & Environmental Impact Reporting where this Department is the Competent Authority.
2. This form is current as of 01 September 2018. It is the responsibility of the Applicant / Environmental Assessment Practitioner (EAP) to ascertain whether subsequent versions of the form have been published or produced by the Competent Authority. The latest available Departmental templates are available at <https://www.environment.gov.za/documents/forms>.
3. A copy of this form containing original signatures must be appended to all Draft and Final Reports submitted to the department for consideration.
4. All documentation delivered to the physical address contained in this form must be delivered during the official Departmental Officer Hours which is visible on the Departmental gate.
5. All EIA related documents (includes application forms, reports or any EIA related submissions) that are faxed; emailed; delivered to Security or placed in the Departmental Tender Box will not be accepted, only hardcopy submissions are accepted.

Departmental Details

Postal address:
Department of Environmental Affairs
Attention: Chief Director: Integrated Environmental Authorisations
Private Bag X447
Pretoria
0001

Physical address:
Department of Environmental Affairs
Attention: Chief Director: Integrated Environmental Authorisations
Environment House
473 Steve Biko Road
Arcadia

Queries must be directed to the Directorate: Coordination, Strategic Planning and Support at:
Email: EIAAdmin@environment.gov.za

1. SPECIALIST INFORMATION

Specialist Company Name:	freelance (for Tony Barlow Environmental)		
B-BBEE	Contribution level (indicate 1 to 8 or non-compliant)	n.a.	Percentage Procurement recognition
			n.a.
Specialist name:	Schalk vd Meer		
Specialist Qualifications:	MPhil (Environmental science)		
Professional affiliation/registration:	none		
Physical address:	12 Glen Alpine, Dassenpark Rd, Vredendag		
Postal address:			
Postal code:	9001	Cell:	082 0800 521
Telephone:	08 021 461 4579	Fax:	
E-mail:	lilah@mweb.co.za		

2. DECLARATION BY THE SPECIALIST

I, Schalk van der Meer, declare that -

- I act as the independent specialist in this application;
- I will perform the work relating to the application in an objective manner, even if this results in views and findings that are not favourable to the applicant;
- I declare that there are no circumstances that may compromise my objectivity in performing such work;
- I have expertise in conducting the specialist report relevant to this application, including knowledge of the Act, Regulations and any guidelines that have relevance to the proposed activity;
- I will comply with the Act, Regulations and all other applicable legislation;
- I have no, and will not engage in, conflicting interests in the undertaking of the activity;
- I undertake to disclose to the applicant and the competent authority all material information in my possession that reasonably has or may have the potential of influencing - any decision to be taken with respect to the application by the competent authority; and - the objectivity of any report, plan or document to be prepared by myself for submission to the competent authority;
- all the particulars furnished by me in this form are true and correct; and
- I realise that a false declaration is an offence in terms of regulation 48 and is punishable in terms of section 24F of the Act.



Signature of the Specialist

(freelance)
Name of Company:

2023-05-25
Date

Details of Specialist, Declaration and Undertaking Under Oath

3. UNDERTAKING UNDER OATH/ AFFIRMATION

I, Schalk van der Elawe, swear under oath / affirm that all the information submitted or to be submitted for the purposes of this application is true and correct.

Signature of the Specialist

TBEL (freelance ter)
Name of Company

2023-05-24
Date

Signature of the Commissioner of Oaths

2023/05/24
Date





CHAPTER 14: Traffic Impact Assessment



TRAFFIC ENGINEERING SPECIALIST ASSESSMENT:

**Scoping and Environmental Impact Assessment (EIA)
Process for the Proposed Development of a Solar
Photovoltaic Facility (Kudu Solar Facility 1) and associated
infrastructure, near De Aar, Northern Cape Province**

<i>Report prepared for:</i>	<i>Report prepared by:</i>
CSIR – Environmental Management Services P O Box 320 Stellenbosch 7599 South Africa	Sturgeon Consulting 7 Waterberg Crescent, Clara Anna Fontein Durbanville 7550 South Africa

Version 1: March 2023

A graphic consisting of a dark blue curved shape on the left and a light blue curved shape on the right, resembling a stylized 'C' or a swoosh. The text 'EXECUTIVE SUMMARY' is written in white, uppercase letters across the light blue section.

EXECUTIVE SUMMARY

The purpose of the Traffic Engineering Impact Assessment of the proposed Kudu Solar Photovoltaic (PV) Facility 1 is to investigate the transport implications associated with the abnormal load vehicles transporting components, construction material, equipment and labourers to the site during the construction, operational and decommissioning phases of the project.

The construction phase will primarily consist of the removal of vegetation, excavation for infrastructure, the establishment of a laydown area for equipment, the transportation of materials and equipment to site and the construction of the solar field and additional infrastructure. The operational phase of the project is expected to be approximately 20 years and will primarily consist of the generation and supply of electricity from the proposed solar facility, the cleaning of the solar panels and the maintenance of the solar field and infrastructure. The purpose of the decommissioning phase is to return the land to its original condition before construction.

During the proposed project, the construction site will need to be accessed by single-unit trucks transporting building materials, double axel trucks transporting 40 foot long containers containing the solar panels, frames and inverters, minibus taxis and buses transporting labourers and abnormal load trucks transporting the transformers.

The report proposed three different access routes to the site and the preferred route was identified as the route between the Port of Ngqura and the site. The preferred haulage route is approximately 545 km and follows the N2 from the Port and then turns north onto the N10 to De Aar. From De Aar, the R48 can be taken east up to the access point of the site. Various provincial roads can provide access to the site via the R48 (Trunk Road 38/1 and Trunk Road 38/02). The preferred access is from the surfaced Divisional Road 3093 (DR3093), located along the R48, approximately 45km north-east of De Aar. This access will provide direct access from a surfaced road and sufficient shoulder sight distances (SSD) are available.

Access Route Option 1 will require the removal of the existing island at the TR38/01 and DR3093 intersection to accommodate the turning movements of the abnormal load vehicles. For Access Route Option 2, widening of the intersection at TR38/01 and MR790 will be required (the widening will exceed 6 m at certain points) and the widening of the MR790/DR3093 intersection by approximately 60m² and widening of the DR3093/DR3084 intersection by 170m² (the widening will exceed 6 m at certain points) will also be required. Access Route Option 3 will require the widening of the intersection at TR38/02 and DR3096 (the widening will exceed 4 m at certain points) and localised widening will be required along DR3096 at two locations (approximately 56m² and 50m²).

Temporary SANRAL counting stations indicated the Average Daily Traffic (ADT) as approximately 62 vehicles (two-way) along DR3093 and approximately 8 vehicles (two-way) along Divisional Road 3084 (DR3084) per day in 2011. These numbers indicate that there are extremely low volumes of traffic along these roads in the vicinity of the site. Permanent SANRAL traffic counting stations, Station

13730 and Station 13731, are located along the R389 and the R48, respectively. The traffic information for 2021 indicated that the R389 carries an ADT of 626 vpd (two-way) and the R48 carries an ADT of 866 vpd (two-way). The R389 and the R48 both operate well below the capacity of 2000 vehicles per hour for a Class 1 principal arterial with two lanes.

Traffic will be generated during the construction, operational and decommissioning phases of the project. During the construction phase it is expected that trips will be generated by the transportation of materials and equipment, the transportation of labourers and the transportation of water for construction and dust control purposes. It was determined that a total of **30 daily trips (two-way)** will be generated by the proposed Solar PV Facility. During the decommissioning phase it is expected that the same number of trips will be generated as during the construction phase. During the operational phase it is expected that trips will be generated by the transportation of maintenance equipment, the transportation of labourers and the transportation of water for the cleaning of the solar panels and dust control purposes. It was determined that a total of **10 daily trips (two-way)** will be generated by the proposed Solar PV Facility.

Potential transport and traffic related impacts were identified for the different phases of the project. During the construction and decommissioning phases potential impacts include congestion and delays on the surrounding road network (very low impact significance), the impact on traffic safety and an increase in accidents (moderate impact significance), change in the quality of the surface conditions of the road (very low impact significance), dust pollution (low impact significance) and noise pollution (low impact significance). During the operational phase the traffic generated will have an insignificant impact on the surrounding road network.

To further mitigate the effects of the expected daily traffic impact on the existing road network during the construction and decommissioning phases it is proposed that delivery times be staggered and the transportation of labourers trips be scheduled outside of peak hours where possible, speed control by means of a stop-and-go be implemented within the construction site along with ensuring all vehicles are roadworthy, visible, adequately marked and operated by a licenced operator, regular maintenance of the internal farm access road and dust control be implemented on gravel roads within the construction site. If the mitigation measures are implemented the construction phase will have an overall low to very low impact significance, the operational phase will have an insignificant impact and the decommissioning phase will have a low to very low impact significance, similar to the construction phase.

It is very unlikely that all 12 Kudu PV projects will occur at the same time and construction will most likely be staggered based on project and site-specific aspects. However, the potential cumulative traffic impact related to the construction and decommissioning phases were investigated in this report. The cumulative traffic impact related to the operational phase can still be regarded as insignificant. If the mitigations are implemented the construction phase will have an overall low to very low impact significance, the operational phase will have an insignificant impact and the decommissioning phase will have a low to very low impact significance.

No other remedial or mitigation measures will be required to accommodate the additional traffic generated by the proposed project. Provided that the recommendations provided in this report are adhered to, the proposed development of the Solar PV facility can be supported from a traffic engineering perspective.



CONTENTS

14. TRAFFIC IMPACT ASSESSMENT	14-8
14.1 Introduction	14-8
14.1.1 Scope, Purpose and Objectives of this Specialist Report	14-8
14.1.2 Details of Specialist	14-9
14.1.3 Terms of Reference	14-9
14.2 Approach and Methodology	14-11
14.2.1 Information Sources	14-11
14.2.2 Assumptions, Knowledge Gaps and Limitations	14-12
14.2.3 Consultation Processes Undertaken	14-12
14.3 Description of Project Aspects relevant to Traffic Engineering Assessment	14-13
14.3.1 Construction Phase	14-13
14.3.2 Operational Phase	14-13
14.3.3 Decommissioning Phase	14-13
14.3.4 Transportation Requirements	14-13
14.4 Baseline Environmental Description	14-14
14.4.1 Study Area Definition	14-14
14.4.2 General Description – Existing Road Network	14-14
14.4.2.1 Haulage of Imported Materials	14-16
14.4.2.2 Main Roads in the Vicinity of the Site	14-18
14.4.2.3 Main Access Considerations	14-19
14.4.2.3.1 Access Route Option 1	14-22
14.4.2.3.2 Access Route Option 2	14-23
14.4.2.3.3 Access Route Option 3	14-24
14.4.3 Project Specific Description	14-26
14.4.3.1 Kudu Solar Facility 1 and associated infrastructure	14-26
14.4.4 Identification of Environmental Sensitivities	14-27
14.4.4.1 Sensitivities identified by the National Web-Based Environmental Screening Tool	14-27
14.4.5 Preliminary Vehicle Tracking Analysis and Road Widening/Lengthening Investigation	14-27
14.4.5.1.1 Access Route Option 1	14-29
14.4.5.1.2 Access Route Option 2	14-30
14.4.5.1.3 Access Route Option 3	14-31
14.4.5.2 Conclusion Statement	14-32
14.5 Existing Traffic Conditions	14-34

14.6	Trip Generation Rates	14-36
14.6.1	Construction Phase	14-36
14.6.2	Operational Phase	14-37
14.6.3	Decommissioning Phase	14-38
14.7	Trip Generation Summary	14-38
14.8	Issues, Risks and Impacts	14-39
14.8.1	Identification of Potential Impacts/Risks	14-39
14.8.1.1	Construction Phase	14-39
14.8.1.2	Operational Phase	14-39
14.8.1.3	Decommissioning Phase	14-39
14.8.1.4	Cumulative Impacts	14-40
14.8.2	Summary of Issues identified during the Public Consultation Phase	14-40
14.9	Impact Assessment	14-41
14.9.1	Potential Impacts during the Construction Phase	14-41
14.9.1.1	Impact 1: Potential congestion and delays on the surrounding road network.	14-41
14.9.1.2	Impact 2: Potential impact on traffic safety and increase in accidents with other vehicles or animals.	14-41
14.9.1.3	Impact 3: Potential change in the quality of the surface condition of the roads.	14-41
14.9.1.4	Impact 4: Potential noise pollution.	14-42
14.9.1.5	Impact 5: Potential dust pollution.	14-42
14.9.1.6	Impact Summary Tables: Construction Phase	14-42
14.9.2	Potential Impacts during the Operational Phase	14-45
14.9.3	Potential Impacts during the Decommissioning Phase	14-45
14.9.3.1	Impact 1: Potential congestion and delays on the surrounding road network.	14-45
14.9.3.2	Impact 2: Potential impact on traffic safety and increase in accidents with other vehicles or animals.	14-45
14.9.3.3	Impact 3: Potential change in the quality of the surface condition of the roads.	14-45
14.9.3.4	Impact 4: Potential noise pollution.	14-46
14.9.3.5	Impact 5: Potential dust pollution.	14-46
14.9.3.6	Impact Summary Tables: Decommissioning Phase	14-46
14.9.4	Cumulative Impacts	14-49
14.9.5	Battery Energy Storage System	14-56
14.9.6	No-Go Option	14-56
14.10	Impact Assessment Summary	14-56
14.11	Legislative and Permit Requirements	14-57
14.12	Environmental Management Programme Inputs	14-57
14.13	Final Specialist Statement and Authorisation Recommendation	14-65
14.13.1	Statement and Reasoned Opinion	14-65
14.13.2	EA Condition Recommendations	14-66
14.14	References	14-67
APPENDICES		14-68

Appendix A - Specialist Expertise	14-69
Appendix B - Specialist Statement of Independence	14-74
Appendix C: Site Sensitivity Verification	14-77
Appendix D: Impact Assessment Methodology	14-78
Appendix E: Compliance with the Appendix 6 of the 2014 EIA Regulations (as amended)	14-83

TABLES

Table 14-1: Main Roads in the Vicinity of the Site	14-18
Table 14-2: Potential Access Roads	14-21
Table 14-3: Station 13730 and Station 13731 Count Data	14-35
Table 14-4: Rating of Traffic Related Impacts During the Construction Phase	14-43
Table 14-5: Rating of Traffic Related Impacts During the Decommissioning Phase	14-47
Table 14-6: Proposed renewable energy and EGI projects, located within 30 km of the proposed Kudu Solar Facilities, that are considered in the Cumulative Impact Assessment (Source: DFFE REEA, Quarter 4, 2022; and SAHRIS)	14-51
Table 14-7: Rating of Cumulative Traffic Related Impacts during the Construction and Decommissioning Phase	14-54
Table 14-8: Overall Impact Significance (Post Mitigation)	14-56
Table 14-9: Environmental Management Programme for Traffic Impacts	14-58

FIGURES

Figure 14-1: Locality Plan	14-8
Figure 14-2: Proposed Kudu Solar PV1 Facility	14-15
Figure 14-3: Preferred Route	14-16
Figure 14-4: Proposed Route: Alternative 1	14-17
Figure 14-5: Proposed Route: Alternative 2	14-17
Figure 14-6: Main Roads in the Vicinity of the Site	14-19
Figure 14-7: Proposed Kudu Solar PV Facility Gravel Roads	14-20
Figure 14-8: Proposed Access Roads	14-22
Figure 14-9: Divisional Road 3093	14-23
Figure 14-10: Main Road 790	14-24
Figure 14-11: Divisional Road 3096	14-25

Figure 14-12: Kudu Solar Facility 1 (PV1) _____	14-26
Figure 14-13: Kudu Solar Facility 1 (PV1) Access Location _____	14-27
Figure 14-14: Abnormal Design Vehicle _____	14-29
Figure 14-15: Intersection Design _____	14-29
Figure 14-16: DR3093 and TR38/01 Intersection _____	14-30
Figure 14-17: MR790 and TR38/01 Intersection _____	14-30
Figure 14-18: Access Route Option 2 Road Widening Requirements _____	14-31
Figure 14-19: Access Route Option 3 Road Widening Requirements _____	14-31
Figure 14-20: Access Route Option 3 Road Widening Requirements _____	14-32
Figure 14-21: Road Widening Width at TR38/01 and MR790 and DR3093 and DR3084 intersections _____	14-33
Figure 14-22: Road Widening Width at TR38/02 and DR3096 intersection _____	14-33
Figure 14-23: Location of Temporary Count Stations _____	14-34
Figure 14-24: Location of Permanent Count Stations _____	14-35
Figure 14-25: SANRAL Station 13730 and Station 13731 Historic Count Information _____	14-36
Figure 14-26: Renewable Energy Developments and EGI within 30km Radius _____	14-50

ABBREVIATIONS

Abbreviations	
ADT	Average Daily Traffic
EIA	Environmental Impact Assessment
BA	Basic Assessment
DEA	Department of Environmental Affairs
PV	Photovoltaic
TIS	Traffic Impact Study
vph	Vehicles per Hour
COTO	Committee of Transport Officials
AMP	Access Management Plan
RCAM	Road Classification and Access Management Manual
LOS	Level of Service
AM	Morning
PM	Afternoon
SEF	Solar Energy Facility

14. TRAFFIC IMPACT ASSESSMENT

This chapter includes the Traffic Engineering Impact Assessment Specialist Assessment that was prepared by Sturgeon Consulting as part of the Scoping and Environmental Impact Assessment (EIA) Process for the proposed development of the Kudu Solar Facility 1 and associated infrastructure, near De-Aar, Northern Cape Province.

14.1 Introduction

14.1.1 Scope, Purpose and Objectives of this Specialist Report

ABO Wind is intending to develop a Solar Photovoltaic (PV) cluster, located to the northeast of De Aar in the Northern Cape Province, as shown in Figure 14-1. The project will entail the proposed development of 12 Solar PV facilities and associated electrical infrastructure. Each PV facility will have an estimated capacity ranging from up to 50 MWac to 350 MWac. This Traffic Impact Assessment (TIA) focuses on the Traffic Impact associated with Kudu Solar Facility 1, although the cumulative impact of all 12 Solar PV facilities will also be considered.

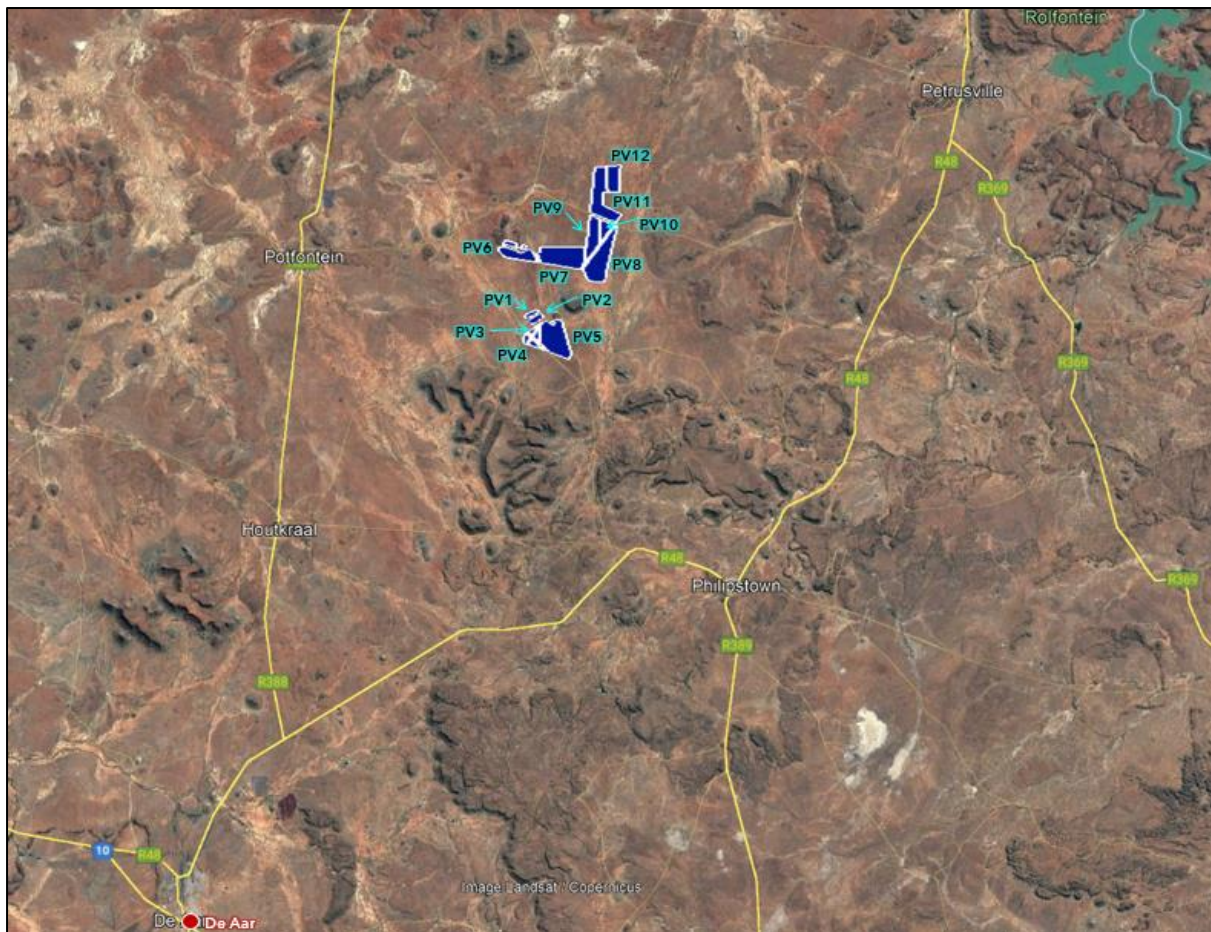

Figure 14-1: Locality Plan

The scope of the Traffic Engineering Impact Assessment is to investigate the transportation implications associated with the abnormal load vehicles transporting components to the site and the transportation of construction materials, equipment and workers to the site during the construction and operational phases.

The report identifies the preferred access route to the site, comments on the condition of the existing roads in the vicinity of the site and identifies possible access points to the site.

The primary purpose of this Traffic Engineering Impact Assessment is therefore to provide a specialist assessment of potential traffic related impacts in accordance with the requirements of Appendix 6 of the 2014 National Environmental Management Act (Act 107 of 1998, as amended) (NEMA) EIA Regulations (as amended).

Separate reports have been compiled for each PV facility. This chapter only addresses Kudu Solar Facility 1 (hereafter referred to as the “Kudu Solar Facility 1” or “proposed project”).

14.1.2 Details of Specialist

This specialist assessment has been undertaken by Annebet Krige of Sturgeon Consulting (Pty) Ltd, Traffic Engineering and Transport Planning Specialists. Annebet Krige is registered with the Engineering Council of South Africa with Registration Number 20150161 in the field of Traffic Engineering. A curriculum vitae is included in Appendix A of this specialist input report.

In addition, a signed specialist statement of independence is included in Appendix B of this specialist input report.

14.1.3 Terms of Reference

The Terms of Reference for the TIA include:

- Extent of the traffic study and study area, including a description of the traffic and transportation context of the study area, focusing on aspects that are potentially affected by the proposed project;
- Site Observations by undertaking a site visit to gather relevant information in terms of access, road conditions etc. and to confirm if there are any aspects that need to be considered in the layout planning;
- Proposed development description in relation to traffic related impacts;
- Describe the baseline transport and traffic condition of the study area, as well as identified traffic features and potential traffic disturbances of the local area;
- Existing and Future Road Planning;
- Existing traffic volumes on external road network;
- Access Assessment;
- Acceptability from a traffic safety point of view of the location of the access route(s) to the proposed facility;
- Trip generation of the proposed development during Construction, Operation and Decommissioning;
- A description of assumptions and limitations;

- Consideration of the project layout;
- Determine the national and local haulage routes between port of entry/manufacturer and site;
- Assessment of freight requirements and permitting needed for abnormal loads;
- Risk posed by construction and operational vehicles;
- Consider traffic issues such as impact on the road network, congestion etc.;
- Impact assessment of the potential direct, indirect and cumulative impacts of the proposed development on the receiving environment from a traffic perspective;
- Based on existing volumes of traffic, recommendations for mitigations measures for traffic impacts where relevant;
- Determine mitigation and/or management measures, which could be implemented to as far as possible, reduce the effect of negative impacts and enhance the effect of positive impacts. Identify best practice management actions, monitoring requirements, and rehabilitation guidelines for all identified impacts for inclusion in the Environmental Management Programme (EMPr);
- Identification of any additional protocols, licensing and/or permitting requirements that are relevant to the project and the implications thereof;
- A reasoned opinion indicating the acceptability of the proposed development and a recommendation if the development should go ahead or not.

14.2 Approach and Methodology

The report assesses possible access routes for the haulage of imported materials, the road network surrounding the proposed facility, possible access options and the traffic impact of the proposed facility on the surrounding road network in the vicinity of the site during the Construction, Operational and Decommissioning phases of the project.

The broad methodology to be adopted for this specialist study is as follows:

- Site visit:
 - 23 and 24 March 2022.
 - Review of project background information.
 - Literature review and internet research.
- Access Routes and Access Point Assessment:
 - Evaluation of proposed access configurations.
 - Assessment of potential access roads.
- Traffic Impact:
 - Assessment of typical trip generation during the Construction, Operation and Decommissioning phases of the project.
 - Assessment of potential traffic impacts.
- Liaison with Applicant and/or project team.
- Preparation of report and figures.

14.2.1 Information Sources

The main information sources used for this Traffic Engineering Impact Assessment are listed below:

Data / Information	Source	Date	Type	Description
TMH 16 Volume 1 South African Traffic Impact and Site Traffic Assessment Manual	Committee of Transport Officials	August 2012	Manual	Requirements for Traffic Impact Studies in South Africa.
National Road Traffic Act, 1996 (Act No. 93 of 1996)	Department of Transport	1996	Government Gazette	To provide for road traffic matters which shall apply uniformly throughout the Republic and for matters connected therewith.
Amendment of the National Road Traffic Regulations	Department of Transport	2014	Government Notice	Regulations to the National Road Traffic Act, 1996 (Act No. 93 of 1996)
TRH 11: Dimensional and Mass Limitations and Other Requirements for Abnormal Load Vehicles	Department of Transport	August 2009	Government Notice	Description of abnormal loads and vehicle configurations and methods to determine road pavement damage

Data / Information	Source	Date	Type	Description
TRH 11: Guidelines for Granting of Exemption Permits for the Conveyance of Abnormal Loads and for other events on Public Roads	Committee of State Road Authorities	March 2000	Report	Rules and Conditions which apply to the transport of abnormal loads and vehicles on public roads.

In addition to the above, the following Information was also used:

- Project Information provided by the Environmental Assessment Practitioner (EAP) and Applicant;
- Google Earth files provided by the EAP and Applicant;
- Google Earth Satellite Imagery;
- Information gathered during the site visit; and
- Project research of all available information.

14.2.2 Assumptions, Knowledge Gaps and Limitations

The following assumptions, knowledge gaps and limitations apply:

- The study is based on information supplied by the Applicant (ABO Wind) and the Environmental Consultants (CSIR);
- Haulage and access will be limited to existing surfaced national and provincial and gravel roads;
- The internal farm roads within the boundary of the PV Facility will not be included in this study;
- Construction materials are to be sourced and transported from local manufacturers where possible;
- All imported materials are to be transported from the nearest, most viable port of entry;
- Maximum vertical height clearance along the haulage route is 5.2m for abnormal loads.
- The power lines that will be constructed to facilitate grid connection, and the associated Main Transmission Substation and 400 KV Loop-in-Loop-Out (LILO) are subjected to separate Basic Assessment and/or Standard Registration Processes, and do not require a Traffic Impact Assessment.

14.2.3 Consultation Processes Undertaken

Due to the significance of the traffic related impact, no specific consultation processes were deemed necessary or undertaken for this specialist assessment.

14.3 Description of Project Aspects relevant to Traffic Engineering Assessment

The project can be divided into the following three main phases:

- Construction Phase;
- Operational Phase; and
- Decommissioning Phase.

14.3.1 Construction Phase

The main activities that will form part of the construction phase are:

- Removal of vegetation for the proposed infrastructure, where necessary, within the approved development footprint to facilitate the construction and/or establishment of infrastructure. Note that vegetation is planned to be trimmed within the PV array area (and not removed completely);
- Excavations for infrastructure and associated infrastructure;
- Establishment of a laydown area for equipment;
- Stockpiling of topsoil and cleared vegetation, where necessary (except for the PV array);
- Creation of employment opportunities and associated transport of employees to and from site;
- Transportation of material and equipment to site; and
- Construction of the solar field and additional infrastructure.

14.3.2 Operational Phase

The following activities will occur during the operational phase:

- The generation of electricity from the proposed solar facility and supply of electricity;
- Cleaning of panels and maintenance of the solar field and infrastructure.
- During the life span of the project (approximately 20 years), on-going cleaning and maintenance will be required on a scheduled basis.

14.3.3 Decommissioning Phase

The main aim of decommissioning is to return the land to its original, pre-construction condition. Should the unlikely need for decommissioning arise (i.e. if the actual solar facility becomes outdated or the land needs to be used for other purposes), the decommissioning procedures will be undertaken and the site will be rehabilitated and returned to its pre-construction state.

14.3.4 Transportation Requirements

During the project cycle, it is anticipated that the following vehicles will need to access the site:

- Building materials are to be transported by single-unit trucks within the road freight limitations of South Africa.

- Solar panels, frames and inverters are to be transported in 40 foot long containers (which have exterior dimensions of 12.19 m long x 2.44 m wide x 2.59 m high) on double axle trucks within the road freight limitations of South Africa.
- Workers from the surrounding area will be transported by taxi (mini-bus)/bus/shuttle or private car.
- Transformers will be transported by abnormal load trucks for which a permit will need to be applied for in terms of Section 81 of the National Road Traffic Act and authorisation needs to be obtained from the relevant road authorities to modify the road reserve to accommodate turning movements at intersections.

14.4 Baseline Environmental Description

14.4.1 Study Area Definition

The study area for the proposed Kudu Solar Facilities 1 to 12 is the full extent of the eight affected farm properties on which the proposed PV Facilities will be constructed. The full extent of these properties has been assessed in this study in order to identify environmental sensitivities and no-go areas. The total **study area** for Kudu Solar Facilities 1 to 12 is approximately 8 150 hectares (ha).

At the commencement of this Scoping and EIA Process, the **Original Scoping Buildable Areas**, which fall within the study area, were identified by the Project Developer following the completion of high-level environmental screening based on the Screening Tool.

Following the identification of sensitivities during the Scoping Phase, the Project Developer considered such sensitivities and formulated the **Revised Scoping Buildable Areas**. The **Revised Scoping Buildable Areas** were used to inform the design of the layout and further assessed during this EIA Phase of the project in order to identify the preferred development footprint of the proposed project on the approved site as contemplated in the accepted Scoping Report. The development footprint is where the actual development will be located, i.e. the footprint containing the PV solar arrays and associated infrastructure.

14.4.2 General Description – Existing Road Network

The proposed Kudu Solar PV 1 facility will be located to the north-east of De Aar in the Northern Cape as shown in Figure 14-2.

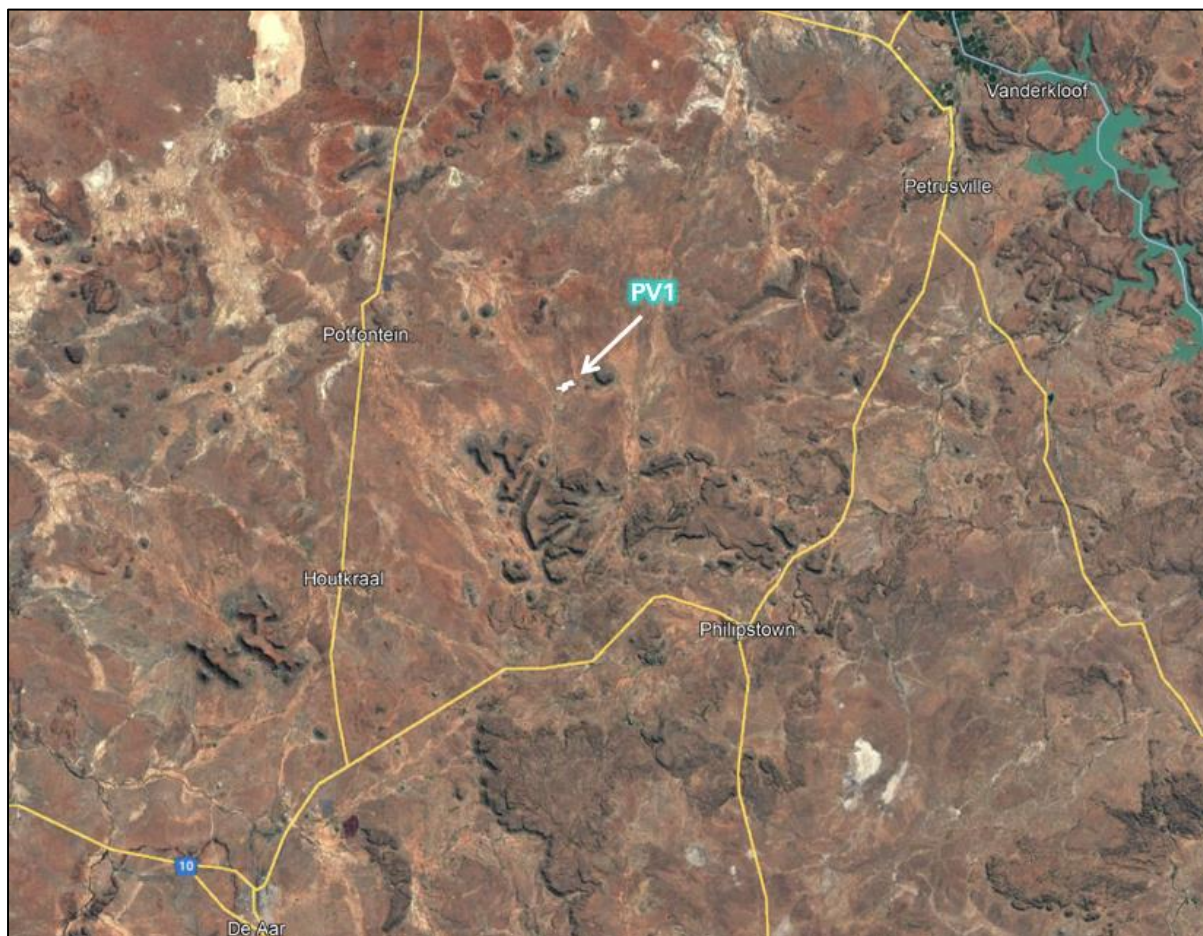

Figure 14-2: Proposed Kudu Solar PV1 Facility

14.4.2.1 Haulage of Imported Materials

There are three options for the haulage of imported materials to the proposed PV facility as shown in the figures below. The preferred option will be the route from the Port of Ngqura as shown in Figure 14-3. The route is approximately 545 km and follows the N2 from the Port and then turns north onto the N10 to De Aar. From De Aar, the R48 can be taken east up to the access point to the sites.

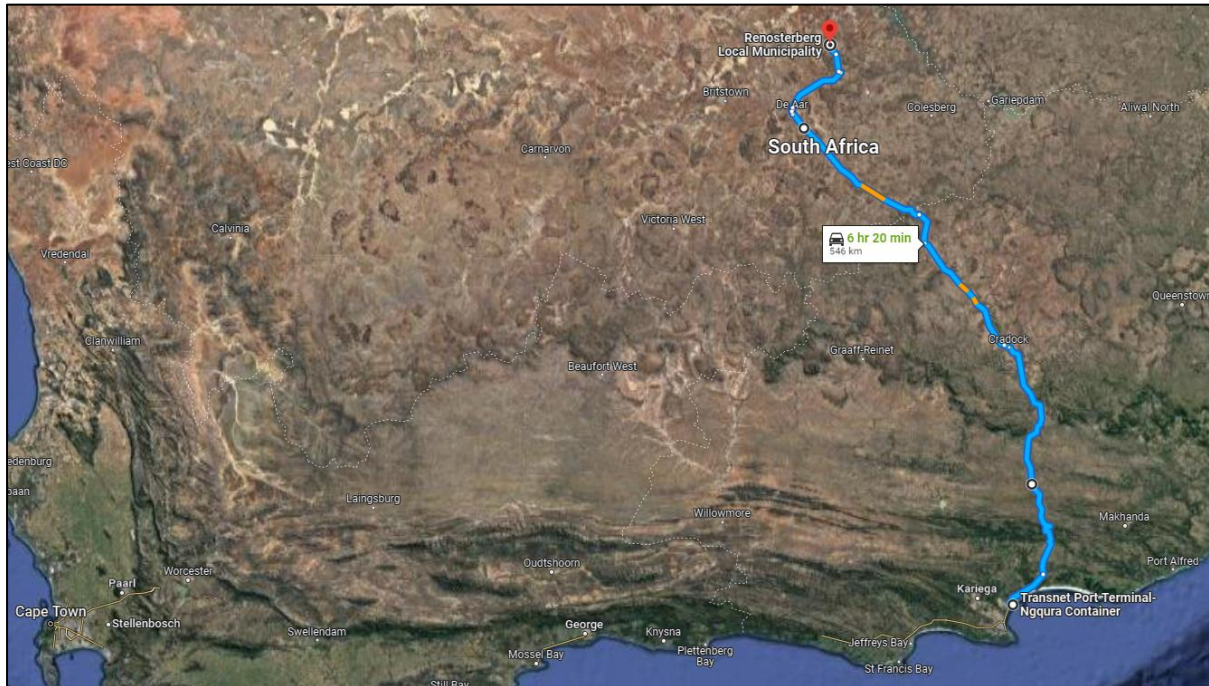

Figure 14-3: Preferred Route

The first alternative option will be the route from the Port of Cape Town as shown in Figure 14-4 by the blue line. This route is approximately 825 km and follows the N1 from the Cape Town Harbour and then turns north at Three Sisters onto the N12 to Britstown and then turns east towards De Aar. From De Aar, the R48 can be taken east up to the access point to the sites.

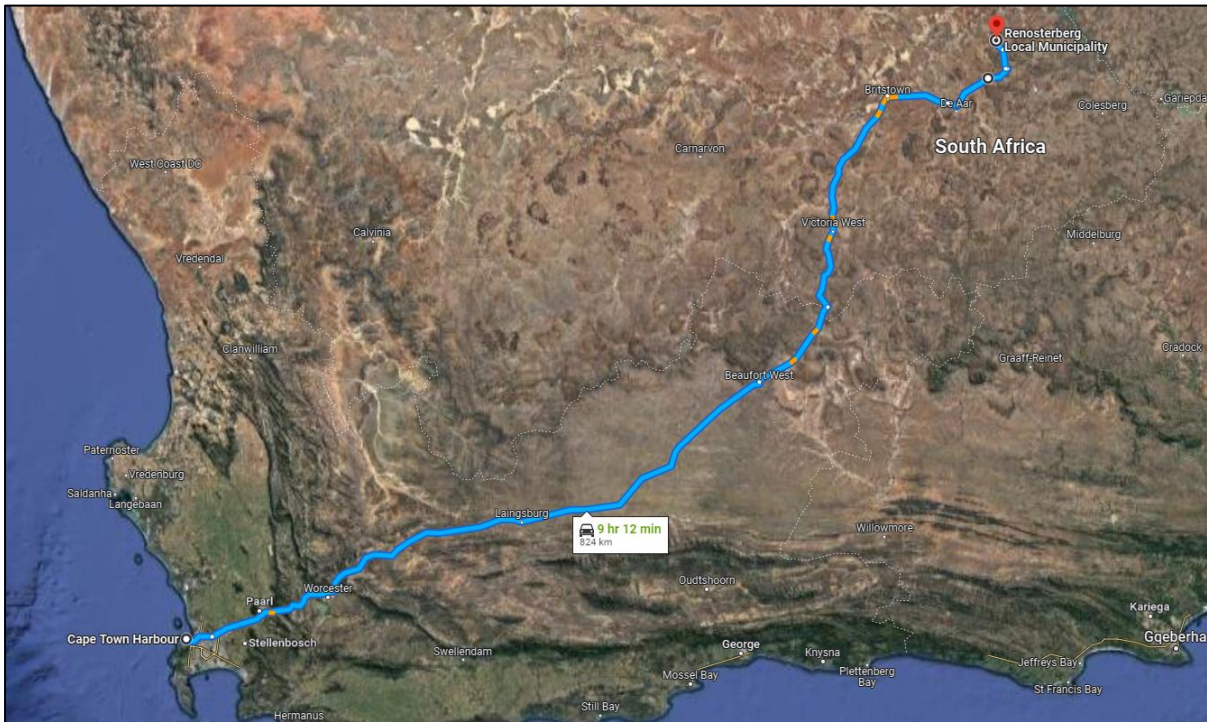

Figure 14-4: Proposed Route: Alternative 1

The second alternative option will be the route from the Port of Saldanha as shown in Figure 14-5 by the blue line. This route is approximately 845 km and follows the N7 from the Port and then turns east past Calvinia and Britstown to De Aar. From De Aar, the R48 can be taken east up to the access point to the sites.

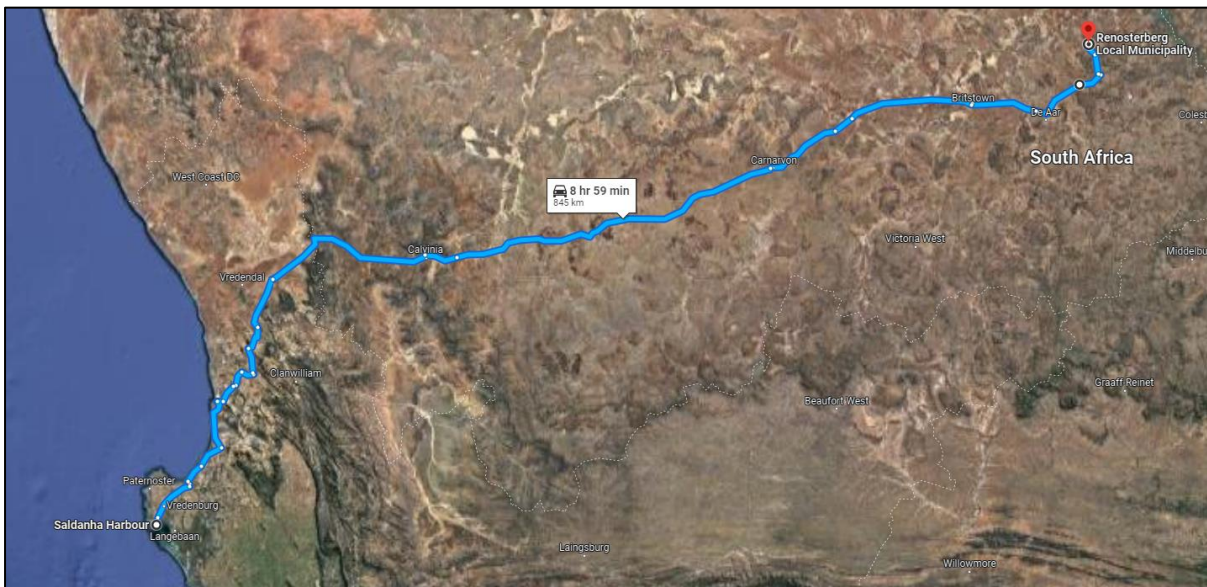

Figure 14-5: Proposed Route: Alternative 2

It should be noted that the above-mentioned route alternatives will all need to navigate through intersections, over and underneath bridges and other road structures, across railway lines and also along mountain passes. It is critical that the abnormal load vehicles can move safely and without obstruction along these routes. It is however anticipated that this is achievable, considering other solar facilities in the vicinity of the proposed site.

14.4.2.2 Main Roads in the Vicinity of the Site

The main roads in the vicinity of the Kudu Solar PV 1 facility is shown in Table 14-1 and Figure 14-6. Table 14-1 also provides details with regards to the controlling and maintaining road authority, width of the road and whether the road is a gravel or surfaced (tarred) road.

Table 14-1: Main Roads in the Vicinity of the Site

Road Name	Road Authority	Road Width	Gravel / Surfaced
Divisional Road 3084 (DR 3084)	Northern Cape Provincial Government	Between $\pm 6.0\text{m}$ and $\pm 7.5\text{m}$	Gravel
Divisional Road 3093 (DR 3093)	Northern Cape Provincial Government	Between $\pm 6.0\text{m}$ and $\pm 8.0\text{m}$	Gravel
Trunk Road 38/1 (TR 38/01) (R48)	Northern Cape Provincial Government	$\pm 6.2\text{m}$ blacktop and $\pm 2.5\text{m}$ gravel shoulders along both sides of the road	Surfaced
Main Road 790 (MR 790) (R388)	Northern Cape Provincial Government	$\pm 8.0\text{m}$	Gravel
Divisional Road 3096 (DR 3096)	Northern Cape Provincial Government	Between $\pm 6.5\text{m}$ and $\pm 8.0\text{m}$	Gravel
Trunk Road 38/02 (TR 38/02) (R48)	Northern Cape Provincial Government	$\pm 6.6\text{m}$ blacktop and $\pm 5\text{m}$ and more gravel shoulders along both sides of the road	Surfaced

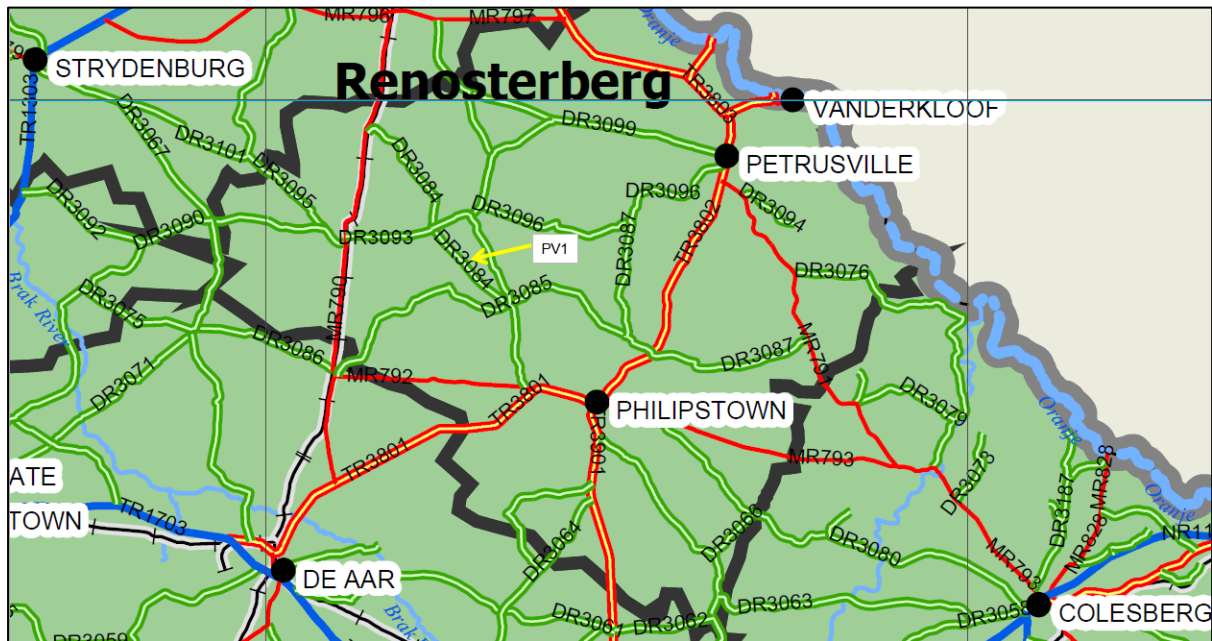

Figure 14-6: Main Roads in the Vicinity of the Site

14.4.2.3 Main Access Considerations

As indicated in the previous paragraph, various existing provincial gravel roads from the R48 (Trunk Road 38/1 and Trunk Road 38/02) can provide access to the site. This can be seen in Figure 14-7 below.



Figure 14-7: Proposed Kudu Solar PV Facility Gravel Roads

The potential main access roads to the proposed facility as shown in Figure 14-7 and Figure 14-8 are:

- Access Route Option 1:
 - Route A: Along TR38/01, DR3093, and DR3096
 - Route B: Along TR38/01, DR3093 and DR3084
- Access Route Option 2:
 - Route A: Along MR790, DR3093 and DR3084
 - Route B: Along MR790 and DR3093
 - Route C: Along MR790, DR3093 and DR3096
- Access Route Option 3:
 - Route A: Along TR38/01, TR38/02, and DR3096
 - Route B: Along TR38/01, TR38/02, DR3096 and DR3093
 - Route C: Along TR38/01, TR38/02, DR3096, DR3093 and DR3084

Please also refer to Table 14-2 for an indication of all potential access roads.

Table 14-2: Potential Access Roads

Access Option	Proposed Access Roads	Main access point from the closest surfaced road	Description of Applicability to the Kudu PV Project	Applicable to Kudu Solar Facility 1?
Access Route Option 1	Route A: Along TR38/01, DR3093, and DR3096	Intersection of the TR38/01 and DR3093	This will provide access to all the proposed Kudu Solar Facilities. Alternatively, once the internal roads are constructed at Kudu Solar Facility 5, it can also be used to access Kudu Solar Facilities 1 to 4. Furthermore, once the internal roads are constructed at Kudu Solar Facility 7, it can also be used to access Kudu Solar Facilities 8 to 12.	Yes
	Route B: Along TR38/01, DR3093 and DR3084	Intersection of the TR38/01 and DR3093	This will provide access to the proposed Kudu Solar Facilities 1 to 5.	Yes
Access Route Option 2	Route A: Along MR790, DR3093 and DR3084	Intersection of the TR38/01 and MR790	This will provide access to the proposed Kudu Solar Facilities 1 to 5.	Yes
	Route B: Along MR790 and DR3093	Intersection of the TR38/01 and MR790	This will provide access to the proposed Kudu Solar Facilities 5, 6 and 7.	No
	Route C: Along MR790, DR3093 and DR3096	Intersection of the TR38/01 and MR790	This will provide access to the proposed Kudu Solar Facilities 8, 9, 10, 11 and 12. Alternatively, once the internal roads are constructed at Kudu Solar Facility 7, it can also be used to access Kudu Solar Facilities 8 to 12.	No
Access Route Option 3	Route A: Along TR38/01, TR38/02, and DR3096	Intersection of the TR38/02 and DR3096	This will provide access to the proposed Kudu Solar Facilities 8, 9, 10, 11 and 12.	No
	Route B: Along TR38/01, TR38/02, DR3096 and DR3093	Intersection of the TR38/02 and DR3096	This will provide access to the proposed Kudu Solar Facilities 5, 6 and 7. Alternatively, once the internal roads are constructed at Kudu Solar Facility 8 to 10, it can also be used to access Kudu Solar Facilities 6 to 7.	No
	Route C: Along TR38/01, TR38/02, DR3096, DR3093 and DR3084	Intersection of the TR38/02 and DR3096	This will provide access to the proposed Kudu Solar Facilities 1 to 5.	Yes



Figure 14-8: Proposed Access Roads

14.4.2.3.1 Access Route Option 1

The main access point for Access Route Option 1, Route A and Route B (refer to Table 14-2), from a surfaced road is from DR3093, located along the R48, approximately 45 km north-east of De Aar. This access will provide the most direct access from a surfaced road. This access road is considered the preferred option. Figure 14-9 indicates the sight distance to the left and right along the R48 and a photo of DR 3093 taken from the R48.

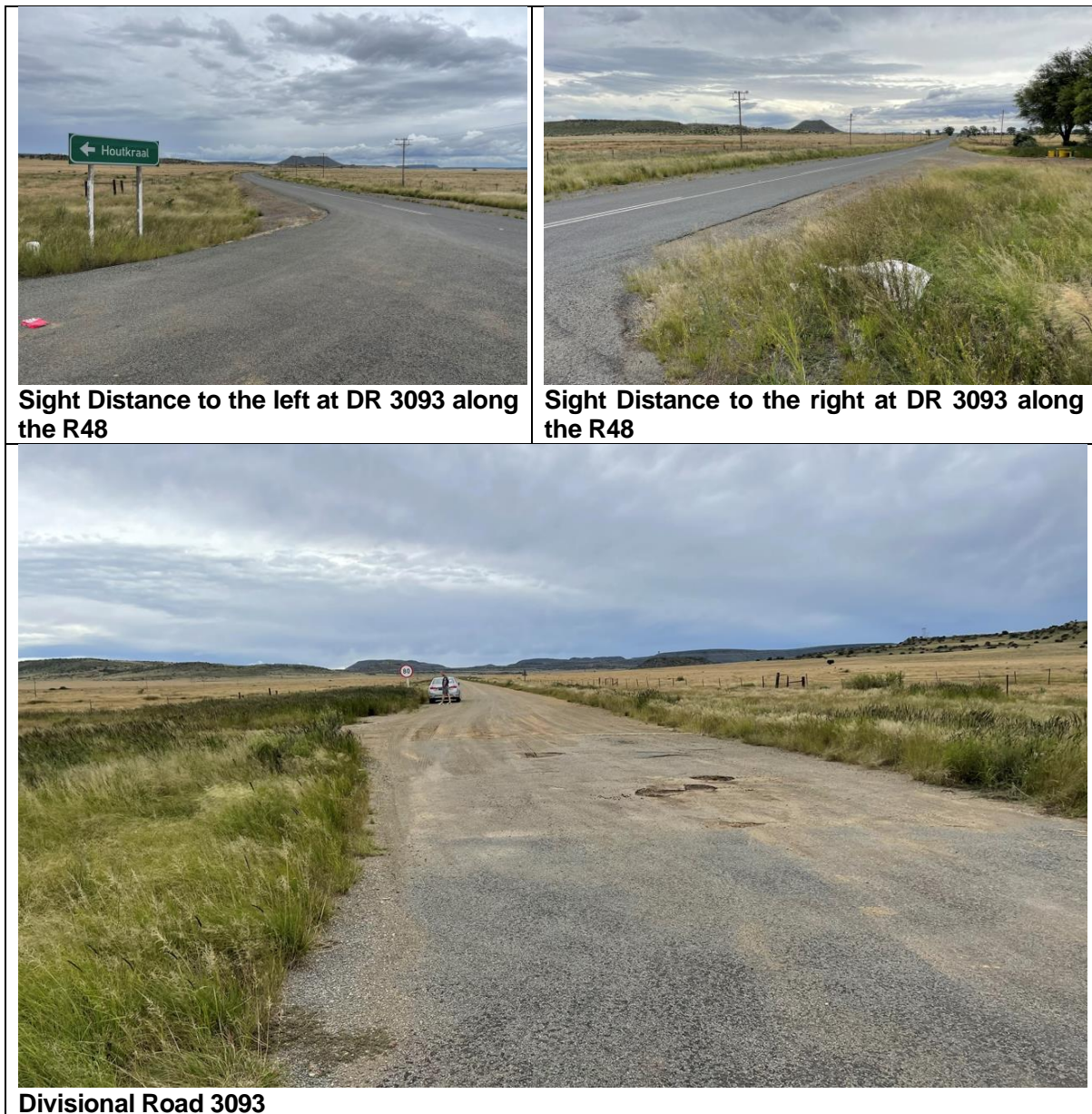

Figure 14-9: Divisional Road 3093

14.4.2.3.2 Access Route Option 2

The main access point for Access Route Option 2, Route A, Route B and Route C (refer to Table 14-2), from a surfaced road is at Main Road 790, located along the R48, approximately 14 km north-east of De Aar. Main Road 790 is a gravel road and crosses a railway line to gain access to DR3093. Figure 14-10 indicates the sight distance to the left and right at MR790 along the R48 and a photo of MR790 taken from the R48.



Figure 14-10: Main Road 790

14.4.2.3.3 Access Route Option 3

The main access point for Access Route Option 3, Route A, Route B and Route C (refer to Table 14-2), from a surfaced road is from DR3096, located along Trunk Road 38/02 (R48), approximately 100 km north-east of De Aar. Site observations concluded that Trunk Road 38/02 is in a very bad condition with potholes present along most part of this portion of road. There will also be a large portion of travel distance on gravel roads along this access. This is the least favourable option. Figure 14-11 indicates the sight distance to the left and right along the R48 and a photo of DR3096 taken from the R48.



Figure 14-11: Divisional Road 3096

All routes to the site should however be further investigated to ensure that the abnormal loads are not obstructed at any point by geometric, height and width limitations along the route. The applicable permits to transport the abnormal loads should also be obtained. It should also be ensured that all the gravel haulage roads should be maintained during the construction phase and reinstated after the construction phase is completed, this is applicable for both provincial roads and also the private internal farm roads to an extent as agreed with the landowners.

14.4.3 Project Specific Description

14.4.3.1 *Kudu Solar Facility 1 and associated infrastructure*

Kudu Solar PV facility (PV1) is shown in Figure 14-12. The preferred access route will be from the R48 (TR38/01), along DR3093 and DR3084 gravel roads. Refer to Table 14-2 for additional information.



Figure 14-12: Kudu Solar Facility 1 (PV1)

Furthermore, direct access to the facility will be taken from DR3084 along an existing farm access as shown in Figure 14-13. The development footprint and detailed layout are acceptable as shown in Figure 14-13. Changes to the detailed layouts are deemed acceptable if the changes remain within the approved buildable areas / development footprints and area assessed during the Scoping and EIA Process with no-go sensitive areas avoided.



Figure 14-13: Kudu Solar Facility 1 (PV1) Access Location

14.4.4 Identification of Environmental Sensitivities

14.4.4.1 Sensitivities identified by the National Web-Based Environmental Screening Tool

Part of the terms of reference was to identify sensitivities by the National Web-Based Environmental Screening Tool (Screening Tool). However, it is important to note that there are no dedicated traffic or transport related themes on the Screening Tool, therefore the environmental sensitivity of the proposed project area as identified by the Screening Tool is not applicable. Therefore, no site sensitivity verification report is required (as indicated in Appendix C). Furthermore, there is no dedicated assessment protocol prescribed for Traffic. Therefore, the specialist assessment has been undertaken in compliance with Appendix 6 of the NEMA EIA Regulations of 2014.

14.4.5 Preliminary Vehicle Tracking Analysis and Road Widening/Lengthening Investigation

According to the NEMA EIA Regulations of 2014, the following relevant listed activities are noted:

Activity 56 of Listing Notice 1: The widening of a road by more than 6 metres, or the lengthening of a road by more than 1 kilometre -

- (i) where the existing reserve is wider than 13,5 meters; or
- (ii) where no reserve exists, where the existing road is wider than 8 metres.

For Activity 56 of Listing Notice 1, *(i) where the existing reserve is wider than 13,5 meters* is relevant.

Activity 18 (g) (ii) (ee) (ii) of Listing Notice 3: The widening of a road by more than four meters, or the lengthening of a road by more than one kilometre in the:

g. Northern Cape

ii. Outside urban areas:

(ee) Critical biodiversity areas as identified in systematic biodiversity plans adopted by the competent authority or in bioregional plans;

(ii) Areas within a watercourse or wetland; or within 100 metres from the edge of a watercourse or wetland.

Existing roads will be used as far as practically achievable. The proposed project study area can be accessed via various existing main roads and unnamed farm gravel roads. The potential access routes are discussed below, as per Section 14.4.2.3:

- Access Route Option 1:
 - Route A: Along TR38/01, DR3093, and DR3096;
 - Route B: Along TR38/01, DR3093 and DR3084;
- Access Route Option 2:
 - Route A: Along MR790, DR3093 and DR3084;
 - Route B: Along MR790 and DR3093;
 - Route C: Along MR790, DR3093 and DR3096;
- Access Route Option 3:
 - Route A: Along TR38/01, TR38/02, and DR3096;
 - Route B: Along TR38/01, TR38/02, DR3096 and DR3093; and
 - Route C: Along TR38/01, TR38/02, DR3096, DR3093 and DR3084.

The existing main roads, divisional roads and unnamed farm gravel roads may need to be upgraded for the proposed Kudu Solar cluster.

To accommodate the turning movements of abnormal vehicles, preliminary vehicle tracking was undertaken along the Access Route Options to determine areas where the existing road will need to be widened / lengthened. The following design vehicle was used (refer to Figure 14-14). The design vehicle will need to be confirmed during the geometric design process, however, the vehicle used is based on similar projects.

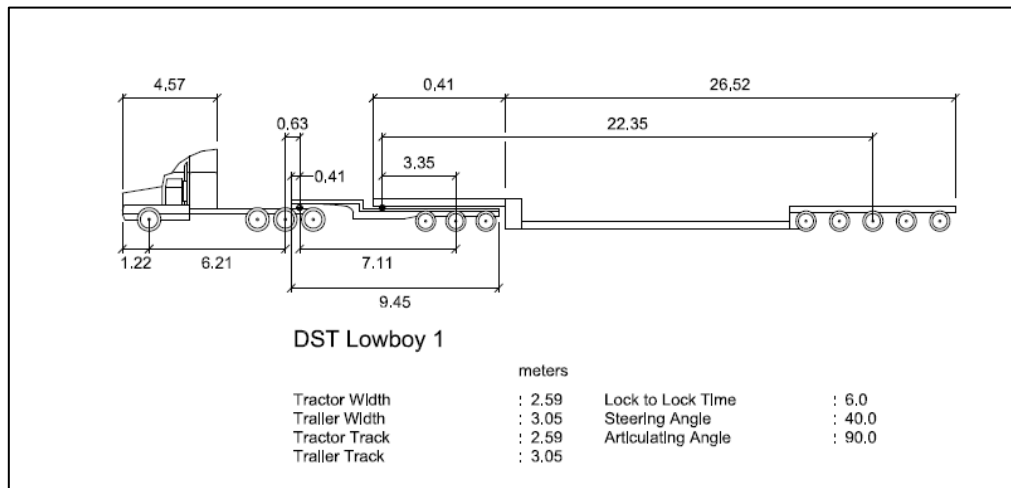

Figure 14-14: Abnormal Design Vehicle

Furthermore, based on similar studies, to accommodate the delivery of materials to site, the following intersection design at the main access point from the R48 is proposed as shown in Figure 14-15.

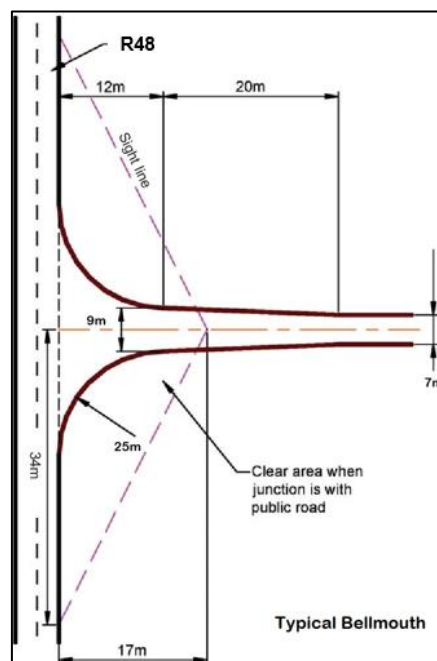

Figure 14-15: Intersection Design

The findings of the vehicle tracking based on the abnormal design vehicle for each access route option is discussed below.

14.4.5.1.1 Access Route Option 1

For this option, it is not anticipated that any widening of the intersection at TR38/01 and DR3093 will be required, however, the existing island will need to be removed (approximately 60 m²) to accommodate the turning movements as shown in Figure 14-16 and in accordance with Figure 14-15.



Figure 14-16: DR3093 and TR38/01 Intersection

No other widening or lengthening of roads will be required along this route.

14.4.5.1.2 Access Route Option 2

For this option, widening of the intersection at TR38/01 and MR790 will be required (approximately 95m²) to accommodate the turning movements as shown in Figure 14-17 and in accordance with Figure 14-15.



Figure 14-17: MR790 and TR38/01 Intersection

Furthermore, widening of the MR790/DR3093 intersection by approximately 60m² and widening of the DR3093/DR3084 intersection by 170m² will also be required as shown in Figure 14-18.



Figure 14-18: Access Route Option 2 Road Widening Requirements

No other widening or lengthening of roads will be required along this route.

14.4.5.1.3 Access Route Option 3

For this option, widening of the intersection at TR38/02 and DR3096 will be required (approximately 150m² in total) to accommodate the turning movements as shown in Figure 14-19 and in accordance with Figure 14-15.



Figure 14-19: Access Route Option 3 Road Widening Requirements

Furthermore, localised widening will be required along DR3096 at two locations (approximately 56m² heading north and 50m² heading west) and at the DR3093/DR3084 intersection (approximately 79m²) as shown in Figure 14-20.



Figure 14-20: Access Route Option 3 Road Widening Requirements

No other widening or lengthening of roads will be required along this route.

14.4.5.2 Conclusion Statement

Based on the wheel tracking analysis of the abnormal load vehicles that are discussed in Section 14.4.5, it can be concluded that no road will need to be lengthened by more than 1 kilometre for Access Route Option 1, Access Route Option 2 and Access Route Option 3. However, road widening exceeding 6m will be required for Access Route Option 2 only at the TR38/01 and MR790 intersection

(approximately 12m at the widest point) and at the DR3093 and DR3084 intersection (approximately 6.6m at the widest point). This is shown in Figure 14-21.



Figure 14-21: Road Widening Width at TR38/01 and MR790 and DR3093 and DR3084 intersections

Road widening exceeding 4m will be required for Access Route Option 3 at the TR38/02 and DR3096 intersection (approximately 4.4m at the widest point). This is shown in Figure 14-22.

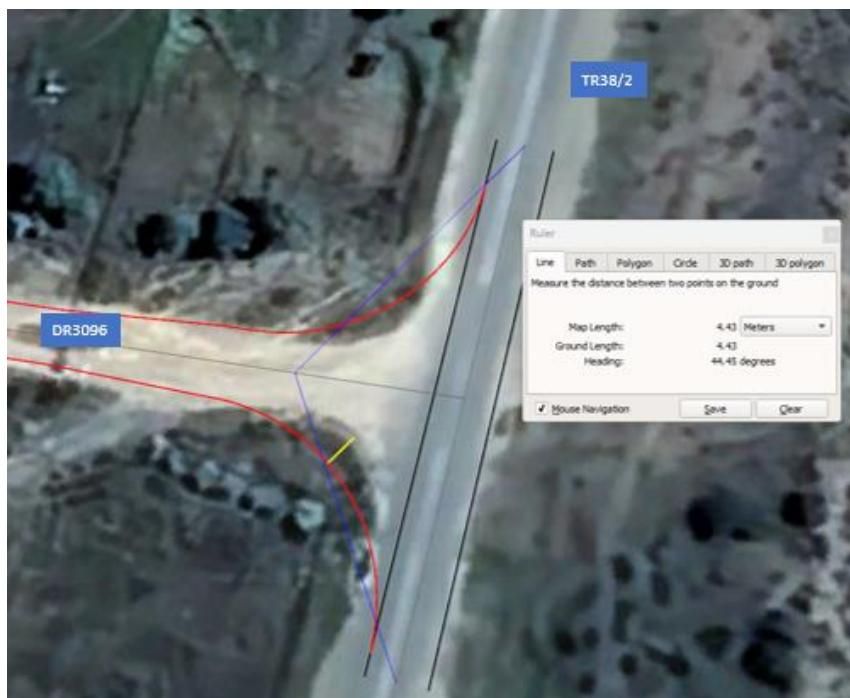

Figure 14-22: Road Widening Width at TR38/02 and DR3096 intersection

Road widening exceeding 4m and 6m will not be required for Access Route Option 1.

14.5 Existing Traffic Conditions

Temporary counting stations were commissioned by SANRAL in 2011 along the DR3093 and DR3084. The locations of the counting stations are indicated in Figure 14-23 below. The results of these counts indicated an Average Daily Traffic (ADT) of approximately 62 vehicles (two-way) along DR3093 and approximately 8 vehicles (two-way) along DR3084 per day. These numbers indicate that there are extremely low volumes of traffic along these roads in the vicinity of the study area. If an annual growth rate factor of 2% growth rate per annum is applied to these volumes, the ADT would increase to 79 vehicles (two-way) along DR3093 and 10 vehicles (two-way) along DR3084 per day, which is still extremely low traffic volumes. This growth rate relates to traffic growth experienced in low growth rate areas and is deemed appropriate for this area and could account for development that has taken place since 2011.



Figure 14-23: Location of Temporary Count Stations

SANRAL has two permanent counting stations, Station 13730 and Station 13731, in the vicinity of the site. Station 13730 is located along the R389 approximately 64 km northeast of De Aar and Station 13731 is located along the R48 approximately 102 km northeast of De Aar. The location of the counting stations is indicated in Figure 14-24 below.



Figure 14-24: Location of Permanent Count Stations

A summary of the ADT recorded at Station 13730 and Station 13731 is shown in Table 14-3 and Figure 14-25 below.

Table 14-3: Station 13730 and Station 13731 Count Data

Year	Average Traffic (ADT) (two-way)	
	Station 13730	Station 13731
2018	412	748
2019	454	648
2020	610	839
2021	626	866

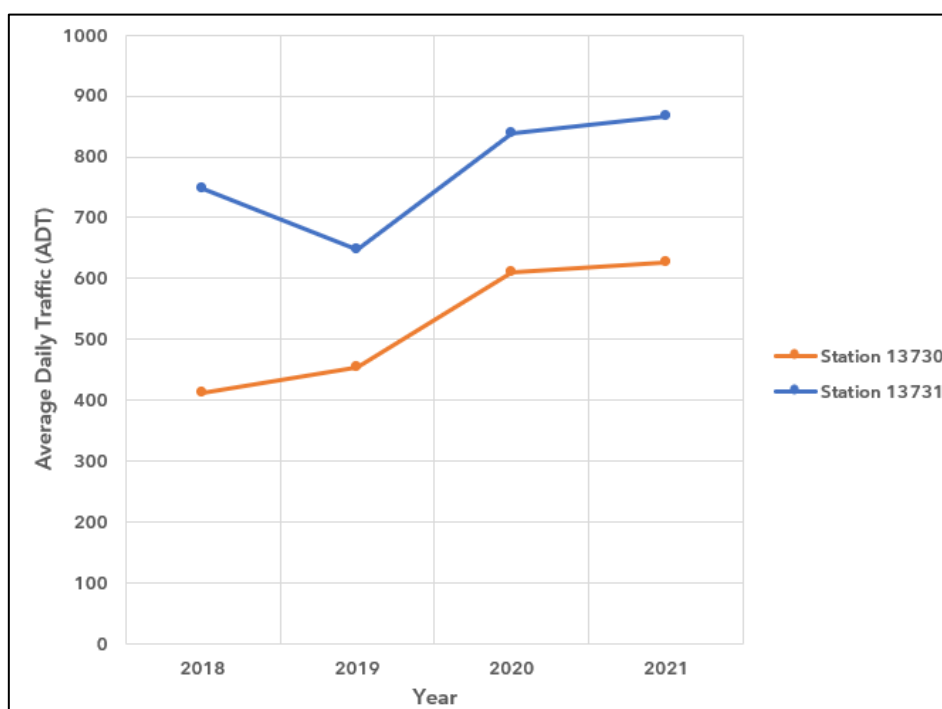

Figure 14-25: SANRAL Station 13730 and Station 13731 Historic Count Information

From the above information, it can be concluded that the growth rate from the recorded 2018 to 2021 ADT values is approximately 14% per annum along the R389 and approximately 5% per annum along the R48. Furthermore, the percentage of heavy vehicles recorded on the R389 was 78% during 2021 and 56% along the R48 during 2021. An increase in ADT is evident from 2020 onwards. This can possibly be attributed to increased mining activities and renewable energy projects. It should however be noted that the capacity of a Class 1 road with two lanes is in the order of 2000 vehicles per hour and therefore the traffic volumes recorded on this road is still significantly less than the capacity of the roads.

14.6 Trip Generation Rates

The trip generation rates discussed below are based on similar studies that have been undertaken for Solar Energy Facilities and associated electrical infrastructure (e.g. collector substation and transmission line). The trip generation rates discussed below relates to the anticipated trip generation rates associated with the 50MW Solar PV Facility.

14.6.1 Construction Phase

It is expected that the Construction Phase of the proposed Kudu Solar PV facility will be 12 to 18 months.

From experience with similar projects, it was assumed that for projects up to 150MW, the following number of truck trips (one-way) are expected:

- Panels = 273 truck trips
- Mounting Structure = 300 truck trips
- Inverters = 13 truck trips
- Field Transformers = 12 truck trips
- Cable and Battery Operating System (BOS) = 120 truck trips

It is assumed that each project will be constructed over a 12 to 18 month period. Therefore, based on an 18-month construction period and a 6 day work week ($78 \times 6 = 468$ work days), this could result in approximately **2 daily truck trips (one-way)**.

It is also expected that approximately 3 single unit trucks carrying construction materials will visit the site on a daily basis, resulting in **3 daily single unit truck trips (one-way)**.

Furthermore, it is expected that approximately 150 workers will be transported to the site daily. It was assumed that 50% the workers will be transported to/from the site by 15-seater minibus taxis and 50% of the workers will be transported to/from the site by 80-seater buses from the surrounding areas resulting in approximately **5 daily staff minibus taxi trips (one-way)** and **1 daily bus trip (one-way)**. Experience has shown that during the construction period, approximately **2 daily private vehicle trips** are expected to come to/from the site from supervisors or senior personnel. Therefore, a total of **8 daily staff trips (one-way)** are expected.

Water will also be required during the construction phase for human consumption and construction activities, such as the installation of the solar panels, dust control along the gravel roads and potable water. As noted in Chapter 2 of this EIA Report, water may be sourced from the following sources, in order of priority: local municipality, third-party water supplier, existing boreholes or new drilled boreholes on site. For purposes of this TIA, the maximum development scenario in terms of water supply is used i.e. trucking in water from the local municipality. The water will be delivered to the site from a municipal water supply by 12 kilolitre water trucks on a daily basis. Based on similar projects, water demand will be in the order of approximately 9 000 m³ per year for the construction phase for construction purposes and potable water. This equates to 750 000 litres per month. This relates to an additional ~ **2 daily water truck trips (one-way)** to the site.

Based on the above, a total of **15 one-way trips per day**, i.e. **30 trips in total per day (two-way)** are expected during the 18 month period construction phase.

14.6.2 Operational Phase

It is expected that the Operational Phase will take place during the life span of the project (approximately 20 years). During this time, it is anticipated that 1 - 2 light load trucks will visit the site on a weekly basis. This will conservatively equate to **1 daily light load truck trip (one-way)**.

It is expected that a workforce of 8 members, made up of staff, supervisors or senior personnel will commute to the site by private vehicles daily. It is assumed that 3 workers will share a private vehicle, resulting in a total of **3 daily staff trips (one-way)**.

Water will be required for cleaning the solar panels, which must be done 4 times per year. It is also anticipated that the gravel district road be watered daily to suppress dust during operation depending

on traffic volumes. Based on similar projects, water demand will be in the order of approximately 1 000 m³ per year during the operational phase. This equates to 83 333 litres per month. The water will be delivered to the site from a municipal water supply by 12 kilolitre water trucks on a daily basis, resulting in **1 daily water truck trip (one-way)**.

Based on the above, a total of **5 one-way trips per day**, i.e. **10 trips in total per day (two-way)** are expected during the operational phase.

14.6.3 Decommissioning Phase

The Decommissioning Phase will generate similar trips as the Construction Phase over a similar time period of 18 months. This includes **2 daily truck trips (one-way)** trips for the transportation of the solar panels, **3 daily single unit truck trips (one-way)**, for the transportation of construction materials, **8 daily staff trips (one-way)** and **2 daily water truck trips (one-way)**.

Based on the above, a total of **15 one-way trips per day**, i.e. **30 trips in total per day (two-way)** are expected during the 18 month period decommissioning phase.

14.7 Trip Generation Summary

From the trip generation information gathered the following traffic impacts should be considered:

- Potential congestion and delays on the surrounding road network;
- Potential impact on traffic safety and increase in accidents with other vehicles or animals;
- Potential change in the quality of the surface condition of the roads; and
- Potential noise and dust pollution.

The number of additional daily trips per solar PV plant and associated electrical grid infrastructure are summarised below. These trips can be expected for the duration of the construction period and decommissioning phase (18 months) and for the operational phase of the project (20 years).

Construction Phase – 30 Daily Trips (two-way)

- 4 daily truck trips
- 6 daily light load trips
- 16 daily staff transport trips
- 4 daily water truck trips

Operational Phase – 10 Daily Trips (two-way)

- 2 daily light load truck trips
- 6 daily staff transport trips
- 2 daily water truck trips

Decommissioning Phase – 30 Daily Trips (two-way)

- 4 daily truck trips
- 6 daily light load trips
- 16 daily staff transport trips
- 4 daily water truck trips

It is anticipated that the PV facility will have an 18-month construction period. From historic traffic information in the vicinity of the site, traffic is evenly spread daily and the AM and PM peak hour trips each constitute approximately 7% of the daily traffic. This relates to approximately an additional 2 trips on the road network during the peak hours for the construction and decommissioning phase and approximately an additional 1 trip on the road network during the peak hours for the operational phase. **The additional peak hour trips during the construction, operational and decommissioning phases will have an insignificant traffic impact on the surrounding road network.**

However, possible mitigation measures to address the daily traffic impact are discussed in the following section.

14.8 Issues, Risks and Impacts

14.8.1 Identification of Potential Impacts/Risks

The potential transport and traffic related impacts identified are described below.

14.8.1.1 Construction Phase

The potential transport and traffic related impacts during the construction phase are listed below:

- Potential congestion and delays on the surrounding road network.
- Potential impact on traffic safety and increase in accidents with other vehicles or animals.
- Potential change in the quality of the surface condition of the roads.
- Potential noise and dust pollution.

14.8.1.2 Operational Phase

The traffic generated during the operational phase are mainly related to the staff that will be transported to and from the sites and are not anticipated to have a significant traffic impact on the surrounding road network.

14.8.1.3 Decommissioning Phase

The potential transport related impacts during the decommissioning phase are similar to the potential transport related impacts during the construction phase and are listed below:

- Potential congestion and delays on the surrounding road network.
- Potential impact on traffic safety and increase in accidents with other vehicles or animals.
- Potential change in the quality of the surface condition of the roads.
- Potential noise and dust pollution.

14.8.1.4 Cumulative Impacts

The cumulative transport impacts related to the proposed facility are listed below and apply to the construction and decommissioning phases:

- Congestion and delays on the surrounding road network.
- Impact on traffic safety and increase in accidents with other vehicles or animals.
- Change in the quality of the surface condition of the roads.
- Noise and dust pollution.

14.8.2 Summary of Issues identified during the Public Consultation Phase

During the 30-day review of the Draft Scoping Report, various comments were raised by stakeholders and Interested and Affected Parties (I&APs). The comments raised that relate to traffic related impacts are noted and summarised below, with responses provided by the specialist team:

NAME OF ORGANISATION/ I&AP	KEY ISSUE	RESPONSE
Adjacent Landowners	Queries on the maintenance of infrastructure (such as roads and water courses) and the management of dust pollution caused by the increased traffic.	<p>Maintenance of existing infrastructure that is impacted by the proposed project during the construction and operational phase will be undertaken by the Project Developer. The requirements for maintenance are discussed in the Environmental Management Programme (EMPr). Similarly, mitigation measures to control and manage dust pollution that occurs as a result of the proposed project are included in the EMPr. The Applicant will place a significant emphasis on ensuring compliance with the management measures included.</p> <p>Dust pollution has been identified as a potential impact in this Traffic Impact Assessment, as well as the Visual Impact Assessment. Refer to Section 14.9 of this report for feedback on the potential dust pollution impact and mitigation measures, such as ensuring that speed control is implemented by means of a stop and go system and speed limit road signage within the construction site. Further management actions are also included in the EMPr.</p>
Adjacent Landowner	A concern was raised regarding the dust pollution generated by the roads and the removal of vegetation.	The concerns regarding dust pollution are noted. Note that during the construction phase, vegetation is planned to be trimmed within the PV array area (and not removed completely). Therefore, even though it appears that a large area will be covered by the Solar PV array, not all the vegetation will be removed completely. This is also expected to reduce some of the dust generation. Nevertheless, dust management actions are included in the EMPr.

14.9 Impact Assessment

14.9.1 Potential Impacts during the Construction Phase

The impacts associated with the traffic generation of the proposed Kudu PV Facility 1 during the construction phase are summarised in Table 14-4 below, and discussed in detail below:

14.9.1.1 Impact 1: Potential congestion and delays on the surrounding road network.

Congestion and delays on the surrounding road network are identified as a potential impact as a result of increased traffic volumes relating to the trip generation of the construction activities during the peak hour periods. This impact is rated as neutral, with a local spatial extent and a medium-term duration. The impact is rated with a high reversibility (meaning that the potential impact is highly reversible at end of the project life); and is rated as replaceable (meaning the resources i.e. road network are replaceable). The potential impact is allocated a slight consequence and likely probability, which will render the impact significance as very low, without the implementation of mitigation measures. With the implementation of mitigation measures, the significance of the impact is also rated as very low. The recommended mitigation measures are detailed in Table 14-4 below.

14.9.1.2 Impact 2: Potential impact on traffic safety and increase in accidents with other vehicles or animals.

Traffic safety and an increase in accidents with other vehicles and animals is identified as a potential impact as a result of more vehicles travelling on the road to and from the construction site, increasing the likelihood of incidents. This impact is rated as negative, with a local spatial extent and a medium-term duration. The impact is rated with a low reversibility and high irreplaceability if the incident results in a fatality. The potential impact is allocated a substantial consequence and likely probability, which will render the impact significance as moderate, without the implementation of mitigation measures. With the implementation of mitigation measures, the significance of the impact is rated as low. The recommended mitigation measures are detailed in Table 14-4 below.

14.9.1.3 Impact 3: Potential change in the quality of the surface condition of the roads.

The potential change in the quality of the surface condition of the roads is identified as a potential impact as a result of the increase in especially heavy vehicle traffic on the roads. This impact is rated as neutral, with a local spatial extent and a medium-term duration. The impact is rated with a high reversibility (meaning that the potential impact is highly reversible at end of the project life); and is rated as replaceable (meaning the resources i.e. road network are replaceable). The potential impact is allocated a slight consequence and likely probability, which will render the impact significance as very low, without the implementation of mitigation measures. With the implementation of mitigation measures, the significance of the impact is also rated as very low. The recommended mitigation measures are detailed in Table 14-4 below.

14.9.1.4 Impact 4: Potential noise pollution.

The potential of noise pollution is identified as a potential impact as a result of increased traffic volumes during the construction phase of the project. This impact is rated as neutral, with a local spatial extent and a medium-term duration. The impact is rated with a high reversibility (meaning that the potential impact is highly reversible at end of the project life); and is rated as replaceable (meaning the resources i.e. road network are replaceable). The potential impact is allocated a moderate consequence and likely probability, which will render the impact significance as low, without the implementation of mitigation measures. With the implementation of mitigation measures, the significance of the impact is also rated as low. The recommended mitigation measures are detailed in Table 14-4 below.

14.9.1.5 Impact 5: Potential dust pollution.

The potential of dust pollution is identified as a potential impact as a result of the increased number of vehicles using the gravel roads to access the proposed construction site. This impact is rated as neutral, with a local spatial extent and a medium-term duration. The impact is rated with a high reversibility (meaning that the potential impact is highly reversible at end of the project life); and is rated as replaceable (meaning the resources i.e. road network are replaceable). The potential impact is allocated a moderate consequence and likely probability, which will render the impact significance as low, without the implementation of mitigation measures. With the implementation of mitigation measures, the significance of the impact is also rated as low. The recommended mitigation measures are detailed in Table 14-4 below.

14.9.1.6 Impact Summary Tables: Construction Phase

Table 14-4: Rating of Traffic Related Impacts During the Construction Phase

Impact	Impact Criteria		Significance and Ranking (Pre-Mitigation)	Potential mitigation measures	Significance and Ranking (Post-Mitigation)	Confidence Level
CONSTRUCTION PHASE						
Congestion and delays on road network	Status	Neutral	Very Low (5)	Stagger delivery trips and schedule trips, including staff trips outside of peak hours where possible.	Very Low (5)	High
	Spatial Extent	Local				
	Duration	Medium Term				
	Consequence	Slight				
	Probability	Likely				
	Reversibility	High				
Potential impact on traffic safety and increase in accidents with other vehicles and animals	Status	Negative	Moderate (3)	Implement speed control by means of a stop and go system and speed limit road signage within the construction site. Ensure all vehicles are roadworthy, visible, adequately marked, and operated by an appropriately licenced operator.	Low (4)	High
	Spatial Extent	Local				
	Duration	Medium Term				
	Consequence	Substantial				
	Probability	Likely				
	Reversibility	Low				
Condition of road surface	Status	Neutral	Very Low (5)	Regular maintenance of internal farm access roads by the contractor. Ensure private access roads that are impacted on by the proposed development are restored to original pre-construction road condition.	Very Low (5)	High
	Spatial Extent	Local				
	Duration	Medium Term				
	Consequence	Slight				
	Probability	Likely				
	Reversibility	High				
Dust Pollution	Status	Neutral	Low (4)	Implement dust control on gravel roads within the construction site. Implement speed control by means of a stop and go system and speed limit road signage within the construction site.	Low (4)	High
	Spatial Extent	Local				
	Duration	Medium Term				
	Consequence	Moderate				
	Probability	Likely				
	Reversibility	High				
Noise Pollution	Status	Neutral	Low (4)	Stagger delivery trips.	Low (4)	High
	Spatial Extent	Local				
	Duration	Medium Term				
	Consequence	Moderate				

Impact	Impact Criteria		Significance and Ranking (Pre-Mitigation)	Potential mitigation measures	Significance and Ranking (Post-Mitigation)	Confidence Level
	Probability	Likely				
	Reversibility	High				
	Irreplaceability	Replaceable				

14.9.2 Potential Impacts during the Operational Phase

The traffic generated during the operational phase will not have a significant impact on the surrounding road network.

14.9.3 Potential Impacts during the Decommissioning Phase

The impacts associated with the traffic generation of the proposed Kudu PV Facility during the decommissioning phase are summarised in Table 14-5 below:

14.9.3.1 Impact 1: Potential congestion and delays on the surrounding road network.

Congestion and delays on the surrounding road network are identified as a potential impact as a result of increased traffic volumes relating to the trip generation of the facility for decommissioning activities during the peak hour periods. This impact is rated as neutral, with a local spatial extent and a medium-term duration. The impact is rated with a high reversibility (meaning that the potential impact is highly reversible at end of the project life); and is rated as replaceable (meaning the resources i.e. road network are replaceable). The potential impact is allocated a slight consequence and likely probability, which will render the impact significance as very low, without the implementation of mitigation measures. With the implementation of mitigation measures, the significance of the impact is also rated as very low. The recommended mitigation measures are detailed in Table 14-5 below.

14.9.3.2 Impact 2: Potential impact on traffic safety and increase in accidents with other vehicles or animals.

Traffic safety and increase in accidents with other vehicles and animals is identified as a potential impact as a result of more vehicles travelling on the road to and from the facility for decommissioning activities, increasing the likelihood of incidents. This impact is rated as negative, with a local spatial extent and a medium-term duration. The impact is rated with a low reversibility and high irreplaceability if the incident results in a fatality. The potential impact is allocated a substantial consequence and likely probability, which will render the impact significance as moderate, without the implementation of mitigation measures. With the implementation of mitigation measures, the significance of the impact is rated as low. The recommended mitigation measures are detailed in Table 14-5 below.

14.9.3.3 Impact 3: Potential change in the quality of the surface condition of the roads.

The potential change in the quality of the surface condition of the roads is identified as a potential impact as a result of the increase in especially heavy vehicle traffic on the roads due to decommissioning activities. This impact is rated as neutral, with a local spatial extent and a medium-term duration. The impact is rated with a high reversibility (meaning that the potential impact is highly reversible at end of the project life); and is rated as replaceable (meaning the resources i.e. road network are replaceable). The potential impact is allocated a slight consequence and likely probability, which will render the impact significance as very low, without the implementation of mitigation measures. With the implementation of mitigation measures, the significance of the impact is also rated as very low. The recommended mitigation measures are detailed in Table 14-5 below.

14.9.3.4 Impact 4: Potential noise pollution.

The potential of noise pollution is identified as a potential impact as a result of increased traffic volumes during the decommissioning phase of the project. This impact is rated as neutral, with a local spatial extent and a medium-term duration. The impact is rated with a high reversibility (meaning that the potential impact is highly reversible at end of the project life); and is rated as replaceable (meaning the resources i.e. road network are replaceable). The potential impact is allocated a moderate consequence and likely probability, which will render the impact significance as low, without the implementation of mitigation measures. With the implementation of mitigation measures, the significance of the impact is also rated as low. The recommended mitigation measures are detailed in Table 14-5 below.

14.9.3.5 Impact 5: Potential dust pollution.

The potential of dust pollution is identified as a potential impact as a result of increased number of vehicles using the gravel roads to access the proposed facility for decommissioning activities. This impact is rated as neutral, with a local spatial extent and a medium-term duration. The impact is rated with a high reversibility (meaning that the potential impact is highly reversible at end of the project life); and is rated as replaceable (meaning the resources i.e. road network are replaceable). The potential impact is allocated a moderate consequence and likely probability, which will render the impact significance as low, without the implementation of mitigation measures. With the implementation of mitigation measures, the significance of the impact is also rated as low. The recommended mitigation measures are detailed in Table 14-5 below.

14.9.3.6 Impact Summary Tables: Decommissioning Phase

Table 14-5: Rating of Traffic Related Impacts During the Decommissioning Phase

Impact	Impact Criteria		Significance and Ranking (Pre-Mitigation)	Potential mitigation measures	Significance and Ranking (Post-Mitigation)	Confidence Level
DECOMMISSIONING PHASE						
Congestion and delays on road network	Status	Neutral	Very Low (5)	<ul style="list-style-type: none"> Stagger delivery trips and schedule trips, including staff trips outside of peak hours where possible. 	Very Low (5)	High
	Spatial Extent	Local				
	Duration	Medium Term				
	Consequence	Slight				
	Probability	Likely				
	Irreplaceability	Replaceable				
Potential impact on traffic safety and increase in accidents with other vehicles and animals	Status	Negative	Moderate (3)	<ul style="list-style-type: none"> Implement speed control by means of a stop and go system and speed limit road signage within the decommissioning site. Ensure all vehicles are roadworthy, visible, adequately marked, and operated by an appropriately licenced operator. 	Low (4)	High
	Spatial Extent	Local				
	Duration	Medium Term				
	Consequence	Substantial				
	Probability	Likely				
	Irreplaceability	High				
Condition of road surface	Status	Neutral	Very Low (5)	<ul style="list-style-type: none"> Regular maintenance of internal farm access roads by the contractor. Ensure private access roads that are impacted on by the proposed development are restored to original pre-construction road condition. 	Very Low (5)	High
	Spatial Extent	Local				
	Duration	Medium Term				
	Consequence	Slight				
	Probability	Likely				
	Irreplaceability	Replaceable				
Dust Pollution	Status	Neutral	Low (4)	<ul style="list-style-type: none"> Implement dust control on gravel roads within the decommissioning site. Implement speed control by means of a stop and go system and speed limit road signage within the decommissioning site. 	Low (4)	High
	Spatial Extent	Local				
	Duration	Medium Term				
	Consequence	Moderate				
	Probability	Likely				
	Irreplaceability	Replaceable				
Noise Pollution	Status	Neutral	Low (4)	<ul style="list-style-type: none"> Stagger delivery trips. 	Low (4)	High
	Spatial Extent	Local				
	Duration	Medium Term				
	Consequence	Moderate				

Impact	Impact Criteria		Significance and Ranking (Pre-Mitigation)	Potential mitigation measures	Significance and Ranking (Post-Mitigation)	Confidence Level
	Probability	Likely				
	Reversibility	High				
	Irreplaceability	Replaceable				

14.9.4 Cumulative Impacts

It is very unlikely that all 12 Kudu PV projects will occur at the same time and construction will most likely be staggered based on project and site-specific aspects. However, the potential cumulative traffic impact related to the construction and decommissioning phases are shown in the table below based on the assumption of all 12 PV projects being constructed at the same time. The cumulative traffic impact related to the operational phase can still be regarded as insignificant.

The biggest traffic impact associated with renewable energy facilities is during the construction phase (and similarly during the decommissioning phase). During the operational phase, the trips added to the road network is expected to be insignificant. It should be noted that all the applications for abnormal load transport are considered by the applicable authorities, and they will ensure that the trips are staggered on the road network to limit possible delays.

Other renewable energy and EGI developments within a 30 km radius are also considered in this cumulative impact assessment as part of the EIA Phase. Refer to Figure 14-26 below for a map of the other renewable energy developments and EGI considered, as well as a corresponding list of projects in Table 14-6. Some of these projects are already constructed and operational (selected preferred bidders or existing power lines), currently in the Environmental Assessment phase, or have received Environmental Authorisation, or are planned. In reality it is however very unlikely that all the proposed projects will occur at the same time, as all these projects will be subject to a highly competitive bidding process and only a few projects would be allowed to enter into a power purchase agreement at a time. Construction will most likely be staggered based on project and site-specific issues. In addition, as noted above, the applicable authorities will consider abnormal load applications and work with the applicants to ensure that staggering and phasing of loads on public roads is achieved to minimise impacts.

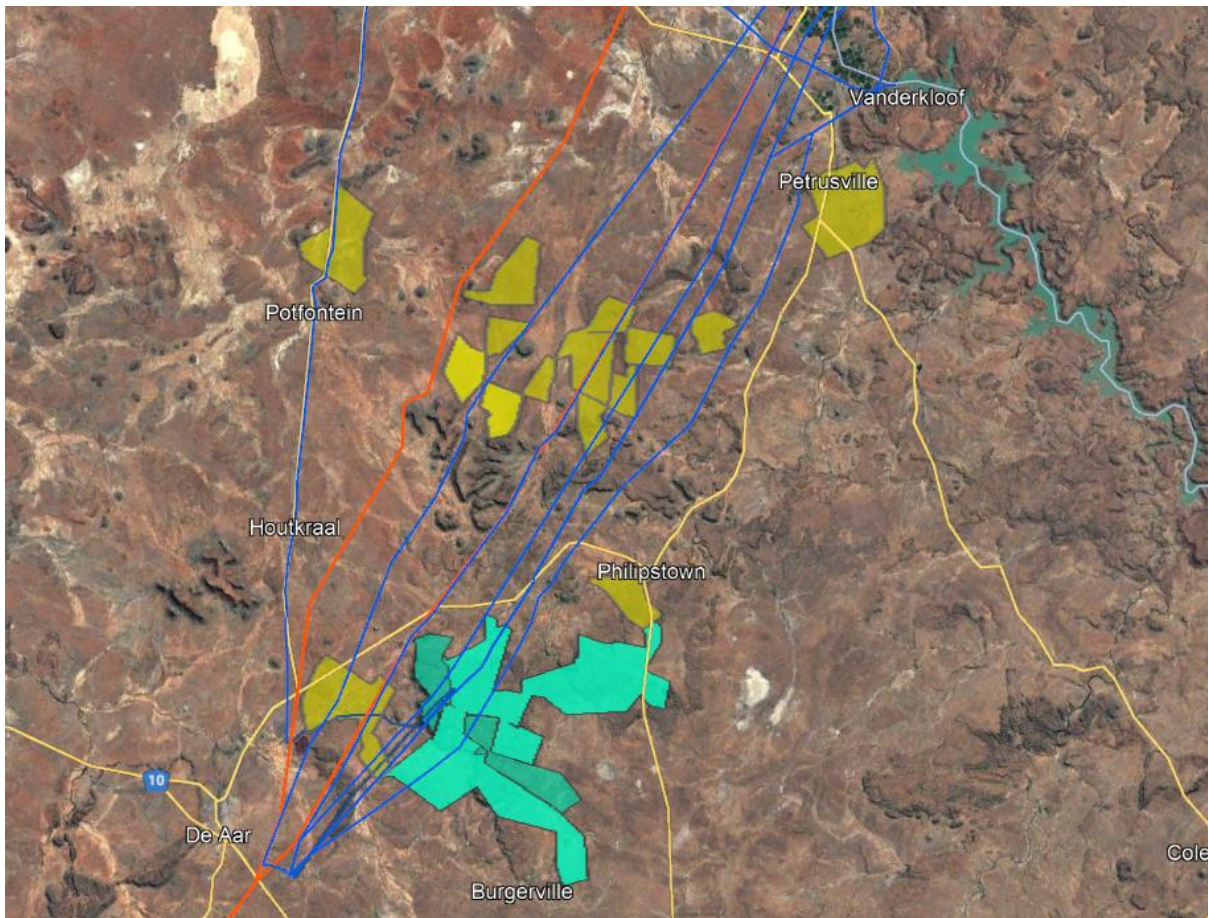

Figure 14-26: Renewable Energy Developments and EGI within 30km Radius

Table 14-6: Proposed renewable energy and EGI projects, located within 30 km of the proposed Kudu Solar Facilities, that are considered in the Cumulative Impact Assessment (Source: DFFE REEA, Quarter 4, 2022; and SAHRIS)

CSIR NUMBER	DFFE REFERENCE	TECHNOLOGY	MW/KV	STATUS	PROJECT TITLE	EIA REGULATIONS	ASSESSMENT PROCESS	APPLICANT	EAP
1	<ul style="list-style-type: none"> 12/12/20/2258 12/12/20/2258/1 	Solar PV	75	Approved and Preferred Bidder (Operational)	<ul style="list-style-type: none"> The Proposed Establishment of Photovoltaic (Solar Power) Farms in the Northern Cape Province - Kalkbult 	2010	Scoping and EIA	Scatec Solar SA Pty Ltd	Sustainable Development Projects cc
2	<ul style="list-style-type: none"> 12/12/20/2463/1 12/12/20/2463/1/2 12/12/20/2463/1/A2 12/12/20/2463/1/AM3 12/12/20/2463/1/AM4 12/12/20/2463/1/AM5 	Onshore Wind	140	Approved and Preferred Bidder (Operational)	<ul style="list-style-type: none"> Longyuan Mulilo De Aar 2 North Wind Energy Facility Longyuan Mulilo De Aar Maanhaarberg Wind Energy Facility The Wind Energy Facility (North and South) situated on the Plateau Near De Aar, Northern Cape Province 	2010 and 2014	Scoping and EIA and Amendment	Longyuan Mulilo De Aar 2 South (Pty)	Aurecon South Africa (Pty) Ltd and Holland and Associates Environmental Consultants
3	<ul style="list-style-type: none"> 12/12/20/2463/2 12/12/20/2463/2/AM2 	Onshore Wind	100	Approved and Preferred Bidder (Operational)	<ul style="list-style-type: none"> Longyuan Mulilo De Aar Maanhaarberg Wind Energy Facility The Wind Energy Facility (North and South) Situated on The Plateau Near De Aar, Northern Cape Province 	2010 and 2014	Scoping and EIA and Amendment	Mulilo Renewable Energy (Pty) Ltd	Aurecon South Africa (Pty) Ltd
4	<ul style="list-style-type: none"> 14/12/16/3/3/1/1166 14/12/16/3/3/1/1166/AM3 14/12/16/3/3/1/1166/AM4 	Transmission line	132	Approved	<ul style="list-style-type: none"> Basic Assessment for the proposed construction of a 132 kV transmission line corridor adjacent to the existing Eskom transmission line from Longyuan Mulilo De Aar 2 North Wind Energy Facility (WEF) to the Hydra Substation in De Aar, Northern Cape 	2010 and 2014	Basic Assessment	Longyuan Mulilo De Aar 2 North (Pty) Ltd	Aurecon South Africa (Pty) Ltd
5	<ul style="list-style-type: none"> 14/12/16/3/3/1/785 	Transmission line	132	Approved	<ul style="list-style-type: none"> Proposed construction of two 132kV transmission lines from the South & North Wind Energy Facilities on the Eastern Plateau (De Aar 2) near De Aar, Northern Cape. 	2010	Basic Assessment	Mulilo Renewable Energy (Pty) Ltd	Aurecon South Africa (Pty) Ltd
6	<ul style="list-style-type: none"> 14/12/16/3/3/2/278 14/12/16/3/3/2/278/1 14/12/16/3/3/2/278/2 	Onshore Wind	118	Approved	<ul style="list-style-type: none"> Proposed Castle Wind Energy Facility Project, located near De Aar, Northern Cape 	2010 and 2014	Scoping and EIA	Castle Wind Farm (Pty) Ltd	Aurecon South Africa (Pty) Ltd; and Savannah Environmental Consultants (Pty) Ltd
7	<ul style="list-style-type: none"> 14/12/16/3/3/2/564 14/12/16/3/3/2/564/AM1 14/12/16/3/3/2/564/AM2 	Solar PV	75	To be confirmed	<ul style="list-style-type: none"> Proposed Swartwater 75MW solar PV power facility in Petrusville within Renosterburg Local Municipality, Northern Cape 	2010 and 2014	Scoping and EIA and Amendment	AE-AMD Renewable Energy (Pty) Ltd	USK Environmental and Waste Engineering (Pty) Ltd
8	<ul style="list-style-type: none"> 14/12/16/3/3/2/740 	Solar PV	300	Approved	<ul style="list-style-type: none"> Proposed 300MW Solar Power Plant in Phillipstown area in Renosterberg Local Municipality 	2010	Scoping and EIA	To be confirmed	Tshikovha Environmental and Communication Consultants
9	<ul style="list-style-type: none"> 14/12/16/3/3/2/744 	Solar PV	Unknown	Approved	<ul style="list-style-type: none"> Proposed PV facility on farm Jakhalsfontein near De Aar 	2010	Scoping and EIA	Solar Capital (Pty) Ltd	Eco Compliance (Pty) Ltd
10	<ul style="list-style-type: none"> 14/12/16/3/3/2/739 	Solar PV	70 - 100	To be confirmed	<ul style="list-style-type: none"> Proposed 70 - 100 MW Solar Power Plant in Petrusville 	2010	Scoping and EIA	To be confirmed	Tshikovha Environmental and Communication Consultants
11	<ul style="list-style-type: none"> Not issued yet (it is understood that the project is still within the pre-application stage) 	Solar PV	800 (Maximum)	Pre-Application	<ul style="list-style-type: none"> The Proposed Keren Energy Odyssey Solar PV Facilities (Odyssey Solar 1, Odyssey Solar 2, Odyssey Solar 3, Odyssey Solar 4, Odyssey Solar 5, Odyssey Solar 6, Odyssey Solar 7 And Odyssey Solar 8) 	2014	Scoping and EIA	Keren Energy Group Holdings	EnviroAfrica cc
12	<ul style="list-style-type: none"> To be confirmed 	Solar PV	3050	Scoping	<ul style="list-style-type: none"> The Proposed Development of the Crossroads (formally referred to as the Hydra B) Green Energy Cluster of Renewable Energy Facilities and Grid Connection Infrastructure, Pixley Ka Seme District Municipality, Northern Cape Province. The Cluster entails the development of up to 21 solar energy facilities, with the Scoping and EIA Processes consisting of three phases. Phases 1, 2 and 3 consist of 9, 6 and 6 solar facilities, respectively. The Phase 1 Scoping and EIA Processes were launched in January 2023. 	2014	Scoping and EIA	Akuo Energy Afrique	Savannah Environmental Consultants (Pty) Ltd
Study area shown on map	<ul style="list-style-type: none"> 14/12/16/3/3/2/2244 14/12/16/3/3/2/2245 14/12/16/3/3/2/2246 14/12/16/3/3/2/2247 14/12/16/3/3/2/2248 14/12/16/3/3/2/2249 14/12/16/3/3/2/2250 14/12/16/3/3/2/2251 14/12/16/3/3/2/2252 14/12/16/3/3/2/2253 	Solar PV	2180	Scoping and EIA Process underway	<ul style="list-style-type: none"> Proposed Development of 12 Solar Photovoltaic (PV) Facilities (Kudu Solar Facility 1 to 12) and associated infrastructure, near De Aar, Northern Cape Province 	2014	Scoping and EIA	Kudu Solar Facility 1 (Pty) Ltd to Kudu Solar Facility 12 (Pty) Ltd	CSIR

CSIR NUMBER	DFFE REFERENCE	TECHNOLOGY	MW/KV	STATUS	PROJECT TITLE	EIA REGULATIONS	ASSESSMENT PROCESS	APPLICANT	EAP
	<ul style="list-style-type: none"> 14/12/16/3/3/2/2254 14/12/16/3/3/2/2255 								
Shown on map as Existing HV Lines	<ul style="list-style-type: none"> N/A 	Transmission Line	220	Existing Power Line	<ul style="list-style-type: none"> HYDRA ROODEKUIL 2 	-	-	-	-
Shown on map as Existing HV Lines	<ul style="list-style-type: none"> N/A 	Transmission Line	132	Existing Power Line	<ul style="list-style-type: none"> HYDRA ROODEKUIL 1 	-	-	-	-
Shown on map as Existing HV Lines	<ul style="list-style-type: none"> N/A 	Transmission Line	765	Existing Power Line	<ul style="list-style-type: none"> BETA HYDRA 2 	-	-	-	-
Shown on map as Existing HV Lines	<ul style="list-style-type: none"> N/A 	Transmission Line	400	Existing Power Line	<ul style="list-style-type: none"> HYDRA PERSEUS 3 	-	-	-	-
Shown on map as Existing HV Lines	<ul style="list-style-type: none"> N/A 	Transmission Line	220	Existing Power Line	<ul style="list-style-type: none"> VAN DER KLOOF ROODEKUIL 2 	-	-	-	-
Shown on map as Existing HV Lines	<ul style="list-style-type: none"> N/A 	Transmission Line	220	Existing Power Line	<ul style="list-style-type: none"> VAN DER KLOOF ROODEKUIL 1 	-	-	-	-
Shown on map as Existing HV Lines	<ul style="list-style-type: none"> N/A 	Transmission Line	400	Existing Power Line	<ul style="list-style-type: none"> BETA HYDRA 1 	-	-	-	-
Shown on map as Existing HV Lines	<ul style="list-style-type: none"> N/A 	Transmission Line	400	Existing Power Line	<ul style="list-style-type: none"> HYDRA PERSEUS 2 	-	-	-	-
Shown on map as Existing HV Lines	<ul style="list-style-type: none"> N/A 	Transmission Line	132	Existing Power Line	<ul style="list-style-type: none"> KALKBULT/KAREEBOSCHPAN 1 	-	-	-	-
Shown on map as Existing HV Lines	<ul style="list-style-type: none"> N/A 	Transmission Line	132	Existing Power Line	<ul style="list-style-type: none"> ROODEKUIL/ORANIA 1 	-	-	-	-
Shown on map as Planned HV Lines	<ul style="list-style-type: none"> N/A 	Transmission Line	765	Planned Power Line	<ul style="list-style-type: none"> Perseus to Gamma 2nd 765 kV line Cape Corridor Phase 4: 2nd Zeus-Per-Gam-Ome 765kV Line 	-	-	-	-
Shown on map as Planned HV Lines	<ul style="list-style-type: none"> N/A 	Transmission Line	765	Planned Power Line	<ul style="list-style-type: none"> Relocate Beta-Hydra 765kV line to form Perseus-Hydra 1st 765kV line Cape Corridor Phase 2: Zeus - Hydra 765kV Integration 	-	-	-	-
Shown on map as Planned HV Lines	<ul style="list-style-type: none"> N/A 	Transmission Line	765	Planned Power Line	<ul style="list-style-type: none"> Perseus to Gamma 2nd 765 kV line Cape Corridor Phase 4: 2nd Zeus-Per-Gam-Ome 765kV Line 	-	-	-	-

Refer to Table 14-7 below for a rating of the potential cumulative impacts.

Table 14-7: Rating of Cumulative Traffic Related Impacts during the Construction and Decommissioning Phase

Impact	Impact Criteria		Significance and Ranking (Pre-Mitigation)	Potential mitigation measures	Significance and Ranking (Post-Mitigation)	Confidence Level
CONSTRUCTION AND DECOMMISSIONING PHASE						
Congestion and delays on road network	Status	Neutral	Moderate (3)	<ul style="list-style-type: none"> Stagger delivery trips and schedule trips, including staff trips outside of peak hours where possible. 	Low (4)	High
	Spatial Extent	Local				
	Duration	Medium Term				
	Consequence	Substantial				
	Probability	Unlikely				
	Reversibility	High				
Potential impact on traffic safety and increase in accidents with other vehicles and animals	Status	Negative	Moderate (3)	<ul style="list-style-type: none"> Implement speed control by means of a stop and go system and speed limit road signage within the construction and decommissioning site. Ensure all vehicles are roadworthy, visible, adequately marked, and operated by an appropriately licenced operator. 	Low (4)	High
	Spatial Extent	Local				
	Duration	Medium Term				
	Consequence	Substantial				
	Probability	Unlikely				
	Reversibility	Low				
Condition of road surface	Status	Neutral	Moderate (3)	<ul style="list-style-type: none"> Regular maintenance of internal farm access roads by the contractor. Ensure private access roads that are impacted on by the proposed development are restored to original pre-construction road condition. 	Very Low (5)	High
	Spatial Extent	Local				
	Duration	Medium Term				
	Consequence	Substantial				
	Probability	Unlikely				
	Reversibility	High				
Dust Pollution	Status	Neutral	Low (4)	<ul style="list-style-type: none"> Implement dust control on gravel roads within the decommissioning site. Implement speed control by means of a stop and go system and speed limit road signage within the construction and decommissioning site. 	Low (4)	High
	Spatial Extent	Local				
	Duration	Medium Term				
	Consequence	Moderate				
	Probability	Unlikely				
	Reversibility	High				
Noise Pollution	Status	Neutral	Low (4)	<ul style="list-style-type: none"> Stagger delivery trips. 	Low (4)	High
	Spatial Extent	Local				
	Duration	Medium Term				
	Consequence	Moderate				

Impact	Impact Criteria		Significance and Ranking (Pre-Mitigation)	Potential mitigation measures	Significance and Ranking (Post-Mitigation)	Confidence Level
	Probability	Unlikely				
	Reversibility	High				
	Irreplaceability	Replaceable				

14.9.5 Battery Energy Storage System

A Lithium-Ion Battery Energy Storage System (BESS) and Redox Flow BESS were both considered for the proposed project. For Redox Flow BESS, various chemical compositions are likely, such as Vanadium. Refer to Chapter 15 of this EIA Report for a High-Level Safety, Health and Environment Risk Assessment, which provides high level information on the safety, health and environmental risks of the BESS technologies.

Both BESS technologies have been considered in this assessment. This type of technology will have no significant influence on traffic; therefore, both are considered viable from a traffic perspective. The traffic impacts discussed in Section 14.9 are also associated with the BESS.

14.9.6 No-Go Option

The no-go option will result in no additional impacts on traffic and will result in the road and traffic status quo being maintained. However, with that being said, no fatal flaws were discovered in the course of the investigations for the proposed Kudu Solar Facilities, and with mitigation the potential impact significance is rated as mainly low to very low.

14.10 Impact Assessment Summary

The overall impact significance findings, following the implementation of the proposed mitigation measures are shown in the Table 14-8 below:

Table 14-8: Overall Impact Significance (Post Mitigation)

Phase	Overall Impact Significance
Construction	Low to Very Low Risk / Impact (4-5)
Operational	Insignificant
Decommissioning	Low to Very Low Risk / Impact (4-5)
Nature of Impact	Overall Impact Significance
Cumulative - Construction	Low Risk / Impact (4)
Cumulative - Operational	Insignificant
Cumulative - Decommissioning	Low to Very Low Risk / Impact (4-5)

14.11 Legislative and Permit Requirements

The Legislative and Permit requirements pertaining to the transport requirements for the proposed project is listed below:

- Abnormal load permits, (Section 81 of the National Road Traffic Act)
- Port permit (Guidelines for Agreements, Licenses and Permits in terms of the National Ports Act No. 12 of 2005), and
- Authorisation from Road Authorities to modify the road reserve to accommodate turning movements of abnormal loads at intersections.

14.12 Environmental Management Programme Inputs

The EMP inputs for traffic related impacts is shown in Table 14-9 below.

Table 14-9: Environmental Management Programme for Traffic Impacts

Impact	Mitigation/Management Objectives	Mitigation/Management Actions	Monitoring		
			Methodology	Frequency	Responsibility
A. PLANNING AND DESIGN PHASE					
<ul style="list-style-type: none"> Increased traffic generation 	Manage impact that additional traffic generation will have on road network	<ul style="list-style-type: none"> If abnormal loads need to be transported by road to the site, a permit will need to be applied for in terms of Section 81 of the National Road Traffic Act and authorisation needs to be obtained from the relevant road authorities to modify the road reserve to accommodate turning movements at intersections (if necessary). It is not anticipated that any widening of the intersection at TR38/01 and DR3093 will be required, however, the existing island will need to be removed (approximately 60 m²) to accommodate the turning movements of the abnormal load vehicles. 	<ul style="list-style-type: none"> Ensure that the permits and authorisations are applied for and obtained prior to commencement. Verify that this has been undertaken by reviewing approved permits. 	<ul style="list-style-type: none"> Once-off during the planning and design phase Once-off during the planning and design phase. 	<ul style="list-style-type: none"> Contractor ECO
		<ul style="list-style-type: none"> The route to the sites should be further investigated to ensure that abnormal loads are not obstructed at any point by geometric, height and width limitations along the route. 	<ul style="list-style-type: none"> Ensure that this is taken into consideration during the planning and design phase by reviewing signed minutes of meetings or signed reports. 	<ul style="list-style-type: none"> Once-off during the planning and design phase. 	<ul style="list-style-type: none"> Project Developer and Traffic Specialist
		<ul style="list-style-type: none"> Discussions must be held with the relevant landowners on which the internal farm access roads leading to the site is located, prior to commencement to confirm requirements. 	<ul style="list-style-type: none"> Ensure that this is taken into consideration during the planning and design phase by reviewing signed minutes of meetings or signed reports. 	<ul style="list-style-type: none"> Once-off during the planning and design phase. 	<ul style="list-style-type: none"> Project Developer and ECO
		<ul style="list-style-type: none"> Ensure that the requirements for use of the internal farm access roads leading to the sites are addressed and considered in the design, as and where applicable. 	<ul style="list-style-type: none"> Ensure that this is taken into consideration during the planning and design phase by reviewing signed minutes of meetings or signed reports. 	<ul style="list-style-type: none"> Once-off during the planning and design phase. 	<ul style="list-style-type: none"> Project Developer and ECO

Impact	Mitigation/Management Objectives	Mitigation/Management Actions	Monitoring		
			Methodology	Frequency	Responsibility
		<ul style="list-style-type: none"> Provide a Transport Traffic Plan to the Provincial and Municipal Road Department (if required). 	<ul style="list-style-type: none"> Ensure that the plan is compiled and submitted prior to commencement. Verify that this has been undertaken by reviewing approved plans. 	<ul style="list-style-type: none"> Once-off during the planning and design phase Once-off during the planning and design phase. 	<ul style="list-style-type: none"> Contractor ECO
<ul style="list-style-type: none"> Accelerated degradation of road structure due to construction, operational and decommissioning phase traffic. 	Limit the deterioration of the road condition due to construction, operational and decommissioning phase traffic.	<ul style="list-style-type: none"> A Road Maintenance Plan should be developed for the internal farm access roads (i.e. internal private roads leading off the DR3093) that will be used. The plan should address requirements such as, but not limited to, grading, dust suppressant mechanisms, drainage (where required), signage, and speed limits. The Road Maintenance Plan must ensure regular maintenance of the roads. The Road Maintenance Plan must be communicated with the relevant authorities, where required, and must be provided to the surrounding community forum prior to commencement of construction. 	<ul style="list-style-type: none"> Ensure that the plan is compiled and submitted prior to commencement. Verify that this has been undertaken by reviewing approved plans. 	<ul style="list-style-type: none"> Once-off during the planning and design phase Once-off during the planning and design phase. 	<ul style="list-style-type: none"> Project Developer, Traffic Specialist and Contractor ECO
B. CONSTRUCTION PHASE					
<ul style="list-style-type: none"> Increased traffic generation during the construction phase resulting in a reduction of road based level of service and potential congestion and delays on the surrounding road network. 	Plan the project to spread and reduce the amount of road based traffic during the construction phase.	<ul style="list-style-type: none"> Plan and stagger delivery trips and schedule deliveries so that they occur outside of peak traffic periods, where possible. 	<ul style="list-style-type: none"> Monitor and management of traffic generated and when trips are made. 	<ul style="list-style-type: none"> During construction 	<ul style="list-style-type: none"> Contractor and ECO
		<ul style="list-style-type: none"> Suitable parking areas should be designated for construction trucks and vehicles at the construction site camp in order to promote order and improve safety. 	<ul style="list-style-type: none"> Monitor the placement of the designated parking area for trucks and vehicles via visual inspections and record and report any non-compliance. 	<ul style="list-style-type: none"> Once-off prior to construction and as required during the construction phase. 	<ul style="list-style-type: none"> Project Developer and ECO
		<ul style="list-style-type: none"> The use of public transport (buses and/or minibus taxis) to convey construction personnel to the site should be encouraged. Staff trips should occur outside of peak hours, where possible. 	<ul style="list-style-type: none"> Contractor should record the arrival and departure times as well as the number of workers using public transport. 	<ul style="list-style-type: none"> Once a month on a randomly selected day. 	<ul style="list-style-type: none"> Appointed Contractor

Impact	Mitigation/Management Objectives	Mitigation/Management Actions	Monitoring		
			Methodology	Frequency	Responsibility
		<ul style="list-style-type: none"> Ensure that the existing island removal at the intersection of TR38/01 and DR3093 is undertaken in an environmental conscious manner, once the relevant authorisations from the road authorities are obtained. Ensure that construction vehicles always remain within a demarcated area at the intersection, and that local road officials are informed of the planned island removal process. 	<ul style="list-style-type: none"> Monitor the island removal process via visual inspections and record and report any non-compliance. 	<ul style="list-style-type: none"> As required during the construction phase. 	<ul style="list-style-type: none"> Project Developer and ECO
<ul style="list-style-type: none"> Increased level of road accidents (involving pedestrians, animals, other motorists on the surrounding road network) due to increased traffic during construction. 	<p>Minimise the impact of the construction activities on the local traffic and avoid accidents with pedestrians, animals and other drivers on the surrounding roads.</p> <p>Reduce number of road accidents due to increased traffic during construction.</p>	<ul style="list-style-type: none"> Well maintained vehicles should be used together with well-trained drivers during the construction phase. Vehicle maintenance and driver competency should be monitored. Proof of driver competency as well as the vehicle checks should be verified and undertaken to ensure that vehicles are roadworthy and hence, do not pose a safety risk. The Contractors must ensure that construction vehicles are roadworthy, visible, adequately marked, properly serviced and maintained, operated by an appropriately licensed operator, and respect the vehicle safety standards implemented by the Project Developer. 	<ul style="list-style-type: none"> Carry out random checks of driver licenses and conduct random visual inspections of construction vehicles for roadworthiness. 	<ul style="list-style-type: none"> Random visual inspection of vehicles weekly. 	<ul style="list-style-type: none"> Contractor
		<ul style="list-style-type: none"> To ensure reduced speeds along the roads, implement speed control mechanisms within the construction site by means of a stop and go system, implement speed limits and placement of road signage for the speed limits. 	<ul style="list-style-type: none"> Implement speed control mechanisms within the construction site prior to commencement of construction. Carry out random inspections to verify whether proper speed control is being implemented. 	<ul style="list-style-type: none"> On-going Random during the construction phase 	<ul style="list-style-type: none"> Contractor and ECO ECO
		<ul style="list-style-type: none"> Adhere to all speed limits applicable to all roads used. 	<ul style="list-style-type: none"> Ensure that speed limits are adhered to. Carry out random visual inspections to verify speed limits and general awareness of vehicle drivers. 	<ul style="list-style-type: none"> Daily Random during the construction phase 	<ul style="list-style-type: none"> Contractor and ECO ECO

Impact	Mitigation/Management Objectives	Mitigation/Management Actions	Monitoring		
			Methodology	Frequency	Responsibility
		<ul style="list-style-type: none"> Road kill monitoring programme (inclusive of wildlife collisions record keeping) should be established. 	<ul style="list-style-type: none"> Appropriate monitoring should be undertaken. 	<ul style="list-style-type: none"> Weekly 	<ul style="list-style-type: none"> Contractor and ECO
		<ul style="list-style-type: none"> Implement clear and visible signage indicating movement of vehicles at intersections within the construction site and in the vicinity of the nearby farm steads. 	<ul style="list-style-type: none"> Implement clear signalisation. Carry out random inspections to verify whether proper construction signage is being implemented. 	<ul style="list-style-type: none"> On-going Random during the construction phase 	<ul style="list-style-type: none"> Contractor and ECO ECO
<ul style="list-style-type: none"> Deterioration in the surface condition of the roads and accelerated degradation of road structure due to construction traffic. 	Limit the deterioration of the road condition due to construction traffic.	<ul style="list-style-type: none"> Ensure that there is regular maintenance of the internal farm access roads (i.e. internal private roads leading off the DR3093) that will be used, by the contractor during the construction phase in line with the agreed maintenance plan. Ensure that the upgrading of the internal farm access roads (i.e. internal private roads leading off the DR3093 that are impacted on by the proposed project and will be used), is undertaken to suitable standards as specified by the civil engineer and in accordance with the maintenance plan. Ensure that the internal farm access roads (i.e. internal private roads leading off the DR3093 that are impacted on by the proposed project and will be used) are restored to its original pre-construction road condition. 	<ul style="list-style-type: none"> Carry out visual inspections to verify if regular maintenance is being undertaken. Ensure that the internal farm access road to site is upgraded through photographic surveys and monitoring. 	<ul style="list-style-type: none"> Bi-monthly Ongoing 	<ul style="list-style-type: none"> Contractor and ECO Project Developer, Contractor and ECO
		<ul style="list-style-type: none"> Construction activities will have a higher impact than the normal road activity and therefore the internal farm access roads (i.e. internal private roads leading off the DR3093) to site should be inspected on a weekly basis for structural damage. 	<ul style="list-style-type: none"> Ensure that the access road to site maintains current condition through photographic surveys and monitoring. 	<ul style="list-style-type: none"> Weekly 	<ul style="list-style-type: none"> Contractor and ECO
		<ul style="list-style-type: none"> Implement management strategies for dust generation e.g. apply dust suppressant on the gravel roads on the construction site, exposed areas and stockpiles. Avoid the use of potable water for dust suppression during the 	<ul style="list-style-type: none"> Ensure dust management measures are in place to adequately decrease the generation of dust. 	<ul style="list-style-type: none"> On-going 	<ul style="list-style-type: none"> Contractor and ECO

Impact	Mitigation/Management Objectives	Mitigation/Management Actions	Monitoring		
			Methodology	Frequency	Responsibility
		<p>construction phase and consider the use of alternative approved sources, where possible.</p> <ul style="list-style-type: none"> Vehicles must not be overloaded during the construction phase in order to reduce impacts on the road structures, particularly the access roads leading to the site. Random visual inspection of vehicles should be undertaken in order to monitor for overloading. The inspections should also verify if the trucks are covered with appropriate material (such as tarpaulin) if and where possible. 			
		<ul style="list-style-type: none"> Perform visual inspection of vehicles during the construction phase. 	<ul style="list-style-type: none"> Random visual inspection of vehicles weekly. 	<ul style="list-style-type: none"> Appointed Contractor 	
<ul style="list-style-type: none"> Impact on air quality due to dust generation, noise and exhaust emissions from construction vehicles and equipment. 	Limit the release of noise, pollutants and dust emissions	<ul style="list-style-type: none"> Implement management strategies for dust generation e.g. apply dust suppressant on the gravel roads on the construction site, exposed areas and stockpiles. Avoid the use of potable water for dust suppression during the construction phase and consider the use of alternative approved sources, where possible. 	<ul style="list-style-type: none"> Ensure dust management measures are in place to adequately decrease the generation of dust. 	<ul style="list-style-type: none"> On-going 	<ul style="list-style-type: none"> Contractor and ECO
		<ul style="list-style-type: none"> Postpone or reduce dust-generating activities during periods with strong wind. Earthworks may need to be rescheduled or the frequency of application of dust control/suppressant increased. 	<ul style="list-style-type: none"> Ensure dust management measures are in place to decrease the dust generated. 	<ul style="list-style-type: none"> On-going 	<ul style="list-style-type: none"> Contractor and ECO
		<ul style="list-style-type: none"> Avoid using old and unmaintained construction equipment (which generate high sound levels and greater exhaust emissions) and ensure equipment is well maintained. 	<ul style="list-style-type: none"> Manage noise levels and air pollutants from construction vehicles through checking the condition of vehicles. 	<ul style="list-style-type: none"> On-going 	<ul style="list-style-type: none"> Contractor and ECO
C. OPERATIONAL PHASE					
<ul style="list-style-type: none"> Increased level of road accidents (involving pedestrians, animals, other motorists on the surrounding tarred/gravel road network) due to increased (but 	Minimise the impact of the operational activities on the local traffic and avoid accidents with pedestrians, animals and other drivers on	<ul style="list-style-type: none"> Well maintained vehicles should be used together with well-trained drivers during the operational phase, as required. Vehicle maintenance and driver competency should be monitored. Proof of driver competency as well as the vehicle checks should be verified and undertaken to ensure that vehicles are 	<ul style="list-style-type: none"> Carry out random checks of driver licenses and conduct random visual inspections of vehicles for roadworthiness. 	<ul style="list-style-type: none"> Random visual inspection of vehicles weekly. 	<ul style="list-style-type: none"> Project Developer

Impact	Mitigation/Management Objectives	Mitigation/Management Actions	Monitoring		
			Methodology	Frequency	Responsibility
limited) traffic during the operational phase.	the surrounding tarred/ gravel roads. Reduce number of road accidents due to increased traffic during the operational phase.	roadworthy and hence, do not pose a safety risk. Vehicles must be roadworthy, visible, adequately marked, properly serviced and maintained, and operated by an appropriately licensed operator.			
		<ul style="list-style-type: none"> ▪ Adhere to all speed limits applicable to all roads used. 	<ul style="list-style-type: none"> ▪ Ensure that speed limits are adhered to. ▪ Carry out random visual inspections to verify speed limits and general awareness of vehicle drivers. 	<ul style="list-style-type: none"> ▪ Daily ▪ Random during the operational phase 	<ul style="list-style-type: none"> ▪ Project Developer
		<ul style="list-style-type: none"> ▪ Implement clear and visible signage indicating movement of vehicles at intersections and in the vicinity of the nearby farm steads. 	<ul style="list-style-type: none"> ▪ Implement clear signalisation. ▪ Carry out random inspections to verify whether proper signage is being implemented. 	<ul style="list-style-type: none"> ▪ Ongoing ▪ Random during the operational phase 	<ul style="list-style-type: none"> ▪ Project Developer
		<ul style="list-style-type: none"> ▪ The use of public transport (buses and/or minibus taxis) or carpooling to convey operational personnel to the site should be encouraged. ▪ Staff trips should occur outside of peak hours, where possible. 	<ul style="list-style-type: none"> ▪ Monitor the requirements 	<ul style="list-style-type: none"> ▪ On-going 	<ul style="list-style-type: none"> ▪ Project Developer
		<ul style="list-style-type: none"> ▪ Limit access to the site to operational personnel. 	<ul style="list-style-type: none"> ▪ Maintain a register of visitors and staff that enter site and restrict access to personnel. 	<ul style="list-style-type: none"> ▪ On-going 	<ul style="list-style-type: none"> ▪ Project Developer
<ul style="list-style-type: none"> ▪ Accelerated degradation of road structure due to operational traffic. 	Limit the deterioration of the road condition due to operational phase traffic.	<ul style="list-style-type: none"> ▪ The main access roads to site should be inspected on a weekly basis for structural damage. 	<ul style="list-style-type: none"> ▪ Ensure that the main access road to site maintains current condition through photographic surveys and monitoring. 	<ul style="list-style-type: none"> ▪ Weekly 	<ul style="list-style-type: none"> ▪ Project Developer
		<ul style="list-style-type: none"> ▪ Ensure that there is regular maintenance of the internal farm access roads (i.e. internal private roads leading off the DR3093) that will be used, by the operator during the operational phase in line with the agreed maintenance plan. 	<ul style="list-style-type: none"> ▪ Carry out visual inspections to verify if regular maintenance is being undertaken. ▪ Ensure that the internal farm access road to site is upgraded through 	<ul style="list-style-type: none"> ▪ Weekly 	<ul style="list-style-type: none"> ▪ Project Developer

Impact	Mitigation/Management Objectives	Mitigation/Management Actions	Monitoring		
			Methodology	Frequency	Responsibility
			photographic surveys and monitoring.		
		<ul style="list-style-type: none"> Implement management strategies for dust generation e.g. apply dust suppressant on gravel roads on the operational site, exposed areas and stockpiles. 	<ul style="list-style-type: none"> Ensure dust management measures are in place to adequately decrease the generation of dust. 	<ul style="list-style-type: none"> On-going 	<ul style="list-style-type: none"> Project Developer
		<ul style="list-style-type: none"> Vehicles must not be overloaded during the operational phase (where applicable) in order to reduce impacts on the road structures. Random visual inspection of vehicles should be undertaken in order to monitor for overloading (where applicable). 	<ul style="list-style-type: none"> Perform visual inspection of vehicles. 	<ul style="list-style-type: none"> Random visual inspection of vehicles weekly. 	<ul style="list-style-type: none"> Project Developer
D. DECOMMISSIONING PHASE					
<ul style="list-style-type: none"> Ensure that the construction mitigation and management measures are adhered to during the decommissioning phase. 					

14.13 Final Specialist Statement and Authorisation Recommendation

14.13.1 Statement and Reasoned Opinion

This report summarises the existing transportation conditions within the site vicinity and provides an assessment of the transportation impacts of the proposed development on the surrounding transport system. From the traffic impact investigation and discussions in the report the following conclusions can be made:

- The preferred route for the haulage of imported materials is from the Port of Ngqura to the site.
- The preferred access route option to the proposed facility will be from the R48 along DR3093, DR3084, and DR3096 gravel roads (i.e. Access Route Option 1). As noted above, Access Route Option 1 - Route A (along TR38/01, DR3093, and DR3096) will provide access to all the proposed Kudu Solar Facilities. Alternatively, once the internal roads are constructed at Kudu Solar Facility 5, it can also be used to access Kudu Solar Facilities 1 to 4. Furthermore, once the internal roads are constructed at Kudu Solar Facility 7, it can also be used to access Kudu Solar Facilities 8 to 12. Access Route Option 1 - Route B (Along TR38/01, DR3093 and DR3084) will provide access to the proposed Kudu Solar Facilities 1 to 5.
- Sufficient shoulder sight distances (SSD) are available along the R48 at the DR3093 in both directions.
- Direct access to the proposed development will be taken off DR3093.
- It is not anticipated that any widening of the intersection at TR38/01 and DR3093 will be required, however, the existing island will need to be removed (approximately 60m²) to accommodate the turning movements of the abnormal load vehicles.
- Based on the wheel tracking analysis of the abnormal load vehicles, it can be concluded that no road will need to be lengthened by more than 1 kilometre for Access Route Option 1.
- Temporary counting stations recorded the ADT in 2011 as 62 vehicles (two-way) along DR3093 and as 8 vehicles (two-way) along DR3084 per day.
-
- If these volumes are increased by a growth rate of 2% per annum, this would relate to the ADT in 2023 as 79 vehicles (two-way) along DR3093 and as 10 vehicles (two-way) along DR3084 per day.
- Traffic information for 2021 indicated that the R389 carries an ADT of 626 vpd (two-way) and the R48 carries an ADT of 866 vpd (two-way).
- The R389 and the R48 operates well below the capacity of 2000 vehicles per hour for a Class 1 principal arterial with two lanes.
- Traffic will be generated during the Construction, Operational and Decommissioning phases of the project.
- During the Construction and Decommissioning phases, an additional **30 daily trips (two-way)** and **2 peak hour trips (two-way)** will be generated by the proposed solar PV facility.
- During the Operation phases, an additional **10 daily trips (two-way)** and **1 peak hour trip (two-way)** will be generated by the proposed solar PV facility.
- The following traffic impacts are related to the trips generated during the Construction and Decommissioning phases:
 - Potential congestion and delays on the surrounding road network.

- Potential impact on traffic safety and increase in accidents with other vehicles or animals.
- Potential change in the quality of the surface condition of the roads.
- Potential noise and dust pollution.
- Traffic generated during the Operational phase will have an insignificant traffic impact on the surrounding road network.
- The proposed project will have a range of potential traffic related impacts ranging from very low to moderate significance before mitigation, which is expected to be reduced to very low to low significance with the appropriate mitigation. No fatal flaws were discovered during the investigations. The proposed project is supported, and it is therefore recommended that the activity is authorised, with the understanding that all mitigation measures recommended in this report will be strictly implemented.

14.13.2 EA Condition Recommendations

The following mitigation measures to address the potential traffic impacts are recommended for inclusion in the EMPr and EA conditions:

- Implement dust control of the gravel roads within the construction site.
- Undertake regular maintenance of the internal farm access roads by the contractor during the construction and decommissioning phases and then by the operator during the operational phase.
- Removal of the island at the TR38/01 and DR3093 intersection to accommodate the turning movements of the abnormal load vehicles.
- Upgrading of the internal farm access road (i.e. internal private roads leading off DR3093 that are impacted on by the proposed project) to suitable standards as specified by the civil engineer and regular maintenance of these access roads during all phases of the project, especially during the construction and decommissioning phases. Following construction, these specific internal private access roads should be restored to original pre-construction road condition.
- Implement speed control by means of a stop and go system and speed limit road signage within the construction site.
- Ensure all vehicles are roadworthy, visible, adequately marked and operated by an appropriately licensed operator.
- The route to the site should be further investigated to ensure that the abnormal loads are not obstructed at any point by geometric, height and width limitations along the route.
- The applicable permits to transport the abnormal loads should be obtained.
- Stagger delivery trips and schedule deliveries/trips outside of the peak traffic periods, where possible.
- Staff trips should also occur outside of the peak hours where possible.

No other remedial or mitigation measures will be required to accommodate the additional traffic generated by the proposed Solar PV Facility. Provided that the above recommendations are adhered to, the proposed development of the Solar PV facility can be supported from a traffic engineering perspective.

14.14 References

- Department of Transport, Guidelines for Traffic Impact Studies, Report No. PR93/645, Pretoria, 1995.
- Department of Transport, South African Trip Generation Rates, Report No. RR92/228, Pretoria, 1995.
- Committee of Transport Officials (COTO), South African Trip Data Manual, TMH 17, Committee Draft 2.2, August 2020.
- Committee of Transport Officials (COTO), South African Traffic Impact and Site Traffic Assessment Manual Standards and Requirements Manual, Volume 2 TMH 16, Committee Draft 2.0, October 2020.
- Committee of Transport Officials (COTO), South African Traffic Impact and Site Traffic Assessment Manual, Volume 1 TMH 16, Committee Draft 2.0, May 2018.
- SANRAL Geometric Design Guide
- Department of Transport, TRH17, Geometric Design of Rural Roads, 1988

APPENDICES

Appendix A - Specialist Expertise



CURRICULUM VITAE

ANNEBET KRIGE

GENERAL INFORMATION:

Name	:	ANNEBET KRIGE
Date of Birth	:	20 November 1984
Marital Status	:	Married
Home Language	:	Afrikaans
Profession	:	Civil Engineer
Specialism	:	Transport Planning and Traffic Engineering
Joined Sturgeon	:	2018
Nationality	:	South African
Years' Experience	:	15+
Qualifications	:	M Eng (Transportation), B Eng (Civil)
Professional Associations	:	Engineering Council of South Africa (ECSA): Professional Engineer (20150161) South African Institution of Civil Engineering (SAICE): Member (206324)



KEY EXPERTISE:

AnneBet Krige is registered as a Professional Civil Engineer with the Engineering Council of South Africa (ECSA). Over the past 15 years, she has gained extensive knowledge in the Civil Engineering field and currently works as a Traffic Engineer for Sturgeon Consulting. She obtained her Masters' Degree in Transportation Engineering from the University of Stellenbosch in 2010 and specialises in this field.

Expertise & Specialised Skills:

AnneBet has gained extensive experience in the following fields:

- Traffic Studies and Transportation Planning (Statements, Assessments, Parking Studies);
- Design of Non-Motorised Transport Facilities;
- Design and Upgrading of Traffic Signals;
- Traffic Accommodation Plans;
- Design of Civil Engineering Infrastructure for various developments (Water, Sewerage, Stormwater, Roads);
- Rehabilitation and Reseal of existing National and Provincial Roads;
- Construction of new Roads;
- Tender Documentation.
- Contract Administration

EMPLOYMENT RECORD:

2021 - Present	Director, Sturgeon Consulting
2018 - 2021	Associate, Sturgeon Consulting
2011 - 2018	Traffic Engineer, Element Consulting Engineers
2006 - 2011	Engineer in Training, EFG Engineers

www.sturgeonsa.co.za

STURGEON Consulting (PTY) LTD (Reg No. 2015/059313/07)
Director: A Krige (Pr Eng) | Associate: SJ Larratt (Pr Tech Eng)
7 Waterberg Crescent, Clara Anna Fontein, Durbanville, 7550

October 2022



CURRICULUM VITAE

ANNEBET KRIGE

KEY QUALIFICATIONS/EDUCATION:

2010 : M Eng (Transportation), University of Stellenbosch
2006 : B Eng (Civil), University of Stellenbosch

PROFESSIONAL AFFILIATIONS

Professional Engineer, Engineering Council of South Africa (ECSA) - 20150161 - 1 May 2015

PROJECT EXPERIENCE - TRANSPORTATION ENGINEERING (TRAFFIC STUDIES)

Bottling Plant Farm Kaaldraai		Normandien Farms
Traffic Impact Study for the proposed Water Bottling Plant, Tulbagh		
Role & Responsibilities:	Traffic Engineer	
Completed/Current:	2021	
	Study Value: R35 000	
Ceres PV Farms		Veroniva Energy
Traffic Impact Assessment for nine 175MW Solar Photo Voltaic Farms, Tankwa Karoo		
Role & Responsibilities:	Traffic Engineer	
Completed/Current:	2021	
	Study Value: R57 000	
Mamre Service Station		Plan Africa Consulting
Traffic Impact Assessment for the proposed Rezoning of Erf 615, Mamre		
Role & Responsibilities:	Traffic Engineer	
Completed/Current:	2019	
	Study Value: R34 700	
Langebaanweg Truck Stop		West Coast Petroleum (Pty) Ltd
Access Investigation / Traffic Impact Assessment for the proposed Langebaanweg Truck Stop		
Role & Responsibilities:	Traffic Engineer	
Completed/Current:	2020	
	Study Value: R89 800	
Abbotsdale		CK Rumboll and Partners
Traffic Impact Assessment for the Industrial Development on Portion A of Erf 373, Abbotsdale		
Role & Responsibilities:	Traffic Engineer	
Completed/Current:	2019	
	Study Value: R60 100	
Grootfontein - Tsumkwe Feasibility Study		Pregon Consulting Engineers
Feasibility Study for the Upgrade to Bitumen Standard of M0074: Grootfontein - Tsumkwe		
Role & Responsibilities:	Traffic Engineer	
Completed/Current:	Current	
	Study Value: R163 600	
Sleeper Site, East London		
Traffic Study for the Development of the Sleeper Site, East London		
Role & Responsibilities:	Traffic Engineer	
Completed/Current:	2017	
	Study Value: R255 000	
Worcester Traffic Study		
Traffic Study at Pre-Determined intersections in Worcester		
Role & Responsibilities:	Traffic Engineer	
Completed/Current:	2017	
	Project Value: R537 000	



CURRICULUM VITAE

ANNEBET KRIGE

PV Farm Hanover	
Traffic Impact Statement for the Proposed Solar PV Farm, Hanover	
Role & Responsibilities:	Traffic Engineer
Completed/Current: 2017	Study Value: R38 500
Malmesbury Sand Mine	
Tip Trans Logistix	
Traffic Impact Statement for a Sand Mine, Malmesbury	
Role & Responsibilities:	Traffic Engineer
Completed/Current: 2017	Study Value: R24 500
Strand Storage Facilities	
Asla Devco	
Traffic Impact Study for the proposed Storage and Office Facilities in Strand	
Role & Responsibilities:	Traffic Engineer
Completed/Current: 2017	Study Value: R33 500
Dube Tradeport	
Dube Tradeport	
Traffic Impact Study for Dube Tradeport, Durban	
Role & Responsibilities:	Traffic Engineer
Completed/Current: Current	Study Value: R80 000

PROJECT EXPERIENCE - GENERAL TRANSPORTATION ENGINEERING

Bonnievale Speed Survey		WCG
Speed Limit Survey for TR32/1, Bonnievale		
Role & Responsibilities:	Traffic Engineer	
Completed/Current: 2021	Study Value: R70 000	
Road Safety Audit		Namibia Roads Authority
Road Safety Audit for T0602: Gobabis to Buitepos		
Role & Responsibilities:	Traffic Engineer	
Completed/Current: 2016	Contract Value:	
Non-Motorised Transport, City of Cape Town		City of Cape Town
Implementation of the Non-Motorised Transport programme to the City of Cape Town		
Role & Responsibilities:	Traffic Engineer	
Completed/Current: 2016	Contract Value: R50m	
Westbury Pedestrian Bridge, Johannesburg		Johannesburg Development Agency
Traffic Accommodation Plan for the construction of the Westbury Pedestrian Bridge, Johannesburg		
Role & Responsibilities:	Traffic Engineer	
Completed/Current: 2014	Contract Value: Unknown	
Erven 13259 and 13585, Brackenfell		Group 5 Property Development
Traffic Accommodation Plan for the development of Erven 13259 and 13585, Brackenfell		
Role & Responsibilities:	Traffic Engineer	
Completed/Current: 2014	Contract Value: R550 000	
Lakeview and Klipspruit BRT Stations, Soweto		Johannesburg Roads Authority
Non-motorised Transport for Lakeview and Klipspruit BRT Stations, Soweto		
Role & Responsibilities:	Traffic Engineer / Design Engineer	
Completed/Current: 2014	Contract Value: R35 million	



CURRICULUM VITAE

ANNEBET KRIGE

PROJECT EXPERIENCE – REHABILITATION / RESEAL / NEW ROAD CONSTRUCTION

Upgrading of Medway Road, Richards Bay	
Upgrading of Medway Road	
Role & Responsibilities:	Assistant Engineer
Completed/Current:	Current Contract Value: R50 million
Trunk Road 32 between N2 and Herbertsdale Provincial Government Western Cape	
The Reseal / Rehabilitation of a section of Main Road 342 between km 7.72 and Herbertsdale	
Role & Responsibilities:	Assistant Engineer
Completed/Current:	Current Contract Value: Unknown
National Route 7, Garies SANRAL	
Repair and Reseal of National Route 7 Section 7 between Garies and km 60	
Role & Responsibilities:	Assistant Engineer
Completed/Current:	Current Contract Value: R101.4 million
National Route 7, Okiep SANRAL	
Repair and Reseal of National Route 7 Section 7 to 8 between km 60 and Okiep	
Role & Responsibilities:	Assistant Engineer
Completed/Current:	Current Contract Value: R95.5 million
Roads P122/1, P249/1, P39/1, P241/1(D405) and K111, Muldersdrift	
Rehabilitation of Roads P122/1, P249/1, P39/1, P241/1(D405) and K111, Muldersdrift	
Role & Responsibilities:	Assistant Engineer
Completed/Current:	Current Contract Value: Unknown
Trunk Road 32 between Ashton and Swellendam Provincial Government Western Cape	
The Reseal of Trunk Road 32 Section 1 between Ashton and Swellendam, Main Road 283 and Divisional Road 1329	
Role & Responsibilities:	Assistant Engineer
Completed/Current:	2014 Contract Value: R60.8 million
National Route 14 Section 1 between Witputs and Pofadder SANRAL	
Repair and reseal N14 between Witputs and Pofadder	
Role & Responsibilities:	Assistant Engineer
Completed/Current:	2013 Contract Value: R70.3 million
National Route 14 Section 2 between Bladgrond and Kakamas	
Repair and reseal: National route 14 Section 2 between Bladgrond (Km 59.00) and Kakamas 9Km 131.00)	
Role & Responsibilities:	Assistant Engineer
Completed/Current:	2014 Contract Value: R89.1 million

PROJECT EXPERIENCE: CIVIL INFRASTRUCTURE

Sitari, Somerset West	
Civil Engineering Services for Sitari Fields, Somerset West	
Role & Responsibilities:	Assistant Resident Engineer
Completed/Current:	Current Contract Value: R350m
Van der Stel, Stellenbosch	
Upgrading of the Van der Stel Sport Complex parking area	
Role & Responsibilities:	Resident Engineer
Completed/Current:	2012 Contract Value: R700 000



CURRICULUM VITAE

ANNEBET KRIGE

CSP Plant, Upington	
Access to the proposed CSP Plant	
Role & Responsibilities:	Design Engineer
Completed/Current: 2012	Contract Value: Unknown
Droogfontein, Kimberley	
Upgrading of the existing access to the proposed PV Farm, Droogfontein, Kimberley	
Role & Responsibilities:	Design Engineer
Completed/Current: 2012	Contract Value: Unknown
Robben Island	
Repair & Maintenance of Water and Sewerage works on Robben Island	
Role & Responsibilities:	Assistant Resident Engineer
Completed/Current: 2011	Contract Value: R12 million
KFC Observatory	
Civil Engineering Services for KFC, Observatory	
Role & Responsibilities:	Assistant Resident Engineer
Completed/Current: 2010	Contract Value: R300 000
Blue Downs Development	
Upgrading of Roads and Accesses for the Blue Downs Development	
Role & Responsibilities:	Assistant Design Engineer
Completed/Current: 2010	Contract Value: R12 million
Shoprite, Strand	
Construction of Broadway Shoprite Access Road, Strand	
Role & Responsibilities:	Resident Engineer
Completed/Current: 2010	Contract Value: R950 000
Checkers, Burgundy	
Civil Infrastructure for Checkers, Burgundy Estate	
Role & Responsibilities:	Assistant Design Engineer, Assistant Resident Engineer
Completed/Current: 2009	Contract Value: R44 million

Appendix B - Specialist Statement of Independence



environmental affairs

Department:
 Environmental Affairs
 REPUBLIC OF SOUTH AFRICA

DETAILS OF THE SPECIALIST, DECLARATION OF INTEREST AND UNDERTAKING UNDER OATH

File Reference Number:	(For official use only)
NEAS Reference Number:	DEA/EIA/
Date Received:	

Application for authorisation in terms of the National Environmental Management Act, Act No. 107 of 1998, as amended and the Environmental Impact Assessment (EIA) Regulations, 2014, as amended (the Regulations)

PROJECT TITLE

Scoping and Environmental Impact Assessment Processes for the Proposed Development of 12 Solar Photovoltaic (PV) Facilities and associated infrastructure (i.e. Kudu Solar Facility 1 - 12), near De Aar, Northern Cape

Kindly note the following:

1. This form must always be used for applications that must be subjected to Basic Assessment or Scoping & Environmental Impact Reporting where this Department is the Competent Authority.
2. This form is current as of 01 September 2018. It is the responsibility of the Applicant / Environmental Assessment Practitioner (EAP) to ascertain whether subsequent versions of the form have been published or produced by the Competent Authority. The latest available Departmental templates are available at <https://www.environment.gov.za/documents/forms>.
3. A copy of this form containing original signatures must be appended to all Draft and Final Reports submitted to the department for consideration.
4. All documentation delivered to the physical address contained in this form must be delivered during the official Departmental Officer Hours which is visible on the Departmental gate.
5. All EIA related documents (includes application forms, reports or any EIA related submissions) that are faxed; emailed; delivered to Security or placed in the Departmental Tender Box will not be accepted, only hardcopy submissions are accepted.

Departmental Details

Postal address:
 Department of Environmental Affairs
 Attention: Chief Director: Integrated Environmental Authorisations
 Private Bag X447
 Pretoria
 0001

Physical address:
 Department of Environmental Affairs
 Attention: Chief Director: Integrated Environmental Authorisations
 Environment House
 473 Steve Biko Road
 Arcadia

Queries must be directed to the Directorate: Coordination, Strategic Planning and Support at:
 Email: EIAAdmin@environment.gov.za

Details of Specialist Declaration of Interest Under Oath

1. SPECIALIST INFORMATION

Specialist Company Name:	Sturgeon Consulting		
B-BBEE	Contribution level (indicate 1 to 8 or non-compliant)	Non-Compliant	Percentage Procurement recognition
Specialist name:	Annebet Krige		
Specialist Qualifications:	M. Eng (Transportation) – Stellenbosch University 2010 B. Eng (Civil) – Stellenbosch University 2006		
Professional affiliation/registration:	Engineering Council of South Africa (ECSA) Registration Number: 20150161		
Physical address:	7 Waterberg Crescent, Clara Anna Fontein, Durbanville, Cape Town		
Postal address:			
Postal code:	7550	Cell:	084 610 0233
Telephone:		Fax:	
E-mail:	Annebet@sturgeonsa.co.za		

2. DECLARATION BY THE SPECIALIST

I, _____ Annebet Krige _____, declare that –

- I act as the independent specialist in this application;
- I will perform the work relating to the application in an objective manner, even if this results in views and findings that are not favourable to the applicant;
- I declare that there are no circumstances that may compromise my objectivity in performing such work;
- I have expertise in conducting the specialist report relevant to this application, including knowledge of the Act, Regulations and any guidelines that have relevance to the proposed activity;
- I will comply with the Act, Regulations and all other applicable legislation;
- I have no, and will not engage in, conflicting interests in the undertaking of the activity;
- I undertake to disclose to the applicant and the competent authority all material information in my possession that reasonably has or may have the potential of influencing - any decision to be taken with respect to the application by the competent authority; and - the objectivity of any report, plan or document to be prepared by myself for submission to the competent authority;
- all the particulars furnished by me in this form are true and correct; and
- I realise that a false declaration is an offence in terms of regulation 48 and is punishable in terms of section 24F of the Act.



Signature of the Specialist

Sturgeon Consulting
Name of Company:

5 July 2023

Date
Details of Specialist, Declaration and Undertaking Under Oath

3. UNDERTAKING UNDER OATH/ AFFIRMATION

I, _____ Annebet Krige _____, swear under oath / affirm that all the information submitted
or to be submitted for the purposes of this application is true and correct.



Signature of the Specialist

Sturgeon Consulting

Name of Company

5 July 2023

Date



Signature of the Commissioner of Oaths

06 July 2023

Date

.....
 **SABPP™**
SA BOARD FOR
PEOPLE PRACTICES
Setting HR standards

KERRY AUGUST
Commissioner of Oaths
Master HR Professional (MHRP)
Member Number: 53544596
25 Bordeaux Close
Stellenbosch
7600

Appendix C: Site Sensitivity Verification

It is important to note that there are no dedicated traffic or transport related themes on the National Web-based Environmental Screening Tool (Screening Tool), therefore the environmental sensitivity of the proposed project area as identified by the Screening Tool is not applicable. Therefore, no site sensitivity verification report is required. Furthermore, there is no dedicated assessment protocol prescribed for Traffic. Therefore, the specialist assessment has been undertaken in compliance with Appendix 6 of the NEMA EIA Regulations of 2014.

Appendix D: Impact Assessment Methodology

The impact assessment includes:

- *the nature, status, significance and consequences of the impact and risk;*
- *the extent and duration of the impact and risk;*
- *the probability of the impact and risk occurring;*
- *the degree to which impacts and risks can be mitigated;*
- *the degree to which the impacts and risks can be reversed; and*
- *the degree to which the impacts and risks can cause loss of irreplaceable resources.*

Terminology used in impact assessment can overlap. To avoid ambiguity, please note the following clarifications (that are based on NEMA and the EIA Regulations):

- *The term environment is understood to have a broad interpretation that includes both the natural (biophysical) environment and the socio-economic environment. The term socio-ecological system is also used to describe the natural and socio-economic environment and the interactions amongst these components.*
- *Significance = Consequence x Probability, which means that significance is equivalent to risk.*
- *The impact can have a positive or negative status. The significance of a negative impact may be called a risk, and the significance of a positive impact may be called an opportunity.*

The following principles are to underpin the application of this methodology:

- *Transparent and repeatable process - specialists are to describe the thresholds and limits they apply in their assessment, wherever possible.*
- *Adapt parameters to context (where justified) – the methodology proposes some thresholds (e.g. for spatial extent, in Step 3 below), however, if the nature of the impact requires a different definition of the categories of spatial extent, then this can be provided and described.*
- *Combination of a quantitative and qualitative assessment – where possible, specialists are to provide quantitative assessments (e.g. areas of habitat affected, decibels of noise, number of jobs), however, it is recognised that not all impacts can be quantified, and then qualitative assessments are to be provided.*

As per the DFFE Guideline 5: Assessment of Alternatives and Impacts, the following methodology is applied to the prediction and assessment of impacts and risks. Potential impacts and risks have been rated in terms of the direct, indirect and cumulative:

- *Direct impacts are impacts that are caused directly by the activity and generally occur at the same time and at the place of the activity. These impacts are usually associated with the construction, operation or maintenance of an activity and are generally obvious and quantifiable.*
- *Indirect impacts of an activity are indirect or induced changes that may occur as a result of the activity. These types of impacts include all the potential impacts that do not manifest immediately when the activity is undertaken or which occur at a different place as a result of the activity.*
- *Cumulative impacts are impacts that result from the incremental impact of the proposed activity on a common resource when added to the impacts of other past, present or reasonably foreseeable future activities. Cumulative impacts can occur from the collective impacts of individual minor actions over a period of time and can include both direct and indirect impacts.*

The impact assessment methodology includes the aspects described below.

- **Step 1: Nature** of impact/risk - *The type of effect that a proposed activity will have on the environment.*
- **Step 2: Status** - *Whether the impact/risk on the overall environment will be:*
 - *Positive - environment overall will benefit from the impact/risk;*
 - *Negative - environment overall will be adversely affected by the impact/risk; or*
 - *Neutral - environment overall not be affected.*
- **Step 3: Qualitatively** determine the **consequence** of the impact/risk by identifying the **a) SPATIAL EXTENT; b) DURATION; c) REVERSIBILITY; AND d) IRREPLACEABILITY.**
 - **A) Spatial extent** – *The size of the area that will be affected by the impact/risk:*
 - *Site specific;*
 - *Local (<10 km from site);*
 - *Regional (<100 km of site);*
 - *National; or*
 - *International (e.g. Greenhouse Gas emissions or migrant birds).*
 - **B) Duration** – *The timeframe during which the impact/risk will be experienced:*
 - *Very short term (instantaneous);*
 - *Short term (less than 1 year);*
 - *Medium term (1 to 10 years);*
 - *Long term (the impact will cease after the operational life of the activity (i.e. the impact or risk will occur for the project duration)); or*
 - *Permanent (mitigation will not occur in such a way or in such a time span that the impact can be considered transient (i.e. the impact will occur beyond the project decommissioning)).*
 - **C) Reversibility** of the Impacts - *the extent to which the impacts/risks are reversible assuming that the project has reached the end of its life cycle (decommissioning phase):*
 - *High reversibility of impacts (impact is highly reversible at end of project life i.e. this is the most favourable assessment for the environment);*
 - *Moderate reversibility of impacts;*
 - *Low reversibility of impacts; or*
 - *Impacts are non-reversible (impact is permanent, i.e. this is the least favourable assessment for the environment).*
 - **D) Irreplaceability** of Receiving Environment/Resource Loss caused by impacts/risks – *the degree to which the impact causes irreplaceable loss of resources assuming that the project has reached the end of its life cycle (decommissioning phase):*
 - *High irreplaceability of resources (project will destroy unique resources that cannot be replaced, i.e. this is the least favourable assessment for the environment);*
 - *Moderate irreplaceability of resources;*
 - *Low irreplaceability of resources; or*

- *Resources are replaceable (the affected resource is easy to replace/rehabilitate, i.e. this is the most favourable assessment for the environment).*

*Some of the criteria are quantitative (e.g. spatial extent and duration) and some may be described in a quantitative or qualitative manner (e.g. reversibility and irreplaceability). The specialist then combines these criteria in a qualitative manner to determine the **consequence**.*

The consequence terms ranging from slight to extreme must be calibrated per Specialist Study so that there is transparency and consistency in the way a risk/impact is measured. For example, from a biodiversity and ecology perspective, the consequence ratings could be defined according to a reduction in population or occupied area in relation to Species of Conservation Concern (SCC) status, ranging from slight consequence for defined areas of Least Concern, to extreme consequence for defined areas that are Critically Endangered. For example, from a social perspective, a slight consequence could refer to small and manageable impacts, or impacts on small sections of the community; a moderate consequence could refer to impacts which affect the bulk of the local population negatively or may produce a net negative impact on the community; and an extreme consequence could refer to impacts which could result in social or political violence or institutional collapse.

- **Consequence** – *The anticipated consequence of the risk/impact is generally defined as follows:*
 - *Extreme (extreme alteration of natural or socio-economic systems, patterns or processes, i.e. where environmental or socio-economic functions and processes are altered such that they permanently cease);*
 - *Severe (severe alteration of natural or socio-economic systems, patterns or processes, i.e. where environmental or socio-economic functions and processes are altered such that they temporarily or permanently cease);*
 - *Substantial (substantial alteration of natural or socio-economic systems, patterns or processes, i.e. where environmental or socio-economic functions and processes are altered such that they temporarily or permanently cease);*
 - *Moderate (notable alteration of natural or socio-economic systems, patterns or processes, i.e. where the natural or socio-economic environment continues to function but in a modified manner; or*
 - *Slight (negligible and transient alteration of natural or socio-economic systems, patterns or processes, i.e. where natural systems/environmental or socio-economic functions, patterns, or processes are not affected in a measurable manner, or if affected, that effect is transient and the system recovers).*
- **Step 4:** *Rate the **probability** of the impact/risk using the criteria below:*
 - **Probability** – *The probability of the impact/risk occurring:*
 - *Extremely unlikely (little to no chance of occurring);*
 - *Very unlikely (<30% chance of occurring);*
 - *Unlikely (30-50% chance of occurring)*
 - *Likely (51 – 90% chance of occurring); or*
 - *Very Likely (>90% chance of occurring regardless of prevention measures).*

- **Step 5:** Use both the **consequence** and **probability** to determine the **significance** of the identified impact/risk (qualitatively as shown in Figure 1). Significance definitions and rankings are provided below:

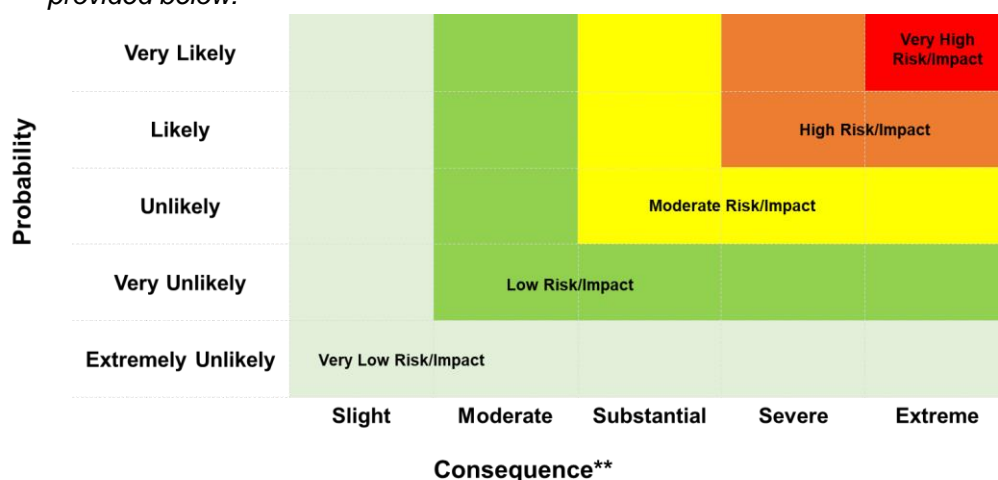

**[Qualitatively determined based on Spatial Extent, Duration, Reversibility and Irreplaceability]

Figure 1. Guide to assessing risk/impact significance as a result of consequence and probability.

- **Significance** – Will the impact cause a notable alteration of the environment?
 - Very low (the risk/impact may result in very minor alterations of the environment and can be easily avoided by implementing appropriate mitigation measures, and will not have an influence on decision-making);
 - Low (the risk/impact may result in minor alterations of the environment and can be easily avoided by implementing appropriate mitigation measures, and will not have an influence on decision-making);
 - Moderate (the risk/impact will result in moderate alteration of the environment and can be reduced or avoided by implementing the appropriate mitigation measures, and will only have an influence on the decision-making if not mitigated);
 - High (the risk/impact will result in major alteration to the environment even with the implementation on the appropriate mitigation measures and will have an influence on decision-making); and
 - Very high (the risk/impact will result in very major alteration to the environment even with the implementation on the appropriate mitigation measures and will have an influence on decision-making (i.e. the project cannot be authorised unless major changes to the engineering design are carried out to reduce the significance rating)).

With the implementation of mitigation measures, the residual impacts/risks are ranked as follows in terms of significance:

- Very low = 5;
- Low = 4;
- Moderate = 3;
- High = 2; and
- Very high = 1.

The specialists must provide a written supporting motivation of the assessment ratings provided.

- **Step 6:** Determine the **Confidence Level** – *The degree of confidence in predictions based on available information and specialist knowledge:*
 - *Low;*
 - *Medium; or*
 - *High.*

Appendix E: Compliance with the Appendix 6 of the 2014 EIA Regulations (as amended)

Requirements of Appendix 6 (Specialist Reports) of Government Notice R326 (Environmental Impact Assessment (EIA) Regulations of 2014, as amended)	Section where this has been addressed in the Specialist Report
1. (1) A specialist report prepared in terms of these Regulations must contain -	Section 14.1.2 and Appendix A and Appendix B of this chapter
a) details of -	
i. the specialist who prepared the report; and	
ii. the expertise of that specialist to compile a specialist report including a curriculum vitae;	Appendix B of this chapter
b) a declaration that the specialist is independent in a form as may be specified by the competent authority;	
c) an indication of the scope of, and the purpose for which, the report was prepared;	Section 14.1.1
(cA) an indication of the quality and age of base data used for the specialist report;	Section 14.2
(cB) a description of existing impacts on the site, cumulative impacts of the proposed development and levels of acceptable change;	Section 14.4 to Section 14.9
d) the duration, date and season of the site investigation and the relevance of the season to the outcome of the assessment;	Section 14.2
e) a description of the methodology adopted in preparing the report or carrying out the specialised process inclusive of equipment and modelling used;	Section 14.1 and Section 14.2
f) details of an assessment of the specific identified sensitivity of the site related to the proposed activity or activities and its associated structures and infrastructure, inclusive of a site plan identifying site alternatives;	Section 14.4
g) an identification of any areas to be avoided, including buffers;	N/A
h) a map superimposing the activity including the associated structures and infrastructure on the environmental sensitivities of the site including areas to be avoided, including buffers;	Section 14.4
i) a description of any assumptions made and any uncertainties or gaps in knowledge;	Section 14.2.2
j) a description of the findings and potential implications of such findings on the impact of the proposed activity or activities;	Section 14.4.4.3
k) any mitigation measures for inclusion in the EMPr;	Section 14.8 and Section 14.9
l) any conditions for inclusion in the environmental authorisation;	Section 14.8 and Section 14.9
m) any monitoring requirements for inclusion in the EMPr or environmental authorisation;	Section 14.8 and Section 14.9
n) a reasoned opinion-	Section 14.13.1 Section 14.13.2
i. whether the proposed activity, activities or portions thereof should be authorised;	
(iA) regarding the acceptability of the proposed activity or activities; and	
ii. if the opinion is that the proposed activity, activities or portions thereof should be authorised, any avoidance, management and mitigation measures that should be included in the EMPr, and where applicable, the closure plan;	
o) a description of any consultation process that was undertaken during the course of preparing the specialist report;	N/A
p) a summary and copies of any comments received during any consultation process and where applicable all responses thereto; and	N/A
q) any other information requested by the competent authority.	N/A
(2) Where a government notice by the Minister provides for any protocol or minimum information requirement to be applied to a specialist report, the requirements as indicated in such notice will apply.	Part A of the Assessment Protocols published in GN 320 on 20 March 2020 is

Requirements of Appendix 6 (Specialist Reports) of Government Notice R326 (Environmental Impact Assessment (EIA) Regulations of 2014, as amended)	Section where this has been addressed in the Specialist Report
	<i>applicable (i.e. Site sensitivity verification requirements where a specialist assessment is required but no specific assessment protocol has been prescribed).</i>



CHAPTER 15:

Battery Energy Storage Systems High Level Risk Assessment



**HIGH LEVEL SAFETY HEALTH AND
ENVIRONMENTAL RISK ASSESSMENT FOR
THE DEVELOPMENT OF A
BATTERY ENERGY STORAGE SYSTEM AT THE
PROPOSED SOLAR PHOTOVOLTAIC FACILITY
(KUDU SOLAR FACILITY 1), DE AAR,
NORTHERN CAPE PROVINCE**

28th May 2023

REPORT:	HIGH LEVEL SAFETY HEALTH AND ENVIRONMENTAL RISK ASSESSMENT FOR THE DEVELOPMENT OF A BATTERY ENERGY STORAGE SYSTEM AT THE PROPOSED SOLAR PHOTOVOLTAIC FACILITY (SOLAR KUDU 1) NEAR DE AAR IN THE NORTHERN CAPE
ASSIGNMENT NO:	J3115M - 1
REPORT DATE:	28 th May 2023
RISK ASSESSOR, REPORT:	Debra Mitchell Telephone: 011 201 4783/5 Email: mitcheld@ishecon.co.za
TECHNICAL SIGNATORY:	Debra Mitchell Telephone: 011 201 4783/5 Mobile phone: 082 428 8844 Email: mitchelld@ishecon.co.za
CLIENT:	CSIR on behalf of ABO Renewable Energies (Pty) Ltd
ENVIRONMENTAL ASSESSMENT PRACTITIONER:	Rohaida Abed on behalf of ABO +27 31 242 2318 rabad@csir.co.za
INSTALLATION REPRESENTATIVE	Du Toit Malherbe and Petrus Scheepers ABO (Pty) Ltd
ADDRESS OF INSTALLATION:	Renosterberg Local Municipality in the Pixley ka Seme District Municipality in the Northern Cape
ADDRESS OF COMPANY:	Unit B1, Mayfair Square, Century Way, Century City, 7441, South Africa



ISHECON cc, H4 Pinelands Office Park, Maxwell Drive, Modderfontein, Box 320 Modderfontein 1645
 Tel: (011) 201 4785/83 Fax: (086) 549 0878 Cell: (082) 428-8844
 Email: mitchelld@ishecon.co.za
 CK 99/29022/23 VAT 4800182422

REPORT ADMINISTRATIVE RECORD

LIST OF ASSESSMENTS

Assessment	Rev. No.	Assessment Date	Description
SHE Risk Assessment	7	28 th April 2023	J3115M - 1 – High-Level Safety Health and Environmental Risk Assessment for the Development of a Battery Energy Storage System At The Proposed Solar Photovoltaic Facility (Solar Kudu 1) Near De Aar In The Northern Cape - Issued By Ishecon

CONTRIBUTORS

The validity, results and conclusions of this assessment are based on the expertise, skills and information provided by the following contributing team members:

NAME	ORGANISATION	DISCIPLINE
Rohaida Abed	CSIR	Environmental Consultant
Du Toit Malherbe and Petrus Scheepers	ABO-Wind	Project Manager

DISCLAIMER

Although every effort has been made by ISHECON to obtain the correct information and to carry out an appropriate, independent, impartial and competent study, it remains the responsibility of the Contractor to ensure suitable Process Safety Measures are in place. ISHECON cannot be held liable for any accident or incident, due to negligence by the owner/operator, which directly or indirectly relates to the plant, equipment, facilities and systems analysed in this document and which may have an effect on the client or any other third party.

CONFIDENTIALITY

ISHECON will keep all information, results and findings confidential, and will not pass these on to other parties without the permission of the Client. However, as an Approved Inspection Authority for Department of Employment and Labour, ISHECON is also under legal obligation to the Department of Employment and Labour to report any obvious violations of the OHS Act.

RISK ASSESSMENT APPROVAL

This report is approved for issue by the undersigned Technical Signatory.

NAME	CAPACITY	REPORT DATE	SIGNATURE
D.C. Mitchell	Risk Assessment, Report preparation, Technical signatory	28 th May 2023	

EXECUTIVE SUMMARY

The applicant, Kudu Solar Facility 1 (Pty) Ltd, is considering a Battery Energy Storage Systems (BESS) to complement a solar power (Kudu 1 Photo-voltaic (PV)) generation facility near the town of De Aar in the Northern Cape.

The BESS system will have a power generation capacity of up to 500 MW and will be able to deliver up to 500 MWh. It is proposed that Lithium Battery Technologies, such as Lithium-Ion Phosphate, Lithium Nickel Manganese Cobalt oxides or Redox flow technology, typically vanadium, will be considered as the possible battery technologies, however, the specific technology will only be determined following Engineering, Procurement and Construction (EPC) procurement. The batteries this would typically be housed within numerous containers although the redox flow type could be house in a single building.

Supplementary infrastructure and equipment may include substations, power cables, transformers, power converters, substation buildings & offices, HV/MV switch gear, inverters and other control equipment that may be positioned within the battery containers / separate dedicated containers / the battery building.

The proposed BESS is subject to an Environmental Impact Assessment (S&EIA) process. In 2019, the Department of Forestry, Fisheries and the Environment (DFFE) requested that EIA applications for BESSs, either on their own or as part of a power generation (e.g., PV or wind) application, should include a high-level Risk Assessment of the BESS considering all applicable risks (e.g., fire, explosion, contamination, end-of life disposal etc).

This report summaries the high-level Safety Health and Environmental Risk Assessment conducted by ISHECON for the proposed Solid-State Lithium (SSL) or Vanadium Redox Flow (VRFB) Battery Energy Storage Systems at the proposed Kudu 1 Solar PV facilities.

1. METHODOLOGY

This assessment of risk comprises:

- Identification of the likely hazards and hazardous events related to the construction, operation and decommissioning of the installation using a checklist approach.
- Estimation of the likelihood/probability of these hazardous events occurring.
- Estimation of the consequences of these hazardous events.
- Estimation of the risk and comparison against certain acceptability criteria.

For the purpose of this high-level Risk Assessment a desktop study of the available information, preliminary layout of the facility and associated BESS alternative locations, reports of related incidents and various literature sources was undertaken. The facility and the project were divided into the sections/phases and using a checklist approach the hazards in each section/phase were identified. Each identified hazard was then analysed in terms of causes, consequences, expected and suggested preventive and mitigative measures to be in place. Each hazard was qualitatively assessed using a qualitative risk ranking system.

2. FINDINGS

In order to highlight the maximum differences between the possible technology types, this study is based on the assumption that redox flow batteries (typically vanadium based chemistry) would most likely be installed within a building using bulk tanks, while solid state batteries (typically lithium based chemistry) would be installed in shipping containers that have hundreds of individual batteries combined into packs. Redox flow batteries can be installed in containers where the individual quantities of electrolyte involved would be smaller.

GENERAL

- This Risk Assessment has found that with suitable preventative and mitigative measures in place, none of the identified potential risks are excessively high, i.e., from a Safety, Health and Environment (SHE) perspective no fatal flaws were found with either type of technology for the proposed BESS installation at the Kudu 1 SEF near De Aar.
- At a large facility, without installation of the state-of-the art battery technology that includes protective features, there can be significant risks to employees and first responders. The latest battery designs include many preventative and mitigative measures to reduce these risks to tolerable levels. (Refer to tables in section 4 under preventative and mitigative measures). Where reasonably practicable, state-of-the-art technology should be used, i.e., not old technology that may have been prone to fire and explosion risks.
- The design should be subject to a full Hazard and Operability Study (HAZOP) prior to commencement of procurement. A HAZOP is a detailed technical systematic study that looks at the intricacies of the design, the control system, the emergency system etc. and how these may fail under abnormal operating conditions. Additional safeguards may be suggested by the team doing the study.

LITHIUM SOLID STATE CONTAINERIZED BATTERIES

- With lithium solid-state batteries, the most significant hazard with battery units is the possibility of thermal runaway and the generation of toxic and flammable gases. There have been numerous such incidents around the world with batteries at all scales and modern technology providers include many preventative and mitigative features in their designs. This type of event also generates heat which may possibly propagate the thermal runaway event to neighbouring batteries if suitable state of the art technology is not employed.
- The flammable gases generated may ignite leading to a fire which accelerates the runaway process and may spread the fire to other parts of the BESS or other equipment located near-by.
- If the flammable gases accumulate within the container before they ignite, they may eventually ignite with explosive force. This type of event is unusual but has happened with an older technology container installed at McMicken in the USA in 2019.
- Due to a variety of causes, thermal runaway could happen at any point during transport to the facility, during construction or operation / maintenance at the facility or during decommissioning and safe making for disposal.
- Due to the containerized approach as well as the usual good practice of separation between containers, which should be applied on this project, and therefore the likely restriction of events to

one container at a time, the main risks are close to the containers i.e., to transport drivers, employees at the facilities and first responders to incidents.

- In terms of a worst conceivable case container fires, the significant impact zone is likely to be limited to within 10m of the container and mild impacts to 20m. Based on the current proposed layouts, impacts at the closest isolated farmhouses are not expected.
- In terms of a worst conceivable case explosion, the significant impact zone is likely to be limited to with 10m of the container and minor impacts such as debris within 50m. Based on the current proposed layouts, impacts at the closest isolated farmhouses are not expected.
- In terms of a worst reasonably conceivable toxic smoke scenario, provided the units are placed suitably far apart to prevent propagation from one unit to another and large external fires are prevented, the amount of material burning should be limited to one container at any one time. In this case, beyond the immediate vicinity of the fire, the concentrations of harmful gases within the smoke should be low. The proposed BESS installation's location should ideally be over 500m from any occupied development / farmhouse. The BESS is well over 500m from the closest facility, and therefore the risks posed by BESS are acceptably low.
- Based on the above it is suggested that if the substation were over 20m from the closest BESS container there should be limited direct impacts of any fire or explosion on the substation. With this separation, fires at the substation are also not likely to lead to domino failures of the BESS.

VANADIUM REDOX FLOW BATTERY INSTALLATIONS

- The most significant hazard with VRFB units is the possibility of spills of corrosive and environmentally toxic electrolyte. Many preventative and mitigative features will be included in the design and operation, e.g., full secondary containment, level control on tanks, leak detection on equipment etc. (Refer to tables in section 4 under preventative and mitigative measures).
- VRFB units do not present significant fire and electrical arcing hazards provided they are correctly designed, operated, maintained and managed. Suitable Battery Management System (BMS), safety procedures, operating instructions, maintenance procedures, trips, alarms and interlocks should be in place. (Refer to tables in section 4 under preventative and mitigative measures).

TECHNOLOGY AND LOCATION OF BESS FACILITIES

- From a safety and health point of view, the above Risk Assessment shows that risks posed by VRFB systems may be slightly lower than those of SSL facilities, particularly with respect to fire and explosion risks. From an environmental spill and pollution point of view the VRFB systems present higher short-term risks than the SSL systems. However, the above conclusions may be due to the fact that the VRFB technology is not as mature as SSL technology and therefore there is not as much operating experience and accident information available for the VRFB. Overall, from and SHE RA points of view, there is no specific preference for a type of technology.
- From a SHE risk assessment point of view, where there is a choice of location that is further from public roads, water courses or isolated farmhouses/occupied developments, this would be preferred. VRFB hazards are mostly related to possible loss of containment of electrolyte and SSL batteries to fires producing toxic smoke and fire fighting which may result in contaminated of firewater runoff. One

would not want these liquids to enter water courses nor the smoke to pass close to houses / public traffic. The current chosen location meets these separation requirements, and the relevant specialists such as aquatic and geohydrology have provided inputs on setback distances.

- Changes to the detailed layouts post Environmental Authorisation (should such be granted) are deemed acceptable if the changes remain within the approved buildable areas / development footprints, and area assessed during this Scoping and EIA Process (with the avoidance of no-go sensitive areas) and any solid state (e.g. lithium) BESS is located over 500m from farm buildings.

3. RECOMMENDATIONS

The following recommendations have been made:

- There are numerous different battery technologies but using one consistent battery technology system for the BESS installations associated with all the Kudu developments in the De Aar area would allow for ease of training, maintenance, emergency response and could significantly reduce risks.
- Where reasonably practicable, state-of-the-art battery technology should be used with all the necessary protective features e.g., draining of cells during shutdown and standby-mode, full BMS with deviation monitoring and trips, leak detection systems.
- There are no fatal flaws associated with the proposed Kudu 1 SEF battery installation for either technology type.
- The tables in Section 4 of this report contains technical and systems suggestions for managing and reducing risks. Ensure the items listed in these tables under preventative and mitigative measures are included in the design.
- The overall design should be subject to a full Hazop prior to finalization of the design.
- For the VRFB systems an end of life (and for possible periodic purging requirements) solution for the large quantities of hazardous electrolyte should be investigated, e.g., can it be returned to the supplier for re-conditioning.
- Prior to bringing any solid-state battery containers into the country, the contractor should ensure that:
 - An Emergency Response Plan is in place that would be applicable for the full route from the ship to the site. This plan would include details of the most appropriate emergency response to fires both while the units are in transit and once they are installed and operating.
 - An End-of-Life plan is in place for the handling, repurposing or disposal of dysfunctional, severely damaged batteries, modules and containers.
- The site layout and spacing between lithium solid-state containers should be such that it mitigates the risk of a fire or explosion event spreading from one container to another.
- Under certain weather conditions, the noxious smoke from a fire in a lithium battery container could travel some distance from the unit. The smoke will most likely be acrid and could cause irritation, coughing, distress etc. Close to the source of the smoke, the concentration of toxic gases may be high enough to cause irreversible harmful effects. Location of the facilities needs to ensure a suitable separation distance from public facilities/residences etc. The proposed BESS location is well over 500m

from isolated farmhouses/development and is therefore suitable in this context.

- In order to limit the possibility of domino failures the BESS should be separated from the substation by at least 20m.
- Where there is a choice of alternative locations for the BESS, those that are further from water courses would be preferred. VRFB hazards are mostly related to possible loss of containment of electrolyte and solid-state systems may experience fires that may result in loss of containment of liquids or the use of large amounts of fire water which could be contaminated. One would not want these run-offs to enter water courses directly. The buffer distance between water bodies and the facilities containing chemicals should be set in consultation with a water specialist and is therefore not specified in this SHE RA. It is noted that there are no tributaries of the main water courses in the area within 500m of the proposed BESS location, and therefore this is not a risk of concern.
- Finally, it is suggested once the BESS technology has been chosen and more details of the final design are available, the necessary updated Risk Assessments should be in place (prior to commencement, after environmental authorisation and other necessary approvals are granted (should such be granted)).

TABLE OF CONTENTS

15.1	INTRODUCTION	10
15.1.1	SCOPE OF ASSESSMENT	10
15.1.2	EIA REGULATION SCOPE OF APPLICATION	10
15.1.3	RISK ASSESSMENT METHODOLOGY	11
15.2.	DESCRIPTIONS	18
15.2.1	ORGANISATION, SITE LOCATION AND SURROUNDING AREAS	18
15.2.1.1	ORGANIZATION	18
15.2.1.2	LOCATION AND PHYSICAL ADDRESS	18
15.2.1.3	DESCRIPTION OF SITE AND SURROUNDINGS	18
15.2.2	TOPOGRAPHY, LAND-USE AND METEOROLOGY	23
15.2.2.1	TOPOGRAPHY	23
15.2.2.2	LAND-USE	23
15.2.2.3	METEOROLOGY	23
15.2.3	PLANT AND PROCESSES	24
15.2.3.1	PROPOSED DESIGN SOLID STATE BATTERIES – TYPICALLY LITHIUM	24
15.2.3.2	PROPOSED DESIGN - REDOX FLOW BATTERIES – TYPICALLY VANADIUM	26
15.2.3.3	STAFF AND SHIFT ARRANGEMENT	28
15.2.3.4	OPERATIONS AT THE BESS FACILITY AND PHASES OF THE BESS PROJECT	29
15.3.	HAZARD IDENTIFICATION	32
15.3.1	SOLID STATE LITHIUM BATTERY CHEMICAL HAZARDS	32
15.3.1.1	BATTERIES IN GENERAL	32
15.3.1.2	LITHIUM BATTERY CHEMISTRY	32
15.3.1.3	HAZARD - THERMAL DECOMPOSITION	32
15.3.1.4	HAZARD - PROPAGATION	33
15.3.1.5	HAZARD - ELECTROLYTE LEAKS	34
15.3.2	VANADIUM REDOX FLOW BATTERY HAZARDS	34
15.3.2.1	BATTERIES IN GENERAL	34
15.3.2.2	VANADIUM BATTERY CHEMISTRY	35
15.3.2.3	HAZARD – TOXICITY AND CORROSIVITY	36
15.3.2.4	HAZARD – ELECTRICAL SHOCK/ARC	37
15.3.2.5	HAZARD – FIRE / DEFLAGRATION	37
15.3.2.6	HAZARD - HYDROGEN GENERATION	37
15.3.2.7	HAZARD – WASTE ELECTROLYTE	38
15.3.2.8	HAZARD - ELECTROLYTE LEAKS	38
15.3.3	OTHER CHEMICALS OR HAZARDS	38
15.3.3.1	COOLING SYSTEMS	39
15.3.3.2	FIRE SUPPRESSION SYSTEMS	39
15.3.3.3	GENERAL ELECTRICAL AND ELECTRONIC EQUIPMENT	39
15.3.4	PAST ACCIDENTS AND INCIDENTS RELEVANT TO BESS	39
15.4.	RISK ASSESSMENT	45
15.4.1	SOLID STATE LITHIUM-ION BATTERY ENERGY STORAGE SYSTEMS	46
15.4.2	VANADIUM REDOX FLOW BATTERY ENERGY STORAGE SYSTEMS	75
15.5.	CONCLUSIONS AND RECOMMENDATIONS	101
15.5.1	CONCLUSIONS	101
15.5.2	RECOMMENDATIONS	103
15.6	REFERENCES	105

GLOSSARY OF SOME TERMS POSSIBLY USED IN THIS REPORT

List of units, acronyms and abbreviations used in this report	Definition
BEI	Biological Exposure Index (Refers to values in blood or urine etc as per to OHS Act)
BESS	Battery Energy Storage System
BMS	Battery Management System
dB	Decibels
DEA	Department of Environmental Affairs
DFFE	Department of Forestry, Fisheries and the Environment
EIA	Environmental Impact Assessment
EMPr	Environmental Management Programme
ERPG	Emergency Response Planning Guideline (a series of values in ppm or mg/m ³ that indicates various levels health effects if exposed to this concentration for more than 60 minutes)
E-stop	Emergency stop button
HAZOP	Hazard and Operability Study
HBA	Hazardous Biological Agents (Refers to pathogens, parasites, cell cultures etc - Refer to the Occupational Health and Safety Act, 1993 (Act No. 83 of 1993) (OHS Act)
HCS	Hazardous Chemical Substances (Refers to a list of hazardous chemicals - Refer to the OHS Act)
HV / MV	High Voltage / Medium Voltage
IDLH	Immediately Dangerous to Life and Health (a value in ppm or mg/m ³ that indicates serious health effects if exposed to this concentration for more than 30 minutes)
kW	Kilowatts
kPa	Kilopascal
m	Metres
m ²	Metres squared
m ³	Metres cubed
NEMA	National Environmental Management Act, 1998 (Act No. 107 of 1998), as amended
NFPA	National Fire Protection Agency
NRT Act	National Road Traffic Act, 1996 (Act No. 93 of 1996) (Chapter 8 deals with transportation of dangerous goods) Note various South African National Standards (SANS) are incorporated into the regulations.
OEL	Occupational Exposure Limit (usually in ppm or mg/m ³ in the air for each HCS as defined in the Hazardous Chemical Substances Regulations of the OHS Act)
OHS Act	Occupational Health and Safety Act, 1993 (Act No. 83 of 1993)
PV	Photovoltaic
RA	Risk Assessment
RQ	Reportable Quantity in terms of NEMA to DFFE
QC / QA	Quality Control or Quality Assurance
SANS	South African National Standards
SDS	Safety Data Sheet
SHE	Safety, Health and Environment
SSLB	Solid State Lithium Batteries
TWA (8 hrs)	Time weighted average of 8 hrs
VRFB	Vanadium redox flow battery
WEF	Wind Energy Facility
WBGT Index	An index in degrees Celsius composed of fractions of the Wet Bulb, Globe and Dry Bulb Temperatures (Refer to Environmental Regulations under the OHS Act)

15.1 INTRODUCTION

15.1.1 SCOPE OF ASSESSMENT

The applicant, Kudu Solar Facility 1 (Pty) Ltd, is considering a Battery Energy Storage System (BESS) to complement a solar power (Kudu 1 Photo-voltaic (PV)) generation facility near the town of De Aar in the Northern Cape.

The BESS system will have a power generation capacity of up to 500 MW and will be able to deliver up to 500 MWh. Two alternative technologies are being considered for the BESS, i.e. either Solid State (typically Lithium chemistry) (SSL) or Redox Flow (typically vanadium chemistry) (VRFB). The technology is advancing rapidly and the exact technology and chemistry will be chosen during the Engineering, Procurement and Construction (EPC) phase. For SSL batteries this would mean multiple containerised units. For VRFB, the systems can be containerized but could, in order to achieve economies of scale, be one large utility scale plant within a conventional industrial type structural steel / brick warehousing structure. In either configuration there could be large volumes of electrolyte on site either in smaller tanks inside containers or larger tanks in a building. The VRFB facilities, either containerized or as utility buildings, will be banded to contain 110% of the largest vessel.

Supplementary infrastructure and equipment may include substations, power cables, transformers, power converters, substation buildings & offices, HV/MV switch gear, inverters and other control equipment that may be positioned within the battery containers / separate dedicated containers / the battery building / within the on-site substation complex (within which the BESS will be positioned).

The proposed BESS is subject to an Environmental Impact Assessment (S&EIA) process. In 2019, the Department of Forestry, Fisheries and the Environment (DFFE) recommended that EIA applications for BESSs, either on their own or as part of a power generation (e.g., PV or wind) application, should include a high-level Risk Assessment of the BESS considering all applicable risks (e.g., fire, explosion, contamination, end-of life disposal etc.).

This report summarizes the high-level Safety Health and Environmental (SHE) Risk Assessment conducted by ISHECON for the proposed SSL or VRFB BESS at the proposed facility. Separate reports have been compiled for each of the 12 proposed Kudu Solar Facilities. This report only addresses Kudu Solar Facility 1 (hereafter referred to as the “Kudu Solar Facility” or “proposed project”).

Although this assessment is based on the best available information and expertise, ISHECON cc cannot be held liable for any incident that may occur on this installation and associated equipment which directly or indirectly relate to the work in this report.

15.1.2 EIA REGULATION SCOPE OF APPLICATION

This Risk Assessment is conducted as a technical input into the EIA process for the proposed project to comply with the requirement for a high-level SHE Assessment, and it does not necessarily comply with the requirements of a specialist study as defined in Appendix 6 of the EIA Regulations of 2014, as amended, under the National Environmental Management Act, 1998 (Act No. 107 of 1998), as amended (NEMA). This was communicated since the Scoping Phase of the proposed project and in the Plan of Study for EIA.

15.1.3 RISK ASSESSMENT METHODOLOGY

This Risk Assessment will consider the technology in detail. However, considering the general risks posed by the technology, each of the possible locations will be assessed with respect to advising on preferred locations from a SHE perspective.

Risk is made up of two components:

- The probability of a certain hazardous event or incident occurring.
- The severity of the consequences of that hazardous event / incident.

Therefore, this assessment of risk comprises:

- Identification of the likely hazards and hazardous events related to the operation of the installation.
- Estimation of the likelihood/probability of these hazardous events occurring.
- Estimation of the consequences of these hazardous events.
- Estimation of the risk and comparison against certain acceptability criteria.

For the purpose of this high-level SHE Risk Assessment a desktop study of the available information, preliminary BESS locations, reports of related incidents and various literature sources was undertaken. Based on this information the facility and the project were divided into construction, operation and decommissioning (end of life) phases.

This study makes use of a qualitative risk ranking system framework¹. The method considers the nature of what causes the effect, what will be affected and how it will be affected, as described below.

NATURE OF IMPACT	DEFINITION
Beneficial / Positive	An impact that is considered to represent an improvement on the baseline or introduces a positive change.
Adverse / Negative	An impact that is considered to represent an adverse change from the baseline, or introduces a new undesirable factor.
Direct	Impacts that arise directly from activities that form an integral part of the Project (e.g., new infrastructure).
Indirect	Impacts that arise indirectly from activities not explicitly forming part of the Project (e.g., noise changes due to changes in road or rail traffic resulting from the operation of Project).
Secondary	Secondary or induced impacts caused by a change in the Project environment (e.g., employment opportunities created by the supply chain requirements).
Cumulative	Impacts are those impacts arising from the combination of multiple impacts from existing projects, the Project and/or future projects.

A Health and Safety Risk Assessment is focussed on hazards arising from the construction, operation and decommissioning of a facility and their impact on humans, either employees or members of the public outside the site. By definition the nature of the chemical and machine hazards is negative, i.e., adverse impact on health and safety. Some of the impacts are immediate and direct such as effects of fires and explosions or exposure to high concentrations of chemicals (in health and safety we refer to these as acute impacts). Other impacts are longer term such as repeated exposure to low concentrations of harmful chemicals, noise etc. (in health and safety we refer to these as chronic impacts).

¹ Adapted from a method developed by WSP to meet the combined requirements of international best practice and NEMA, Environmental Assessment Regulations, 2014, as amended (GN No.326) (the “EIA Regulations”).

Using the checklist detailed in Table 15.1.3.1 the hazards in each section/phase were identified. Each identified hazard was then described by the assessor in terms of causes, consequences, preventive and mitigative measures in place.

Each hazard was qualitatively dimensioned and assessed using the method as per Table 15.1.3.2. There are five dimensioning criteria in this method:

- a) The magnitude of impact on the processes of interest (i.e., human health and safety) e.g., no impact, moderate impact and will alter the operation of the process (e.g., injuries), very high impact and will destroy the process (e.g., fatalities).
- b) The physical extent, e.g., will it be limited to the site or not.
- c) The duration, i.e., how long will the person bear the brunt of the impact.
- d) Reversibility: an impact may either be reversible or irreversible, e.g., fatalities are permanent, while it may be possible to recover from injuries.
- e) The probability of occurrence of the impact.

After dimensioning these aspects, a combined overall risk / significance was calculated for each hazard, see Table 15.1.3.3.

The impact significance without design controls, preventative and mitigation measures will be assessed. Impacts without mitigation measures in place are not representative of the proposed development's actual extent of impact and are included to facilitate understanding of how and why mitigation measures were identified.

The residual impact is what remains following the application of mitigation and management measures and is thus the final level of impact associated with the development.

Residual impacts also serve as the focus of management and monitoring activities during Project implementation to verify that actual impacts are the same as those predicted in this Report.

There are other specialist assessments being carried out as part of the S&EIA process, for example assessments in the field of impacts on terrestrial biodiversity, including fauna and flora, aquatic biodiversity, avifauna etc. The focus of this study is on human health and safety with possible impacts from chemicals, fires, explosions etc. and on broad issues of chemical pollution, emissions and waste of resources.

TABLE 15.1.3.1 SAFETY, HEALTH AND ENVIRONMENTAL RISK ASSESSMENT CHECKLIST

NO	RISKS	DESCRIPTION OF TYPICAL HAZARDS	TYPICAL STANDARD (OHS Act) OR KEY ISSUES
	HEALTH RISKS		
H1	Chronic Chemical or Biological Toxic Exposure	Continuous releases of toxic materials (Chemical or biological) Long term exposure to low concentrations Unsanitary or unhygienic conditions Diseases Harmful animals/insects	Do not exceed Occupational Exposure Limits (OEL's) and Biological Exposure Indices (BEI's – OHS Act Hazardous Chemical Substances (HCS) and Hazardous Biological Agents (HBA) Regulations)) for continuous work time exposure to hazardous chemical substances and materials. Awareness of HBA.
H2	Noise	Continuous and peak exposure to high levels of noise	Continuous noise not to exceed 85dB at workstation (OHS Act Noise-Induced Hearing Loss Regulations) and 61dB at boundary of the site.
H3	Environmental	High temperatures in work areas Low temperatures in work areas High humidity in work areas	Wet Bulb Globe Temperature (WBGT) index above 30 in summer and/or very cold less than 6 deg C in winter (OHS Act Environmental Regulations for Workplaces)
H4	Psychological	Inherently dangerous tasks Monotonous tasks High production pressure	
H5	Ergonomics	Bad ergonomic design, chronic or acute impact Vibration, repetitive impact	Maximum weight to lift 20 – 25kg
	SAFETY RISKS		
S1	Fire	Internal and external fire Small fire Large fires	Upper and lower flammability limits for materials. 12.5 kW/m ² for 1-minute leads to 1% fatalities. 37.5 kW/m ² leads to >90% fatalities and probable structural failure.
S2	Explosion	Internal explosions inside equipment Confined explosion inside structures Unconfined explosions outside	7 kPa overpressure leads to minor structural damage. 70 kPa leads to 90 % fatalities and probable structural failure.
S3	Acute Chemical or Biological Toxic Exposure	Large releases of toxic gases Exposure to high concentrations of harmful materials Asphyxiation inside a vessel Exposure to corrosive materials, burns Ingestion of poisonous materials	Immediately Dangerous to Life and Health values (IDLH) and Emergency Response Planning Guidelines (ERPG's) for all materials. Minimum oxygen levels. Low or high pH.

NO	RISKS	DESCRIPTION OF TYPICAL HAZARDS	TYPICAL STANDARD (OHS Act) OR KEY ISSUES
S4	Acute physical Impact or violent release of energy	Slips and trips Working at heights Moving equipment, objects or personnel	
S5	Generation impact	Electrocution Radiation sources Lasers Static Lightning	
	ENVIRONMENTAL RISKS		
E1	Emissions	Continuous emissions	Exceeding permitted emission levels
E2	Pollution	Unplanned pollution incidents causing immediate damage	Not transporting as per legislation (SANS10228/0229 and Haz. Subs. Act – Road Tanker Regs.) Hazmat requirements Reportable spill quantities NEMA Section 30
E3	Waste of resources	Water Power Other non-renewable resources (minerals) Biodiversity	Exceeding water consumption permits Peak demand requirements
	GENERAL RISKS		
G1	Aesthetics	Tall unsightly structures Glaring glass Odours	
G2	Financial	Risks of litigation Business collapse – recovery after emergency Sustainability	Business continuity Std SANS22301
G3	Security	Theft Hi-jacking Looting	
G4	Emergencies	Emergencies originating off-site (neighbours) Natural disasters	MHI Emergency Response Planning SANS1514
G5	Legal compliance		

TABLE 15.1.3.2 – SHE QUALITATIVE RISK ASSESSMENT MATRIX

a) The magnitude of impact on human health and safety and environmental pollution, quantified on a scale from 0-5, where a score is assigned.

SCORE	DESCRIPTION
0	small and will have no effect on the environment.
1	minor and will not result in an impact on processes.
2	low and will cause a slight impact on processes.
3	moderate and will result in processes continuing but in a modified way.
4	high (processes are altered to the extent that they temporarily cease).
5	very high and results in complete destruction of patterns and permanent cessation of processes.

b) The physical extent.

SCORE	DESCRIPTION
1	the impact will be limited to the site;
2	the impact will be limited to the local area;
3	the impact will be limited to the region;
4	the impact will be national; or
5	the impact will be international.

c) The duration, wherein it is indicated whether the lifetime of the impact will be:

SCORE	DESCRIPTION
1	of a very short duration (0 to 1 years)
2	of a short duration (2 to 5 years)
3	medium term (5–15 years)
4	long term (> 15 years)
5	permanent

d) Reversibility: An impact is either reversible or irreversible. How long before impacts on receptors cease to be evident.

SCORE	DESCRIPTION
1	The impact is immediately reversible.
3	The impact is reversible within 2 years after the cause or stress is removed; or
5	The activity will lead to an impact that is in all practical terms permanent.

e) The probability of occurrence, which describes the likelihood of the impact actually occurring.

SCORE	DESCRIPTION
1	very improbable (probably will not happen).
2	improbable (some possibility, but low likelihood).
3	probable (distinct possibility).
4	highly probable (most likely).
5	definite (impact will occur regardless of any prevention measures).

TABLE 15.1.3.3 – CALCULATION AND INTERPRETATION OF RISK / SIGNIFICANCE

The final assessment of the risk, i.e., the significance, of a particular impact is determined through combination of the characteristics described above (refer formula below)

$$\begin{aligned} \text{Risk} &= \text{Consequence} \times \text{Likelihood} \\ \text{Significance} &= (\text{Extent} + \text{Duration} + \text{Reversibility} + \text{Magnitude}) \times \text{Probability} \end{aligned}$$

The risk (significance) can then be assessed as very low, low, medium, high or very high as follows:

OVERALL SCORE	SIGNIFICANCE RATING (NEGATIVE)	SIGNIFICANCE RATING (POSITIVE)	DESCRIPTION
4-15	Very Low	Very Low	Where the impact is negligible
16-30	Low	Low	Where this impact would not have a direct influence on the decision to develop in the area
31-60	Moderate	Moderate	Where the impact could influence the decision to develop in the area unless it is effectively mitigated
61-80	High	High	Where the impact must have an influence on the decision process to develop in the area
81-100	Very High	Very High	Where the impact would indicate a potential fatal flaw

15.2. DESCRIPTIONS

15.2.1 ORGANISATION, SITE LOCATION AND SURROUNDING AREAS

15.2.1.1 ORGANIZATION

ABO Wind AG is an international company originating in Germany in 1996. The South African subsidiary of ABO Wind, ABO Wind renewable energies (Pty) Ltd, was founded in 2017. There is a local Cape Town Office with local employees working together with the international team. The company is currently working on a pipeline of around 5 GW of wind and solar projects as well as storage projects with batteries or hydrogen. The primary concept of the projects is to ensure social and environmental reliability / sustainability. ABO Wind acts as the project developer and project interface, coordinating the research and studies, the site identification, the project structure, BAs, EIAs, selecting the strategic partners and arranging financing.

15.2.1.2 LOCATION AND PHYSICAL ADDRESS

Kudu 1 Solar PV BESS

Affected properties for the BESS only: Remaining Extent of the Farm Bas Berg No. 88 Renosterberg Local Municipality in the Pixley ka Seme District Municipality in the Northern Cape GPS co-ordinates: 30°14'31.20" S 24°18'13.2" E

15.2.1.3 DESCRIPTION OF SITE AND SURROUNDINGS

The maps below show that the BESS facilities are planned in an isolated location. Activities in the area consist of the low intensity livestock farming.

Figure 15.2.1.1 is a map of South Africa showing the location of the proposed Kudu Solar PV facility.

Figure 15.2.1.2 is the development area showing the location of the BESS facilities.

Figure 15.2.1.3 shows 500m circles (dark blue) around the proposed BESS Facilities as well as local farmsteads/developments with (red 500m circles), nearby water courses/bodies (light blue) and aquatic sensitivity and flood plain areas (green and yellow marked area) in the immediate vicinity of the BESS.

Figure 15.2.1.4 shows the details of the development and the location of the BESS within the substation area

Figure 15.2.1.1 - Map showing the location of the proposed Kudu Solar PV Facility within the Northern Cape, South Africa.



Figure 15.2.1.2 - The general area of interest for the BESS

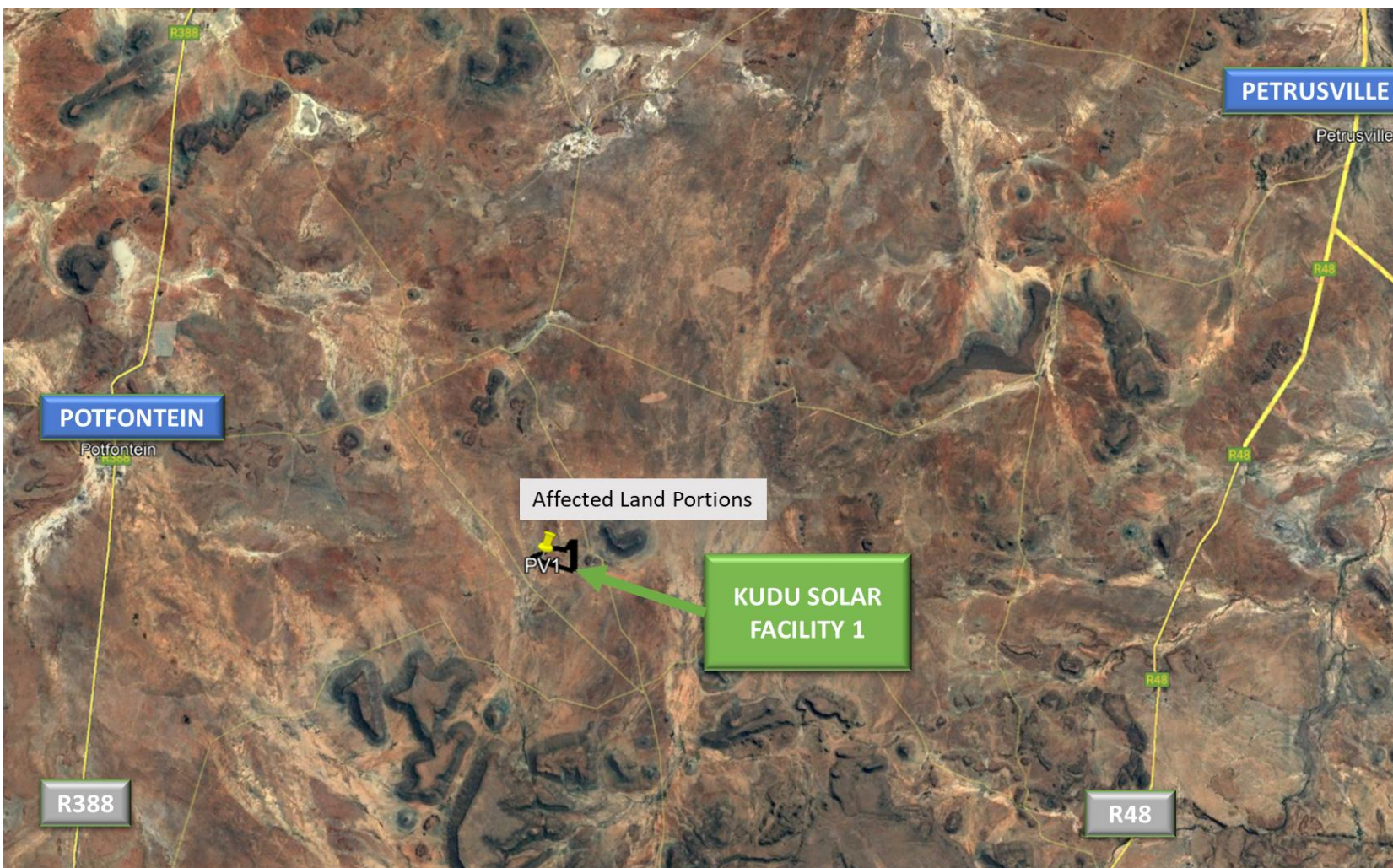

Figure 15.2.1.3 – 500m circles around the BESS Facilities (Dark Blue), Location of Developments / Farmhouses (Red), Nearby Water Courses/Bodies (Light blue) and aquatic sensitivity and floodplain areas (green and yellow) in the immediate vicinity of the BESS

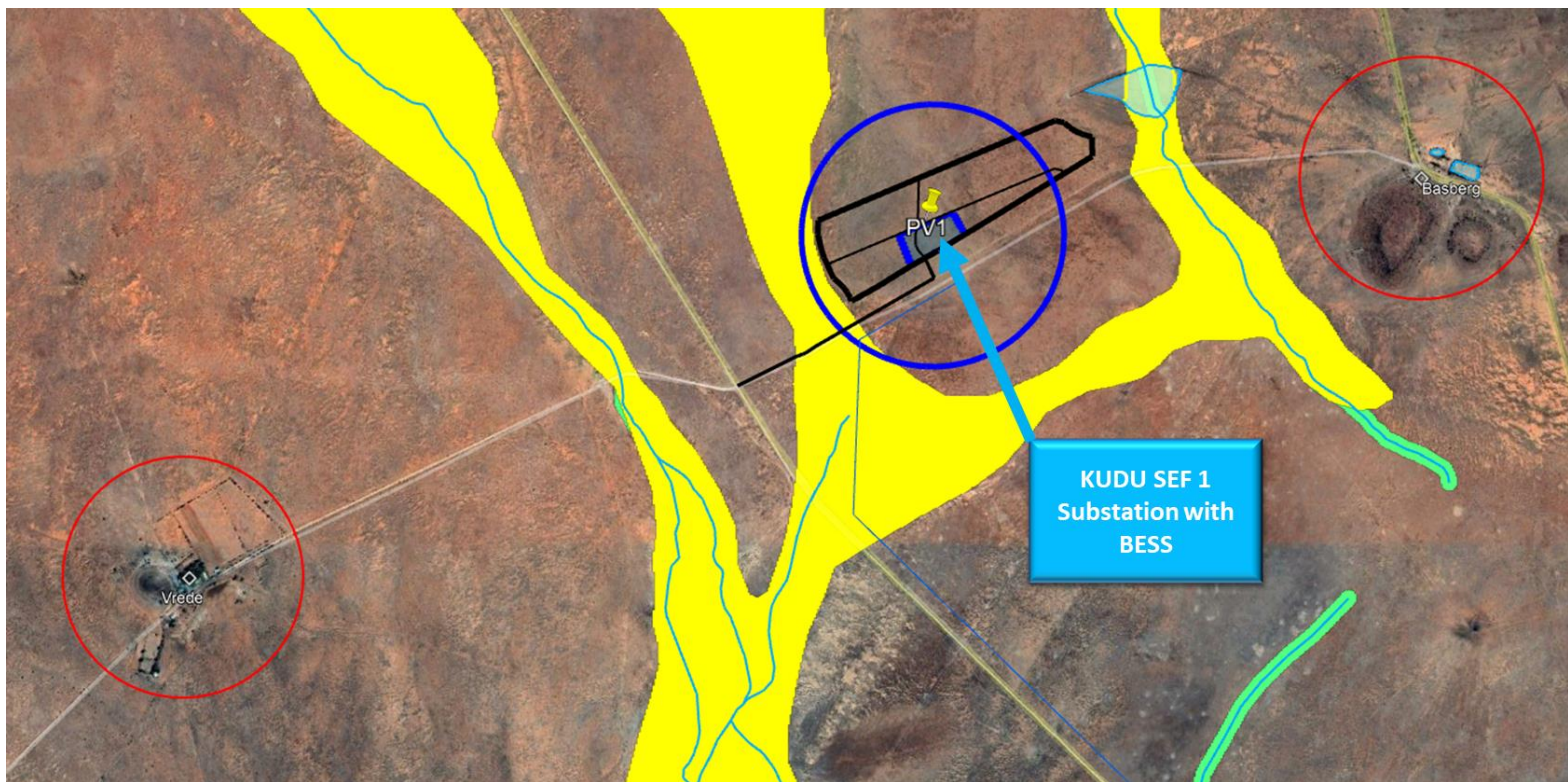

Figure 15.2.1.2 – Detailed layout of the site showing the location of the BESS within the Substation complex



15.2.2 TOPOGRAPHY, LAND-USE AND METEOROLOGY

15.2.2.1 TOPOGRAPHY

Refer to the relevant EIA specialist studies for details of flora and fauna as well as water resources in the area. Vegetation in the area is mostly dry scrub, grass and bushes closer to water courses.

The area is very flat ground with a few hills to the north.

There is a dry (seasonal) river to the west of the BESS site. Due to the semi-arid nature of the area, these water sources, although seasonal, are critical.

15.2.2.2 LAND-USE

Refer to the relevant EIA specialist studies for details of the agricultural and commercial activities and cultural aspects in the area. The BESS facilities will not use large amounts of land typically < 5 ha.

The area is used very sparsely for agricultural activity, mostly livestock. There are few isolated farmstead developments in the general area but none of the dwellings in the area is within 500m of the proposed BESS location.

Across South Africa seismic activity is conceivable with Gauteng (man-made activity) and the Western Cape (natural activity) being relatively higher risk areas. However, compared with aspects such as corrosion, human error etc. seismic activity is not usually a highly likely risk factor, refer to SANS 10160:2011, part 4. [Ref 6]. The proposed area is a low seismic activity area and civil / structural design of the BESS facilities would not normally need to take major additional seismic protection into account. Refer to the Geotechnical Assessment undertaken as part of the EIA Process.

15.2.2.3 METEOROLOGY

Weather data for De Aar indicates that the wind blows predominantly from the north, north west and west. There is very little wind from the east and south. The winds vary from virtually nothing to strong winds in September/October. Given the proposed locations of the BESS facilities this means that the wind blows across the BESS facilities away from any occupied farmsteads.

The area has very little rain but long days with plenty of sunshine and summer daytime temperatures in the mid-thirties. Day night variations are typically 15 degrees Celsius or more.

Across South Africa, lightning strikes are conceivable as a source of ignition of major hazards, refer to SANS10313:2012 lightning strike density table [Ref 7]. The lightning ground flash density in De Aar is 3.3 flashes/km²/year which is at the middle to lower end of the spectrum in South Africa, e.g. Piet Retief is 15.1 and Boksburg as 12.1 although there are lower areas such as Cape Town (i.e. 0.1). Nevertheless, ignition from on-plant sources is much more likely than lightning, but lightning cannot be ignored as a source of risk particularly for tall structures in wide open flat areas.

15.2.3 PLANT AND PROCESSES

15.2.3.1 PROPOSED DESIGN SOLID STATE BATTERIES – TYPICALLY LITHIUM

The one type of battery technology being considered for each BESS is a Solid-State Battery which consists of multiple battery cells that are assembled together to form modules. Each cell contains a positive electrode, a negative electrode and an electrolyte. The BESS will comprise of multiple battery units or modules housed in shipping containers and/or an applicable housing structure which is delivered pre-assembled to the project site. Containers are usually raised slightly off the ground and laid out in rows. They can be stacked if required although this may increase the risk of events in one container spreading to another container. Supplementary infrastructure and equipment may include substations, power cables, transformers, power converters, substation buildings and offices, HV/MV switch gear, inverters and temperature control equipment that may be positioned between, adjacent to or in the vicinity of the battery containers. The solid-state batteries that are being considered are Lithium-ion systems. The pictures in Figure 15.2.3.1.1 are typical BESS installations servicing solar power farms. Figures 15.2.3.1.2 & 15.2.3.1.3 show typical battery modules in the BESS facility.

FIGURE 15.2.3.1.1 – Images of Typical BESS Systems Servicing Solar Power Farms



Source – computer generated artist impressions

FIGURE 15.2.3.1.2 – Typical Battery Modules in a BESS with the Separated Sections

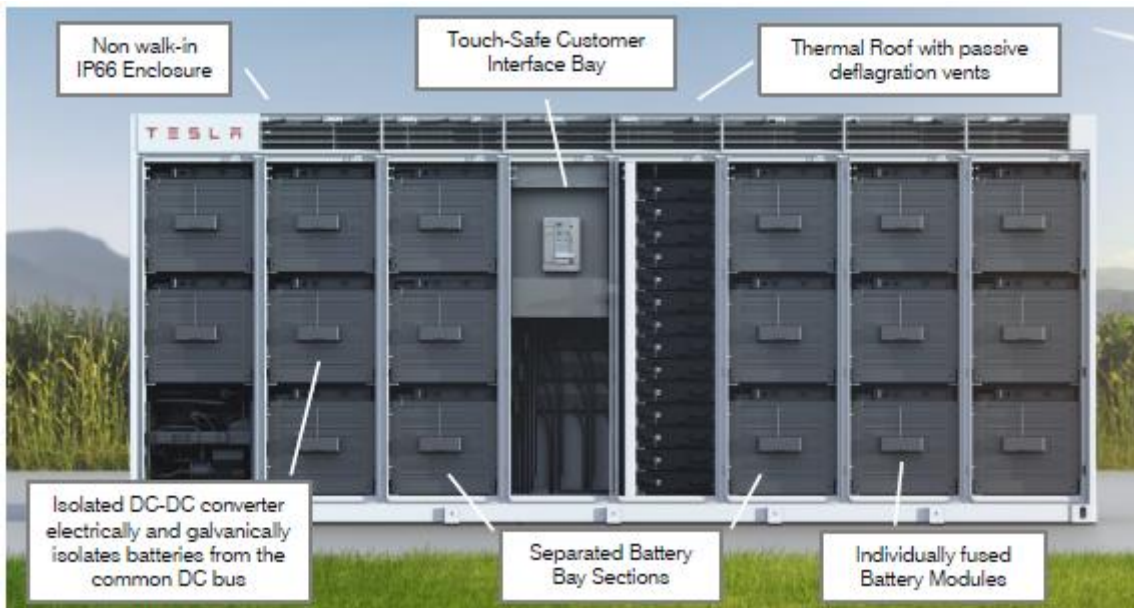

Source – Tesla MegaPack – Safety Overview

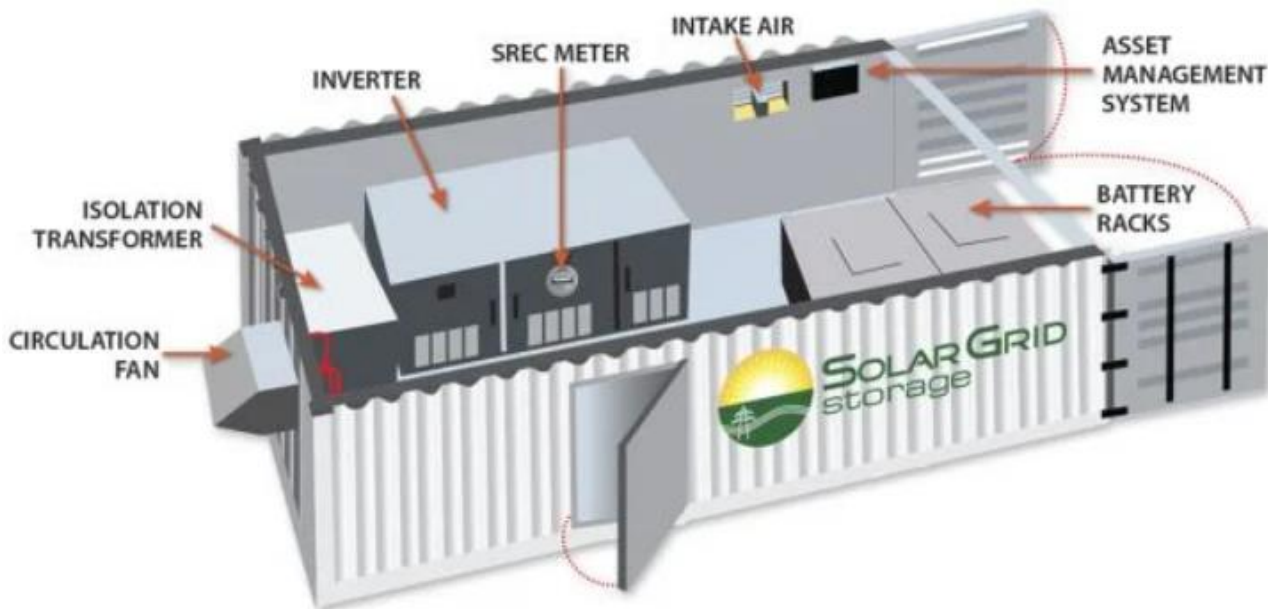

Source – Tesla MegaPack – Safety Overview

FIGURE 15.2.3.1.3 – Typical Battery Modules in a BESS with the Power Conversion Systems in with the Batteries

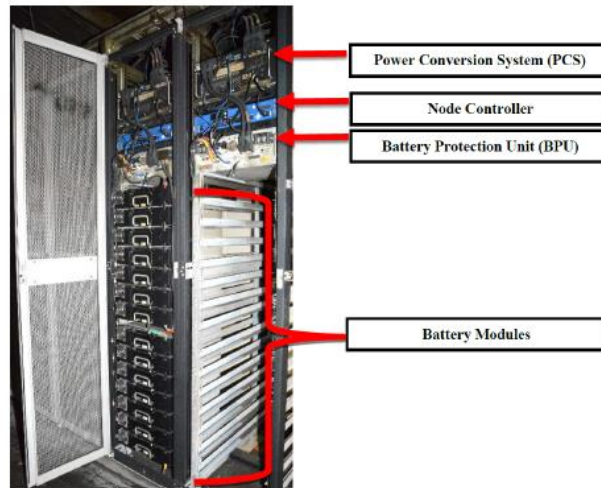

Source – DNV-GL McMicken Event Analysis

15.2.3.2 PROPOSED DESIGN - REDOX FLOW BATTERIES – TYPICALLY VANADIUM

One of the types of battery technology being considered for the BESS would be VRFB. These energy storage systems can be supplied either as containerized units or as a fixed installation within a building etc.

In order to present contrasting hazards with the containerized lithium batteries in the section above, this report will discuss utility scale redox flow system, i.e. not containerized redox flow batteries. Due to the proposed size of the facility (up to 500MW), and in order to highlight the possible more extreme differences between technology types, the facility can be envisioned as having redox units housed within a large battery building. If containerized systems are used, the essential hazards remain the same, but may just be slightly smaller in magnitude. For this project (up to 500 MW) there are expected to be up to 720 containers, each with six 25m³ tanks of electrolyte within the containers, hence approximately 108 000 m³ of electrolyte in the entire project. Each container acts as bund (secondary containment) able to hold at least the volume of one tank. In addition a bund mound/trench (tertiary containment primarily for any runoff) will be constructed around the entire facility. The pictures in Figure 15.2.3.2.1 and Figure 15.2.3.2.2 are typical Redox Flow BESS installations.

FIGURE 15.2.3.2.1 – Images of Some Redox Flow BESS Systems – containerized systems or buildings with tanks of electrolyte and battery systems



1 MW 4 MWh containerized vanadium flow battery owned by Avista Utilities and manufactured by UniEnergy Technologies



Source – Bulk Redox flow batteries for renewable energy storage, 21 Jan 2020, J Noak, N Roznyatovskaya, C Menictas, M Skyllas-Kazacos



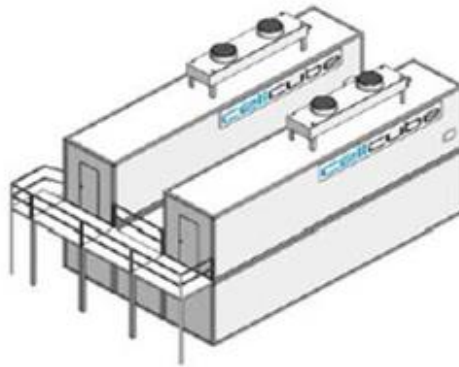

Source – Bushveld Minerals and Energy – Energy Storage and Vanadium Redox Flow batteries 101 – 13 November 2018.
And general Product Info 2023

Within each unit, battery cells are assembled together to form stacks, the image below showing a view of typical stack.

FIGURE 15.2.3.2.2 – Typical Battery Cell and Stack Set-up



Stacks of a 2MW/20MWh vanadium redox flow battery at Fraunhofer ICT. Image:

15.2.3.3 STAFF AND SHIFT ARRANGEMENT

The BESS facilities will run 7 days a week for 24 hours a day. Although the system will be largely automated with a battery management system and electronic operator interface etc, it will still require attention from operators and maintenance staff. The facility will need routine checking / preventative and breakdown maintenance / grass cutting / security etc. During normal operations there are assumed to be approximately 8 persons on site during the day depending on the activities taking place and possibly one or two operators/maintenance staff as well as security personnel at night.

15.2.3.4 OPERATIONS AT THE BESS FACILITY AND PHASES OF THE BESS PROJECT

The BESS facilities can be considered to have three main phases:

- Construction including transport to site and storage prior to installation,
- Operation including commissioning, maintenance, shutdown – restart, and
- Decommissioning including repurposing and disposal.

The main processes undertaken in each of these stages can be summarized as follows together with some details:

TABLE 15.2.3.4.1 – Project Phase with Main Processes/Activities and Some Details of Likely Elements

No	PHASE	MAIN PROCESSES	DETAILS
1.1	Construction both types of battery technology	Construction machines e.g., cranes, graders, cement trucks, diesel and oil storage	Graders to clear ground and make roads, diggers for trenches and foundations, cement mixers for civil works, cranes to place containers, diesel bowser for fuel for machines, oil for machines
1.2		Materials for the construction of the Vanadium Redox Flow Battery (VRFB) building / container plinths Equipment items for installations within the VRFB building	Building materials such as bricks, cement, re-bar, I-beams, roof sheeting etc. BESS equipment such as tanks, pumps, piping etc. Electrical equipment such as transformers, pylons, cabling.
		Equipment items for containerized installation e.g., lithium battery containers / VRFB containers	Battery containers Electrical equipment such as transformers, pylons, cabling.
1.3		Waste e.g., packaging materials, paint	Connections, transformers, switches etc will likely have protective coverings (Plastic, paper, cable ties etc) to remove during installation, paint waste (cans, brushes, solvents), and building rubble
1.4		Construction camp	Temporary offices, accommodation, ablutions
2.1	VRFB Operation	Chemical electrolyte and electrode materials in the battery cell	Tanks, pumps and pipes containing electrolyte, typically vanadium dissolved in an acidic solution.
2.2		Battery cells, stacks	The batteries will be able to generate up to 500 MW of power for four hours. The electrolyte storage will have capacity to dispatch up to 500 MWh.
2.3		Electronic equipment in building / container	Battery management system for monitoring of the batteries and control of the loading and unloading cycles
2.4		Electrical equipment inside	Power conversion system, connections, switches, cabling
2.5		Support mechanical equipment	Air conditioners, fans, coolant
2.6		Electrical equipment outside	Network interconnection equipment, switchgear, transformers
2.7		Site office and workshop	Including potable water, 220V power, kitchen, sewage, tools and parts store etc
2.8		Support services	Dirt roads, access control fences, lights inside the container and outside for general access lighting, fire suppression/fighting systems, grass cutting, communication systems
2.9		Waste	Broken parts, storm water run-off, hot air from battery and Power Conversion System (PCS) cooling systems, waste electrolyte from maintenance or other spills
2.10		Lithium Solid State Operation	Chemical electrolyte and electrode materials in the battery cell
2.11	Battery cells, modules and racks typically in shipping containers		The facilities are designed for up to 500 MW/500 MWh having typically ~ 700 containers. (for example, each Tesla Megapack has up to 3 megawatt hours (MWhs) of storage and 1.5 MW of inverter capacity, other units only have a power rating of just over 0.7 MW per container).
2.12	Electronic equipment in container		Battery management system for monitoring of the batteries and control of the loading and unloading cycles

ENVIRONMENTAL IMPACT ASSESSMENT REPORT: Scoping and Environmental Impact Assessment (EIA) Process for the Proposed Development of a Solar Photovoltaic (PV) Facility (Kudu Solar Facility 1) and associated infrastructure, near De Aar, Northern Cape Province

2.13		Electrical equipment in container or separate container	Power conversion system, connections, switches, cabling
2.14		Mechanical equipment in container(s)	Air conditioners, fans, filters, coolant
2.15		Electrical equipment outside the containers	Network interconnection equipment, switchgear, transformers
2.16		Site office and workshop	Including potable water, 220V power, kitchen, sewage, tools and parts store etc
2.17		Support services	Dirt roads, access control fences, lights inside the container and outside for general access lighting, fire suppression/fighting systems, grass cutting, communication systems
2.18		Waste	Broken parts, storm water run-off, hot air from battery and PCS cooling systems
3.1	Decommissioning both types of battery technology	VRFB Liquid chemical waste	Waste electrolyte solution, transformer oils, coolants
		Solid State Lithium chemical waste	Batteries, air filters, transformer oils, coolants
3.2		Electronic waste	Circuit boards, HMI screens
3.3		Building rubble - non-hazardous waste	Steel, copper, cement, equipment and structures
3.4		VRFB Hazardous waste	Contaminated equipment such as pumps, pipes, bund linings
3.5		Lithium Containers	Shipping containers

15.3. HAZARD IDENTIFICATION

15.3.1 SOLID STATE LITHIUM BATTERY CHEMICAL HAZARDS

15.3.1.1 BATTERIES IN GENERAL

Lithium-ion based battery systems are becoming one of the dominant technologies for utility systems in Europe and America. For this reason, this assessment assumes that lithium-based batteries will be used in the BESS facilities. Should sodium-based batteries be used, the hazards are likely to be similar at a high level but different in their details, and therefore the Risk Assessment may need to be reviewed.

Primary (non-rechargeable) batteries use lithium metal anodes. Lithium is one of the lightest and most reactive metallic elements and is highly reactive towards water and oxygen. Exposure of lithium metal to water even as humidity can decompose exothermically to produce flammable hydrogen gas and heat. These lithium metal batteries are not used in BESS systems. However, if secondary batteries discussed below are charged at temperatures below 0 degrees Celsius, then lithium can plate out onto the anode surface and in this manner lithium metal could be present even in lithium-ion batteries.

Secondary, rechargeable lithium batteries, as used in bulk BESSs, use cathodes that contain lithium in the crystal structure of the cathode coating and/or lithium salts in an electrolyte that is in the battery. These are called lithium-ion batteries. Lithium-ion batteries operate at room temperature and have significant limitations outside the 0 – 50 degree range. The exact lithium-ion composition of the batteries can vary with suppliers. In addition, the technology allows for many combinations of chemistry to suit the particular application.

15.3.1.2 LITHIUM BATTERY CHEMISTRY

The lithium in the batteries is usually in the form of lithium salts dissolved in an electrolyte solution that is absorbed within the electrodes and/or lithium plated onto the surface of the electrode. These are referred to as solid state batteries because electrolyte liquid is not freely available in a form that can easily leak or be extracted. The electrolytes are typically ethylene carbonate or di-ethyl carbonate. The flash points of these carbonates can vary from 18 – 145 deg C which means they can be highly flammable (Flash Point FP < 60 deg C) or merely combustible if involved in an external fire (FP > 60 deg C). Some of the lithium compound in the electrolyte include lithium hexafluorophosphate, lithium perchlorate, lithium cobalt oxide etc.

15.3.1.3 HAZARD - THERMAL DECOMPOSITION

Upon heating of the contents of a battery due to shorting, contaminants, external heat or exposure to water and reaction heat, the lithium salts in batteries begin to break down exothermically to release either oxygen (oxidants) that enhances combustion, possibly leading to explosion, or fumes such as hydrogen fluoride or chlorine that are toxic.

These exothermic break down reactions are self-sustaining above a certain temperature (typically 70 deg C) and can lead to thermal run away. In this process the battery gets hotter and hotter, the decomposition reactions happen faster and faster, and excessive hot fumes are generated in the battery. Eventually the pressure in the battery builds up to the point where those gases need to be vented, usually via the weakest point in the system. These vented fumes can be flammable due to vaporization of the electrolyte and can ignite as a flash fire or fire ball (if large amounts) leading to the fire spreading to any surrounding combustible materials, e.g., plastic insulation on cables, the electrolyte, the electrodes and possibly even the plastic parts of the battery casing etc. If the vented flammable vapours do not ignite immediately, they can accumulate

within the surrounding structures. If this flammable mixture is ignited later, e.g., due to a spark, this can lead to a violent explosion of the module, cabinet, room, container etc.

In addition to being flammable the vented gases will contain toxic components. These could include:

- the products of combustion such as carbon dioxide/monoxide, hydrogen cyanide,
- VOCs like benzene and ethylene, and
- decomposition products such as hydrogen fluoride, hydrogen chloride, phosphorous pentafluoride, phosphoryl fluoride and oxides of aluminium, cobalt, copper etc.

The temperature in the batteries and of these vented gases can be extremely high, e.g., > 600 deg C.

In the situation where oxygen is released internally as part of the decomposition (e.g., lithium perchlorate) the oxygen is available to react with the combustible electrolyte and if all this happens extremely fast in a self-sustaining manner within the confines of the device, an explosion of the device can occur with only localized impacts.

15.3.1.4 HAZARD - PROPAGATION

A BESS is composed of individual batteries which are combined into different size packs such as modules and racks, as illustrated on the diagram below.

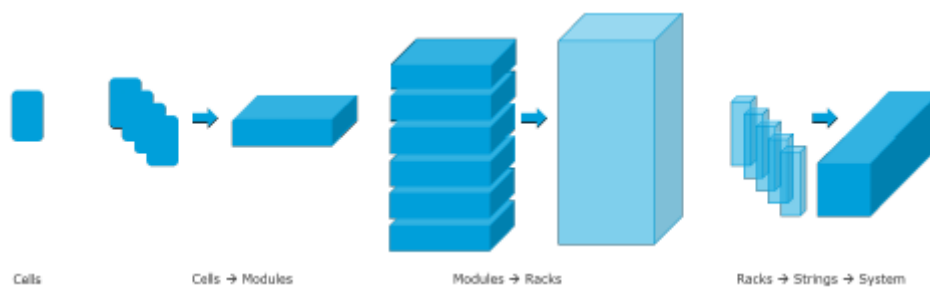

Source DNV-GL McMicken Event Analysis

The very high temperature generated by one battery cell in thermal run away could lead to overheating of adjacent cells. This cell in turn then starts thermal decomposition and so the process propagates through the entire system, as illustrated on the diagram below.

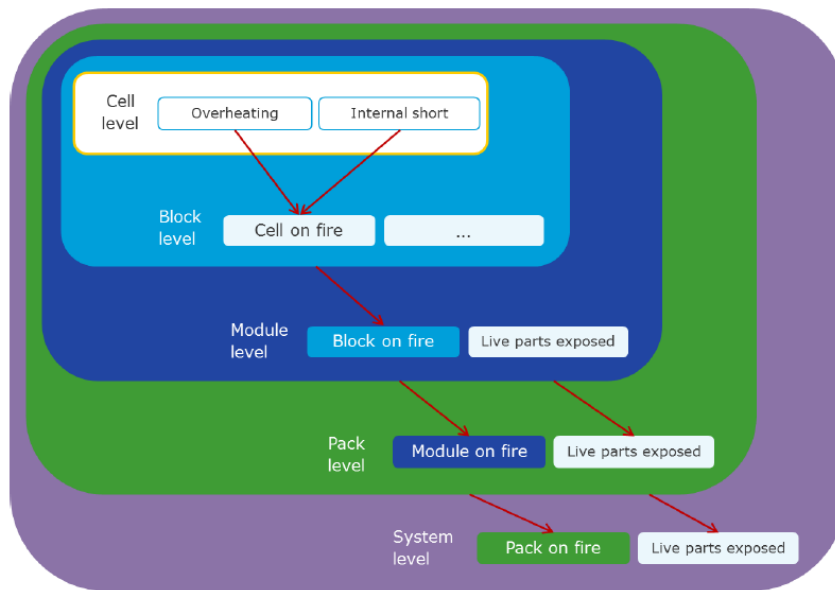

Source – STALLION Report

In order to prevent propagation, there are separation requirements between cells, modules etc. Separation could be with physical space or insulating materials etc.

15.3.1.5 HAZARD - ELECTROLYTE LEAKS

Although extremely unlikely due to the structure of the batteries, should electrolyte liquid leak out of the batteries, it can be potentially flammable as well as corrosive etc. If ignited as fire, or explosion, the smoke would contain toxic components. If unignited it can still be extremely harmful especially if its decomposition products include hydrofluoric acid.

15.3.2 VANADIUM REDOX FLOW BATTERY HAZARDS

15.3.2.1 BATTERIES IN GENERAL

All electrochemical energy storage systems convert electrical energy into chemical energy when charging, and the process is reversed when discharging. With conventional batteries, the conversion and storage take place in closed cells. With redox flow batteries, however, the conversion and storage of energy are separated. Redox flow batteries differ from conventional batteries in that the energy storage material is conveyed by an energy converter. This requires the energy storage material to be in a flowable form. In redox flow batteries, charging and discharging processes can take place in the same cell. Redox flow batteries thus have the distinguishing feature that energy and power can be scaled separately. The power determines the cell size, or the number of cells and the energy is determined by the amount of the energy storage medium. In theory, there is no limit to the amount of energy that can be produced and/or stored thereby allowing for scalability of these systems.

Figure 15.3.2.1 shows the general operating principle of redox flow batteries. The energy conversion takes place in an electrochemical cell which is divided into two half cells. The half cells are separated from each other by an ion-permeable membrane or separator, so that the liquids of the half cells mix as little as possible. The separator ensures a charge balance between positive and negative half cells, ideally without the negative

and positive active materials coming into direct contact with each other. In fact, however, separators are not perfect so some cross-over of the active materials always occurs and this leads to the self-discharge effect.

FIGURE 15.3.2.1 – Schematic Diagrams of Redox Flow BESS Systems

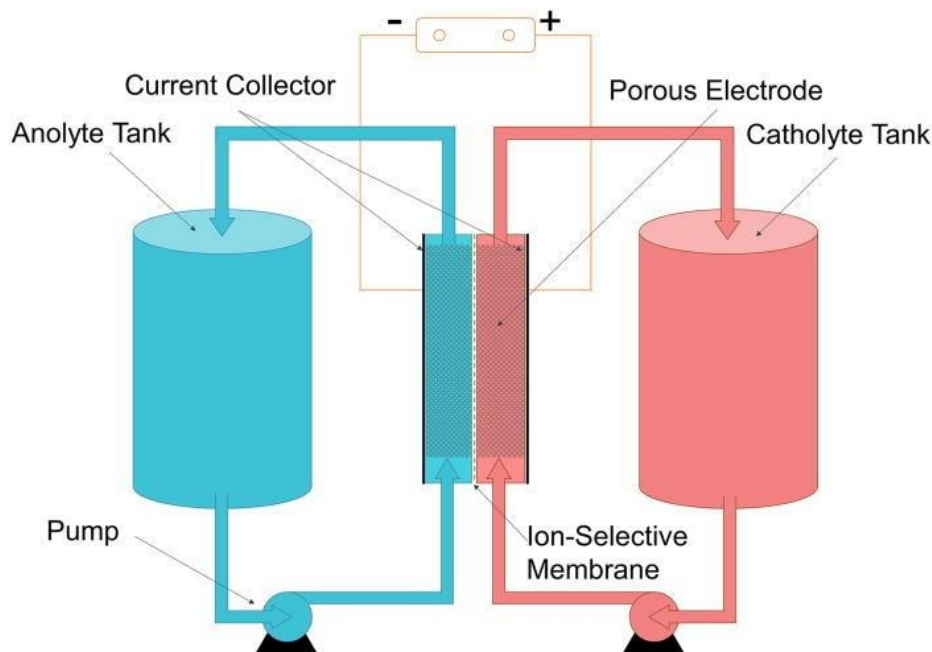

Source – WIKIPEDIA

15.3.2.2 VANADIUM BATTERY CHEMISTRY

The vanadium redox battery (VRB), also known as the vanadium flow battery (VFB) or vanadium redox flow battery (VRFB), is a type of rechargeable flow battery that employs vanadium ions in different oxidation states to store chemical potential energy. The vanadium redox battery exploits the ability of vanadium to exist in solution in four different oxidation states, and uses this property to make a battery that has just one electroactive element instead of two.

The possibility of creating a vanadium flow battery was explored by Pissoort in the 1930s, NASA researchers in the 1970s, and Pellegrini and Spaziant in the 1970s, but none of them were successful in demonstrating the technology. The first successful demonstration of the all-VRFB which employed vanadium in a solution of sulfuric acid in each half was by Maria Skyllas-Kazacos at the University of New South Wales in the 1980s. In redox flow batteries, the electrodes should not participate in the reactions for energy conversion and should not cause any further side reactions (e.g., undesirable gas formation). Most redox flow batteries are therefore based on carbon electrodes.

The redox pair VO_2^+/VO_2 are at the positive electrode and the redox pair V^{2+}/V^{3+} at the negative electrode. The use of the same ions in the positive and negative electrolytes permits relatively high concentrations of active material. It also overcomes the cross-contamination degradation issues which plague other flow type batteries. The energy storage solution consists primarily of vanadium sulphate in a diluted (2mol/L) sulphuric acid (possibly containing a low concentration of phosphoric acid) and is therefore roughly comparable to the acid of lead/acid batteries. The energy density is limited by the concentration of the pentavalent $+VO_2$.

The VRFB is without doubt the best investigated and most installed redox flow battery.

For several reasons, including their relative bulkiness, most vanadium batteries are currently used for grid energy storage, i.e., attached to power plants or electrical grids. Currently, there are over 100 VRFB installations globally with an estimated capacity of over 209,800 kWh of energy and the use of vanadium in energy storage applications has doubled to 2.1% of the global vanadium consumption in 2018.

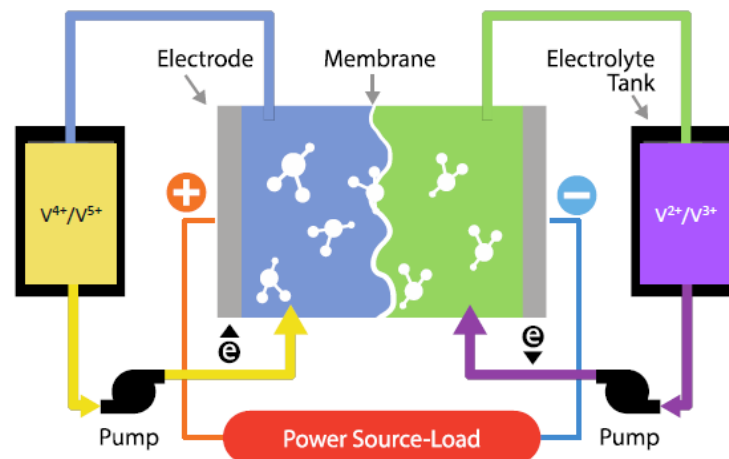

Source: IEEE Spectrum: “It’s Big and Long-Lived, and It Won’t Catch Fire: The Vanadium Redox-Flow Battery”, 26 October 2017

15.3.2.3 HAZARD – TOXICITY AND CORROSIVITY

The electrolyte in the VRFB system is corrosive. It is composed of a sulphuric acid-based solution similar to common automotive lead acid batteries. Unlike traditional lead-acid batteries, VRBs do not include lead. Therefore, VRBs do not have the toxicity issues of lead that conventional car batteries have. The only potential source of human toxicity in a VRB is Vanadium.

Vanadium in various physio-chemical states can have a relatively high aquatic and human toxicity. Acute oral exposure to high doses can lead to haemorrhaging, while chronic exposure leads to adverse effects on the digestive system, kidneys and blood (diarrhoea, cramps etc.).

Inhalation hazards lead to irritation of the respiratory tract, bronchospasm, and pulmonary congestion. There is little evidence that vanadium compounds are reproductive toxics or teratogens. There is also no evidence that it is carcinogenic (Source USA EPA Risk Assessment Information Systems, Toxicity Profiles, Vanadium 1998).

In the electrolyte the concentration levels of Vanadium are so low that when it is mixed into liquid form in the final product and put into operation, the VRB is deemed non-toxic. In addition, VRBs have a lower concentration of sulfuric acid than traditional lead-acid batteries. Vanadium poses a hazard when it is in powder form, i.e. when making up the electrolyte solution. The facilities will purchase the liquid electrolyte solution already made up and there will be no solid vanadium powder on site.

Toxicity or corrosion risks may be present from off-gassing produced by over-heating aqueous or vaporized electrolytes. In addition, flow batteries in fire scenarios may generate toxic gas from the combustion of hydrocarbons, plastics, or acidic electrolytes. Refer to sections on fire below for mitigation measures.

15.3.2.4 HAZARD – ELECTRICAL SHOCK/ARC

Electrical shock presents a risk to workers and emergency responders, if the energy storage system cannot be “turned off”. This is referred to as “stranded energy” and presents unique hazards. Arc flash or blast is possible for systems operating above 100 V.

In the area of shock hazard, a flow battery produces voltage only when electrolytes are in a cell stack. For most designs, if the motors are turned off and fluids drained from the cell stack, then the cell stacks have no measurable voltage at the terminals. This happens not only when the battery is forcibly turned off but also in the standby mode as vanadium batteries do not include any metal plates to hold the chemical reactions / charges / voltages and can be fully drained when not in use.

If not fully drained, vanadium flow batteries are also unique in terms of short circuiting in that the internal dynamics of the battery are such that the energy discharge is limited to the fluid in the battery at any given time and the is typically less than 1% of the total stored energy. Therefore, together with the relatively low energy density of the vanadium electrolyte, the immediate release of energy, which occurs as a result of electrical shorting, is somewhat limited. The high heat capacity of the aqueous electrolyte is also beneficial in limiting the temperature rise.

Vanadium flow batteries have been tested under dead-short conditions resulting in normal operation with no danger to either equipment or personnel.

15.3.2.5 HAZARD – FIRE / DEFLAGRATION

Over 50% of the electrolyte solution is made up of water, which gives the electrolyte a non-flammable property. In the event of short circuiting, intense heat or high pressure, it is unlikely for the battery to catch fire. There is no “thermal runaway” risk when compared to other battery technologies.

Whilst some heat may be discharged from the battery, it will not be at a level that is deemed unsafe.

Like all other RFBs, VRFBs also have a battery management system. A battery management system ensures optimum and safe conditions for battery operation. Often a heat management system is integrated to avoid too high or too low temperatures.

15.3.2.6 HAZARD - HYDROGEN GENERATION

As with all other aqueous batteries, aqueous energy storage media from redox flow batteries are also subject to water limitations. In case of too high voltages or more precisely too high or too low half-cell potentials, the water is decomposed into its components, hydrogen and oxygen.

The generation of hydrogen in particular is often present as a very small but undesirable side reaction and causes a charge carrier imbalance between positive and negative half-cells, which leads to a slow loss of capacity. It also presents a fire / explosion hazard.

With VRFB, due to the flowability of the energy storage medium, the reaction products that would normally remain in the half-cell can be transported out of the cell and stored in separate tanks thus allowing the capability for a higher capacity than that attainable with conventional batteries. In addition, any deviations from safe operating parameters will trigger the shutdown of the system pumps ceasing to charge the electrolyte and thereby reducing the chances of accidental H₂ generation. In addition, the thermal mass of the electrolyte tanks can provide an additional barrier to overcharging conditions by allowing ambient temperature during the discharge times to cool the VRFB for the next charge cycle.

15.3.2.7 HAZARD – WASTE ELECTROLYTE

Unfortunately, pentavalent vanadium ions have a tendency to react with each other, which leads to the formation of larger molecules which precipitate as solids and can thus damage the system. The reaction depends on the temperature and the concentration of VO₂⁺ (state of charge) but is also a function of the proton concentration. Temperature and concentrations therefore need to be controlled within specified ranges.

Should the concentration of undesirable components increase in the electrolyte, a part may need to be purged and replaced with fresh electrolyte. There may be facilities for regenerating purged electrolyte or it may have to be disposed of to a suitable hazardous waste facility.

15.3.2.8 HAZARD - ELECTROLYTE LEAKS

Leaks must be expected in any hazardous-fluid handling equipment. Secondary containment is typically designed into the system and standard corrosive PPE is required for handling liquid. Reliable leak detection, warning alarms, and containment is paramount. As with any chemicals plant, a suitable design with detection, alarm and trip instrumentation that has been subject to thorough Hazard and Operability Study (HAZOP) study should be in place, e.g., detection of dry running of pumps, detection of dead heading of pumps, prevention of reverse flow, detection of drop in tank levels etc.

15.3.3 OTHER CHEMICALS OR HAZARDS

The BESS is composed not only of the batteries, but also electrical connections, switches, power converters, cooling systems etc. The diagram below shows a typical complex system for a lithium solid state facility.

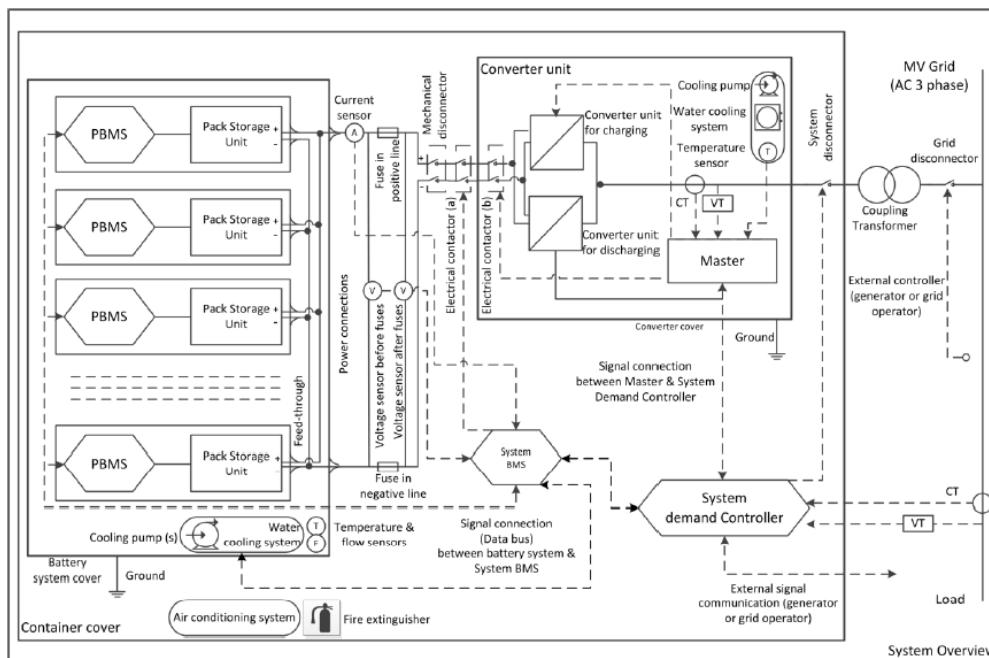

Source – STALLION reports

15.3.3.1 COOLING SYSTEMS

Due to the need to keep the batteries within a specified temperature range most of the containerized modular system have built-in air-conditioning systems while the VRFB building systems may have cooling water systems. Some have only fans for air cooling with filters to remove dust prior to cooling. Others, particularly those in hot environments requiring more cooling, may have refrigerant-based systems. These would have a refrigerant circuit usually containing non-flammable non-toxic refrigerant such as R134a (simple asphyxiant) etc as well as a low hazard circulating medium such as an ethylene glycol-based coolant. At high temperatures above 250 deg C R134 may decompose and may generate hydrogen fluoride and other toxic gases. Ethylene glycol is really only harmful if swallowed. In the environment it breaks down quickly and at low concentrations that would typically occur from occasional small spills, it has no toxicity.

15.3.3.2 FIRE SUPPRESSION SYSTEMS

Although these are only effective for some fire scenarios, some of the solid-state containerized systems come fitted with "Clean agent" fire suppressant systems. These are pressurized containers of powder/gases that are released into the container to snuff a fire and do not leave a residue on the equipment. Some containers have water sprinkler systems installed to quench thermal run-away reactions.

In general fire fighters may respond with water cannons/hydrants, foam systems etc. Such responses may generate large amount of contaminated and hazardous water runoff. A system to contain as much of this as possible should be in place.

15.3.3.3 GENERAL ELECTRICAL AND ELECTRONIC EQUIPMENT

Whatever the configuration of the battery containers/ buildings there will be electrical and electronic equipment in the battery compartment, the battery building as well as outside. In some installations the main electrical equipment such as the power conversion system is in a separate compartment separated by a fire wall. In others it can be in a separate container.

Wherever there is electrical equipment there is a possibility of shorting and overheating and fire.

15.3.4 PAST ACCIDENTS AND INCIDENTS RELEVANT TO BESS

The following events occurred with various types of batteries, e.g., solid state, and are included for the purpose of possible ideas on how things may go wrong with equipment around the batteries themselves:

1. There have been sodium-sulphur fires in Japanese installations. One such event was at the Tsukuba Plant, (Joso City, Ibaraki Prefecture) of Mitsubishi Materials Corporation where molten material leaked from a battery cell causing a short between battery cells in an adjoining block. As there was no fuse between cells the current continued to flow, with the whole battery module catching fire. Hot molten material melted the battery cell casings inside the battery overflowing to the modules below, causing the fire to spread further.
2. There have been exploding, melting Samsung smartphone lithium batteries.
3. A tesla electric battery powered car caught fire, see image below. Initially, a metal object penetrated the battery causing damage leading to short circuiting and thermal runaway. There was an alarm and the driver warned by on-board computer to park car safely and exit. The runaway did not propagate

to the other battery compartment due to separation measures installed. Fire fighters actually made the fire worse by their action to open the battery system to try and get water into it. This allowed air in and the flames to spread to the rest of the car. By way of comparison the American National Fire Protection Agency (NFPA) has stated that there are approximately 90 fires per billion kilometres driven with internal combustion engine cars as compared to the Tesla electric car with only 2 fires per billion driven kilometres.



Source STALLION Report

4. In 2010 a UPS Airlines cargo plane from Dubai crashed after a fire started in a large undeclared lithium battery shipment. Since not declared the batteries were not handled in any special manner as would be required if they were a declared hazardous load. There have been two other fires on flights containing lithium battery cargos. In all cases the fire went from small to uncontrolled in less than 30 minutes.
5. In 2013 the lithium batteries installed in two separate Air Japan Boeing 787 Dreamliners ignited resulting in fires, while on the ground in one case and in-flight in the other.
6. In August 2012, there was a fire at night at the Kahuku wind farm in Hawaii with an advanced lead-acid battery system installed indoors. The fire department were called several hours later and attempted, unsuccessfully to extinguish the fire with dry powder. The fire fighters faced thick smoke and could not enter the building for several hours because it was unclear whether the batteries were emitting toxic fumes.
7. In February 2012 during commission of a solar BESS in Arizona USA a fire started. The cause is unknown but the fire did not spread beyond the shipping container.
8. On 10 August 2016 in Wisconsin USA a fire started in the DC power control compartment of a BESS under construction. Fire department arrived and applied alcohol resistant foam to extinguish the fire. The fire did not spread to the batteries. As the system was in commissioning the fire suppression system in the PCS was not yet functional.
9. On 11 November 2017, a Lithium based BESS in Belgium caught fire during commissioning. Fitted fire detection and extinguishing system failed to contain the fire. The fire department were called and rapidly extinguished the fire preventing spreading to adjacent containers.



A fire engulfs a lithium-ion battery system at an Engie test site in Belgium, Nov. 11.

Photo Credit: MrJoostvanL/ YouTube

10. On 19 April 2019 there was an explosion at utility company Arizona Public Service's (APS) solar battery facility in Surprise, Arizona. The incident on April 19, 2019, started when there were reports at around 17:00 of smoke from the building housing the BESS. A few hours later, at approximately 20:04, an explosion occurred from inside the BESS. Nine people were injured. The factual conclusions reached by the investigation into the incident were:
- The suspected fire was actually an extensive cascading thermal runaway event, initiated by an internal cell failure within one battery cell in the BESS: cell pair 7, module 2, rack 15.
 - It is believed to a reasonable degree of scientific certainty that this internal failure was caused by an internal cell defect, specifically abnormal Lithium metal deposition and dendritic growth within the cell.
 - The total flooding clean agent fire suppression system installed in the BESS operated early in the incident and in accordance with its design. However, clean agent fire suppression systems are designed to extinguish incipient fires in ordinary combustibles. Such systems are not capable of preventing or stopping cascading thermal runaway in a BESS.
 - As a result, thermal runaway cascaded and propagated from cell 7-2 through every cell and module in Rack 15, via heat transfer. This propagation was facilitated by the absence of adequate thermal barrier protections between battery cells, which may have stopped or slowed the propagation of thermal runaway.
 - The uncontrolled cascading of thermal runaway from cell-to-cell and then module-to-module in Rack 15 led to the production of a large quantity of flammable gases within the BESS. Analysis and modelling from experts in this investigation confirmed that these gases were sufficient to create a flammable atmosphere within the BESS container.
 - Approximately three hours after thermal runaway began, the BESS door was opened by firefighters, agitating the remaining flammable gases, and allowing the gases to make contact with a heat source or spark. This led to the explosion.



Arizona utility APS has grounded its energy storage operations while the investigation continues.



Posted Tuesday, April 30, 2019 9:44 am

By Jason Stone & Matt Roy, Independent Newsmedia



Source DNV-GL McMicken Event Analysis

11. Records (By WoodMac) indicate that there are approximately 200 BESS systems in the USA and there have been 2 - 3 fires in the last 5 -10 years. This is an event frequency of 0.001 - 0.003 events per unit per year. DNV-GL in their quantitative risk analysis of BESS sites found that considering all the latest (2019) safety features the theoretical event frequency should be as low as 0.00001 events/unit/year i.e., 2 orders of magnitude lower than the actual values.
12. Korea has installed over 1200 energy storage systems as part of the clean energy programs. In December 2018 a lithium BESS caught fire at a cement plant in Jecheon. It was the 15th fire in 2018 in Korea. As of June 2019, there had been 23 fires at Korean facilities. The faults are reported to be with the incorrect installation of battery management systems, electrical systems and not due to the batteries themselves. Assuming these BESS systems have on average been in place for 5 years then the event frequency is approximately 0.004 events per unit per year. This correlates to the high value estimated for the USA data. This data is also two orders of magnitude higher than the DNV theoretical prediction on 0.00001 events/unit/year.
13. The Electric Power Research Institute (EPRI) of California USA maintains a list of Battery released accidents on its Wiki-Storage Page. The EPRI is an independent non-profit energy research, development and deployment organization that is funded by organizations around the world including the energy sector, academia and governments. The graphs and lists below summarize some of the incidents and the three accidents described in more below the table are typical of the types of accidents recorded.

ENVIRONMENTAL IMPACT ASSESSMENT REPORT: Scoping and Environmental Impact Assessment (EIA) Process for the Proposed Development of a Solar Photovoltaic (PV) Facility (Kudu Solar Facility 1) and associated infrastructure, near De Aar, Northern Cape Province

System Size ■ < 5MWh ■ 5 - 50 MWh ■ 50 MWh < ■ Unknown

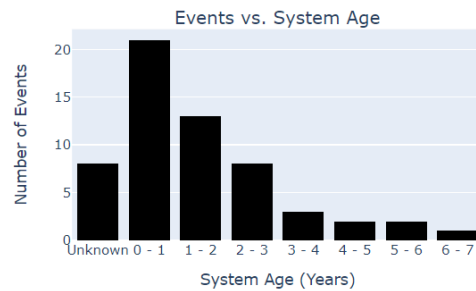
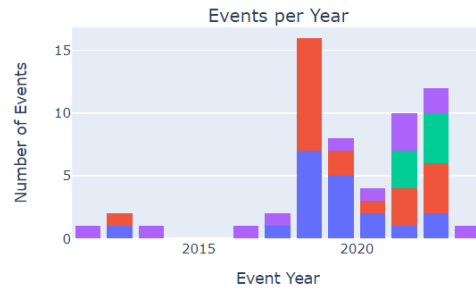
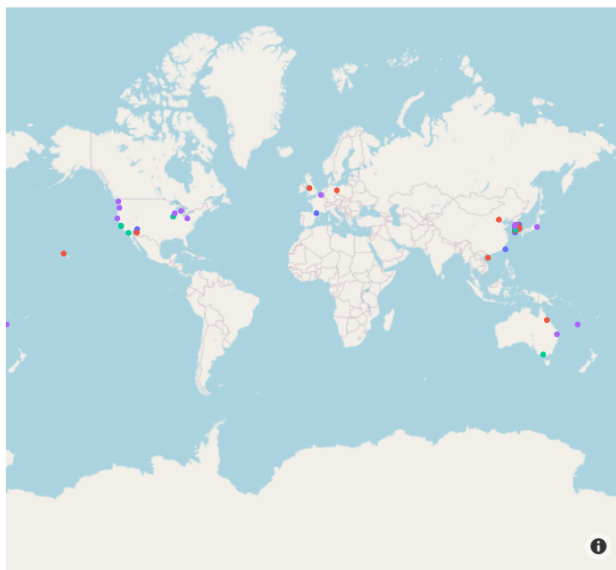

Location	Energy (MWh)	Power (MW)	Application	Installation	Event Date	System Age (yr)	State During Accident	Source	
US, PA, Millvale			Solar Integration	Urban	30 January 2023		Operational	WTAE	
South Korea, Jeollanam-do, Yeongam-gun, Geumjeong-myeon	251		Solar Integration	Rural	27 December 2022	1.8	Operational	E2News.com	
South Korea, Jeollanam-do, Damyang-gun, Mujeong-myeon, Deogok-ri	9.1	2.5	Solar Integration	Rural	8 December 2022	5.5	Operational	E2News.com	
China, Hainan	50	25	Solar Integration		20 October 2022	0	Commissioning	china5e.com	
US, CA, Moss Landing	730	182.5	Energy Shifting, Ancillary Services	Substation	20 September 2022	0.5	Operational	KSBW News	
South Korea, Incheon		103	Energy Shifting	Factory	6 September 2022		Operational	Teller Report	
US, CA, Rio Dell			Solar Integration / Backup	Rural	3 August 2022	4	Operational	KRCR	
US, AZ, Chandler	40	10		Substation	18 April 2022	3	Operational	AZ Central	
US, CA, Valley Center	560	140		Substation	5 April 2022	0.2	Operational	Valley Road Runner	
Longjing, Taichung City, Taiwan	1	1	Solar Integration	Power Plant	30 March 2022	2	Operational	Economic Daily	
US, CA, Moss Landing	400	100	LG Energy Solution	Solar Integration	Power Plant	13 February 2022	1	Operational	KSBW News
South Korea, Gunwi-gun, Gyeongsangbuk-do	1.5	0.45	LG Energy Solution	Solar integration	Rural	17 January 2022	3	Operation. Fully charged	E2News
South Korea, Nam-gu, Ulsan	50	10	SK Innovation	Peak Load Reduction	Urban	12 January 2022	2	Operational	E2News
US, CA, Moss Landing	1,200	300	LG Energy Solution	Solar Integration	Power Plant	4 September 2021	0.8		Vistra
Australia, Victoria, Geelong	450	300	Tesla	Grid Stability	Rural	30 July 2021	0	Construction, Commissioning	ABC News
US, IL, LaSalle	72	72	LFP	Frequency Regulation	Rural	19 July 2021	1.6		The Times
Germany, Neuhausen	5	5	[LFP]	Solar Integration and Frequency Regulation	Indoor/Hangar	18 July 2021	5		RBB 24
Boulouparis, New Caledonia, France				Solar Integration	Rural	13 July 2021			FranceTVInfo.fr
US, MI, Standish				Demand Charge Mgmt	Substation	19 April 2021	0	Installation	WSGW
China, Beijing	25		Gotion High-Tech [LFP]	Solar Integration	Commerce Area	16 April 2021	2	Construction, Commissioning	CTIF Accident Analysis

- a) There have been three incidents at the Moss Landing Power plants PG&E battery storage facility in the USA where there are 256 TESLA Mega Packs installed. The latest involved one pack which caught alight and burned out five hours later. Firefighting approach was to let the pack burn out. Near-by communities were warned to shelter-in-place and the adjacent highway shutdown due to possible toxic smoke. Only one mega pack burned out and the fire did not spread.



- b) There was a small fire at the new Terra-Gen battery storage facility on Valley Centre Road USA. A small electrical failure produced some smoke which triggered the protection systems. Those worked exactly as planned and the failure was contained to a single battery module (meaning literally a single battery which is about the size of a DVD case). The safety systems worked exactly as planned and in addition the enclosure next to the one with the problem shut down because it also detected the smoke.
- c) The fire broke out during testing of a 13-tonne Tesla lithium megapack at the Victorian Big Battery site near Geelong Australia. A 13-tonne lithium battery was engulfed in flames, which then spread to an adjacent battery bank. This event indicates that if the battery pack units are not suitably separated the heat from one fire can set off an adjacent unit.



15.4. RISK ASSESSMENT

An analysis was undertaken to identify the failure events, their causes, consequences, as well as the preventative and mitigative measures in place on the proposed installation for all three phases of a typical project.

15.4.1 SOLID STATE LITHIUM-ION BATTERY ENERGY STORAGE SYSTEMS

TABLE 15.4.1.1 - CONSTRUCTION PHASE (Excluding commissioning which involves starting and testing the installed equipment, i.e. powering up the batteries)

Impact number	Receptor	Description	Stage	Character	Preventative and Mitigative Measures	Ease of Mitigation	Raw Risk						Residual Risk					
							(M+)	E+	R+	(D)x	P=	S	(M+)	E+	R+	(D)x	P=	S
Impact 1:	Human Health - chronic exposure to toxic chemical or biological agents	Causes - Construction materials such as cement, paints, solvents, welding fumes, truck fumes etc. Consequences - Employee / contractor illness.	Construction	Negative	The construction phase will be managed according to all the requirements of the Occupational Health and Safety Act 85 of 1993 specifically the Construction Regulations. SHEQ policy in place. A detailed construction Risk Assessment to be undertaken prior to work. SHE procedure in place. PPE to be specified. SHE appointees in place. Contractor's safety files in place and up to date. All necessary health controls/ practices to be in place, e.g., ventilation of welding and painting areas. SHE monitoring and reporting programs in place. Emergency response plan to be in place prior to beginning construction and to include aspects such as appointment of emergency controller, provision of first aid, first responder contact numbers.	Moderate	3	1	3	4	4	44	1	1	3	4	2	18
Impact 2:	Human Health - exposure to noise	Causes - Drilling, piling, generators, air compressors. Consequences - Adverse impact on hearing of workers. Possible nuisance factor in near-by areas.	Construction	Negative	OHS Act Noise Induced Hearing Loss Regulations. Health Risk Assessment to determine if equipment noise exceeds 85dB at workstation and 61dB at boundary of the site. Employees to be provided with hearing protection if working near equipment that exceeds the noise limits.	Easy	3	1	5	5	4	56	2	1	5	5	2	26

ENVIRONMENTAL IMPACT ASSESSMENT REPORT: Scoping and Environmental Impact Assessment (EIA) Process for the Proposed Development of a Solar Photovoltaic (PV) Facility
(Kudu Solar Facility 1) and associated infrastructure, near De Aar, Northern Cape Province

Impact number	Receptor	Description	Stage	Character	Preventative and Mitigative Measures	Ease of Mitigation	(M+)	E+	R+	D)x	P=	S	(M+)	E+	R+	D)x	P=	S
							Raw Risk						Residual Risk					
Impact 3:	Human Health - exposure to temperature extremes and/or humidity	Causes - Heat during the day. Cold in winter. Consequence - Heat stroke. Hypothermia.	Construction	Negative	Construction site facilities to comply with Occupational Health and Safety Act 85 of 1993, specifically the thermal, humidity, lighting and ventilation requirements of the Environmental Regulations for Workplaces. Adequate potable water for employees to be provided during all phases of the project. Bore hole, bowser and tank or small water treatment plant may be required to provide potable water for the BESS installation staff during all phases of the project. Geohydrology Assessment has been conducted during the EIA Phase to assess the impact of the use of groundwater.	Easy	3	2	3	1	2	18	2	2	3	1	1	8
						Significance	N2 - Low						N1 - Very Low					
Impact 4:	Human Health - exposure to psychological stress	Causes - Large projects bring many contractor workers into a small, isolated community. Consequences – Lack of sufficient accommodation, entertainment etc. Increase in alcohol abuse, violence	Construction	Negative	Refer to the Socio-Economic Specialist Study undertaken as part of the EIA for this project.	Easy	2	3	3	2	2	20	2	3	3	2	2	20
						Significance	N2 – Low						N2 – Low					
Impact 5:	Human Health – exposure to ergonomic stress	Causes – Lifting heavy equipment. Awkward angles during construction. Consequences – Back and other injuries.	Construction	Negative	Training in lifting techniques. Ensure that despite the isolated location all the necessary equipment is available (and well maintained) during construction. Otherwise, employees may revert to unsafe practices. Ensure this is in place prior to project commencement Ensure first aid provision on site.	Moderate	4	1	3	2	3	30	4	1	3	2	2	20
						Significance	N2 - Low						N2 - Low					

ENVIRONMENTAL IMPACT ASSESSMENT REPORT: Scoping and Environmental Impact Assessment (EIA) Process for the Proposed Development of a Solar Photovoltaic (PV) Facility (Kudu Solar Facility 1) and associated infrastructure, near De Aar, Northern Cape Province

Impact number	Receptor	Description	Stage	Character	Preventative and Mitigative Measures	Ease of Mitigation	Raw Risk						Residual Risk					
							(M+	E+	R+	D)x	P=	S	(M+	E+	R+	D)x	P=	S
Impact 6a:	Human and Equipment Safety - exposure to fire radiation	Causes – Involvement in an external fire. Fire involving fuels used in construction vehicles or vehicles themselves (e.g., tyre fire). Fire due to uncontrolled welding or other hot-work Consequences - Injuries due to radiation especially amongst first responders and bystanders. Fatalities unlikely from the heat radiation as not highly flammable nor massive fire.	Construction	Negative	Fuels stored on site in dedicated, demarcated and bunded areas. Suitable fire-fighting equipment on site near source of fuel, e.g., diesel tank, generators, mess, workshops etc. The company responsible for the facility at this stage is to have: 1. Emergency plan to be in place prior to commencement of construction. 2. Fuel spill containment procedures and equipment to be in place. 3. Hot-work permit and management system to be in place.	Complex	4	2	3	5	4	56	4	2	3	5	2	28
							Significance						N3 - Moderate					

ENVIRONMENTAL IMPACT ASSESSMENT REPORT: Scoping and Environmental Impact Assessment (EIA) Process for the Proposed Development of a Solar Photovoltaic (PV) Facility (Kudu Solar Facility 1) and associated infrastructure, near De Aar, Northern Cape Province

Impact number	Receptor	Description	Stage	Character	Preventative and Mitigative Measures	Ease of Mitigation	Raw Risk						Residual Risk					
							(M+	E+	R+	D)x	P=	S	(M+	E+	R+	D)x	P=	S
Impact 6b:	Human and Equipment Safety - exposure to fire radiation	<p>Causes - Solid state battery containers damaged on route e.g., dropped in port (drops do happen about 1/2000 containers) and importing possibly up to 700 containers for the site. With this it is possible, although unlikely, that one will be dropped, traffic accident on-route. Involvement in an external fire e.g., at the port or on route. Data indicates installed facility events are 0.001/year. Transport of 700 units per installation assumed to take 4 weeks each so f= 0.05 - once in 20 years so likelihood is moderate.</p> <p>Consequences – Injuries due to radiation especially amongst first responders and bystanders. Fatalities unlikely from the heat radiation as not highly flammable nor massive fire (refer to noxious smoke in</p>	Construction	Negative	<p>Solid state battery design includes abuse tests such as drop test, impact, rapid discharge etc. Propagation tests for systems, e.g., heat insulating materials between cells/modules. Factory acceptance test prior to prior to leaving manufacture. Batteries are usually stored at 50% charge to prolong life but may be shipped fully discharged. This level of detail should be understood so as to assess the risk during transport and storage.</p> <p>The company responsible for the battery installation should ensure suitably competent transport companies are appointed. The company responsible for transportation should ensure:</p> <ul style="list-style-type: none"> - Compliance with National Road Traffic Act regulation 8 – dangerous goods. - Port Authorities should be alerted to the overall project and the hazardous nature of the contents of battery containers being imported. Note. If, as per one of the typical suppliers (Tesla) indications, the containers are classified as IMDG Class 9 – the containers will not receive any special care in the ports and may be stored next to flammables. Port emergency response in particular need training on mitigating battery hazards. <p>Prior to bringing any containers into the country, the company responsible for the battery installation (possibly via appointed contractors) should ensure that an Emergency response plan is in place for the full route from the ship to the site. Drivers trained in the hazards of containerized batteries.</p> <p>The Emergency response plan must determine and address:</p> <ul style="list-style-type: none"> - What gases would be released in a fire and are there inhalation hazards. - Extinguishing has two important elements, put out fire and to provide cooling. Different approaches may be needed for small fire – e.g., put out, and for large fires e.g., cool with copious quantities of water. Note inert gases and foam may put out the initial fire but fail to control thermal runaway or to cool the batteries 	Complex	5	2	5	5	4	68	5	2	5	5	1	17

ENVIRONMENTAL IMPACT ASSESSMENT REPORT: Scoping and Environmental Impact Assessment (EIA) Process for the Proposed Development of a Solar Photovoltaic (PV) Facility (Kudu Solar Facility 1) and associated infrastructure, near De Aar, Northern Cape Province

Impact number	Receptor	Description	Stage	Character	Preventative and Mitigative Measures	Ease of Mitigation	(M+	E+	R+	D)x	P=	S	(M+	E+	R+	D)x	P=	S
							Raw Risk						Residual Risk					
		APPENDIX A below for the major impact).			resulting in reignition. - What initial fire extinguishing medium should be used. - Whether there are any secondary gases or residues from use of extinguishers. - If water is appropriate, determine if the system needs outside connections to sprinklers inside the container. - First responders need to know what media to use, especially if water totally unsuitable and if there are no connection points for water etc. - Must the container be left unopened or opened. - PPE to be specified including possible exposure to chemicals and fumes as well as radiate heat. - Containment of residues/water/damaged equipment. - Suitable safe making and disposal plan for after the event i.e. how do responders deal with partially charged damage units, contaminated surfaces (e.g., HF residues).													
						Significance	N4 - High						N2 - Low					
Impact 7:	Human and Equipment Safety - exposure to explosion over pressures	Causes - With solid state lithium containers, flammable gases generated by thermal run away reach explosive limits. Ignition on hot surfaces, static. Consequences - Potential fatalities amongst first responders. Damage to container, transport truck or other nearby items, e.g., other container in the port.	Construction	Negative	During transport this is only likely to happen due to possible inappropriate emergency response, e.g., opening containers when they may be the type that should be left to burn out. For simplicity one transport route would be preferable. The route needs to be assessed in terms of responding local services, rest places for drivers, refuelling if required, break down services available etc. Once an import route has been chosen, e.g., N10 from Port of Ngqura, then the appointed transport company should ensure key emergency services on route could be given awareness training in battery fire/accident response. Emergency response planning and training referred to above may be important for key locations such as the mountain passes / tunnels.	N/A	5	4	5	5	3	57	5	4	5	5	1	19
						Significance	N3 - Moderate						N2 - Low					

ENVIRONMENTAL IMPACT ASSESSMENT REPORT: Scoping and Environmental Impact Assessment (EIA) Process for the Proposed Development of a Solar Photovoltaic (PV) Facility
(Kudu Solar Facility 1) and associated infrastructure, near De Aar, Northern Cape Province

Impact number	Receptor	Description	Stage	Character	Preventative and Mitigative Measures	Ease of Mitigation	(M+)	E+	R+	(D)x	P=	S	(M+)	E+	R+	(D)x	P=	S
							Raw Risk						Residual Risk					
Impact 8a:	Human and Equipment Safety - exposure to acute toxic chemical and biological agents	Causes Human pathogens and diseases, sewage, food waste. Snakes, insects, wild and domesticated animals and harmful plants. Consequences - Illness and at worst without mitigation, possibly extending to fatalities. Effects can vary from discomfort to fatalities for venomous snakes or bee swarms etc.	Construction	Negative	All necessary good hygiene practices to be in place, e.g., provision of sanitation facilities, eating areas, infectious disease controls. Policies and practice for dealing with known vectors of disease such as AIDS, TB, COVID 19 and others. Awareness training for persons on site, safety induction to include animal hazards. First aid and emergency response to consider the necessary anti-venom, anti-histamines, topical medicines etc. Due to isolated locations some distance from town, the ability to treat with anti-venom and extreme allergic reactions on site is critical to mitigate the impacts.	Complex	4	2	3	2	3	33	3	2	3	2	2	20
Significance							N3 - Moderate						N2 - Low					
Impact 8b:	Human and Equipment Safety - exposure to acute toxic chemical and biological agents	Causes - Damaged solid-state batteries release fumes, leak electrolyte, are completely broken exposing hazardous chemicals. Thermal runaway and hazardous fumes released. Consequences - Impacts can vary from mild skin irritation from exposure to small leaks to serious corrosive burns or lung damage.	Construction	Negative	Appointed transport company to ensure transport in accordance with Regulation 8 of the National Road Traffic Act 93 of 1996, Dangerous Goods. Not permitted to transport prescribed goods in manner not consistent with the prescriptions, e.g., consignor and consignee responsibilities. Prescription found in SANS 10228/29 and international codes for battery transport etc. Transportation of BESS components in sealed packages that are kept upright, protected from movement damage etc. Also packaged to ensure no short-circuiting during transport. Transport to prevent excessive vibration considerations as battery internal components may be damaged leading to thermal run-away during commissioning. Pre-assembled containers will most likely be supplied. These will be fitted with the necessary protective measures by the supplier considering marine and road transport as well as lifting, setting down etc.	Complex	4	3	3	5	3	45	4	3	3	5	2	30

ENVIRONMENTAL IMPACT ASSESSMENT REPORT: Scoping and Environmental Impact Assessment (EIA) Process for the Proposed Development of a Solar Photovoltaic (PV) Facility (Kudu Solar Facility 1) and associated infrastructure, near De Aar, Northern Cape Province

Impact number	Receptor	Description	Stage	Character	Preventative and Mitigative Measures	Ease of Mitigation	(M+)	E+	R+	(D)x	P=	S	(M+)	E+	R+	(D)x	P=	S
							Raw Risk						Residual Risk					
					Route selection to consider possible incidents along the way and suitable response, e.g., satellite tracking, mobile communication, 24/7 helpline response. Standard dangerous goods requirements for Hazmat labels, Transport Emergency Data i.e. Trem cards, driver trained in the hazards of the load. Likelihood similar to fire above.													
						Significance	N3 - Moderate						N2 - Low					
Impact 9:	Human and Equipment Safety - exposure to violent release of kinetic or potential energy	Causes - Construction moving equipment, heavy loaded, elevated loads, working at heights Consequences - Injury or possibly fatality. Damage to equipment. Delays in starting the project, financial losses	Construction	Negative	The construction phase will be managed according to all the requirements of the Occupational Health and Safety Act 85 of 1993 specifically the Construction Regulations. SHEQ policy in place. A detailed construction Risk Assessment to be undertaken prior to work. SHE procedure in place. PPE to be specified. SHE appointees in place. Contractors safety files in place and up to date. SHE monitoring and reporting programs in place. Standard construction site rules regarding traffic, reversing sirens, rigging controls, cordoning off excavations etc. Civil and building structures to comply with the National Building Regulations and building Standards Act 103 of 1977, SANS 10400 and other relevant codes. Other constructions such as roads, sewers etc also to comply with relevant SANS standards. All normal procedures for working at heights, hot work permits, confined space entry, cordon off excavations etc to be in place before construction begins. Emergency response plan to be in place before construction begins.	Complex	5	1	5	5	4	64	5	1	5	5	1	16
							N4 - High						N2 - Low					

ENVIRONMENTAL IMPACT ASSESSMENT REPORT: Scoping and Environmental Impact Assessment (EIA) Process for the Proposed Development of a Solar Photovoltaic (PV) Facility (Kudu Solar Facility 1) and associated infrastructure, near De Aar, Northern Cape Province

Impact number	Receptor	Description	Stage	Character	Preventative and Mitigative Measures	Ease of Mitigation	(M+)	E+	R+	(D)x	P=	S	(M+)	E+	R+	(D)x	P=	S
							Raw Risk						Residual Risk					
Impact 10:	Human and Equipment Safety - exposure to electromagnetic waves	Causes - Use of electrical machines, generators etc. Hot dry area static generation is highly likely. Lightning strike. Consequences - Electrocutation. Ignition and burns. Injury and death. Damage to electrical equipment.	Construction	Negative	Standard maintenance of condition of electrical equipment and safe operating instructions. Ability to shut off power to systems in use on site. If persons are decanting fuels or dealing with other highly flammable materials care should be taken regarding possible static discharge, and installations to be suitably designed and maintained. Lightning strike rate in the study area is moderately low. Outside work must be stopped during thunderstorms. Lighting conductors may be required for the final installation, to be confirmed during design phase.	Complex	5	2	5	5	3	51	5	2	5	5	1	17
							Significance						N3 - Moderate					
Impact 11:	Environment - emissions to air	Causes - Dust from construction and generally hot dry area. Consequences - Adverse impact on employee health.	Construction	Negative	May need to use dampening on roads etc. as per normal construction practices. May need PPE (dust masks) for specific construction workers.	Easy	3	2	1	1	4	28	2	2	1	1	2	12
							Significance						N2 - Low					
Impact 12:	Environment - emissions to water	Causes - Diesel for equipment, paints and solvents. Transformer oil spills. Sewage and kitchen/mess area wastewater. Consequences - Environmental damage, particularly to the surface and underground water in the area.	Construction	Negative	Normal construction site practices for preventing and containing fuels/paint/oil etc spills. Bunding under any temporary tanks, curbing under truck offloading areas and sealed surfaces (e.g., concrete) under truck parking area is particularly important. Spill clean-up procedures to be in place before commencing construction. Sewage and any kitchen liquids - containment and suitable treatment/disposal	Moderate	2	2	3	2	3	27	2	2	3	2	2	18
							Significance						N2 - Low					

ENVIRONMENTAL IMPACT ASSESSMENT REPORT: Scoping and Environmental Impact Assessment (EIA) Process for the Proposed Development of a Solar Photovoltaic (PV) Facility
(Kudu Solar Facility 1) and associated infrastructure, near De Aar, Northern Cape Province

Impact number	Receptor	Description	Stage	Character	Preventative and Mitigative Measures	Ease of Mitigation	(M+)	E+	R+	D)x	P=	S	(M+)	E+	R+	D)x	P=	S
							Raw Risk						Residual Risk					
Impact 13:	Environment - emissions to earth	Causes - Mess area and other solid waste. Consequences - Environmental damage.	Construction	Negative	There will be packaging materials that will need to be disposed of after the entire system is connected and commissioned as well as after regular maintenance. There will need to be waste segregation (e.g., electronic equipment, chemicals) and management on the site.	Easy	2	2	3	3	3	30	1	2	3	3	2	18
						Significance	N2 - Low						N2 - Low					
Impact 14:	Environment - waste of resources e.g., water, power etc	Causes - Water usage not controlled. Battery containers damaged. Consequences - Delays.	Construction	Negative	Water usage to be monitored on site during construction. Handling protocols to be provided by battery supplier. End of Life plan needs to be in place before any battery containers enter the country as there may be damaged battery unit from day 1. Water management plan and spill containment plans to be in place.	Easy	1	1	1	2	4	20	1	1	1	2	2	10
							N2 - Low						N1 - Very Low					
Impact 15:	Public - Aesthetics	Causes - Bright surfaces reflecting light. Tall structures in a flat area. Consequences - Irritation.	Construction	Negative	Refer to the visual impact assessment undertaken as part of the EIA.	Moderate	2	2	3	3	3	30	2	2	3	3	3	30
						Significance	N2 - Low						N2 - Low					
Impact 16:	Investors - Financial	Causes - Defective technology. Extreme project delays. Consequences - Financial loss	Construction	Negative	Design by experienced contractors using internationally recognized and proven technology. Project management with deviation monitoring.	Moderate	5	1	3	4	3	39	3	1	3	4	2	22
						Significance	N3 - Moderate						N2 - Low					

ENVIRONMENTAL IMPACT ASSESSMENT REPORT: Scoping and Environmental Impact Assessment (EIA) Process for the Proposed Development of a Solar Photovoltaic (PV) Facility
(Kudu Solar Facility 1) and associated infrastructure, near De Aar, Northern Cape Province

Impact number	Receptor	Description	Stage	Character	Preventative and Mitigative Measures	Ease of Mitigation	(M+)	E+	R+	(D)x	P=	S	(M+)	E+	R+	(D)x	P=	S
							Raw Risk						Residual Risk					
Impact 17:	Employees and investors - Security	Causes - On route, potential hi-jacking of valuable but hazardous load. On site, theft of construction equipment and battery installation facilities. Civil unrest or violent strike by employees. Consequences - Theft. Injury to burglars. Damage to equipment possibly setting off thermal runaway.	Construction	Negative	Fencing around electrical infrastructure to SANS standard and Eskom Guidelines. The hazardous nature of the electrical and battery equipment should be clearly indicated – e.g., Skull and Cross Bones or other signs. Isolated location both helps and hinders security. Night lighting to be provided both indoors and outdoors where necessary.	Complex	4	1	3	2	4	40	3	1	3	2	3	27
Significance							N3 - Moderate						N2 - Low					
Impact 18:	Emergencies	Causes - Fires, explosions, toxic smoke, large spills, traffic accidents, equipment/structural collapse. Inadequate emergency response to small event leads to escalation. Consequences - Injuries turn to fatalities, small losses become extended down time.	Construction	Negative	All safety measures listed above. Emergency procedures need to be practiced prior to commencement of construction. If batteries are stored at 50% charge, thermal run away can happen while in storage on site waiting for installation. In addition, if involved in an external fire thermal run away can happen even with uncharged batteries. Except during shipping, ideally the units should not be stored any closer to each other than they would be in the final installation so that propagation is prevented, i.e. laydown area needs to be considered. The company in charge of the containers at each stage in the transport process needs to be very clear so that responsibility for the integrity of the load and protection of the persons involved in transfer and coordination of emergency response on-route. E.g., if purchased from Tesla where does hand over occur to the South African contractor / owner, at the factory door in USA, at the port in RSA, at the site fence. For example, who will be accountable if there's thermal	Complex	4	2	3	5	4	56	4	2	3	5	2	28

ENVIRONMENTAL IMPACT ASSESSMENT REPORT: Scoping and Environmental Impact Assessment (EIA) Process for the Proposed Development of a Solar Photovoltaic (PV) Facility (Kudu Solar Facility 1) and associated infrastructure, near De Aar, Northern Cape Province

Impact number	Receptor	Description	Stage	Character	Preventative and Mitigative Measures	Ease of Mitigation	(M+)	E+	R+	D)x	P=	S	(M+)	E+	R+	D)x	P=	S	
							Raw Risk						Residual Risk						
					runway event on a truck with a container that stops in a small town for driver refreshments.														
						Significance	N3 - Moderate						N2 - Low						
Impact 19:	Investors - Legal	Causes - Battery field is evolving quickly with new guides, codes and regulations happening at the same time as evolving technology. Consequences - Unknown hazards manifest due to using "cheaper supplier or less developed technology".	Construction	Negative	Use only internationally reputable battery suppliers who comply with all known regulations/guideline at the time of purchasing. Where reasonably practicable ensure only "state of the art" battery systems are used and not old technologies prone to fires/explosions etc.	Moderate	3	1	3	3	4	40	2	1	3	3	2	18	
						Significance	N3 - Moderate						N2 - Low						

The above Risk Assessment shows that provided the preventative and mitigative measures are incorporated, the construction phase of the project does not present any high risks nor any fatal flaws. The average raw risk significance is rated as moderate, and the average residual risk is rated as low.

TABLE 15.4.1.2 - OPERATIONAL PHASE (Including Commissioning – i.e. initial testing of the systems and first powerup of batteries)

From the details of accidents that have happened both with BESS installations and chemical plants in general, it is clear that many potential problems manifest during the commissioning phase when units are first powered up to test functionality. This phase is critical and all controls, procedures, mitigation measures etc that would be in place for full operation should be in place before commissioning commences.

Impact number	Receptor	Description	Stage	Character	Preventative and Mitigative Measures	Ease of Mitigation	(M+	E+	R+	D)x	P=	S	(M+	E+	R+	D)x	P=	S
						Raw Risk						Residual Risk						
Impact 1a:	Human Health - chronic exposure to toxic chemical or biological agents	Causes - Operation and maintenance materials spare parts, paints, solvents, welding fumes, transformers oils, lubricating oils and greases etc. Consequences - Occupational illness.	Operation	Negative	<p>The operation and maintenance phase will be managed according to all the requirements of the Occupational Health and Safety Act 85 of 1993. SHEQ policy in place.</p> <p>A detailed Risk Assessment of all normal operating and maintenance activities on site to be compiled, and form the basis of operating instructions, prior to commencing commissioning.</p> <p>SHE procedure in place, e.g., PPE specified, management of change, integrity monitoring. SHE appointees in place.</p> <p>Training of staff in general hazards on site.</p> <p>All necessary health controls/ practices to be in place, e.g., ventilation of confined areas, occupational health monitoring if required and reporting programs in place.</p> <p>Emergency response plan for full operation and maintenance phase to be in place prior to beginning commissioning and to include aspects such as:</p> <ul style="list-style-type: none"> - appointment of emergency controller, - emergency isolation systems for electricity, - emergency isolation and containment systems for electrolyte, - provision of PPE for hazardous materials response, - provision of emergency facilities for staff at the main office building, - provision of first aid facilities, - first responder contact numbers etc. 	Easy	2	1	3	4	5	50	1	1	3	4	2	18
						Significance	N3 - Moderate						N2 - Low					

ENVIRONMENTAL IMPACT ASSESSMENT REPORT: Scoping and Environmental Impact Assessment (EIA) Process for the Proposed Development of a Solar Photovoltaic (PV) Facility
(Kudu Solar Facility 1) and associated infrastructure, near De Aar, Northern Cape Province

Impact number	Receptor	Description	Stage	Character	Preventative and Mitigative Measures	Ease of Mitigation	Raw Risk						Residual Risk					
							(M+)	E+	R+	D)x	P=	S	(M+)	E+	R+	D)x	P=	S
Impact 1b:	Human Health - chronic exposure to toxic chemical or biological agents	Causes - Compromised battery compartments vapours accumulate in the containers, solids/liquids on surfaces. Maintenance of battery components, corrosive and mildly toxic liquid on surfaces. Consequences - Dermatitis, skin /eye/lung irritation.	Operation	Negative	Solid state batteries sealed, individual batteries in modules which are also sealed, pre-packed in the container. Maintenance procedures will be in place should equipment need to be opened, e.g., pumps drained and decontaminated prior to repair in workshop etc. PPE will be specified for handling battery parts and other equipment on site. Training of staff in hazards of chemicals on site. Possible detectors with local alarms if regulated occupational exposure limits are exceeded etc prior to entry for inspection of battery containers. Labelling of all equipment. Confined space entry procedures if entering tanks. There needs to be careful thought given to procedures to be adopted before entering into the BESS or a container particularly after a Battery management System (BMS) shut down where there may be flammable or toxic gases present, a fire etc. Safety Data Sheets (SDSs) to be available on site. Operating manuals to be provided including start-up, shut-down, steady state, monitoring requirements. Maintenance manuals with make safe, decontamination and repair procedures. Proposed maintenance schedules e.g., checklists for weekly, monthly, annual etc. Provided portable equipment for calibration and for testing/verification of defective equipment, e.g., volt/current meters, infrared camera	Complex	3	1	3	5	4	48	1	1	3	5	2	20
Impact 2:	Human Health - exposure to noise	Causes - Moving parts inside containers, buildings, pumps, compressors, cooling systems etc. Consequences - Adverse impact on hearing of workers. Nuisance factor at	Operation	Negative	Design to ensure continuous noise does not exceed 85dB within the facilities or at any other location on site or 61 dB at the site boundary, e.g., emergency generator, air compressor etc. Employees to be provided with hearing protection if working near equipment that exceeds the noise limits.	Easy	2	1	5	5	4	52	2	1	5	5	2	26

ENVIRONMENTAL IMPACT ASSESSMENT REPORT: Scoping and Environmental Impact Assessment (EIA) Process for the Proposed Development of a Solar Photovoltaic (PV) Facility
(Kudu Solar Facility 1) and associated infrastructure, near De Aar, Northern Cape Province

Impact number	Receptor	Description	Stage	Character	Preventative and Mitigative Measures	Ease of Mitigation	Raw Risk						Residual Risk						
							(M+	E+	R+	D)x	P=	S	(M+	E+	R+	D)x	P=	S	
		near-by residences or other activities.																	
Significance							N3 - Moderate						N2 - Low						
Impact 3:	Human Health - exposure to temperature extremes and/or humidity	Causes - Heat during the day. Batteries generate heat within enclosed building / containers. Cold in winter. Night work requires lighting. Consequences - Heat stroke. Hypothermia.	Operation	Negative	Building and container facilities to comply with Occupational Health and Safety Act 85 of 1993 specifically the thermal, humidity, lighting and ventilation requirements of the Environmental Regulations for Workplaces. Ensure containers are temperature controlled as required to remain within the optimal battery operating temperature range. Lighting to be provided inside any buildings, inside the containers, possibly linked to the door opening and outdoors where necessary. Adequate potable water to be provided during all phases of the project. Suitable lighting to be provided including emergency lighting for safe building exit in the event of power failure. PPE for operations and maintenance staff to be suitable for the weather conditions.	Easy	4	2	3	1	2	20	3	2	3	1	1	9	
Significance							N2 - Low						N1 - Very Low						
Impact 4:	Human Health - exposure to psychological stress	Causes - Isolated workstation and monotonous repetitive work. Consequences - Low performance, system productivity suffers.	Operation	Negative	Staff rotation to other activities within the site may be necessary. Performance monitoring of inspections / maintenance tasks in particular will be necessary.	Easy	2	3	3	2	2	20	1	3	3	2	1	9	
Significance							N2 - Low						N1 - Very Low						

ENVIRONMENTAL IMPACT ASSESSMENT REPORT: Scoping and Environmental Impact Assessment (EIA) Process for the Proposed Development of a Solar Photovoltaic (PV) Facility (Kudu Solar Facility 1) and associated infrastructure, near De Aar, Northern Cape Province

Impact number	Receptor	Description	Stage	Character	Preventative and Mitigative Measures	Ease of Mitigation	Raw Risk						Residual Risk					
							(M+	E+	R+	D)x	P=	S	(M+	E+	R+	D)x	P=	S
Impact 5:	Human Health - exposure to ergonomic stress	Causes - Lifting heavy equipment. Awkward angles during maintenance, stretching reaching to high level and bending to low level. Working at height if equipment located on top of roofs or elevated electrical equipment (e.g., pylons). Consequences - Back and other injuries.	Operation	Negative	Training in lifting techniques. Training in working at heights. If equipment is at height (see OHS Act General Safety Regulation 6), ensure suitable safe (electrically and physically) ladders / harnesses etc. are available. Working at height procedure to be in place.	Easy	5	1	3	2	3	33	4	1	3	2	2	20
							Significance						N3 - Moderate					

ENVIRONMENTAL IMPACT ASSESSMENT REPORT: Scoping and Environmental Impact Assessment (EIA) Process for the Proposed Development of a Solar Photovoltaic (PV) Facility
(Kudu Solar Facility 1) and associated infrastructure, near De Aar, Northern Cape Province

Impact number	Receptor	Description	Stage	Character	Preventative and Mitigative Measures	Ease of Mitigation	Raw Risk						Residual Risk					
							(M+	E+	R+	D)x	P=	S	(M+	E+	R+	D)x	P=	S
Impact 6a:	Human and Equipment Safety - exposure to fire radiation	Causes – Involvement in an external fire e.g., veld fire, maintenance vehicle fire, electrical systems fire. Manufacturing defects or damage to battery leading to shorting and heating. High humidity condensation of water or ingress of water or flooding leading to shorting. Dust accumulation on electrical parts leading to overheating. Excessive electrical loads - surges Operator abuse BMS failure or software failure. Incorrect extinguishing medium, escalate the fire. Consequences - Contaminated run off. Radiation burns unlikely to be severe as no highly flammable materials on site. Damaged equipment. Fire spreads to other units or offsite if	Operation	Negative	Grass cutting and fire breaks around the BESS installations to prevent veld fires. No combustible materials to be stored in or near the batteries or electrical infrastructure. Separation of site diesel tank, transformers from BESS and vice versa. Suggested minimum separation from substation is 20m. There are BESS design codes from the USA and standards of practice that can be used e.g., UL9540, NFPA 855 and DNV GL RP 43. Detailed Failure Modes and Effect Analysis (FMEA)/Hazop/Bowtie to be done during design at the component level and system levels. Safety integrity level rating of equipment (failure probably) with suitable redundancy if required. Site Acceptance Testing as part of commissioning of each unit and the overall system. Abuse tests conducted by supplier. BMS should be checking individual cell voltage as well as stack, module, container, system voltages/current etc. BMS tripping the cell and possibly the stack/building unit or module/rack/container, if variations in voltage. Diagnostics easily accessible. Diagnostics able to distinguish cell from stack or cell from module faults. Protective systems are only as good as their reliability and functionality testing is important, e.g., testing that all battery trips actually work. Fire resistant barrier between the batteries and the PCS side if in the same container, or separate containers. Suitable ingress protection level provided for electrical equipment, e.g., IP55 - 66. If air cooling into container, suitable dust filters to be provided. Smoke detectors linked to BMS & alerts in control room. Effects of battery aging to be considered. Solid state battery life starts to be impacted above 40 deg C and significant impacts above 50 deg C with thermal runaway starting at 65-70 deg C. BMS trips system at 50 deg C. Temperature monitoring to be in place. Regular infrared scanning. Data needs to be stored for trend analysis. Data indicates an event frequency of 0.001 per installation and with up to 700 units this would mean	Complex	5	1	5	5	4	64	5	1	5	5	1	16

ENVIRONMENTAL IMPACT ASSESSMENT REPORT: Scoping and Environmental Impact Assessment (EIA) Process for the Proposed Development of a Solar Photovoltaic (PV) Facility (Kudu Solar Facility 1) and associated infrastructure, near De Aar, Northern Cape Province

Impact number	Receptor	Description	Stage	Character	Preventative and Mitigative Measures	Ease of Mitigation	Raw Risk					Residual Risk						
							(M+)	E+	R+	D)x	P=	S	(M+)	E+	R+	D)x	P=	S
		grass/vegetation not controlled.			<p>an event once 2 years, i.e. a high probability event. Most events will be small not resulting in injuries, but this is possible if the event is not controlled.</p> <p>Prior to commencement of cold commissioning, emergency plan from transport and construction phase to be extended to operational phase and to include the hazards of the electrically live system.</p> <p>Procedure to address solid state container fires – extinguishing, ventilating, entering as appropriate or not. PPE for container firefighting include fire retardant, chemically resistant, nitrile gloves, antistatic acid resistant boots, full face shields, BA sets.</p> <p>A planned fire response to prevent escalation to an explosion or an environmental event.</p> <p>Suitable supply of fire extinguishing medium and cooling medium</p> <p>Consider fire water for cooling adjacent equipment – BESS units.</p> <p>Can use fogging nozzles to direct smoke.</p> <p>Ensure procedures in place for clean up after event</p> <p>Lingering HF and other toxic residues in the soil and on adjacent structures.</p> <p>Procedures to be in place for Infra-red (IR) scanning (or other suitable method) to determine if batteries are still smouldering / are sufficient cooled to handle as batteries may still be active some weeks after an event.</p> <p>Smoke or gas detector systems that are not part of the original battery container package, need to be linked to the main control panel for the entire system so that issues can be detected and responded to rapidly.</p>													

ENVIRONMENTAL IMPACT ASSESSMENT REPORT: Scoping and Environmental Impact Assessment (EIA) Process for the Proposed Development of a Solar Photovoltaic (PV) Facility
(Kudu Solar Facility 1) and associated infrastructure, near De Aar, Northern Cape Province

Impact number	Receptor	Description	Stage	Character	Preventative and Mitigative Measures	Ease of Mitigation	Raw Risk						Residual Risk											
							(M+	E+	R+	D)x	P=	S	(M+	E+	R+	D)x	P=	S						
							Significance						N4 - High						N2 - Low					
Impact 6b:	Human and Equipment Safety - exposure to fire radiation	Causes - Power Conversion System (PCS – DC to AC) cooling failure, electrical fire. Consequences - Fire starts in PCS or another section or room and spreads to battery area.	Operation	Negative	Modern lithium container design places the PCS in another part of the container with a fire rated wall separating it from the battery. Alternately the PCS in another container altogether.	Moderate	5	2	5	5	4	68	5	2	5	5	1	17						
							Significance						N4 - High						N2 - Low					
Impact 7:	Human and Equipment Safety - exposure to explosion over pressures	Cause 1 - Transformer shorting / overheating / explosion. Cause 2 - Flammable gases generated by thermal run away reach explosive limits. Ignition on hot surfaces, static. Lithium Cobalt Oxide generates O2 during decomposition – escalation. Consequences - Potential fatalities amongst first responders. Damage to container or other nearby items, e.g., other container.	Operation	Negative	Electrical equipment will be specified to suit application. Emergency response plan and employee training referred to above is to be in place. This is only really likely to happen due to possible inappropriate emergency response, e.g., opening containers when they may be the type that should be left to burn out. Modern state of the art containers have ventilation systems for vapours. Undertake a hazardous area classification of the inside of the container to confirm the rating of electrical equipment, due to possible leaks of electrolyte or generation of flammable gases under thermal run away. Emergency response plan and employee training referred to above is critical. Suitable training of selected emergency responders who may be called out to the facilities is critical. NOTE. Refer to Appendix A for an initial approximation of worst-case possible explosion impact zones.	Moderate	5	1	5	5	2	32	5	1	5	5	1	16						
							Significance						N3 - Moderate						N2 - Low					

ENVIRONMENTAL IMPACT ASSESSMENT REPORT: Scoping and Environmental Impact Assessment (EIA) Process for the Proposed Development of a Solar Photovoltaic (PV) Facility
(Kudu Solar Facility 1) and associated infrastructure, near De Aar, Northern Cape Province

Impact number	Receptor	Description	Stage	Character	Preventative and Mitigative Measures	Ease of Mitigation	Raw Risk						Residual Risk					
							(M+)	E+	R+	(D)x	P=	S	(M+)	E+	R+	(D)x	P=	S
Impact 8a:	Human and Equipment Safety - exposure to acute toxic chemical and biological agents	Causes Human pathogens and diseases, sewage, food waste. Snakes, insects, wild and domesticated animals and harmful plants. Consequences - Illness and at worst without mitigation, possibly extending to fatalities. Effects can vary from discomfort to fatalities for venomous snakes or bee swarms etc	Operation	Negative	All necessary good hygiene practices to be in place, e.g., provision of sanitation facilities, eating areas, infectious disease controls. Policies and practice for dealing with known vectors of disease such as AIDS, TB, COVID 19 and others. Awareness training for persons on site, safety induction to include animal hazards. First aid and emergency response to consider the necessary anti-venom, anti-histamines, topical medicines etc. Due to isolated locations some distance from town, the ability to treat with anti-venom and extreme allergic reactions on site is critical to mitigate the impacts	Moderate	4	1	3	2	3	30	3	1	2	2	2	16
Impact 8b:	Human and Equipment Safety - exposure to acute toxic chemical and biological agents	Causes - Damaged batteries components, leak electrolyte, are completely broken exposing hazardous chemicals. Hazardous fumes released on thermal run away see fire above. Consequences - Impacts can vary from mild skin irritation from exposure to small leaks to serious corrosive burns for large exposure.	Operation	Negative	Acid resistant PPE (e.g., overalls, gloves, eyeglasses) to be specified for all operations in electrolyte areas. PPE to be increased (e.g., full-face shield, aprons, chemical suits) for operations that involve opening equipment and potential exposure, e.g., sampling, maintenance. All operators/maintenance staff trained in the hazards of chemicals on site. Batteries contained, modules contained and all inside a container that acts as bund. Refer to fire above as all the protective measures apply to prevent toxic smoke. Refer to fire above as all the measures apply to mitigate toxic smoke. 24/7 helpline response. Standard dangerous goods requirements for Hazmat labels. All operators/maintenance staff trained in the hazards.	Moderate	4	3	3	5	3	45	3	3	3	5	2	28

ENVIRONMENTAL IMPACT ASSESSMENT REPORT: Scoping and Environmental Impact Assessment (EIA) Process for the Proposed Development of a Solar Photovoltaic (PV) Facility (Kudu Solar Facility 1) and associated infrastructure, near De Aar, Northern Cape Province

Impact number	Receptor	Description	Stage	Character	Preventative and Mitigative Measures	Ease of Mitigation	Raw Risk						Residual Risk							
							(M+	E+	R+	D)x	P=	S	(M+	E+	R+	D)x	P=	S		
		In the case of toxic fumes, serious lung damage.			NOTE Refer to Appendix A for an initial approximation of worst case possible noxious smoke impact zones.															
						Significance	N3 - Moderate						N2 - Low							
Impact 9:	Human and Equipment Safety - exposure to violent release of kinetic or potential energy	Causes - Moving equipment, pumps, heavy equipment at elevation, nip points, working at heights. Traffic accidents. Earthquake / tremor. Consequences - Injury. Fatality in unlikely worst case, e.g., traffic accidents or fall from heights. Damage to equipment, spills, environment pollution	Operation	Negative	<p>Apart from pumps, no major moving parts during operation.</p> <p>Maintenance equipment to be serviced and personnel suitably trained in the use thereof. Normally just small vehicles on site, bakkies, grass cutting, cherry-pickers etc. Possibly large cranes if large equipment or elevated structure removed/replaced.</p> <p>Traffic signs, rules etc in place on site.</p> <p>All normal working at heights, hot work permits, confined space entry, cordon off unsafe areas/works etc to be in place.</p> <p>Emergency response plan.</p> <p>Civil design to take seismic activity into account.</p>	Moderate	5	1	5	5	3	48	5	1	5	5	1	16		
							N3 - Moderate						N2 - Low							

ENVIRONMENTAL IMPACT ASSESSMENT REPORT: Scoping and Environmental Impact Assessment (EIA) Process for the Proposed Development of a Solar Photovoltaic (PV) Facility
(Kudu Solar Facility 1) and associated infrastructure, near De Aar, Northern Cape Province

Impact number	Receptor	Description	Stage	Character	Preventative and Mitigative Measures	Ease of Mitigation	Raw Risk						Residual Risk					
							(M+	E+	R+	D)x	P=	S	(M+	E+	R+	D)x	P=	S
Impact 10:	Human and Equipment Safety - exposure to electromagnetic waves	Causes - Use of electrical machines, generators etc. Hot dry area static generation is highly likely. Lightning strike. Consequences - Electrocutation. Ignition and burns. Injury and death. Damage electrical equipment.	Operation	Negative	<p>Codes and guidelines for electrical insulation. Suitable PPE to be specified.</p> <p>Low voltage equipment (e.g., batteries) separated from high voltage equipment (e.g. transmission lines), minimum is 20m.</p> <p>Ensure trained personnel and refer to guideline – IEE 1657 – 2018.</p> <p>Ensure compliance with Eskom Operating Regulations for high voltage systems including access control, permit to work, safe work procedures, live work, abnormal and emergency situations, keeping records.</p> <p>Electromagnetic fields, impact on other equipment e.g., testing devices, mobile phones – malfunction, permanent damage.</p> <p>Software also need to be kept as update to date as reasonably practicable.</p> <p>Consider suitably located Emergency stop buttons for the facility and the other equipment on site.</p> <p>PPE to consider static accumulation for entering the facility, and particularly the battery containers especially after a high temperature shut down where there could possibly be flammable materials.</p> <p>The procedures for responding to alarm and auto shut down on containers, needs to consider that there may be a dangerous environment inside and how to protect personnel who may enter to respond.</p> <p>Lightning strike rate in proposed development area is moderate.</p> <p>All outside work must be stopped during thunder storms.</p> <p>Lighting conductors may be required for the installation, to be confirmed during design</p>	Complex	5	2	5	5	3	51	5	2	5	5	1	17
Impact 11:	Environment - emissions to air	Not expected on a normal basis. Refrigerant may be an asphyxiant if accidentally released indoors it can	Operation	Negative	Especially after any warning alarms have gone off, but possibly even normally the container could be treated as entering a confined space and similar procedures could be in place, e.g., do not enter alone, gas testing prior to entering, ensure adequate ventilation.	Easy	3	1	1	1	3	18	3	1	1	1	1	6

ENVIRONMENTAL IMPACT ASSESSMENT REPORT: Scoping and Environmental Impact Assessment (EIA) Process for the Proposed Development of a Solar Photovoltaic (PV) Facility
(Kudu Solar Facility 1) and associated infrastructure, near De Aar, Northern Cape Province

Impact number	Receptor	Description	Stage	Character	Preventative and Mitigative Measures	Ease of Mitigation	Raw Risk						Residual Risk					
							(M+)	E+	R+	D)x	P=	S	(M+)	E+	R+	D)x	P=	S
		accumulate and displace oxygen.																
						Significance	N2 - Low						N1 - Very Low					
Impact 12:	Environment - emissions to water	Causes - Cooling water blow-down. Laboratory waste (if included in the design). Maintenance waste, e.g., oils. Spills from batteries, coolant system, diesel trucks, transformers. Parked vehicles – oil drips. Fire water runoff control. Kitchen waste and sewage. Refrigerant release. Consequences - Pollution if not contained. Excessive disposal costs if emissions not limited.	Operation	Negative	Bunding under any outdoors tanks, curbing under truck offloading areas and sealed surfaces (e.g., concrete) under truck parking area is particularly important. Sewage and any kitchen liquids - containment and suitable treatment/disposal. Procedures for dealing with damaged/leaking equipment as well as clean-up of spills. Normal site practices for preventing and containing diesel/paint etc spills. Waste management plan to be in place e.g., liquid waste treatment or suitable removal and disposal will be provided. Spill clean-up procedures to be in place before bringing container on site, including spill kits – non-combustible materials, hazmat disposal. The National Environment Management Act (NEMA) Section 30, the DEA Guidelines have a list of hazard categories with Reportable spill Quantities, ensure compliance with this by listing all materials on site, their hazard categories and determining the spill thresholds for reporting.	Moderate	2	2	3	2	3	27	2	2	3	2	2	18
						Significance	N2 - Low						N2 - Low					
Impact 13:	Environment - emissions to earth	Causes - Mess area and other solid waste. Disposal of solid-state batteries. Consequences - Environmental damage.	Operation	Negative	Implement waste segregation (e.g., electronic equipment, chemicals, domestic) and management on the site.	Easy	2	2	3	3	3	30	2	2	3	3	1	10
						Significance	N2 - Low						N1 - Very Low					

ENVIRONMENTAL IMPACT ASSESSMENT REPORT: Scoping and Environmental Impact Assessment (EIA) Process for the Proposed Development of a Solar Photovoltaic (PV) Facility
(Kudu Solar Facility 1) and associated infrastructure, near De Aar, Northern Cape Province

Impact number	Receptor	Description	Stage	Character	Preventative and Mitigative Measures	Ease of Mitigation	Raw Risk						Residual Risk					
							(M+	E+	R+	D)x	P=	S	(M+	E+	R+	D)x	P=	S
Impact 14:	Environment - waste of resources e.g., water, power etc	Causes - Similar to construction phase. Disposal of batteries or components. Disposal of containers. Water usage not controlled. Consequences - Delays. Excessive costs and disposal of large volumes of hazardous waste.	Operation	Negative	Water usage to be monitored on site. Handling protocols to be provided by supplier of batteries. Water management plan and spill containment plans to be in place. Investigate end of Life plan for solid state batteries - reuse / recovery / reconditioning. Similarly, for decommissioned containers – reuse / recovery / repurpose	Easy	1	1	1	2	4	20	1	1	1	2	2	10
							Significance						N2 - Low					
Impact 15:	Public - Aesthetics	Causes - Bright surfaces reflecting light. Tall structures in a flat area. Consequences - Irritation.	Operation	Negative	Refer to the Visual Impact Assessment undertaken as part of the EIA.	Easy	1	2	4	4	2	22	1	2	4	4	2	22
							Significance						N2 - Low					
Impact 16:	Investors - Financial	Causes - Defective technology. Extreme project delays. Consequences - Financial loss	Operation	Negative	Operation by experienced personnel using internationally recognized and proven technology operating procedures. Operations management with deviation monitoring.	Easy	5	1	3	4	3	39	3	1	3	4	2	22
							Significance						N3 - Moderate					

ENVIRONMENTAL IMPACT ASSESSMENT REPORT: Scoping and Environmental Impact Assessment (EIA) Process for the Proposed Development of a Solar Photovoltaic (PV) Facility
(Kudu Solar Facility 1) and associated infrastructure, near De Aar, Northern Cape Province

Impact number	Receptor	Description	Stage	Character	Preventative and Mitigative Measures	Ease of Mitigation	Raw Risk						Residual Risk					
							(M+	E+	R+	D)x	P=	S	(M+	E+	R+	D)x	P=	S
Impact 17a:	Employees and investors - Security	Causes - On route, potential hi-jacking of valuable but hazardous load. On site, theft of construction equipment and battery installation facilities. Civil unrest or violent strike by employees. Consequences - Theft. Injury to burglars. Damage to equipment possibly setting off thermal runaway.	Operation	Negative	Fencing around electrical infrastructure to SANS standard and Eskom Guidelines. Consider motion detection lights and CCTV. The hazardous nature of the electrical and battery equipment should be clearly indicated – e.g., Skull and Cross Bones or other signs. Isolated location both helps and hinders security. Night lighting to be provided both indoors and outdoors where necessary.	Moderate	3	1	3	2	4	36	3	1	3	2	2	18
Impact 17b:	Employees and investors - Security	Causes - Cyber security attacks aimed at the National Electricity Grid. Consequences - Ransom of the National Electricity Grid.	Operation	Negative	Cyber security needs monitoring. Remote access to system needs to be negotiated and controlled e.g. Password controls, levels of authority etc.to ensure protection of the National Electricity Grid from Cyber-attacks accessing through the BESS. Cyber emergency procedures – should be in place prior to commissioning.	Complex	4	4	3	1	4	48	4	4	3	1	2	24
Impact 18:	Emergencies	Causes - Fires, explosions, toxic smoke, large spills, traffic accidents, equipment/structural collapse. Inadequate emergency response to small event leads	Operation	Negative	All safety measures listed above. Emergency procedures need to be practiced prior to commencement of operations. Escape doors should swing open outwards and not into the container. Doors should be able to be hooked open when persons are inside the container, i.e. they should not be automatically self-closing. More than one exit from buildings. Storage of spare batteries (e.g., in stores on site or	Complex	4	2	3	4	3	39	4	2	3	4	2	26

ENVIRONMENTAL IMPACT ASSESSMENT REPORT: Scoping and Environmental Impact Assessment (EIA) Process for the Proposed Development of a Solar Photovoltaic (PV) Facility (Kudu Solar Facility 1) and associated infrastructure, near De Aar, Northern Cape Province

Impact number	Receptor	Description	Stage	Character	Preventative and Mitigative Measures	Ease of Mitigation	Raw Risk						Residual Risk							
							(M+	E+	R+	D)x	P=	S	(M+	E+	R+	D)x	P=	S		
		to escalation. Consequences - Injuries turn to fatalities, small losses become extended down time.			elsewhere) also needs to consider possible thermal run away.															
Significance						N3 - Moderate						N2 - Low								
Impact 19:	Investors - Legal	Causes Battery field is evolving quickly with new guides, codes and regulations happening at the same time as evolving technology. Consequences - Unknown hazards manifest due to using "cheaper supplier or less developed technology".	Operation	Negative	Use only internationally reputable battery suppliers who comply with all known regulations/guideline at the time of purchasing. Where reasonably practicable ensure only "state of the art" battery systems are used and not old technologies prone to fires/explosions etc.	Moderate	3	1	3	3	4	40	3	1	3	3	2	20		
Significance						N3 - Moderate						N2 - Low								

The above Risk Assessment shows that, provided the preventative and mitigative measures are incorporated, the operational phase of the project does not present any high risks nor any fatal flaws. The average raw risk significance is rated as moderate, and the average residual risk is rated as low.

TABLE 15.4.1.3 - DECOMMISSIONING PHASE

Battery components may have a limited lifespan, there are damaged equipment etc. There could already be “waste” on the first day of commissioning and plans should be in place to deal with this. Ideally an End-of-Life plan needs to be in place before the first BESS container / equipment is brought on site.

All decommissioning activities must comply with the relevant regulations at the time. Decommissioning will ultimately need to be informed by the regulatory requirements at the time, which may be different to present requirements. The exact risk ratings are not possible to determine now given the uncertainties in mitigations applicable at that time. Except for the actual physical disposal to ground and its legal aspects the ratings for all other hazards have been left as neutral and the mitigation measures applied to the hazards during the construction and operational phases would also be applicable during de-commissioning.

Impact number	Receptor	Description	Stage	Character	Preventative and Mitigative Measures	Ease of Mitigation	(M+	E+	R+	D)x	P=	S	(M+	E+	R+	D)x	P=	S	
							Raw Risk						Residual Risk						
Impact 1:	Human Health - chronic exposure to toxic chemical or biological agents	Similar to the construction and operational phases - no new hazards.	De-commission	Negative	As per construction and operational phases.	Easy													
							Significance						#N/A						
Impact 2:	Human Health - exposure to noise	Similar to the construction and operational phases - no new hazards.	De-commission	Negative	As per construction and operational phases.	Easy													
							Significance						#N/A						
Impact 3:	Human Health - exposure to temperature extremes and/or humidity	Similar to the construction and operational phases - no new hazards.	De-commission	Negative	As per construction and operational phases.	Easy													
							Significance						#N/A						
Impact 4:	Human Health - exposure to psychological stress	Similar to the construction and operational phases - no new hazards.	De-commission	Negative	As per construction and operational phases.	Easy													
							Significance						#N/A						

ENVIRONMENTAL IMPACT ASSESSMENT REPORT: Scoping and Environmental Impact Assessment (EIA) Process for the Proposed Development of a Solar Photovoltaic (PV) Facility
(Kudu Solar Facility 1) and associated infrastructure, near De Aar, Northern Cape Province

Impact number	Receptor	Description	Stage	Character	Preventative and Mitigative Measures	Ease of Mitigation	(M+	E+	R+	D)x	P=	S	(M+	E+	R+	D)x	P=	S	
							Raw Risk						Residual Risk						
Significance							#N/A						#N/A						
Impact 5:	Human Health - exposure to ergonomic stress	Similar to the construction and operational phases - no new hazards.	De-commission	Negative	As per construction and operational phases.	Easy													
Significance							#N/A						#N/A						
Impact 6:	Human and Equipment Safety - exposure to fire radiation	Similar to the construction and operational phases - no new hazards.	De-commission	Negative	As per construction and operational phases.	Easy													
Significance							#N/A						#N/A						
Impact 7:	Human and Equipment Safety - exposure to explosion over pressures	Similar to the construction and operational phases - no new hazards.	De-commission	Negative	As per construction and operational phases.	Easy													
Significance							#N/A						#N/A						
Impact 8:	Human and Equipment Safety - exposure to acute toxic chemical and biological agents	Similar to the construction and operational phases - no new hazards.	De-commission	Negative	As per construction and operational phases.	Easy													
Significance							#N/A						#N/A						
Impact 9:	Human and Equipment Safety - exposure to violent release of kinetic or potential energy	Similar to the construction and operational phases - no new hazards.	De-commission	Negative	As per construction and operational phases.	Easy													
							#N/A						#N/A						

ENVIRONMENTAL IMPACT ASSESSMENT REPORT: Scoping and Environmental Impact Assessment (EIA) Process for the Proposed Development of a Solar Photovoltaic (PV) Facility
(Kudu Solar Facility 1) and associated infrastructure, near De Aar, Northern Cape Province

Impact number	Receptor	Description	Stage	Character	Preventative and Mitigative Measures	Ease of Mitigation	(M+	E+	R+	D)x	P=	S	(M+	E+	R+	D)x	P=	S	
							Raw Risk						Residual Risk						
Impact 10:	Human and Equipment Safety - exposure to electromagnetic waves	Similar to the construction and operational phases - no new hazards.	De-commission	Negative	As per construction and operational phases.	Easy													
Significance						#N/A						#N/A							
Impact 11:	Environment - emissions to air	Similar to the construction and operational phases - no new hazards.	De-commission	Negative	As per construction and operational phases.	Easy													
Significance						#N/A						#N/A							
Impact 12:	Environment - emissions to water	Similar to the construction and operational phases - no new hazards.	De-commission	Negative	As per construction and operational phases.	Easy													
Significance						#N/A						#N/A							
Impact 13:	Environment - emissions to earth	Causes - Batteries / equipment reached end of life and may leak. Consequences - Environment damage from heavy metal ions.	De-commission	Negative	End of Life shutdown procedure including a Risk Assessment of the specific activities involved. Where possible re-purpose the solid-state batteries / containers and equipment with associated environmental impact considered. Disposal according to local regulations and other directives such as the European Batteries Directive, where relevant. End of life, which is affected by temperature and time, cycles etc, should be predefined and the monitoring should be in place to determine if it has been reached.	Complex	4	3	3	5	4	60	4	3	3	5	2	30	
Significance						N3 - Moderate						N2 - Low							
Impact 14:	Environment - waste of resources e.g., water, power etc	Similar to the construction and operational phases - no new hazards.	De-commission	Negative	As per construction and operational phases.	Easy													
Significance						#N/A						#N/A							
Impact 15:	Public - Aesthetics	Similar to the construction and	De-commission	Negative	As per construction and operational phases.	Easy													

ENVIRONMENTAL IMPACT ASSESSMENT REPORT: Scoping and Environmental Impact Assessment (EIA) Process for the Proposed Development of a Solar Photovoltaic (PV) Facility
(Kudu Solar Facility 1) and associated infrastructure, near De Aar, Northern Cape Province

Impact number	Receptor	Description	Stage	Character	Preventative and Mitigative Measures	Ease of Mitigation	(M+	E+	R+	D)x	P=	S	(M+	E+	R+	D)x	P=	S	
							Raw Risk						Residual Risk						
		operational phases - no new hazards.																	
						Significance	#N/A						#N/A						
Impact 16:	Investors - Financial	Similar to the construction n and operational phases - no new hazards.	De-commission	Negative	As per construction and operational phases.	Easy													
						Significance	#N/A						#N/A						
Impact 17:	Employees and investors - Security	Similar to the construction and operational phases - no new hazards.	De-commission	Negative	As per construction and operational phases.	Easy													
						Significance	#N/A						#N/A						
Impact 18:	Emergencies	Similar to the construction and operational phases - no new hazards.	De-commission	Negative	As per construction and operational phases.	Easy													
						Significance	#N/A						#N/A						
Impact 19:	Investors - Legal	Disposal of hazardous "waste" is rife with difficulties and numerous regulations that need to be complied with.	De-commission	Negative	Applicants should seek the opinion from a waste consultant on how to correctly dispose of hazardous waste.	Complex	3	1	3	3	4	40	3	1	3	3	3	30	
						Significance	N3 - Moderate						N2 - Low						

As noted above, it is not possible to provide exact ratings for most impacts predicted during the decommissioning phase based on various factors. However, from an emissions and leakage perspective, recommended mitigation measures and a preliminary significance rating has been provided, which have a raw risk rating as moderate and residual risk as low.

15.4.2 VANADIUM REDOX FLOW BATTERY ENERGY STORAGE SYSTEMS

TABLE 15.4.2.1 - CONSTRUCTION PHASE (Excluding commissioning i.e. filling the system with electrolyte, testing and initial powerup of the batteries)

Impact number	Receptor	Description	Stage	Character	Preventative and Mitigative Measures	Ease of Mitigation	(M+	E+	R+	D)x	P=	S	(M+	E+	R+	D)x	P=	S
							Raw Risk						Residual Risk					
Impact 1:	Human Health - chronic exposure to toxic chemical or biological agents	Causes - Construction materials such as cement, paints, solvents, welding fumes, truck fumes etc. Consequences - Employee / contractor illness.	Construction	Negative	The construction phase will be managed according to all the requirements of the Occupational Health and Safety Act 85 of 1993 specifically the Construction Regulations. SHEQ policy in place. A detailed construction Risk Assessment to be undertaken prior to work. SHE procedure in place. PPE to be specified. SHE appointees in place. Contractor's safety files in place and up to date. All necessary health controls/ practices to be in place, e.g., ventilation of welding and painting areas. SHE monitoring and reporting programs in place. Emergency response plan to be in place prior to beginning construction and to include aspects such as appointment of emergency controller, provision of first aid, first responder contact numbers.	Moderate	3	1	3	4	4	44	1	1	3	4	2	18
						Significance	N3 - Moderate						N2 - Low					
Impact 2:	Human Health - exposure to noise	Causes - Drilling, piling, generators, air compressors. Consequences - Adverse impact on hearing of workers. Possible nuisance factor in near-by areas.	Construction	Negative	OHS Act Noise Induced Hearing Loss Regulations. Health Risk Assessment to determine if equipment noise exceeds 85dB at workstation and 61dB at boundary of the site Employees to be provided with hearing protection if working near equipment that exceeds the noise limits.	Easy	3	1	5	5	4	56	2	1	5	5	2	26
						Significance	N3 - Moderate						N2 - Low					

ENVIRONMENTAL IMPACT ASSESSMENT REPORT: Scoping and Environmental Impact Assessment (EIA) Process for the Proposed Development of a Solar Photovoltaic (PV) Facility (Kudu Solar Facility 1) and associated infrastructure, near De Aar, Northern Cape Province

Impact number	Receptor	Description	Stage	Character	Preventative and Mitigative Measures	Ease of Mitigation	Raw Risk						Residual Risk					
							(M+	E+	R+	D)x	P=	S	(M+	E+	R+	D)x	P=	S
Impact 3:	Human Health - exposure to temperature extremes and/or humidity	Causes - Heat during the day. Cold in winter. Consequence - Heat stroke. Hypothermia.	Construction	Negative	Construction site facilities to comply with Occupational Health and Safety Act 85 of 1993, specifically the thermal, humidity, lighting and ventilation requirements of the Environmental Regulations for Workplaces. Adequate potable water for employees to be provided during all phases of the project. Bore hole, bowser and tank or small water treatment plant may be required to provide potable water for the employees during all phases of the project. Geohydrology Assessment has been conducted during the EIA Phase to assess the impact of the use of groundwater.	Easy	3	2	3	1	2	18	2	2	3	1	1	8
Impact 4:	Human Health - exposure to psychological stress	Causes - Large projects bring many contractor workers into a small, isolated community. Consequences – Lack of sufficient accommodation, entertainment etc. Increase in alcohol abuse, violence	Construction	Negative	Refer to the Socio-Economic Specialist Study undertaken as part of the EIA for this project.	Easy	2	3	3	2	2	20	2	3	3	2	2	20
Impact 5:	Human Health - exposure to ergonomic stress	Causes - Lifting heavy equipment. Awkward angles during construction. Consequences - Back and other injuries.	Construction	Negative	Training in lifting techniques. Ensure that despite the isolated location all the necessary equipment is available (and well maintained) during construction. Otherwise, employees may revert to unsafe practices. Ensure this is in place prior to project commencement Ensure first aid provision on site.	Moderate	4	1	3	2	3	30	4	1	3	2	2	20

ENVIRONMENTAL IMPACT ASSESSMENT REPORT: Scoping and Environmental Impact Assessment (EIA) Process for the Proposed Development of a Solar Photovoltaic (PV) Facility
(Kudu Solar Facility 1) and associated infrastructure, near De Aar, Northern Cape Province

Impact number	Receptor	Description	Stage	Character	Preventative and Mitigative Measures	Ease of Mitigation	Raw Risk						Residual Risk					
							(M+	E+	R+	D)x	P=	S	(M+	E+	R+	D)x	P=	S
Impact 6:	Human and Equipment Safety - exposure to fire radiation	Causes – Involvement in an external fire. Fire involving fuels used in construction vehicles or vehicles themselves (e.g., tyre fire). Fire due to uncontrolled welding or other hot-work Consequences - Injuries due to radiation especially amongst first responders and bystanders. Fatalities unlikely from the heat radiation as not highly flammable nor massive fire.	Construction	Negative	Fuels stored on site in dedicated, demarcated and bunded areas. Suitable fire-fighting equipment on site near source of fuel, e.g., diesel tank, generators, mess, workshops etc. The company responsible for the facility at this stage is to have: 1. Emergency plan to be in place prior to commencement of construction. 2. Fuel spill containment procedures and equipment to be in place. 3. Hot-work permit and management system to be in place.	Complex	4	2	3	5	4	56	4	2	3	5	2	28
Impact 7:	Human and Equipment Safety - exposure to explosion over pressures	No credible causes	Construction	Negative	None identified due to no credible causes.	N/A	1	1	1	1	1	4	1	1	1	1	1	4
Significance						#N/A						#N/A						

ENVIRONMENTAL IMPACT ASSESSMENT REPORT: Scoping and Environmental Impact Assessment (EIA) Process for the Proposed Development of a Solar Photovoltaic (PV) Facility (Kudu Solar Facility 1) and associated infrastructure, near De Aar, Northern Cape Province

Impact number	Receptor	Description	Stage	Character	Preventative and Mitigative Measures	Ease of Mitigation	(M+)	E+	R+	D)x	P=	S	(M+)	E+	R+	D)x	P=	S
							Raw Risk						Residual Risk					
Impact 8:	Human and Equipment Safety - exposure to acute toxic chemical and biological agents	Causes Human pathogens and diseases, sewage, food waste. Snakes, insects, wild and domesticated animals and harmful plants. Consequences - Illness and at worst without mitigation, possibly extending to fatalities. Effects can vary from discomfort to fatalities for venomous snakes or bee swarms etc.	Construction	Negative	All necessary good hygiene practices to be in place, e.g., provision of sanitation facilities, eating areas, infectious disease controls. Policies and practice for dealing with known vectors of disease such as AIDS, TB, COVID 19 and others. Awareness training for persons on site, safety induction to include animal hazards. First aid and emergency response to consider the necessary anti-venom, anti-histamines, topical medicines etc. Due to isolated locations some distance from town, the ability to treat with anti-venom and extreme allergic reactions on site is critical to mitigate the impacts.	Complex	4	2	3	2	3	33	3	2	3	2	2	20
						Significance	N3 - Moderate						N2 - Low					

ENVIRONMENTAL IMPACT ASSESSMENT REPORT: Scoping and Environmental Impact Assessment (EIA) Process for the Proposed Development of a Solar Photovoltaic (PV) Facility (Kudu Solar Facility 1) and associated infrastructure, near De Aar, Northern Cape Province

Impact number	Receptor	Description	Stage	Character	Preventative and Mitigative Measures	Ease of Mitigation	Raw Risk						Residual Risk					
							(M+)	E+	R+	D)x	P=	S	(M+)	E+	R+	D)x	P=	S
Impact 9:	Human and Equipment Safety - exposure to violent release of kinetic or potential energy	Causes - Construction moving equipment, heavy loaded, elevated loads, working at heights Consequences - Injury or possibly fatality. Damage to equipment. Delays in starting the project, financial losses	Construction	Negative	<p>The construction phase will be managed according to all the requirements of the Occupational Health and Safety Act 85 of 1993 specifically the Construction Regulations. SHEQ policy in place.</p> <p>A detailed construction Risk Assessment to be undertaken prior to work. SHE procedure in place. PPE to be specified. SHE appointees in place.</p> <p>Contractors safety files in place and up to date. SHE monitoring and reporting programs in place. Standard construction site rules regarding traffic, reversing sirens, rigging controls, cordoning off excavations etc.</p> <p>Civil and building structures to comply with the National Building Regulations and building Standards Act 103 of 1977, SANS 10400 and other relevant codes.</p> <p>Other constructions such as roads, sewers etc also to comply with relevant SANS standards.</p> <p>All normal procedures for working at heights, hot work permits, confined space entry, cordon off excavations etc to be in place before construction begins.</p> <p>Emergency response plan to be in place before construction begins.</p>	Complex	5	1	5	5	4	64	5	1	5	5	1	16

ENVIRONMENTAL IMPACT ASSESSMENT REPORT: Scoping and Environmental Impact Assessment (EIA) Process for the Proposed Development of a Solar Photovoltaic (PV) Facility
(Kudu Solar Facility 1) and associated infrastructure, near De Aar, Northern Cape Province

Impact number	Receptor	Description	Stage	Character	Preventative and Mitigative Measures	Ease of Mitigation	Raw Risk						Residual Risk					
							(M+	E+	R+	D)x	P=	S	(M+	E+	R+	D)x	P=	S
Impact 10:	Human and Equipment Safety - exposure to electromagnetic waves	Causes - Use of electrical machines, generators etc. Hot dry area static generation is highly likely. Lightning strike. Consequences - Electrocutation. Ignition and burns. Injury and death. Damage electrical equipment.	Construction	Negative	Standard maintenance of condition of electrical equipment and safe operating instructions. Ability to shut off power to systems in use on site. If persons are decanting fuels or dealing with other highly flammable materials care should be taken regarding possible static discharge, and installations to be suitably designed and maintained. Lightning strike rate in the study area is moderately low. Outside work must be stopped during thunderstorms. Lighting conductors may be required for the final installation, to be confirmed during design phase. Risk to and from electricity transmission pylons, suggest separation at least the pylon fall height, e.g. >10m for 10m tall pylons.	Complex	5	2	5	5	3	51	5	2	5	5	1	17
Impact 11:	Environment - emissions to air	Causes - Dust from construction and generally hot dry area. Consequences - Adverse impact on employee health.	Construction	Negative	May need to use dampening on roads etc. as per normal construction practices. May need PPE (dust masks) for specific construction workers.	Easy	3	2	1	1	4	28	2	2	1	1	2	12

ENVIRONMENTAL IMPACT ASSESSMENT REPORT: Scoping and Environmental Impact Assessment (EIA) Process for the Proposed Development of a Solar Photovoltaic (PV) Facility
(Kudu Solar Facility 1) and associated infrastructure, near De Aar, Northern Cape Province

Impact number	Receptor	Description	Stage	Character	Preventative and Mitigative Measures	Ease of Mitigation	Raw Risk						Residual Risk																	
							(M+	E+	R+	D)x	P=	S	(M+	E+	R+	D)x	P=	S												
Impact 12:	Environment - emissions to water	Causes - Diesel for equipment, paints and solvents. Transformer oil spills. Sewage and kitchen/mess area wastewater. Consequences - Environmental damage, particularly to the surface and underground water in the area.	Construction	Negative	Normal construction site practices for preventing and containing fuels/paint/oil etc spills. Bunding under any temporary tanks, curbing under truck offloading areas and sealed surfaces (e.g., concrete) under truck parking area is particularly important. Spill clean-up procedures to be in place before commencing construction. Sewage and any kitchen liquids - containment and suitable treatment/disposal	Moderate	2	2	3	2	3	27	2	2	3	2	2	18												
																			Significance						N2 - Low					
Impact 13:	Environment - emissions to earth	Causes - Mess area and other solid waste. Consequences - Environmental damage.	Construction	Negative	There will be packaging materials that will need to be disposed of after the entire system is connected and commissioned as well as after regular maintenance. There will need to be waste segregation (e.g., electronic equipment, chemicals) and management on the site.	Easy	2	2	3	3	3	30	1	2	3	3	2	18												
																			Significance						N2 - Low					
Impact 14:	Environment - waste of resources e.g., water, power etc	Causes - Water usage not controlled. Battery equipment damaged. Consequences - Delays.	Construction	Negative	Water usage to be monitored on site during construction. Handling protocols to be provided by battery supplier. Water management plan and spill containment plans to be in place.	Easy	1	1	1	2	4	20	1	1	1	2	2	10												
																			Significance						N2 - Low					
Impact 15:	Public - Aesthetics	Causes - Bright surfaces reflecting light. Tall structures in a flat area. Consequences - Irritation.	Construction	Negative	Refer to the visual impact assessment undertaken as part of the EIA.	Moderate	3	2	3	4	4	48	1	2	3	4	2	20												
																			Significance						N3 - Moderate					

ENVIRONMENTAL IMPACT ASSESSMENT REPORT: Scoping and Environmental Impact Assessment (EIA) Process for the Proposed Development of a Solar Photovoltaic (PV) Facility
(Kudu Solar Facility 1) and associated infrastructure, near De Aar, Northern Cape Province

Impact number	Receptor	Description	Stage	Character	Preventative and Mitigative Measures	Ease of Mitigation	(M+	E+	R+	D)x	P=	S	(M+	E+	R+	D)x	P=	S
							Raw Risk						Residual Risk					
Impact 16:	Investors - Financial	Causes - Defective technology. Extreme project delays. Consequences - Financial loss	Construction	Negative	Design by experienced contractors using internationally recognized and proven technology. Project management with deviation monitoring.	Moderate	5	1	3	4	3	39	3	1	3	4	2	22
						Significance	N3 - Moderate						N2 - Low					
Impact 17:	Employees and investors - Security	Causes - On route, potential hi-jacking of valuable but hazardous load. On site, theft of construction equipment and battery installation facilities. Civil unrest or violent strike by employees. Consequences - Theft. Injury to burglars. Damage to equipment possibly setting off thermal runaway.	Construction	Negative	Fencing around electrical infrastructure to SANS standard and Eskom Guidelines. The hazardous nature of the electrical and battery equipment should be clearly indicated – e.g., Skull and Cross Bones or other signs. Isolated location both helps and hinders security. Night lighting to be provided both indoors and outdoors where necessary.	Complex	4	1	3	2	4	40	3	1	3	2	3	27
						Significance	N3 - Moderate						N2 - Low					

ENVIRONMENTAL IMPACT ASSESSMENT REPORT: Scoping and Environmental Impact Assessment (EIA) Process for the Proposed Development of a Solar Photovoltaic (PV) Facility
(Kudu Solar Facility 1) and associated infrastructure, near De Aar, Northern Cape Province

Impact number	Receptor	Description	Stage	Character	Preventative and Mitigative Measures	Ease of Mitigation	(M+)	E+	R+	D)x	P=	S	(M+)	E+	R+	D)x	P=	S
							Raw Risk						Residual Risk					
Impact 18:	Emergencies	Causes - Fires, explosions, toxic smoke, large spills, traffic accidents, equipment/structural collapse. Inadequate emergency response to small event leads to escalation. Consequences - Injuries turn to fatalities, small losses become extended down time.	Construction	Negative	All safety measures listed above. Emergency procedures need to be practiced prior to commencement of construction.	Complex	4	2	3	4	3	39	4	2	3	4	2	26
Significance							N3 - Moderate						N2 - Low					
Impact 19:	Investors - Legal	Causes Battery field is evolving quickly with new guides, codes and regulations happening at the same time as evolving technology. Consequences - Unknown hazards manifest due to using "cheaper supplier or less developed technology".	Construction	Negative	Use only internationally reputable battery suppliers who comply with all known regulations/guideline at the time of purchasing. Where reasonably practicable ensure only "state of the art" battery systems are used and not old technologies prone to fires/explosions etc.	Moderate	3	1	3	3	4	40	2	1	3	3	2	18
Significance							N3 - Moderate						N2 - Low					

The above Risk Assessment shows that provided the preventative and mitigative measures are incorporated, the construction phase of the project does not present any high risks nor any fatal flaws. The average raw risk significance is rated as moderate, and the average residual risk is rated as low.

TABLE 15.4.2.2 - OPERATIONAL PHASE (Including Commissioning, e.g. filling the electrolyte into the tanks, testing the electrics, powering up the battery systems)

From the details of accidents that have happened both with BESS installations and chemical plants in general, it is clear that many potential problems manifest during the commissioning phase when units are first powered up to test functionality. This phase is critical and all controls, procedures, mitigation measures etc that would be in place for full operation should be in place before commissioning commences.

Impact number	Receptor	Description	Stage	Character	Preventative and Mitigative Measures	Ease of Mitigation	(M+)	E+	R+	D)x	P=	S	(M+)	E+	R+	D)x	P=	S
							Raw Risk						Residual Risk					
Impact 1a:	Human Health - chronic exposure to toxic chemical or biological agents	Causes - Operation and maintenance materials spare parts, paints, solvents, welding fumes, transformers oils, lubricating oils and greases etc. Consequences - Occupational illness.	Operation	Negative	<p>The operation and maintenance phase will be managed according to all the requirements of the Occupational Health and Safety Act 85 of 1993. SHEQ policy in place.</p> <p>A detailed Risk Assessment of all normal operating and maintenance activities on site to be compiled, and form the basis of operating instructions, prior to commencing commissioning.</p> <p>SHE procedure in place, e.g., PPE specified, management of change, integrity monitoring. SHE appointees in place.</p> <p>Training of staff in general hazards on site.</p> <p>All necessary health controls/ practices to be in place, e.g., ventilation of confined areas, occupational health monitoring if required and reporting programs in place.</p> <p>Emergency response plan for full operation and maintenance phase to be in place prior to beginning commissioning and to include aspects such as:</p> <ul style="list-style-type: none"> - appointment of emergency controller, - emergency isolation systems for electricity, - emergency isolation and containment systems for electrolyte, - provision of PPE for hazardous materials response, - provision of emergency facilities for staff at the main office building, - provision of first aid facilities, - first responder contact numbers etc. 	Easy	2	1	3	4	5	50	1	1	3	4	2	18
							Significance						N3 - Moderate					

ENVIRONMENTAL IMPACT ASSESSMENT REPORT: Scoping and Environmental Impact Assessment (EIA) Process for the Proposed Development of a Solar Photovoltaic (PV) Facility
(Kudu Solar Facility 1) and associated infrastructure, near De Aar, Northern Cape Province

Impact number	Receptor	Description	Stage	Character	Preventative and Mitigative Measures	Ease of Mitigation	Raw Risk						Residual Risk					
							(M+)	E+	R+	D)x	P=	S	(M+)	E+	R+	D)x	P=	S
Impact 1b:	Human Health - chronic exposure to toxic chemical or biological agents	Causes - Compromised battery compartments vapours accumulate in the containers, solids/liquids on surfaces. Maintenance of battery components, corrosive and mildly toxic liquid on surfaces. Consequences - Dermatitis, skin /eye/lung irritation.	Operation	Negative	VRFB Batteries facilities normally within buildings but may be containerized. Maintenance procedures will be in place should equipment need to be opened, e.g., pumps drained and decontaminated prior to repair in workshop etc. PPE will be specified for handling battery parts and other equipment on site. Training of staff in hazards of chemicals on site. Labelling of all equipment. Confined space entry procedures if entering tanks. Safety Data Sheets (SDSs) to be available on site. Operating manuals to be provided including start-up, shut-down, steady state, monitoring requirements. Maintenance manuals with make safe, decontamination and repair procedures. Proposed maintenance schedules e.g., checklists for weekly, monthly, annual etc. Provided portable equipment for calibration and for testing/verification of defective equipment, e.g., volt/current meters, infrared camera	Complex	2	1	3	5	4	44	1	1	3	5	2	20
Impact 2:	Human Health - exposure to noise	Causes - Moving parts inside containers, buildings, pumps, compressors, cooling systems etc. Consequences - Adverse impact on hearing of workers. Nuisance factor at near -by residences or other activities.	Operation	Negative	Design to ensure continuous noise does not exceed 85dB within the facilities or at any other location on site or 61 dB at the site boundary, e.g., emergency generator, air compressor etc. Employees to be provided with hearing protection if working near equipment that exceeds the noise limits.	Easy	2	1	5	5	4	52	2	1	5	5	2	26

ENVIRONMENTAL IMPACT ASSESSMENT REPORT: Scoping and Environmental Impact Assessment (EIA) Process for the Proposed Development of a Solar Photovoltaic (PV) Facility (Kudu Solar Facility 1) and associated infrastructure, near De Aar, Northern Cape Province

Impact number	Receptor	Description	Stage	Character	Preventative and Mitigative Measures	Ease of Mitigation	Raw Risk						Residual Risk																	
							(M+	E+	R+	D)x	P=	S	(M+	E+	R+	D)x	P=	S												
Impact 3:	Human Health - exposure to temperature extremes and/or humidity	Causes - Heat during the day. Batteries generate heat within enclosed building / containers. Cold in winter. Night work requires lighting. Consequences - Heat stroke. Hypothermia.	Operation	Negative	Building and container facilities to comply with Occupational Health and Safety Act 85 of 1993 specifically the thermal, humidity, lighting and ventilation requirements of the Environmental Regulations for Workplaces. Night work is likely for VRFB. Suitable lighting to be provided including emergency lighting for safe building exit in the event of power failure. Adequate potable water to be provided during all phases of the project. PPE for operations and maintenance staff to be suitable for the weather conditions.	Easy	4	2	3	1	2	20	3	2	3	1	1	9												
																			Significance						N2 - Low					
																									N1 - Very Low					
Impact 4:	Human Health - exposure to psychological stress	Causes - Isolated workstation and monotonous repetitive work. Consequences - Low performance, system productivity suffers.	Operation	Negative	Staff rotation to other activities within the site may be necessary. Performance monitoring of inspections / maintenance tasks in particular will be necessary.	Easy	2	3	3	2	2	20	1	3	3	2	1	9												
																			Significance						N2 - Low					
																									N1 - Very Low					
Impact 5:	Human Health - exposure to ergonomic stress	Causes - Lifting heavy equipment. Awkward angles during maintenance, stretching reaching to high level and bending to low level. Working to height if equipment located on top of electrolyte tanks, roofs or elevated electrical equipment (e.g., pylons). Consequences - Back and other injuries.	Operation	Negative	Training in lifting techniques. Training in working at heights. If equipment is at height (see OHS Act General Safety Regulation 6), ensure suitable safe (electrically and physically) ladders / harnesses etc. are available. Working at height procedure to be in place.	Easy	5	1	3	2	3	33	4	1	3	2	2	20												
																			Significance						N3 - Moderate					
																									N2 - Low					

ENVIRONMENTAL IMPACT ASSESSMENT REPORT: Scoping and Environmental Impact Assessment (EIA) Process for the Proposed Development of a Solar Photovoltaic (PV) Facility
(Kudu Solar Facility 1) and associated infrastructure, near De Aar, Northern Cape Province

Impact number	Receptor	Description	Stage	Character	Preventative and Mitigative Measures	Ease of Mitigation	Raw Risk						Residual Risk					
							(M+	E+	R+	D)x	P=	S	(M+	E+	R+	D)x	P=	S
Impact 6a:	Human and Equipment Safety - exposure to fire radiation	Causes – Involvement in an external fire e.g., veld fire, maintenance vehicle fire, electrical systems fire. Manufacturing defects or damage to battery leading to shorting and heating. High humidity condensation of water or ingress of water or flooding leading to shorting. Dust accumulation on electrical parts leading to overheating. Excessive electrical loads - surges Operator abuse BMS failure or software failure. Incorrect extinguishing medium, escalate the fire. Consequences - Contaminated run off. Radiation burns. No affected bystanders. Damaged equipment. Fire spreads to other units or offsite if grass/vegetation not controlled.	Operation	Negative	<p>Grass cutting and fire breaks around the BESS installations. No combustible materials to be stored in or near the batteries or electrical infrastructure, e.g., separation of site diesel tank and separation from substations. In this case the risk is from the substation to the BESS and not vice versa. Apply normal electrical separation distances of substation to other independent infrastructure</p> <p>Fire resistant barrier between the batteries and the PCS side if in the same container.</p> <p>Design codes from USA and standards of practice UL9540, NFPA 855 and DNV GL RP 43. Detailed Failure Mode and Effect Analysis FMEA/Hazop/Bowtie to done during design at the component level and system levels.</p> <p>Safety integrity level rating of equipment (failure probably) with suitable redundancy if required. Site Acceptance Testing as part of commissioning of each unit and the overall system. BMS should be checking individual cell voltage as well as stack, module, container, system voltages/current etc. BMS tripping the cell and possibly the stack/ building unit or module/rack/container, if variations in voltage. Diagnostics easily accessible. Diagnostics able to distinguish cell from stack or cell from module faults. As per SANS Standards, suitable ingress protection (IP) level provided for electrical equipment, e.g., IP55 - 66. If air cooling into container / building, suitable dust filters to be provided if needed. Smoke detectors may be needed linked to BMS and alerts in the main control room.</p> <p>Effects of battery aging to be considered. Temperature monitoring, regular infrared scanning. Data stored for trend analysis.</p> <p>Protective systems functionality testing.</p> <p>Prior to commencement of cold commissioning, emergency plan from transport and construction phase to extended to operational phase and to include the hazards of the electrically live system. Procedure to address suitable extinguishing media, ventilating, entering container as appropriate or not. PPE for firefighting may need to include fire retardant, chemically resistant, nitrile gloves, antistatic acid resistant boots, fill face shields, BA sets. A planned fire response to prevent escalation to an environmental event is critical. Suitable fire extinguishing medium, cooling medium and adequate supply of both is critical e.g., cooling adjacent equipment and can use fogging nozzles to direct smoke. Ensure procedures in place to clean up after event Lingering toxic residues in the soil and on adjacent structures.</p>	Complex	5	1	5	5	3	48	5	1	5	5	1	16

ENVIRONMENTAL IMPACT ASSESSMENT REPORT: Scoping and Environmental Impact Assessment (EIA) Process for the Proposed Development of a Solar Photovoltaic (PV) Facility (Kudu Solar Facility 1) and associated infrastructure, near De Aar, Northern Cape Province

Impact number	Receptor	Description	Stage	Character	Preventative and Mitigative Measures	Ease of Mitigation	Raw Risk						Residual Risk					
							(M+	E+	R+	D)x	P=	S	(M+	E+	R+	D)x	P=	S
Impact 6b:	Human and Equipment Safety - exposure to fire radiation	Causes - Power Conversion System (PCS – DC to AC) cooling failure electrical fire. Consequences - Fire starts in PCS or another section or room and spreads to battery area.	Operation	Negative	VRFB building systems PCS in another area separating it from the batteries and other equipment	Moderate	5	2	5	5	3	51	5	2	5	5	1	17
							Significance						N3 - Moderate			N2 - Low		
Impact 7:	Human and Equipment Safety - exposure to explosion over pressures	Transformer shorting / overheating / explosion. Consequences - Potential fatalities, e.g., amongst first responders. Damage to nearby equipment.	Operation	Negative	Electrical equipment will be specified to suit application. Emergency response plan and employee training referred to above is to be in place.	Moderate	5	1	5	5	2	32	5	1	5	5	1	16
							Significance						N3 - Moderate			N2 - Low		

ENVIRONMENTAL IMPACT ASSESSMENT REPORT: Scoping and Environmental Impact Assessment (EIA) Process for the Proposed Development of a Solar Photovoltaic (PV) Facility (Kudu Solar Facility 1) and associated infrastructure, near De Aar, Northern Cape Province

Impact number	Receptor	Description	Stage	Character	Preventative and Mitigative Measures	Ease of Mitigation	Raw Risk						Residual Risk					
							(M+	E+	R+	D)x	P=	S	(M+	E+	R+	D)x	P=	S
Impact 8a:	Human and Equipment Safety - exposure to acute toxic chemical and biological agents	Causes Human pathogens and diseases, sewage, food waste. Snakes, insects, wild and domesticated animals and harmful plants. Consequences - Illness and at worst without mitigation, possibly extending to fatalities. Effects can vary from discomfort to fatalities for venomous snakes or bee swarms etc	Operation	Negative	All necessary good hygiene practices to be in place, e.g., provision of sanitation facilities, eating areas, infectious disease controls. Policies and practice for dealing with known vectors of disease such as AIDS, TB, COVID 19 and others. Awareness training for persons on site, safety induction to include animal hazards. First aid and emergency response to consider the necessary anti-venom, anti-histamines, topical medicines etc. Due to isolated locations some distance from town, the ability to treat with anti-venom and extreme allergic reactions on site is critical to mitigate the impacts	Moderate	4	1	3	2	3	30	3	1	2	2	2	16
							Significance						N2 - Low			N2 - Low		
Impact 8b:	Human and Equipment Safety - exposure to acute toxic chemical and biological agents	Causes - Damaged batteries components, leak electrolyte, are completely broken exposing hazardous chemicals. Consequences - Impacts can vary from mild skin irritation from exposure to small leaks to serious corrosive burns for large exposure.	Operation	Negative	Corrosion resistant PPE (e.g., overalls, gloves, eyeglasses) to be specified for all operations in electrolyte areas. PPE to be increased (e.g., full-face shield, aprons, chemical suits) for operations that involve opening equipment and potential exposure, e.g., sampling, maintenance. All operators/maintenance staff trained in the hazards of chemicals on site. Electrolyte contained, modules contained inside a building that is banded. 24/7 helpline response. Standard dangerous goods requirements for Hazmat labels. All operators/maintenance staff trained in the hazards.	Moderate	4	3	3	5	3	45	3	3	3	5	2	28
							Significance						N3 - Moderate			N2 - Low		

ENVIRONMENTAL IMPACT ASSESSMENT REPORT: Scoping and Environmental Impact Assessment (EIA) Process for the Proposed Development of a Solar Photovoltaic (PV) Facility (Kudu Solar Facility 1) and associated infrastructure, near De Aar, Northern Cape Province

Impact number	Receptor	Description	Stage	Character	Preventative and Mitigative Measures	Ease of Mitigation	Raw Risk						Residual Risk					
							(M+	E+	R+	D)x	P=	S	(M+	E+	R+	D)x	P=	S
Impact 9:	Human and Equipment Safety - exposure to violent release of kinetic or potential energy	Causes - Moving equipment, pumps, heavy equipment at elevation, nip points, working at heights. Traffic accidents. Earthquake / tremor. Consequences - Injury. Fatality in unlikely worst case, e.g., traffic accidents or fall from heights. Damage to equipment, spills, environment pollution	Operation	Negative	<p>Apart from pumps, no major moving parts during operation.</p> <p>Maintenance equipment to be serviced and personnel suitably trained in the use thereof. Normally just small vehicles on site, bakkies, grass cutting, cherry-pickers etc. Possibly large cranes if large equipment or elevated structure removed/replaced.</p> <p>Traffic signs, rules etc in place on site.</p> <p>All normal working at heights, hot work permits, confined space entry, cordon off unsafe areas/works etc to be in place.</p> <p>Emergency response plan.</p> <p>Civil design to take seismic activity into account.</p>	Moderate	5	1	5	5	3	48	5	1	5	5	1	16
							N3 - Moderate						N2 - Low					

ENVIRONMENTAL IMPACT ASSESSMENT REPORT: Scoping and Environmental Impact Assessment (EIA) Process for the Proposed Development of a Solar Photovoltaic (PV) Facility
(Kudu Solar Facility 1) and associated infrastructure, near De Aar, Northern Cape Province

Impact number	Receptor	Description	Stage	Character	Preventative and Mitigative Measures	Ease of Mitigation	Raw Risk						Residual Risk					
							(M+)	E+	R+	D)x	P=	S	(M+)	E+	R+	D)x	P=	S
Impact 10:	Human and Equipment Safety - exposure to electromagnetic waves	Causes - Use of electrical machines, generators etc. Hot dry area static generation is highly likely. Lightning strike. Consequences - Electrocution. Ignition and burns. Injury and death. Damage electrical equipment.	Operation	Negative	<p>Codes and guidelines for electrical insulation. PPE to suit.</p> <p>Low voltage equipment (e.g., batteries) separated from high voltage (e.g., transmission to grid). Risk of pylons to BESS, suggest at least the pylon fall height, e.g. >10m for 10m tall pylons.</p> <p>Ensure trained personnel and refer to guideline – IEE 1657 – 2018.</p> <p>Ensure compliance with Eskom Operating Regulations for high voltage systems including access control, permit to work, safe work procedures, live work, abnormal and emergency situations, keeping records. Electromagnetic fields, impact on other equipment e.g., testing devices, mobile phones – malfunction, permanent damage.</p> <p>Software also need to be kept as update to date as reasonably practicable.</p> <p>Consider suitably located Emergency stop buttons for the facility and the other equipment on site.</p> <p>PPE to consider static accumulation for entering the facilities, and particularly the battery containers especially after a high temperature shut down where there could possibly be flammable materials.</p> <p>The procedures for responding to alarm and auto shut down on containers, needs to consider that there may be a dangerous environment inside and how to protect personnel who may enter to respond.</p> <p>Lightning strike rate in proposed development area is moderate.</p> <p>All outside work must be stopped during thunder storms.</p> <p>Lighting conductors may be required for the installation, to be confirmed during design</p>	Complex	5	2	5	5	3	51	5	2	5	5	1	17
Impact 11:	Environment - emissions to air	Not expected on a normal basis. Refrigerant may be an asphyxiant if accidentally released	Operation	Negative	Especially after any warning alarms have gone off, but possibly even normally the container could be treated as entering a confined space and similar procedures could be in place, e.g., do not enter	Easy	3	1	1	1	3	18	3	1	1	1	1	6

ENVIRONMENTAL IMPACT ASSESSMENT REPORT: Scoping and Environmental Impact Assessment (EIA) Process for the Proposed Development of a Solar Photovoltaic (PV) Facility
(Kudu Solar Facility 1) and associated infrastructure, near De Aar, Northern Cape Province

Impact number	Receptor	Description	Stage	Character	Preventative and Mitigative Measures	Ease of Mitigation	(M+	E+	R+	D)x	P=	S	(M+	E+	R+	D)x	P=	S
							Raw Risk						Residual Risk					
		indoors it can accumulate and displace oxygen.			alone, gas testing prior to entering, ensure adequate ventilation													
						Significance	N2 - Low						N1 - Very Low					
Impact 12:	Environment - emissions to water	<p>Causes - Cooling water blow-down. Laboratory waste (if included in the design). Maintenance waste, e.g., oils. Spills from batteries, coolant system, diesel trucks, transformers. Parked vehicles – oil drips. Fire water runoff control. Kitchen waste and sewage. Refrigerant release. VRFB electrolyte purging.</p> <p>Consequences - Pollution if not contained. Excessive disposal costs if emissions not limited.</p>	Operation	Negative	<p>Electrolyte areas fully bunded to 110% of largest tank, or more. Bunding under any outdoors tanks, curbing under truck offloading areas and sealed surfaces (e.g., concrete) under truck parking area is particularly important. Sewage and any kitchen liquids - containment and suitable treatment/disposal. Procedures for dealing with damaged/leaking equipment as well as clean-up of spills. Normal site practices for preventing and containing diesel/paint etc spills. Waste management plan to be in place e.g., liquid waste treatment or suitable removal and disposal will be provided. Spill clean-up procedures to be in place before bringing container on site, including spill kits – non-combustible materials, hazmat disposal. The National Environment Management Act (NEMA) Section 30, the DEA Guidelines have a list of hazard categories with Reportable spill Quantities, ensure compliance with this by listing all materials on site, their hazard categories and determining the spill thresholds for reporting. This is particularly relevant for liquid filled systems such as RFB.</p> <p>Process controls in place to prevent contamination and deterioration of electrolyte leading to excessive purging. Ensure proposed locations of the BESS facilities are a suitable distance from the closest water course. Relevant recommendations have been made by the Aquatic Specialist and Groundwater Specialists, and this has been factored into the layout. Refer to the relevant studies for additional information. In the</p>	Moderate	3	2	3	2	3	30	3	2	3	2	2	20

ENVIRONMENTAL IMPACT ASSESSMENT REPORT: Scoping and Environmental Impact Assessment (EIA) Process for the Proposed Development of a Solar Photovoltaic (PV) Facility (Kudu Solar Facility 1) and associated infrastructure, near De Aar, Northern Cape Province

Impact number	Receptor	Description	Stage	Character	Preventative and Mitigative Measures	Ease of Mitigation	Raw Risk						Residual Risk							
							(M+)	E+	R+	D)x	P=	S	(M+)	E+	R+	D)x	P=	S		
					event of a major spill if this is too close it may not allow time for mitigation to be taken. Adequate secondary and possibly tertiary containment systems may then be needed on site.															
Significance							N2 - Low						N2 - Low							
Impact 13:	Environment - emissions to earth	Causes - Mess area and other solid waste. Disposal of battery components. Consequences - Environmental damage.	Operation	Negative	Implement waste segregation (e.g., electronic equipment, chemicals, domestic) and management on the site. During commissioning there will be a need for bulk transport of electrolyte to site and transfer of electrolyte into the tanks within the containers. Suitable secondary containment of possible spills / overfills etc. during this transfer process will need to be in place.	Easy	2	2	3	3	4	40	2	2	3	3	2	20		
Significance							N3 - Moderate						N2 - Low							
Impact 14:	Environment - waste of resources e.g., water, power etc	Causes - Similar to construction phase. Disposal of batteries or components. Disposal of containers. Water usage not controlled. Excessive purging of deteriorated or	Operation	Negative	Water usage to be monitored on site. Handling protocols to be provided by supplier of electrolyte. Water management plan and spill containment plans to be in place. Investigate End of Life plan for electrolyte - reuse / recovery / reconditioning. Similarly, for decommissioned containers / equipment – reuse / recovery / repurpose	Easy	2	1	1	2	4	24	2	1	1	2	2	12		

ENVIRONMENTAL IMPACT ASSESSMENT REPORT: Scoping and Environmental Impact Assessment (EIA) Process for the Proposed Development of a Solar Photovoltaic (PV) Facility (Kudu Solar Facility 1) and associated infrastructure, near De Aar, Northern Cape Province

Impact number	Receptor	Description	Stage	Character	Preventative and Mitigative Measures	Ease of Mitigation	Raw Risk						Residual Risk						
							(M+	E+	R+	D)x	P=	S	(M+	E+	R+	D)x	P=	S	
		contaminated electrolyte. Consequences - Delays. Excessive costs and disposal of large volumes of hazardous waste.																	
							N2 - Low						N1 - Very Low						
Impact 15:	Public - Aesthetics	Causes - Bright surfaces reflecting light. Tall structures in a flat area. Consequences - Irritation.	Construction	Negative	Refer to the Visual Impact Assessment undertaken as part of the EIA.	Moderate	3	2	3	4	4	48	1	2	3	4	2	20	
Significance							N3 - Moderate						N2 - Low						
Impact 16:	Investors - Financial	Causes - Defective technology. Extreme project delays. Consequences - Financial loss	Operation	Negative	Operation by experienced personnel using internationally recognized and proven technology operating procedures. Operations management with deviation monitoring	Easy	5	1	3	4	3	39	3	1	3	4	2	22	
Significance							N3 - Moderate						N2 - Low						
Impact 17a:	Employees and investors - Security	Causes - On route, potential hi-jacking of valuable but hazardous load. On site, theft of construction equipment and battery installation facilities. Civil unrest or violent strike by employees. Consequences - Theft.	Operation	Negative	Fencing around electrical infrastructure to SANS standard and Eskom Guidelines. Consider motion detection lights and CCTV. The hazardous nature of the electrical and battery equipment should be clearly indicated – e.g., Skull and Cross Bones or other signs. Isolated location both helps and hinders security. Night lighting to be provided both indoors and outdoors where necessary.	Moderate	3	1	3	2	4	36	3	1	3	2	2	18	

ENVIRONMENTAL IMPACT ASSESSMENT REPORT: Scoping and Environmental Impact Assessment (EIA) Process for the Proposed Development of a Solar Photovoltaic (PV) Facility
(Kudu Solar Facility 1) and associated infrastructure, near De Aar, Northern Cape Province

Impact number	Receptor	Description	Stage	Character	Preventative and Mitigative Measures	Ease of Mitigation	Raw Risk						Residual Risk							
							(M+	E+	R+	D)x	P=	S	(M+	E+	R+	D)x	P=	S		
		Injury to burglars. Damage to equipment possibly setting off thermal runaway.																		
Significance							N3 - Moderate						N2 - Low							
Impact 17b:	Employees and investors - Security	Causes - Cyber security attacks aimed at the National Electricity Grid. Consequences - Ransom of the National Electricity Grid.	Operation	Negative	Cyber security needs monitoring. Remote access to system needs to be negotiated and controlled e.g. password controls, levels of authority etc.to ensure protection of the National Electricity Grid from Cyber-attacks accessing through the BESS. Cyber emergency procedures – should be in place prior to commissioning	Complex	4	4	3	1	4	48	4	4	3	1	2	24		
Significance							N3 - Moderate						N2 - Low							
Impact 18:	Emergencies	Causes - Fires, explosions, toxic smoke, large spills, traffic accidents, equipment/structural collapse. Inadequate emergency response to small event leads to escalation. Consequences - Injuries turn to fatalities, small losses become extended down time.	Operation	Negative	All safety measures listed above. Emergency procedures need to be practiced prior to commencement of operations. Escape doors should swing open outwards and not into the building/container. More than one exit from buildings.	Complex	4	2	3	4	3	39	4	2	3	4	2	26		
Significance							N3 - Moderate						N2 - Low							

ENVIRONMENTAL IMPACT ASSESSMENT REPORT: Scoping and Environmental Impact Assessment (EIA) Process for the Proposed Development of a Solar Photovoltaic (PV) Facility (Kudu Solar Facility 1) and associated infrastructure, near De Aar, Northern Cape Province

Impact number	Receptor	Description	Stage	Character	Preventative and Mitigative Measures	Ease of Mitigation	Raw Risk						Residual Risk					
							(M+	E+	R+	D)x	P=	S	(M+	E+	R+	D)x	P=	S
Impact 19:	Investors - Legal	Causes Battery field is evolving quickly with new guides, codes and regulations happening at the same time as evolving technology. Consequences - Unknown hazards manifest due to using "cheaper supplier or less developed technology".	Operation	Negative	Use only internationally reputable battery suppliers who comply with all known regulations/guideline at the time of purchasing. Where reasonably practicable ensure only "state of the art" battery systems are used and not old technologies prone to fires/explosions etc.	Moderate	3	1	3	3	4	40	3	1	3	3	2	20
							Significance						N3 - Moderate					

The above Risk Assessment shows that, provided the preventative and mitigative measures are incorporated, the operational phase of the project does not present any high risks nor any fatal flaws. The average raw risk significance is rated as moderate, and the average residual risk is rated as low.

TABLE 15.4.2.3 - DECOMMISSIONING PHASE

Battery components may have a limited lifespan, there are damaged equipment, waste electrolyte etc. There could already be “waste” on the first day of commissioning and plans should be in place to deal with this. Ideally an End-of-Life plan needs to be in place before the first electrolyte / container / equipment is brought on site.

All decommissioning activities must comply with the relevant regulations at the time. Decommissioning will ultimately need to be informed by the regulatory requirements at the time, which may be different to present requirements. The exact risk ratings are not possible to determine now given the uncertainties in mitigations applicable at that time. Except for the actual physical disposal to ground and its legal aspects the ratings for all other hazards have been left as neutral and the mitigation measures applied to the hazards during the construction and operational phases would also be applicable during de-commissioning.

Impact number	Receptor	Description	Stage	Character	Preventative and Mitigative Measures	Ease of Mitigation	(M+	E+	R+	D)x	P=	S	(M+	E+	R+	D)x	P=	S
							Raw Risk						Residual Risk					
Impact 1:	Human Health - chronic exposure to toxic chemical or biological agents	Similar to the construction and operational phases - no new hazards.	De-commission	Negative	As per construction and operational phases.	Easy												
							Significance						#N/A					
Impact 2:	Human Health - exposure to noise	Similar to the construction and operational phases - no new hazards.	De-commission	Negative	As per construction and operational phases.	Easy												
							Significance						#N/A					
Impact 3:	Human Health - exposure to temperature extremes and/or humidity	Similar to the construction and operational phases - no new hazards.	De-commission	Negative	As per construction and operational phases.	Easy												
							Significance						#N/A					
Impact 4:	Human Health - exposure to	Similar to the construction and	De-commission	Negative	As per construction and operational phases.	Easy												
							Significance						#N/A					

ENVIRONMENTAL IMPACT ASSESSMENT REPORT: Scoping and Environmental Impact Assessment (EIA) Process for the Proposed Development of a Solar Photovoltaic (PV) Facility
(Kudu Solar Facility 1) and associated infrastructure, near De Aar, Northern Cape Province

Impact number	Receptor	Description	Stage	Character	Preventative and Mitigative Measures	Ease of Mitigation	(M+	E+	R+	D)x	P=	S	(M+	E+	R+	D)x	P=	S	
							Raw Risk						Residual Risk						
	psychological stress	operational phases - no new hazards.																	
						Significance	#N/A						#N/A						
Impact 5:	Human Health - exposure to ergonomic stress	Similar to the construction and operational phases - no new hazards.	De-commission	Negative	As per construction and operational phases.	Easy													
						Significance	#N/A						#N/A						
Impact 6:	Human and Equipment Safety - exposure to fire radiation	Similar to the construction and operational phases - no new hazards.	De-commission	Negative	As per construction and operational phases.	Easy													
						Significance	#N/A						#N/A						
Impact 7:	Human and Equipment Safety - exposure to explosion over pressures	Similar to the construction and operational phases - no new hazards.	De-commission	Negative	As per construction and operational phases.	Easy													
						Significance	#N/A						#N/A						
Impact 8:	Human and Equipment Safety - exposure to acute toxic chemical and biological agents	Similar to the Construction and operational phases - no new hazards.	De-commission	Negative	As per construction and operational phases.	Easy													
						Significance	#N/A						#N/A						
Impact 9:	Human and Equipment Safety - exposure to violent release of kinetic or	Similar to the Construction and operational phases - no new hazards.	De-commission	Negative	As per construction and operational phases.	Easy													

ENVIRONMENTAL IMPACT ASSESSMENT REPORT: Scoping and Environmental Impact Assessment (EIA) Process for the Proposed Development of a Solar Photovoltaic (PV) Facility
(Kudu Solar Facility 1) and associated infrastructure, near De Aar, Northern Cape Province

Impact number	Receptor	Description	Stage	Character	Preventative and Mitigative Measures	Ease of Mitigation	(M+	E+	R+	D)x	P=	S	(M+	E+	R+	D)x	P=	S	
							Raw Risk						Residual Risk						
	potential energy																		
							#N/A						#N/A						
Impact 10:	Human and Equipment Safety - exposure to electromagnetic waves	Similar to the Construction and operational phases - no new hazards.	De-commission	Negative	As per construction and operational phases.	Easy													
						Significance	#N/A						#N/A						
Impact 11:	Environment - emissions to air	Similar to the Construction and operational phases - no new hazards.	De-commission	Negative	As per construction and operational phases.	Easy													
						Significance	#N/A						#N/A						
Impact 12:	Environment - emissions to water	Similar to the Construction and operational phases - no new hazards.	De-commission	Negative	As per construction and operational phases.	Easy													
						Significance	#N/A						#N/A						
Impact 13:	Environment - emissions to earth	Causes - Batteries / electrolyte / equipment reached end of life and may leak. Consequences - Environment damage from heavy metal ions.	Construction	Negative	End of Life shutdown procedure including a Risk Assessment of the specific activities involved. Where possible re-purpose the solid-state batteries / containers and equipment with associated Environmental impact considered. Disposal according to local regulations and other directives such as the European Batteries Directive. End of life, which is affected by temperature and time, cycles etc, should be predefined and the monitoring should be in place to determine if it has been reached.	Complex	4	3	3	5	4	60	4	3	3	5	2	30	
						Significance	N3 - Moderate						N2 - Low						

ENVIRONMENTAL IMPACT ASSESSMENT REPORT: Scoping and Environmental Impact Assessment (EIA) Process for the Proposed Development of a Solar Photovoltaic (PV) Facility
(Kudu Solar Facility 1) and associated infrastructure, near De Aar, Northern Cape Province

Impact number	Receptor	Description	Stage	Character	Preventative and Mitigative Measures	Ease of Mitigation	(M+	E+	R+	D)x	P=	S	(M+	E+	R+	D)x	P=	S	
							Raw Risk						Residual Risk						
Impact 14:	Environment - waste of resources e.g., water, power etc	Similar to the Construction and operational phases - no new hazards.	De-commission	Negative	As per construction and operational phases.	Easy													
Significance						#N/A						#N/A							
Impact 15:	Public - Aesthetics	Similar to the Construction and operational phases - no new hazards.	De-commission	Negative	As per construction and operational phases.	Easy													
Significance						#N/A						#N/A							
Impact 16:	Investors - Financial	Similar to the Construction and operational phases - no new hazards.	De-commission	Negative	As per construction and operational phases.	Easy													
Significance						#N/A						#N/A							
Impact 17:	Employees and investors - Security	Similar to the Construction and operational phases - no new hazards.	De-commission	Negative	As per construction and operational phases.	Easy													
Significance						#N/A						#N/A							
Impact 18:	Emergencies	Similar to the Construction and operational phases - no new hazards.	De-commission	Negative	As per construction and operational phases.	Easy													
Significance						#N/A						#N/A							
Impact 19:	Investors - Legal	Disposal of hazardous "waste" is rife with difficulties and numerous regulations that need to be complied with.	De-commission	Negative	Applicants should seek the opinion from a waste consultant on how to correctly dispose of hazardous waste.	Complex	3	1	3	3	4	40	3	1	3	3	3	30	
Significance						N3 - Moderate						N2 - Low							

The above Risk Assessment shows that, provided the preventative and mitigative measures are incorporated, the de-commissioning phase of the project does not present any high risks nor any fatal flaws.

15.5. CONCLUSIONS AND RECOMMENDATIONS

The tables in Section 15.4 contain all the recommended preventative and mitigative measures necessary to ensure risks are not unacceptably high.

Below are a few extracted items that are possibly of highest risks and therefore a priority.

15.5.1 CONCLUSIONS

GENERAL

- This Risk Assessment has found that with suitable preventative and mitigative measures in place, none of the identified potential risks are excessively high, i.e., from a SHE perspective no fatal flaws were found with either type of technology for the proposed BESS installation at the proposed Kudu Solar Facility near De Aar.
- At a large facility, without installation of the “state-of-the-art” battery technology that includes protective features, there can be significant risks to employees and first responders. The latest battery designs include many preventative and mitigative measures to reduce these risks to tolerable levels. (Refer to tables in section 15.4 under preventative and mitigative measures). Where reasonably practicable, state-of-the-art technology should be used, i.e., not old technology that may have been prone to fire and explosion risks.
- The design should be subject to a full Hazard and Operability Study (HAZOP) prior to commencement of procurement. A HAZOP is a detailed technical systematic study that looks at the intricacies of the design, the control system, the emergency system etc. and how these may fail under abnormal operating conditions. Additional safeguards may be suggested by the team doing the study.

LITHIUM SOLID STATE CONTAINERIZED BATTERIES

- With lithium solid-state batteries, the most significant hazard with battery units is the possibility of thermal runaway and the generation of toxic and flammable gases. There have been numerous such incidents around the world with batteries at all scales and modern technology providers include many preventative and mitigative features in their designs. This type of event also generates heat which may possibly propagate the thermal runaway event to neighbouring batteries if suitable “state of the art” technology is not employed.
- The flammable gases generated may ignite leading to a fire which accelerates the runaway process and may spread the fire to other parts of the BESS or other equipment located near-by.
- If the flammable gases accumulate within the container before they ignite, they may eventually ignite with explosive force. This type of event is unusual but has happened with an older technology container installed at McMicken in the USA in 2019.
- Due to a variety of causes, thermal runaway could happen at any point during transport of the BESS to the facility, during construction or operation / maintenance at the facility or during decommissioning and safe making for disposal.

- Due to the containerized approach as well as the usual good practice of separation between containers, which should be applied on this project, and therefore the likely restriction of events to one container at a time, the main risks are close to the containers i.e., to transport drivers, employees at the facilities and first responders to incidents.
- In terms of a worst conceivable case container fires, the significant impact zone is likely to be limited to within 10m of the container and mild impacts to 20m. Based on the current proposed layouts, impacts at the closest isolated farmhouses are not expected.
- In terms of a worst conceivable case explosion, the significant impact zone is likely to be limited to with 10m of the container and minor impacts such as debris within 50m. Based on the current proposed layouts, impacts at the closest isolated farmhouses are not expected.
- In terms of a worst reasonably conceivable toxic smoke scenario, provided the units are placed suitably far apart to prevent propagation from one unit to another and large external fires are prevented, the amount of material burning should be limited to one container at any one time. In this case, beyond the immediate vicinity of the fire, the concentrations of harmful gases within the smoke should be low. The proposed BESS installation's location should ideally be over 500m from any occupied development / farmhouse. The BESS is well over 500m from the closest facility to the east, and therefore the risks posed by BESS are acceptably low.
- Based on the above it is suggested that if the substation were over 20m from the closest BESS container there should be limited direct impacts of any fire or explosion on the substation. Fires at the substation are also not likely to lead to domino failures of the BESS.

VANADIUM REDOX FLOW BATTERY INSTALLATIONS

- The most significant hazard with VRFB units is the possibility of spills of corrosive and environmentally toxic electrolyte. Many preventative and mitigative features should be included in the design and operation, e.g., full secondary containment, level control on tanks, leak detection on equipment etc. (Refer to tables in section 15.4 under preventative and mitigative measures).
- VRFB units do not present significant fire and electrical arcing hazards provided they are correctly designed, operated, maintained and managed. Suitable Battery Management System (BMS), safety procedures, operating instructions, maintenance procedures, trips, alarms and interlocks should be in place. (Refer to tables in section 15.4 under preventative and mitigative measures).

TECHNOLOGY AND LOCATION OF BESS FACILITIES

- From a safety and health point of view, the above Risk Assessment shows that risks posed by VRFB systems may be slightly lower than those of SSL facilities, particularly with respect to fire and explosion risks. From an environmental spill and pollution point of view the VRFB systems present higher short-term risks than the SSL systems. However, the above conclusions may be due to the fact that the VRFB technology is not as mature as SSL technology and therefore there is not as much operating experience and accident information available for the VRFB. From an overall SHE RA point of view, there is no specific preference for a type of technology.
- From a SHE risk assessment point of view, where there is a choice of location that is further from public

roads, water courses or isolated farmhouses/occupied developments, this would be preferred. VRFB hazards are mostly related to possible loss of containment of electrolyte and SSL batteries to fires producing toxic smoke and fire fighting which may result in contaminated firewater runoff. One would not want these liquids to enter water courses nor the smoke to pass close to houses / public traffic. The current chosen location meets these separation requirements, and the relevant specialists such as aquatic and geohydrology have provided inputs on setback distances.

- Changes to the detailed layouts post Environmental Authorisation (should such be granted) are deemed acceptable if the changes remain within the approved buildable areas / development footprints, and area assessed during this Scoping and EIA Process (with the avoidance of no-go sensitive areas) and any solid state (e.g. lithium) BESS is located over 500m from farm buildings.

15.5.2 RECOMMENDATIONS

The following recommendations have been made:

- There are numerous different battery technologies but using one consistent battery technology system for the BESS installations associated with all the Kudu developments in the De Aar area would allow for ease of training, maintenance, emergency response and could significantly reduce risks.
- Where reasonably practicable, state-of-the-art battery technology should be used with all the necessary protective features e.g., draining of cells during shutdown and standby-mode, full BMS with deviation monitoring and trips, leak detection systems.
- There are no fatal flaws associated with the proposed Kudu Solar Facility battery installation for either technology type.
- The tables in Section 4 of this report contains technical and systems suggestions for managing and reducing risks. Ensure the items listed in these tables under preventative and mitigative measures are included in the design.
- The overall design should be subject to a full HAZOP prior to finalization of the design.
- For the VRFB systems an end of life (and for possible periodic purging requirements) solution for the large quantities of hazardous electrolyte should be investigated, e.g., can it be returned to the supplier for re-conditioning.
- Prior to bringing any solid-state battery containers into the country, the contractor should ensure that:
 - An Emergency Response Plan is in place that would be applicable for the full route from the ship to the site. This plan would include details of the most appropriate emergency response to fires both while the units are in transit and once they are installed and operating.
 - An End-of-Life plan is in place for the handling, repurposing or disposal of dysfunctional, severely damaged batteries, modules and containers.
- The site layout and spacing between lithium solid-state containers should be such that it mitigates the risk of a fire or explosion event spreading from one container to another.
- Under certain weather conditions, the noxious smoke from a fire in a lithium battery container could travel some distance from the unit. The smoke will most likely be acrid and could cause irritation,

coughing, distress etc. Close to the source of the smoke, the concentration of toxic gases may be high enough to cause irreversible harmful effects. Location of the facilities needs to ensure a suitable separation distance from public facilities/residences etc. The proposed BESS location is well over 500m from isolated farmhouses/development and is therefore suitable in this context.

- In order to limit the possibility of domino failures the BESS should be separated from the substation by at least 20m.
- Where there is a choice of alternative locations for the BESS, those that are further from water courses would be preferred. VRFB hazards are mostly related to possible loss of containment of electrolyte and solid-state systems may experience fires that may result in loss of containment of liquids or the use of large amounts of fire water which could be contaminated. One would not want these run-offs to enter water courses directly. The buffer distance between water bodies and the facilities containing chemicals should be set in consultation with a water specialist and is therefore not specified in this SHE RA. It is noted that there are no tributaries of the main water courses in the area within 500m of the proposed BESS location, and therefore this is not a risk of concern.
- Finally, it is suggested once the BESS technology has been chosen and more details of the final design are available, the necessary updated Risk Assessments should be in place (prior to commencement, after environmental authorisation and other necessary approvals are granted (should such be granted)).

15.6 REFERENCES

1. "National Environmental Management Act, 1998 (Act No. 107 of 1998), as amended (NEMA) and the NEMA EIA Regulations, 2014, as amended. Government Gazette No 19519 of 27 November 1998.
2. "Environmental Impact Assessment Regulations, 2014, as amended", Government Gazette No 326 of 7 April 2017.
3. SABS, "SANS 10228 – The Identification and Classification of Dangerous Goods for Transport", Standards South Africa, Pretoria, 2012.
4. SABS, "SANS 10234 – Globally Harmonize System of classification and labelling of chemicals (GHS)", SABS, Pretoria 2008.
5. SABS, "Supplement to SANS 10234 – List of classification and labelling of chemicals in accordance with the Globally Harmonize System (GHS)", SABS, Pretoria, 2008.
6. SABS, "SANS 10160: part 4: Basis of structural design and actions for buildings and industrial structures Part 4 seismic actions and general requirements for building", SABS, Pretoria, 2011.
7. SABS, "SANS10313: Protection against lightning – physical damage to structure and life hazard", SABS, Pretoria, 2012.
8. DNV-GL, Recommended Practice – Safety, operation and performance of grid-connected energy storage systems, DNVGL-RP-0043, September 2017
9. IEC, "IEC 62619 – Secondary cells and batteries containing alkaline or other non-acid electrolytes – Safety Requirements or secondary lithium cells and batteries for use in industrial applications", Feb 2017.
10. Hare, G. "Batteries – What's the Problem", Brandz, Fire and Emergency New Zealand Research Report 174. Jan 2020.
11. DNV-GL, 'McMicken Battery Energy Storage Systems Event – Technical Analysis and Recommendations, July 2020.
12. DNV-GL, 'Quantitative risk analysis for battery energy storage sites', 17 May 2019.
13. Energy Response Solutions, "Energy Storage Systems Safety - Comparing Vanadium Redox Flow and Lithium-Ion Based Systems ", Aug 2017.
14. Wikipedia, "Vanadium redox Batteries".
15. Bushveld Minerals and Energy, "Energy Storage and Vanadium Redox Flow batteries 101", 13 November 2018.
16. Whitehead A.H, Rabbow T.J, Trampert M, Pokorny P, "Critical safety features of the vanadium redox flow battery", Volume 351, 31 May 2017, Pages 1-7.
17. ESI AFRICA, "The vanadium redox flow battery, a leading technology in energy storage", Aug 8, 2019.
18. Noak J, Roznyatovskaya N, Menictas C and Skyllas-Kazacos AM, "Redox flow batteries for renewable energy storage", 21 Jan 2020.
19. Global Sustainable Energy Solutions, "Battery Storage Systems: What are their chemical hazards?", GSES Technical Papers, 2016, www.gses.com.au.
20. University of Washington Environment Health and Safety, "Lithium Battery Safety", www.ehs.washington.edu, April 2018.
21. Hesler, P & Travers, K.A., "Lithium-ion Battery Energy Storage Systems - The risks and how to manage them", AIG, 17 July 2019.
22. Verhaegh, N., van de Burgt, J., Tiggelman, A and Mulder G. "STALLION Handbook on safety assessment for large Scale, stationary, grid-connected Lithium -ion energy Storage Systems", Arnhem, March 2015.
23. TESLA, Battery Emergency Response Guide (Lithium-ion), 17 Dec 2019.
24. Tesla, MegaPack – Datasheet Safety Overview.
25. St John, J, "SunEdison Buys Solar Grid Storage for Battery-Backed PV and Wind Power", Greentechmedia.com, 5 March 2015.
26. Energy Storage Association, "Operation Risk Management in the US Energy Storage Industry: Lithium-Ion Fire and Thermal Event Safety", Sept 2019.

APPENDIX A

Preliminary Approximations of Absolute WORST-CASE Consequence and Risk Modelling (Modelling done using DNV-GL software PHAST RISK 6.7)

PLEASE NOTE – the modelling, especially the noxious smoke modelling, is an approximation.

Approximation of WORST-CASE Radiation Levels from an Entire Container on Fire

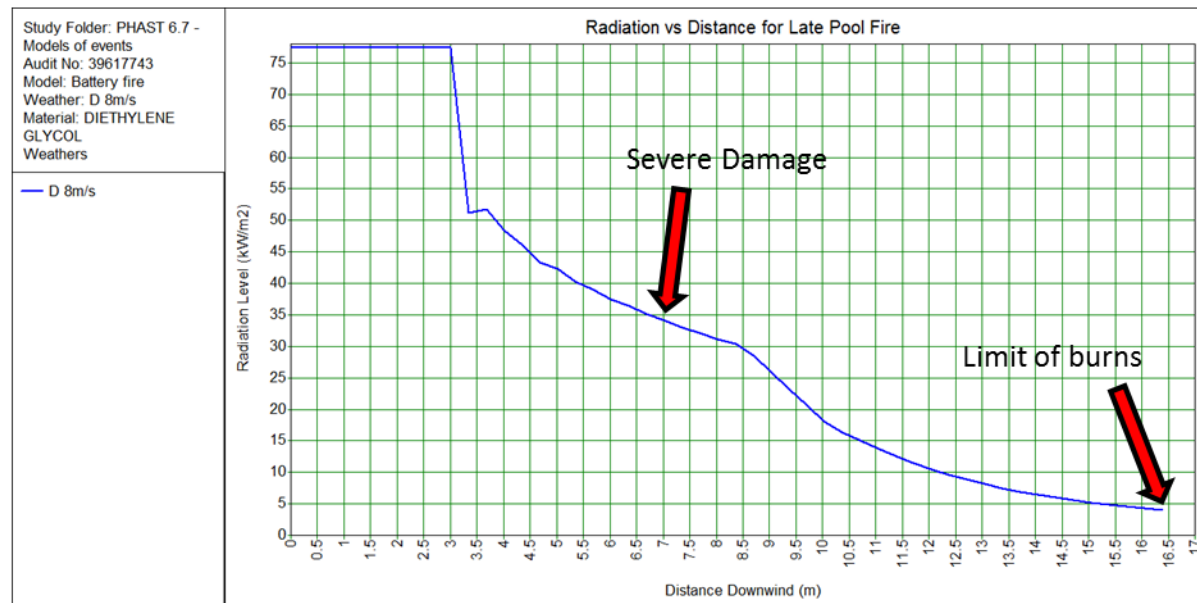

Approximation of WORST-CASE Explosion Over pressures from an Entire Container Explosion

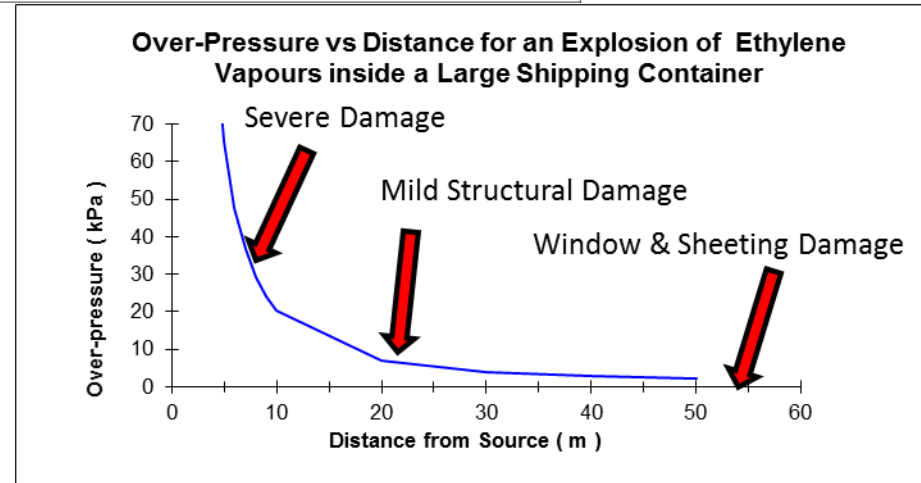
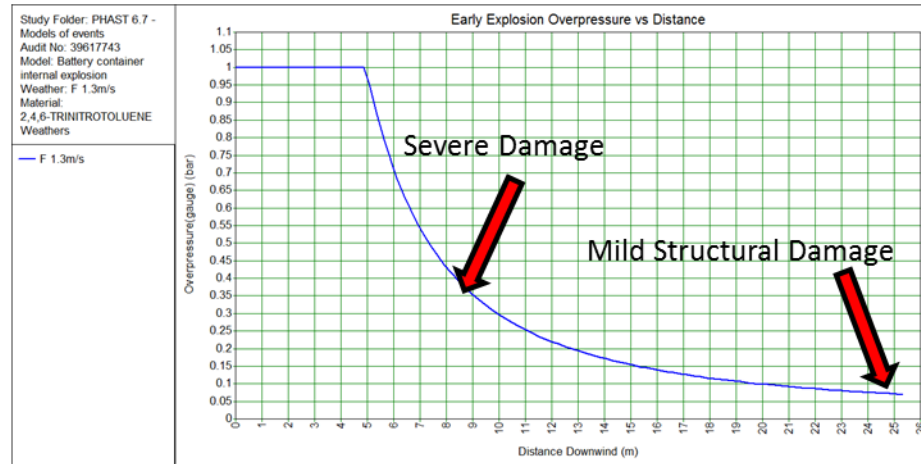

Approximation of Maximum Concentration of Carbon Monoxide in Noxious Smoke Cloud from Lithium Container Fire 200ppm is the Nuisance Level, 500ppm is potentially harmful

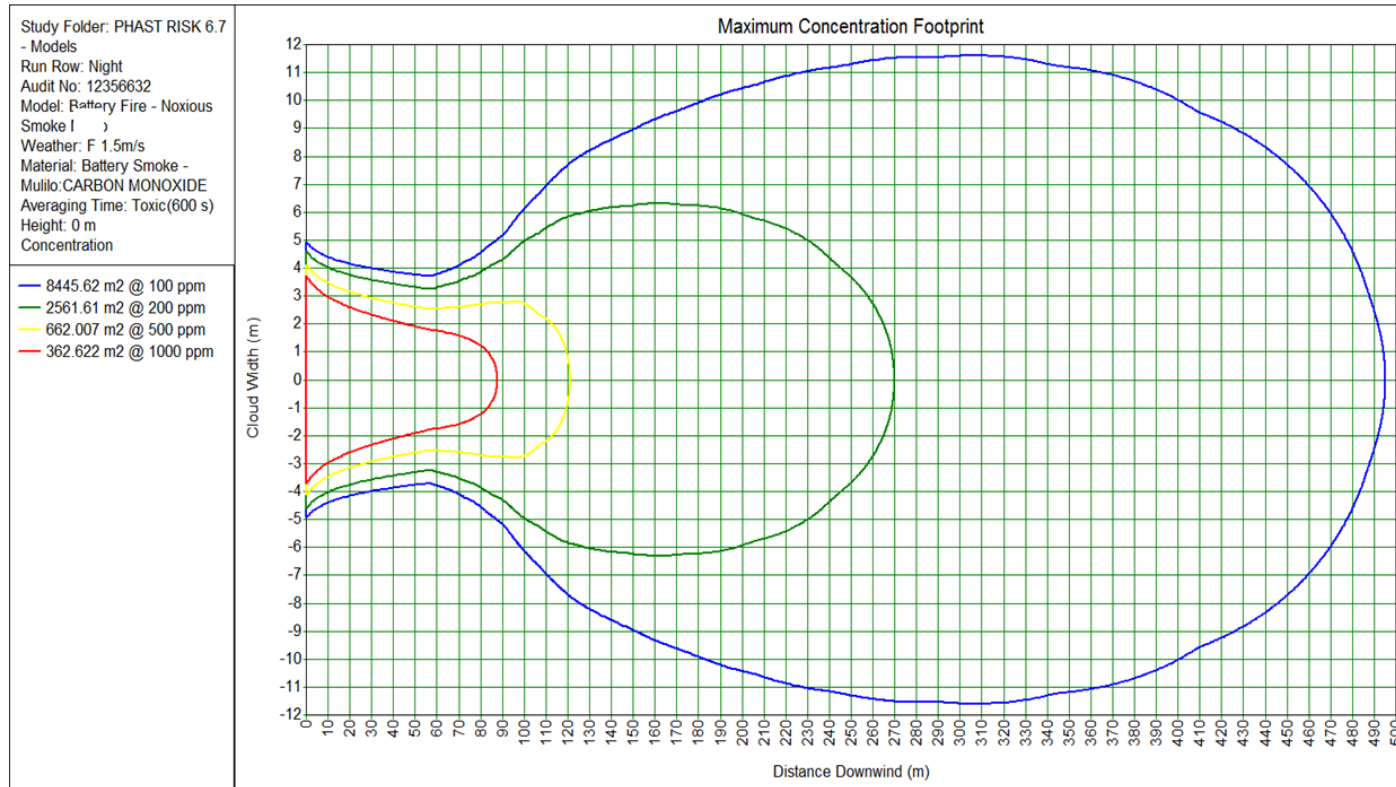

APPENDIX B: SPECIALIST STATEMENT OF INDEPENDENCE



environmental affairs

Department:
Environmental Affairs
REPUBLIC OF SOUTH AFRICA

DETAILS OF THE SPECIALIST, DECLARATION OF INTEREST AND UNDERTAKING UNDER OATH

	(For official use only)
File Reference Number:	
NEAS Reference Number:	DEA/EIA/
Date Received:	

Application for authorisation in terms of the National Environmental Management Act, Act No. 107 of 1998, as amended and the Environmental Impact Assessment (EIA) Regulations, 2014, as amended (the Regulations)

PROJECT TITLE

Scoping and Environmental Impact Assessment Processes for the Proposed Development of 12 Solar Photovoltaic (PV) Facilities and associated infrastructure (i.e. Kudu Solar Facility 1 - 12), near De Aar, Northern Cape

Kindly note the following:

1. This form must always be used for applications that must be subjected to Basic Assessment or Scoping & Environmental Impact Reporting where this Department is the Competent Authority.
2. This form is current as of 01 September 2018. It is the responsibility of the Applicant / Environmental Assessment Practitioner (EAP) to ascertain whether subsequent versions of the form have been published or produced by the Competent Authority. The latest available Departmental templates are available at <https://www.environment.gov.za/documents/forms>.
3. A copy of this form containing original signatures must be appended to all Draft and Final Reports submitted to the department for consideration.
4. All documentation delivered to the physical address contained in this form must be delivered during the official Departmental Officer Hours which is visible on the Departmental gate.
5. All EIA related documents (includes application forms, reports or any EIA related submissions) that are faxed; emailed; delivered to Security or placed in the Departmental Tender Box will not be accepted, only hardcopy submissions are accepted.

Departmental Details

Postal address:

Department of Environmental Affairs
Attention: Chief Director: Integrated Environmental Authorisations
Private Bag X447
Pretoria
0001

Physical address:

Department of Environmental Affairs
Attention: Chief Director: Integrated Environmental Authorisations
Environment House
473 Steve Biko Road
Arcadia

Queries must be directed to the Directorate: Coordination, Strategic Planning and Support at:
Email: EIAdmin@environment.gov.za

1. SPECIALIST INFORMATION

Specialist Company Name:	ISHECONcc		
B-BBEE	Contribution level (indicate 1 to 8 or non-compliant)	4	Percentage Procurement recognition
Specialist name:	Debra Catherine Mitchell		
Specialist Qualifications:	MSc Chem Eng		
Professional affiliation/registration:	ECSA Professional Engineer		
Physical address:	Building H4, Pinelands Office Park, Maxwell Drv, Moddefontein		
Postal address:	P O Box 320, Modderfontein		
Postal code:	1645	Cell:	+27 (0)82 428 8844
Telephone:	+27 (0)11 201 4783	Fax:	+27 (0)86 549 0878
E-mail:	mitchelld@isheocn.co.za		

2. DECLARATION BY THE SPECIALIST

I, DEBRA CATHERINE MITCHELL, declare that –

- I act as the independent specialist in this application;
- I will perform the work relating to the application in an objective manner, even if this results in views and findings that are not favourable to the applicant;
- I declare that there are no circumstances that may compromise my objectivity in performing such work;
- I have expertise in conducting the specialist report relevant to this application, including knowledge of the Act, Regulations and any guidelines that have relevance to the proposed activity;
- I will comply with the Act, Regulations and all other applicable legislation;
- I have no, and will not engage in, conflicting interests in the undertaking of the activity;
- I undertake to disclose to the applicant and the competent authority all material information in my possession that reasonably has or may have the potential of influencing - any decision to be taken with respect to the application by the competent authority; and - the objectivity of any report, plan or document to be prepared by myself for submission to the competent authority;
- all the particulars furnished by me in this form are true and correct; and
- I realise that a false declaration is an offence in terms of regulation 48 and is punishable in terms of section 24F of the Act.



Signature of the Specialist

ISHECONcc

Name of Company:

12 JUNE 2023

Date

Details of Specialist, Declaration and Undertaking Under Oath

3. UNDERTAKING UNDER OATH/ AFFIRMATION

I, DEBRA CATHERINE MITCHELL, swear under oath / affirm that all the information submitted or to be submitted for the purposes of this application is true and correct.



Signature of the Specialist

ISHECONcc

Name of Company

12 JUNE 2023

Date



Signature of the Commissioner of Oaths

12 JUNE 2023

Date

Dennis Richard Diamond
COMMISSIONER OF OATHS
9/1/8/2 Randburg (A15) 14 March 2001
Fish Eagle 2 Office Park
Unit 12 Kingfisher Crescent
Tel. (011) 867-4326 Fax: (011) 867-1557



CHAPTER 16: Geohydrology Assessment



GEOHYDROLOGY ASSESSMENT:

Scoping and Environmental Impact Assessment (EIA) Process for the Proposed Development of a Solar Photovoltaic Facility (Kudu Solar Facility 1) and associated infrastructure, near De Aar, Northern Cape Province

<i>Report prepared for:</i>	<i>Report prepared by:</i>
CSIR – Environmental Management Services P O Box 320 Stellenbosch 7599 South Africa	Christel van Staden; Dale Barrow; Shane Teek & Louis Jonk GEOSS South Africa (Pty) Ltd P.O. Box 12412 Die Boord, Stellenbosch 7613 South Africa Stellenbosch 7600 South Africa

Version 0: 22 March 2023

Version 1: July 2023

EXECUTIVE SUMMARY

GEOSS South Arica (Pty) Ltd was appointed to complete a geohydrology impact assessment for the proposed Kudu Solar Facilities project located approximately 60 km to the northeast of De Aar in the Northern Cape Province. This geohydrological assessment is aimed at determining the potential for groundwater to be used for construction and operational purposes, as well as the risks to nearby groundwater users which are mainly livestock and occupants on the farms.

The proposed site is directly underlain by three main lithologies (rock/soil types):

- Various shales and combinations of purple, red, green and grey, mudstone or sandstones of the Tierberg Formation (Pt) and undifferentiated sediments of the Adelaide Subgroup (predominantly horizontal layers).
- Large dolerite sill structures, which have intruded into the mudstone and sandstone layers in the area (Jd), (including associated dyke structures).
- Locally developed areas of alluvial and/or other quaternary deposits.

The Kudu Solar Facility 1 and surrounding area is underlain by two aquifers with regional groundwater electrical conductivity (EC) ranges between 70 and 300 mS/m.

- A fractured aquifer with an average borehole yield potential of 0.5 – 2.0 L/s.
- An intergranular and fractured aquifer, although there is currently no known information on this aquifer.

The water requirements for the proposed Kudu Solar Facility 1 are as follows:

- Construction phase: 9 000 m³/a (0.29 L/s)
- Operational phase: 1 000 m³/a (0.03 L/s).

The assessment identified the following main impacts along with the significance of each phase pre and post mitigation shown in the table below.

Construction Phase

- Potential impact 1: Potential lowering of the groundwater level.
- Potential impact 2: Potential impact on groundwater quality as a result of accidental oil spillages or fuel leakages.

Operational Phase

- Potential impact 3: Potential lowering of the groundwater level.
- Potential impact 4: Potential impact on groundwater quality as a result of using cleaning agents for cleaning the solar panels.

- Potential impact 5: Groundwater quality deterioration as a result of electrolyte that will be used for the Battery Energy Storage System (BESS).

Decommissioning Phase

- Potential impact 6: Potential impact on groundwater quality as a result of accidental oil spillages or fuel leakages.
- Potential impact 7: Potential lowering of the groundwater level.

Cumulative impacts identified were identical to the individual impacts of the individual Kudu Solar Facility 1, with the only changes occurring in the duration, scale, and likelihood of the impacts occurring.

Phase	Overall Impact Significance (Pre-Mitigation)	Overall Impact Significance (Post Mitigation)
Construction	Moderate to Very Low	Low-Very Low
Operational	Moderate to Very Low	Low-Very Low
Decommissioning	Very Low	Very Low
Cumulative Impacts		
Cumulative - Construction	Moderate to Very Low	Low-Very Low
Cumulative - Operational	Moderate to Very Low	Low-Very Low
Cumulative - Decommissioning	Very Low	Very Low

A summary of the main mitigation measures identified for the developments include:

- Inclusion of a borehole monitoring program
- Adherence to the safe borehole yield values
- The use of environmentally friendly cleaning agents
- Construction of BESS with a 50-meter buffer from any boreholes
- The addition of effective bunding and secondary containment around BESS facilities
- Vehicles must be regularly serviced and maintained.
- Inclusion of drip trays for long standing vehicles.
- Diesel fuel storage tanks should be above ground on an impermeable concrete surface in a bunded area.
- Construction vehicles and equipment should also be refuelled on an impermeable surface. Spillages are to be removed with correct disposal procedures.
- Proof of disposal retained on file for auditing purposes.

The distribution of boreholes across the proposed area have been assessed in relation to the farm portions with special reference to the allowable General Authorisation volumes for each of the constituent farm portions that comprise the proposed Kudu Solar Facility 1 and surrounds. Furthermore, the hydrocensus has confirmed there are several boreholes on site and/or on neighbouring properties, with HBH1 representing a potentially viable source of groundwater for the development of Solar Facility 1. The use of this/these borehole/s would/will depend on the operational requirements of the facility, negotiations with the landowners and proximity to the facility.

Considering that the required peak (construction) water supply is 9 000 m³/a (0.29 L/s) for the proposed Kudu Solar Facility 1, the required water volumes should be readily available and could be supplied by the regional aquifer yield (0.5 – 2.0 L/s).

The demand for the facility could potentially be met by abstraction from Farm 3/88. However, if Solar Facilities 2, 3, 4 and 5 are constructed simultaneously, the water demands during the construction period will exceed the available GA volume of the farm portion. Furthermore, the cumulative demands of construction (~4.6 L/s) for all twelve planned Kudu Solar Facilities (if developed simultaneously) exceeds the regional yield potential of the underlying aquifer (0.5 – 2.0 L/s). Therefore, groundwater exploration (including hydrocensus, lineament mapping and geophysics) on adjacent properties should be undertaken for additional supply to meet the demands. Alternatively, to source all the water from this farm portion, a Water Use License Application will be required to meet the demands of the construction period.

Given the findings of this assessment, an overall significance rating post mitigation is given as **Low to Very Low** and the development of the proposed Kudu Solar Facility is authorised to continue on condition the following recommendations are adhered to:

- In the case that multiple projects are constructed simultaneously, adherence to recommended mitigation measures should be strictly followed to prevent over abstraction.
- In the event that groundwater is to be used in the project, the proposed monitoring plan should be followed with a special focus on groundwater level monitoring to ensure that the aquifer is not over abstracted and falls to levels below historic borehole depths.
- All proposed impact mitigation measures are to be implemented during the development of the project. These include the use of environmentally safe cleaning agents, the construction of BESS facilities 50m from any boreholes along with appropriate bunding and secondary containment, and the recommended precautionary approaches aimed at preventing oil spills and fuel leaks.



CONTENTS

16. GEOHYDROLOGY ASSESSMENT	16-11
16.1 Introduction	16-11
16.1.1 Scope, Purpose and Objectives of this Specialist Report	16-13
16.1.2 Details of Specialist	16-13
16.1.3 Terms of Reference	16-13
16.2 Approach and Methodology	16-15
16.2.1 Information Sources	16-15
16.2.2 Assumptions, Knowledge Gaps and Limitations	16-15
16.2.3 Consultation Processes Undertaken	16-16
16.3 Description of Project Aspects relevant to Hydrogeological Specialist Study	16-17
16.4 Baseline Environmental Description	16-18
16.4.1 Study Area Definition	16-18
16.4.2 General Description	16-18
16.4.3 Project Specific Description	16-21
16.4.3.1 Climate	16-21
16.4.3.2 Regional Geology	16-22
16.4.3.3 Regional Hydrogeology	16-22
16.4.3.4 Aquifer Vulnerability (DRASTIC)	16-23
16.4.4 Site Specific and Existing Groundwater Information	16-24
16.4.4.1 NGA Database	16-24
16.4.4.2 Hydrocensus	16-25
16.4.4.3 Groundwater Quality	16-27
16.4.4.3.1 SANS241-1:2015: Drinking water standards	16-27
16.4.4.3.2 DWA (1998): Drinking Water Assessment Guide	16-28
16.4.4.4 Water level elevation maps	16-30
16.4.5 Identification of Environmental Sensitivities	16-36
16.4.5.1 Sensitivities identified by the National Web-Based Environmental Screening Tool	16-36
16.4.5.2 Specialist Sensitivity Analysis and Verification	16-36
16.4.5.3 Sensitivity Analysis Summary Statement	16-37
16.5 Issues, Risks and Impacts	16-39
16.5.1 Identification of Potential Impacts/Risks	16-39
16.5.2 Summary of Issues identified during the Public Consultation Phase	16-40

16.6	Impact Assessment	16-47
16.6.1	Potential Impacts during the Construction Phase	16-47
16.6.1.1	Impact 1: Groundwater impact as a result of over-abstraction from construction requirements	16-47
16.6.2	Potential Impacts during the Operational Phase	16-50
16.6.2.1	Impact 1: Groundwater impact as a result of over-abstraction from operational requirements	16-50
16.6.2.2	Impact 2: Potential impact on groundwater quality as a result of using cleaning agents	16-50
16.6.2.3	Impact 3: Potential impact on groundwater quality as a result of electrolyte that will be used for the BESS	16-50
16.6.3	Potential Impacts during the Decommissioning Phase	16-52
16.6.3.1	Impact 1: Potential Impact on Groundwater Quality as a result of Accidental Oil Spillages or Fuel Leakages	16-52
16.6.3.2	Impact 2: Groundwater impact as a result of over-abstraction from decommissioning requirements	16-52
16.6.4	Potential Cumulative Impacts	16-54
16.6.4.1	Impact 1: Groundwater impact as a result of over-abstraction from construction, operation, and decommissioning requirements	16-56
16.6.4.2	Impact 2: Potential Impact on Groundwater Quality as a result of Accidental Oil Spillages or Fuel Leakages during the construction and decommissioning phases	16-57
16.6.4.3	Impact 3: Potential impact on groundwater quality as a result of using cleaning agents during the operational phase	16-58
16.6.4.4	Impact 4: Potential impact on groundwater quality as a result of electrolyte that will be used for the BESS during the operational phase	16-58
16.6.4.5	Concluding Cumulative Summary: Potential impacts during the construction, operational, and decommissioning phases of other wind and solar, and EGI projects within a 30 km radius.	16-58
16.6.4.6	Impact Summary Tables: Cumulative Impacts	16-59
16.6.5	No-go Alternatives	16-62
16.6.6	Battery Energy Storage System	16-62
16.7	Impact Assessment Summary	16-63
16.8	Legislative and Permit Requirements	16-63
16.9	Environmental Management Programme Inputs	16-66
16.9.1	Proposed Monitoring Plan:	16-67
16.9.1.1	Groundwater Level Monitoring	16-68
16.9.1.2	Groundwater Quality Monitoring	16-68
16.9.1.3	Sample Collection, Preservation and Submission	16-69
16.9.1.4	Monitoring Frequency and Parameter Analysis	16-69
16.10	Final Specialist Statement and Authorisation Recommendation	16-73
16.10.1	Statement and Reasoned Opinion	16-73
16.10.2	EA Condition Recommendations	16-74
16.11	References	16-75

APPENDICES	16-77
APPENDIX A - SPECIALIST EXPERTISE	16-77
APPENDIX B - SPECIALIST STATEMENT OF INDEPENDENCE	16-81
APPENDIX C - SITE SENSITIVITY VERIFICATION	16-90
APPENDIX D - IMPACT ASSESSMENT METHODOLOGY	16-91
APPENDIX E - COMPLIANCE WITH THE APPENDIX 6 OF THE 2014 EIA REGULATIONS (AS AMENDED)	16-96
APPENDIX F - OTHER RENEWABLE ENERGY PROJECTS WITHIN 30 KM OF THE KUDU SOLAR PV FACILITY	16-98



Table 16-1: Information sources used to assess the Groundwater for the proposed Kudu Solar Facility project.	16-15
Table 16-2: Geological formations within the study area listed in order of relative age.	16-22
Table 16-3: Summary of NGA borehole.	16-25
Table 16-4 : Summary of Boreholes in the study area.	16-25
Table 16-5: Classification table for specific limits for domestic water standards	16-27
Table 16-6: Production borehole results classified according the SANS241-1:2015	16-27
Table 16-7: Classification table for the groundwater results (DWAF, 1998)	16-28
Table 16-8: Classified production borehole results according to DWAF 1998.	16-28
Table 16-9: Table showing a summary of the main comments received from stakeholders during the Public Consultation Phase during Scoping with key responses	16-41
Table 16-10: Extent and water requirements of the Kudu Solar Facility 1	16-47
Table 16-11: Impact Summary Tables: Construction Phase	16-49
Table 16-12: Impact Summary Tables: Operational Phase	16-51
Table 16-13: Impact Summary Tables: Decommissioning Phase	16-53
Table 16-14: Summary of anticipated water requirements of solar facilities during construction and operational phases.	16-57
Table 16-15: Overall Impact Significance	16-63
Table 16-16: Farm portions affected by the proposed Kudu Solar Facilities; relevant portion highlighted in blue.	16-65
Table 16-17: General locations for proposed monitoring points.	16-67
Table 16-18: Proposed groundwater monitoring parameters and their recommended frequency.	16-70
Table 16-19: Approved renewable energy projects, located within 30 km of the proposed Kudu Solar Facility.	16-98

FIGURES

- Figure 16-1: Monthly average air temperature for the Kudu Solar Facility study area (Schulze, 2009). 16-21
Figure 16-2: Monthly median rainfall and evaporation distribution for the Kudu Solar Facility study area (Schulze, 2009). _____ 16-21
Figure 16-3: Correlation between surface topography and groundwater elevation. _____ 16-30
Figure 16-4: Schematic representation of the proposed general borehole construction. _____ 16-68
Figure 16-5: Guide to assessing risk/impact significance as a result of consequence and probability. 16-94

MAPS

- Map 16-1: Locality of the proposed Kudu Solar Facility development, near De Aar, Northern Cape. 16-12
Map 16-2: The study area delineating the study area for the 12 Kudu Solar Facilities, property boundaries, hydrocensus boreholes and the NGA borehole on a 1:50 000 scale topocadastral map (3024AA, 3024AB, 3024AC, 3024AD, 3024BA, 3024BC). Note that this report is focused on Kudu Solar Facility 1. _____ 16-19
Map 16-3: Aerial view delineating the study area of the 12 Kudu Solar Facilities, hydrocensus boreholes and the NGA borehole. Note that this report is focused on Kudu Solar Facility 1. _____ 16-20
Map 16-4: Geological setting of the study area for the Kudu Solar Facilities. (CGS (1997) map: 1:250 000 scale Colesberg). Note that this report is focused on Kudu Solar Facility 1. _____ 16-31
Map 16-5: Regional aquifer yield (DWAF, 2005) and borehole yields (L/s) in the study area for the Kudu Solar Facilities. Note that this report is focused on Kudu Solar Facility 1. _____ 16-32
Map 16-6: Regional groundwater quality (mS/m) from DWAF (2005) and borehole groundwater quality (EC in mS/m) in the study area for the Kudu Solar Facilities. Note that this report is focused on Kudu Solar Facility 1. _____ 16-33
Map 16-7: Vulnerability rating (DWAF, 2005) and groundwater depths (mbgl) in the study area for the Kudu Solar Facilities. Note that this report is focused on Kudu Solar Facility 1. _____ 16-34
Map 16-8: Groundwater contour map based on the March 2022 field measurements in the study area. Note that this report is focused on Kudu Solar Facility 1. _____ 16-35
Map 16-9: Detailed Layout of Kudu Solar Facility 1 _____ 16-38
Map 16-10: Map showing the proposed Kudu Solar PV Facility in relation to other local authorised, in process or operational renewable projects _____ 16-55
Map 16-11: Proposed monitoring borehole locations from an aerial view. _____ 16-72



ABBREVIATIONS

Abbreviations	
BH	Borehole
CGS	Council for Geoscience
DHSWS	Department of Human Settlements, Water and Sanitation
DWA	Department of Water Affairs (used to be Department of Water Affairs and Forestry)
DWAF	Department of Water Affairs and Forestry
DWS	Department of Water and Sanitation
EC	electrical conductivity
GIS	Geographic Information System
L/s	litres per second
m	metres
mbch	meters below collar height
mbgl	metres below ground level
mm	millimetre
mS/m	milli-Siemens per metre
NGA	National Groundwater Archive
WARMS	Water Authorisation and Registration Management System

GLOSSARY

Definitions	
Aquifer	A geological formation, which has structures or textures that hold water or permit appreciable water movement through them [from National Water Act (Act No. 36 of 1998)].
Borehole	Includes a well, excavation, or any other artificially constructed or improved groundwater cavity which can be used for the purpose of intercepting, collecting or storing water from an aquifer; observing or collecting data and information on water in an aquifer; or recharging an aquifer [from National Water Act (Act No. 36 of 1998)].
DRASTIC	An acronym for a groundwater vulnerability assessment methodology: D = depth to groundwater / R = recharge / A = aquifer media type / S = soil type / T = topography / I = impact of the unsaturated zone / C = hydraulic conductivity. The methodology uses a rating and weighting approach and was developed by the Environmental Protection Agency (USA)
Electrical Conductivity	The ability of groundwater to conduct electrical current, due to the presence of charged ionic species in solution (Freeze and Cherry, 1979).
Fractured aquifer	Fissured and fractured bedrock resulting from decompression and/or tectonic action. Groundwater occurs predominantly within fissures and fractures.
Groundwater	Water found in the subsurface in the saturated zone below the water table or piezometric surface i.e. the water table marks the upper surface of groundwater systems.
Inferred	Where a geological contact or fault is believed to exist however is not confirmed.
Intergranular aquifer	Generally unconsolidated but occasionally semi-consolidated aquifers. Groundwater occurs within intergranular interstices in porous medium. Typically occur as alluvial deposits along river terraces.
Intergranular and fractured aquifers	Largely medium to coarse grained granite, weathered to varying thicknesses, with groundwater contained in intergranular interstices in the saturated zone, and in jointed and occasionally fractured bedrock.
Vulnerability	The tendency or likelihood for contaminants to reach a specified position in the ground-water system after introduction at some location above the uppermost aquifer (National Research Council, 1993).

16. GEOHYDROLOGY ASSESSMENT

This report serves as the Groundwater Impact Assessment that was prepared as part of the Environmental Impact Assessment (EIA) Processes for the proposed development of 12 Solar Photovoltaic (PV) Facilities (Kudu Solar Facilities 1 - 12) and associated infrastructure, near De-Aar, Northern Cape Province (Map 16-1).

16.1 Introduction

GEOSS South Arica (Pty) Ltd was appointed to complete a geohydrology impact assessment for the proposed Kudu Solar Facilities project. This geohydrological assessment includes a review of groundwater characteristics and users in the area, with the aim of determining the potential for groundwater to be used for construction and operational purposes, as well as risk to nearby groundwater users.

The generation capacity of each proposed solar PV facility will range from 50 MWac to 350 MWac. Four PV facilities each have a capacity of more than 150 MWac but up to 350 MWac. Eight PV facilities each have an estimated capacity of up to 150 MWac. Generally, the water requirements are as follows:

For the facilities (i.e. eight) with an estimated capacity of up to 150 MWac:

- Construction Phase: The total water requirement is estimated to be 9 000 m³/a per solar facility thus a total 72 000 m³/a. The construction phase should last approximately 18 months.
- Operational Phase: The total water requirement is estimated to be 1 000 m³/a per solar facility thus a total of 8 000 m³/a for the operational phase which should last approximately 20 years.

For the facilities (i.e. four) with an estimated capacity of more than 150 MWac but up to 350 MWac:

- Construction Phase: The total water requirement is estimated to be 18 000 m³/a per solar facility thus a total 72 000 m³/a. The construction phase should last approximately 18 months.
- Operational Phase: The total water requirement is estimated to be 2 000 m³/a per solar facility thus a total of 8 000 m³/a for the operational phase which should last approximately 20 years.

For the capacity and water requirement of this facility see Table 16-10. The water requirements differ depending on the capacity of the facility, and this is elaborated upon for this specific facility in subsequent sections (Section 16.5 – 16.9).

This report outlines the work completed to assess the likelihood of using groundwater for the proposed Kudu Solar Facility development, including the potential impact the development may have on groundwater resources in the area.

Separate reports have been compiled for each PV facility. This report only covers the Kudu Solar Facility 1 and associated infrastructure (hereafter referred to as the “Kudu Solar Facility” or “proposed project”).

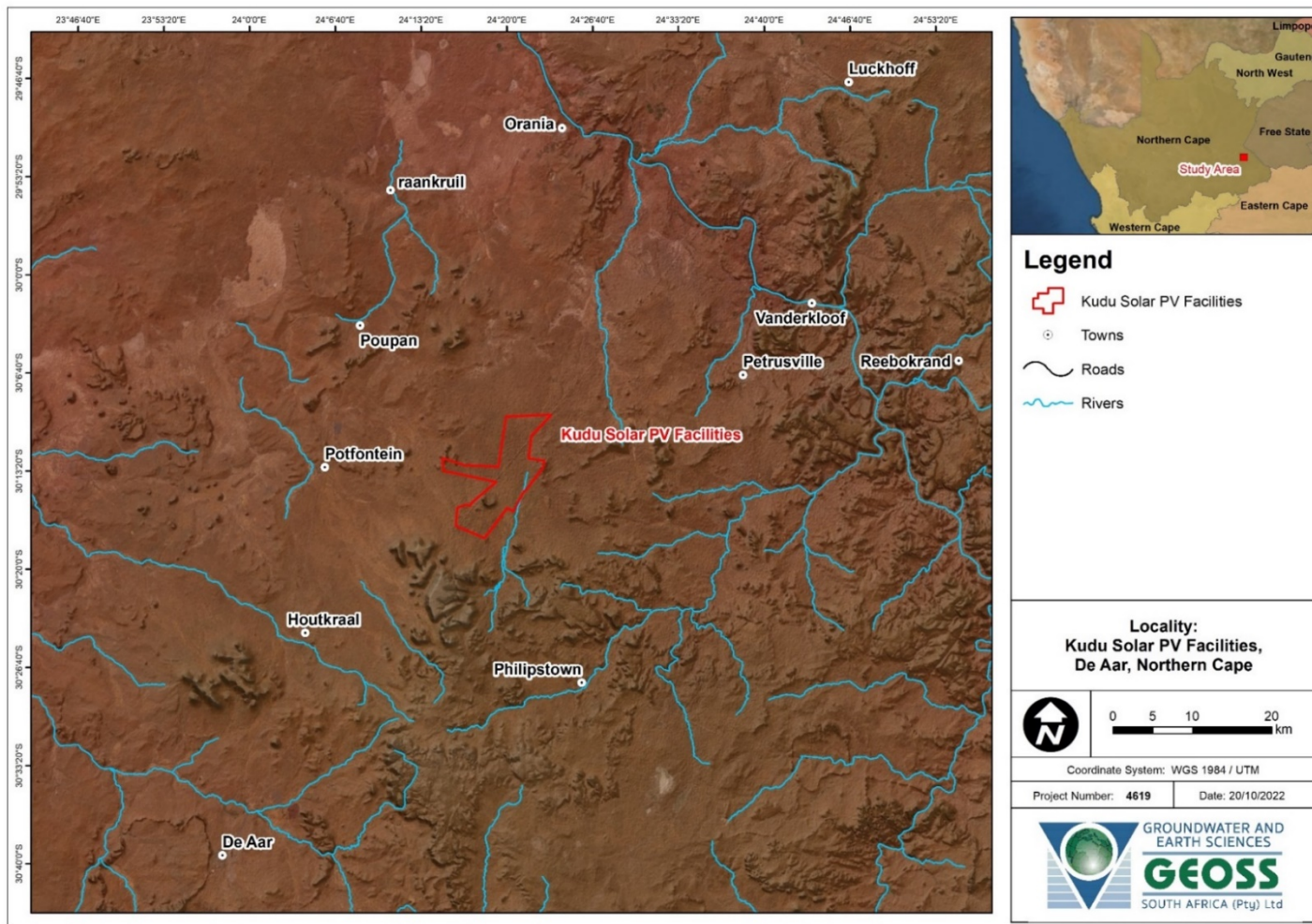

Map 16-1: Locality of the proposed Kudu Solar Facility development, near De Aar, Northern Cape.

16.1.1 Scope, Purpose and Objectives of this Specialist Report

The scope of work is to provide groundwater specialist services with regard to the tasks outlined below:

- Assessment for groundwater to be used for construction and operational purposes for the proposed project, including solar panel cleaning.
- Assessment of the impact on geohydrological resources as a result of the proposed development.
- Provide recommendations to minimize or mitigate impacts.
- Confirm what type of authorisation is required to make use of the groundwater.

The results of the investigation are presented in this report along with the data analysis and interpretation.

16.1.2 Details of Specialist

This specialist assessment has been undertaken by Dale Barrow, Christel van Staden, Shane Teek and Louis Jonk of GEOSS South Africa. Dale Barrow is registered with the South African Council for Natural and Scientific Professions (SACNASP), as a Professional Natural Scientist, with Registration Number 400289/13 in the field of Earth Sciences. Christel van Staden is registered as a candidate with the SACNASP, with Registration Number 122591. Shane Teek is registered as a candidate with the SACNASP, with Registration Number 126397. Louis Jonk is registered as a Professional Natural Scientist with the SACNASP, with Registration Number 121278. A curriculum vitae is included for all parties in Appendix A of this Specialist Assessment.

In addition, a signed specialist statement of independence is included in Appendix B of this specialist input report.

16.1.3 Terms of Reference

The procedure adopted for this Impact Assessment Level study involved an initial desktop study of all available data and databases. The study involved obtaining and reviewing all relevant data to the proposed projects. This included analysing data from the National Groundwater Archive (NGA), Water Authorisation and Registration Management System (WARMS) and GEOSS's internal database, as well as groundwater yield, groundwater chemistry and geological maps of the area. A site visit was also carried out on the 23rd and 24th of March 2022 to conduct a hydrocensus to obtain further groundwater use information. The hydrocensus data was also analysed using geohydrological and spatial analysis methods to address the project objectives. A summary of the sensitivities and high-level impacts was also included.

The following terms of reference applies to the assessment:

- Obtain data for all the PV sites (i.e. obtain data from the NGA (and associated groundwater use databases) and internal GEOSS database (which includes information relevant to the site). Obtain data from the local Department of Water and Sanitation (DWS) monitoring boreholes.

Obtain relevant geological maps and geohydrological maps, as well as relevant groundwater reports.

- Undertake a site visit in order to identify the level of sensitivity relating to geohydrology, and to complete a hydrocensus.
- Analyse the hydrocensus data using geohydrological and spatial analysis methods to address the project objectives.
- Compile a Geohydrology Impact Assessment in compliance with Appendix 6 of the 2014 National Environmental Management Act (Act 107 of 1998, as amended) (NEMA) EIA Regulations (as amended) and Part A of the Assessment Protocols published in GN 320. The Specialist Assessment must also be in adherence to any additional relevant legislation and guidelines that may be deemed necessary, as applicable.
- Determination, description and mapping of the baseline environmental condition and sensitivity of the study area relating to geohydrology (including hydrogeological characterisation of aquifers (types, sensitivity, vulnerability)), and groundwater (quality, quantity, use, potential for industrial or domestic use) in the area surrounding the proposed development. Specify set-backs or buffers, and provide clear reasons for these recommendations.
- Provide review input on the preferred infrastructure layout following the sensitivity analysis and layout identification.
- Identify relevant permits that may be required and additional protocols and/or licensing requirements that are relevant to the project and the implications thereof, if any.
- A description of assumptions and limitations used.
- Identify significant features or disturbances within the proposed project study area and define any environmental risks in terms of geohydrology and the proposed project infrastructure.
- Confirm what type of authorisation or licence is required to make use of the groundwater.
- Identify and assess the potential direct, indirect and cumulative impacts of the proposed development geohydrology.
- Provide recommendations with regards to potential monitoring programmes.
- Determine mitigation and/or management measures for inclusion in the Environmental Management Programme (EMPr) which could be implemented to as far as possible reduce the effect of negative impacts and enhance the effect of positive impacts. Also identify best practice management actions, monitoring requirements, and rehabilitation guidelines for all identified impacts for inclusion in the EMPr.
- Review the Generic EMPr for Substations (GN 435) and confirm if there are any specific environmental sensitivities or attributes present on the site and any resultant site-specific impact management outcomes and actions that need to be included.
- Provide a reasoned opinion indicating the acceptability of the proposed development and a recommendation if the development should go ahead or not.

16.2 Approach and Methodology

The specialist study was completed as follows:

- Task 1: Obtain all relevant data to the proposed projects (i.e. obtain data from NGA and associated groundwater use databases, e.g. WARMS, GEOSS internal database). Obtain any data from local DWS monitoring boreholes. Obtain relevant geological maps and geohydrological maps. Obtain relevant groundwater reports. Compile a project Geographic Information System (GIS).
- Task 2: Complete a site visit and a hydrocensus (i.e. visit boreholes and land owners to obtain information such as yields and to measure the field chemistry to assess the groundwater quality (pH, Electrical Conductivity (EC) and total dissolved solids (TDS)). The representative hydrocensus extends for a radius of 1 km from the study area.
- Task 3: Analyse the data, using geohydrological methods and address the questions raised in the project objectives.
- Task 4: Document the results in a report.

16.2.1 Information Sources

The information sources used in this study are listed in Table 16-1.

Table 16-1: Information sources used to assess the Groundwater for the proposed Kudu Solar Facility project.

Data / Information	Source	Date	Type	Description
Geological Map	Council for Geosciences	1997	Spatial	1:250 000 scale Geological Map Series of 3024 Colesberg
Climatology and Geohydrology	Cape Farm Mapper	2009	Database	SA Atlas of Climatology and Geohydrology; obtained from Western Cape Government Agriculture
Groundwater recharge and vulnerability mapping	Conrad J. and Munch Z.	2007	Spatial	A National scale approach to groundwater recharge and vulnerability mapping
Hydrogeological map series	Department of Water Affairs and Forestry	2005	Spatial	Hydrogeological map series of the republic of South Africa
NGA Database	NGA	14 April 2022	Database and Spatial	Spatial delineation of NGA registered boreholes

16.2.2 Assumptions, Knowledge Gaps and Limitations

The following assumptions and limitations apply:

- A limitation experienced during this investigation was the fact that the area received extensive rainfall prior to and during the site visit. Due to the rain the roads were extremely wet and made progress in the field slow and also difficult. Some farmers did not give GEOSS permission to drive on certain roads on their properties as it would damage the roads and there was a high

risk of the vehicle getting stuck. Despite this, the field work conducted is deemed suitable for the study and meets the objectives of the study.

- The investigation was conducted during the rainfall season of the region. The data, therefore, does not reflect conditions that prevail during the drier portion of the year. It is not expected that this would affect the outcome of the assessment.
- The geohydrological assessment is based on available literature for the study area. This includes regional scale GIS datasets based on 1: 1 000 000.
- No drill records or yield test data exists for production or wind pump boreholes to clarify yields and geological logs.
- The acquisition of accurate groundwater levels proved to be difficult, therefore data was limited to information obtained from local parties. Nonetheless these limitations have not negatively impacted the conclusions of the study.
- The NGA data is available at a local scale, although is known to sometimes contain false information.
- Since the area earmarked for the development of PV 8 falls across the Remaining Extent of the Farm Annex Wolve Kuil No. 41 and Portion 1 (Wolve Kuil West) of the Farm Annex Wolve Kuil No. 41, the water requirement for PV 8 was calculated based on a ratio of 25:75 split between the two mentioned portions.
- Since the area earmarked for the development of PV 1 falls across the Remaining Extent of the Farm Bas Berg No. 88 and Remaining Extent of Portion 3 of the Farm Bas Berg No. 88, the water requirement for PV 1 was calculated based on a ratio of 75:25 split between the two mentioned portions.
- Since the area earmarked for the development of PV 2 falls across the Remaining Extent of the Farm Bas Berg No. 88 and Remaining Extent of Portion 3 of the Farm Bas Berg No. 88, the water requirement for PV 2 was calculated based on a ratio of 50:50 split between the two mentioned portions.
- Since the area earmarked for the development of PV 11 falls across the Portion 1 (Wolve Kuil West) of the Farm Annex Wolve Kuil No. 41 and Portion 2 of the Farm Wolve Kuil No. 43, the water requirement for PV 11 was calculated based on a ratio of 75:25 split between the two mentioned portions.

The information obtained was sufficient to provide comprehensive geohydrological characterization of the regional setting.

It must be noted that there are no areas on site that should be avoided from a groundwater sensitivity perspective.

16.2.3 Consultation Processes Undertaken

During the undertaking of the geohydrological and geotechnical¹ site verification process, all landowners were contacted to ensure that GEOSS was able to locate their boreholes and inspect the landforms across their properties. This was mainly to ensure consent was granted; this was achieved telephonically by Christel Van Staden of GEOSS South Africa.

¹ Note that a separate Geotechnical Assessment is included in Chapter 17 of this EIA Report.

16.3 Description of Project Aspects relevant to Hydrogeological Specialist Study

The Project Applicant intends to source water from the existing boreholes or to drill new boreholes to source groundwater (if available and if suitable) for the construction, operational and decommissioning phases (i.e. general construction use, concrete batching, cleaning of panels, drinking water, and domestic use). As a result, water pipelines may need to be constructed to transfer groundwater from identified waterpoints. Alternatively water may be transported by trucks from the identified water points to the sites (Map 16-2) Groundwater may also need to be stored on site in suitable, closed containers or reservoir tanks during the construction and operational phases. The compliance requirements in terms of the National Water Act (Act 36 of 1998) (NWA) are also assessed in terms of groundwater use. It must be noted that in terms of water supply options, the use of existing boreholes is the third option and drilling of new boreholes is the fourth option. The first option is to source water from the local municipality and the second is to source water from a third party.

Generally, groundwater can be impacted negatively in two manners, namely:

- Over-abstraction (where groundwater abstraction exceeds recharge rates) which can result in the alteration of groundwater flow directions and gradients, as well as quality.
- Quality deterioration (i.e. from anthropogenic activities negatively impacting groundwater quality).

There is currently limited groundwater abstraction taking place in relation to the size of the study area (based on regional datasets). Groundwater use volumes are generally low, and water is mostly used for drinking and livestock watering. The low rainfall and high evapotranspiration rates within the study area are a limiting factor for the recharge of the aquifer underlying the study area.

The groundwater requirement for the project can be met by using the existing boreholes. However, agreements will have to be put in place with the current land owners for the use of groundwater. These agreements will have to be legally valid documents and the necessary endorsements will be required from the DWS.

If no such agreements can be put in place, then additional new boreholes will need to be drilled on the relevant farm portions/developments, followed by complete geohydrological testing and an assessment, including yield and water quality testing, and then authorisation from DWS to use the groundwater will be required, as well as the necessary Environmental Assessment process (if required). This will be undertaken as a separate process, once more detailed information becomes available, outside of the current Application for Environmental Authorisation for the Solar PV Facility and associated infrastructure. This Geohydrology Assessment focuses on the third option, which is the use of existing boreholes within the study area. Some information is provided on the permitting requirements for new boreholes, where possible, but this is not the focus of this assessment.

The proposed project will also entail the development of a Battery Energy Storage System (BESS) at the PV Facility. Lithium Ion and Redox Flow BESS technologies were considered during this EIA Process. With any chemical storage (e.g. for the electrolyte needed for the Redox Flow BESS) there

is always a risk of contamination to soils and groundwater. Additional information is provided in the impact assessment section of this report.

16.4 Baseline Environmental Description

16.4.1 Study Area Definition

The study area for all the proposed Kudu Solar Facilities 1 to 12 is the full extent of the eight affected farm properties on which the proposed PV Facilities will be constructed. The full extent of these properties has been assessed in this study in order to identify environmental sensitivities and no-go areas. The total study area for all the Kudu Solar Facilities 1 to 12 is approximately 8 150 hectares (ha).

At the commencement of this Scoping and EIA Process, the **Original Scoping Buildable Areas** which fall within the study area were identified by the Project Developer following the completion of high-level environmental screening based on the Screening Tool.

Following the identification of sensitivities during the Scoping Phase, the Project Developer considered such sensitivities and formulated the **Revised Scoping Buildable Areas**. The **Revised Scoping Buildable Areas** were used to inform the design of the layout, and further assessed during this EIA Phase of the project in order to identify the preferred development footprint of the proposed project on the approved site as contemplated in the accepted Scoping Report. The development footprint is where the actual development will be located, i.e. the footprint containing the PV solar arrays and associated infrastructure.

16.4.2 General Description

The nearest town to the proposed project is De Aar, approximately 60 km to the southwest. The landscape in the surrounding area is arid, with transported sands occurring widely along plains with dolerite sills (generally northwest of the study area) and mudstone, shale and sandstones (generally southeast of the study area) outcropping in areas of higher elevation. It is understood that the farms in the area are mainly used for livestock farming purposes. The major impact within the area is, therefore, the abstraction of ground water for livestock-focused agriculture.

The receptors that could be impacted due to groundwater abstraction or groundwater quality deterioration are the livestock and occupants on the farms within the study area.

Acceptable levels of change in terms of geohydrology conditions would generally be characterised by small to negligible changes in water table depth up until depth of historic boreholes and small changes in chemistry such that there is no level of deterioration in groundwater quality.

Map 16-2 and Map 16-3 present existing boreholes used for livestock and drinking water on and around the study area with detailed views of the Kudu Solar Facility 1 superimposed on a 1:50 000 topo-cadastral map and aerial image respectively.

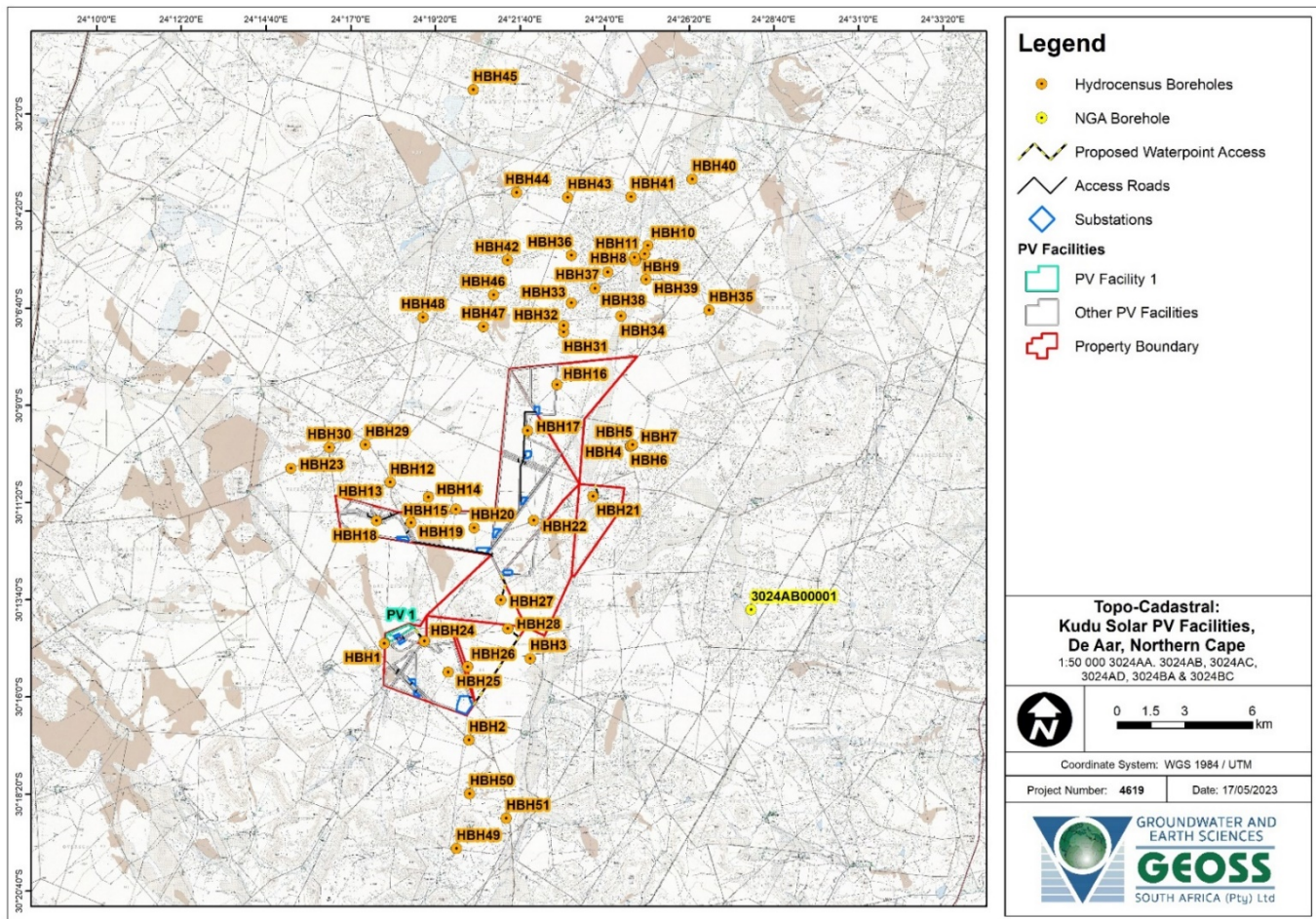

Map 16-2: The study area delineating the study area for the 12 Kudu Solar Facilities, property boundaries, hydrocensus boreholes and the NGA borehole on a 1:50 000 scale topocadastral map (3024AA, 3024AB, 3024AC, 3024AD, 3024BA, 3024BC). Note that this report is focused on Kudu Solar Facility 1.

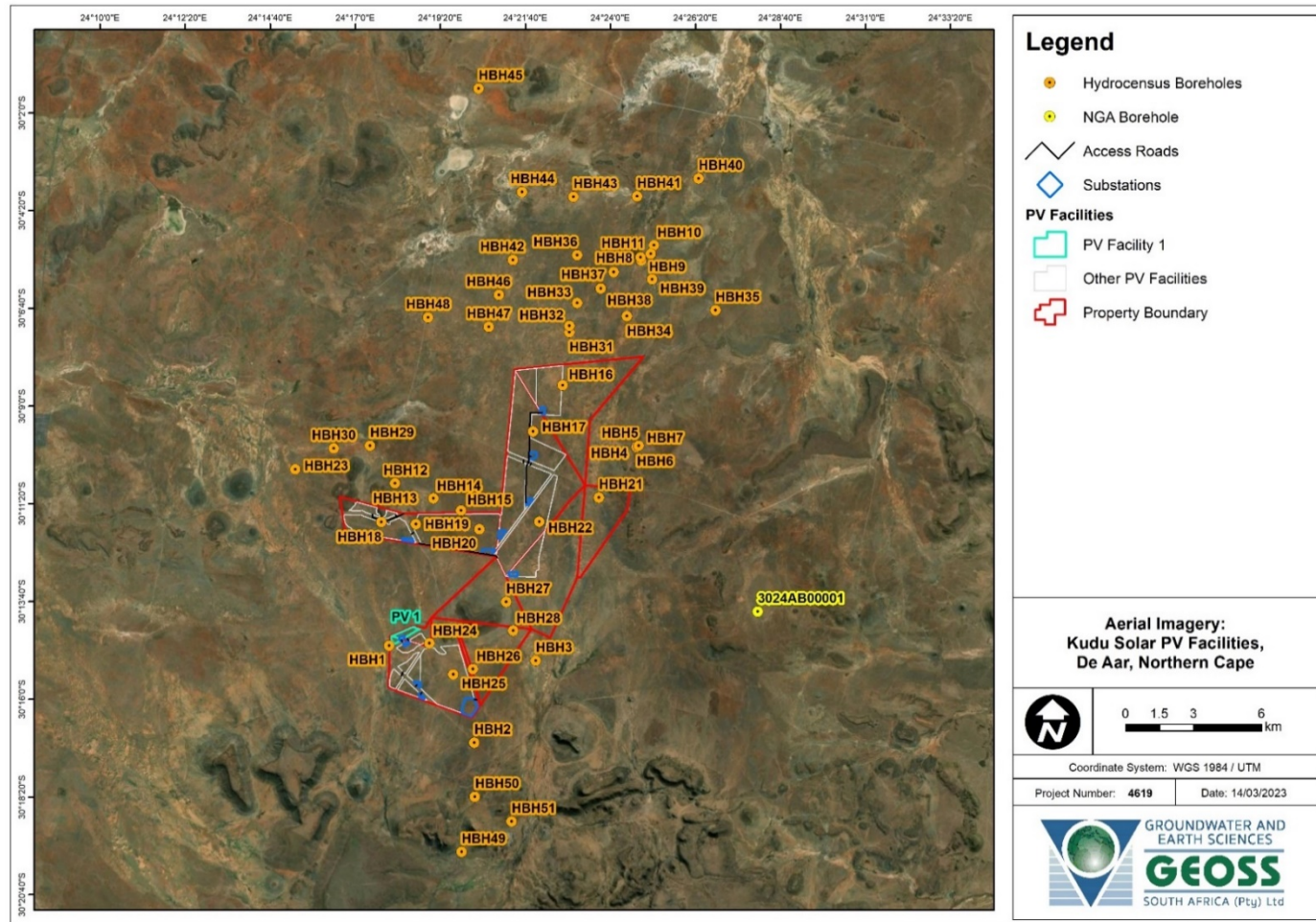

Map 16-3: Aerial view delineating the study area of the 12 Kudu Solar Facilities, hydrocensus boreholes and the NGA borehole. Note that this report is focused on Kudu Solar Facility 1.

16.4.3 Project Specific Description

16.4.3.1 Climate

The study area experiences a semi-arid climate, with most of the rainfall occurring during February to March. Figure 16-1 shows the monthly average minimum and maximum air temperature distribution and Figure 16-2 shows the monthly median rainfall and evaporation distribution for the study area (Schulze, 2009). The long term (1950 – 2000) mean annual precipitation for the study area is 281 mm/a. The rainfall does not exceed evaporation during the course of the year.

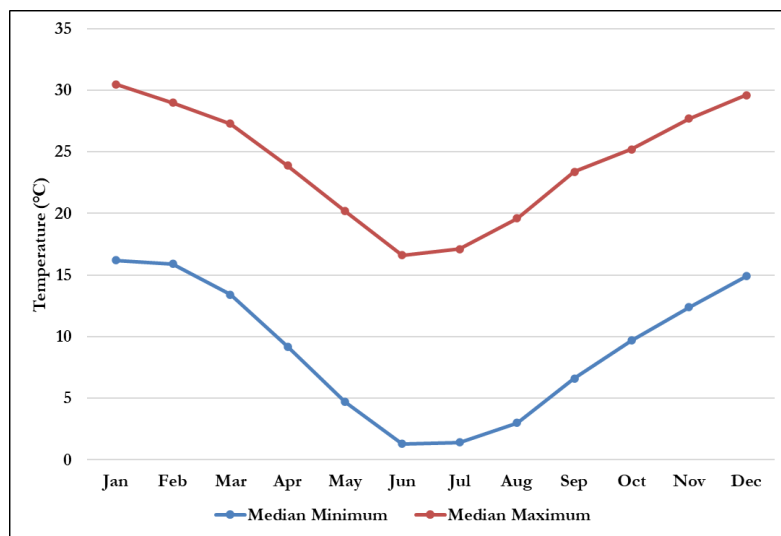

Figure 16-1: Monthly average air temperature for the Kudu Solar Facility study area (Schulze, 2009).

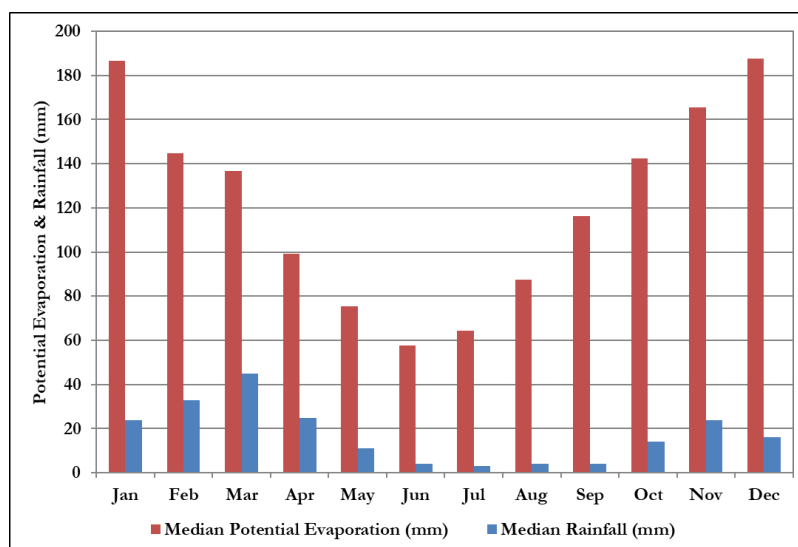



Figure 16-2: Monthly median rainfall and evaporation distribution for the Kudu Solar Facility study area (Schulze, 2009).

16.4.3.2 Regional Geology

The Geological Survey of South Africa (now the Council for Geoscience) has mapped the area at 1:250 000 scale (3024, Colesberg). The geological setting is shown in Map 16-4. The main geology of the area is listed in Table 16-2.

Table 16-2: Geological formations within the study area listed in order of relative age.

Symbol	Formation/Subgroup	Group	Lithology
	Quaternary Deposit		Alluvium / Terrace Gravel
Qc			Calcrete
Jd	Jurassic Intrusion		Dolerite
Pa	Adelaide Subgroup	Beaufort Group	Blue-grey silty mudstone, subordinate brownish-red mudstone; sandstone
Pt	Tierberg Formation	Ecca Group	Blue-grey to black shale with carbonate-rich concretions; subordinate siltstone and sandstone in upper part

The Kudu Solar Facility 1 is mainly underlain by Quaternary alluvium deposits and well-developed calcretes. These quaternary deposits, in turn, overly either dolerite sills and dykes, (Jd) or undifferentiated sediments of the Adelaide Subgroup (Pa) and/or Tierberg Formation (Pt). The Adelaide Subgroup (Pa) comprises interbedded mudstones, siltstones and sandstone, whilst the Tierberg Formation (Pt) consists primarily of shale and sandstone. Both of these units were deposited within a braided river to deltaic setting within the Karoo basin during the Permian Period some 268 to 247 Million years ago (Johnson et al., 2006). These sediments were subsequently intruded during the Jurassic Period by dolerite sills and dykes of the Karoo Dolerite Suite. There are no known large structural geological features in the surrounding area of the proposed project; however, the dolerite sills in the area commonly show extensive jointing as a result of cooling and exhumation (Senger et al., 2015).

16.4.3.3 Regional Hydrogeology

The regional aquifer directly underlying the proposed project study area is classified by the Department of Water Affairs and Forestry (DWAf) (DWAf, 2005) as a fractured aquifer with an average yield potential of 0.5 – 2.0 L/s (Map 16-5). A fractured aquifer describes an aquifer where groundwater only occurs in narrow fractures within the bedrock. However, based on the geological map and the site-specific information it is known that the Quaternary deposits of alluvium and calcrete form an intergranular aquifer on top of the fractured bedrock. There is no known information about this aquifer. An intergranular aquifer is a primary aquifer and is described as an aquifer in which groundwater is stored within, and flows through open pore spaces in the unconsolidated Quaternary deposits.

Based on the DWAf (2005) mapping of the regional groundwater quality, as indicated by electrical conductivity (EC), the groundwater underlying the Kudu Solar Facility and the surrounding area is in the range of 70 – 300 mS/m. This is considered to be “good to marginal” quality for water (Map 16-6) with respect to drinking water standards.

Both these classifications are based on regional datasets, and therefore only provide an indication of conditions to be expected.

According to research done by Harkness et al. (2018), there is evidence in the southern portion of the Karoo basin that there are several variable aged sources of ground water at different depths. They found that the deeper groundwater was typically more saline, older according to isotope data, and had chemical signatures indicating both ancient meteoric and marine sources. Although separated by confining fine grained units throughout, fracture and joint sets within dolerite sills and dykes potentially act as a conduit for mixing between younger freshwater, and ancient saline aquifers.

16.4.3.4 Aquifer Vulnerability (DRASTIC)

Based on the regional datasets the proposed project overlies a fractured aquifer that possesses water bearing properties due to fracturing. Several methods have been developed to classify an aquifer's vulnerability with The DRASTIC method being applied to this study.

Groundwater vulnerability can be defined as the "tendency for contaminants to reach a specified position in the groundwater system after introduction at some location" (Vrba and Zaporozec, 1994). Key physical parameters which determine groundwater vulnerability include lithology, thickness, effective porosity, groundwater flow direction, age and residence time of water. Generally, the residence time of contaminants in groundwater and the distance that it travels in the aquifer are considered important measures of vulnerability.

There are two main groups of methods for assessing groundwater vulnerability, namely:

- Index or subjective rating methods, and
- Statistical or process-based methods.

The "index or subjective rating method" is relatively easily addressed within a GIS framework. The cell-based layer approach facilitates the assignment of ratings and weights, and rapid achievement of a final result of relative groundwater vulnerability. This approach also means that the algorithm can easily be repeated as new or more detailed data sets are obtained or if ratings and weightings need to be adjusted as a result of a sensitivity analysis for example. The most well-known "index or subjective rating method" is the "DRASTIC" method (Aller et al., 1987). The DRASTIC method of Aller et al. (1987) uses the typical overlay technique often applied in subjective rating methods. The DRASTIC approach is based on four major assumptions:

- The contaminant is introduced at ground surface;
- The contaminant is flushed into the groundwater by precipitation;
- The contaminant has the mobility of water; and
- The area evaluated using DRASTIC is 40.5 ha or larger.

The implication of these assumptions is that DRASTIC should not be used for contaminants that do not have the mobility of water or for point assessment (such as storage tanks). In addition, groundwater conditions in South Africa are dominated by secondary/fracture-controlled flow conditions. The DRASTIC method does not consider local preferential flow paths of fractured aquifer systems particularly well. The DRASTIC method takes into account the following factors:

D	=	depth to groundwater	(9)
R	=	recharge	(8)
A	=	aquifer media	(8)
S	=	soil type	(4-5)
T	=	topography	(10)
I	=	impact of the vadose zone	(9)
C	=	conductivity (hydraulic)	(6)

The number indicated in parenthesis at the end of each factor description is the weighting or relative importance at that factor.

Groundwater vulnerability maps developed using the DRASTIC method have been produced in many parts of the world. In spite of the widespread use of DRASTIC, the effectiveness of the method has been met with mixed success due to hydrogeological heterogeneity and the many assumptions that need to be made in determining groundwater vulnerability. In addition, the use of a generic vulnerability map only gives a broad indication of relative vulnerability and in many instances detailed scale, contaminant specific vulnerability assessments are required.

As part of the Groundwater Resources Assessment Project (DWAF, 2005), numerous data sets were produced and this enabled the mapping of groundwater vulnerability at the national scale on a 1 km by 1 km cell (pixel) size basis (Conrad and Munch, 2007). This national scale map indicates the relative vulnerability of groundwater resources throughout the country and provides project planners a clear idea of what level of groundwater protection is required.

The groundwater vulnerability for the study area is shown in Map 16-7. The development area for the Kudu Solar Facility 1 has a **Low to Medium** groundwater vulnerability. It is assumed that the regional data maps relate to the underlying fractured aquifer and not the intergranular aquifer. The intergranular aquifer on top of the fractured aquifer has no protection and therefore any contamination that is introduced on the surface of the intergranular aquifer will infiltrate into the subsurface and can cause contamination of the intergranular aquifer. Therefore, the vulnerability specifically for the intergranular aquifer is considered to be **medium**.

16.4.4 Site Specific and Existing Groundwater Information

16.4.4.1 NGA Database

A desktop assessment was initially carried out within and around the study area to determine if there were any groundwater users in the area. The NGA database provides data on borehole positions, groundwater chemistry and yield, where available. The NGA indicated there is one borehole surrounding the study area (Map 16-2 and Map 16-3). The NGA site is summarized in Table 16-3.