

Prepared for:
ABO Wind Renewable
Energies (Pty) Ltd



Scoping and Environmental Impact Assessment (EIA) Process
for the
PROPOSED DEVELOPMENT OF A SOLAR PHOTOVOLTAIC (PV)
FACILITY (KUDU SOLAR FACILITY 2) AND ASSOCIATED
INFRASTRUCTURE, NEAR DE AAR, NORTHERN CAPE PROVINCE

FEBRUARY 2023



FINAL
SCOPING
REPORT

Prepared by:
Council for Scientific and
Industrial Research (CSIR)



PART A: MAIN REPORT



SCOPING AND ENVIRONMENTAL IMPACT ASSESSMENT

for the

**Proposed Development of a Solar Photovoltaic (PV)
Facility (Kudu Solar Facility 2) and associated
infrastructure, near De Aar, Northern Cape Province**

FINAL SCOPING REPORT

February 2023

Prepared for:

ABO Wind renewable energies (Pty) Ltd

Prepared by:

Council for Scientific and Industrial Research (CSIR)

P. O. Box 320, Stellenbosch, 7599
Tel: 021 888 2400

P. O. Box 59081, Umbilo, 4075
Tel: 031 242 2300

Lead Authors:

Paul Lochner, Rohaida Abed, and Helen Antonopoulos (CSIR)

Specialists:

Johann Lanz, Corné Niemandt, Samuel Laurence, Antonia Belcher, Dana Grobler, Chris van Rooyen, Albert Froneman, Quinton Lawson, Bernard Oberholzer, Dr. Jayson Orton, Dr. John Almond, Tony Barbour, Annebet Krige, Debbie Mitchell, Shane Teek, Dale Barrow, Michael Baleta, Julian Conrad, and Christel van Staden

Mapping:

Luanita Snyman-Van der Walt (CSIR)

Formatting and Desktop Publishing:

Magdel van der Merwe (DTP Solutions)

© CSIR 2023. All rights to the intellectual property and/or contents of this document remain vested in the CSIR. This document is issued for the sole purpose for which it is supplied. No part of this publication may be reproduced, stored in a retrieval system or transmitted, in any form or by means electronic, mechanical, photocopying, recording or otherwise without the express written permission of the CSIR. It may also not be lent, resold, hired out or otherwise disposed of by way of trade in any form of binding or cover than that in which it is published.

REPORT DETAILS

Title:	Scoping and Environmental Impact Assessment (EIA) Process for the proposed development of a Solar Photovoltaic (PV) Facility (Kudu Solar Facility 2) and associated infrastructure, near De Aar in the Northern Cape Province: FINAL SCOPING REPORT			
Purpose of this report:	<p>The purpose of this Final Scoping Report is to:</p> <ul style="list-style-type: none"> ▪ Present the details of and the need for the proposed project; ▪ Describe the affected environment at a sufficient level of detail based on scoping level specialist input to facilitate informed decision-making; ▪ Provide an overview of the Scoping Process that has been followed, including public consultation; ▪ Provide an overview of the potential positive and negative impacts of the proposed project on the environment; ▪ Provide recommendations to avoid or mitigate negative impacts and to enhance the positive benefits of the project (based on a high-level); and ▪ Provide the Plan of Study for the EIA Phase for the proposed project. <p>The Draft Scoping Report was made available to all Interested and/or Affected Parties (I&APs), Organs of State and relevant stakeholders for a 30-day review period extending from 9 December 2022 to 30 January 2023, excluding public holidays and the regulated shutdown period. All comments submitted during the 30-day review period has been incorporated in a Comments and Responses Report, and addressed, as applicable and where relevant, and is included as an appendix to this Final Scoping Report. The Final Scoping Report is being submitted to the National Department of Forestry, Fisheries and the Environment (DFFE) for decision-making.</p>			
Prepared for:	ABO Wind renewable energies (Pty) Ltd			
Prepared by:	<p>Contact Persons:</p> <table border="1"> <tr> <td>Du Toit Malherbe Phone: 021 276 3620 Email: capetown@abo-wind.com</td> <td>Petrus Scheepers Phone: 021 276 3620 Email: capetown@abo-wind.com</td> </tr> </table>		Du Toit Malherbe Phone: 021 276 3620 Email: capetown@abo-wind.com	Petrus Scheepers Phone: 021 276 3620 Email: capetown@abo-wind.com
Du Toit Malherbe Phone: 021 276 3620 Email: capetown@abo-wind.com	Petrus Scheepers Phone: 021 276 3620 Email: capetown@abo-wind.com			
Lead Authors:	Paul Lochner, Rohaida Abed, and Helen Antonopoulos (CSIR)			
Mapping:	Luanita Snyman-Van der Walt (CSIR)			
Specialists:	Johann Lanz, Corné Niemandt, Samuel Laurence, Antonia Belcher, Dana Grobler, Chris van Rooyen, Albert Froneman, Quinton Lawson, Bernard Oberholzer, Dr. Jayson Orton, Dr. John Almond, Tony Barbour, Annebet Krige, Debbie Mitchell, Shane Teek, Dale Barrow, Michael Baleta, Julian Conrad, and Christel van Staden			
Formatting and Desktop Publishing:	Magdel van der Merwe, DTP Solutions			
Date:	February 2023			
DFFE Reference No:	14/12/16/3/3/2/2245			
To be cited as:	CSIR, 2023. Scoping and Environmental Impact Assessment (EIA) Process for the proposed development of a Solar Photovoltaic (PV) Facility (Kudu Solar Facility 2) and associated infrastructure, near De Aar in the Northern Cape Province. Final Scoping Report. CSIR Report Number: CSIR/SPLA/SECO/ER/2022/0052/B			

CONTENTS

PART A: MAIN REPORT

Executive Summary

Chapter 1	Introduction
Chapter 2	Project Description
Chapter 3	Description of the Affected Environment
Chapter 4	Approach to EIA Process and Public Participation
Chapter 5	Project Alternatives
Chapter 6	Issues and Potential Impacts
Chapter 7	Plan of Study for EIA

PART B: APPENDICES

Appendix A	Curriculum Vitae of the Environmental Assessment Practitioners
Appendix B	Declaration of Independence of the Environmental Assessment Practitioner
Appendix C	Maps
Appendix D	Database of Interested and/or Affected Parties
Appendix E	Public Participation
Appendix F	Pre-Consultation with the Competent Authority
Appendix G	Scoping Level Specialist Assessments and Inputs
Appendix H	Additional Information

Key Changes made from the DRAFT Scoping Report that was issued for I&AP, Stakeholder and Organ of State Review from 9 December 2022 to 30 January 2023

Key change description	Change made – Yes (denoted by ✓) or N/A (denoted by ■)															
	Summary	Chapters							Appendices							
		1	2	3	4	5	6	7	A	B	C	D	E	F	G	H
The term “Draft Scoping Report” has been updated to “Final Scoping Report”, where applicable	✓	✓	✓	✓	✓	✓	✓	✓	■	■	■	✓	✓	■	✓	■
Clarification on the reasoning for the National Department of Forestry, Fisheries and the Environment (DFFE) serving as the Competent Authority	✓	✓	■	■	■	■	■	■	■	■	■	✓	■	■	■	■
Renewable Energy Independent Power Producer Programme (REIPPPP) has been mentioned in the Need and Desirability	■	✓	■	■	■	■	■	■	■	■	■	■	■	■	■	■
Screening Tool Reports generated for each specific project and including the compiler signature.	■	■	■	■	✓	■	■	■	■	■	■	■	■	■	■	✓
Improved certainty on the applicability of relevant listed activities and project description details, where possible (i.e. Redox Flow Battery maintained for Activity 14 of Listing Notice 1, lengthening of roads falling below thresholds for relevant listed activities, and Activity 12 of Listing Notice 3 removed)	✓	✓	✓	■	✓	■	■	■	■	■	■	■	■	■	■	■
Confirmation from the Northern Cape Department of Agriculture, Environmental Affairs, Rural Development and Land Reform (DAEARDLR) that the Northern Cape Critical Biodiversity Areas Map (2016) constitutes a systematic biodiversity plan adopted by the Competent Authority, and therefore the relevant listed activities from Listing Notice 3 apply. Feedback provided accordingly in the report.	■	■	■	■	✓	✓	■	■	■	■	■	■	✓	■	■	■
Provision for the internal reticulation within the Solar Facility (22 or 33 kV) to also be aboveground, in isolated events.	✓	✓	✓	■	■	■	■	■	■	■	■	■	■	■	■	■
Confirmation of inclusion of the Independent Power Producer (IPP) Substation within the current Application for Environmental Authorisation (EA), with an update on the applicability of Activity 11 of Listing Notice 1	■	✓	✓	■	✓	■	■	✓	■	■	■	■	✓	■	■	■
Clarification that the terms “site” and “study area” are used synonymously in the report; and that the Original and Revised Scoping Buildable Areas serve as the “development footprint” and fall within the preferred site / study area. Clarification included on the evolution of the how the development footprints have been identified.	✓	✓	✓	✓	✓	✓	■	■	■	■	■	■	■	■	■	■

SCOPING REPORT: Scoping and Environmental Impact Assessment (EIA) Process for the Proposed Development of a Solar Photovoltaic (PV) Facility (Kudu Solar Facility 2) and associated infrastructure, near De Aar, Northern Cape Province

Key change description	Change made – Yes (denoted by ✓) or N/A (denoted by)															
	Chapters								Appendices							
	Summary	1	2	3	4	5	6	7	A	B	C	D	E	F	G	H
Highlighting that both battery technologies will be assessed during the EIA Phase			✓		✓	✓										
Preliminary combined environmental feature map and preliminary combined environmental sensitivity map for the study area updated to include clearer buffers.				✓							✓					
Updated layout and sensitivity maps and provided separate layout maps per project to include as many of the features requested by the DFFE.								✓			✓					
Updated with additional information regarding the status and progress made on the Scoping Process, the submission of the Application for EA to the DFFE, as well as DFFE's acknowledgment of receipt, and the assignment of reference numbers for the projects. Updated with Case Numbers and correspondence made with SAHRA. Updated with details of the Public Participation Process undertaken thus far.					✓								✓			
Added proof of placement of the newspaper advertisements, correspondence and proof of correspondence sent to stakeholders for the Draft Scoping Report release; proof of submission of the DSR and Application Form to the DFFE; comments received from stakeholders during the 30-day review of the DSR; and Comments and Responses Trail (Specifically Appendix E.7 to E.11).													✓			
Updated the database of I&APs, Stakeholders and Organs of State to reflect stages of consultation, commenting, as well as additions to the database.																

Note from the CSIR: If sections are not mentioned in the above table, this means that either there have been no changes or no major changes to these sections.

EXECUTIVE SUMMARY

INTRODUCTION AND PROJECT LOCALITY

The Project Developer, ABO Wind renewable energies (Pty) Ltd (hereafter “ABO Wind”) is proposing to develop 12 Solar Photovoltaic (PV) power generation facilities and associated Electrical Grid Infrastructure (EGI), north-east of the town of De Aar in the Renosterberg Local Municipality and Pixley Ka Seme District Municipality, in the Northern Cape Province. The proposed projects are located approximately 50 km from De Aar and 25 km from Petrusville. A locality map is provided in Figure A. The proposed projects are referred to as the “Kudu project”.

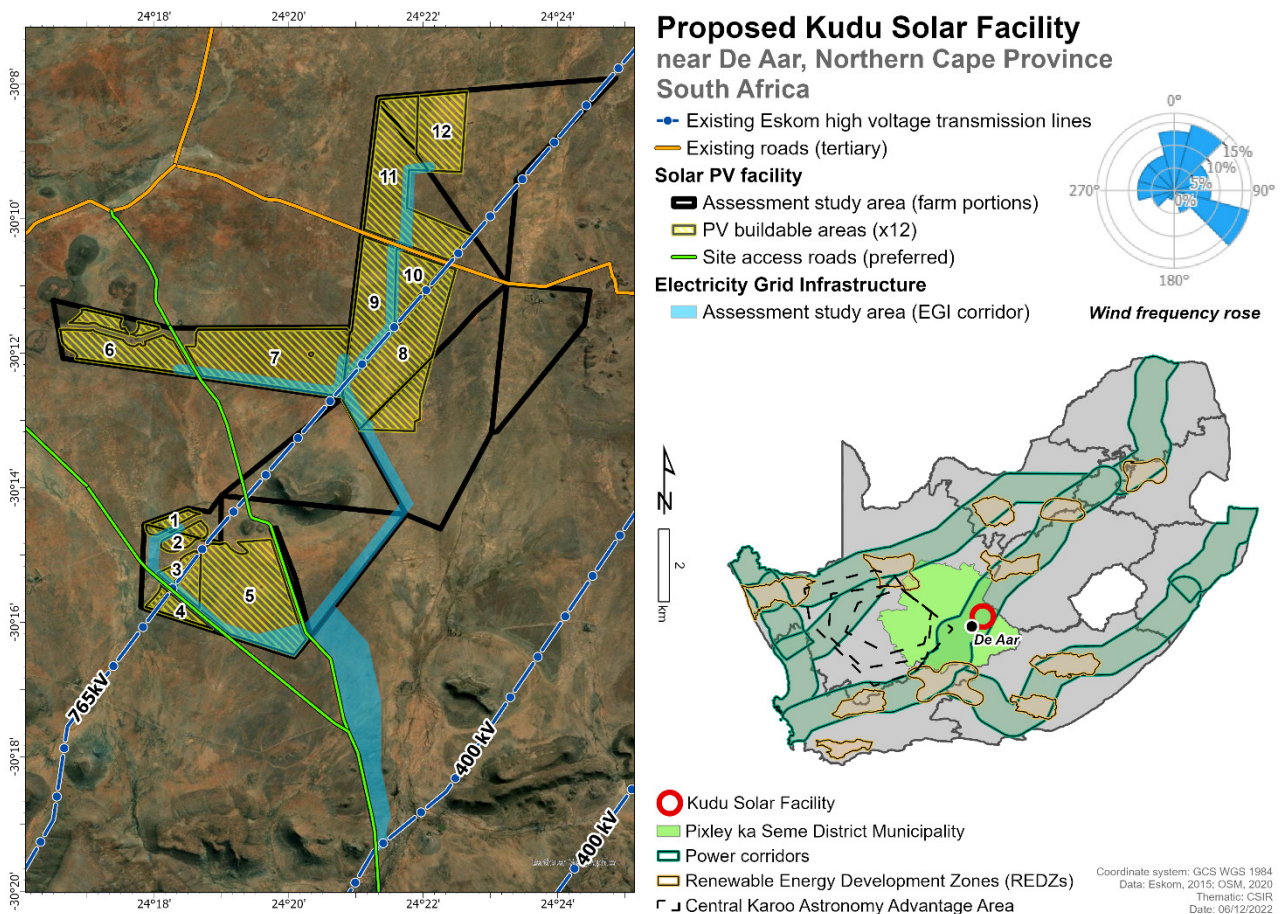

Figure A. Locality Map of the proposed Kudu Projects. Note that the EGI Projects are not part of the current application and report. The EGI Projects will be considered separately at a later stage. The EGI corridor indicated in this Figure is indicative.

The proposed Solar PV Facilities will make use of PV solar technology to generate electricity from energy derived from the sun. Each solar PV Facility will have a range of associated infrastructure, including, but not limited to, an on-site substation complex, Battery Energy Storage System (BESS), and is proposed to connect to the existing Hydra-Perseus 400 kV overhead power line via dedicated proposed 132 kV power lines, an independent Main Transmission Substation (MTS), and a 400 kV Loop-In-Loop-Out (LILO).

Each of the Solar PV Facilities would be its own project and would require its own, separate Environmental Authorisation (EA). The same applies to the EGI projects. Each project will have a specific Project Applicant. The following projects are being proposed (illustrated in Figure B):

- **PROJECTS 1 TO 12:** The proposed development of 12 Solar PV Facilities and associated infrastructure (i.e. Kudu Solar Facility 1 to Kudu Solar Facility 12¹).
- **PROJECTS 13 TO 24:** The proposed development of switching stations and collector stations at each on-site substation complex at each of the 12 Kudu Solar Facilities, and up to 12 x 132 kV overhead power lines running from each Solar PV Facility to the proposed collector stations or up to the proposed MTS.
- **PROJECT 25:** The proposed development of an independent 400/132 kV MTS, including associated infrastructure at the MTS.
- **PROJECT 26:** The proposed development of a 400 kV LILO from the existing Hydra-Perseus 400 kV overhead power line to the proposed MTS.

Scoping and EIA Processes x 12		BA Processes x 12 or Standard Registration Processes x 12 or hybrid approach		
Project 1: Kudu Solar Facility 1	Project 7: Kudu Solar Facility 7	Project 13: Switching Station, Collector Station, 132 kV Power Line for Kudu Solar 1	Project 19: Switching Station, Collector Station, 132 kV Power Line for Kudu Solar 7	Project 25: Independent 400/132 kV MTS and associated infrastructure
Project 2: Kudu Solar Facility 2	Project 8: Kudu Solar Facility 8	Project 14: Switching Station, Collector Station, 132 kV Power Line for Kudu Solar 2	Project 20: Switching Station, Collector Station, 132 kV Power Line for Kudu Solar 8	Project 26: 400 kV Loop-In-Loop-Out (LILO) from the existing Hydra-Perseus 400 kV line to the proposed MTS
Project 3: Kudu Solar Facility 3	Project 9: Kudu Solar Facility 9	Project 15: Switching Station, Collector Station, 132 kV Power Line for Kudu Solar 3	Project 21: Switching Station, Collector Station, 132 kV Power Line for Kudu Solar 9	
Project 4: Kudu Solar Facility 4	Project 10: Kudu Solar Facility 10	Project 16: Switching Station, Collector Station, 132 kV Power Line for Kudu Solar 4	Project 22: Switching Station, Collector Station, 132 kV Power Line for Kudu Solar 10	
Project 5: Kudu Solar Facility 5	Project 11: Kudu Solar Facility 11	Project 17: Switching Station, Collector Station, 132 kV Power Line for Kudu Solar 5	Project 23: Switching Station, Collector Station, 132 kV Power Line for Kudu Solar 11	
Project 6: Kudu Solar Facility 6	Project 12: Kudu Solar Facility 12	Project 18: Switching Station, Collector Station, 132 kV Power Line for Kudu Solar 6	Project 24: Switching Station, Collector Station, 132 kV Power Line for Kudu Solar 12	

Figure B: Breakdown of the projects that comprise the Kudu Solar Facilities and EGI cluster.

¹ Note that throughout the report the term Solar Facility and PV are used synonymously. For example, Kudu Solar Facility 1 and Kudu PV1 are used interchangeably.

Projects 1 to 12 require Scoping and Environmental Impact Assessment (EIA) Processes in terms of the 2014 National Environmental Management Act (Act 107 of 1998, as amended) (NEMA) EIA Regulations (as amended). Projects 13 to 26 will require Basic Assessment (BA) Processes or will be subjected to separate registration processes in terms of the EGI Standard (Government Gazette (GG) 47095; Government Notice (GN) 2313, dated 27 July 2022), or may require a hybrid approach depending on the sensitivities found within the EGI corridor.

This Scoping Report only addresses Kudu Solar Facility 2 (i.e. Project 2) (hereafter referred to as the “Kudu Solar Facility” or “proposed project”), and separate reports have been compiled for each of the Solar PV Facilities (i.e. Projects 1 to 12).

The Draft Scoping Report was released to all Interested and/or Affected Parties (I&APs), Organs of State and relevant stakeholders for a 30-day review period, extending from 9 December 2022 to 30 January 2023. All comments received during the 30-day review have been incorporated into a detailed Comments and Responses Report, and addressed, as applicable and where relevant, and has been included as Appendix E.11 of this Final Scoping Report. The Final Scoping Report is being submitted to the DFFE, in accordance with Regulation 21 (1) of the 2014 NEMA EIA Regulations (as amended), for decision-making.

Note that separate reporting will also be followed for Projects 13 to 26 based on the relevant environmental management instrument implemented at the time. Projects 13 to 26 are not the subject of this current Scoping Report.

The proposed project is not located within any of the Renewable Energy Development Zones (REDZs) that were gazetted in GG 41445, GN 114 on 16 February 2018; and GG 44191, GN 144 on 26 February 2021, hence it is subjected to a full Scoping and EIA Process with a 107-day decision-making timeframe, as opposed to a BA Process and 57-day decision-making timeframe allowed for in the REDZs. The proposed project is located within the Central Strategic Transmission Corridor that was gazetted in GN 113 on 16 February 2018; however, the benefits only apply specifically to the EGI projects (Projects 13 – 26). This is depicted in Figure A.

The Competent Authority for this proposed project is the National Department of Forestry, Fisheries and the Environment (DFFE), and the Project Applicant is Kudu Solar Facility 2 (Pty) Ltd. The Competent Authority determination is based on Section 24C (2) (a) (i) of NEMA which deals with activities that have implications for international environmental commitments or relations, and where it is identified by the Minister by notice in the Gazette. In this regard, GG 40110, GN 779, dated 1 July 2016, stipulates that the Minister of Environmental Affairs (now Forestry, Fisheries and the Environment) is the Competent Authority for the consideration and processing of EAs and amendments thereto for activities related to the Integrated Resource Plan (IRP) 2010 – 2030, and any updates thereto. It is intended that this project will be bid into a future bidding program of the Renewable Energy Independent Power Producer Programme (REIPPPP) [or another future process linked to the IRP].

An integrated Public Participation Process is being undertaken for the proposed projects.

Study Area and Buildable Areas

The study area or preferred site for all 12 of the Kudu Solar Facilities constitutes the full extent of the eight affected farm portions indicated in Table A. The total extent of the study area is approximately 8 150 hectares (ha). The preferred site serves as the study area for this Scoping and EIA Process. Therefore, the terms “site” and “study area” are used synonymously in this report.

Table A: Farm portions and SG codes for the Study Area

FARM PORTION	SG CODE
Remaining Extent of the Farm Bas Berg No. 88	C05700000000008800000
Remaining Extent of Portion 3 of the Farm Bas Berg No. 88	C05700000000008800003
Portion 4 (Portion of Portion 3) of the Farm Bas Berg No. 88	C05700000000008800004
Remaining Extent of Portion 2 (Middel Plaats) (a Portion of Portion 1) of the Farm Grasspan No. 40	C05700000000004000002
Remaining Extent of the Farm Annex Wolve Kuil No. 41	C05700000000004100000
Portion 1 (Wolve Kuil West) of the Farm Annex Wolve Kuil No. 41	C05700000000004100001
Portion 2 of the Farm Wolve Kuil No. 43	C05700000000004300002
Remaining Extent of the Farm Wolve Kuilen No. 42	C05700000000004200000

Initially, the Project Developer identified the Original Scoping Buildable Areas within the study area / preferred site, and these contained up to 14 Solar PV Facilities (as noted in the Background Information Document). As part of the Scoping and EIA Process, specialists were commissioned to assess the full extent of the study area / preferred site in order to identify environmental sensitivities and no-go areas, and also comment on and consider the Original Scoping Buildable Areas. The Scoping Buildable Areas serve as the “development footprints” for the 12 proposed PV facilities and fall within the preferred site / study area.

Following the identification of sensitivities during the Scoping Phase, as well as various considerations such as the capacities of the Bidding Window 6 and the requirements of landowners, the Project Developer took such sensitivities and considerations into account and formulated the Revised Scoping Buildable Areas or development footprints, which resulted in up to 12 Solar PV Facilities (Figure A). The Revised Scoping Buildable Areas or development footprints will be used to inform the design of the layout and will be further assessed during the EIA Phase. Overall, the entire site / study area, and thus all identified buildable areas / development footprints were assessed by the specialists.

PROJECT ENVIRONMENTAL IMPACT ASSESSMENT TEAM

In accordance with Regulation 12 (1) of the 2014 NEMA EIA Regulations (as amended), ABO Wind has appointed the Council for Scientific and Industrial Research (CSIR) to undertake the required Scoping and EIA Process in order to determine the potential biophysical, social and economic impacts associated with undertaking the proposed development. The project team and the relevant specialists are indicated in Table B below.

Table B. Project Team for the Scoping and EIA Process

NAME	ORGANISATION	ROLE/STUDY TO BE UNDERTAKEN
<i>Environmental Management Services (CSIR)</i>		
Paul Lochner (<i>Registered EAP (2019/745)</i>)	CSIR	EAP, Technical Advisor and Quality Assurance
Rohaida Abed (<i>Pr.Sci.Nat. and Registered EAP (2021/4067)</i>)	CSIR	EAP and Project Manager
Helen Antonopoulos	CSIR	Project Officer
Luanita Snyman van der Walt (<i>Pr.Sci.Nat.</i>)	CSIR	GIS Specialist
Lizande Kellerman (<i>Pr.Sci.Nat.</i>)	CSIR	Public Participation Specialist
<i>Specialists</i>		
Johann Lanz (<i>Pr.Sci.Nat.</i>)	Private	Agriculture and Soils Compliance Statement
Corne Niemandt (<i>Pr.Sci.Nat.</i>) Samuel Laurence (<i>Pr.Sci.Nat.</i>)	Enviro-Insight cc	Terrestrial Biodiversity, Terrestrial Plant Species, and Terrestrial Animal Species
Toni Belcher (<i>Pr.Sci.Nat.</i>) Dana Grobler (<i>Pr.Sci.Nat.</i>)	Private	Aquatic Biodiversity Impact Assessment
Chris van Rooyen Albert Froneman (<i>Pr.Sci.Nat.</i>)	Chris van Rooyen Consulting	Avifauna Impact Assessment
Quinton Lawson (<i>SACAP, 3686</i>) Bernard Oberholzer (<i>SACLAP, 87018</i>)	QARC and BOLA	Visual Impact Assessment
Dr Jayson Orton (<i>APHP: Member 43; ASAPA CRM Section: Member 233</i>)	ASHA Consulting (Pty) Ltd	Heritage Impact Assessment (Archaeology and Cultural Landscape)
Dr John Almond (<i>PSSA and APHP Member</i>)	Natura Viva cc	Palaeontology Site Sensitivity Verification Report
Tony Barbour	Private	Socio-Economic Impact Assessment
Annebet Krige (<i>Pr Eng</i>)	Sturgeon Consulting	Traffic Impact Assessment
Debbie Mitchell (<i>Pr Eng</i>)	Ishecon cc	Battery Storage High Level Safety, Health and Environment Risk Assessment
Dale Barrow (<i>Pr.Sci.Nat.</i>) Christel van Staden (<i>Cand.Sci.Nat.</i>) Shane Teek (<i>Cand.Sci.Nat.</i>) Julian Conrad	GEOSS South Africa (PTY) Ltd	Geohydrology Assessment
Shane Teek (<i>Cand.Sci.Nat.</i>) Michael Baleta (<i>Pr.Sci.Nat.</i>) Julian Conrad	GEOSS South Africa (PTY) Ltd	Geotechnical Assessment
Rohaida Abed (<i>Pr.Sci.Nat. and Registered EAP (2021/4067)</i>) Helen Antonopoulos Lizande Kellerman (<i>Pr.Sci.Nat.</i>)	CSIR	Civil Aviation Site Sensitivity Verification
Rohaida Abed (<i>Pr.Sci.Nat. and Registered EAP (2021/4067)</i>) Helen Antonopoulos Lizande Kellerman (<i>Pr.Sci.Nat.</i>)	CSIR	Defence Site Sensitivity Verification

The specialist assessments will be detailed during the EIA Phase and will comply with Appendix 6 of the 2014 NEMA EIA Regulations (as amended), or the Assessment Protocols published in GN 320 on March 2020; or the Assessment Protocols published in GN 1150 on October 2020. However, the BESS High Level Safety, Health and Environment Risk Assessment serves as a technical report and the aforementioned legislation will thus not be applicable.

PROJECT DESCRIPTION

It is important to point out at the outset that the exact specifications of the proposed project components will be determined during the detailed design and engineering phase prior to construction (subsequent to the issuing of EA, should it be granted for the proposed project). A summary of the key components of the proposed project is provided in Table C below.

Table C. Summary of the proposed project components and associated infrastructure

COMPONENT	DESCRIPTION
<i>Solar Field</i>	
Type of Technology	Solar Photovoltaic (PV) Technology
Generation Capacity (Maximum Installed)	<ul style="list-style-type: none"> ▪ 50 MWac
Total developable area that includes all associated infrastructure within the fenced off area of the PV facility	<p><u>Revised Scoping Buildable Areas:</u></p> <ul style="list-style-type: none"> ▪ 48 ha
PV Panel Structure (with the following possible tracking and mounting systems): <ul style="list-style-type: none"> ▪ Single Axis Tracking structures (aligned north-south); ▪ Dual Axis Tracking (aligned east-west and north-south); ▪ Fixed Tilt Mounting Structure; ▪ Mono-facial Solar Modules; or ▪ Bifacial Solar Modules. 	<ul style="list-style-type: none"> ▪ <u>Height:</u> Approximately 3.5 m (maximum)
<i>Building Infrastructure</i>	
Auxiliary Buildings	<ul style="list-style-type: none"> ▪ <u>Type:</u> These include, but are not limited to, Operation and Maintenance (O&M) building and control centre, site office, workshop, staff lockers, bathrooms/ablutions, warehouses, guard houses, etc. ▪ <u>Cumulative Footprint:</u> Approximately up to 5000 m² ▪ <u>Height:</u> Up to 10 m
Inverter/Transformer Stations	<ul style="list-style-type: none"> ▪ <u>Preliminary average number of stations:</u> 27 ▪ <u>Height:</u> Approximately 3 m ▪ <u>Footprint:</u> Approximately 220 m² each
On-site Substation Complex	<ul style="list-style-type: none"> ▪ <u>Components of the on-site substation complex:</u> <ul style="list-style-type: none"> ○ On-site Independent Power Producer (IPP) or Facility Substation (~1 ha). ○ Lithium Ion or Redox Flow Battery Energy Storage System. Refer to the details below. ○ Switching Station and Collector Station (~2 ha). This forms part of Projects 13 – 24 and will be assessed as part of separate processes. ▪ <u>Footprint of the on-site substation complex:</u> Up to approximately 4 ha ▪ <u>Height of the on-site substation complex:</u> Up to 10 m

SCOPING REPORT: Scoping and Environmental Impact Assessment (EIA) Process for the Proposed Development of a Solar Photovoltaic (PV) Facility (Kudu Solar Facility 2) and associated infrastructure, near De Aar, Northern Cape Province

COMPONENT	DESCRIPTION
	<ul style="list-style-type: none"> ▪ <u>Capacity of the on-site substation complex</u>: This varies according to the detailed design and requirements from potential clients, however a capacity stepping up from 22kV or 33kV to 132 kV is estimated.
Associated Infrastructure	
Battery Energy Storage System (BESS)	<ul style="list-style-type: none"> ▪ <u>Technology</u>: Lithium-Ion BESS or Redox Flow BESS (both options being considered in the Scoping and EIA Process) ▪ <u>Footprint</u>: Approximately 1 ha ▪ <u>Height</u>: Up to 10 m ▪ <u>Capacity</u>: Up to 500 MW / 500 MWh
On-site medium voltage internal cables	<ul style="list-style-type: none"> ▪ <u>Placement</u>: Underground or above ground in certain sections ▪ <u>Capacity</u>: 22 or 33 kV ▪ <u>Depth</u>: Maximum depth of 1.5 m
Underground low voltage cables or cable trays	<ul style="list-style-type: none"> ▪ <u>Depth</u>: Maximum depth of 1.5 m
Access roads (including upgrading and widening of existing roads)	<ul style="list-style-type: none"> ▪ <u>Details</u>: Existing roads will be used as far as practically achievable. Some intersections may need to be widened by more than 4 m or 6 m. If lengthening of the intersections is required, then such lengthening will not exceed 1 km. Exact details of the length will be confirmed during the EIA Phase. In addition, some access roads may need to be upgraded depending on which route is used. Upgrading of the main access point from the R48 is likely to need upgrading. Such upgrading will include lengthening of less than 1 km. Details will be confirmed during the EIA Phase.
Internal roads	<ul style="list-style-type: none"> ▪ <u>Details</u>: New internal service roads will need to be established. These would either comprise farm roads (compacted dirt/gravel) or paved roads. ▪ <u>Width</u>: Approximately 4 – 5 m
Fencing around the PV Facility Perimeter	<ul style="list-style-type: none"> ▪ <u>Type</u>: Could be Palisade or mesh or fully electrified ▪ <u>Height</u>: Up to 3 m
Storm water channels	<ul style="list-style-type: none"> ▪ Details to be confirmed once the Engineering, Procurement and Construction (EPC) contractor has been selected and the design is finalised. Where necessary, a detailed storm water management plan would need to be developed.
Panel cleaning and maintenance area	<ul style="list-style-type: none"> ▪ Details to be confirmed during the EIA Phase
Work area during the construction phase (i.e. laydown area)	<ul style="list-style-type: none"> ▪ Temporary Laydown: Up to 7 ha. ▪ The need for a permanent laydown area will be confirmed during the EIA Phase.
Water Requirements	<ul style="list-style-type: none"> ▪ Approximately 9 000 m³ of water is estimated to be required per year for the construction phase.

COMPONENT	DESCRIPTION
	<ul style="list-style-type: none"> ▪ Approximately 1 000 m³ of water is estimated to be required per year for the operational phase. ▪ Water requirements during the decommissioning phase are unknown at this stage. ▪ Potential sources: Local municipality, third-party water supplier, existing boreholes or drilled boreholes on site.
Construction Period	<ul style="list-style-type: none"> ▪ 12 – 18 months
Operational Period	<ul style="list-style-type: none"> ▪ Once the commercial operation date is achieved, the proposed facility will generate electricity for a minimum period of 20 years.

NEED FOR THE ENVIRONMENTAL IMPACT ASSESSMENT

As noted above, in terms of the 2014 NEMA EIA Regulations (as amended) published in GN R326, R327, R325 and R324 and further amended on 11 June 2021 in GN 517; and on 3 March 2022 in GN 1816, a full Scoping and EIA Process is required for the proposed project. The need for the Scoping and EIA is triggered by, amongst others, the inclusion of Activity 1 listed in GN R325 (Listing Notice 2):

- *“The development of facilities or infrastructure for the generation of electricity from a renewable resource where the electricity output is 20 megawatts or more, excluding where such development of facilities or infrastructure is for photovoltaic installations and occurs (a) within an urban area; or (b) on existing infrastructure”.*

Chapter 4 of the Scoping Report contains the detailed list of activities contained in GN R327, R325 and R324 which are triggered by the various project components and thus form part of this Scoping and EIA Process.

The purpose of the Scoping and EIA Process is to identify, assess and report on any potential impacts the proposed project, if implemented, may have on the receiving environment. The Scoping and EIA therefore needs to show the Competent Authority, the National DFFE; and the Project Applicant what the consequences of their choices will be in terms of impacts on the biophysical and socio-economic environment and how such impacts can be, as far as possible, enhanced or mitigated and managed as the case may be.

POTENTIAL ISSUES AND HIGH-LEVEL IMPACT ASSESSMENT

Potential issues and impacts associated with the proposed project have been identified based on Scoping Level Specialist Assessments and inputs. These potential issues and impacts, summarised in Table D below, will be assessed in further detail during the EIA Phase and are included in Chapter 6 of this Scoping Report. Issues raised during the 30-day review period on the Draft Scoping Report were in line with the potential issues identified below for further assessment in the EIA Phase. The Terms of Reference for the various Specialist Assessments are included in Chapter 7 of this Scoping Report.

Note that at the Scoping Phase, it has been confirmed that an Agricultural Compliance Statement (in accordance with GN 320) and a Terrestrial Animal Species Compliance Statement (in accordance with GN 1150) are required and deemed suitable based on the sensitivities identified within the study area. It has also been confirmed that the study area is of low to very low palaeo-sensitivity following a Site Sensitivity Verification (SSV), and thus the specialist has motivated that no further assessments are required.

Table D. Summary of Issues to be addressed during the EIA Phase as part of the Specialist Assessments / Input

SPECIALIST ASSESSMENT / INPUT	KEY ISSUES TO BE ADDRESSED
Agriculture and Soils Compliance Statement	<ul style="list-style-type: none"> ▪ Negative potential impacts: <ul style="list-style-type: none"> ○ Construction Phase: Loss of agricultural potential by occupation of land. ○ Construction and Decommissioning Phases: Loss of agricultural potential by soil degradation. ○ Construction and Decommissioning Phases: Loss of agricultural potential by dust generation. ▪ Positive potential impacts (Construction, Operation and Decommissioning Phases): <ul style="list-style-type: none"> ○ Increased financial security for farming operations. ○ Improved security against stock theft and other crime due to the presence of security infrastructure and security personnel at the energy facility.
Terrestrial Biodiversity, Terrestrial Plant Species, and Terrestrial Animal Species	<p>Construction Phase:</p> <ul style="list-style-type: none"> ▪ Habitat loss and fragmentation. ▪ Loss of protected species. ▪ Increased alien invasive species. ▪ Increased erosion and soil compaction. ▪ Littering and general pollution. <p>Operational Phase:</p> <ul style="list-style-type: none"> ▪ Loss of species composition and diversity. ▪ Increased alien invasive species. ▪ Littering and general pollution. <p>Decommissioning Phase</p> <ul style="list-style-type: none"> ▪ Loss of habitat. ▪ Increased alien invasive species. <p>Cumulative Impact</p> <ul style="list-style-type: none"> ▪ Habitat loss and fragmentation.
Aquatic Biodiversity Impact Assessment	<p>Construction Phase:</p> <ul style="list-style-type: none"> ▪ Disturbance of aquatic habitat and the associated impact to sensitive aquatic biota. ▪ Removal of indigenous aquatic vegetation and associated loss of aquatic ecological integrity and functionality. ▪ Water supply for construction and associated stress on available water resources. ▪ Road crossing structures may impede flow in the aquatic features. ▪ Alien vegetation infestation may occur within the aquatic features due to disturbance.

SPECIALIST ASSESSMENT / INPUT	KEY ISSUES TO BE ADDRESSED
	<ul style="list-style-type: none"> ▪ Increased sedimentation and risks of contamination of surface water runoff may result from construction works. <p>Operational Phase:</p> <ul style="list-style-type: none"> ▪ Ongoing disturbance of aquatic features and associated vegetation along access roads or adjacent to the infrastructure that needs to be maintained. ▪ Modified runoff characteristics from hardened surfaces at the substation and along access roads has the potential to result in erosion of adjacent watercourses. ▪ Water supply and water quality impacts (e.g. contamination from sewage) as a result of the operation of the site. <p>Decommissioning Phase:</p> <ul style="list-style-type: none"> ▪ Increased disturbance of aquatic habitat due to the increased activity on the site. ▪ Increased sedimentation and risks of contamination of surface water runoff. <p>Cumulative Impacts:</p> <ul style="list-style-type: none"> ▪ Construction and Decommissioning Phases: Increased disturbance of aquatic habitat due to the increased activity in the wider area. ▪ Operational Phase: Degradation of ecological condition of aquatic ecosystems.
Avifauna Impact Assessment	<p>Construction Phase:</p> <ul style="list-style-type: none"> ▪ Displacement due to disturbance and habitat transformation associated with the construction of the solar PV plant and associated infrastructure. <p>Operational Phase:</p> <ul style="list-style-type: none"> ▪ Displacement due to habitat transformation associated with the presence of the solar PV plant and associated infrastructure. ▪ Collisions with the solar panels. ▪ Entrapment in perimeter fences. ▪ Electrocutions in the onsite substation complex. <p>Decommissioning Phase:</p> <ul style="list-style-type: none"> ▪ Displacement due to disturbance associated with the decommissioning of the solar PV plant and associated infrastructure. <p>Cumulative Impacts:</p> <ul style="list-style-type: none"> ▪ Construction and Decommissioning Phases: <ul style="list-style-type: none"> ○ Displacement due to disturbance and habitat transformation associated with the construction and decommissioning of the solar PV plant and associated infrastructure. ▪ Operational Phase: <ul style="list-style-type: none"> ○ Displacement due to habitat transformation associated with the presence of the solar PV plant and associated infrastructure. ○ Collisions with the solar panels. ○ Entrapment in perimeter fences. ○ Electrocutions in the onsite substation complex.
Visual Impact Assessment	<p>Construction Phase:</p> <ul style="list-style-type: none"> ▪ Potential effect of dust and noise from trucks and construction machinery during the construction period, and the effect of this on nearby farmsteads and visitors to the area. ▪ Potential visual effect of haul roads, access roads, stockpiles and construction camps in the visually exposed landscape.

SPECIALIST ASSESSMENT / INPUT	KEY ISSUES TO BE ADDRESSED
	<p>Operational Phase:</p> <ul style="list-style-type: none"> ▪ Potential visual intrusion of solar arrays and related infrastructure on receptors including glint and glare ▪ Potential visual impact of an industrial type of activity on the pastoral / rural character and sense of place of the area <p>Decommissioning Phase:</p> <ul style="list-style-type: none"> ▪ Potential visual effect of any remaining structures, platforms and disused roads on the landscape. <p>Cumulative Impacts:</p> <ul style="list-style-type: none"> ▪ Potential combined visual effect of proposed 12 solar PV facilities seen together during construction phase ▪ Potential combined visual effect of proposed 12 solar PV facilities seen together during operational phase. ▪ Potential combined visual effect of proposed 12 solar PV facilities seen together during decommissioning phase.
<p>Heritage Impact Assessment (Archaeology and Cultural Landscape)</p>	<p>Construction Phase:</p> <ul style="list-style-type: none"> ▪ Potential impacts on archaeology ▪ Potential impacts on graves ▪ Potential impacts on the cultural landscape <p>Operational Phase:</p> <ul style="list-style-type: none"> ▪ Potential impacts on the cultural landscape <p>Decommissioning Phase:</p> <ul style="list-style-type: none"> ▪ Potential impacts on the cultural landscape <p>Cumulative Impacts:</p> <ul style="list-style-type: none"> ▪ Construction and Decommissioning Phases: <ul style="list-style-type: none"> ○ Potential impacts on archaeology. ○ Potential impacts on graves. ▪ Operational Phase: <ul style="list-style-type: none"> ○ Potential impacts on the cultural landscape.
<p>Palaeontology Site Sensitivity Verification Report</p>	<ul style="list-style-type: none"> ▪ The study area has been confirmed as low to very low palaeo-sensitivity. Provided that the Chance Fossil Finds Protocol is incorporated into the Environmental Management Programmes (EMPrs) and fully implemented during the construction phase of the solar PV facility, there are no objections on palaeontological heritage grounds to authorisation of the proposed project. Pending the discovery of significant new fossil finds before or during construction, no further specialist palaeontological studies, reporting, monitoring or mitigation are recommended for the proposed project.
<p>Socio-Economic Impact Assessment</p>	<p>Construction Phase:</p> <ul style="list-style-type: none"> ▪ Potential positive impacts: <ul style="list-style-type: none"> ○ Creation of employment and business opportunities, and opportunity for skills development and on-site training. ▪ Potential negative impacts: <ul style="list-style-type: none"> ○ Impacts associated with the presence of construction workers on local communities. ○ Impacts related to the potential influx of job-seekers. ○ Increased risks to livestock and farming infrastructure associated with the construction related activities and presence of construction workers on the site.

SPECIALIST ASSESSMENT / INPUT	KEY ISSUES TO BE ADDRESSED
	<ul style="list-style-type: none"> ○ Increased risk of grass fires associated with construction related activities. ○ Nuisance impacts, such as noise, dust, and safety, associated with construction related activities and vehicles. ○ Impact on productive farmland. <p>Operational Phase:</p> <ul style="list-style-type: none"> ▪ Potential positive impacts: <ul style="list-style-type: none"> ○ The establishment of infrastructure to improve energy security and support the renewable sector. ○ Creation of employment opportunities. ○ Benefits to the affected landowners. ○ Benefits associated with the socio-economic contributions to community development. ▪ Potential negative impacts: <ul style="list-style-type: none"> ○ Visual impacts and associated impacts on sense of place. ○ Impact on property values. ○ Impact on tourism. <p>Decommissioning Phase:</p> <ul style="list-style-type: none"> ▪ Potential negative impacts: <ul style="list-style-type: none"> ○ Social impacts associated with retrenchment including loss of jobs, and source of income. <p>Cumulative Impacts:</p> <ul style="list-style-type: none"> ▪ Potential positive impacts: <ul style="list-style-type: none"> ○ Cumulative impact on local economies. ▪ Potential negative impacts: <ul style="list-style-type: none"> ○ Cumulative impact on sense of place. ○ Cumulative impact on services.
Traffic Impact Assessment	<p>Construction Phase:</p> <ul style="list-style-type: none"> ▪ Potential congestion and delays on the surrounding road network. ▪ Potential impact on traffic safety and increase in accidents with other vehicles or animals. ▪ Potential change in the quality of the surface condition of the roads. ▪ Potential noise and dust pollution. <p>Operational Phase:</p> <ul style="list-style-type: none"> ▪ The traffic generated during the operational phase are mainly related to the staff that will be transported to and from the sites and are not anticipated to have a significant traffic impact on the surrounding road network. <p>Decommissioning Phase:</p> <ul style="list-style-type: none"> ▪ Potential congestion and delays on the surrounding road network. ▪ Potential impact on traffic safety and increase in accidents with other vehicles or animals. ▪ Potential change in the quality of the surface condition of the roads. ▪ Potential noise and dust pollution. <p>Cumulative Impacts</p> <ul style="list-style-type: none"> ▪ Congestion and delays on the surrounding road network.

SPECIALIST ASSESSMENT / INPUT	KEY ISSUES TO BE ADDRESSED
	<ul style="list-style-type: none"> ▪ Impact on traffic safety and increase in accidents with other vehicles or animals. ▪ Change in the quality of the surface condition of the roads. ▪ Noise and dust pollution.
<p>Battery Storage High Level Safety, Health and Environment Risk Assessment</p>	<ul style="list-style-type: none"> ▪ Lithium-ion Battery Energy Storage System (BESS): <ul style="list-style-type: none"> ○ Noxious smoke from potential fires. ○ Risk of fires or explosions. ▪ Redox flow BESS: <ul style="list-style-type: none"> ○ Risk of spills due to the large volume of electrolyte handled.
<p>Geohydrology Assessment</p>	<p>Construction Phase:</p> <ul style="list-style-type: none"> ▪ Potential lowering of the groundwater level due to abstraction for construction related activities. ▪ Potential impact on groundwater quality as a result of accidental oil spillages or fuel leakages <p>Operational Phase:</p> <ul style="list-style-type: none"> ▪ Potential lowering of the groundwater level due to abstraction for operational related activities such as panel cleaning. ▪ Potential impact on groundwater quality as a result of using cleaning agents for cleaning the solar panels. ▪ Potential impact on groundwater quality as a result of electrolyte that will be used for the BESS. <p>Decommissioning Phase:</p> <ul style="list-style-type: none"> ▪ Potential impact on groundwater quality as a result of accidental oil spillages or fuel leakages. <p>Cumulative Impacts:</p> <ul style="list-style-type: none"> ▪ Potential lowering of groundwater level during the construction and operational phase for all 12 of the Kudu Solar Facilities. ▪ Accidental oil spillages or fuel leakages from the construction and the decommissioning phase for all the 12 Kudu Solar Facilities. ▪ Potential of impact on groundwater quality as a result of using cleaning agents for cleaning the solar panels during the operational phase for all the 12 Kudu Solar Facilities. ▪ Potential impact on groundwater quality as a result of electrolyte that will be used for the BESS. ▪ Other wind and solar projects within a 30 km radius.
<p>Geotechnical Assessment</p>	<p>Construction, Operational and Decommissioning Phases:</p> <ul style="list-style-type: none"> ▪ Displacement of geologic materials. This is related to increased unnatural hard surfaces that will yield increased runoff, potentially increasing erosion. Removal of rocks and other geologic materials for site levelling and grading during construction and decommissioning, resulting in loss of geologic materials, e.g. topsoil removal/loss, and potentially the destruction of habitats of endemic species. ▪ Contamination of subsoils and loss of topsoil. This includes contamination of geologic materials as a consequence of the construction and decommissioning activities by earthworks machinery and other apparatus; as well as through typical maintenance activities during the operation phase, such as washing of solar panels, or spillages associated with the BESS.

Table E below provides a summary of the overall impact significance assessed by the relevant specialists at the Scoping Level. It includes the overall impact significance, based on the implementation of mitigation measures for each phase of the proposed project, including direct and cumulative impacts. Where information is not provided, it means that the impacts were insignificant or not predicted for that phase. All impacts provided in the table are negative in nature, except for the Socio-Economic Assessment. Additional positive impacts will be unpacked during the EIA Phase.

Overall, based on Table E it can be deduced that the effect of potential impacts can be limited or reduced to acceptable levels through avoidance, minimisation and the implementation of appropriate mitigation measures and management actions during the construction, operational and decommissioning phases. Therefore, based on the scoping level specialist input, potential negative impacts associated with the proposed project are anticipated to mainly be of **low to very low significance after mitigation**, whilst some positive socio-economic impacts of moderate significance are expected.

Table E: Overall Impact Significance with the Implementation of Mitigation Measures for Direct and Cumulative Negative and Positive Impacts for the proposed project

PHASE → SPECIALIST STUDY ↓	CONSTRUCTION		OPERATIONAL		DECOMMISSIONING	
Direct Impacts						
Terrestrial Biodiversity, Terrestrial Plant Species and Terrestrial Animal Species	Moderate		Low		Low	
Aquatic Biodiversity and Species	Very Low		Very Low		Very Low	
Avifauna Assessment	Low		Very Low	Low	Low	
Visual Impact Assessment	Low		Moderate		Very Low	
Heritage Impact Assessment (Archaeology and Cultural Heritage)	Low		Low		Low	
Socio-Economic Assessment	Low		Low		Low	
	Moderate		Moderate			
Traffic Impact Assessment	Low	Very Low			Low	Very Low
Geohydrology Assessment	Low	Very Low	Low	Very Low	Very Low	
Geotechnical Assessment	Very Low		Very Low		Very Low	
Cumulative Impacts						
Terrestrial Biodiversity, Terrestrial Plant Species and Terrestrial Animal Species	Moderate		Low		Low	
Aquatic Biodiversity and Species	Very Low		Very Low		Very Low	
Avifauna Assessment	Low		Moderate		Low	
Visual Impact Assessment	Low		Moderate		Very Low	
Heritage Impact Assessment (Archaeology and Cultural Heritage)	Low		Low		Low	
Socio-Economic Assessment	Moderate	Low	Moderate	Low	Moderate	Low
	Moderate		Moderate		Moderate	
Traffic Impact Assessment	Low	Very Low			Low	Very Low
Geohydrology Assessment						
Geotechnical Assessment	Low		Low		Low	



CHAPTER I: Introduction



CONTENTS

1. INTRODUCTION	1-3
1.1. Overview of the Proposed Kudu Solar Facility 2	1-6
1.2. Project Motivation	1-6
1.3. Legal Requirements for an EIA	1-9
1.4. Project Developer	1-9
1.5. Project Applicant	1-10
1.6. Competent Authority and EIA Project Team	1-10
1.7. Details and Expertise of the CSIR EIA Project Management Team	1-12
1.8. Need and Desirability	1-13
1.9. Objectives for this Scoping Report	1-38

TABLES

Table 1.1: The EIA Project Team	1-11
Table 1.2: The Guideline on the Need and Desirability's list of questions to determine the "Need and Desirability" of a proposed project	1-14
Table 1.3: Compliance with Appendix 2 of the 2014 NEMA EIA Regulations (as amended)	1-39



FIGURES

- Figure 1.1: Breakdown of the projects that comprise the Kudu Solar Facilities and EGI cluster 1-4
- Figure 1.2: Locality map for the proposed Kudu Solar Facilities 1 to 12 and EGI near De Aar in the Northern Cape. Note that the EGI Projects are not part of the current application and report. The EGI Projects will be considered separately at a later stage. The EGI corridor indicated in this Figure is indicative. 1-5

1. INTRODUCTION

The Project Developer, ABO Wind renewable energies (Pty) Ltd (hereafter “ABO Wind”) is proposing to develop 12¹ Solar Photovoltaic (PV) power generation facilities and associated Electrical Grid Infrastructure (EGI), north-east of the town of De Aar in the Renosterberg Local Municipality and Pixley Ka Seme District Municipality, in the Northern Cape Province. The proposed projects are located approximately 50 km from De Aar and 25 km from Petrusville. The proposed projects are referred to as the “Kudu project”.

The proposed Solar PV Facilities will make use of PV solar technology to generate electricity from energy derived from the sun. Each solar PV Facility will have a range of associated infrastructure, including, but not limited to, an on-site substation complex, battery energy storage system (BESS), and is proposed to connect to the existing Hydra-Perseus 400 kV overhead power line via dedicated proposed 132 kV power lines, an independent Main Transmission Substation (MTS), and a 400 kV Loop-In-Loop-Out (LILO).

Each of the Solar PV Facilities would be its own project and would require its own, separate Environmental Authorisation (EA). The same applies to the EGI projects. Each project will have a specific Project Applicant. The following projects are being proposed (Figure 1.1):

- **PROJECTS 1 TO 12:** The proposed development of 12 Solar PV Facilities and associated infrastructure (i.e. Kudu Solar Facility 1 to Kudu Solar Facility 12²).
- **PROJECTS 13 TO 24:** The proposed development of switching stations and collector stations at each on-site substation complex at each of the 12 Kudu Solar Facilities, and up to 12 x 132 kV overhead power lines running from each Solar PV Facility to the proposed collector stations or up to the proposed MTS.
- **PROJECT 25:** The proposed development of an independent 400/132 kV MTS, including associated infrastructure at the MTS.
- **PROJECT 26:** The proposed development of a 400 kV LILO from the existing Hydra-Perseus 400 kV overhead power line to the proposed MTS.

Projects 1 to 12 require Scoping and Environmental Impact Assessment (EIA) Processes. Projects 13 to 26 will require Basic Assessment (BA) Processes or will be subjected to separate registration processes in terms of the EGI Standard (Government Gazette (GG) 47095; Government Notice (GN) 2313, dated 27 July 2022), or may require a hybrid approach depending on the sensitivities found within the EGI corridor.

¹ Initially, the Project Developer identified the Original Scoping Buildable Areas within the study area, and these contained up to 14 Solar PV Facilities (as noted in the Background Information Document). Following the identification of sensitivities during the Scoping Phase, as well as various considerations such as the capacities of the Bidding Window 6 and the requirements of landowners, the Project Developer took such sensitivities and considerations into account and formulated the Revised Scoping Buildable Areas, which resulted in up to 12 Solar PV Facilities.

² Note that throughout the report the term Solar Facility and PV are used synonymously. For example, Kudu Solar Facility 1 and Kudu PV1 are used interchangeably.

With specific reference to Projects 25 and 26, if the proposed Eskom Hydra B Substation is built by Eskom, then additional upgrades of this Eskom substation would be undertaken to ensure that the substation can accommodate the power generated by the proposed 12 Kudu Solar Facilities. This would be undertaken based on engagements with and approval from Eskom. Additional detail will be provided as the separate BA or registration processes progress.

Scoping and EIA Processes x 12		BA Processes x 12 or Standard Registration Processes x 12 or hybrid approach		
Project 1: Kudu Solar Facility 1	Project 7: Kudu Solar Facility 7	Project 13: Switching Station, Collector Station, 132 kV Power Line for Kudu Solar 1	Project 19: Switching Station, Collector Station, 132 kV Power Line for Kudu Solar 7	Project 25: Independent 400/132 kV MTS and associated infrastructure
Project 2: Kudu Solar Facility 2	Project 8: Kudu Solar Facility 8	Project 14: Switching Station, Collector Station, 132 kV Power Line for Kudu Solar 2	Project 20: Switching Station, Collector Station, 132 kV Power Line for Kudu Solar 8	Project 26: 400 kV Loop-In-Loop-Out (LILO) from the existing Hydra-Perseus 400 kV line to the proposed MTS
Project 3: Kudu Solar Facility 3	Project 9: Kudu Solar Facility 9	Project 15: Switching Station, Collector Station, 132 kV Power Line for Kudu Solar 3	Project 21: Switching Station, Collector Station, 132 kV Power Line for Kudu Solar 9	
Project 4: Kudu Solar Facility 4	Project 10: Kudu Solar Facility 10	Project 16: Switching Station, Collector Station, 132 kV Power Line for Kudu Solar 4	Project 22: Switching Station, Collector Station, 132 kV Power Line for Kudu Solar 10	
Project 5: Kudu Solar Facility 5	Project 11: Kudu Solar Facility 11	Project 17: Switching Station, Collector Station, 132 kV Power Line for Kudu Solar 5	Project 23: Switching Station, Collector Station, 132 kV Power Line for Kudu Solar 11	
Project 6: Kudu Solar Facility 6	Project 12: Kudu Solar Facility 12	Project 18: Switching Station, Collector Station, 132 kV Power Line for Kudu Solar 6	Project 24: Switching Station, Collector Station, 132 kV Power Line for Kudu Solar 12	

Figure 1.1: Breakdown of the projects that comprise the Kudu Solar Facilities and EGI cluster

This Scoping Report only addresses **Kudu Solar Facility 2** (i.e. Project 2) (hereafter referred to as the “Kudu Solar Facility” or “proposed project”), and separate reports have been compiled for each Solar PV Facilities (i.e. Projects 1 to 12). Separate reporting will also be followed for Projects 13 to 26 based on the relevant environmental management instrument implemented at the time. Therefore, the EGI Projects (Projects 13 to 26) are not the subject of this current Scoping Report.

In terms of reporting, note that a request to submit combined Applications for EA in terms of Regulation 11 (4) of the 2014 National Environmental Management Act (Act 107 of 1998, as amended) (NEMA) EIA Regulations (as amended) and the issuing of multiple EAs in terms of Regulation 25 (1) and (2) of the 2014 NEMA EIA Regulations (as amended) was not accepted by the Department of Forestry, Fisheries and the Environment (DFFE). Refer to Appendix F.6 of this Scoping Report for a copy of this correspondence from the DFFE.

This chapter provides an introduction of the proposed project, and includes the following:

- An overview of the proposed Solar PV Facility and associated infrastructure;
- Project Motivation;
- The legal requirements for an EIA;
- Information on the Project Developer and Project Applicant;
- The Competent Authority and EIA Project Team;
- Details and Expertise of the CSIR EIA Project Management Team;
- Need and Desirability;
- The objectives of the Scoping Report; and
- Requirements for a Scoping Report in terms of Appendix 2 of the 2014 NEMA EIA Regulations (as amended).

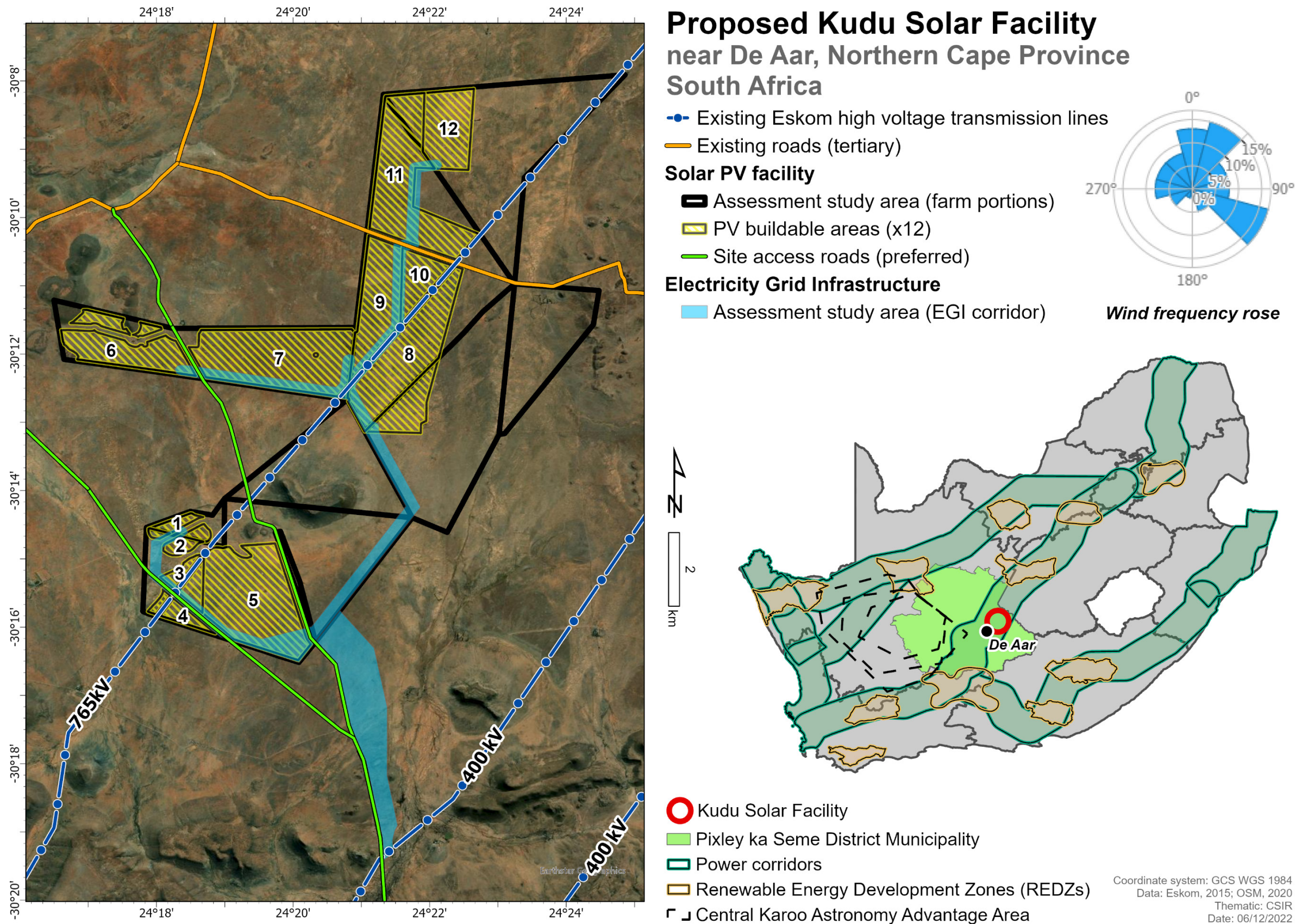

Figure 1.2: Locality map for the proposed Kudu Solar Facilities 1 to 12 and EGI near De Aar in the Northern Cape. Note that the EGI Projects are not part of the current application and report. The EGI Projects will be considered separately at a later stage. The EGI corridor indicated in this Figure is indicative.

1.1. Overview of the Proposed Kudu Solar Facility 2

The proposed Solar PV Facility will consist of the key components listed in Chapter 2 of this Scoping Report, as summarised below:

- Solar Field, comprising Solar Arrays with a maximum height of approximately 3.5 m.
- Building Infrastructure (e.g. on-site substation complex; offices; operational and maintenance building and control centre; warehouse/workshop; ablution facilities; Inverter-Transformer stations; and guard house).
- An on-site substation complex including the following:
 - On-site Independent Power Producer (IPP) or Facility Substation.
 - Lithium Ion or Redox Flow BESS.
 - Switching Station and Collector Station. This forms part of Projects 13 – 24.
- Associated Infrastructure (e.g. temporary construction laydown area; internal roads up to 5 m wide; widening and/or upgrading of existing access roads (where required); fencing; storm water channels; panel maintenance and cleaning area; underground low voltage cables or cable trays; and 22 or 33 kV internal underground power lines³).

The generation capacity for Kudu Solar Facility 2 is estimated at 50 Megawatts alternating current (MWac). The construction period is estimated to extend 12 to 18 months. Once the commercial operation date is achieved, the proposed facilities will generate electricity for a minimum period of 20 years.

1.2. Project Motivation

The need for renewable energy is clear, in both a local and international context, with South Africa becoming an integral part of the global transition towards renewable sources of electricity generation. South Africa is one of the highest per capita producers of carbon emissions in the world. These emissions are largely a result of an energy-intensive economy and high dependence on coal-based electricity generation to meet more than 90% of its energy needs. Consequently, the South African government is committed to supplementing the existing generation capacity of thermal and nuclear power plants with renewable energy power generation, thus creating the framework that will lead to an increase in the supply of clean energy for the nation. The development of renewable energy is important for South Africa to reduce its overall environmental footprint from power generation (including externality costs), and thereby to steer the country on a pathway towards sustainability.

Commitment toward decarbonisation of the economy is clearly illustrated in the South Africa's National Development Plan (NDP) Vision 2030 published in 2012. Chapters 4 and 5 of the NDP advocates for increased investment in an energy sector that is both economically inclusive and environmentally sustainable – with renewable energy at the core of enabling this transition. The

³ The internal reticulation would be 22 or 33 kV, and most likely underground. In the isolated event of crossing a feature hindering underground cabling (e.g. a road, topographical or environmental constraint) the reticulation line may better be suited to be above ground in certain sections. Therefore, both below and above ground routings need to be covered in this Application for EA. This does not trigger Activity 11 of Listing Notice 1, as the internal reticulation will not have “a capacity of more than 33 kV”. This is also updated in Chapter 2 of the Final Scoping Report.

plan identifies, as a priority, the production of sufficient energy to support industry at competitive prices, ensuring access for poor households, while reducing the carbon intensity of the economy.

In addition, due to the current constrained energy landscape and frequent loadshedding, the South African Government has articulated a plan to address the energy crisis. The President of South Africa delivered a speech on 25 July 2022 to inform the public of the plan towards achieving a reliable, affordable and sustainable energy supply (The Presidency, 2022⁴). In addition, the Minister of Forestry, Fisheries and the Environment also held a stakeholder engagement session on 21 July 2022 during which she highlighted proposed mechanisms for streamlining environmental approvals for solar energy development in low and medium sensitivity areas throughout the country; as well as power line and substation development within low and medium sensitivity areas within the gazetted EGI corridors (DFFE, 2022⁵). One of those mechanisms has already been gazetted for implementation, as noted above (i.e. the EGI Standard published in GG 47095; GN 2313, dated 27 July 2022).

Further, the Integrated Resource Plan (IRP) for South Africa for the period 2010 to 2030 (referred to as “IRP2010”) was released by government in 2010, and an updated report was published in 2013, which proposed to secure 17 800 MW of renewable energy capacity by 2030 (including solar, wind and other energy sources). In August 2011, the Department of Energy (DoE) (currently operating as the Department of Mineral Resources and Energy (DMRE)) launched the Renewable Energy Independent Power Producer Programme (REIPPPP) and invited potential IPPs to submit proposals for the financing, construction, operation and maintenance of the first 3 725 MW of onshore wind, solar thermal, PV, biomass, biogas, landfill gas or small hydropower projects. On 18 August 2015, an additional procurement target of 6 300 MW to be generated from renewable energy sources was added to the REIPPPP for the years 2021 - 2025, as published in GN 733, GG 39111. Of this, the additional target allocated for solar PV was 2 200 MW.

The most recent update to the IRP i.e. the IRP 2019, was gazetted by the Minister of Mineral Resources and Energy, Gwede Mantashe, in October 2019. The update revised the energy forecast for South Africa to the year 2030. Provision has been made for new additional capacity by 2030 including in particular 14 400 MW of wind and 6 000 MW of solar PV. In terms of the REIPPPP, submitted proposals are then evaluated according to a Request for Proposal (RFP). Bidding Window 5 had the same two main evaluation criteria for compliant proposals as the previous Bidding Windows 1-4, namely price and economic development. However, for Bidding Window 5, the point allocation changed to 90/10 compared to 70/30 for the previous Bidding Windows.

The overview summary document (DMRE, 2022⁶) on the RFP issued for Bidding Window 6 notes that Bid responses will be assessed firstly in terms of Functional and Qualification Criteria to determine if they are compliant. These criteria include the structure of the project; legal aspects; land acquisition and land use; environmental; financial; technical; economic development; and

⁴ The Presidency (2022). *Address by President Cyril Ramaphosa on actions to address the electricity crisis, Union Buildings, Tshwane*. Accessed online: <https://www.thepresidency.gov.za/speeches/address-president-cyril-ramaphosa-actions-address-electricity-crisis%2C-union-buildings%2C-tshwane> [August 2022]

⁵ DFFE (2022). *Minister Creecy announces improved environmental assessment processes for solar energy*. Accessed online: https://www.dffe.gov.za/creecy_environmentalassessmentprocesses_solarenergy [August 2022]

⁶ DMRE (2022). *Overview of the Request for Qualification and Proposals for New Generation Capacity under Sixth Bid Submission Phase of the Renewable Energy Independent Power Producer Procurement Programme*. Accessed online: <https://www.ipp-renewables.co.za/> [June 2022]

value for money. Secondly, the compliant Bids are proposed to be evaluated on a comparative basis (out of 100 points) in terms of price (maximum of 90 points) and economic development (maximum of 10 points). Therefore, economic development has been retained as a qualification criterion based on the RFP for Bidding Window 5, but it is also considered in the comparative scoring (DMRE, 2022). The bidders whose responses rank the highest (according to the aforementioned criteria) generally have the greatest potential to be appointed as “Preferred Bidders” by the DMRE.

Bidding Window 5 was conducted during 2021 with an allocation of 2 600 MW for new wind and solar energy. The successful bidders were announced on 28 October 2021. Bidding Window 6 was announced in April 2022 with an allocation of 4200 MW of renewable energy of which solar comprises 1000 MW.

Should this proposed project be acceptable and authorised, it is considered viable that long-term benefits for the community and society in the De Aar area would be realised. The proposed project will provide an opportunity for additional employment in an area where job creation is identified as a key priority. Approximately 150 employment opportunities will be created during the construction phase, and approximately 8 during the operational phase of the proposed project. The proposed project will make use of local labour as much as possible.

The project is intended to address the current energy shortages in South Africa and assist in meeting the need for additional renewable energy generation capacity, as required by the IRP of 2019. The total generation capacity of the entire project (i.e. should all 12 Solar Facilities be authorised) would be in the order of approximately 2 180 MWac⁷. As a means of comparison, for 2022 the municipal area of Kimberley in the Northern Cape has a total electricity load forecast of 643 MW and the total load forecast for the Northern Cape is 897 MW (Eskom, 2021⁸). The total provincial peak load forecast for the Northern Cape is expected to increase to about 1 313 MW by 2031 (Eskom, 2021).

The proposed project would also have international significance as it contributes to South Africa being able to meet some of its international obligations by aligning domestic policy with internationally agreed strategies and standards as set by the United Nations Framework Convention on Climate Change (UNFCCC), the Paris Agreement on Climate Change, Kyoto Protocol, and United Nations Convention on Biological Diversity (UNCBD), all of which South Africa is a signatory to. Renewable energy is critical to South Africa as this source of energy is recognised as a major contributor to climate protection, has a much lower environmental impact significance, as well as advancing economic and social development.

It is intended that this project will be bid into a future bidding program of the REIPPPP [or another future process linked to the IRP]. To submit a Bid in terms of the REIPPPP, the Project Applicant is required to have obtained an EA in terms of the 2014 NEMA EIA Regulations (as amended), as well as several additional authorisations or consents.

⁷ The total generation capacity is an estimate at this stage and may change based on the final buildable areas and sensitivities identified.

⁸ Eskom (2021). *Transmission Development Plan (2022 – 2031)*. Accessed online: <https://www.eskom.co.za/eskom-divisions/tx/transmission-lines/transmission-development-plans/> [May 2022]

1.3. Legal Requirements for an EIA

Section 24(1) of the NEMA, states that “In order to give effect to the general objectives of integrated environmental management laid down in this Chapter, the potential impact on the environment of listed activities must be considered, investigated, assessed and reported to the competent authority charged by this Act with granting the relevant EA”. The reference to “listed activities” relates to the regulations promulgated in GN R982, R983, R984 and R985 in GG 38282, dated 4 December 2014, which came into effect on 8 December 2014. These were amended on 7 April 2017, specifically promulgated in GN R326, R327, R325 and R324 in GG 40772; and further amended on 11 June 2021 in GN 517; and on 3 March 2022 in GN 1816. GN R327 and GN R324 includes listed activities that trigger the need for a BA Process, whereas GN R325 includes listed activities that trigger the need for a full Scoping and EIA Process. Additional detail is provided in Chapter 4 of this Scoping Report.

In terms of the NEMA and the 2014 NEMA EIA Regulations (as amended), a full Scoping and EIA Process is required for the proposed project.

The proposed project is not located within any of the Renewable Energy Development Zones (REDZs) that were gazetted in GG 41445, GN 114 on 16 February 2018; and GG 44191, GN 144 on 26 February 2021, hence it is subjected to a full Scoping and EIA Process with a 107-day decision-making timeframe, as opposed to a BA Process and 57-day decision-making timeframe allowed for in the REDZs. The proposed project is located within the Central Strategic Transmission Corridor that was gazetted in GN 113 on 16 February 2018; however the benefits only apply specifically to the EGI projects (Projects 13 – 26), as discussed above.

The need for the full Scoping and EIA is triggered by, amongst others, the inclusion of Activity 1 listed in GN R325 (Listing Notice 2):

- ***“The development of facilities or infrastructure for the generation of electricity from a renewable resource where the electricity output is 20 megawatts or more, excluding where such development of facility or infrastructure is for photovoltaic installations and occurs (a) within an urban area; or (b) on existing infrastructure”.***

Chapter 4 of this Scoping Report contains the detailed list of activities contained in GN R327, R325, and R324, which may be triggered by the various project components and thus form part of the Scoping and EIA Process.

1.4. Project Developer

ABO Wind AG is a Europe based company, which was formed in 1996. The company has since established subsidiaries in 13 countries. ABO Wind renewable energies (Pty) Ltd (referred to as “ABO Wind”), the South African subsidiary, was founded in 2017. The company focuses on wind, solar and biogas technologies and works with landowners, technology providers, regulators and investors to source and develop renewable energy projects. ABO Wind acts as the project developer and project interface, coordinating the research and studies, the site identification, the project structure, BAs, EIAs, selecting the strategic partners and arranging financing.

ABO Wind is committed to developing renewable energy in South Africa, and thus investing in the country. The company is currently working on a pipeline of around 5 GW of wind and solar projects as well as storage projects with batteries or hydrogen. As at 2021, 200 MW were sold during development; and 3 600 MW was under development by the company in South Africa.

1.5. Project Applicant

Each Solar PV Facility will have a dedicated Project Applicant. The Project Applicant for the Kudu Solar Facility 2 is Kudu Solar Facility 2 (Pty) Ltd.

1.6. Competent Authority and EIA Project Team

In accordance with Regulation 12 (1) of the 2014 NEMA EIA Regulations (as amended), ABO Wind has appointed the Council for Scientific and Industrial Research (CSIR) to undertake the Scoping and EIA Process to determine the potential biophysical, social and economic impacts associated with the proposed project, and to identify how such negative impacts can be avoided, remedied, mitigated or managed; and how positive impacts can be enhanced. Public participation forms an integral part of the Scoping and EIA Process and assists in identifying issues and possible alternatives to be considered. The CSIR is also undertaking the Public Participation Process (PPP) for this Scoping and EIA Process, via an integrated approach including all 12 proposed projects. Details on the PPP are included in Chapter 4 of this Scoping Report.

The 2014 NEMA EIA Regulations, as amended in GN 517 on 11 June 2021 states that the Competent Authority (CA) in respect of the listed activities *“is the CA in the province in which the activity is to be undertaken, unless: (a) it is an application for an activity contemplated in Section 24C(2) of the Act, in which case the CA is the Minister or an organ of state with delegated powers in terms of Section 42(1) of the Act; or (b) the application is a mining application in which case the CA is the Minister responsible for mineral resources”*.

With relevance to the proposed project, Section 24C (2) (a) (i) of NEMA states *“(2) the Minister must be identified as the competent authority in terms of subsection (1), unless otherwise agreed to in terms of section 24C (3), if the activity (a) has implications for international environmental commitments or relations, and where (i) it is identified by the Minister by notice in the Gazette”*.

Related to this, GN 779 states that, in terms of Sections 24C(1), 24C(2)(a)(i) and 24D of the NEMA, the Minister of Environmental Affairs (now Forestry, Fisheries and the Environment) is the CA for activities which are identified as activities in terms of Section 24(2)(a) of NEMA, which may not commence without an EA, and which relates to the Integrated Resources Plan (IRP) 2010 - 2030 and any updates thereto. The proposed project triggers various listed activities and thus requires EA. As noted above, the proposed project will be bid into a future bidding program of REIPPPP. Based on the above, the National DFFE serves as the CA for the proposed project.

The project team, which is involved in this Scoping and EIA Process, is listed in Table 1.1 below. This team includes several specialists who have extensive experience in conducting specialist studies for renewable energy projects in South Africa.

Table 1.1: The EIA Project Team

NAME	ORGANISATION	ROLE/STUDY TO BE UNDERTAKEN
<i>Environmental Management Services (CSIR)</i>		
Paul Lochner (<i>Registered EAP (2019/745)</i>)	CSIR	EAP, Technical Advisor and Quality Assurance
Rohaida Abed (<i>Pr.Sci.Nat. and Registered EAP (2021/4067)</i>)	CSIR	EAP and Project Manager
Helen Antonopoulos	CSIR	Project Officer
Luanita Snyman van der Walt (<i>Pr.Sci.Nat.</i>)	CSIR	GIS Specialist
Lizande Kellerman (<i>Pr.Sci.Nat.</i>)	CSIR	Public Participation Specialist
<i>Specialists</i>		
Johann Lanz (<i>Pr.Sci.Nat.</i>)	Private	Agriculture and Soils Compliance Statement
Corne Niemandt (<i>Pr.Sci.Nat.</i>) Samuel Laurence (<i>Pr.Sci.Nat.</i>)	Enviro-Insight cc	Terrestrial Biodiversity, Terrestrial Plant Species, and Terrestrial Animal Species
Toni Belcher (<i>Pr.Sci.Nat.</i>) Dana Grobler (<i>Pr.Sci.Nat.</i>)	Private	Aquatic Biodiversity Impact Assessment
Chris van Rooyen Albert Froneman (<i>Pr.Sci.Nat.</i>)	Chris van Rooyen Consulting	Avifauna Impact Assessment
Quinton Lawson (<i>SACAP, 3686</i>) Bernard Oberholzer (<i>SACLAP, 87018</i>)	QARC and BOLA	Visual Impact Assessment
Dr Jayson Orton (<i>APHP: Member 43; ASAPA CRM Section: Member 233</i>)	ASHA Consulting (Pty) Ltd	Heritage Impact Assessment (Archaeology and Cultural Landscape)
Dr John Almond (<i>PSSA and APHP Member</i>)	Natura Viva cc	Palaeontology Site Sensitivity Verification Report
Tony Barbour	Private	Socio-Economic Impact Assessment
Annebet Krige (<i>Pr Eng</i>)	Sturgeon Consulting	Traffic Impact Assessment
Debbie Mitchell (<i>Pr Eng</i>)	Ishecon cc	Battery Storage High Level Safety, Health and Environment Risk Assessment
Dale Barrow (<i>Pr.Sci.Nat.</i>) Christel van Staden (<i>Cand.Sci.Nat.</i>) Shane Teek (<i>Cand.Sci.Nat.</i>) Julian Conrad	GEOSS South Africa (PTY) Ltd	Geohydrology Assessment
Shane Teek (<i>Cand.Sci.Nat.</i>) Michael Baleta (<i>Pr.Sci.Nat.</i>) Julian Conrad	GEOSS South Africa (PTY) Ltd	Geotechnical Assessment
Rohaida Abed (<i>Pr.Sci.Nat. and Registered EAP (2021/4067)</i>) Helen Antonopoulos Lizande Kellerman (<i>Pr.Sci.Nat.</i>)	CSIR	Civil Aviation Site Sensitivity Verification
Rohaida Abed (<i>Pr.Sci.Nat. and Registered EAP (2021/4067)</i>) Helen Antonopoulos Lizande Kellerman (<i>Pr.Sci.Nat.</i>)	CSIR	Defence Site Sensitivity Verification

Feedback on the specialist studies commissioned as part of this Scoping and EIA Process is also included in Chapter 3, Chapter 4, Chapter 6 and Chapter 7 of this Scoping Report. Chapter 4 also includes motivation for not undertaking certain studies identified by the Screening Tool.

1.7. Details and Expertise of the CSIR EIA Project Management Team

This section provides information on the expertise of the CSIR EIA Project Management Team and Environmental Assessment Practitioner (EAPs).

Paul Lochner (*Registered EAP; Technical Advisor and Quality Assurance*):

Paul Lochner is an EAP at the CSIR in Stellenbosch, with 30 years of experience in a wide range of environmental assessment and management studies. Paul commenced work at CSIR in 1992, after completing a B.Sc. degree in Civil Engineering and a Masters in Environmental Science, both at the University of Cape Town. His initial work at focused on wetlands and estuarine management; environmental engineering in the coastal zone; and coastal zone management plans. Since 2008, Paul has been the leader and manager of the Environmental Management Services (EMS) group within CSIR that has been at the forefront of advancing environmental assessment in South Africa. This group currently consists of approximately 10 environmental scientists, planners and engineers, with offices in Stellenbosch, Cape Town and Durban. Paul's particular experience is in environmental planning and assessment for renewable energy, EGI, desalination, oil and gas, wetlands and coastal zone management, and industrial and port development. He has been closely involvement in the research and application of Strategic Environmental Assessment (SEA) in South Africa, and also has wide experience in Environmental and Social Impact Assessment, Environmental Management Programmes (EMPRs) and Environmental Screening Studies. He has been the project leader for over 40 SEAs and EIAs. He also served as project leader for a suite of SEAs commissioned by the DFFE from 2014 to 2020. Paul is a Registered EAP (2019/745) with the Environmental Assessment Practitioners Association of South Africa (EAPASA).

Rohaida Abed (*Pr. Sci. Nat. and Registered EAP, Project Manager*):

Rohaida Abed is an EAP in the EMS group of the CSIR. She has 12 years of experience in the Environmental Management field, and has been involved in various transport infrastructure related projects as an Environmental Control Officer. She has also been involved in BAs and EIAs relating to renewable energy, port infrastructure and bulk liquid storage facilities in the capacity of Project Manager. She also worked on the SEA for Gas Pipeline and EGI Expansion from 2017 to 2019, which was commissioned by the National Departments of Environmental Affairs, Energy and Public Enterprises. She is a registered Professional Natural Scientist (400247/14) with the South African Council for Natural Scientific Professions (SACNASP), and a Registered EAP (2021/4067) with the EAPASA.

Helen Antonopoulos (*Project Officer*):

Helen Antonopoulos is an intern EAP in the EMS group of the CSIR and holds BSc, BSc Honours, and MSc degrees in Environmental and Geographical Science from the University of Cape Town. She has assisted with compiling EA applications for Wind Energy Facilities in the Western Cape, as well as BA and Scoping Reports for Solar Facilities in the Northern Cape. She is interested in using renewable energy projects to promote sustainable development in South Africa.

1.8. Need and Desirability

It is an important requirement in the EIA Process to review the need and desirability of the proposed project. Guidelines on Need and Desirability were published by the Department of Environmental Affairs (DEA) [now operating as the DFFE] in 2017⁹. These guidelines list specific questions to determine need and desirability of proposed developments. This checklist is a useful tool in addressing specific questions relating to the need and desirability of a project and assists in explaining that need and desirability at the provincial and local context. Need and desirability answer the question of whether the activity is being proposed at the right time and in the right place.

Table 1.2 includes a list of questions based on the DEA's Guideline to determine the need and desirability of the proposed project. It should be noted this table will be informed by the outcomes of the Scoping and EIA Process and will be updated once the Specialist Assessments are completed in the EIA Phase. Note that the Scoping Level Specialist Assessments are included in Appendix G of this Scoping Report, and where possible, the findings of these studies have been integrated into Table 1.2.

⁹ DEA (2017), Guideline on Need and Desirability, Department of Environmental Affairs (DEA), Pretoria, South Africa. ISBN: 978-0-9802694-4-4.

Table 1.2: The Guideline on the Need and Desirability’s list of questions to determine the “Need and Desirability” of a proposed project

NEED	
Question	Response
1. How will this development (and its separate elements/aspects) impact on the ecological integrity of the area?	
<p>1.1. How were the following ecological integrity considerations taken into account?:</p> <ul style="list-style-type: none"> 1.1.1. Threatened Ecosystems, 1.1.2. Sensitive, vulnerable, highly dynamic or stressed ecosystems, such as coastal shores, estuaries, wetlands, and similar systems require specific attention in management and planning procedures, especially where they are subject to significant human resource usage and development pressure, 1.1.3. Critical Biodiversity Areas ("CBAs") and Ecological Support Areas ("ESAs"), 1.1.4. Conservation targets, 1.1.5. Ecological drivers of the ecosystem, 1.1.6. Environmental Management Framework, 1.1.7. Spatial Development Framework, and 1.1.8. Global and international responsibilities relating to the environment (e.g. RAMSAR sites, Climate Change, etc.). 	<p>The ecological sensitivities present within the study area will be assessed in detail in the Terrestrial Biodiversity and Plant and Animal Species, Aquatic Biodiversity, and Avifauna Impact Assessments during the EIA Phase. The specialists will identify aquatic, terrestrial and avifaunal sensitive areas within the study area that should be avoided by the proposed development, as well as any other ecologically sensitive areas and how to suitably develop within these areas so that the ecological integrity is maintained.</p> <p>The Terrestrial Biodiversity and Plant and Animal Species, Aquatic Biodiversity, and Avifauna Scoping Level Assessments are included in Appendix G.2, Appendix G.3 and Appendix G.4 of this Scoping Report respectively. These Scoping Level Assessments have identified sensitivities within the study area¹⁰ that should be avoided, based on desktop assessments and field work.</p> <p>The Aquatic Biodiversity Scoping Level Assessment determined the following:</p> <ul style="list-style-type: none"> ▪ The aquatic features within the study area comprise ephemeral unnamed tributaries of the Orange River. The catchments of these tributaries are not within any National Freshwater Ecosystem Priority Area (FEPA) river sub-catchments. ▪ The larger watercourses flow along the eastern and western extents of the study area, flowing in a northerly direction to join the Orange River downstream of Van der Kloof Dam. Associated with these larger watercourses are wide floodplains. Smaller watercourses and drainage features drain into the larger river corridors. ▪ The ephemeral streams and floodplains provide aquatic habitat to a diverse array of faunal species. ▪ The present ecological condition of the aquatic features within the study area is rated as largely natural to moderately modified.

¹⁰ The preferred site for the proposed Kudu Solar Facility comprises the full extent of the affected farm portions which cover a combined footprint of 8 150 ha, which serves as the study area for this Scoping and EIA Process. Therefore, the terms “site” and “study area” are used synonymously in the report. The Original and Revised Scoping Buildable Areas serve as the “development footprint” and fall within the preferred site (or study area).

NEED	
Question	Response
	<ul style="list-style-type: none"> ▪ The recommended ecological condition of the watercourses within the study area is largely natural to moderately modified. ▪ The larger watercourses (unnamed tributaries of the Orange River) and associated floodplains, as well as wetland areas within the study area, are deemed to be of medium aquatic ecological sensitivity. ▪ The smaller watercourses and drainage lines are considered to be of low aquatic ecological sensitivity. ▪ Buffers have been recommended to protect the aquatic ecosystems, as follows: <ul style="list-style-type: none"> ○ The larger tributary: The delineated edge of the surrounding floodplain wetland features. No buffer area is deemed to be required considering that the floodplain is a wide transitional area between the tributary and the surrounding terrestrial areas. ○ Smaller streams and drainage features that are indicated to be of medium sensitivity: At least 35 m for the watercourse or the delineated edge of wetland features to allow for the movement of water along these streams. ○ The Battery Energy Storage System (BESS) should preferably not be placed within 100 m of major rivers, watercourses and wetlands. <p>The Terrestrial Biodiversity and Plant and Animal Species Scoping Level Assessment determined the following:</p> <ul style="list-style-type: none"> ▪ Identified Ecological Support Areas (ESA) according to the Northern Cape Critical Biodiversity Area (CBA) Map (2016) extend over a wide area in this specific region of the Northern Cape. The entire site / study area, and thus all identified buildable areas and development footprints, are located within the ESA. ▪ Four main habitats were identified based on species composition and structure, namely 'White Grassland', 'Shrubby Grassland', 'Watercourse', and 'Koppies'. In addition, 'Transformed' areas were included which consists of existing roads, homesteads and bare soil. ▪ The following sensitive features are rated with a high sensitivity: <ul style="list-style-type: none"> ○ The Koppies habitat are high sensitivity features which must be avoided by development activities. Only limited development activities of low impact will be acceptable. Linear infrastructure such as roads and overhead powerlines

NEED	
Question	Response
	<p>should not cross the Koppies, and pylons should not be constructed in this habitat. No buffer applies to the Koppies.</p> <ul style="list-style-type: none"> ○ No sensitive plants were recorded, however several provincially protected species as well as a protected tree species were recorded. The Koppies habitat will assist in protecting many of the provincially protected species as well as a protected tree species. ▪ The following sensitive features are rated with a medium sensitivity: <ul style="list-style-type: none"> ○ The White and Shrubby Grasslands are considered moderately sensitive owing to its pristine nature with limited major impacts, mostly concentrated at homesteads, cattle camps and watering holes. Restoration efforts post-construction for temporary laydown areas are critical, as well as after the decommissioning of the project. ○ The Watercourse sensitivity is medium. ▪ Existing Transformed areas are rated as very low sensitivity. <p>The Avifauna Scoping Level Assessment noted the following:</p> <ul style="list-style-type: none"> ▪ The study area is located in the Platberg-Karoo Conservancy Important Bird Area. ▪ The study area is not located within any Protected Areas and National Protected Areas Expansion Strategy (NPAES) focus areas. ▪ A total of 82 species could potentially occur within the Broader Area where the project is located (see Appendix E). Of these, 21 are classified as priority species for solar developments. Of the 21 priority species, 17 were recorded during the monitoring so far, and 15 priority species have a medium to high probability of occurring regularly in the Study Area. Five Red Data species were recorded during the site surveys, namely Blue Crane, Martial Eagle, Verreaux’s Eagle, Cape Vultures and White-backed Vulture. ▪ Based on the desktop analysis and the Site Sensitivity Verification undertaken, the following buffers are recommended: <ul style="list-style-type: none"> ○ <u>All infrastructure exclusion zone</u>: A 1 km all infrastructure exclusion zone is recommended for a Verreaux’s Eagle nest found within the study area to prevent the displacement of the breeding pair during the construction phase due to disturbance.

NEED	
Question	Response
	<ul style="list-style-type: none"> ○ <u>Solar panel exclusion zones (other infrastructure allowed): Waterpoints:</u> The Original and Revised Scoping Buildable Areas and the immediate surrounding area contain several boreholes which are sources of surface water. It is preferable to leave some open space where possible with no solar panels, for birds to access and leave the surface water area unhindered¹¹. It is noted that the area surrounding the Original and Revised Scoping Buildable Areas contain several boreholes that will not be affected by the proposed development, and these boreholes will ensure that the local avifauna will still have access to adequate sources of surface water. ○ <u>High sensitivity zones:</u> The entire study area is rated as a high sensitivity zone due to the potential presence of several Species of Conservation Concern (SCCs), including Ludwig’s Bustard, Secretarybird, Martial Eagle, Cape Vulture and White-backed Vulture which could utilise the whole study area for foraging. However, these species do not require specific avoidance measures at this stage because there is still adequate habitat available outside the study area. <p>The preliminary sensitivity map is included in Chapter 3 and Chapter 7 of this Scoping Report and will be further refined, where warranted, during the EIA Phase following detailed specialist assessments.</p> <p>The sensitivities identified by the various specialists during the Scoping Phase, as highlighted above, have been taken into consideration and avoided where possible into order to identify the Revised Scoping Buildable Areas / development footprint.</p>
1.2. How will this development disturb or enhance ecosystems and/or result in the loss or protection of biological diversity? What measures were explored to firstly avoid these negative impacts, and where these negative impacts could not be avoided altogether, what measures were explored to minimise and remedy	The ecological sensitivities present within the study area will be assessed in detail in the Terrestrial Biodiversity and Plant and Animal Species, Aquatic Biodiversity, and Avifauna Impact Assessments during the EIA Phase. The specialists will identify aquatic, terrestrial and avifaunal sensitive areas within the study area that should be avoided by the

¹¹ While some of the waterpoints in the Revised Scoping Buildable Area might be removed, the applicant has agreed to retain some water points which will be buffered by a minimum circular solar panel exclusion zone of 50 m. The removal of some of the water points will therefore not be a significant impact.

NEED	
Question	Response
<p>(including offsetting) the impacts? What measures were explored to enhance positive impacts?</p>	<p>proposed development, as well as any other ecologically sensitive areas and how to suitably develop within these areas so that the ecological integrity is maintained.</p> <p>The Terrestrial Biodiversity and Plant and Animal Species, Aquatic Biodiversity, and Avifauna Scoping Level Assessments are included in Appendix G.2, Appendix G.3 and Appendix G.4 of this Scoping Report respectively. These Scoping Level Assessments have identified sensitivities within the study area that should be avoided, based on desktop assessments and field work.</p> <p>Refer to the response to Question 1.1 regarding the sensitivities identified in the Terrestrial Biodiversity and Plant and Animal Species, Aquatic Biodiversity, and Avifauna Scoping Level Assessments.</p> <p>The preliminary sensitivity map is included in Chapter 3 and Chapter 7 of this Scoping Report and will be further refined during the EIA Phase following detailed specialist assessments. The sensitivities identified by the various specialists during the Scoping Phase, as highlighted above, have been taken into consideration and avoided where possible into order to identify the Revised Scoping Buildable Areas / development footprint.</p> <p>The Terrestrial Biodiversity and Plant and Animal Species Scoping Level Assessment has identified various potential impacts during the Scoping Phase, which are discussed below:</p> <ul style="list-style-type: none"> ▪ Construction Phase: <ul style="list-style-type: none"> ○ Fragmentation and loss of habitat and sensitive features. ○ Loss of protected species. ○ Introduction and spread of alien invasive species. ○ Increased erosion and soil compaction. ○ Littering and general pollution. ▪ Operational Phase: <ul style="list-style-type: none"> ○ Increase in alien invasive species. ○ Loss of species composition and diversity.

NEED	
Question	Response
	<ul style="list-style-type: none"> ○ Littering and general pollution. ▪ Decommissioning Phase: <ul style="list-style-type: none"> ○ Increase in alien invasive species. ○ Loss of habitat. <p>Various mitigation measures have been identified to reduce the significance of or manage the impact. These measures are documented in the Scoping Level Assessment (Appendix G.2), and include, for example:</p> <ul style="list-style-type: none"> ▪ No construction related activities, such as the site camp, storage of materials, temporary roads or ablution facilities may be located in the high sensitivity areas. ▪ Avoidance is the best measure. All suitable habitat should be excluded from the proposed development, where relevant. ▪ Where the approved layout designs impact on individuals, permit applications are required for either the relocation or destruction of provincially protected species (Northern Cape Nature Conservation Act 9 of 2009) and for protected trees in terms of the National Forests Act (Act 84 of 1998). <p>Measures to avoid, remedy, mitigate and manage impacts will be included in the Environmental Management Programme (EMPr) that will be compiled during the EIA Phase and included in the EIA Report.</p> <p>In summary, the potential disturbance of ecosystems, and potential loss or protection of biological diversity have been identified as potential impacts in the Terrestrial Biodiversity and Plant and Animal Species Scoping Level Assessment. In addition, avoidance mechanisms have been adopted, whereby the highly sensitive ecological features have been avoided in the Revised Scoping Buildable Areas. In addition, mitigation measures have been provided to minimise and remedy the potential impacts. All the potential impacts will be assessed in further detail and refined during the EIA Phase.</p>
1.3. How will this development pollute and/or degrade the biophysical environment? What measures were explored to firstly avoid these impacts, and where impacts could not be avoided altogether, what measures were explored to minimise and	Various Scoping Level Assessments have been compiled and are included in Appendix G of this Scoping Report. These Scoping Level Assessments have identified sensitivities within the study area that should be avoided at the scoping phase, based on desktop

NEED	
Question	Response
<p>remedy (including offsetting) the impacts? What measures were explored to enhance positive impacts?</p>	<p>assessments and field work. This has informed the identification of the Revised Scoping Buildable Areas / development footprint. In addition, the Scoping Level Assessments have identified various potential negative impacts that the proposed project may result in, such as degradation to the biophysical environment and potential pollution. The associated high-level mitigation measures have also been identified. Such potential impacts are also summarised in Chapter 6 of this Scoping Report. All the potential impacts will be assessed in further detail and refined during the EIA Phase.</p> <p>Measures to avoid, remedy, mitigate or manage biophysical impacts will also be included in the EMPr that will be compiled during the EIA Phase and included in the EIA Report.</p>
<p>1.4. What waste will be generated by this development? What measures were explored to firstly avoid waste, and where waste could not be avoided altogether; what measures were explored to minimise, reuse and/or recycle the waste? What measures have been explored to safely treat and/or dispose of unavoidable waste?</p>	<p>Waste will mostly be generated during the construction and decommissioning phases of the proposed project.</p> <p>Approximately 50 m³ and 1.92 m³ of solid waste is estimated to be generated per month during the construction phase and operational phase, respectively for the proposed project.</p> <p>The following waste materials are expected during the construction phase:</p> <ul style="list-style-type: none"> ▪ Packaging material, such as the cardboard, plastic and wooden packaging and off-cuts; ▪ Hazardous waste from empty tins, oils, soil containing oil and diesel (in the event of spills), and chemicals; ▪ Building rubble, discarded bricks, wood and concrete; ▪ Domestic waste generated by personnel; and ▪ Vegetation waste generated from the clearing of vegetation. <p>During the operational phase, the facility will produce minor amounts of general waste (as a result of the offices or maintenance). Waste generated on site will be disposed of at a licenced landfill site. Refer to Chapter 2 (Project Description) of this Scoping Report for a detailed description of the waste to be generated by the proposed project.</p>

NEED	
Question	Response
	Measures to avoid, remedy, reduce, mitigate or manage waste will be included in the EMPr that will be compiled during the EIA Phase and included in the EIA Report.
1.5. How will this development disturb or enhance landscapes and/or sites that constitute the nation's cultural heritage? What measures were explored to firstly avoid these impacts, and where impacts could not be avoided altogether, what measures were explored to minimise and remedy (including offsetting) the impacts? What measures were explored to enhance positive impacts?	<p>A Heritage Impact Assessment (HIA) will be undertaken during the EIA Phase to assess potential archaeological and cultural impacts resulting from the proposed project. A Scoping Level Heritage Assessment (Archaeology and Cultural Heritage) has been commissioned and is included in Appendix G.6 of this Scoping Report. It is a Scoping Level Assessment intended for the Scoping Phase in terms of the 2014 National Environmental Management Act (NEMA) EIA Regulations (as amended), to capture high level assessments and to identify if there are any fatal flaws, as well as to capture the findings of the Site Sensitivity Verifications in line with the Assessment Protocols of GN 320. Thus, the requirements of the National Heritage Resources Act (Act 25 of 1999) (NHRA) (and Appendix 6 of the 2014 NEMA EIA Regulations, as amended) will be fulfilled in the EIA Phase, during which the formal HIA will be compiled.</p> <p>This Scoping Level Assessment has identified the following high-level impacts at this stage:</p> <ul style="list-style-type: none"> ▪ Construction Phase: <ul style="list-style-type: none"> ○ Potential impacts on archaeology. ○ Potential impacts on graves. ○ Potential impacts on the cultural landscape. ▪ Operational Phase: <ul style="list-style-type: none"> ○ Potential impacts on the cultural landscape. ▪ Decommissioning Phase: <ul style="list-style-type: none"> ○ Potential impacts on the cultural landscape. ▪ Cumulative Impacts: <ul style="list-style-type: none"> ○ Construction and Decommissioning Phases: <ul style="list-style-type: none"> ▪ Potential impacts on archaeology. ▪ Potential impacts on graves. ○ Operational Phase: <ul style="list-style-type: none"> ▪ Potential impacts on the cultural landscape.

NEED	
Question	Response
	<p>Overall, with the recommended mitigation measures being implemented, the potential impacts have been rated with a low significance during the Scoping Phase. This will be further refined during the EIA Phase and the HIA will be included in the EIA Report. The HIA will also be sent to the South African Heritage Resources Agency (SAHRA) for comment during the EIA Phase.</p> <p>A Palaeontology Site Sensitivity Verification Report has been completed and included in Appendix G.7 of this Scoping Report. The Site Sensitivity Verification Report notes that the Screening Tool depicts a Medium to High palaeo-sensitivity for the majority of the study area. However, the specialist has recommended, based on a 2-day palaeontological site visit and several previous field-based and desktop Palaeontology Impact Assessment (PIA) studies in the broader De Aar – Kimberley region, that the study area is of Low to Very Low palaeo-sensitivity in general. If any fossiliferous deposits are exposed by surface clearance or excavations during the construction phase, the Chance Fossils Finds Protocol should be fully implemented. Provided that the Chance Fossil Finds Protocol is incorporated into the EMPr and fully implemented during the construction phase, there are no objections on palaeontological heritage grounds to authorisation of the proposed project. Pending the discovery of significant new fossil finds before or during construction, <u>no further specialist palaeontological studies, monitoring or mitigation are recommended for this proposed project.</u> Therefore, no further assessment is necessary from a palaeontology perspective, as explained in Appendix G.7.</p>
1.6. How will this development use and/or impact on non-renewable natural resources? What measures were explored to ensure responsible and equitable use of the resources? How have the consequences of the depletion of the non-renewable natural resources been considered? What measures were explored to firstly avoid these impacts, and where impacts could not be avoided altogether, what measures were explored to minimise and remedy (including offsetting) the impacts? What measures were explored to enhance positive impacts?	Measures to avoid, remedy, mitigate or manage impacts on non-renewable natural resources will be included in the EMPr that will be compiled during the EIA Phase and included in the EIA Report. However, the proposed project is focused on the use of renewable natural resources (i.e. a Solar PV Facility).
1.7. How will this development use and/or impact on renewable natural resources and the ecosystem of which they are part? Will the use of the resources and/or impact on the ecosystem jeopardise the integrity of the resource and/or system taking into account carrying capacity restrictions, limits of acceptable change, and	South Africa has heavily relied on coal as a source of electricity for decades. Due to the nature of coal as a non-renewable resource that causes major environmental degradation, there is a need to identify alternative resources that could promote sustainable energy as well as cleaner energy production mechanisms. The proposed project aims to harness

NEED	
Question	Response
<p>thresholds? What measures were explored to firstly avoid the use of resources, or if avoidance is not possible, to minimise the use of resources? What measures were taken to ensure responsible and equitable use of the resources? What measures were explored to enhance positive impacts?</p> <p>1.7.1. Does the proposed development exacerbate the increased dependency on increased use of resources to maintain economic growth or does it reduce resource dependency (i.e. de-materialised growth)? (note: sustainability requires that settlements reduce their ecological footprint by using less material and energy demands and reduce the amount of waste they generate, without compromising their quest to improve their quality of life)</p> <p>1.7.2. Does the proposed use of natural resources constitute the best use thereof? Is the use justifiable when considering intra- and intergenerational equity, and are there more important priorities for which the resources should be used (i.e. what are the opportunity costs of using these resources of the proposed development alternative?)</p> <p>1.7.3. Do the proposed location, type and scale of development promote a reduced dependency on resources?</p>	<p>the solar resources available in the area for the generation of electricity. This project is seen as a source of 'clean energy' and reduces the dependence on non-renewable sources. The proposed project is intended to form part of the Renewable Energy Independent Power Producer Programme (REIPPPP), and therefore aims to contribute to the energy mix of South Africa, in line with the Integrated Resource Plan (IRP). The need for renewable energy is clear, with South Africa becoming an integral part of the global transition towards renewable sources of electricity generation.</p> <p>The proposed project is a sustainable option for the area and the footprint will, as far as possible, avoid areas of very high environmental sensitivity. Where impacts cannot be avoided, the footprint will be placed to minimise, mitigate or manage potential impacts to the receiving environment.</p> <p>In addition, various Scoping Level Assessments have been compiled and are included in Appendix G of this Scoping Report. These Scoping Level Assessments have identified various potential negative impacts that the proposed project may result in. The associated high-level mitigation measures have also been identified. Such potential impacts are also summarised in Chapter 6 of this Scoping Report. All the potential impacts will be assessed in further detail and refined during the EIA Phase.</p>
<p>1.8. How were a risk-averse and cautious approach applied in terms of ecological impacts?</p> <p>1.8.1. What are the limits of current knowledge (note: the gaps, uncertainties and assumptions must be clearly stated)?</p> <p>1.8.2. What is the level of risk associated with the limits of current knowledge?</p> <p>1.8.3. Based on the limits of knowledge and the level of risk, how and to what extent was a risk-averse and cautious approach applied to the development?</p>	<p>The precautionary approach has been adopted for this study, i.e. assuming the maximum development scenario will occur and then identifying ways to mitigate or manage these impacts. In addition, the specialist assessments that will be compiled during the EIA Phase will provide detailed feedback on any uncertainties, assumptions, and risks associated with limits of current knowledge.</p>
<p>1.9. How will the ecological impacts resulting from this development impact on people's environmental right in terms following:</p>	<p>A detailed Socio-Economic Impact Assessment will be included in the EIA Report that will consider the impact of the proposed project from a socio-economic perspective. A preliminary socio-economic profile is included in Chapter 3 of this Scoping Report and will</p>

NEED	
Question	Response
<p>1.9.1. Negative impacts: e.g. access to resources, opportunity costs, loss of amenity (e.g. open space), air and water quality impacts, nuisance (noise, odour, etc.), health impacts, visual impacts, etc. What measures were taken to firstly avoid negative impacts, but if avoidance is not possible, to minimise, manage and remedy negative impacts?</p> <p>1.9.2. Positive impacts: e.g. improved access to resources, improved amenity, improved air or water quality, etc. What measures were taken to enhance positive impacts?</p>	<p>be further refined during the EIA Phase. Scoping Level inputs have been provided by the Socio-Economic specialist and have been included in Appendix G.8 of the Scoping Report. The Scoping Level assessment has identified the following impacts at this stage:</p> <ul style="list-style-type: none"> ▪ Construction Phase: <ul style="list-style-type: none"> ○ Potential positive impacts: <ul style="list-style-type: none"> ▪ Creation of employment and business opportunities, and opportunity for skills development and on-site training. ○ Potential negative impacts: <ul style="list-style-type: none"> ▪ Impacts associated with the presence of construction workers on local communities. ▪ Impacts related to the potential influx of job-seekers. ▪ Increased risks to livestock and farming infrastructure associated with the construction related activities and presence of construction workers on the site. ▪ Increased risk of grass fires associated with construction related activities. ▪ Nuisance impacts, such as noise, dust, and safety, associated with construction related activities and vehicles. ▪ Impact on productive farmland. ▪ Operational Phase: <ul style="list-style-type: none"> ○ Potential positive impacts: <ul style="list-style-type: none"> ▪ The establishment of infrastructure to improve energy security and support the renewable sector. ▪ Creation of employment opportunities. ▪ Benefits to the affected landowners. ▪ Benefits associated with the socio-economic contributions to community development. ○ Potential negative impacts: <ul style="list-style-type: none"> ▪ Visual impacts and associated impacts on sense of place. ▪ Impact on property values.

NEED	
Question	Response
	<ul style="list-style-type: none"> ▪ Impact on tourism. ▪ Decommissioning Phase: <ul style="list-style-type: none"> ○ Potential negative impacts: <ul style="list-style-type: none"> ▪ Social impacts associated with retrenchment including loss of jobs, and source of income.
1.10. Describe the linkages and dependencies between human wellbeing, livelihoods and ecosystem services applicable to the area in question and how the development's ecological impacts will result in socio-economic impacts (e.g. on livelihoods, loss of heritage site, opportunity costs, etc.)?	Linkages and dependencies between human wellbeing, livelihoods and ecosystem services applicable to the area will be considered as part of the relevant specialist assessments during the EIA Phase.
1.11. Based on all of the above, how will this development positively or negatively impact on ecological integrity objectives / targets / considerations of the area?	The impacts on ecological integrity objectives of the area will be considered as part of the Terrestrial Biodiversity and Plant and Animal Species, Aquatic Biodiversity, and Avifauna Impact Assessments that will be undertaken during the EIA Phase. Refer to the responses provided to Questions 1.1 to 1.10 regarding the sensitivities identified in these Scoping Level Assessments, as well as the potential high-level impacts identified on terrestrial biodiversity.
1.12. Considering the need to secure ecological integrity and a healthy biophysical environment, describe how the alternatives identified (in terms of all the different elements of the development and all the different impacts being proposed), resulted in the selection of the "best practicable environmental option" in terms of ecological considerations?	<p>Chapter 5 of this Scoping Report includes a full description of alternatives that will be assessed during the EIA Phase. The no-go alternative and technology alternatives (relating to the BESS) will be assessed during the EIA Phase. Note that the specialists will assess Lithium Ion and Redox Flow BESS technologies and if both are acceptable, it will be motivated to the DFFE in the EIA Phase that both options be approved in the EA (should it be granted).</p> <p>With regards to technology options, these include options relating to the solar PV system or mounting structure, however these will not be weighed against each other in order to identify the preferred alternative at the end of the EIA Phase. Instead, the specialists will assess various mounting systems and if acceptable, all will be put forward for approval in the EA (should it be granted).</p> <p>The approach followed to identify the buildable areas was to use environmental and social constraints to avoid sensitive features, thus applying mitigation hierarchy thinking. This</p>

NEED	
Question	Response
	approach replaces the need to rank alternative sites and locations, as it leads to the selection of the least sensitive development footprint.
1.13. Describe the positive and negative cumulative ecological/biophysical impacts bearing in mind the size, scale, scope and nature of the project in relation to its location and existing and other planned developments in the area?	Refer to Chapter 6 of this Scoping Report where the potential cumulative impacts are discussed, as well as each Scoping Level Specialist Assessment included in Appendix G. Chapter 7 of this Scoping Report contains a list of all other renewable energy projects within a 30 km radius that are being considered in the cumulative impact assessment. The cumulative impacts will be assessed during the EIA Phase.
2.1. What is the socio-economic context of the area, based on, amongst other considerations, the following considerations?	
2.1.1. The IDP (and its sector plans' vision, objectives, strategies, indicators and targets) and any other strategic plans, frameworks of policies applicable to the area.	<p>The proposed project is entirely located within the Renosterberg Local Municipality (RLM) and Pixley Ka Seme District Municipality (PKSDM).</p> <p>The Integrated Development Plan (IDP) for the RLM could not be sourced during the Scoping Phase. This is corroborated by the Socio-Economic Scoping Level Assessment (Appendix G.8), which notes that this is likely linked to the dissolution of RLM by the Northern Cape Provincial Government on 7 September 2020.</p> <p>However, the Final IDP (2022 – 2027) for the PKSDM that was adopted in June 2022 is available. The vision for the PKSDM is “<i>Sustainably Developed District for future Generations</i>” (PKSDM, 2022, Page 23¹²); and the mission is:</p> <ul style="list-style-type: none"> ▪ “<i>Supporting our local municipalities to create a home for all in our towns, settlements and rural areas to render dedicated services;</i> ▪ <i>Providing political and administrative leadership and direction in the development planning process;</i> ▪ <i>Promoting economic growth that is shared across and within communities;</i> ▪ <i>Promoting and enhancing integrated development planning in the operations of our municipalities; and</i>

¹² Pixley Ka Seme District Final Integrated Development Plan (IDP) 2022 – 2027. 2022. Available: [https://www.pksdm.gov.za/idps/PKSDM%20Final%20Integrated%20Development%20Plan%20\(IDP\)%202022-2027.pdf](https://www.pksdm.gov.za/idps/PKSDM%20Final%20Integrated%20Development%20Plan%20(IDP)%202022-2027.pdf). [online] Accessed: November 2022.

NEED	
Question	Response
	<ul style="list-style-type: none"> ▪ <i>Aligning development initiatives in the district to the National Development Plan.”</i> (PKSDM, 2022, Page 23). <p>The 2019-2020 IDP notes that the economy in the PKSDM is characterized by:</p> <ul style="list-style-type: none"> ▪ High levels of poverty and low levels of education. ▪ Low levels of development despite the strategic location in terms of the national transport corridors. ▪ High rate of unemployment, poverty and social grant dependence. ▪ Prone to significant environmental changes owing to long-term structural changes (such as climate change, energy crises and other shifts). <p>The IDP recognises renewable energy projects as potential sustainable economic development opportunities. The development of the proposed project will therefore also be in line with the vision of the PKSDM to diversify the job market by creating and supporting sustainable economic growth and development opportunities.</p> <p>The proposed project will create job opportunities and economic spin offs during the construction and operational phases (if an EA is granted by the DFFE). Approximately 150 employment opportunities will be created during the construction phase, and approximately 8 during the operational phase of the proposed project. It should, however, be noted that employment during the construction phase will be temporary, whilst the employment opportunities during the operational phase will be long-term.</p> <p>Therefore, the proposed project would help to address the need for increased electricity supply to the national grid while also providing advanced skills transfer and training to the local communities and creating contractual and permanent employment in the area. These factors are linked to the REIPPPP.</p>
<p>2.1.2. Spatial priorities and desired spatial patterns (e.g. need for integrated of segregated communities, need to upgrade informal settlements, need for densification, etc.)</p>	<p>This is not applicable as the proposed project is located within a rural area and the site is zoned for agricultural use.</p>

NEED	
Question	Response
<p>2.1.3. Spatial characteristics (e.g. existing land uses, planned land uses, cultural landscapes, etc.)</p>	<p>The Terrestrial Biodiversity and Plant and Animal Species Scoping Level Assessment (Appendix G.2) notes that the land within the study area is currently being used for livestock grazing, with some game animals such as springbok. Infrastructure such as homesteads, livestock pens, windpumps, waterpoints, gravel farm roads and fences are located on the affected properties. Furthermore, existing overhead powerlines run through the study area.</p> <p>An HIA will be undertaken during the EIA Phase to assess potential archaeological and cultural impacts resulting from the proposed project. A Scoping Level Heritage Assessment (Archaeology and Cultural Heritage) has been commissioned and is included in Appendix G.6 of this Scoping Report. Refer to the response to Question 1.5 for detailed feedback on the high-level impacts identified on Archaeology and Cultural Heritage at this stage, as well as feedback on the palaeontology.</p> <p>Should the proposed project proceed, it is not expected that the agricultural activities present on site will be significantly threatened. An Agricultural Compliance Statement has been included in Appendix G.1 of this Scoping Report based on a Scoping Level and will be refined and expanded on, where necessary, during the EIA Phase. The compliance statement considers the impact of the proposed project in terms of the land capability and agricultural potential. As noted in Appendix G.1, the proposed site is identified as being of predominantly low and medium sensitivity for agricultural resources.</p> <p>As noted, an EMPr will be compiled for the proposed project to ensure that all potential negative impacts identified are suitably managed and mitigated, and potential positive impacts are enhanced.</p> <p>The impact on the sense of place is difficult to predict and would potentially be ambiguous. This is due to the subjective nature of perceptions regarding the relative attraction or disturbance of the solar facilities in a rural landscape. The visual impact and considerations will be further assessed as part of the Visual Impact Assessment to be undertaken during the EIA Phase. A Scoping Level Visual Impact Assessment has been commissioned and is included in Appendix G.5 of this Scoping Report. The Scoping Level Visual Impact</p>

NEED	
Question	Response
	<p>Assessment has provided more accurate mapping of landscape features at the detailed project scale, being a refinement of the Screening Tool Landscape Sensitivity Map. No significant landscape or scenic features would be affected by the currently proposed project based on the Revised Scoping Buildable Areas.</p> <p>The preliminary sensitivity map is included in Chapter 3 and Chapter 7 of this Scoping Report and will be further refined during the EIA Phase following detailed specialist assessments. The sensitivities identified by the various specialists during the Scoping Phase have been taken into consideration and avoided where possible into order to identify the Revised Scoping Buildable Areas.</p>
2.1.4. Municipal Economic Development Strategy ("LED Strategy").	The LED Strategy will be considered, and potential alignment will be discussed in the EIA Report. However, the Final IDP (2022 – 2027 ¹⁰) for the PKSDM notes that one of the thrusts in the National LED Strategy is focused on renewable energy development and enhancing efficiency in the energy sector.
<p>2.2. Considering the socio-economic context, what will the socio-economic impacts be of the development (and its separate elements/aspects), and specifically also on the socio-economic objectives of the area?</p> <p>2.2.1. Will the development complement the local socio-economic initiatives (such as local economic development (LED) initiatives), or skills development programs?</p>	<p>This will be addressed in the Socio-Economic Impact Assessment that will be included in the EIA Report. The assessment will consider the impact of the proposed project from a socio-economic perspective. As noted in the Socio-Economic Scoping Level Assessment (Appendix G.8 of the Final Scoping Report), the REIPPPP has contributed significantly towards meeting South Africa's Greenhouse Gas emission targets and, at the same time, supporting energy security, economic stability, and environmental sustainability. The establishment of renewable energy facilities, such as the proposed project, therefore, not only address the environmental issues associated with climate change and consumption of scarce water resources, but also creates significant socio-economic opportunities and benefits, specifically for historically disadvantaged, rural communities.</p> <p>A preliminary socio-economic profile is included in Chapter 3 of this Scoping Report and will be further refined during the EIA Phase. Scoping Level inputs have been provided by the Socio-Economic specialist and have been included in Appendix G.8 of the Scoping Report. Refer to the response provided to Question 1.9 for a description of the impacts identified at the Scoping Level.</p>
2.3. How will this development address the specific physical, psychological, developmental, cultural and social needs and interests of the relevant communities?	These needs and interests of the relevant communities will be addressed in the Socio-Economic Impact Assessment that will be included in the EIA Report. Issues raised by

NEED	
Question	Response
	Interested and Affected Parties (I&APs) to this effect will also be addressed in the relevant Issues and Responses Trail of the EIA Report. An Issues and Responses Trail is also included in Appendix E.5 of this Scoping Report, which includes all comments raised during the release of the Background Information Document (BID), with responses provided by the EIA Project Team. Appendix E.11 includes the Issues and Responses Trail for all issues raised by I&APs during the 30-day review of the Draft Scoping Report, as well as corresponding responses.
2.4. Will the development result in equitable (intra- and inter-generational) impact distribution, in the short- and long term? Will the impact be socially and economically sustainable in the short- and long-term?	This will be addressed in the Socio-Economic Impact Assessment that will be included in the EIA Report. The assessment will consider the impact of the proposed project from a socio-economic perspective. Scoping Level inputs have been provided by the Socio-Economic specialist and have been included in Appendix G.8 of the Scoping Report. Refer to the response provided to Question 1.9 for a description of the impacts identified at the Scoping Level.
2.5. In terms of location, describe how the placement of the proposed development will:	
2.5.1. result in the creation of residential and employment opportunities in close proximity to or integrated with each other	Local employment opportunities will be provided as far as possible. Approximately 150 employment opportunities will be created during the construction phase, and approximately 8 during the operational phase of the proposed project. It should, however, be noted that employment during the construction phase will be temporary, whilst the employment opportunities during the operational phase will be long-term.
2.5.2. reduce the need for transport of people and goods	This is not applicable as the proposed project is located within a remote rural area and the site is zoned for agricultural use. This project is a renewable energy project proposal. Nevertheless, traffic related impacts of the proposed project will be addressed in the Traffic Impact Assessment during the EIA Phase. A Scoping Level Assessment has been provided in Appendix G.9 of this Scoping Report.
2.5.3. result in access to public transport or enable non-motorised and pedestrian transport (e.g. will the development result in densification and the achievement of thresholds in terms public transport)	This is not applicable as the proposed project is located within a remote rural area and the site is zoned for agricultural use. This project is a renewable energy project proposal. Refer to the response provided to Question 2.5.2.
2.5.4. compliment other uses in the area	As noted above, the land within the study area is currently being used for livestock grazing. The Agricultural Compliance Statement (Appendix G.1) notes the following:

NEED	
Question	Response
	<ul style="list-style-type: none"> ▪ The proposed project will occupy land that is of very limited land capability, which is insufficient for crop production. There is no scarcity of such agricultural land in South Africa and its conservation for agricultural production is not therefore a priority. ▪ The amount of agricultural land used by the proposed project is well within the allowable development limits prescribed by the Agricultural Protocol of GN 320. ▪ The proposed project offers positive impact on agriculture by way of improved financial security for farming operations, as well as security benefits against stock theft and other crime. ▪ The proposed development will also have the wider societal benefits of generating additional income and employment in the local economy. <p>Based on the above, the proposed project is understood to compliment other uses in the area.</p>
2.5.5. be in line with the planning for the area	<p>The Final IDP (2022 – 2027¹⁰) for the PKSDM identifies solar energy as a development opportunity in the RLM.</p> <p>Based on the Scoping Level Socio-Economic Assessment (Appendix G.8 of this Scoping Report), the 2017 PKSDM Spatial Development Framework (SDF) notes the establishment of a Renewable Energy Hub stretching from the west coast up to De Aar region.</p> <p>Furthermore, the proposed project is also located within the Central Strategic Transmission Corridor that was gazetted in February 2018. This facilitates large scale transmission and distribution EGI, which would be needed to support the proposed project. Therefore, the proposed project is in line with the planning for the area.</p>
2.5.6. for urban related development, make use of the underutilised land available with the urban edge	<p>This is not applicable as the proposed project is located within a remote rural area and the site is zoned for agricultural use.</p>
2.5.7. optimise the use of existing resources and infrastructure	<p>The proposed project is planned to connect to the existing Hydra-Perseus 400 kV overhead power line via dedicated proposed 132 kV power lines and an independent Main Transmission Substation (MTS). However, if the proposed Eskom Hydra B Substation is built by Eskom, then additional upgrades of this Eskom substation would be undertaken to ensure that the substation can accommodate the power generated by the proposed 12</p>

SCOPING REPORT: Scoping and Environmental Impact Assessment (EIA) Process for the Proposed Development of a Solar Photovoltaic (PV) Facility (Kudu Solar Facility 2) and associated infrastructure, near De Aar, Northern Cape Province

NEED	
Question	Response
	Kudu Solar Facilities. This is being considered as to minimise impacts and make use of existing infrastructure. Separate Basic Assessment (BA) and/or EGI Standard Registration Processes will be undertaken for the EGI Projects (Projects 13 – 26).
2.5.8. opportunity costs in terms of bulk infrastructure expansions in non-priority areas (e.g. not aligned with the bulk infrastructure planning for the settlement that reflects the spatial reconstruction priorities of the settlement)	The proposed project is a renewable energy project and not related to bulk infrastructure expansion.
2.5.9. discourage "urban sprawl" and contribute to compaction/densification	This will be addressed in the Socio-Economic Impact Assessment that will be included in the EIA Report.
2.5.10. contribute to the correction of the historically distorted spatial patterns of settlements and to the optimum use of existing infrastructure in excess of current needs	This is not applicable as the proposed project is located within a remote rural area and the site is zoned for agricultural use.
2.5.11. encourage environmentally sustainable land development practices and processes	The development of a renewable energy facility is a sustainable land development practice provided it is constructed and operated in an environmentally conscious manner.
2.5.12. take into account special locational factors that might favour the specific location (e.g. the location of a strategic mineral resource, access to the port, access to rail, etc.)	Refer to Chapter 5 of this Scoping Report for a description of the process undertaken to identify the study area as the preferred site for the solar PV facility.
2.5.13. the investment in the settlement or area in question will generate the highest socio-economic returns (i.e. an area with high economic potential)	This will be addressed within the Socio-Economic Impact Assessment that will be included in the EIA Report.
2.5.14. impact on the sense of history, sense of place and heritage of the area and the socio-cultural and cultural-historic characteristics and sensitivities of the area	<p>An HIA will be undertaken during the EIA Phase to assess potential archaeological and cultural impacts resulting from the proposed project. A Scoping Level Heritage Assessment (Archaeology and Cultural Heritage) has been commissioned and is included in Appendix G.6 of this Scoping Report. Refer to the response to Question 1.5 for detailed feedback on the high-level impacts identified on Archaeology and Cultural Heritage at this stage, as well as feedback on the palaeontology.</p> <p>The visual impact and considerations, including sense of place, will be further assessed as part of the Visual Impact Assessment to be undertaken as part of the EIA Phase. A Scoping Level Visual Impact Assessment has been commissioned and is included in Appendix G.5 of this Scoping Report. Refer to the response provided to Question 2.1.3 for additional feedback on the potential visual impacts.</p>

NEED	
Question	Response
2.5.15. in terms of the nature, scale and location of the development promote or act as a catalyst to create a more integrated settlement?	Several renewable energy projects have been granted EA in the vicinity of De Aar and the surrounding region. Chapter 7 of this Scoping Report includes a list of other renewable energy projects within a 30 km radius that have received EA or are currently going through an Environmental Assessment process.
2.6. How were a risk-averse and cautious approach applied in terms of socio-economic impacts?	
2.6.1. What are the limits of current knowledge (note: the gaps, uncertainties and assumptions must be clearly stated)?	The precautionary approach has been adopted for this study, i.e. assuming the maximum development scenario will occur and then identifying ways to mitigate or manage these impacts. In addition, the specialist assessments that will be compiled during the EIA Phase will provide detailed feedback on any uncertainties, assumptions, and risks associated with limits of current knowledge. The Socio-Economic Scoping Level Specialist Assessment included in Appendix G.8 of this Scoping Report provides high-level input on the assumptions and limitations at the scoping phase.
2.6.2. What is the level of risk (note: related to inequality, social fabric, livelihoods, vulnerable communities, critical resources, economic vulnerability and sustainability) associated with the limits of current knowledge?	
2.6.3. Based on the limits of knowledge and the level of risk, how and to what extent was a risk-averse and cautious approach applied to the development?	
2.7. How will the socio-economic impacts resulting from this development impact on people's environmental right in terms following:	
2.7.1. Negative impacts: e.g. health (e.g. HIV-Aids), safety, social ills, etc. What measures were taken to firstly avoid negative impacts, but if avoidance is not possible, to minimise, manage and remedy negative impacts?	A detailed Socio-Economic Impact Assessment will be included in the EIA Report that will consider the impact of the proposed project from a socio-economic perspective. A preliminary socio-economic profile is included in Chapter 3 of this Scoping Report and will be further refined during the EIA Phase. Scoping Level inputs have been provided by the Socio-Economic specialist and have been included in Appendix G.8 of the Scoping Report. Refer to the response provided to Question 1.9 for a description of the impacts identified in the Socio-Economic Scoping Level assessment
2.7.2. Positive impacts. What measures were taken to enhance positive impacts?	
2.8. Considering the linkages and dependencies between human wellbeing, livelihoods and ecosystem services, describe the linkages and dependencies applicable to the area in question and how the development's socioeconomic impacts will result in ecological impacts (e.g. over utilisation of natural resources, etc.)?	In addition, measures to avoid, remedy, mitigate or manage negative socio-economic impacts and enhance positive socio-economic impacts will be included in the EMPr that will be compiled during the EIA Phase and included in the EIA Report.
2.9. What measures were taken to pursue the selection of the "best practicable environmental option" in terms of socio-economic considerations?	Linkages and dependencies between human wellbeing, livelihoods and ecosystem services applicable to the area, as well as how the potential socio-economic impacts will
2.10. What measures were taken to pursue environmental justice so that adverse environmental impacts shall not be distributed in such a manner as to unfairly	

NEED	
Question	Response
discriminate against any person, particularly vulnerable and disadvantaged persons (who are the beneficiaries and is the development located appropriately)? Considering the need for social equity and justice, do the alternatives identified, allow the "best practicable environmental option" to be selected, or is there a need for other alternatives to be considered?	result in ecological impacts will be considered as part of the relevant specialist assessments during the EIA Phase.
2.11. What measures were taken to pursue equitable access to environmental resources, benefits and services to meet basic human needs and ensure human wellbeing, and what special measures were taken to ensure access thereto by categories of persons disadvantaged by unfair discrimination?	With regards to the best practicable environmental option, Chapter 5 of this Scoping Report includes a full description of alternatives that will be assessed during the EIA Phase. The no-go alternative and technology alternatives (relating to the BESS) will be assessed during the EIA Phase. Refer to the response provided to Question 1.12 above for additional information on the alternatives to be considered.
2.12. What measures were taken to ensure that the responsibility for the environmental health and safety consequences of the development has been addressed throughout the development's life cycle?	
2.13. What measures were taken to:	
2.13.1. ensure the participation of all interested and affected parties	The Public Participation Process (PPP) that is being undertaken during the Scoping Phase is described in Chapter 4 of this Scoping Report, and the PPP that will be undertaken during the EIA Phase is described in Chapter 7 of this Scoping Report. The PPP will comply with the 2014 NEMA EIA Regulations (as amended). The Draft Scoping Report was released for a 30-day comment period, extending from 9 December 2022 to 30 January 2023, to all the relevant authorities, I&APs and stakeholders. Various methods were employed to notify potential I&APs of the proposed project, namely, through newspaper advertisements, site notices boards, notification letters and communication via email, as well as text messages, and telephonic discussions where possible.
2.13.2. provide all people with an opportunity to develop the understanding, skills and capacity necessary for achieving equitable and effective participation	
2.13.3. ensure participation by vulnerable and disadvantaged persons	
2.13.4. promote community wellbeing and empowerment through environmental education, the raising of environmental awareness, the sharing of knowledge and experience and other appropriate means	
2.13.5. ensure openness and transparency, and access to information in terms of the process	
	The Scoping and EIA Process will aim to take cognisance of all interests, needs, and values espoused by all I&APs. Opportunity for public participation will be provided to all I&APs throughout the Scoping and EIA Process in terms of the 2014 NEMA EIA Regulations (as amended).
	The PPP that is being undertaken during the Scoping Phase is described in Chapter 4 of this Scoping Report, and the PPP that will be undertaken during the EIA Phase is described in Chapter 7 of this Scoping Report. Refer to the responses provided to Questions 2.13.1 – 2.13.3 above.

NEED	
Question	Response
2.13.6. ensure that the interests, needs and values of all interested and affected parties were taken into account and that adequate recognition were given to all forms of knowledge, including traditional and ordinary knowledge	The EIA process will take cognisance of relevant interests, needs and values adopted by I&APs.
2.13.7. ensure that the vital role of women and youth in environmental management and development were recognised and their full participation therein was promoted	Public participation of all I&APs will be promoted and opportunities for engagement will be provided during the EIA process.
2.14. Considering the interests, needs and values of all the interested and affected parties, describe how the development will allow for opportunities for all the segments of the community (e.g. a mixture of low-, middle-, and high-income housing opportunities) that is consistent with the priority needs of the local area (or that is proportional to the needs of an area)?	This will be addressed in the Socio-Economic Impact Assessment that will be included in the EIA Report. Refer to the responses provided to Questions 1.9, 2.2 and 2.3.
2.15. What measures have been taken to ensure that current and/or future workers will be informed of work that potentially might be harmful to human health or the environment or of dangers associated with the work, and what measures have been taken to ensure that the right of workers to refuse such work will be respected and protected?	An EMPr will be developed during the EIA Phase to address environmental, health and safety concerns. An Environmental Control Officer (ECO) will be appointed to monitor compliance with the EMPr and EA (should such authorisation be granted) during the construction and operational phases.
2.16. Describe how the development will impact on job creation in terms of, amongst other aspects:	
2.16.1. the number of temporary versus permanent jobs that will be created	This will be addressed in the Socio-Economic Impact Assessment that will be included in the EIA Report. Refer to the response provided to Question 1.9 for a description of the impacts identified at the Scoping Level from a socio-economic perspective, and also the responses to Questions 2.1.1 and 2.5.1 for feedback on potential employment opportunities.
2.16.2. whether the labour available in the area will be able to take up the job opportunities (i.e. do the required skills match the skills available in the area)	
2.16.3. the distance from where labourers will have to travel	
2.16.4. the location of jobs opportunities versus the location of impacts (i.e. equitable distribution of costs and benefits)	
2.16.5. the opportunity costs in terms of job creation (e.g. a mine might create 100 jobs, but impact on 1000 agricultural jobs, etc.).	

SCOPING REPORT: Scoping and Environmental Impact Assessment (EIA) Process for the Proposed Development of a Solar Photovoltaic (PV) Facility (Kudu Solar Facility 2) and associated infrastructure, near De Aar, Northern Cape Province

NEED	
Question	Response
2.17. What measures were taken to ensure:	
2.17.1. that there were intergovernmental coordination and harmonisation of policies, legislation and actions relating to the environment	Various government departments have been listed as I&APs and were given the opportunity to comment on the Draft Scoping Report and will be given the opportunity to comment on the Draft EIA Report during the 30-day public participation period.
2.17.2. that actual or potential conflicts of interest between organs of state were resolved through conflict resolution procedures?	This will be determined during the EIA Phase (following the PPP undertaken as part of the Scoping Phase).
2.18. What measures were taken to ensure that the environment will be held in public trust for the people, that the beneficial use of environmental resources will serve the public interest, and that the environment will be protected as the people's common heritage?	The proposed project will adhere to the principles of environmental management in NEMA. Measures taken to ensure adherence to the principles of NEMA will be determined during the EIA Phase. In addition, the outcomes of this Scoping and EIA Process and the associated conditions of the EA (should it be received) will serve to address this question.
2.19. Are the mitigation measures proposed realistic and what long-term environmental legacy and managed burden will be left?	It would be premature to decide whether proposed mitigation measures are realistic prior to the completion of the Impact Assessment Phase of this Scoping and EIA Process. Therefore, the practicality of mitigation measures shall be determined during the EIA Phase. The proposed mitigation measures to be included in the EMPr will be informed by the specialist studies undertaken. This will include a detailed assessment of the environment as well as the impacts associated with the proposed development.
2.20. What measures were taken to ensure that the costs of remedying pollution, environmental degradation and consequent adverse health effects and of preventing, controlling or minimising further pollution, environmental damage or adverse health effects will be paid for by those responsible for harming the environment?	The EMPr for the proposed project (to be included in the EIA Report) will form part of the contractual agreement and must be adhered to by the contractors, construction workers and the Project Applicant. The EMPr will include measures to ensure that the costs to potentially remedy pollution, environmental degradation and consequent adverse health effects will be paid for by those responsible for the relevant environmental impacts. The EMPr will accordingly include measures to ensure that the costs to potentially prevent, control or minimise further pollution, environmental damage or adverse health effects will be paid for by those responsible for the relevant environmental impacts. Roles and responsibilities for the implementation of management actions, and monitoring thereof will be included in the EMPr.
2.21. Considering the need to secure ecological integrity and a healthy bio-physical environment, describe how the alternatives identified (in terms of all the different elements of the development and all the different impacts being proposed), resulted in the selection of the best practicable environmental option in terms of socio-economic considerations?	Agriculture on site is influenced by climatic variables and limitations. Renewable energy development is a suitable land use option for the site. The proposed project would be more robust in terms of economic viability and profitability while also being largely uninfluenced by climate change variables. The proposed project would also provide the

NEED	
Question	Response
	<p>farm owners with additional income by way of lease agreements and will also contribute to local socio-economic upliftment through job creation.</p> <p>Chapter 5 of this Scoping Report includes a full description of alternatives that will be assessed during the EIA Phase. The no-go alternative and technology alternatives (relating to the BESS) will be assessed during the EIA Phase. Refer to the response provided to Question 1.12 above for additional information on the alternatives to be considered.</p>
<p>2.22. Describe the positive and negative cumulative socio-economic impacts bearing in mind the size, scale, scope, and nature of the project in relation to its location and other planned developments in the area?</p>	<p>The potential cumulative impacts resulting from the proposed project can only be objectively determined at the end of the EIA process. These will be assessed as part of the EIA Phase.</p> <p>Refer to Chapter 6 of this Scoping Report where the potential cumulative impacts are discussed for this project, where relevant, as well as the Socio-Economic Scoping Level Specialist Assessment included in Appendix G.8. The Socio-Economic Scoping Level Specialist Assessment identified the following cumulative impacts at this stage:</p> <ul style="list-style-type: none"> ▪ Cumulative impact on sense of place (negative impact). ▪ Cumulative impact on services (negative impact). ▪ Cumulative impact on local economies (positive impact). <p>Chapter 7 of this Scoping Report contains a list of all other renewable energy projects within a 30 km radius that are being considered in the cumulative impact assessment. The cumulative impacts will be assessed during the EIA Phase.</p>

1.9. Objectives for this Scoping Report

The Scoping Phase of the EIA refers to the process of determining the spatial and temporal boundaries for the EIA. In broad terms, the objectives of the Scoping Process in terms of the 2014 NEMA EIA Regulations (as amended) are to:

- Confirm the process to be followed and opportunities for stakeholder engagement;
- Clarify the project scope to be covered;
- Identify and confirm the preferred activity and technology alternative;
- Identify and confirm the preferred site for the preferred activity;
- Identify the key issues to be addressed in the impact assessment phase and the approach to be followed in addressing these issues; and
- Confirm the level of assessment to be undertaken during the impact assessment.

This is achieved through parallel initiatives of consulting with:

- The lead authorities involved in the decision-making for this Application for EA;
- The public to ensure that local issues are well understood; and
- The EIA specialist team to ensure that technical issues are identified.

The Scoping Process is supported by a review of relevant background literature on the local area. Through this comprehensive process, the environmental assessment can identify and focus on key issues requiring further assessment during the EIA Phase.

The primary objective of the Scoping Report is to present key stakeholders (including affected organs of state) with an overview of the proposed project and key issues that require assessment in the EIA Phase and allows the opportunity for the identification of additional issues that may require assessment.

Issues raised in response to the Draft Scoping Report that was released for a 30-day comment period, extending from 9 December 2022 to 30 January 2023, have been captured in the Issues and Responses Trail, which is included in Appendix E.11 of this Final Scoping Report. The Final Scoping Report is currently being submitted to the DFFE for decision-making (i.e. approval or rejection) in line with Regulation 21 (1) of GN R326. This approval is planned to mark the end of the Scoping Phase after which the EIA Process moves into the impact assessment and reporting phase.

In terms of legal requirements, a crucial objective of the Scoping Report is to satisfy the requirements of Appendix 2 of the 2014 NEMA EIA Regulations (as amended), as noted in Regulation 21 (3) of the GN R326. This section regulates and prescribes the content of the Scoping Report and specifies the type of supporting information that must accompany the submission of the Scoping Report to the authorities. An overview of where the requirements of Appendix 2 of the 2014 NEMA EIA Regulations (as amended) are addressed in this Scoping Report is presented in Table 1.3.

Furthermore, this process has been designed to satisfy the requirements of Regulations 41, 42, 43 and 44 of the 2014 NEMA EIA Regulations (as amended) relating to the PPP and, specifically, the registration of and submissions from Interested and Affected Parties (I&APs).

Table 1.3: Compliance with Appendix 2 of the 2014 NEMA EIA Regulations (as amended)

Section of the EIA Regulations	Requirements for a Scoping Report in terms of Appendix 2 of the 2014 NEMA EIA Regulations (as amended, GN R326)	Chapter / Appendix
Appendix 2 - (2)(1)(a)	Details of - i. the EAP who prepared the report; and ii. the expertise of the EAP, including a curriculum vitae;	Chapter 1, Appendix A and Appendix B
Appendix 2 - (2)(1)(b)	The location of the activity, including - i. the 21-digit Surveyor General code of each cadastral land parcel; ii. where available, the physical address and farm name; iii. where the required information in items (i) and (ii) is not available, the coordinates of the boundary of the property or properties;	Chapter 1 and Chapter 2
Appendix 2 - (2)(1)(c)	A plan which locates the proposed activity or activities applied for at an appropriate scale, or if it is - i. a linear activity, a description, and coordinates of the corridor in which the proposed activity or activities is to be undertaken; or ii. on land where the property has not been defined, the coordinates within which the activity is to be undertaken;	Chapter 1, Chapter 2, Chapter 3, Chapter 7, Appendix C and Appendix G
Appendix 2 - (2)(1)(d)	A description of the scope of the proposed activity, including – i. all listed and specified activities triggered; ii. a description of the activities to be undertaken, including associated structures and infrastructure;	Chapter 2 and Chapter 4
Appendix 2 - (2)(1)(e)	A description of the policy and legislative context within which the development is proposed including an identification of all legislation, policies, plans, guidelines, spatial tools, municipal development planning frameworks and instruments that are applicable to this activity and are to be considered in the assessment process;	Chapter 4
Appendix 2 - (2)(1)(f)	A motivation for the need and desirability for the proposed development including the need and desirability of the activity in the context of the preferred location;	Chapter 1
Appendix 2 - (2)(1)(g)	A full description of the process followed to reach the proposed preferred activity, site and location of the development footprint within the site, including - i. details of all the alternatives considered;	Chapter 5
	ii. details of the public participation process undertaken in terms of regulation 41 of the Regulations, including copies of the supporting documents and inputs;	Chapter 4, Appendix D, Appendix E, Appendix F
	iii. a summary of the issues raised by interested and affected parties, and an indication of the manner in which the issues were incorporated, or the reasons for not including them;	Chapter 6, Chapter 7, and Appendix E (specifically Appendix E.5 and Appendix E.11)
	iv. the environmental attributes associated with the alternatives focusing on the geographical, physical, biological, social, economic, heritage and cultural aspects;	Chapter 3, Chapter 5, Chapter 6 and Appendix G
	v. the impacts and risks which have informed the identification of each alternative, including nature, significance, consequence, extent, duration, and probability of such identified impacts, including the degree to which these impacts – (aa) can be reversed; (bb) may cause irreplaceable loss of resources; and (cc) can be avoided, managed or mitigated;	Chapter 5, Chapter 6 and Appendix G

SCOPING REPORT: Scoping and Environmental Impact Assessment (EIA) Process for the Proposed Development of a Solar Photovoltaic (PV) Facility (Kudu Solar Facility 2) and associated infrastructure, near De Aar, Northern Cape Province

Section of the EIA Regulations	Requirements for a Scoping Report in terms of Appendix 2 of the 2014 NEMA EIA Regulations (as amended, GN R326)	Chapter / Appendix
	vi. the methodology used in identifying and ranking the nature, significance, consequences, extent, duration, and probability of potential environmental impacts and risks associated with the alternatives;	Chapter 7 and Appendix G
	vii. positive and negative impacts that the proposed activity and alternatives will have on the environment and on the community that may be affected focusing on the geographical, physical, biological, social, economic, heritage and cultural aspects;	Chapter 5, Chapter 6 and Appendix G
	viii. the possible mitigation measures that could be applied and level of residual risk;	Chapter 5, Chapter 6 and Appendix G
	ix. the outcome of the site selection matrix;	Chapter 5
	x. if no alternatives, including alternative locations for the activity, were investigated, the motivation for not considering such; and	Chapter 5
	xi. a concluding statement indicating the preferred alternatives, including the preferred location of the activity;	Chapter 5
Appendix 2 - (2)(1)(h)	A plan of study for undertaking the environmental impact assessment process to be undertaken, including - <ul style="list-style-type: none"> i. a description of the alternatives to be considered and assessed within the preferred site, including the option of not proceeding with the activity; ii. a description of the aspects to be assessed as part of the environmental impact assessment process; iii. aspects to be assessed by specialists; iv. a description of the proposed method of assessing the environmental aspects, including aspects to be assessed by specialists; v. a description of the proposed method of assessing duration and significance; vi. an indication of the stages at which the competent authority will be consulted; vii. particulars of the public participation process that will be conducted during the environmental impact assessment process; and viii. a description of the tasks that will be undertaken as part of the environmental impact assessment process; ix. identify suitable measures to avoid, reverse, mitigate or manage identified impacts and to determine the extent of the residual risks that need to be managed and monitored. 	Chapter 7
Appendix 2 - (2)(1)(i)	An undertaking under oath or affirmation by the EAP in relation to - <ul style="list-style-type: none"> i. the correctness of the information provided in the report; ii. the inclusion of comments and inputs from stakeholders and interested and affected parties; and iii. any information provided by the EAP to interested and affected parties and any responses by the EAP to comments or inputs made by interested or affected parties; 	Appendix B
Appendix 2 - (2)(1)(j)	An undertaking under oath or affirmation by the EAP in relation to the level of agreement between the EAP and interested and affected parties on the plan of study for undertaking the environmental impact assessment;	Appendix B
Appendix 2 - (2)(1)(k)	Where applicable, any specific information required by the competent authority.	Not Applicable

SCOPING REPORT: Scoping and Environmental Impact Assessment (EIA) Process for the
Proposed Development of a Solar Photovoltaic (PV) Facility (Kudu Solar Facility 2) and
associated infrastructure, near De Aar, Northern Cape Province

Section of the EIA Regulations	Requirements for a Scoping Report in terms of Appendix 2 of the 2014 NEMA EIA Regulations (as amended, GN R326)	Chapter / Appendix
Appendix 2 - (2)(1)(l)	Any other matter required in terms of section 24(4)(a) and (b) of the Act.	N/A
Appendix 2 - (2)(2)	Where a government notice gazetted by the Minister provides for any protocol or minimum information requirement to be applied to a scoping report, the requirements as indicated in such notice will apply.	Not applicable in terms of the Scoping Report, however various gazetted assessment and reporting protocols will be complied with for the specialist studies in the EIA Phase. Refer to Chapter 4 of this Scoping Report for additional information.



CHAPTER 2: Project Description





CONTENTS

2. PROJECT DESCRIPTION	2-3
2.1 Definition of Project Study Area	2-3
2.2 Project Locality and Co-ordinates	2-6
2.3 Key components of the proposed project	2-7
2.3.1 Solar PV Facilities – Solar Field	2-12
2.3.2 Infrastructure within the PV Facility	2-13
2.3.2.1 Inverters, Low Voltage Cables, and Medium Voltage Cables	2-13
2.3.2.2 On-site Substation Complex	2-14
2.3.2.3 Battery Energy Storage System	2-14
2.3.2.4 Internal Roads	2-17
2.3.2.5 Panel Maintenance and Cleaning Area	2-17
2.3.2.6 Storm water	2-17
2.3.2.7 Auxiliary Building Infrastructure	2-18
2.3.2.8 Additional Infrastructure	2-18
2.3.3 External Access Roads	2-19
2.3.4 Service Provision	2-22
2.3.4.1 Water Usage	2-22
2.3.4.2 Sewage or Liquid Effluent	2-24
2.3.4.3 Solid Waste Generation	2-24
2.3.4.4 Electricity Requirements	2-25
2.4 Socio-Economic	2-25
2.4.1 Employment during Construction	2-25
2.4.2 Employment during Operations	2-25
2.4.3 Socio-Economic Investment and Development	2-25
2.5 Overview of the Project Development Cycle	2-26
2.5.1 Planning and Design Phase	2-26
2.5.2 Construction Phase	2-26
2.5.3 Operational Phase	2-27
2.5.4 Decommissioning Phase	2-27

TABLES

Table 2.1:	Farm Properties forming the study area	2-3
Table 2.2:	Affected Farm Properties for the proposed project	2-6
Table 2.3:	Co-ordinates of the Mid-Point of the proposed project	2-7
Table 2.4:	Description of the components of the proposed project	2-8

FIGURES

Figure 2.1:	A) Evolution of the Study Area / Preferred Site into the Scoping Buildable Areas / development footprints; B) Detailed view of the Project Study Area / Preferred Site, Original Scoping Buildable Area and Revised Scoping Buildable Area (development footprints).	2-5
Figure 2.2:	Affected and Adjacent Farm Portions for the study area	2-7
Figure 2.3:	Schematic overview of the Kudu Solar Facilities and EGI Connection.	2-11
Figure 2.4:	Components of the Proposed PV Installation	2-12
Figure 2.5:	Example of PV Technology (Department of Environment, Forestry and Fisheries (DEFF), 2019).	2-13
Figure 2.6:	Example of PV Technology with Lithium Ion BESS (ARENAWIRE, 2018)	2-15
Figure 2.7:	Schematic diagram of a typical Redox Flow Battery (Source: Parsons, 2017 ⁴)	2-16
Figure 2.8:	Proposed Access Routes to the study area (Sturgeon Consulting, 2022 ⁷)	2-20
Figure 2.9:	Potential Access Route Option 1: Divisional Road 3093 (Photograph taken from the R48) (Sturgeon, 2022)	2-20
Figure 2.10:	Potential Access Route Option 2: Main Road 790 (Photograph taken from the R48) (Sturgeon, 2022)	2-21
Figure 2.11:	Potential Access Route Option 3: Divisional Road 3096 (Photograph taken from the R48) (Sturgeon, 2022)	2-21

2. PROJECT DESCRIPTION

This chapter provides an overview of the conceptual project design and technology for the proposed Kudu Solar Facility 2 and associated infrastructure, as provided by the Project Developer, ABO Wind renewable energies (Pty) Ltd (hereafter “ABO Wind”).

The purpose of this chapter is to present sufficient project information on the proposed project to inform the Scoping and Environmental Impact Assessment (EIA) Process in terms of design parameters applicable to the project.

As noted in Chapter 1 of this Scoping Report, ABO Wind is proposing to develop 12 Solar Photovoltaic (PV) power generation facilities and associated Electrical Grid Infrastructure (EGI), north-east of the town of De Aar, in the Renosterberg Local Municipality and Pixley Ka Seme District Municipality, in the Northern Cape Province. The Solar PV Facilities are referred to as Projects 1 to 12, and the related EGI projects are referred to as Projects 13 to 26. Separate Scoping Reports have been compiled for each Solar Facility. This Scoping Report only addresses **Project 2** (i.e. Kudu Solar Facility 2 and associated infrastructure) (hereafter referred to as the “Kudu Solar Facility” or “proposed project”).

In terms of the EGI projects (i.e. Projects 13 to 26), these address the proposed grid connection from the proposed Kudu Solar Facilities to the nearby Eskom Hydra-Perseus 400 kV Overhead Power Line; and separate Basic Assessment (BA) Processes and/or adoption of the EGI Standard (Government Gazette 47095; Government Notice (GN) 2313, dated 27 July 2022) will be followed for these projects.

2.1 Definition of Project Study Area

The **study area or preferred site** for all the proposed Kudu Solar Facilities is the **full extent** of the **eight affected farm properties** on which the proposed PV Facilities are planned to be constructed. These farm properties are listed in Table 2.1. The full extent of these properties has been assessed by the specialists to identify environmental sensitivities and no-go areas. The preferred site or **total study area** for all the Kudu Solar Facilities is approximately **8 150 hectares (ha)**. The preferred site serves as the study area for this Scoping and EIA Process. Therefore, the terms “site” and “study area” are used synonymously in this report.

Table 2.1: Farm Properties forming the study area

FARM PORTION	SG CODE
Remaining Extent of the Farm Bas Berg No. 88	C0570000000008800000
Remaining Extent of Portion 3 of the Farm Bas Berg No. 88	C0570000000008800003
Portion 4 (Portion of Portion 3) of the Farm Bas Berg No. 88	C0570000000008800004
Remaining Extent of Portion 2 (Middel Plaats) (a Portion of Portion 1) of the Farm Grasspan No. 40	C0570000000004000002
Remaining Extent of the Farm Annex Wolve Kuil No. 41	C0570000000004100000
Portion 1 (Wolve Kuil West) of the Farm Annex Wolve Kuil No. 41	C0570000000004100001
Portion 2 of the Farm Wolve Kuil No. 43	C0570000000004300002
Remaining Extent of the Farm Wolve Kuilen No. 42	C0570000000004200000

At the commencement of this Scoping and EIA Process, the **Original Scoping Buildable Areas** which fall within the study area / preferred site, were identified by the Project Applicant following the completion of high-level environmental screening based on the Screening Tool. The Scoping Buildable Areas serve as the “development footprints” for the 12 proposed PV facilities and fall within the preferred site / study area.

As part of this Scoping Phase, the specialists assessed and considered the entire study area / preferred site, which include the **Original Scoping Buildable Areas**. Findings of the Scoping Level Specialist Assessments are included in Appendix G and integrated in relevant sections of the Scoping Report.

Following the identification of sensitivities by the specialists and relevant specialist fieldwork during the Scoping Phase, the Project Developer took such sensitivities, and other considerations, into account and formulated the **Revised Scoping Buildable Areas or development footprints for the proposed 12 x PV areas**. The Revised Scoping Buildable Areas will be used to inform the design of the layout and will be further assessed during the EIA Phase.

In summary, the full extent of the study area has been assessed by the specialists and mapped accordingly in the Scoping Level Assessments to identify environmental sensitivities and no-go areas. The Original and Revised Scoping Buildable Areas both fall within the study area, and therefore both have been assessed by the specialists. As part of the Scoping Phase, the specialists were provided the Original Scoping Buildable Areas within the study area as an indicative point of departure of development footprints and relative location of the 12 x PV facilities, and to provide a comprehensive view of the approach followed to identify the buildable areas. Following the identification of sensitivities in relation to the Original Scoping Buildable Areas, each specialist study provides a “Statement on the Revised Scoping Buildable Areas”.

This approach uses environmental and social constraints to avoid sensitive features, thus applying mitigation hierarchy thinking, and it leads to the selection of the least sensitive development footprint.

The information presented in this chapter includes details of the **Revised Scoping Buildable Areas**, where applicable. Figure 2.1 provides an indication of the Original and Revised Scoping Buildable Areas, as well as the study area, and its evolution.

SCOPING REPORT: Scoping and Environmental Impact Assessment (EIA) Process for the Proposed Development of a Solar Photovoltaic (PV) Facility (Kudu Solar Facility 2) and associated infrastructure, near De Aar, Northern Cape Province

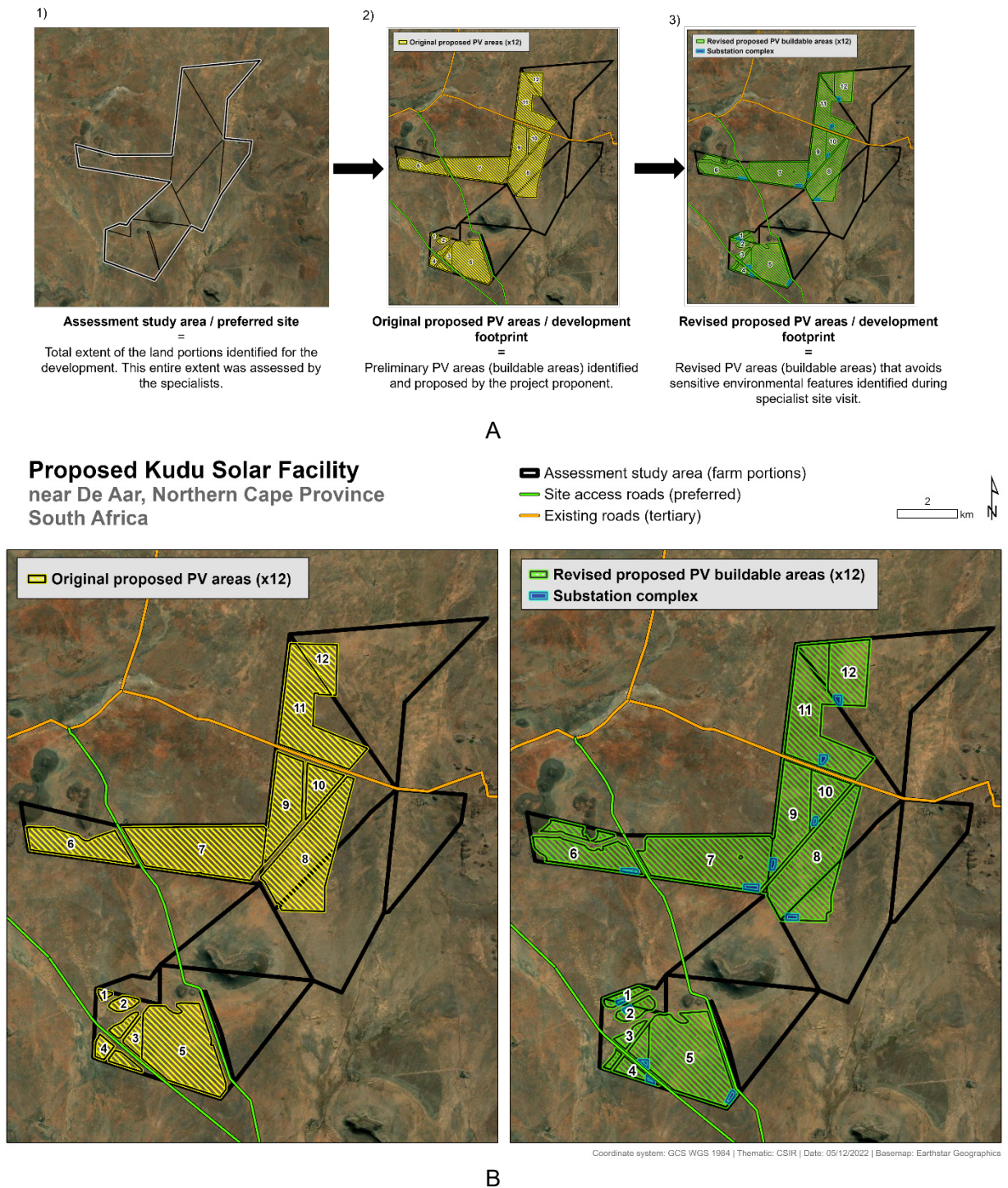

Figure 2.1: A) Evolution of the Study Area / Preferred Site into the Scoping Buildable Areas / development footprints; B) Detailed view of the Project Study Area / Preferred Site, Original Scoping Buildable Area and Revised Scoping Buildable Area (development footprints).

2.2 Project Locality and Co-ordinates

Appendix 2 of the 2014 National Environmental Management Act (Act 107 of 1998, as amended) (NEMA) EIA Regulations (as amended) states that a Scoping Report must provide the location of the activity, including the 21-digit Surveyor General code of each cadastral land parcel; where available, the physical address and farm name; or the coordinates of the boundary of the property or properties if the aforementioned is not available. Appendix 2 of the 2014 NEMA EIA Regulations (as amended) also states that a Scoping Report must include a plan which locates the proposed activity or activities applied for at an appropriate scale.

In line with the above, refer to Chapter 1 for a locality map of the proposed Kudu Solar Facilities and associated infrastructure. Refer to Appendix C of this Scoping Report for additional maps.

The proposed project and associated infrastructure will occur on the farm portions listed in Table 2.2 below, which also specifies the corresponding 21-digit Surveyor General code for each affected farm portion. The properties to be affected by the development of the proposed project will be leased from the property owners by the Project Applicant for the life span of the proposed project.

In addition, some intersections may need to be widened to accommodate truck access to the site. Details of the affected farm properties and intersection widening will be confirmed during the EIA Phase.

Table 2.2: Affected Farm Properties for the proposed project

Farm Portion	21-digit Surveyor General code
Remaining Extent of the Farm Bas Berg No. 88	C0570000000008800000
Remaining Extent of Portion 3 of the Farm Bas Berg No. 88	C0570000000008800003

Figure 2.2 provides an indication of the affected farm portions and the adjacent farm portions for the entire study area.

Proposed Kudu Solar PV facility (1 - 12)
near De Aar, Northern Cape Province
South Africa

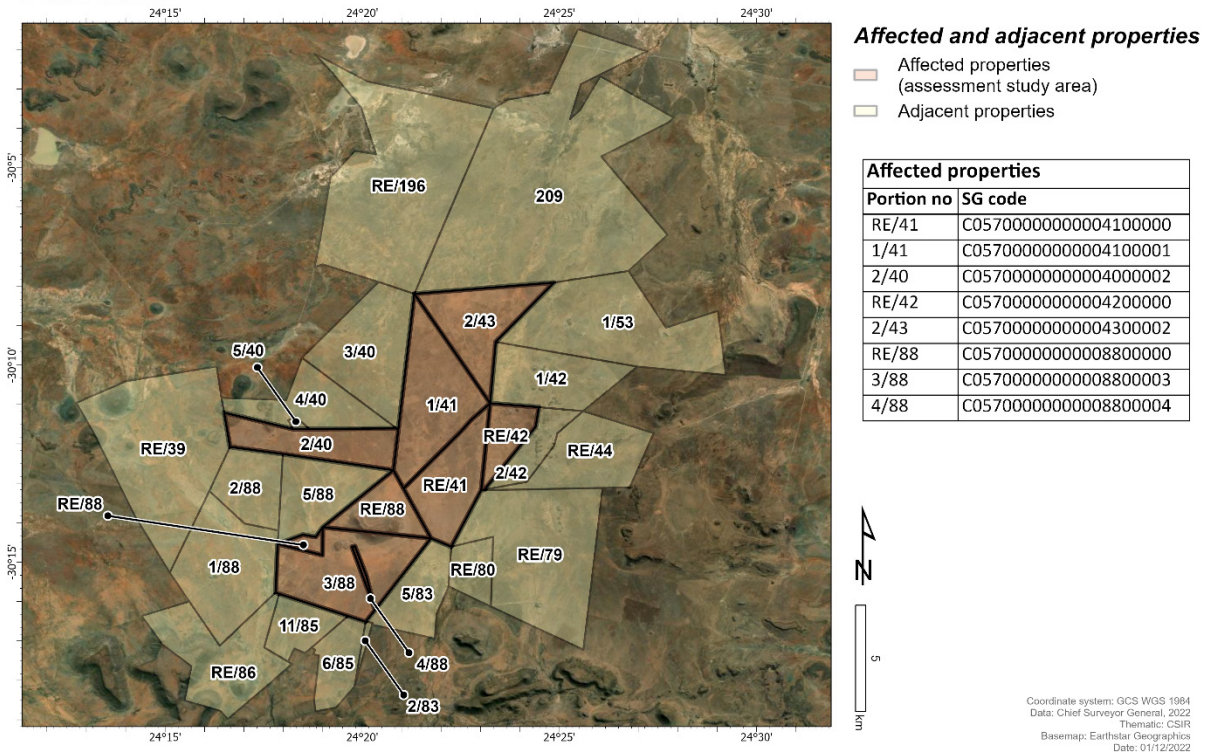

Figure 2.2: Affected and Adjacent Farm Portions for the study area

The co-ordinates of the estimated mid-points of the proposed project are detailed in Table 2.3.

Table 2.3: Co-ordinates of the Mid-Point of the proposed project

Project	Decimal Degrees		Degrees, Minutes, Seconds	
	Latitude (Y)	Longitude (X)	Latitude (S)	Longitude (E)
Kudu Solar Facility 2	-30.1817	24.3639	30° 10' 54.175" S	24° 21' 49.871" E

2.3 Key components of the proposed project

The proposed project will consist of the key components listed below in Table 2.4.

A summary of the key components of the proposed project and technical information is described in this section. The exact specifications of the proposed project components will be determined either during the EIA Phase or detailed engineering phase (subsequent to the issuing of the Environmental Authorisation (EA), should such an authorisation be granted for the proposed project). In line with the precautionary approach and in order to ensure that any environmental impacts which may arise as a result of the project are adequately assessed during the EIA Phase, maximum development scenarios and estimates have been provided in this section. As part of the comments received from the Department of Forestry, Fisheries and the Environment (DFFE) during the 30-day review period on the Draft Scoping Report, the request was for the project description to be more specific. Efforts have been made to confirm as many details as possible,

specifically in terms of the listed activities applicable, however at the Scoping Phase there are some project aspects that are still to be confirmed during the EIA Phase, and it is necessary to follow the maximum development scenario or precautionary approach. In such instances, if any updates need to be made to the listed activities, an Amended Application for EA will be submitted accordingly.

The Scoping Specialist Assessments have also been based on the maximum development scenario in terms of the project specifications (such as the development footprint, dimensions, height etc.).

Table 2.4: Description of the components of the proposed project

Component	Description
Solar Field	
Type of Technology	Solar Photovoltaic (PV) Technology
Generation Capacity (Maximum Installed)	<ul style="list-style-type: none"> 50 MWac
Total developable area that includes all associated infrastructure within the fenced off area of the PV facility	<p><u>Revised Scoping Buildable Areas:</u></p> <ul style="list-style-type: none"> 48 ha
PV Panel Structure (with the following possible tracking and mounting systems): <ul style="list-style-type: none"> Single Axis Tracking structures (aligned north-south); Dual Axis Tracking (aligned east-west and north-south); Fixed Tilt Mounting Structure; Mono-facial Solar Modules; or Bifacial Solar Modules. 	<ul style="list-style-type: none"> <u>Height:</u> Approximately 3.5 m (maximum)
Building Infrastructure	
Auxiliary Buildings	<ul style="list-style-type: none"> <u>Type:</u> These include, but are not limited to, Operation and Maintenance (O&M) building / centre, site office, workshop, staff lockers, bathrooms/ablutions, warehouses, guard houses, etc. <u>Cumulative Footprint:</u> Approximately up to 5000 m² <u>Height:</u> Up to 10 m
Inverter/Transformer Stations	<ul style="list-style-type: none"> <u>Preliminary average number of stations:</u> 27 <u>Height:</u> Approximately 3 m <u>Footprint:</u> Approximately 220 m² each
On-site Substation Complex	<ul style="list-style-type: none"> <u>Components of the on-site substation complex:</u> <ul style="list-style-type: none"> On-site Independent Power Producer (IPP) or Facility Substation (~1 ha)¹.

¹ As confirmed with the DFFE, the on-site substation complex can be included within the current Application for EA. This has been noted in the Amended Application Form for EA, and Chapter 4 of this Final Scoping Report.

Component	Description
	<ul style="list-style-type: none"> ○ Lithium Ion or Redox Flow Battery Energy Storage System. Refer to the details below. ○ Switching Station and Collector Station (~2 ha). This forms part of Projects 13 – 24 and will be assessed as part of separate processes. <ul style="list-style-type: none"> ▪ <u>Footprint of the on-site substation complex</u>: Up to approximately 4 ha ▪ <u>Height of the on-site substation complex</u>: Up to 10 m ▪ <u>Capacity of the on-site substation complex</u>: This varies according to the detailed design and requirements from potential clients, however a capacity stepping up from 22 kV or 33 kV to 132 kV is estimated.
Associated Infrastructure	
Battery Energy Storage System (BESS)	<ul style="list-style-type: none"> ▪ <u>Technology</u>: Lithium-Ion BESS or Redox Flow BESS (both options being considered in the Scoping and EIA Process) ▪ <u>Footprint</u>: Approximately 1 ha ▪ <u>Height</u>: Up to 10 m ▪ <u>Capacity</u>: Up to 500 MW / 500 MWh
On-site medium voltage internal cables	<ul style="list-style-type: none"> ▪ <u>Placement</u>: Underground or above ground in certain sections ▪ <u>Capacity</u>: 22 or 33 kV ▪ <u>Depth</u>: Maximum depth of 1.5 m
Underground low voltage cables or cable trays	<ul style="list-style-type: none"> ▪ <u>Depth</u>: Maximum depth of 1.5 m
Access roads (including upgrading and widening of existing roads, where relevant)	<ul style="list-style-type: none"> ▪ <u>Details</u>: Existing roads will be used as far as practically achievable. The Traffic Specialist has noted that the main roads leading to the proposed project are of a sufficient width, however some intersections may need to be widened by more than 4 m or 6 m. If lengthening of the intersections is required, then such lengthening will not exceed 1 km. Exact details of the length will be confirmed during the EIA Phase. In addition, some access roads may need to be upgraded depending on which route is used. Upgrading of the main access point from the R48 is likely to need upgrading. Such upgrading will include lengthening of less than 1 km. Details will be confirmed during the EIA Phase.

Component	Description
Internal roads	<ul style="list-style-type: none"> ▪ <u>Details</u>: New internal service roads will need to be established. These would either comprise farm roads (compacted dirt/gravel) or paved roads. ▪ <u>Width</u>: Approximately 4 – 5 m
Fencing around the PV Facility Perimeter	<ul style="list-style-type: none"> ▪ <u>Type</u>: Could be palisade or mesh or fully electrified ▪ <u>Height</u>: Up to 3 m
Storm water channels	<ul style="list-style-type: none"> ▪ Details to be confirmed once the Engineering, Procurement and Construction (EPC) contractor has been selected and the design is finalised. Where necessary, a detailed storm water management plan would need to be developed.
Panel cleaning and maintenance area	<ul style="list-style-type: none"> ▪ Details to be confirmed during the EIA Phase
Work area during the construction phase (i.e. laydown area)	<ul style="list-style-type: none"> ▪ Temporary Laydown: Up to 7 ha. ▪ The need for a permanent laydown area will be confirmed during the EIA Phase.
Water Requirements	<ul style="list-style-type: none"> ▪ Approximately 9 000 m³ of water is estimated to be required per year for the construction phase. ▪ Approximately 1 000 m³ of water is estimated to be required per year for the operational phase. ▪ Water requirements during the decommissioning phase are unknown at this stage. ▪ Potential sources: Local municipality, third-party water supplier, existing boreholes or drilled boreholes on site.
Construction Period	<ul style="list-style-type: none"> ▪ 12 – 18 months
Operational Period	<ul style="list-style-type: none"> ▪ Once the commercial operation date is achieved, the proposed facility will generate electricity for a minimum period of 20 years.

Figure 2.3 provides a **schematic** overview (not to scale) of the proposed Kudu Solar Facilities cluster. The EGI projects that consist of the following will be subjected to separate BA processes and/or application of the EGI Standard, as noted above:

- Switching Stations and Collector Stations at each On-Site Substation Complex;
- 132 kV Overhead Power Line from each Kudu Solar Facility to the proposed Collector Station(s) or up to the proposed independent Main Transmission Substation (MTS);
- Independent 132 kV/400 kV MTS and associated infrastructure; and
- 400 kV Loop-In-Loop-Out (LILO) from the existing Hydra-Perseus 400 kV Overhead Power Line to the proposed MTS.

A description of the key components of the proposed project is described below.

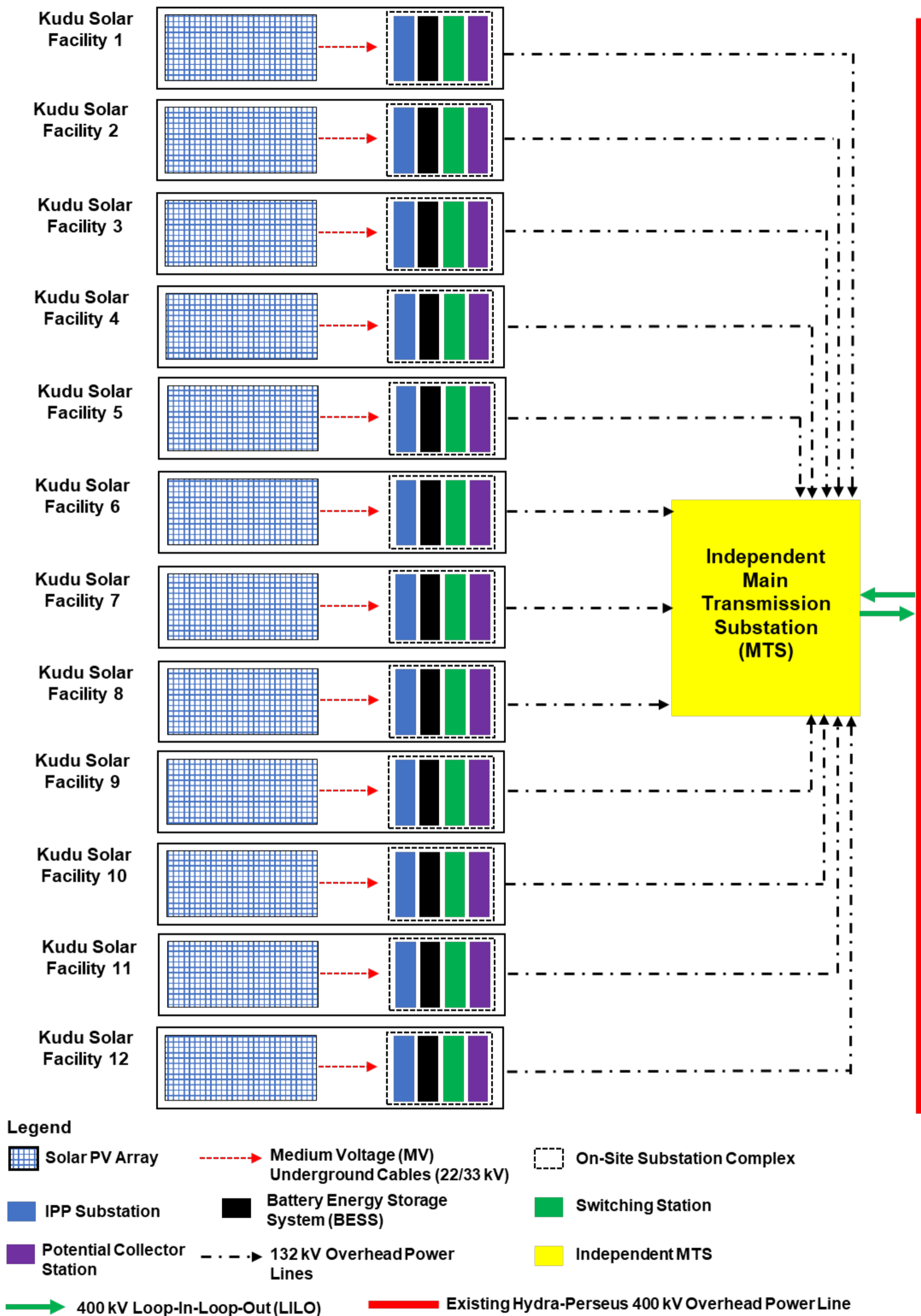

Figure 2.3. Schematic overview of the Kudu Solar Facilities and EGI Connection.

2.3.1 Solar PV Facilities – Solar Field

The Solar Field will consist of the solar arrays (panels) and building infrastructure.

The total developable area that includes all associated infrastructure within the fenced off area of the PV facility i.e. including the solar field, foundations, buildings and associated infrastructure but excluding access roads leading to the fenced off area, for the proposed project is **48 ha** based on the Revised Scoping Buildable Areas / development footprint.

The exact number of solar arrays, confirmation of the foundation type and detailed design will follow as the development progresses, but a preliminary site layout plan has been included in Chapter 7 and Appendix C of this report.

The smallest unit of a PV installation is a cell. A number of cells form a module, and several modules cumulatively form the arrays (Figure 2.4). An example of a Solar PV Facility is provided in Figure 2.5.

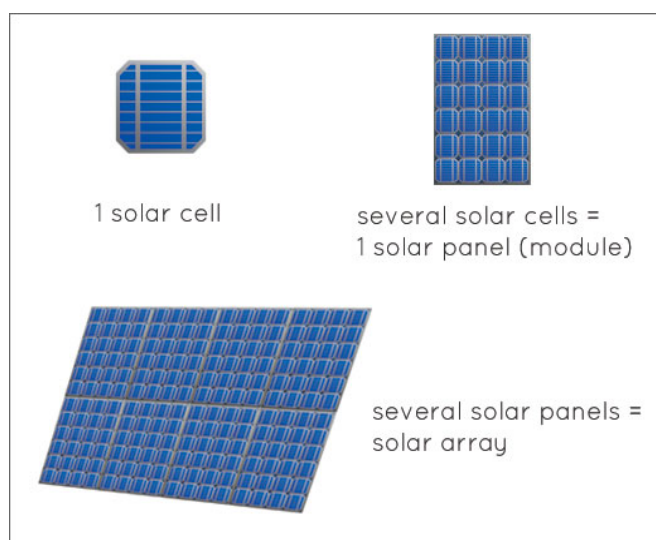

Figure 2.4. Components of the Proposed PV Installation

Modules are arranged into strings that form the solar field, and are installed on racks which are made of aluminium or galvanised steel. Foundations will likely be drilled and concreted into the ground. The entire structure will have a maximum height of approximately 3.5 m (measured from the ground). This system may be fixed, or may track the movement of the sun, either by adopting Single Axis Tracking (aligned north-south), Dual Axis Tracking (aligned east-west and north-south), Fixed Tilt Mounting Structures, Mono-facial Solar Modules, or Bifacial Solar Modules. Bifacial panels can be up to 20 - 40 % more effective since it also utilises solar radiation reflected from the surfaces onto the rear side of the panels. The tracker design will be confirmed during the detailed engineering phase. All tracker design options will be considered in this Scoping and EIA Process.



Figure 2.5. Example of PV Technology (Department of Environment, Forestry and Fisheries (DEFF), 2019²).

2.3.2 Infrastructure within the PV Facility

2.3.2.1 Inverters, Low Voltage Cables, and Medium Voltage Cables

The solar arrays are typically connected to each other in strings, which are in turn connected to inverters that convert DC to AC. Each inverter station is expected to extend approximately 3 m in height, with a footprint of approximately 0.02 ha. It is estimated that there will be an average of 27 inverter stations at the PV Facility.

The strings will be connected to the inverter stations by low voltage underground (internal) DC cables (to a maximum depth of 1.5 m) or cable trays. Power from the inverter stations will be collected in medium voltage transformers through underground (internal) AC cables or cable trays.

The inverter stations will in turn be connected to the proposed on-site substation complexes, via medium voltage (22 or 33 kV) internal underground cables. It is highly unlikely that above ground 22 or 33 kV power lines will be utilised due to the shading created to the PV Facility from the overhead lines. It is more likely that the 22 or 33 kV internal cables will be underground to a maximum depth of 1.5 m. However, in the isolated event of crossing a feature hindering underground cabling (e.g. a road, topographical or environmental constraint), the reticulation lines may better be suited to be above ground in certain sections. Therefore, both below and above ground routings need to be covered in this Application for EA. This does not trigger Activity 11 of Listing Notice 1, as the internal reticulation will not have “a capacity of more than 33 kV”.

² Department of Environment Forestry and Fisheries, 2019. Phase 2 Strategic Environmental Assessment for wind and solar PV energy in South Africa. CSIR Report Number: CSIR/SPLA/SECO/ER/2019/0085 Stellenbosch, Western Cape.

2.3.2.2 On-site Substation Complex

The proposed project will also include an on-site substation complex. The on-site substation complex will cover an approximate area of 4 ha, with a height of up to 10 m, and generally stepping up from 22 kV or 33 kV to 132 kV. The on-site substation complex is planned to include the following:

- On-site Independent Power Producer (IPP) or facility substation;
- Battery Energy Storage System (BESS); and
- Switching Station and Collector Station.

The on-site IPP or facility substation will cover an area of approximately 1 ha within the on-site substation complex, and with a maximum height of 10 m. This will include the relevant section that will be maintained by the IPP, focusing on the high voltage infrastructure leading up to the Point of Connection (the Project Applicant's section of the proposed on-site substation complex). As noted above, this will be included in the current Application for EA (i.e. for the Solar PV Facility and associated infrastructure), as confirmed with the DFFE.

The BESS is described in the section below.

The Switching Station and Collector Station forms part of the separate EGI projects (i.e. Projects 13 – 24). The electrical connection from the on-site substation complex to the proposed independent MTS and national grid will be discussed in a separate authorisation and/or registration process (i.e. for Projects 13 to 26).

2.3.2.3 Battery Energy Storage System

The BESS will extend up to 1 ha at the on-site substation complex, with a height of up to 10 m, and a capacity of up to 500 MW / 500 MWh.

Battery storage offers a wide range of advantages to South Africa including electricity supply reliability and quality improvement. The main purpose of the BESS is to mitigate intermittency of solar PV energy by storing and dispatching of electricity when needed i.e. to contribute to the grid 24 hours/day, during peak demand at night or during power outages. In essence, this technology allows renewable energy to enter the completely independent power generation market.

The BESS technology type will either be Lithium-Ion or Redox Flow. Both these technologies will be assessed during the Scoping and EIA Phase, and a motivation will be included in the EIA Report to potentially authorise both technology types if both are found to be acceptable and preferred during the EIA Phase. Refer to Appendix F.3 of this Scoping Report for a copy of the Pre-Application Meeting Notes, which capture the discussions with the Department of Forestry, Fisheries and the Environment (DFFE) around the BESS and the motivation for both technologies to be authorised (should such authorisation be granted). Additional information on the BESS technologies that are being considered is provided below.

- **Lithium-Ion Batteries**

Lithium-Ion batteries are solid state, sealed systems i.e. pre-assembled off site and then delivered to site for placement as per specifications of the supplier. This BESS system consists of multiple

battery cells that are assembled together to form modules. A module may consist of several cells working in conjunction. Each cell contains a positive electrode, a negative electrode and an electrolyte. The negative electrode for a lithium-ion cell is typically carbon. The positive electrode can be lithium iron phosphate or a lithium metal oxide. The electrolyte is usually a lithium salt dissolved in an organic solvent (CSIR, 2015³).

It is proposed that the Lithium-Ion BESS would be housed in containers, with associated operational, safety and control infrastructure. The BESS will be a sealed unit and will remain sealed during operations. Based on various discussions with the DFFE on previous occasions, it has been confirmed that Lithium-Ion BESS is not classified as containers or structures for the development and related operation of facilities or infrastructure, for the storage, or for the storage and handling, of a dangerous good. Hence, listed activities pertaining to this aspect in the 2014 NEMA EIA Regulations (as amended) do not apply. Figure 2.6 is an illustration of a 25 MW / 50 MWh Lithium-Ion battery located at the 60 MW Gannawarra Solar Farm in Australia.



Figure 2.6. Example of PV Technology with Lithium Ion BESS (ARENAWIRE, 2018⁴)

▪ **Redox Flow Batteries (RFB)**

Flow batteries generally comprise of three major components; a cell stack, auxiliary parts and electrolyte storage. The active chemical species in a flow battery are stored mostly externally in above-ground storage tanks, which contain the positive and negative electrolytes separately. The energy is stored in two chemical components, which are dissolved in a liquid to form electrolytes during operation. The energy density of a RFB is thus dependent on the size of the storage tanks (Parsons, 2017⁵).

A schematic representation of a typical RFB is provided in Figure 2.7.

³ CSIR, 2015. Final Environmental Impact Assessment Report for the proposed construction of Gemsbok Solar PV2 75 MW Solar PV facility on the Remaining Extent of Portion 3 of the Farm Gemsbok Bult 120, Kenhardt, Northern Cape. CSIR Report Number: CSIR/CAS/EMS/ER/2014/0010/B.

⁴ Arenawire (2018). Solar battery storage in Victoria charging up for summer. <https://arena.gov.au/blog/solar-battery-storage-in-victoria-charging-up-for-summer/> [online]. Accessed November 2021.

⁵ Parsons, 2017. US Trade and Development Agency. South Africa Energy Storage Technology and Market Assessment. Order Number: TDA-IE201511210. USTDA Activity Number: 2015-11032A. Parsons Job Number: 640368

There are two types of RFB's i.e. a 'true' RFB and a hybrid RFB. In a 'true' RFB the electro-active materials used to store energy remain dissolved in solution. Therefore, the energy is determined by the volumes of electrolyte available. Examples of a 'true' RFB is a Vanadium RFB and iron-chromium systems. Hybrid RFBs deposit at least one chemical species as a solid during the charge cycle, therefore preventing the complete separation of power and energy characteristics (Parsons, 2017⁴).

Examples of electrolytes for RFBs include Hydrochloric Acid and Sulphuric Acid, which are considered as dangerous goods in terms of the 2014 NEMA EIA Regulations (as amended).

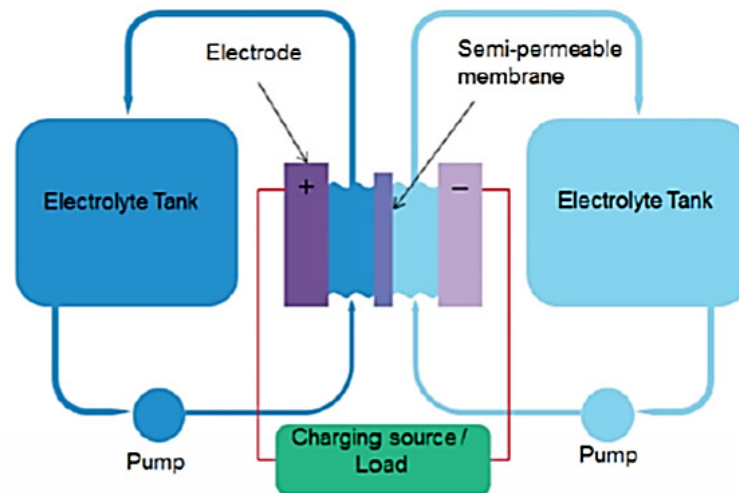

Figure 2.7: Schematic diagram of a typical Redox Flow Battery (Source: Parsons, 2017⁴)

Activity 14 of Listing Notice 1 is for “the development and related operation of facilities or infrastructure, for the storage, or for the storage and handling, of a dangerous good, where such storage occurs in containers with a combined capacity of 80 cubic metres or more but not exceeding 500 cubic metres”. This listed activity has been included in the Application Form for EA to address the Redox Flow BESS technology type as some of the electrolytes could be stored separately in above ground storage tanks for use in the Redox Flow BESS during operations.

If both BESS technologies (i.e. Lithium Ion or Redox Flow BESS) are found acceptable and both are preferred in the EIA Phase; or if the specialists confirm that only Redox Flow is preferred, then the relevant listed activities would have been covered for, as Redox Flow BESS is already included in the Application Form for EA. However, should the EIA Phase confirm that only Lithium Ion BESS is acceptable and preferred, then the applicability of Activity 14 of Listing Notice 1 will be updated (to remove reference to the Redox Flow BESS).

Refer to Appendix G.10 of this Scoping Report for a BESS High-Level Safety, Health and Environment Risk Assessment Scoping Input Report. The report provides high level information on the safety, health and environmental risks of the BESS technologies being considered.

According to ISHECON (2022⁶), the safety and health risks associated with RFBs⁷ will likely be lower than the lithium-ion battery type for both employees and members of the public outside the facility. Lithium-ion batteries pose a higher fire and explosion risk and the possibility of generating noxious smoke under these circumstances. However, lithium battery systems are easier to install, i.e. containers as opposed to formal brick and mortar structures, and will not require as many permanent staff as RFB utility scale operations. The environmental risks of surface aquatic features and groundwater contamination with the RFBs will likely be higher than for solid state batteries, due to the presence of liquids and potential spillages.

2.3.2.4 Internal Roads

Internal roads will also be constructed within the footprint of the PV facility. The internal roads will comprise farm roads (compacted gravel/dirt) or paved roads and will extend approximately 4 to 5 m wide. The total internal road length will be estimated during the EIA Phase, and may vary slightly, depending on the final design. A perimeter road will also be constructed along the boundary of the proposed PV Facility, which will extend up to 5 m wide.

2.3.2.5 Panel Maintenance and Cleaning Area

During the operational phase, the accumulation of dust on solar panels generally negatively influences the productivity of solar facilities. As such the panels require regular cleaning. It is proposed that panel cleaning will take place as part of a maintenance schedule, twice per year; however, this may be revised should the site and weather conditions warrant more frequent cleaning. Cleaning may also be required after events that generate significant dust, but not daily. A dedicated panel maintenance and cleaning area will be required on site during the operational phase. Water that emanates from the cleaning process will be free from harmful detergents or will comprise of approved biodegradable substances.

2.3.2.6 Storm water

It is proposed that the area where the solar panels will be installed will not be fully cleared of vegetation. It is planned for the vegetation to be trimmed and the panels will be installed on steel supporting structures above the height of the vegetation. The solar panels will not replace the vegetated area and thus storm water runoff is not expected to increase specifically due to the proposed PV panel placement.

Stormwater infrastructure, such as channels, will be constructed on site to ensure that stormwater run-off from site is appropriately managed. Water from these channels is not likely to contain any chemicals or hazardous substances and will be released into the surrounding environment based on the natural drainage contours.

Details of storm water management are to be confirmed once the Engineering, Procurement and Construction (EPC) contractor has been selected and the design is finalised. Where necessary, a detailed Storm Water Management Plan would need to be developed during the detailed design phase (post EA, should such an authorisation be granted) and to be implemented during all phases of the project. The plan must ensure compliance with applicable regulations and prevent off-site

⁶ ISHECON (2022). Battery Energy Storage System High-Level Safety, Health and Environment Risk Assessment. Scoping Level Assessment for the proposed Kudu Solar Facilities and associated infrastructure. Prepared for the Scoping and Environmental Impact Assessment (EIA) for the Kudu Solar Facilities and associated infrastructure. Appendix G.10 of the Scoping Report.

⁷ Vanadium is assumed for now; however alternative chemistry may be considered.

migration of contaminated storm water or increased soil erosion. The plan should also include the installation of appropriate design measures that allow surface and subsurface movement of water along drainage lines so as not to impede natural surface and subsurface flows. Drainage measures promotes the dissipation of storm water run-off. Recommendations for the management of storm water will be discussed in the Environmental Management Programme (EMPr) during the EIA Phase.

2.3.2.7 Auxiliary Building Infrastructure

The solar field will require the following auxiliary building infrastructure:

- Warehouse / workshop for storage of equipment;
- Offices;
- Operational and maintenance (O&M) building / control centre;
- Guard Houses / security enclosures;
- Ablution facilities;
- Staff lockers;
- Inverter stations; and
- On-site substation buildings.

The auxiliary buildings will have an estimated cumulative footprint of approximately 5000 m², and a height up to 10 m.

A temporary laydown area with a maximum footprint of 7 ha will also be constructed. The need for a permanent laydown area will be confirmed during the EIA Phase.

2.3.2.8 Additional Infrastructure

The Project Applicant may establish a concrete batch plant on site (within the laydown area) for purposes of the construction phase. Only a limited amount of water (within the overall water usage estimates described in this chapter) will be utilised during construction for the batching of concrete. Details of the concrete batching plant will be confirmed during detailed design as the development progresses.

For various reasons such as security, public protection and lawful requirements, the proposed built infrastructure on site and the entire PV facility will be secured via the installation of appropriate fencing. The PV facility fencing type could be palisade or mesh or fully electrified, with an estimated height of up to 3 m.

Existing livestock fencing on the affected farm portions may be upgraded in places, where deemed insufficiently secure, whereas permanent fencing will be required around the O&M area and on-site substation complex. Access points will be managed and monitored by an appointed security service provider. The type and height of fencing to be installed will be confirmed during detailed design as the development progresses.

2.3.3 External Access Roads

A Scoping Level Traffic Impact Assessment has been commissioned for the proposed Kudu Solar Facilities and is included Appendix G.9 of this Scoping Report. The following information has been obtained from the Scoping Level Traffic Impact Assessment (Sturgeon Consulting, 2022⁸).

The proposed project study area / preferred site can be accessed via various existing main roads and unnamed farm gravel roads. The potential access routes are discussed below and illustrated in Figure 2.8:

- **Access Route Option 1 (Figure 2.9):**
 - Route A: Along TR3801, DR3093, and DR3096;
 - Route B: Along TR3801, DR3093 and DR3084;
- **Access Route Option 2 (Figure 2.10):**
 - Route A: Along MR790, DR3093 and DR3084;
 - Route B: Along MR790 and DR3093;
 - Route C: Along MR790, DR3093 and DR3096;
- **Access Route Option 3 (Figure 2.11):**
 - Route A: Along TR3801, TR3802, and DR3096;
 - Route B: Along TR3801, TR3802, DR3096 and DR3093; and
 - Route C: Along TR3801, TR3802, DR3096, DR3093 and DR3084.

Access route Option 1 is the preferred main access route for the proposed project. Refer to the Scoping Level Traffic Impact Assessment (Appendix G.9 of this Scoping Report) for further information on the above roads, as well as the applicability per project.

⁸ Sturgeon Consulting (2022). Traffic Impact Assessment. Scoping Level Assessment for the proposed Kudu Solar Facilities and associated infrastructure. Prepared for the Scoping and Environmental Impact Assessment (EIA) for the Kudu Solar Facilities and associated infrastructure. Appendix G.9 of the Scoping Report.



Figure 2.8: Proposed Access Routes to the study area (Sturgeon Consulting, 2022⁷)



Figure 2.9: Potential Access Route Option 1: Divisional Road 3093 (Photograph taken from the R48) (Sturgeon, 2022)



Figure 2.10: Potential Access Route Option 2: Main Road 790 (Photograph taken from the R48) (Sturgeon, 2022)



Figure 2.11: Potential Access Route Option 3: Divisional Road 3096 (Photograph taken from the R48) (Sturgeon, 2022)

These existing main roads, divisional roads and unnamed farm gravel roads leading from the R48 and R388 may need to be upgraded for access to the proposed Kudu Solar cluster, depending on which route is used. Upgrading of the main access point from the R48 is likely to need upgrading. Such upgrading will include lengthening of less than 1 km. Details will be confirmed during the EIA Phase.

The Traffic Specialist has also noted that, based on preliminary investigations, the roads leading to the study area are of a sufficient width to accommodate truck movement, however widening by more than 4 m or more than 6 m may be required at localised positions as required (i.e. intersections). Details of this will be provided during the EIA Phase. If lengthening of the

intersections is required, then such lengthening will not exceed 1 km. Exact details of the length will be confirmed during the EIA Phase.

All components fabricated in foreign countries will need to be imported into South Africa via one of the ports. The closest port to the proposed development is the Port of Ngqura, which would result in a route from the port via the N2, then turning north onto the N10 to De Aar.

Another option will be the route from the Port of Cape Town, which follows the N1 from the port and then turns north at Three Sisters onto the N12 to Britstown and then turns east towards De Aar.

The last option will be the route from the Port of Saldanha, which follows the N7 from the port and then turns east past Calvinia and Britstown to De Aar.

In all the above potential route options, from De Aar, the R48 can be taken east up to the proposed site access.

2.3.4 Service Provision

The Project Developer will consult with the Renosterberg Local Municipality during the EIA Phase in order to confirm the supply of services (in terms of water usage, sewage removal, solid waste removal, and electricity requirements) for the proposed project. The municipality was also consulted with as part of the 30-day public review period of the Draft Scoping Report to seek comment on the general proposed project. No feedback was obtained from the municipality, as shown in Appendix E.8 of the Final Scoping Report. However, the municipality will be communicated with in the EIA Phase.

Should the local municipality not have adequate capacity available for the handling of waste, provision of water and sewage handling provisions; then the Project Applicant will make use of private contractors to ensure that these services are provided. An outline of the services that will be required are discussed below.

2.3.4.1 Water Usage

During the construction phase, approximately 9 000 m³ of water will be required per year per facility. Water will be required for human consumption and construction activities. This is also classified as potable water and should be from a reputable source and conform to South African National Standards (SANS) quality standards. The decommissioning phase is also expected to result in similar water usage requirements; however, the exact specifications will be confirmed at the time and is not expected to significantly exceed the volume requirements of the construction phase.

During the operational phase, it is estimated that the panel washing process, and human consumption as well as other operational phase activities will require approximately 1 000 m³ of water per year for an approximate 20-year operational lifespan, per facility. This equates to approximately 83 m³ of water per month during the operational phase. The water for panel washing does not need to meet the same quality standards as that required for potable water, however the water should be tested to ensure that it does not negatively impact on the mechanical equipment.

Refer to the Geohydrology Assessment (Appendix G.11 of this Scoping Report) and Chapter 3 of this Scoping Report for additional information.

The EMPr will provide recommendations for water conservation techniques during the construction, operational and decommissioning phases. The staff would also be encouraged to use water sparingly during all phases.

Water required for the construction, operational and decommissioning phases will either be sourced from the following sources (in order of priority and likelihood):

- The Renosterberg Local Municipality - specific arrangements will be agreed with the local municipality in a Service Level Agreement (SLA). The water will be trucked in, or made available for collection at the Local Municipal Water Treatment Plant via a metered standpipe. Should the water be trucked in, such impacts will be considered in the Traffic Impact Assessment during the EIA Phase.
- Investigation into a third-party water supplier which may include private services companies. This would be trucked in, and such impacts will be considered in the Traffic Impact Assessment during the EIA Phase.
- Existing boreholes on site to source groundwater (if available and if suitable). A Geohydrology Assessment has been commissioned as part of this Scoping and EIA Process. The Scoping Level inputs are included in Appendix G.11 of this Scoping Report, which includes an analysis of the hydrocensus chemistry results in terms of the SANS 241-1: 2015 and the Department of Water Affairs and Forestry (DWAF) (1998) Standards. Based on this, the groundwater quality in the study area is generally of good quality in terms of pH, total dissolved solids (TDS) and electrical conductivity (EC). It is possible that the groundwater can be used for potable and domestic purposes with only minor treatment however a full laboratory analysis will be required. With regards to the cleaning of panels, salts could be removed from the groundwater by thermal distillation (i.e. boiling since salt has a much higher boiling point than water) or by membrane separation (commonly reverse osmosis). Both of these techniques are possible but financial viability would have to be determined before commissioning as both techniques are costly on a large scale. Water pipelines may need to be constructed to transfer groundwater from existing boreholes or they may be transported by trucks from the boreholes to the site. Groundwater may also need to be stored on site in suitable containers or reservoir tanks during the construction and operational phases. Refer to Chapter 4 of this Scoping Report for feedback on the authorisations required for this aspect in terms of the National Water Act (Act 36 of 1998, as amended).
- New boreholes that will be drilled on site to source groundwater (if available and if suitable), which will be subject to complete geohydrological testing and an assessment, as well as a Water Use Licence Application process. This will be undertaken as a separate process, once more detailed information becomes available, outside of the current Application for EA for the Solar PV Facility and associated infrastructure. Refer to Chapter 4 of this Scoping Report for feedback on the authorisations required for this aspect in terms of the National Water Act (Act 36 of 1998, as amended).

2.3.4.2 Sewage or Liquid Effluent

The proposed project will require sewage services during the construction, operational and decommissioning phases. Low volumes of sewage or liquid effluent are estimated. Liquid effluent will be limited to the ablution facilities during the construction and operational phases. Portable sanitation facilities (i.e. chemical toilets) will be used during the construction phase, which will be regularly serviced and emptied by a suitable and registered contractor. Permanent ablution facilities may be installed during the operational phase, as indicated above. The effluent may be stored on site in watertight structures (conservancy tanks) and thereafter transported to and disposed of at the Local Municipal sewerage treatment works or similar facility by a registered service provider.

2.3.4.3 Solid Waste Generation

The quantity of waste generated will depend on the construction phase, which is estimated to extend 12 to 18 months. However, it is estimated that approximately 50 m³ of waste will be generated every month during the construction phase. The following waste materials are expected:

- Packaging material, such as the cardboard, plastic and wooden packaging and off-cuts;
- Hazardous waste from empty tins, oils, soil containing oil and diesel (in the event of spills), and chemicals;
- Building rubble, discarded bricks, wood and concrete;
- Domestic waste generated by personnel; and
- Vegetation waste generated from the clearing of vegetation.

Solid waste will be managed via the EMPr during all project phases. The EMPr will be provided in the Draft EIA Report, which will incorporate waste management principles. During the construction phase, general solid waste will be collected and temporarily stockpiled in skips in a designated area on site and thereafter removed, emptied into trucks, and disposed at a registered waste disposal facility on a regular or monthly basis by an approved waste disposal Contractor (i.e. a suitable Contractor) or the municipality. In addition, a skip will be placed on site and any damaged or broken PV panels (i.e. those not returned to the supplier) will be stored in this skip. A specialist waste management company will be commissioned to manage and dispose of this waste.

Any hazardous waste (such as contaminated soil as a result of spillages) will be temporarily stockpiled in a designated area on site (i.e. placed in leak-proof storage skips), and thereafter removed off site by a suitable service provider for safe disposal at a registered hazardous waste disposal facility.

Waste disposal slips and waybills will be obtained for the collection and disposal of the general and hazardous waste. These disposal slips (i.e. safe disposal certificates) will be kept on file for auditing purposes as proof of disposal. The waste disposal facility selected will be suitable and able to receive the specified waste stream (i.e. hazardous waste will only be disposed of at a registered/licenced waste disposal facility). The details of the disposal facility will be finalised during the contracting process, prior to the commencement of construction. Where possible, recycling and re-use of material will be encouraged.

During the operational phase after construction, the facility will produce minor amounts of general waste (as a result of the offices or maintenance). It is estimated that approximately 1.92 m³ of waste will be generated every month during the operational phase.

2.3.4.4 Electricity Requirements

In terms of electricity supply, the developer may make use of generators on site during construction, and the operational electrical requirements would be nominal and would likely be supplied by the proposed facility.

2.4 Socio-Economic

It should be noted that the employment opportunity specifications provided in this report are estimates and is dependent on the final engineering design and the Renewable Energy Independent Power Producer Procurement Programme (REIPPPP) Request for Proposal provisions, or similar programme requirements, at that point in time.

2.4.1 Employment during Construction

During the construction phase, skilled, low skilled and semi-skilled temporary employment opportunities will be created. It is difficult to specify the actual number of employment opportunities that will be created at this stage; however, approximately 150 employment opportunities are expected to be created during the construction phase. The skill breakdown of employment opportunities is estimated as 60 % low skilled, 25 % semi-skilled and 15 % skilled.

Employees will most likely be housed in local nearby towns and villages. The Socio-Economic Assessment will also consider this during the EIA Phase. Typically, the EPC contractor will be responsible for the provision of transport of construction personnel to and from site.

2.4.2 Employment during Operations

Approximately 8 full time employment opportunities will be created during the operational phase. The employment breakdown is estimated as 70 % low skilled, 25 % semi-skilled and 5 % skilled. The low and semi-skilled jobs will be linked to services such as panel cleaning, maintenance and security. The percentage of temporary workers that may be offered permanent employment once the construction phase is completed will be dependent on the investor requirements, however will meet the requirements of the REIPPPP (or similar process) at the time as well.

2.4.3 Socio-Economic Investment and Development

The Applicant will ultimately own the project, if successful, and will compile an Economic Development Plan which will be compliant with REIPPPP requirements (or similar process) and will inter alia set out to achieve the following:

- Create a local community trust or similar (as required by REIPPPP) which has an equity share in the project life to benefit historically disadvantaged communities;
- Initiate a skills development and training strategy to facilitate future employment from the local community;
- Give preference to local suppliers for the construction of the facility; and

- Support local community upliftment projects and entrepreneurship through socio-economic and enterprise development initiatives.

2.5 Overview of the Project Development Cycle

This section provides an outline of the main activities that are proposed during each phase of the proposed project, i.e. extending from the Planning and Design phase through to the Decommissioning phase. The operational life of the PV Facility is expected to be approximately 20 years, which could be extended through regular maintenance and/or upgrades in technology.

The project can be divided into the following main phases:

- Detailed Planning and Design Phase;
- Construction Phase;
- Operational Phase; and
- Decommissioning Phase.

Each activity undertaken as part of the above phases may have environmental impacts and, where applicable, has therefore been assessed at a high-level in the specialist studies for the Scoping Phase (Appendix G of this Scoping Report), and will be detailed further during the EIA Phase.

2.5.1 Planning and Design Phase

The project layout, including the exact placement of building infrastructure and the proposed internal road network will be finalised in the EIA Phase. The project layout will be informed by the findings of the specialist assessments. The specialists will be requested to comment on the final project layout. The panel mounting system will only be confirmed during the detailed design.

2.5.2 Construction Phase

The construction phase will take place subsequent to the issuing of the EA (should such authorisation be granted) and if a successful bid in terms of the REIPPPP or a similar tender process is issued, and once a power purchase agreement (PPA) is signed with a suitable energy off-taker (either national government or private). As indicated above, the construction phase is expected to extend 12 to 18 months. The main activities that will form part of the construction phase are:

- Removal of vegetation for the proposed infrastructure, where necessary, within the approved development footprint to facilitate the construction and/or establishment of infrastructure. Note that vegetation is planned to be trimmed within the PV array area (and not removed completely);
- Excavations for infrastructure and associated infrastructure;
- Establishment of a laydown area for equipment;
- Stockpiling of topsoil and cleared vegetation, where necessary (except for the PV array);
- Creation of employment opportunities;
- Transportation of material and equipment to site, and personnel to and from site; and
- Construction of the solar field, and additional infrastructure.

All efforts will be made to ensure that construction work will be undertaken in compliance with local, provincial and national legislation, local and international best practice, as well as the EMPr that will be compiled and included in the EIA Report. An independent Environmental Control Officer (ECO) will be appointed during the construction phase and will monitor compliance with the recommendations and conditions of the EMPr and EA, respectively.

2.5.3 Operational Phase

The following activities will occur during the operational phase:

- The generation of electricity from the proposed solar facility; and
- Maintenance of the solar field and associated infrastructure.

The operational lifespan of the proposed solar PV facility is expected to be approximately 20 years. During the life span of the proposed project, on-going maintenance will be required on a scheduled basis to ensure the continued optimal functioning of the infrastructure. In general, maintenance on the structures will involve visual inspection, and only equipment that fails will be replaced in manner similar to that of construction activities. The EMPr that will be compiled and included in the EIA Report will include the requirement for method statements to be compiled prior to the operational phase to describe the manner in which maintenance will be undertaken to ensure environmental impacts are minimised.

2.5.4 Decommissioning Phase

At the end of the operational phase, the PV facility may be decommissioned, or may be repowered i.e. redesigned and refitted so as to operate for a longer period. The main aim of decommissioning is to return the land to its original, pre-construction condition. Should the unlikely need for decommissioning arise i.e. if the facility becomes outdated or the land needs to be used for other purposes, the decommissioning procedures will be undertaken in line with an approved EMPr and relevant legislation at the time, and the site will be rehabilitated and returned to its pre-construction state.