

**APPENDIX C7**  
**COMMENTS RECEIVED**

## ORGANS OF STATE

Eskom SOC Ltd

## Savannah Public Process

---

**From:** John Geeringh [REDACTED]  
**Sent:** Monday, January 25, 2021 7:53 AM  
**To:** Savannah Public Process  
**Subject:** RE: DEVELOPMENT OF A CLUSTER OF RENEWABLE ENERGY FACILITIES: Notification of commencement of Basic Assessment and Public Participation Processes  
**Attachments:** Eskom requirements for work in or near Eskom servitudes.doc; Renewable Energy Generation Plant Setbacks to Eskom Infrastructure Rev2 - signed.pdf

Please find attached Eskom general requirements for works at or near Eskom infrastructure and servitudes. Please also find attached the Eskom setbacks guideline the applicant needs to consider during planning of the layouts and positioning of infrastructure.

Kind regards

John Geeringh (Pr Sci Nat)(EAPASA)  
Senior Consultant Environmental Management  
Land and Rights  
Eskom Transmission Division  
Megawatt Park, D1Y42, Maxwell Drive, Sunninghill, Sandton.

---

**From:** Public Process <publicprocess@savannahsa.com>  
**Sent:** Friday, 22 January 2021 15:39  
**To:** John Geeringh [REDACTED]  
**Cc:** nicolene@savannahsa.com; ronald@savannahsa.com; Nicolene Venter <nicolene@savannahsa.com>  
**Subject:** DEVELOPMENT OF A CLUSTER OF RENEWABLE ENERGY FACILITIES: Notification of commencement of Basic Assessment and Public Participation Processes

### **DEVELOPMENT OF A CLUSTER OF RENEWABLE ENERGY FACILITIES BETWEEN SOMERSET EAST AND MAKHANDA, EASTERN CAPE PROVINCE**

Dear John,

A cluster of renewable energy facilities is proposed to be developed on various project sites located between Somerset East and Makhandla within the Cookhouse Renewable Energy Development Zone (REDZ), as well as the Eastern Strategic Transmission Corridor. The cluster consists of nine (9) projects which includes six (6) wind farms, two (2) solar energy facilities and one (1) Main Transmission Substation (MTS). A suitable project site for each development has been identified by the project development companies and the entire extent of the projects is located within the Sarah Baartman District Municipality. The western section is located within the Blue Crane Route Local Municipality and the eastern section within the Makana Local Municipality.

Please find attached the Background Information Document which provides additional information

regarding the application for the six (6) wind energy facilities, the two (2) solar energy facilities and the 400MW Main Transmission Substation.

The .KMZs for the development sites and grid connection are not yet available and as soon as these become available, we will forward it to you.

Please accept my apologies for omitting you from the projects' databases at this early stage of the project.

Please do not hesitate to contact us should you require additional information and/or clarification regarding the projects. Our team welcomes your participation and look forward to your involvement throughout this process.

Kind regards,



t: 011 656 3237  
f: 086 684 0547

**Nicolene Venter**  
Public Process

e: [publicprocess@savannahsa.com](mailto:publicprocess@savannahsa.com)  
c: +27 (0) 60 978 8396

[SAWEA Award for Leading Environmental Consultant on Wind Projects in 2013 & 2015](#)

NB: This Email and its contents are subject to the Eskom Holdings SOC Ltd EMAIL LEGAL NOTICE which can be viewed at [http://www.eskom.co.za/Pages/Email\\_Legal\\_Spam\\_Disclaimer.aspx](http://www.eskom.co.za/Pages/Email_Legal_Spam_Disclaimer.aspx)

## TO WHOM IT MAY CONCERN

### Eskom requirements for work in or near Eskom servitudes.

1. Eskom's rights and services must be acknowledged and respected at all times.
2. Eskom shall at all times retain unobstructed access to and egress from its servitudes.
3. Eskom's consent does not relieve the developer from obtaining the necessary statutory, land owner or municipal approvals.
4. Any cost incurred by Eskom as a result of non-compliance to any relevant environmental legislation will be charged to the developer.
5. If Eskom has to incur any expenditure in order to comply with statutory clearances or other regulations as a result of the developer's activities or because of the presence of his equipment or installation within the servitude restriction area, the developer shall pay such costs to Eskom on demand.
6. The use of explosives of any type within 500 metres of Eskom's services shall only occur with Eskom's previous written permission. If such permission is granted the developer must give at least fourteen working days prior notice of the commencement of blasting. This allows time for arrangements to be made for supervision and/or precautionary instructions to be issued in terms of the blasting process. It is advisable to make application separately in this regard.
7. Changes in ground level may not infringe statutory ground to conductor clearances or statutory visibility clearances. After any changes in ground level, the surface shall be rehabilitated and stabilised so as to prevent erosion. The measures taken shall be to Eskom's satisfaction.
8. Eskom shall not be liable for the death of or injury to any person or for the loss of or damage to any property whether as a result of the encroachment or of the use of the servitude area by the developer, his/her agent, contractors, employees, successors in title, and assignees. The developer indemnifies Eskom against loss, claims or damages including claims pertaining to consequential damages by third parties and whether as a result of damage to or interruption of or interference with Eskom's services or apparatus or otherwise. Eskom will not be held responsible for damage to the developer's equipment.
9. No mechanical equipment, including mechanical excavators or high lifting machinery, shall be used in the vicinity of Eskom's apparatus and/or services, without prior written permission having been granted by Eskom. If such permission is granted the developer must give at least seven working days' notice prior to the commencement of work. This allows time for arrangements to be made for supervision and/or precautionary instructions to be issued by the relevant Eskom Manager

Note: Where an electrical outage is required, at least fourteen work days are required to arrange it.

10. Eskom's rights and duties in the servitude shall be accepted as having prior right at all times and shall not be obstructed or interfered with.
11. Under no circumstances shall rubble, earth or other material be dumped within the servitude restriction area. The developer shall maintain the area concerned to Eskom's satisfaction. The developer shall be liable to Eskom for the cost of any remedial action which has to be carried out by Eskom.
12. The clearances between Eskom's live electrical equipment and the proposed construction work shall be observed as stipulated by *Regulation 15 of the Electrical Machinery Regulations of the Occupational Health and Safety Act, 1993 (Act 85 of 1993)*.
13. Equipment shall be regarded electrically live and therefore dangerous at all times.
14. In spite of the restrictions stipulated by Regulation 15 of the Electrical Machinery Regulations of the Occupational Health and Safety Act, 1993 (Act 85 of 1993), as an additional safety precaution, Eskom will not approve the erection of houses, or structures occupied or frequented by human beings, under the power lines or within the servitude restriction area.
15. Eskom may stipulate any additional requirements to highlight any possible exposure to Customers or Public to coming into contact or be exposed to any dangers of Eskom plant.
16. It is required of the developer to familiarise himself with all safety hazards related to Electrical plant.
17. Any third party servitudes encroaching on Eskom servitudes shall be registered against Eskom's title deed at the developer's own cost. If such a servitude is brought into being, its existence should be endorsed on the Eskom servitude deed concerned, while the third party's servitude deed must also include the rights of the affected Eskom servitude.

John Geeringh (Pr Sci Nat)(EAPASA)  
Senior Consultant Environmental Management  
Eskom Transmission Division: Land & Rights  
Megawatt Park, D1Y42, Maxwell Drive, Sunninghill, Sandton.  
P O Box 1091, Johannesburg, 2000.  
Tel: 011 516 7233  
Cell: 083 632 7663  
Fax: 086 661 4064  
E-mail: john.geeringh@eskom.co.za

	<p style="text-align: center;"><b>SCOT</b></p>	<p style="text-align: center;"><b>Technology</b></p>
---	--	--

Title: **Renewable Energy Generation Plant Setbacks to Eskom Infrastructure** Unique Identifier: **240-65559775**

Alternative Reference Number: **N/A**

Area of Applicability: **Power Line Engineering**



Documentation Type: **Guideline**

Revision: **2**

Total Pages: **9**

Next Review Date: **N/A**

Disclosure Classification: **CONTROLLED DISCLOSURE**

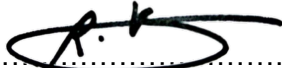
Compiled by	Approved by	Authorised by
		
<p><b>J W Chetty</b> <b>Mechanical Engineer</b></p>	<p><b>B Ntshuntsha</b> <b>Chief Engineer (Lines)</b></p>	<p><b>R A Vajeth</b> <b>Snr Manager (Lines) and SCOT/SC/ Chairperson</b></p>
<p>Date: 15 / 09 / 2020</p>	<p>Date: 30/10/2020</p>	<p>Date: 30/10/2020</p>



## **CONTENTS**

	<b>Page</b>
<b>EXECUTIVE SUMMARY .....</b>	<b>3</b>
<b>1. INTRODUCTION .....</b>	<b>4</b>
<b>2. SUPPORTING CLAUSES.....</b>	<b>4</b>
2.1 SCOPE .....	4
2.1.1 Purpose .....	5
2.1.2 Applicability.....	5
2.2 NORMATIVE/INFORMATIVE REFERENCES.....	5
2.2.1 Normative .....	5
2.2.2 Informative.....	5
2.3 DEFINITIONS.....	6
2.3.1 Disclosure Classification .....	6
2.4 ABBREVIATIONS.....	6
2.5 ROLES AND RESPONSIBILITIES.....	6
2.6 PROCESS FOR MONITORING.....	6
2.7 RELATED/SUPPORTING DOCUMENTS.....	6
<b>3. DOCUMENT CONTENT.....</b>	<b>6</b>
3.1 INTERNATIONAL SETBACK COMPARISON .....	6
3.2 ESKOM REQUIRED SETBACKS .....	7
<b>4. AUTHORISATION.....</b>	<b>9</b>
<b>5. REVISIONS .....</b>	<b>9</b>
<b>6. DEVELOPMENT TEAM .....</b>	<b>9</b>

## **FIGURES**

Figure 1: Horizontal Axis Wind Turbine.....	8
---	---

### **CONTROLLED DISCLOSURE**

When downloaded from the EDMS, this document is uncontrolled and the responsibility rests with the user to ensure it is in line with the authorised version on the system.

## **EXECUTIVE SUMMARY**

In recent decades, the use of wind turbines, concentrated solar plants and photovoltaic plants have been on the increase as it serves as an abundant source of energy. This document specifies proposed setbacks for wind turbines and the reasons for these setbacks from infrastructure as well as setbacks for concentrated solar plants and photovoltaic plants. Setbacks for wind turbines employed in other countries were compared and a general setback to be used by Eskom was suggested for use with wind turbines and other renewable energy generation plants.

### **CONTROLLED DISCLOSURE**

When downloaded from the EDMS, this document is uncontrolled and the responsibility rests with the user to ensure it is in line with the authorised version on the system.

## **1. INTRODUCTION**

During the last few decades, a large amount of wind turbines have been installed in wind farms to accommodate for the large demand of energy and depleting fossil fuels. Wind is one of the most abundant sources of renewable energy. Wind turbines harness the energy of this renewable resource for integration in electricity networks. The extraction of wind energy is its primary function and thus the aerodynamics of the wind turbine is important. There are many different types of wind turbines which will all exhibit different wind flow characteristics. The most common wind turbine used commercially is the Horizontal Axis Wind Turbine. Wind flow characteristics of this turbine are important to analyse as it may have an effect on surrounding infrastructure.

Wind turbines also cause large turbulence downwind that may affect existing infrastructure. Debris or parts of the turbine blade, in the case of a failure, may be tossed behind the turbine and may lead to damage of infrastructure in the wake path.

This document outlines the minimum distances that need to be introduced between a wind turbine and Eskom infrastructure to ensure that debris and / or turbulence would not negatively impact on the infrastructure and future expansion of infrastructure (lines and substation) as per the long term planning scenario.

Safety distances of wind turbines from other structures as implemented by other countries were also considered and the reasons for their selection were noted. All renewable energy developments are approved by The Department of Environmental Affairs, Forestry and Fisheries (DEFF) in terms of NEMA. The DEFF is aware of the setbacks guideline, however they cannot use it in terms of decision making since the setbacks document has no legal standing in SA and it would be outside of their mandate who have been advised to follow the guidelines herein.

Concentrated solar plants and photovoltaic plants setbacks away from substations were also to be considered to prevent restricting possible power line access routes to the substation and possible expansion of substations.

## **2. SUPPORTING CLAUSES**

### **2.1 SCOPE**

This document provides guidance on the safe distance that a wind turbine should be located from any Eskom power line or substation. Although it is not based on any legislative requirement, it is deemed important that Eskom's infrastructure and future network expansion planning is not impeded. The document specifies proposed setback distances for transmission lines (220 kV to 765 kV), distribution lines

**CONTROLLED DISCLOSURE**

(66 kV to 132 kV) and all Eskom substations. Proposed setbacks for concentrated solar plants and photovoltaic plants are also specified away from substations.

### **2.1.1 Purpose**

Setbacks for wind turbines and power lines / substations are required for various reasons. These include possible catastrophic failure of the turbine blade that may release fragments and which may be thrown onto nearby power lines that may result in damage with associated unplanned outages. Turbulence behind the turbine may affect helicopter flight during routine Eskom live line maintenance and inspections that may lead to safety risk of the aircraft / personnel. Concentrated solar plants and photovoltaic plants setback away from substations were required to prevent substations from being boxed in by these renewable generation plants limiting line route access to the substations and possible future substation expansion.

### **2.1.2 Applicability**

This document is applicable to the siting of all new and existing wind turbines, concentrated solar plants and photovoltaic plants near power lines and substations and in line of site between Eskom telecommunication infrastructure, including future Eskom renewable energy development.

## **2.2 NORMATIVE/INFORMATIVE REFERENCES**

### **2.2.1 Normative**

1. <http://www.envir.ee/orb.aw/class=file/action=preview/id=1170403/Hiiumaa+turbulence+impact+EMD.pdf>.
2. <http://www.energy.ca.gov/2005publications/CEC-500-2005-184/CEC-500-2005-184.PDF>
3. <http://www.adamscountywind.com/Revised%20Site/Windmills/Adams%20County%20Ordinance/Adams%20County%20Wind%20Ord.htm>
4. [http://www.dsireusa.org/incentives/incentive.cfm?Incentive\\_Code=PA11R&RE=1&EE=1](http://www.dsireusa.org/incentives/incentive.cfm?Incentive_Code=PA11R&RE=1&EE=1)
5. <http://www.wind-watch.org/documents/european-setbacks-minimum-distance-between-wind-turbines-and-habitations/>
6. <http://www.publications.parliament.uk/pa/ld201011/ldbills/017/11017.1-i.html>
7. [http://www.caw.ca/assets/pdf/Turbine\\_Safety\\_Report.pdf](http://www.caw.ca/assets/pdf/Turbine_Safety_Report.pdf)
8. Rogers J, Slegers N, Costello M. (2011) A method for defining wind turbine setback standards. Wind energy 10.1002/we.468

### **2.2.2 Informative**

None

**CONTROLLED DISCLOSURE**

When downloaded from the EDMS, this document is uncontrolled and the responsibility rests with the user to ensure it is in line with the authorised version on the system.

## 2.3 DEFINITIONS

Definition	Description
Setback	The minimum distance between a wind turbine and boundary line/dwelling/road/infrastructure/servitude etc.
Flicker	Effect caused when rotating wind turbine blades periodically cast shadows
Tip Height	The total height of the wind turbine ie. Hub height plus half rotor diameter (see Figure1)

### 2.3.1 Disclosure Classification

**Controlled disclosure:** controlled disclosure to external parties (either enforced by law, or discretionary).

## 2.4 ABBREVIATIONS

Abbreviation	Description
None	

## 2.5 ROLES AND RESPONSIBILITIES

All parties involved in the positioning wind turbines, concentrated solar plants and photovoltaic plants near power lines/substations should endeavour to follow the setbacks outlined in this guideline.

## 2.6 PROCESS FOR MONITORING

Agreement by Eskom in writing on any encroachment of the setbacks distance should be requested via the Grid Access Unit. Eskom should ensure that every application for renewable energy (RE) developments are informed about the existence of the setbacks document early in the RE planning process to ensure maximum effect. This includes Eskom RE development.

## 2.7 RELATED/SUPPORTING DOCUMENTS

None

## 3. DOCUMENT CONTENT

### 3.1 INTERNATIONAL SETBACK COMPARISON

Wind Turbine setbacks employed by various countries were considered. It was found that setbacks were determined for various reasons that include noise, flicker, turbine blade failure and wind effects as well as

**CONTROLLED DISCLOSURE**

future network expansion planning. The distances (setbacks) varied based on these factors and were influenced by the type of infrastructure

Wind turbine setbacks varied for roads, power lines, dwellings, buildings and property and it was noted that the largest setbacks were employed for reasons of noise and flicker related issues [1-7]. Very few countries specified setbacks for power lines.

The literature survey [1-7], yielded information about studies and experiments were conducted to determine the distance that a broken fragment from a wind turbine might be thrown. Even though of low probability of hitting a power line [ $5.0 \times 10^{-5}$  <sup>[8]</sup>], the distances recorded were significant [750m <sup>[8]</sup>]

Wind turbines may also cause changes in wind patterns with turbulent effects behind the hub. These factors influence the wind turbine setbacks specified in this document.

Setbacks were thus introduced to prevent any damage to Eskom infrastructure and impedance to operation and future network expansion planning.

Renewable energy plant can also limit access into substations for power lines of all voltages. A setback distance should therefore be employed to prevent substations from being boxed in by these generation plants and preventing future network expansion. These setback distances are specified in this document.

### **3.2 ESKOM RECOMMENDED SETBACKS**

Any renewable energy applicant should engage with Eskom to determine if their plant layout or positioning of turbines, CSP or PV infrastructure would encroach on the proposed setbacks provided for in this guideline and to ensure that their planning and Eskom's future expansion planning is taken into account. Eskom must inform all renewable energy developers, including Eskom RE, of the existence of the setbacks guideline early in the development process. Should there be an encroachment, a formal request should be sent to and accepted by Eskom in writing if any of the below mentioned setback distances are infringed upon:

- Eskom requests a setback distance of 3 times the tip height of the wind turbine from the edge of the closest Eskom servitude (including vacant servitudes) for transmission lines (220kV to 765kV) and Substations.
- Eskom requests a setback distance of 1 times the tip height of the wind turbine from the edge of the closest Eskom servitude (including vacant servitudes) for distribution lines (66 kV to 132 kV) and Substations.

**CONTROLLED DISCLOSURE**

- A written request should be sent to Eskom via the Grid Access Unit regarding any proposed wind turbine, concentrated solar plants and photovoltaic activity within a 5 km radius of a substation for Eskom to comment on.
- Where concentrated solar plants, photovoltaic structures, battery storage systems (BESS) and other renewable generation plants fall within a 2 km radius of the closest point of a transmission or distribution substation (66kV to 765kV), a written agreement with Eskom is recommended during the planning phase of such plant or structures to ensure Eskom's future planning is not impeded.
- Applicants should not position any wind turbine in the line of site between and two Eskom Radio Telecommunication masts. It should be proven that Eskom radio telecommunication systems (mainly microwave systems) will not be affected in any way by wind turbines due to the criticality of this infrastructure in terms of network operation. Eskom Telecommunications should be engaged on this matter.
- If the position or size of any turbine changes and subsequently infringes on any of the above stated setbacks, a request for relaxation must be sent through to Eskom as per the point mentioned above.

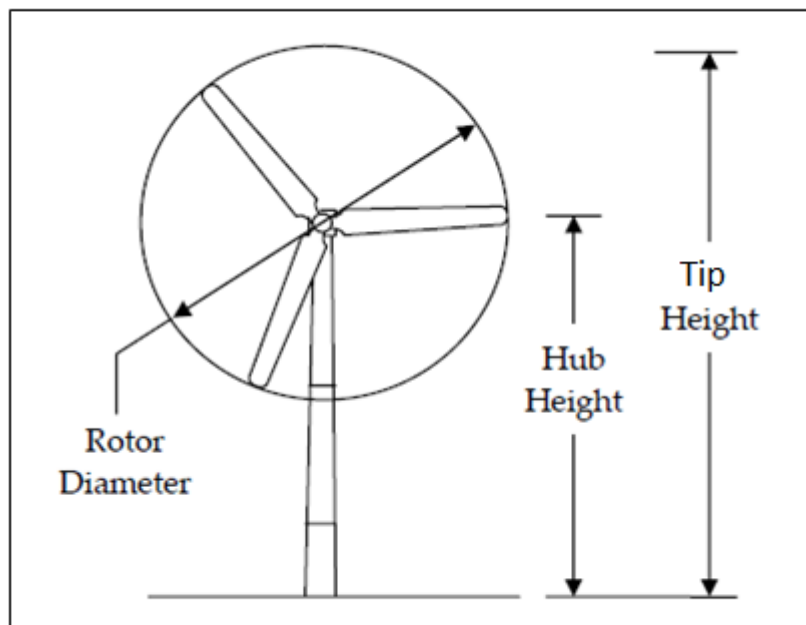

**Figure 1: Horizontal Axis Wind Turbine [2]**

**CONTROLLED DISCLOSURE**

When downloaded from the EDMS, this document is uncontrolled and the responsibility rests with the user to ensure it is in line with the authorised version on the system.

#### **4. AUTHORISATION**

This document has been seen and accepted by:

<b>Name &amp; Surname</b>	<b>Designation</b>
V Naidoo	Chief Engineer
Dr P Pretorius	Electrical Specialist
J Geeringh	Snr Consultant Environ Mngt
B Haridass	Snr Consultant Engineer
B Ntshunsha	Chief Engineer
R Vajeth	Snr Manager (Lines)
D A Tunncliff	Snr Manager L&R (Acting)
B Branfield	Snr Consultant Engineer

#### **5. REVISIONS**

<b>Date</b>	<b>Rev.</b>	<b>Compiler</b>	<b>Remarks</b>
November 2013	0	J W Chetty	First Publication - No renewable energy generation plant setback specification in existence.
October 2018	1	JW Chetty	Modification to sub-section 3.2 to provide more clarity for application procedure.
June 2020	2	JW Chetty	Content within the guideline was re-worded to explain the benefits of mutual agreements between the applicants and ESKOM rather than the application being a legal obligation.

#### **6. DEVELOPMENT TEAM**

The following people were involved in the development of this document:

Jonathan Chetty (Mechanical Engineer)

Vivendhra Naidoo (Chief Engineer)

Dr Pieter Pretorius (Electrical Specialist)

John Geeringh (Snr Consultant Environ Mngt)

Bharat Haridass (Snr Consultant Engineer)

Riaz Vajeth (Snr Manager (Lines))

Bruce Ntshunsha (Chief Engineer)

David Tunncliff (Snr Manager L&R Acting)

**CONTROLLED DISCLOSURE**



SANRAL

## Savannah Public Process

---

**From:** Chumisa Njingana (SR) [REDACTED]  
**Sent:** Sunday, November 22, 2020 4:15 PM  
**To:** Savannah Public Process  
**Cc:** Nenekazi Songxaba (SR)  
**Subject:** RE: DEVELOPMENT OF A CLUSTER OF RENEWABLE ENERGY FACILITIES: Notification of commencement of Basic Assessment and Public Participation Processes

**Importance:** High

Good day Nicolene

Hope all is well.

SANRAL has the following comments, with regards to the proposed above mentioned subject development, within the Blue Crane Local Municipality (R63/N10) and Makana Local Municipality (N2/R67):

- No installation of any infrastructure inside the Road Reserve.
- The wind turbines must be erected at least 200 metres from the Nation Road Reserve boundary, if this requirement cannot be met, then a good motivation has to be submitted to SANRAL as to why the wind turbines should be erected closer.
- All other buildings / structures should be erected at least 60 metres from the National Road Reserve boundary and / or 500 metres from any intersection.
- If access is required from the National Road, an approval from SANRAL is required, otherwise access can be obtained from the nearest numbered route.
- A formal application together with the plans of the proposed wind farm must be submitted to SANRAL.
- Construction of all work may only commence after written approval has been obtained from SANRAL.

Kind regards  
Chumisa

Chumisa Njingana (SR)  
ENGINEERING



Please consider the environment before printing.

---

**Disclaimer**

This message contains confidential information and is intended only for the individual named. If you are not the named addressee you should not disseminate, distribute or copy this e-mail. Please notify the sender immediately by e-mail if you have received this e-mail by mistake and delete this e-mail from your system. E-mail transmission cannot be guaranteed to be secure or without errors as information could be intercepted, corrupted, lost, destroyed, arrive late or incomplete, or contain viruses. The sender therefore does not accept liability for any errors or omissions in the contents of this message, which arise as a result of e-mail transmission. If verification is required please request a hard-copy version. The South African National Roads Agency SOC Ltd, PO Box 415, Pretoria, 0001, South Africa, Tel +27-(0)12 844 8000, [www.nra.co.za](http://www.nra.co.za). This Disclaimer is deemed to form part of the content of this email in terms of Section 11 of the Electronic Communications and Transactions Act, 25 of 2002.

---

---

**From:** Mpati Makoa (HO)  
**Sent:** 18 November 2020 08:09 AM  
**To:** Chumisa Njingana (SR) [REDACTED]  
**Cc:** Nenekazi Songxaba (SR) [REDACTED]  
**Subject:** FW: DEVELOPMENT OF A CLUSTER OF RENEWABLE ENERGY FACILITIES: Notification of commencement of Basic Assessment and Public Participation Processes

Good morning ladies

Please see attached for your information and attention.

Kind regards  
Mpati

---

**From:** Public Process <[publicprocess@savannahsa.com](mailto:publicprocess@savannahsa.com)>  
**Sent:** Tuesday, November 17, 2020 5:03 PM  
**To:** Mpati Makoa (HO) [REDACTED]  
**Subject:** DEVELOPMENT OF A CLUSTER OF RENEWABLE ENERGY FACILITIES: Notification of commencement of Basic Assessment and Public Participation Processes

## **DEVELOPMENT OF A CLUSTER OF RENEWABLE ENERGY FACILITIES BETWEEN SOMERSET EAST AND MAKHANDA, EASTERN CAPE PROVINCE**

Dear Interested and Affected Parties,

A cluster of renewable energy facilities is proposed to be developed on various project sites located between Somerset East and Makhanda within the Cookhouse Renewable Energy Development Zone (REDZ), as well as the Eastern Strategic Transmission Corridor. The cluster consists of nine (9) projects which includes six (6) wind farms, two (2) solar energy facilities and one (1) Main Transmission Substation (MTS). A suitable project site for each development has been identified by the project development companies and the entire

extent of the projects is located within the Sarah Baartman District Municipality. The western section is located within the Blue Crane Route Local Municipality and the eastern section within the Makana Local Municipality.

Please find attached the Background Information Document which provides additional information regarding the application for the six (6) wind energy facilities, the two (2) solar energy facilities and the 400MW Main Transmission Substation.

We kindly request you to complete the attached stakeholder registration and comment form to formally register on the project databases and indicate in which of the nine (9) projects (or all) your interest lies.

Please do not hesitate to contact us should you require additional information and/or clarification regarding the projects. Our team welcomes your participation and look forward to your involvement throughout this process.

Kind regards,

[Unsubscribe this type of email](#)



t: 011 656 3237  
f: 086 684 0547

**Nicolene Venter**  
Public Process

e: [publicprocess@savannahsa.com](mailto:publicprocess@savannahsa.com)  
c: +27 (0) 60 978 8396

SAWEA Award for Leading Environmental Consultant on Wind Projects in 2013 & 2015

Eastern Cape Parks & Tourism Agency

## Savannah Public Process

---

**From:** Savannah Public Process  
**Sent:** Tuesday, January 5, 2021 1:14 PM  
**To:** 'Shanè Gertze'  
**Cc:** Malaika Koali-Lebona  
**Subject:** CLUSTER OF RENEWABLE ENERGY FACILITIES: .KMZ of project localities  
**Attachments:** SE2602-Affected properties - I&AP Distribution (Dec 2020).kmz

Dear Shanè,

Firstly, please accept our apologies for the delay in providing the Eastern Cape Parks & Tourism Agency with the request .KMZ file.

Attached the .KMZ file as requested.

Shanè, it will be appreciated if you can provide us with the following information (data files/shape files/link to applicable page on your website):

- Informal and/or private nature reserves within the study area of the above-mentioned developments in the Eastern Cape; and
- A .KMZ file for Kwandwe Private Nature Reserve. It was brought under our attention that the information we obtained from the DEFF (DEA) database is incorrect.

Kind regards,

---

**From:** Shanè Gertze [REDACTED]  
**Sent:** Thursday, December 3, 2020 3:02 PM  
**To:** Savannah Public Process <publicprocess@savannahsa.com>  
**Cc:** Malaika Koali-Lebona <[REDACTED]>  
**Subject:** FW: DEVELOPMENT OF A CLUSTER OF RENEWABLE ENERGY FACILITIES: Notification of commencement of Basic Assessment and Public Participation Processes

Hi Nicolene

Can you please a kml/kmz file of the localities for this proposed project.

Many thanks,

**Shanè Gertze**

Environmental Planner

[REDACTED]  
17-25 Oxford Street, East London, 5201  
PO Box 11235, Southernwood, East London, 5213

*Eastern Cape*  
PARKS & TOURISM AGENCY

[www.visiteasterncape.co.za](http://www.visiteasterncape.co.za)



**From:** Public Process [<mailto:publicprocess@savannahsa.com>]

**Sent:** 17 November 2020 05:05 PM

**To:** Andre Van der Spuy

**Subject:** DEVELOPMENT OF A CLUSTER OF RENEWABLE ENERGY FACILITIES: Notification of commencement of Basic Assessment and Public Participation Processes

**DEVELOPMENT OF A CLUSTER OF RENEWABLE ENERGY FACILITIES BETWEEN SOMERSET EAST AND MAKHANDA,  
EASTERN CAPE PROVINCE**

Dear Interested and Affected Parties,

A cluster of renewable energy facilities is proposed to be developed on various project sites located between Somerset East and Makhanda within the Cookhouse Renewable Energy Development Zone (REDZ), as well as the Eastern Strategic Transmission Corridor. The cluster consists of nine (9) projects which includes six (6) wind farms, two (2) solar energy facilities and one (1) Main Transmission Substation (MTS). A suitable project site for each development has been identified by the project development companies and the entire extent of the projects is located within the Sarah Baartman District Municipality. The western section is located within the Blue Crane Route Local Municipality and the eastern section within the Makana Local Municipality.

Please find attached the Background Information Document which provides additional information regarding the application for the six (6) wind energy facilities, the two (2) solar energy facilities and the 400MW Main Transmission Substation.

We kindly request you to complete the attached stakeholder registration and comment form to formally register on the project databases and indicate in which of the nine (9) projects (or all) your interest lies.

Please do not hesitate to contact us should you require additional information and/or clarification regarding the projects. Our team welcomes your participation and look forward to your involvement throughout this process.

Kind regards,

[Unsubscribe this type of email](#)



t: 011 656 3237  
f: 086 684 0547

**Nicolene Venter**  
Public Process

e: [publicprocess@savannahsa.com](mailto:publicprocess@savannahsa.com)  
c: +27 (0) 60 978 8396

**SAWEA Award for Leading Environmental Consultant on Wind Projects in 2013 & 2015**

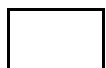

Virus-free. [www.avast.com](http://www.avast.com)

**Disclaimer**

The information contained in this communication from the sender is confidential. It is intended solely for use by the recipient and others authorized to receive it. If you are not the recipient, you are hereby notified that any disclosure, copying, distribution or

taking action in relation of the contents of this information is strictly prohibited and may be unlawful.

This email has been scanned for viruses and malware, and may have been automatically archived by **Mimecast Ltd**, an innovator in Software as a Service (SaaS) for business. Providing a **safer** and **more useful** place for your human generated data. Specializing in; Security, archiving and compliance. To find out more [Click Here](#).



## INTERESTED AND AFFECTED PARTIES

## Savannah Public Process

---

**From:** Savannah Public Process  
**Sent:** Tuesday, February 23, 2021 1:59 PM  
**To:** [REDACTED]  
**Subject:** RE: public participation notice.

Dear Sir,

This e-mail serves to confirm our telephone discussion a few minutes ago in which I requested your name and surname to register you on the projects' databases and to inform you of the availability of the Basic Assessment Reports.

You informed us that there is no need to obtain your information and that the matter can be considered attended to.

Kind regards,



t: +27 (0)11 656 3237  
f: +27 (0) 86 684 0547

Nicolene Venter  
**Public Process**

e: [Publicprocess@savannahsa.com](mailto:Publicprocess@savannahsa.com)  
c: +27 (0)60 978 8396

SAWEA Award for Leading Environmental Consultant on Wind Projects in 2013 & 2015

---

**From:** [REDACTED]  
**Sent:** Thursday, November 12, 2020 11:29 AM  
**To:** Savannah Public Process <publicprocess@savannahsa.com>  
**Subject:** public participation notice.

I suggest that your half page advert in The Herald today is possibly not legal. The headline refers to an area between Somerset East and a town that I believe no longer exists. Perhaps you should consult your lawyers on the matter to ascertain the correctness of the issue.

Sent from my Galaxy

## Savannah Public Process

---

**From:** Savannah Public Process  
**Sent:** Wednesday, November 18, 2020 4:32 AM  
**To:** Jessica Els; jadon@red-cap.co.za  
**Cc:** Ronald Baloyi  
**Subject:** RE: Development of a Cluster of Renewable Energies Between Somerset East and Grahamstown, Eastern Cape

Tracking:	Recipient	Delivery
	Jessica Els [REDACTED]	
	Ronald Baloyi	Delivered: 11/18/2020 4:32 AM

Dear Jadon,

Hope you are keeping well!

Jadon, as requested by Jessica below, please see the release code below.

Kind regards,

---

**From:** Jessica Els [REDACTED]  
**Sent:** Tuesday, November 17, 2020 2:35 PM  
**To:** Savannah Public Process <publicprocess@savannahsa.com>  
**Cc:** Ronald Baloyi <Ronald@savannahsa.com>  
**Subject:** Re: Development of a Cluster of Renewable Energies Between Somerset East and Grahamstown, Eastern Cape

Hi Nicolene

Please can you send the release code to Jadon as well? - [REDACTED]

Thanks  
Jessica

On Tue, Nov 17, 2020 at 1:19 PM Savannah Public Process <[publicprocess@savannahsa.com](mailto:publicprocess@savannahsa.com)> wrote:

Hi Jessica,

Correct – we have schedule the release of the BID today.

Herewith the release code: [REDACTED]

Kind regards,

---

**From:** Jessica Els <[REDACTED]>  
**Sent:** Monday, November 16, 2020 8:18 AM  
**To:** Savannah Public Process <[publicprocess@savannahsa.com](mailto:publicprocess@savannahsa.com)>  
**Cc:** Ronald Baloyi <[Ronald@savannahsa.com](mailto:Ronald@savannahsa.com)>  
**Subject:** Re: Development of a Cluster of Renewable Energies Between Somerset East and Grahamstown, Eastern Cape

Hi Nicolene

Thanks - I trust you had a good weekend.

Will we receive a unique code to view the public documents on your site?

Kind regards

Jessica

On Fri, Nov 13, 2020 at 8:49 PM Savannah Public Process <[publicprocess@savannahsa.com](mailto:publicprocess@savannahsa.com)> wrote:

Hi Jessica,

We herewith acknowledge receipt of Jadon's registration and please find attached proof of registration.

Kind regards,

---

**From:** Jessica Els <[REDACTED]>  
**Sent:** Friday, November 13, 2020 2:42 PM  
**To:** Savannah Public Process <[publicprocess@savannahsa.com](mailto:publicprocess@savannahsa.com)>  
**Cc:** Ronald Baloyi <[Ronald@savannahsa.com](mailto:Ronald@savannahsa.com)>  
**Subject:** Re: Development of a Cluster of Renewable Energies Between Somerset East and Grahamstown, Eastern Cape

Hi Nicolene

My colleague asked that you register him as well, please. Attached is his form.

Kind regards

Jessica

On Fri, Nov 13, 2020 at 9:54 AM Jessica Els [REDACTED] wrote:

Hi Nicolene

Thank you so much. Please see attached.

Kind regards

Jessica

On Thu, Nov 12, 2020 at 3:42 PM Savannah Public Process <[publicprocess@savannahsa.com](mailto:publicprocess@savannahsa.com)> wrote:

Dear Jessica,

Thank you for your request below.

Would you please be so kind and complete the attached registration form and return to us via e-mail.

Kind regards,

t: 011 656 3237  
f: 086 684 0547

e: [publicprocess@savannahsa.com](mailto:publicprocess@savannahsa.com)  
c: +27 (0) 60 978 8396

SAWEA Award for Leading Environmental Consultant on Wind Projects in 2013 & 2015

---

**From:** Jessica Els [REDACTED]  
**Sent:** Thursday, November 12, 2020 10:36 AM  
**To:** Savannah Public Process <[publicprocess@savannahsa.com](mailto:publicprocess@savannahsa.com)>  
**Subject:** Re: Development of a Cluster of Renewable Energies Between Somerset East and Grahamstown, Eastern Cape

Hi Nicolene

Please could you also add me to the list of I&AP's.

Thanks

Jessica

On Thu, Nov 12, 2020 at 10:31 AM Jessica Els [REDACTED] wrote:

Hi Nicolene

I trust you are well.

I was just looking at your cluster of renewable energy projects project and was wondering if all the wind farms are being developed by 1 developer or multiple developers?

Kind regards

Jessica

**BASIC ASSESSMENT PROCESSES AND PUBLIC PARTICIPATION PROCESS**

**DEVELOPMENT OF A CLUSTER OF RENEWABLE ENERGY FACILITIES BETWEEN SOMERSET EAST AND MAKHANDA, EASTERN**

November 2020

Return completed registration and comment form to: **Nicolene Venter** or **Ronald Baloyi** of **Savannah Environmental**

**Phone:** 011 656 3237 / **Mobile (incl. 'please call me'):** 060 978 8396 / **Fax:** 086 684 0547

**E-mail:** publicprocess@savannahsa.com **Postal Address:** PO Box 148, Sunninghill, 2157

**Your registration as an interested and/or affected party will be applicable for this project only and your contact details provided are protected by the PoPI Act of 2013**

**Please provide your complete contact details:**

Name &	Neale Howarth
Surname:	
Organisation:	INDALO Protected Environment
Designation:	Chairman
Postal Address:	
Telephone:	
Mobile:	
E-mail:	

**Please indicate on which project/s you would like to register as an interested and affected party (I&AP)?**  
(please tick the relevant box)

**Wind Farms**

Hamlet	<input type="checkbox"/>	Rippon	<input type="checkbox"/>	Redding	<input type="checkbox"/>	Aeolus	<input type="checkbox"/>	Wind Garden	<input checked="" type="checkbox"/>	Fronteer	<input checked="" type="checkbox"/>
--------	--------------------------	--------	--------------------------	---------	--------------------------	--------	--------------------------	-------------	-------------------------------------	----------	-------------------------------------

**Solar Energy Facilities**

Solaris Fields	<input type="checkbox"/>	Sun Garden	<input type="checkbox"/>
----------------	--------------------------	------------	--------------------------

**REDZ 3 Power Grid Corridor 400MTS**

Grid Connection Corridor	<input type="checkbox"/>
--------------------------	--------------------------

**Note:** In terms of EIA Regulations, 2014, as amended, Regulation 43(1), you are required to register as an I&AP to receive further correspondence regarding the Basic Assessment process and comment on the Reports being made available for comments, and to disclose any direct business, financial, personal or other interest which you may have in the approval or refusal of the application (add additional pages if necessary):

**PLEASE TURN OVER PAGE**

Please list your comments regarding the Environmental Impact Assessment process (add additional pages if necessary):

Major affect on tourism based game reserves.  
Has direct impact on grading of our lodges,  
but more importantly, the noise & danger impact  
on our flora & fauna.

**Please provide contact details of any other persons who you regard as a potential interested or affected party:**

Name & Surname:	
Postal Address:	
Telephone:	
Mobile:	
E-mail:	



## Savannah Public Process

---

**From:** Savannah Public Process  
**Sent:** Wednesday, November 18, 2020 1:13 PM  
**To:** [REDACTED]  
**Cc:** Ronald Baloyi  
**Subject:** RE: Registration as an IAP for Development of a Cluster of Renewable Energies Between Somerset East and Makhandha, Eastern Cape  
**Attachments:** EASPE-HOBSON Stevon (2020.11.18).pdf; SE2602-WindRelic RegCommForm-FINAL.pdf

Tracking:	Recipient	Delivery
	[REDACTED] Ronald Baloyi	Delivered: 11/18/2020 1:13 PM

Dear Stevon,

Please receive herewith confirmation that you are registered as an interested and affected party on the above-projects databases as requested.

Would you please be so kind and complete the attached registration form by indicating in which project (or all projects) you would like to register for.

Kind regards,

---

**From:** Stevonh@easpe.co.za [REDACTED]  
**Sent:** Wednesday, November 18, 2020 8:44 AM  
**To:** Savannah Public Process <publicprocess@savannahsa.com>  
**Subject:** Registration as an IAP for Development of a Cluster of Renewable Energies Between Somerset East and Makhandha, Eastern Cape

Good Morning Nicolene

I trust this finds you well.

I would like to register as an Interested and Affected Party for the Development of a Cluster of Renewable Energies Between Somerset East and Makhandha, Eastern Cape Project.

As an Eastern Cape resident I have a keen interest in the development of the province and these projects could bring much needed development and jobs to the region.

Regards,

**Stevon Hobson**  
**Engineering Advice & Services (Pty) Ltd**

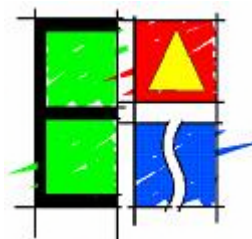

The information transmitted hereby is confidential and may be legally privileged. If not the intended recipient, you may not read, use or disseminate that information. Engineering Advice and Services does not accept liability for any personal views expressed in this message.

## Savannah Public Process

---

**From:** Savannah Public Process  
**Sent:** Wednesday, November 18, 2020 1:06 PM  
**To:** [REDACTED]  
**Cc:** Tsheko Ratsheko; Ronald Baloyi  
**Subject:** Interest in renewable energy projects: Confirmation of Registration  
**Attachments:** ARMINCO-BRITCHFORD Grahame (2020.11.18).pdf; SE2602-WindRelic RegCommForm-FINAL.pdf

<b>Tracking:</b>	<b>Recipient</b>	<b>Delivery</b>
	[REDACTED]	
	Tsheko Ratsheko	
	Ronald Baloyi	Delivered: 11/18/2020 1:06 PM

Dear Grahame,

Please receive herewith confirmation that you are registered as an interested and affected party on the above-projects databases as requested.

Would you please be so kind and complete the attached registration form by indicating in which project (or all projects) you would like to register for.

Kind regards,

---

**From:** grahame@armincopiping.com [REDACTED]  
**Sent:** Wednesday, November 18, 2020 9:31 AM  
**To:** Savannah Public Process <publicprocess@savannahsa.com>  
**Cc:** Tsheko Ratsheko [REDACTED]  
**Subject:** Interest in renewable energy projects

Good day

I would like to register on this platform in order to participate in public commentary and to gain more information on renewable energy projects.

My company is a specialist piping fabricator and constructor and we, as a team, would like to engage in more renewable energy projects as opportunities present themselves. Our interests lie in wind, Solar and gas to power projects.

Many thanks

Warmest Regards

Grahame Britchford

 **arminco**  
ARMINCO PIPING PROJECTS  
Project Managers; Fabricators and Constructors  
A Level 2 B-BBEE Contributor



BASIC ASSESSMENT PROCESSES AND PUBLIC PARTICIPATION PROCESS

DEVELOPMENT OF A CLUSTER OF RENEWABLE ENERGY FACILITIES BETWEEN SOMERSET EAST AND MAKHANDA,  
EASTERN

November 2020

Return completed registration and comment form to: **Nicolene Venter** or **Ronald Baloyi** of Savannah Environmental

Phone: 011 656 3237 / Mobile (incl. 'please call me'): 060 978 8396 / Fax: 086 684 0547

E-mail: publicprocess@savannahsa.com Postal Address: PO Box 148, Sunninghill, 2157

Your registration as an interested and/or affected party will be applicable for this project only and your contact details provided are protected by the PoPI Act of 2013

Please provide your complete contact details:

Name &	ANGUS IAN SHOLTO-DOUGLAS		
Surname:	C-SA PROPERTIES (PTY) LTD		
Organisation:	MANAGING DIRECTOR		
Designation:	[REDACTED]		
Postal Address:	[REDACTED]		
Telephone:		Fax:	
Mobile:	[REDACTED]		
E-mail:	[REDACTED]		

Please indicate on which project/s you would like to register as an interested and affected party (I&AP)? (please tick the relevant box)

Wind Farms

Hamlet	Rippon	Redding	Aeolus	Wind Garden	<input checked="" type="checkbox"/>	Fronteer	<input checked="" type="checkbox"/>
--------	--------	---------	--------	-------------	-------------------------------------	----------	-------------------------------------

Solar Energy Facilities

Solaris Fields	Sun Garden
----------------	------------

REDZ 3 Power Grid Corridor 400MTS

Grid Connection Corridor	<input checked="" type="checkbox"/>
--------------------------	-------------------------------------

Note: In terms of EIA Regulations, 2014, as amended, Regulation 43(1), you are required to register as an I&AP to receive further correspondence regarding the Basic Assessment process and comment on the Reports being made available for comments, and to disclose any direct business, financial, personal or other interest which you may have in the approval or refusal of the application (add additional pages if necessary):

PLEASE TURN OVER PAGE

Please list your comments regarding the Environmental Impact Assessment process (add additional pages if necessary):

- We require the BA before final comments.
- The map of Kwandwe Protected Environment is incorrect.
- The impact of a WEF on a border of a PE and in the Biodiversity expansion corridor is of grave concern and questionable intent.
- We reserve all our rights to strongly oppose this poorly conceived plan which has failed twice before.

Please provide contact details of any other persons who you regard as a potential interested or affected party:

Name & Surname:

Postal Address:

Telephone:

Mobile:

E-mail:

## Savannah Public Process

---

**From:** Savannah Public Process  
**Sent:** Friday, November 20, 2020 9:12 AM  
**To:** Angus Sholto-Douglas; Ronald Baloyi  
**Cc:** Richard@summersinc.co.za  
**Subject:** RE: DEVELOPMENT OF A CLUSTER OF RENEWABLE ENERGY FACILITIES: Acknowledgement of Registration and Comments

<b>Tracking:</b>	<b>Recipient</b>	<b>Delivery</b>
	Angus Sholto-Douglas	
	Ronald Baloyi	Delivered: 11/20/2020 9:12 AM

Dear Angus,

In response to the comments submitted on your registration and comment form please be informed that the Basic Assessment (BA) processes only recently commenced (14 November), including the independent specialist assessments. It is envisaged that the BARs will be available for review and comment in the first quarter of 2021 and as a registered I&AP you will receive notification of the details thereof.

Your comments submitted in the registration and comment form will be considered and addressed in the respective Basic Assessment study (including the relevant specialist studies) and will be included in the comments and responses reports, as per the projects you have indicated to be registered for.

Please do not hesitate to contact us should you require any additional information or clarification regarding the BA process.

Kind regards,

---

**From:** Angus Sholto-Douglas <[REDACTED]>  
**Sent:** Thursday, November 19, 2020 11:02 AM  
**To:** Savannah Public Process <publicprocess@savannahsa.com>; 'Public Participation' <public.participation@ecpta.co.za>; Ronald Baloyi <Ronald@savannahsa.com>  
**Cc:** [REDACTED]  
**Subject:** RE: DEVELOPMENT OF A CLUSTER OF RENEWABLE ENERGY FACILITIES: Acknowledgement of Registration and Comments

Many thanks Nicolene

When can we expect to receive the Basic Assessment so we can comment on the detail of the proposed development?

Regards

Angus

---

**From:** Savannah Public Process [<mailto:publicprocess@savannahsa.com>]  
**Sent:** 19 November 2020 02:39 AM  
**To:** Angus Sholto-Douglas; 'Public Participation'; Ronald Baloyi  
**Cc:** [REDACTED]  
**Subject:** DEVELOPMENT OF A CLUSTER OF RENEWABLE ENERGY FACILITIES: Acknowledgement of Registration and Comments

Dear Angus,

Please receive herewith acknowledgement of receipt of your registration and the comments submitted.

The comments have been forwarded to the project team.

Kind regards,



t: 011 656 3237  
f: 086 684 0547

**Nicolene Venter**  
Public Process

e: [publicprocess@savannahsa.com](mailto:publicprocess@savannahsa.com)  
c: +27 (0) 60 978 8396

SAWEA Award for Leading Environmental Consultant on Wind Projects in 2013 & 2015

---

**From:** Angus Sholto-Douglas [REDACTED]

**Sent:** Wednesday, November 18, 2020 3:02 PM

**To:** 'Public Participation' <[public.participation@ecpta.co.za](mailto:public.participation@ecpta.co.za)>; Nicolene Venter <[nicolene@savannahsa.com](mailto:nicolene@savannahsa.com)>; Ronald Baloyi <[Ronald@savannahsa.com](mailto:Ronald@savannahsa.com)>

**Cc:** [REDACTED]

**Subject:** FW: DEVELOPMENT OF A CLUSTER OF RENEWABLE ENERGY FACILITIES: Notification of commencement of Basic Assessment and Public Participation Processes

Dear Nicolene and Ronald

Please see the attached document and acknowledge receipt.

Many thanks

Angus

ANGUS SHOLTO-DOUGLAS

[REDACTED] Web: [www.kwandwe.com](http://www.kwandwe.com)



Heatherton Towers, Kwandwe Private Game Reserve, Fort Brown District, Eastern Cape, 6140, South Africa

**BASIC ASSESSMENT PROCESSES AND PUBLIC PARTICIPATION PROCESS**

**DEVELOPMENT OF A CLUSTER OF RENEWABLE ENERGY FACILITIES BETWEEN SOMERSET EAST AND MAKHANDA, EASTERN**

November 2020

Return completed registration and comment form to: **Nicolene Venter** or **Ronald Baloyi** of **Savannah Environmental**

**Phone:** 011 656 3237 / **Mobile (incl. 'please call me'):** 060 978 8396 / **Fax:** 086 684 0547

**E-mail:** publicprocess@savannahsa.com **Postal Address:** PO Box 148, Sunninghill, 2157

Your registration as an interested and/or affected party will be applicable for this project only and your contact details provided are protected by the PoPI Act of 2013

Please provide your complete contact details:

Name &	HENDRIK OVENWAAL.
Surname:	
Organisation:	CSA PROPERTIES.
Designation:	GENERAL MANAGER
Postal Address:	[REDACTED]
Telephone:	[REDACTED]
Mobile:	[REDACTED]
E-mail:	[REDACTED]

Please indicate on which project/s you would like to register as an interested and affected party (I&AP)? (please tick the relevant box)

**Wind Farms**

Hamlet	<input type="checkbox"/>	Rippon	<input type="checkbox"/>	Redding	<input type="checkbox"/>	Aeolus	<input type="checkbox"/>	Wind Garden	<input checked="" type="checkbox"/>	Fronteer	<input checked="" type="checkbox"/>
--------	--------------------------	--------	--------------------------	---------	--------------------------	--------	--------------------------	-------------	-------------------------------------	----------	-------------------------------------

**Solar Energy Facilities**

Solaris Fields	<input type="checkbox"/>	Sun Garden	<input type="checkbox"/>
----------------	--------------------------	------------	--------------------------

**REDZ 3 Power Grid Corridor 400MTS**

Grid Connection Corridor	<input type="checkbox"/>
--------------------------	--------------------------

**Note:** In terms of EIA Regulations, 2014, as amended, Regulation 43(1), you are required to register as an I&AP to receive further correspondence regarding the Basic Assessment process and comment on the Reports being made available for comments, and to disclose any direct business, financial, personal or other interest which you may have in the approval or refusal of the application (add additional pages if necessary):

PLEASE REFER TO ATTACHED ANNEXURE A.

PLEASE TURN OVER PAGE



Please list your comments regarding the Environmental Impact Assessment process (add additional pages if necessary):

PLEASE REFER TO ATTACHED  
ANNEXURE A.

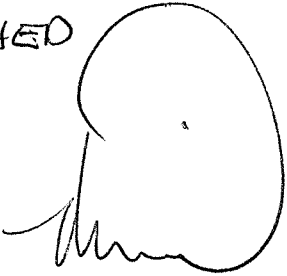

**Please provide contact details of any other persons who you regard as a potential interested or affected party:**

Name & Surname:

Postal Address:

Telephone:

Mobile:

E-mail:



Kwandwe Private Game Reserve lies in the Great Fish River Valley, east of the R67 between Grahamstown and Fort Beaufort. Presently Kwandwe permanently employs 260 people, most of who originate from the immediate area. Kwandwe has made significant investment in the local economy, including, but not limited to the Fort Brown Primary School, the Mgcamabele Community Centre and the establishment of the Ubunye Foundation.

Kwandwe and its subsidiaries inject an average R3,8million per month directly into the Makhanda economy through salaries and support of local business.

Kwandwe has numerous neighbours who will also be adversely affected by the proposed Wind Garden and Fronteer Wind Farms, namely Clifton Wildlife Estate, Hay Lodge, Lukhanyo Game Reserve, Vaalkrans Game Reserve, Lanka Safaris, Hellspoor Game Reserve, Woodlands Safari Estate and Ezulu.

Kwandwe prides itself on a conservation record that has spanned twenty years, conserving a wide variety of endangered species. Renewable energy is of critical importance to our planet and we as a group support this. We do, however, believe that Wind Energy Facilities need to be placed responsibly where minimal impact on the avifauna and wildlife based tourism ventures occurs.

We firmly believe that the position of these WEF's, will have significant impact on the tourism ventures of our greater area, especially Kwandwe Private Game Reserve.

## 1. THE VISUAL IMPACT OF THE PROPOSED FRONTEER AND WIND GARDEN WEF'S.

The clientele of Kwandwe is made up of mainly international guests, bringing much needed foreign currency into our economy. These guests are looking for experiences in wildlife areas that have as little exposure to visual and sound pollution. The proposed 130m high masts on the ridges on our south-western boundary will consequently detract from the sense of place and wildness of the experience we offer to our guests and have gained a reputation for over the past twenty years.

The Socio-Economic value of private game reserves in the Eastern Cape is well researched and studied by:

### 2.1

Nelson Mandela University, Centre for African Conservation Ecology Report No. 60, August 2011 titled "Combining conservation and socio-economic development: An assessment of eco-tourism-based private game reserves in the Eastern Cape by Andrew Muir; Andrew Skowno and Graham Kerley

## 2.2

Centre of African Conservation Ecology Report No 56. "COMBINING CONSERVATION AND DEVELOPMENT ON PRIVATE LANDS: AN ASSESSMENT OF ECOTOURISMBASED PRIVATE GAME RESERVES IN THE EASTERN CAPE" by Jeffrey A. Langholz and Graham Kerley.

## 2.3

J. D. Snowball and G. G. Antrobus: (2008) Ecotourism and Socio-economic development: The impact of the conservation, economic and social activities of private game reserves in the Eastern Cape. Rhodes University, Department of Economics and Economic History.

Renato Johnsson's paper "The Benefits of Wildlife Tourism in the Eastern Cape." (unpublished) refers. Johnsson's paper comments on the Socio-economic studies conducted above.

2.4 A 2019 Socio-Economic Research paper will be published by Rhodes University later in the year, giving an updated perspective on the socio-economic value of Private Game Reserves in the Eastern Cape.

## 2. NEGATIVE IMPACT ON ECO-TOURISM

Private Game Reserves are an important magnet that attracts tourists to the region, notably foreign tourists. For a large proportion of the estimated 1.5 million foreign tourists who visit South Africa every year, **scenery and wildlife** is the primary attraction, with 45% of them visiting at least one wildlife or nature reserve during their trip (Hall, 2007 cited in Indalo 2008.)

Ecotourism, as opposed to agriculture is an activity more likely to achieve economic and ecological sustainability in the long run, with greater benefits for the local communities in terms of employment, empowerment and general upliftment.

The original TERU report of 2004 found that ecotourism-based game farming has long been described as a sustainable alternative to livestock farming, especially in semi-arid areas – such as in the Eastern Cape - where low rainfall precludes cropping and livestock production is marginal. The study finds that:

"As a land- use, eco-tourism-based game farming is an economically and ecologically desirable alternative to other land uses, including mohair and dairy farming. Not only does it generate more income per unit area, but it also creates more jobs that are better paid." (2004: 20) "Private Game Reserves seek to blend earnings with ecology and business with biodiversity" (2006: 4)

This report provides the main findings of the studies; the employment effects of the conversion from farming to ecotourism resulted in more and better jobs being created, and

which has featured the upskilling of local workers in order for the local communities to be able to become involved in the ecotourism ventures. The studies also revealed the contribution of ecotourism to the wider economy, including attracting tourists to stay in the region longer. The move towards eco-tourism has further increased the conservation estate in the Province and provides for the conservation of the rural wildlife for the enjoyment of future generations.

### 3. IMPACT ON COMMUNITY OUTREACH PROGRAMMES AND EMPLOYMENT

Another important feature of the private game reserves of the INDALO association, which was highlighted in the study conducted by Rhodes University, was the extent to which PGRs have developed linkages with the communities in their area, “not because of any legal requirement, but rather from a sense of corporate responsibility.”

“A lesser known feature of Indalo PGRs is the extent of their engagement in community outreach programmes. All the reserves in the study reported some involvement in current community development projects. The engagement includes involvement with local institutions such as schools, taking less privileged children on game drives, in environmental and conservation awareness programmes, AIDs education, facilitating volunteer programmes at an AIDs orphanage, training of family members in small business activities and providing outlets for the sale of products such as vegetables and curios, and sponsoring recreational facilities and activities”.

From the onset the INDALO Private Game Reserves have demonstrated a commitment to job creation and community development through the retraining and conversion of their local workers to make the change from agriculture to the tourism industry. This includes employing local staff despite a lack of skills and, in many cases, illiteracy and providing them with skills training.

For most of the INDALO PGRs strict human resource and procurement policies are in place to employ previous farm workers and to recruit staff from the local community, with a long-term objective to implement skills development and employment equity plans. Due to a lack of hospitality-related skills, substantial in-house training is required. Training may take as long as 18 months to 5 years. Skills required on the PGRs include an ability to speak English, numeracy, literacy, hospitality skills, game ranging, security, anti-poaching, chef skills and public relations.

While the reliance on local rural population to provide an upscale tourism service presents a daunting challenge, the 2006 report considers that INDALO PGRs “are finding creative ways to meet tourists’ high expectations for superb service while also honoring their commitment to local communities.”

#### 4. IMPACT ON WIDER ECONOMY AND SOCIAL STRUCTURE

Ecotourism's Contribution to the Wider Economy:

There is an urgent need for national and provincial government to acknowledge the important contribution this industry is making towards the country's economy. The studies have shown that 3 500 people are dependent on income gained working in Private Game Reserves (PGR's). In terms of multiplier effects the revenue generated by these eco-tourism businesses translates into an infusion of R180 million into the regional economy

Multiplier effects occur in the economy because guests to PGRs purchase further items during their time in the Eastern Cape. These includes buying crafts and souvenirs, staying in hotels, renting cars, buying petrol, purchasing clothes, visiting other attractions, and dining in restaurants. Therefore the tourists' true economic impact in the region is much wider than what is spent at the PGRs.

The INDALO studies sought to determine the general contribution to the economy by the visitors attracted to the region by the private game reserves. The 2004 study estimated that a 70% multiplier effect applied to gross incomes of R87.2 million generated by 12 existing PGRs in 2002/2003 would imply that visitors made direct and indirect expenditures close to R150 million (2004: 16). The 2006 study, using the same equation, found that R105.8 million in revenue generated by PGRs in 2004/2005 translates into a total infusion of R180 million into the regional economy (2006: 12). The spending of overseas guests also generates important foreign exchange earnings for the South Africa treasury.

In addition to economic multiplier effects there are also social multiplier effects, the study by the University of Port Elizabeth remarked:

"Eco-tourism lends itself very well to developing and building partnerships with communities. An array of potential initiatives exists, with regard to previously disadvantaged communities and informal settlements within and around the PGRs. Potential initiatives include promoting development in townships/settlements through arts and crafts; introducing local children to environmental education; conservation outreach programs within the communities themselves and linkages with teachers in local schools."

#### 5. KWANDWE PRIVATE GAME RESERVE

Kwandwe's website introduction is as follows:

"Nestled in the heart of South Africa's unspoilt Eastern Cape province lies Kwandwe Private Game Reserve, a world-class Big Five safari destination. The 22,000 hectares of pristine private wilderness stretches either side of the Great Fish River which meanders for 30

kilometres through scenic landscape and comprises just twenty-six rooms split across five very individual and distinct safari lodges and villas, according it one of the highest land to guest ratios in South Africa. Renowned for quality guiding, understated luxury and the thousands of animals and wildlife that call the Reserve home, Kwandwe offers a range of safari activities and accommodation options to make every African Dream come true".

[www.kwandwe.com](http://www.kwandwe.com)

Kwandwe is committed to making a positive and lasting difference in the rural Eastern Cape, one of South Africa's least developed provinces. Working through its social development partner, the Ubunye Foundation, Kwandwe invests in projects that improve lives and create sustainable livelihoods opportunities in marginalised rural communities.

[www.ubunyefoundation.co.za](http://www.ubunyefoundation.co.za) <https://youtu.be/D-HvZulvFU>

Kwandwe has been trading for 18 years and has an established track record of conservation and community development. These efforts have led to Kwandwe being declared a **Protected Environment**. There is a projected further 6,500 hectares that will be added into the Kwandwe Protected Environment, this will be done on the basis that we are secure in the knowledge that the sense of place and "wildness" of the Great Fish River Valley is not compromised by visual pollution.

It is our proposal that Protected Environments should receive protection from the visual pollution of WEF and **an exclusion zone of at least ten kilometers around all Protected Environments** should be observed. This said, should a proposed WEF still pose a significant visual threat to the business activity, this exclusion zone should be considered on the merits of each application.

Every guest staying at Kwandwe makes a direct contribution to community development through the Conservation and Community Levy (funds raised from this levy are split equally between these two initiatives).

Kwandwe Private Game Reserve firmly believes that WEF's in the two areas proposed above, pose a significant threat to their eco-tourism business. The visual impact of turbines is well-documented, and it is believed that such visual impact will result in reduced numbers of tourists visiting the private game reserve, which will in turn result in a reduction of employment.

The Wildlife Economy Lab run by the National Department of Environmental Affairs and the Department of Tourism plotted out an ambitious and attainable plan, which has been endorsed by all stake holders. There is a green economy that underpins the rural economy, it is clearly evident in the Great Fish River Valley with consumptive use, non-consumptive eco-tourism as well as Provincial Nature Reserves. It is clear that a sustainable and long-

standing wildlife economy has been developed.

## 6. In conclusion

President Cyril Ramaphosa stated that the tourism sector "... is a sector that is thriving and that has tremendous potential for further growth and for the creation of jobs. There is growing global consensus on the need for countries to pursue paths of sustainable development, to grow and transform our respective economies while minimising our impact on nature.

Tourism has an extensive value chain, stimulating economic activity in manufacturing, in the services sector and in the creative and cultural industries. We have set ourselves a bold target to raise over \$100 billion in new investment over five years. Tourism plays a critical role in that strategy." 4 May 2019, South African Tourism Indaba, Durban.

I firmly believe that the proposed WEF's pose a significant threat to our eco-tourism business, and in turn on the valuable socio-economic role of Private Game Reserves and Protected Areas.

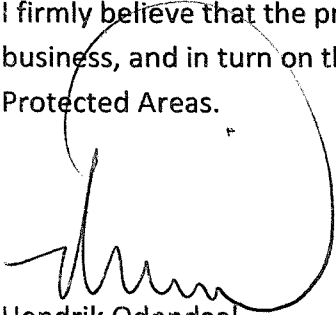

Hendrik Odendaal  
General Manager,  
C-SA Properties (Pty) Ltd.

Kwandwe Private Game Reserve

**Savannah Public Process**

---

**From:** Savannah Public Process  
**Sent:** Thursday, November 26, 2020 3:33 AM  
**To:** Taylor Shaun  
**Cc:** Nicolene Venter; Ronald Baloyi; savannahenvironmentalsa@gmail.com; Nicolene Venter  
**Subject:** RE: DEVELOPMENT OF A CLUSTER OF RENEWABLE ENERGY FACILITIES: Notification of commencement of Basic Assessment and Public Participation Processes  
**Attachments:** SE2602 Wind Relic BID (Eng).pdf; SE2602-WindRelic RegCommForm-FINAL.pdf

**Tracking:**

Recipient	Delivery
Taylor Shaun	
Nicolene Venter	Delivered: 11/26/2020 3:33 AM
Ronald Baloyi	Delivered: 11/26/2020 3:33 AM
savannahenvironmentalsa@gmail.com	
Nicolene Venter	

Dear Shaun,

The applicants are:

Project Name	Hamlett Wind Farm	Ripponn Wind Farm	Redding Wind Farm	Aeolus Wind Farm	Wind Garden Wind Farm	Fronteer Wind Farm	REDZ 3 Power Corridor 400MTS	Solaris Fields Solar Energy Facility	Sun Garden Solar Energy Facility
Applicant	Hamlett (Pty) Ltd	Ripponn (Pty) Ltd	Redding Wind (Pty) Ltd	Aeolus (Pty) Ltd	Wind Garden (Pty) Ltd	Fronteer (Pty) Ltd	Wind Relic (Pty) Ltd	Solaris Fields (Pty) Ltd	Sun Garden (Pty) Ltd

Please find attached the Background Information Document which will provide enel with additional information regarding the proposed developments.

It will be appreciated if you can please complete the attached registration form by indicating in which (or all) of the projects your interest lies.

Kind regards,

---

**From:** Taylor Shaur [REDACTED]  
**Sent:** Saturday, November 21, 2020 1:52 PM  
**To:** Savannah Public Process <publicprocess@savannahsa.com>  
**Cc:** Nicolene Venter <nicolene@savannahsa.com>; Ronald Baloyi <Ronald@savannahsa.com>; savannahenvironmentalsa@gmail.com; Nicolene Venter <nicolene@savannahsa.com>  
**Subject:** RE: DEVELOPMENT OF A CLUSTER OF RENEWABLE ENERGY FACILITIES: Notification of commencement of Basic Assessment and Public Participation Processes

Thank you Nicolene

Could you please provide details about who the applicant is?

Regards



Shaun Taylor  
Pr. Nat. Sci (Reg No: 118409)  
Environment, Archaeology & Biodiversity  
South Africa



102 Rivonia Road, Sandton  
2196, Johannesburg

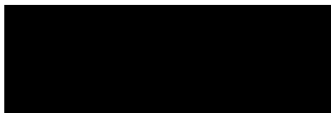

---

**From:** Public Process [<mailto:publicprocess@savannahsa.com>]  
**Sent:** Wednesday, 18 November 2020 01:50  
**To:** Taylor Shaun [REDACTED] Taylor Shaun [REDACTED]  
**Cc:** [nicolene@savannahsa.com](mailto:nicolene@savannahsa.com); [ronald@savannahsa.com](mailto:ronald@savannahsa.com); [savannahenvironmentalsa@gmail.com](mailto:savannahenvironmentalsa@gmail.com); Nicolene Venter <[nicolene@savannahsa.com](mailto:nicolene@savannahsa.com)>  
**Subject:** DEVELOPMENT OF A CLUSTER OF RENEWABLE ENERGY FACILITIES: Notification of commencement of Basic Assessment and Public Participation Processes

**DEVELOPMENT OF A CLUSTER OF RENEWABLE ENERGY FACILITIES BETWEEN SOMERSET EAST AND MAKHANDA,  
EASTERN CAPE PROVINCE**

Dear Shaun,

A cluster of renewable energy facilities is proposed to be developed on various project sites located between Somerset East and Makhanda within the Cookhouse Renewable Energy Development Zone (REDZ), as well as the Eastern Strategic Transmission Corridor. The cluster consists of nine (9) projects which includes six (6) wind farms, two (2) solar energy facilities and one (1) Main Transmission Substation (MTS). A suitable project site for each development has been identified by the project development companies and the entire extent of the projects is located within the Sarah Baartman District Municipality. The western section is located within the Blue Crane Route Local Municipality and the eastern section within the Makana Local Municipality.

As per your telephone request to our colleague, Gideon Raath, yesterday afternoon to be registered on the above-mentioned projects, please find attached the Background Information Document which provides additional information regarding the application for the six (6) wind energy facilities, the two (2) solar energy facilities and the 400MW Main Transmission Substation.

We kindly request you to complete the attached stakeholder registration and comment form to formally register on the project databases and indicate in which of the nine (9) projects (or all) your interest lies.

Please do not hesitate to contact us should you require additional information and/or clarification regarding the projects. Our team welcomes your participation and look forward to your involvement throughout this process.

Kind regards,



t: 011 656 3237  
f: 086 684 0547

**Nicolene Venter**  
Public Process

e: [publicprocess@savannahsa.com](mailto:publicprocess@savannahsa.com)  
c: +27 (0) 60 978 8396

SAWEA Award for Leading Environmental Consultant on Wind Projects in 2013 & 2015

## Savannah Public Process

---

**From:** Savannah Public Process  
**Sent:** Tuesday, December 1, 2020 4:10 AM  
**To:** Sam Ralston  
**Cc:** Nicolene Venter; Ronald Baloyi  
**Subject:** DEVELOPMENT OF A CLUSTER OF RENEWABLE ENERGY FACILITIES: Confirmation of Registration  
**Attachments:** SE2602 Wind Relic, Solar & Grid Notification I&APs-FINAL.pdf; SE2602 Wind Relic BID (Eng).pdf; SE2602-WindRelic RegCommForm-FINAL.pdf

<b>Tracking:</b>	<b>Recipient</b>	<b>Delivery</b>
	Sam Ralston	
	Nicolene Venter	Delivered: 12/1/2020 4:10 AM
	Ronald Baloyi	Delivered: 12/1/2020 4:10 AM

Dear Samantha,

All well here in Gauteng!

Yes, I can confirm that BirdLife SA is an I&AP on the cluster of project's database.

However, I notice that our BID and notification of commencement of the Basic Assessment processes was not sent as part of the 'campaign' sent on the 17<sup>th</sup> of November 2020.

Attached for BirdLife's attention and information is the BID, including the registration and comment form although we always register BirdLife as a key stakeholder on renewable energy projects.

Samantha, thank you for checking on BirdLife's inclusion on the projects' databases.

The enquiry regarding the Cape Vulture Guidelines Guidelines is forwarded to the EAP for confirmation.

Kind regards,

---

**From:** Sam Ralston [REDACTED]  
**Sent:** Monday, November 30, 2020 2:20 PM  
**To:** Savannah Public Process <publicprocess@savannahsa.com>  
**Subject:** Re: DEVELOPMENT OF A CLUSTER OF RENEWABLE ENERGY FACILITIES: Notification of commencement of Basic Assessment and Public Participation Processes

Dear Nicole

I hope you are well? I presume that BirdLife South Africa is a I&AP for these projects and that our Cape Vulture Guidelines are being applied, but just double-checking?

Thanks  
Sam

Samantha Ralston-Paton  
Birds and Renewable Energy Project Manager

<http://www.birdlife.org.za>



BirdLife South Africa's Birds and Renewable Energy Project is sponsored by Investec Corporate and Institutional Banking

Sponsored by



**LIMITATION OF LIABILITY**

Any information present or attached must be regarded as the communication of information and does not under any circumstance constitute formal advice unless otherwise stated to the contrary. This information has been prepared solely for the use of the addressee. It is not intended for use by any other party and may not be relied upon by any other party. No acceptance of any liability for any unauthorised use of this information or any associated attachment will be given. Further, this information is based on the facts provided by the addressee and on the law as promulgated at the date of this document. No responsibility will be taken for advising on any changes to the information which may arise as a result of subsequent changes to law or practice.

---

**From:** Public Process [<mailto:publicprocess@savannahsa.com>]

**Sent:** 17 November 2020 05:05 PM

**To:** Andre Van der Spuy

**Subject:** DEVELOPMENT OF A CLUSTER OF RENEWABLE ENERGY FACILITIES: Notification of commencement of Basic Assessment and Public Participation Processes

**DEVELOPMENT OF A CLUSTER OF RENEWABLE ENERGY FACILITIES  
BETWEEN SOMERSET EAST AND MAKHANDA, EASTERN CAPE PROVINCE**

Dear Interested and Affected Parties,

A cluster of renewable energy facilities is proposed to be developed on various project sites located between Somerset East and Makhanda within the Cookhouse Renewable Energy Development Zone (REDZ), as well as the Eastern Strategic Transmission Corridor. The cluster consists of nine (9) projects which includes six (6) wind farms, two (2) solar energy facilities and one (1) Main Transmission Substation (MTS). A suitable project site for each development has been identified by the project development companies and the entire extent of the projects is located within the SarahBaartman District Municipality. The western section is located within the Blue Crane Route Local Municipality and the eastern section within the Makana Local Municipality.

Please find attached the Background Information Document which provides additional information regarding the application for the six (6) wind energy facilities, the two (2) solar energy facilities and the 400MW Main Transmission Substation.

We kindly request you to complete the attached stakeholder registration and comment form to formally register on the project databases and indicate in which of the nine (9) projects (or all) your interest lies.

Please do not hesitate to contact us should you require additional information and/or clarification regarding the projects. Our team welcomes your participation and look forward to your involvement throughout this process.

Kind regards,

[Unsubscribe this type of email](#)

<image001.jpg>

t: 011 656 3237  
f: 086 684 0547

**Nicolene Venter**

Public Process

<0.gif>

e: [publicprocess@savannahsa.com](mailto:publicprocess@savannahsa.com)  
c: +27 (0) 60 978 8396

---

SAWEA Award for Leading Environmental Consultant on Wind Projects in 2013 & 2015



Virus-free. [www.avast.com](http://www.avast.com)

<SE2602\_Wind\_Relict\_BID\_(Afr).Final.pdf><SE2602-WindRelict\_RegCommForm-FINAL.pdf><SE2602\_Wind\_Relict\_BID\_(Eng)\_Final.pdf><SE2602\_Wind\_Relict,\_Solar\_&\_Grid\_Notification\_I&APs-FINAL.pdf>

# Cape Vulture and Wind Farms

---

Guidelines for impact assessment,  
monitoring and mitigation

August 2018



# Contents

Summary and key recommendations	3
1. Introduction	6
2. Potential impacts of wind energy on Cape Vulture	7
2.1 Fatalities associated with wind turbines and associated infrastructure	7
2.2 Disturbance, habitat loss and displacement	7
3. Recommendations for site screening, impact assessment and mitigation.	8
3.1 Site screening	8
3.2 Impact assessment	12
3.3 Monitoring and adaptive management	19
4. Conservation and research priorities	20
5. Conclusion	20
References	21
Acknowledgements	24
Useful contacts	24

# Summary and key recommendations

The Cape Vulture is Endangered and endemic to southern Africa. Although to date there have been relatively few Cape Vulture fatalities reported at wind farms in South Africa when compared to other sources of vulture fatality, wind energy has been identified as a potential new threat. Globally, numerous vulture fatalities have been recorded from collisions with wind turbine blades and associated infrastructure. These guidelines therefore provide recommendations for site selection, monitoring, impact assessment and mitigation, to help ensure that expansion of wind energy in Africa does not present a new and serious threat to the species.

BirdLife South Africa recommends that if a wind farm is proposed within the range of Cape Vulture, a stepwise approach to site selection and mitigation should be adopted. The risks and feasibility of the wind farm should be regularly reviewed before deciding to proceed with the next step in the assessment (Figure 1).

## Site Screening (location of wind farms)

The large foraging range of the Cape Vulture (thousands of square kilometres) and the potentially significant impact poorly planned wind farms could have on the species implies that large parts of the Cape Vulture's distribution may be unsuitable for the development of wind turbines. The importance of site screening cannot be overemphasised – negative impacts can be minimised by placing turbines well away from areas regularly used by Cape Vulture.

Site screening can begin with a desktop analysis using existing information but should be complemented by field work.

Site screening should take the following into account:

### a) *The location of the proposed wind farm in relation to the distribution of the Cape Vulture*

See Figure 2, and refer to the Southern African Bird Atlas Project 1 and 2. Areas with high SABAP2 reporting rates for Cape Vulture should be assumed to be of high sensitivity.

### b) *The proximity of the site to Cape Vulture colonies and roosts*

Cape Vultures can be expected to regularly use the air-space within 50 km around their roosts and breeding colonies. Vultures will occur well beyond these zones, but there is a lower probability of them occurring beyond these buffers. The location and status of known breeding colonies and roost sites should be confirmed, and the area surrounding the proposed wind farm should be thoroughly surveyed for previously unrecorded breeding and roost sites. A buffer of approximately 50 km around all colonies, and regular or seasonal/occasional roosts should be considered as high to very high sensitivity (with sensitivity influenced by distance from the roost/colony, as well as its size and location). A buffer of approximately 18 km around breeding colonies should be considered as very high sensitivity.

### c) *Topography and wind-scape*

Increased flight activity and risky behaviour are likely along ridge tops, cliffs, steep slopes and wind corridors. These areas are likely to be of high sensitivity.

### d) *The availability of food in the landscape (including existing supplementary feeding sites)*

Livestock management practices and the availability of carrion around the proposed wind farm should be considered, especially the location of existing vulture restaurants (supplementary feeding sites). Increased flight activity can be expected in the area around active supplementary feeding sites, and between vulture restaurants and roosts or colonies.

### e) *Risk maps (once available)*

Spatial risk assessment models can be developed to predict the presence and flight height of birds. Once available for the Cape Vulture, these maps will provide an additional indication of potential collision-risk.

### f) *The potential for cumulative negative impacts.*

The number of operational and potential wind farms within a radius of at least 100 km of the proposed wind farm should be considered, including the results of pre-construction and operational phase monitoring (where available).

Following consideration of all the above factors, the potential risks and limitations to development should be described and a preliminary indication of sensitivity (from low to very high) should be assigned. At this stage the risk assessment would largely be based on the probability of birds using the area and the risk of cumulative negative effects.

## Data collection and analysis for impact assessment

Site screening relies primarily on existing data and the factors listed above must therefore be interrogated in more detail during the impact assessment process (see Figure 1). If a wind farm is proposed within the distribution of the Cape Vulture, the location and status of all known as well as potential breeding colonies, roost sites and supplementary feeding areas within at least 50 km of the site should be checked. This should first be done during site screening and repeated during the assessment process.

The duration and scope of fieldwork recommended for impact assessment must be guided by site screening (i.e. the preliminary assessment of risk to Cape Vulture) and as more data become available, the recommended approach to data collection and impact assessment should be revisited, and if necessary revised.

Avoidance of high sensitivity and particularly very high sensitivity areas is encouraged, but developers may decide to proceed with data collection to verify the risk. If a wind farm is proposed within high or very high sensitivity areas (i.e. if vultures are likely to occur regularly and/or there is a risk of cumulative negative impacts) data collection must extend beyond the minimum protocols recommend in the BirdLife South Africa/EWT Best Practice Guidelines (Jenkins et al. 2015):

- The duration of monitoring should be at least two years to allow for annual variation and increase statistical rigor.
- Surveys should include the pre-breeding season (late March to early May), and the breeding season (May to December).



- c) A minimum of 72 hours per vantage point per year should be surveyed, and site visits should be timed to account for as much seasonal variation as possible (i.e. a minimum of 6 site visits each year).
- d) All occupied and potential breeding colonies and roost sites within 50 km of the proposed wind farm must be monitored according to standard survey protocols.
- e) The use of technology to study the movements of vultures (e.g. radar, tracking devices, and/or wind current modelling) is strongly encouraged.
- f) The number of bird fatalities that might take place once the wind farm is operational should be estimated using a collision risk model (provided there is sufficient data from the site to support this). However, factors such as topography, bird behaviour, season, aggregation, wind direction and wind speed may also affect collision risk and should also be considered in the final assessment of risk.
- g) The risk of cumulative effects should be assessed.

If a site is found to be low or moderate sensitivity after screening, one year of data collection in accordance with the BirdLife South Africa/EWT Best Practice Guidelines (Jenkins et al. 2015), combined with surveys for potential colonies and roosts in surrounding area, may be sufficient. However the scope of data collection should be regularly reviewed and it may be necessary to increase the survey effort if new information suggests the initial sensitivity rating should be increased. Conversely, if data collection suggests that the initial assessment of sensitivity was too high (e.g. all known roosts/colonies are confirmed to be inactive, no new ones are found, and very low/no vulture passage rates are recorded), the duration of data collection could be reduced.

### Mitigation

Mitigation measures must be designed to achieve no net loss of biodiversity. Limited options are available for mitigation once a wind farm is operational. It is therefore critical that the mitigation hierarchy (i.e. first seek to avoid and then minimise risk) is adhered to during planning.

- a) Wind farms and wind turbines should not be placed in areas with a high abundance of Cape Vulture, high passage rates, and where topographic features associated with risky flight are found.
- b) Free spinning of turbines under low wind conditions, when turbines are not generating power should be avoided.
- c) The design, location and alignment of new powerlines associated with the wind farm must be optimised to reduce vulture fatalities (collisions and electrocutions). No new powerlines should be permitted within 5 km of a colony. Where deemed necessary (i.e. following assessment by an avifaunal specialist), bird flight diverters should be installed and maintained to minimise collision risk. All new pylon structures must meet Eskom's 'bird-friendly' standards to minimise the risk of electrocution.
- d) Construction of associated infrastructure within 5 km of breeding colonies and roosts, particularly during the breeding season, should be avoided.
- e) Curtailment or shut-down-on-demand may help reduce the risk of collisions, but the feasibility and effectiveness of this approach for the Cape Vulture needs to be monitored and assessed. Shut-down-on-demand does not replace the



CHRIS VAN ROOYEN

*Physical features such as their large wingspan, weight and narrow field of binocular vision compromise vultures' ability to perceive and response to obstacles in their flight path.*

need to first avoid and minimise impacts through the considered location a wind farm and its turbines but could be implemented to minimise the risk of residual negative impacts, or as part of an adaptive management strategy.

- f) The number of livestock and other animal carcasses must be minimised at the wind farm and within nearby areas (e.g. within 2 km). A carcass management plan should be implemented, and birthing of livestock near turbines should not be permitted (alternatively turbines should be curtailed during calving and lambing season).
- g) If the strategic location or removal of supplementary feeding sites is proposed as a mitigation in order to reduce the risk of collisions to acceptable levels a) the mitigation hierarchy must have been exhausted and b) the effectiveness of this approach must be verified during the preliminary avifaunal assessment and impact assessment process. Any new supplementary feeding site must be located and managed so as not to increase risk to the birds.
- h) The effectiveness and desirability of reducing collision risk by stopping the supply of food at existing supplementary feeding sites must be verified during the preliminary avifaunal assessment or impact assessment process.

The Environmental Management Programme for any wind farm where there is a potential risk of vulture fatalities should include clear impact management objectives, outcomes and actions that may be necessary to address this risk.

### Monitoring (construction and operational phase) and adaptive management

The duration and extent of operational phase monitoring should be increased for wind farms if there is a risk of multiple Cape Vulture fatalities (i.e. the site is located in a high or very high sensitivity area):

- a) Vantage point monitoring should continue through construction. Monitoring Cape Vulture presence and movements may be recommended throughout operation as part of an adaptive management strategy.
- b) Breeding colonies and roost sites should continue to be monitored (where possible in collaboration with NGOs, state conservation agencies, and other wind farm operators in the area).

- c) Carcass surveys must begin as soon as the first few turbines are turning (i.e. 10% of the turbines have been erected and are rotating) and should continue through the lifespan of the project.
- d) If new powerlines are built, operational phase monitoring should extend to include the powerline – bird flight diverters should be checked (and if necessary, replaced) and the area beneath the line should be surveyed for fatalities.

Cape Vulture fatalities should be photographed, the GPS coordinates and estimated wind speed recorded, and immediately reported to BirdLife South Africa, EWT, VulPro, the Department of Environmental Affairs (DEA) and relevant conservation authorities, and a mitigation strategy should be proposed. Injured birds must be transported to the nearest

certified wildlife rehabilitation centre for treatment. Wind farms are encouraged to go beyond demonstrating no net loss and should aim to achieve a net positive gain for the species. Once the mitigation hierarchy has been exhausted, residual impacts could be compensated through off-site conservation action.

**Conclusion**

These guidelines draw on our current understanding of the Cape Vulture, supplemented by research on vultures and wind farms in Europe. These recommendations will be periodically reviewed and updated. With the implementation of the guiding principles outlined in this document we believe it is possible to develop wind energy in South Africa without negatively affecting the conservation status of Cape Vulture.

Figure 1. Decision tree outlining the recommended approach to site screening, data collection and impact assessment.

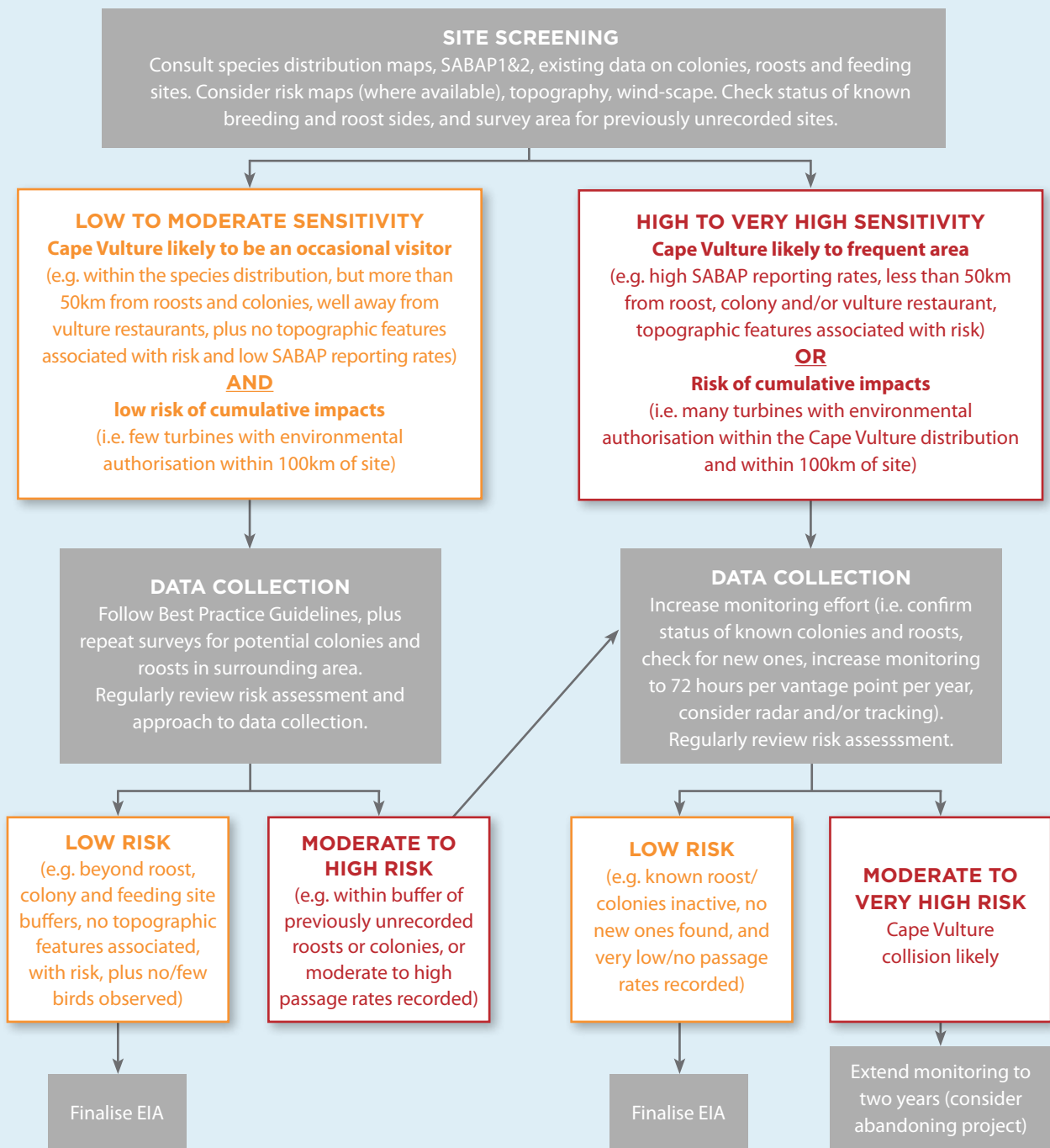

# Cape Vulture and Wind Farms: Guidelines for impact assessment, monitoring, and mitigation

## 1. INTRODUCTION

The demand to produce energy from renewable resources has increased alongside global energy consumption (Saidur et al. 2011). This form of energy production can help reduce carbon emissions – a long-term goal for many countries and an effective way to mitigate the effects of global climate change on biodiversity (Leung and Yang 2012). However, some renewable energy installations can have detrimental environmental impacts (Drewitt and Langston 2006, Gove et al. 2013, Loss et al. 2013, Rydell et al. 2016). Of particular concern is that threatened raptors may experience negative impacts if they collide with wind turbines and associated infrastructure (de Lucas et al. 2012a, Pagel et al. 2013).

The Cape Vulture *Gyps coprotheres* is considered a high priority species for impact assessment and mitigation at wind farms in South Africa. This is because of the predicted risk of collisions (due to their size, behaviour and habitat use), conservation status, and overlap with proposed and operational wind farms (Retief et al. 2013, Ralston-Paton et al. 2017).

The Cape Vulture is endemic to southern Africa (Mundy et al. 1992) and has the smallest distribution of any Old-World vulture species (i.e. vultures that inhabit Europe, Asia, and Africa) (Mundy et al. 1992, Piper 2005). In 2015, the Red List status of the Cape Vulture was up-listed to Endangered because the population had decreased by 50% over three generations (Allan 2015, Ogada et al. 2015b). The species currently faces numerous threats including collisions and electrocution with electrical infrastructure, inadvertent poisoning and poaching (Allan 2015, Botha et al. 2017).

There is growing interest in developing wind energy in the Eastern Cape Province, an important area for the Cape Vulture. A number of wind farms are planned, and some are already operational in areas where interactions with Cape Vulture are possible. Cape Vulture occur regularly in at least three Renewable Energy Development Zones (areas where the large-scale development of wind energy will be promoted) (Avisense 2015), as identified in the first phase of the Strategic Environmental Assessment for wind and solar photovoltaic energy in South Africa (SEA) (CSIR 2015).

To avoid adding further pressure to the species, which could contribute to irreversible population declines and local extinctions (Rushworth and Kruger 2014), guidelines are needed to help wind energy develop with the least negative effects on the species. This document provides an overview of our current understanding of the likely impact of wind turbines on the Cape Vulture and offers guidance on how the impacts should be assessed, avoided, mitigated and monitored.

These guidelines focus on a project-based approach, but the importance of thorough strategic environmental assessment cannot be overemphasised. *“The most effective way to detect and avoid severe environmental impacts of wind energy developments is to perform Strategic Environmental Assessments (SEAs) at large spatial scales. SEAs enable strategic planning and siting of wind energy developments in areas with least environmental and social impact whilst maintaining economic*



CHRIS VAN ROOYEN

*Areas associated with increased flight activity and/or risky behaviour (for example ridge tops, cliffs and steep slopes) should be considered as high sensitivity.*

*benefits”* (Botha et al. 2017). However, it must be noted that BirdLife South Africa does not endorse the outcome of the first phase of the SEA due to the failure of this process to address the cumulative risk to Cape Vulture and other species.

While the effects of wind farms on Cape Vultures have not been well studied, understanding the effect wind turbines have had on European and Asian vultures can provide valuable insights for their African counterparts. Wind farms have been operational in Spain for decades and several articles have been published on factors that might influence the risk of collision for Eurasian Griffon Vulture *Gyps fulvus* (e.g. Barrios and Rodríguez 2004, Carrete et al. 2012, de Lucas et al. 2012a). This species is similar to the Cape Vulture in regard to its flight patterns, behaviour, vision morphology, and colonial cliff breeding strategies (Mundy et al. 1992, Carrete et al. 2012, Martin et al. 2012). These guidelines draw on lessons from these examples, but it is important to note that there are differences in vulture population size, land use, food supply, and human population densities that must be taken into account. As our knowledge grows, the recommendations contained in these guidelines may be amended to reflect our improved understanding of how vultures can flourish alongside increased generation of renewable energy.

These guidelines expand on the recommendations in the BirdLife South Africa/Endangered Wildlife Trust Best Practice Guidelines for Birds and Wind Energy (Best Practice Guidelines) (Jenkins et al. 2015). These documents should therefore be read together.

## 2. POTENTIAL IMPACTS OF WIND ENERGY ON CAPE VULTURE

### 2.1 FATALITIES ASSOCIATED WITH WIND TURBINES AND ASSOCIATED INFRASTRUCTURE

The Cape Vulture is a large bird, weighing on average 9 kg with a wingspan of 2.55 m (Mundy et al. 1992). As a result, they have a high wing load and cannot respond rapidly to obstacles in the air. Gyps vultures (a genus of Old World vulture, which includes Cape Vulture) also have a small frontal binocular field that creates large blind spot areas in the direction of travel (Martin et al. 2012). Tracking data from two adult Cape Vultures captured in the Maluti-Drakensberg area indicate that 61.7% of the recorded flights were less than 100 m above ground level (i.e. potentially within the rotor swept area) (Rushworth and Kruger 2014). Their size, the slope-soaring behaviour, limited visual field, and large foraging range could make Cape Vulture particularly susceptible to collisions with man-made structures such as wind turbines and powerlines (Bamford et al. 2007, Martin 2011, Martin et al. 2012, Rushworth and Krüger 2014).

At the time of writing, few (five) wind farms were operational in areas Cape Vulture had previously been recorded. Cape Vulture fatalities as a result of turbine strikes have occurred at some of these wind farms, and preliminary monitoring data suggests an average fatality rate of approximately 0.03 vultures per turbine per year (Smallie, unpublished data).

Globally numerous vulture fatalities have been recorded from collisions with wind turbine blades and associated infrastructure (e.g. powerlines) (Smallwood and Thelander 2008, Tellería 2009, García-Ripollés and López-López 2011, Camiña 2011, de Lucas et al. 2012a) and it is expected that the Cape Vulture will face a similar risk of collisions (Retief et al. 2013, Rushworth and Krüger 2014). Old World Vultures that have died from collisions with wind turbines include Egyptian Vulture *Neophron percnopterus* and Eurasian Griffon Vulture *Gyps fulvus* (Carrete et al. 2009, Carrete et al. 2012, Ferrer et al. 2012, Martínez-Abraín et al. 2012). There is no evidence that Old World vultures learn to avoid turbine collisions (Johnston et al. 2014, Cabrera-Cruz and Villegas-Patracá 2016), which suggests that they are not only susceptible to collisions when turbines are first installed, but continuously throughout the lifetime of the wind farm (Carrete et al. 2012).

Cape Vulture is a relatively long-lived species, with low reproductive rates. At most a pair will raise one chick a year, and sexual maturity is only reached at 5 years of age (Mundy et al. 1992). The species already faces numerous threats and additional losses as a result of poorly planned wind farms are likely to accelerate population declines. Rushworth and Krüger (2014) calculated that just 80 wind turbines proposed in Lesotho could kill approximately 20-25 Cape Vulture a year. This increased the rate of decline of the local Maluti-Drakensberg Cape Vulture population from -2 % to -3 % per year and brought the predicted time to extinction forward by 80 years (from 220 to 140 years) (Rushworth and Krüger 2014).

The removal of vultures from an area could have negative consequences for the conservation status of the species and could also have implications for the local ecology and human health. The Cape Vulture is an obligate scavenger; it contributes to



SAMANTHA RALSTON-PATON

*These guidelines draw on the best available information to help ensure the expansion of wind energy in southern Africa does not present a new threat to Cape Vulture.*

nutrient recycling, prevents possible mammalian disease transmissions, and provides a carbon-neutral waste removal service (Dupont et al. 2012, Ganz et al. 2012, Ogada et al. 2012).

### 2.2 DISTURBANCE, HABITAT LOSS AND DISPLACEMENT

Cape Vulture have been recorded at a few operational wind farms in South Africa (albeit in low numbers) and at this stage there is no evidence of displacement (effective habitat loss) (Ralston-Paton et al. 2017). The large home ranges of the Cape Vulture is likely to buffer any effects of habitat loss associated with the development of wind farms. However, construction activities near a colony may affect breeding success and could lead to a colony being abandoned.

Construction (buildings and fences) and large-scale timber harvesting during the breeding season at the base of a Cape Vulture breeding colony in Botswana was thought to have contributed to low fledgling rates (Borello and Borello 2002). The Nooitgedacht colony (in the Magaliesberg) was abandoned in the 1960's after construction of microwave transmission towers near to the breeding cliffs (Tarboton & Allan 1984, Verdoorn 2004). While small numbers of Cape Vulture continued to use the site as a roost (Verdoorn 1997), no breeding was recorded again until 1991 (Verdoorn 2004). There are now approximately 140 breeding pairs at the site (Wolter and Hirschauer 2016), despite an access road located directly below the breeding cliffs that is still in use (C. Whittington-Jones pers. comm.).

The type and repetitiveness of the disturbance may influence how vultures respond to disturbance. For example, Cape Vulture at Potberg showed increasing agitation as the number of high velocity aircraft flights 5 km from the colony increased (K. Shaw pers. comm.). The quality of the site, availability of other suitable areas, and investment an individual has made in the site are all likely to affect how a species responds (Gill et al. 2001).

### 3. RECOMMENDATIONS FOR SITE SCREENING, IMPACT ASSESSMENT & MITIGATION

A stepwise approach to risk assessment is recommended (Figure 1). This should start with desktop screening where the broad-scale risks associated with developing a wind farm in the broader area are considered and landscape features likely to be associated with high risk are earmarked as sensitive, and preferably eliminated from further consideration for wind turbine development. This should be followed with preliminary data collection, and then detailed site surveys by an avifaunal specialist, where initial predications are tested, and the layout of turbines is finalised. The risks and feasibility of the proposed project should be regularly reviewed through the process.

#### 3.1 SITE SCREENING

The most widely accepted and cost-effective method to prevent wind turbine related fatalities is to place wind turbines in areas where risks to birds is the lowest (de Lucas et al. 2012b, Gove et al. 2013, Marques et al. 2014). For the Cape Vulture this implies that large areas within the species' range may be unsuitable for the development of wind energy. In particular, placing turbines in areas associated with increased flight activity and/or risky behaviour of vultures should be avoided (de Lucas et al. 2012b, Rushworth and Krüger 2014).

If wind farm development is considered within the range of Cape Vulture (as per Figure 2 and the Southern African Bird Atlas Project 2) we recommend that before deciding to proceed with detailed data collection a coarse-scale assessment of the risk to Cape Vulture should be conducted (i.e. site screening). This will give an early indication of potential limitations to development and help reduce risks due to imperfect sampling and stochastic events. Site screening should also be used to determine the appropriate scope of subsequent avifaunal surveys.

Early consultation with the stakeholders (e.g. BirdLife South Africa, VulPro, the Endangered Wildlife Trust, ornithologists and conservation authorities) is encouraged, and this should help ensure that the most up-to-date information is considered during this critical step. It is anticipated that a National Vulture Working Group, under the auspices of the Department of Environmental Affairs, will soon be established and would help facilitate the dissemination of relevant information.

If the development of a wind farm is proposed within the range of Cape Vulture, the following should be considered during site screening:

- a) The location of the proposed wind farm in relation to the distribution of the Cape Vulture;
- b) The proximity to known colonies and roosts (and characteristics of these sites);
- c) How the topography and wind-scape might affect collision risk;
- d) The availability of food in the landscape (including existing supplementary feeding sites);
- e) Risk maps (where available);
- f) The potential for cumulative negative impacts.

#### Species distribution

The distribution of the Cape Vulture is limited to southern Africa. The species predominantly occurs in South Africa and Lesotho where the regional population is separated into three

nodes, based on their geographical location (Figure 2). The south-eastern and south-western nodes are most likely to be affected by wind energy given the current spatial distribution of proposed wind farms and Renewable Energy Development Zones. The southwest-node comprises one remnant, isolated breeding colony at Potberg in the Western Cape, while the much larger south-eastern node spans Lesotho and the South African provinces of KwaZulu-Natal and the Eastern Cape. The south-eastern node supports approximately 40 % of the global population (Allan 2015).

Southern African Bird Atlas Project 1 and 2 (SABAP) data should be consulted. **Areas with high SABAP2 reporting rates for Cape Vulture should be assumed to be of high sensitivity**, although the number of atlas lists submitted for a pentad should always be taken into account. However, the converse may not be true – several parts of the species range have limited atlas data, especially in the Eastern Cape, KwaZulu-Natal and Limpopo (Wolter et al. 2017) and the number of checklists for an area must always be considered.

#### Proximity to vulture colonies and roosts

Cape Vultures travel large distances. The average foraging ranges of adult Cape Vultures captured at the Msikaba Cape Vulture Colony, Eastern Cape, covered an area of 16 887 km<sup>2</sup> ( $\pm$  366 km<sup>2</sup>) (Pfeiffer et al. 2015). Adult Cape Vultures captured in the North West Province and Namibia covered much larger areas (121 655  $\pm$  90 845 km<sup>2</sup> and 21 320 km<sup>2</sup> respectively) (Bamford et al. 2007, Phipps et al. 2013b).

Vultures may be at risk of collisions throughout their entire foraging range. However, the Cape Vulture is a communal cliff-nesting raptor and can form large breeding colonies on suitable rock formations (Benson 2015). Vultures also gather in the afternoon to spend the night sleeping at roosts (these can be on a cliff, on pylons, or in trees) (Mundy et al. 1992, Dermody et al. 2011, Pfeiffer et al. 2015). As adult breeding Cape Vulture tend to be central place foragers (i.e. they usually forage within a certain area around a central colony) (Boshoff & Minnie 2011), the risk of collisions is likely to be greatest closest to these sites.

It is therefore useful to consider the core foraging range as the area of greatest risk (e.g. Tellería 2009, Vasilaki et al. 2016). Core ranges can be calculated using fixed kernel density estimates (KDE), a measure of the density of records. For Cape Vulture, 50% KDE has been taken to represent the core utilisation area (this is the area an individual is likely to occur 50% of the time). For example Phipps et al. (2013a) used 50% KDE to delineate the core foraging range of vultures that were fitted with GPS-GSM tracking units and reported that 56% of all known Cape Vulture mortalities caused by power line interactions overlapped with the combined core foraging range of the nine Cape vultures in the study.

Building on previous studies of core foraging areas for Cape Vulture which were limited by small sample size (e.g. Boshoff and Minnie 2011, Rushworth and Kruger 2014, Pfeiffer et al. 2015), Venter et al. (2018) analysed data from 18 adult vultures fitted with GPS/GSM transmitters. These birds occurred in both the northern and southern distribution nodes. The

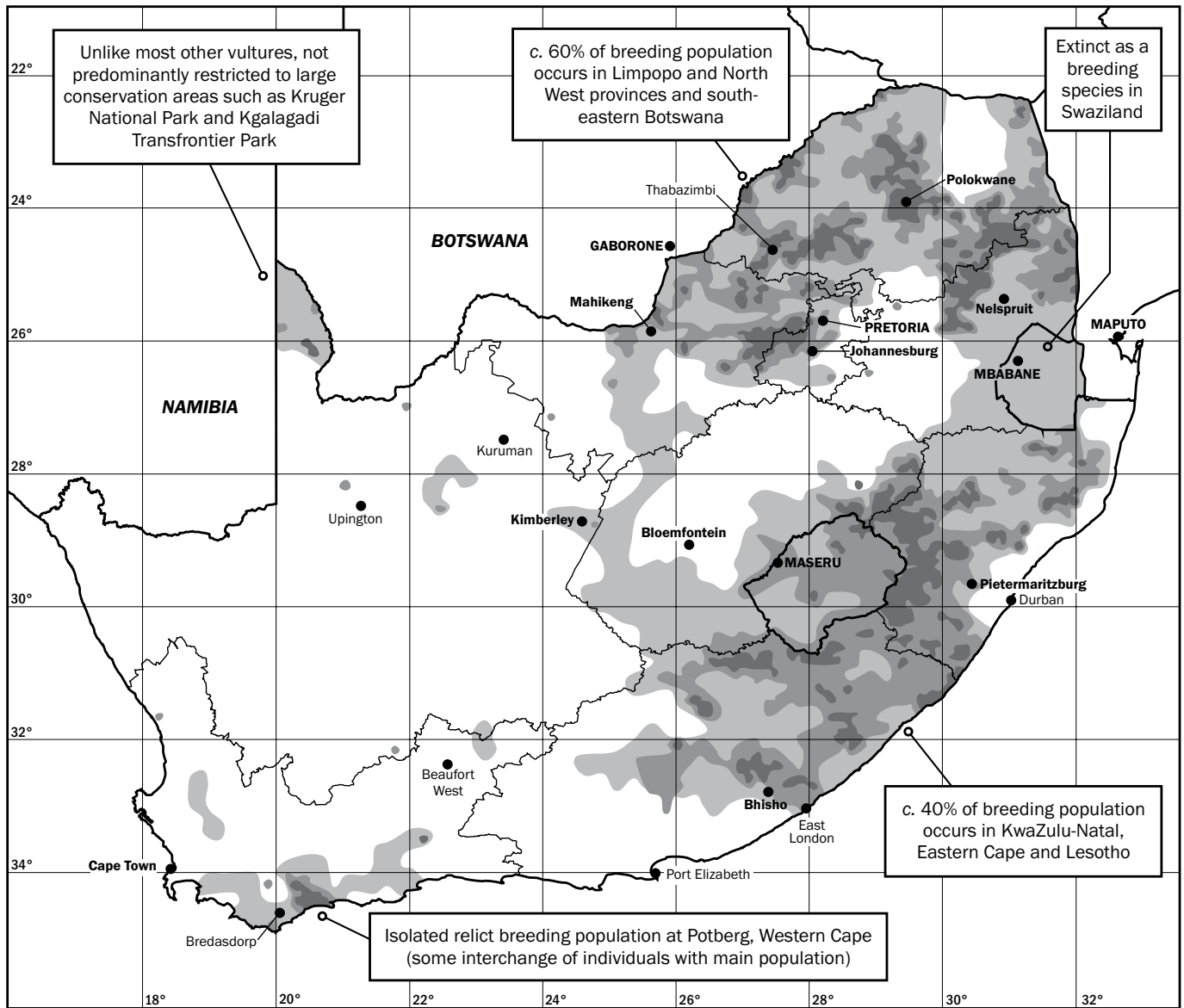

## CAPE VULTURE *Gyps coprotheres*

- High density distribution, based on SABAP2 data (2007-2014); reporting rate >14%.
- Low density distribution, based on SABAP2 data (2007-2014); reporting rate <14%.
- Smoothed distribution based on SABAP1 data (mainly 1987-1993).

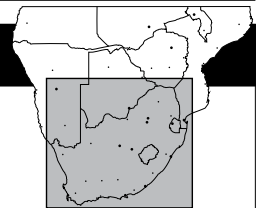

mean radius for the 50% KDE was 49 km (breeding season) and 48 km (non-breeding season).

It is therefore recommended that a buffer of approximately 50km around all colonies, and regular or seasonal/occasional roosts is considered to be of high to very high sensitivity (with sensitivity influenced by distance from the roost/colony and of characteristics of the site).

At the time of writing, multiple Cape Vulture fatalities as a result of turbine strikes had occurred as far as 30 km from a seasonal roost. Three of the four of vulture carcasses that could be aged were sub-adult birds (Smallie, unpublished data).

The recommended buffer around colonies helps protect breeding vultures, as well as young, inexperienced birds. Juvenile Eurasian Griffon Vulture (i.e. less than 2 months from fledging) seem to have a harder time adjusting their flight performance during challenging conditions (such as high winds) and climb slower than adults (Harel et al. 2016). This

**Figure 2.** The distribution of Cape Vulture in South Africa, Lesotho and Swaziland (from Allan, 2015). This map is based on data from the Southern African Bird Atlas Project 1 and 2.

could contribute to an increased probability of collision with wind turbines (Barrios and Rodríguez 2004, de Lucas et al. 2012a). Juvenile birds accounted for the majority of Eurasian Griffon Vulture fatalities (51 % and 74 %) from wind turbine collisions in southern Spain (Barrios and Rodríguez 2004, de Lucas et al. 2012a). Although an opposite trend has been reported for northern Spain, where 75% of the vulture fatalities at wind turbines were adults (Camiña, 2011).

Martens et al. (2018) analysed the movement of juvenile Cape Vultures fitted with GPS/GSM devices in the Eastern Cape. The data indicated that juveniles tend to stay close to the colony for the first 100 days post-fledging; the core area (50% KDE) had an average radius of 18 km. Martens (2017)

also found that the density of roosts for juvenile vultures was highest within 20 kilometres from the breeding colony. A buffer of approximately 18 km around breeding colonies should therefore be considered as very high sensitivity.

A key step in site screening is therefore to **determine the proximity of a proposed wind farm to known breeding colonies or roost sites**. A literature review should be conducted and the appropriate experts (e.g. BirdLife South Africa, EWT, VulPro and other ornithologists) should be consulted. EWT and VulPro both maintain a database of colonies and roosts – to obtain a shape-file contact Gareth Tate (EWT; [gareth@ewt.org.za](mailto:gareth@ewt.org.za)) or Kerri Wolter (VulPro; [Kerri.wolter@gmail.com](mailto:Kerri.wolter@gmail.com)).

Existing data on breeding colonies and roost sites is not always up-to-date and complete. Roosts are also more numerous than breeding colonies, and the sporadic use of these sites can make them difficult to document and monitor (Phipps et al. 2013b). **The status of known breeding colonies and roosts within at least 50 km of a proposed wind farm should therefore be confirmed, and the surrounding area (within approximately 50 km from the site) should be assessed for previously unrecorded sites.**

Potential roosts and colonies should be identified through a combination of a desktop-based GIS survey, local knowledge, and analysis of tracking data (where available). Extensive searching of suitable sites using a spotting scope should follow. Helicopters and drones could potentially be used to survey possible roost and colony sites, however, this should only be considered under the guidance of a vulture specialist, as it could disturb birds and affect breeding success. There are also Civil Aviation Authority restrictions that limit the use of drones. These should be considered and adhered to if this technology is to be used.

Roosts and colonies should be classified according to the following definitions (from Boshoff et al. 2009):

- inactive site (no birds present, no ‘whitewash’ or no fresh or recent ‘whitewash’);
- seasonal/occasional roost (birds present or not present; fresh or relatively fresh ‘whitewash’; used on a seasonal or occasional basis, e.g. summer only);
- regular roost (birds present, fresh ‘whitewash’; birds present throughout all or most of the year);
- roost (status uncertain – either ‘seasonal/occasional roost’ or ‘regular roost’);
- colony (nest building or presence of eggs, nestlings or fledglings).

They should also be described (e.g. man-made or natural). Pylon roosts may be difficult to categorize due to the absence of whitewash. For the purposes of these guidelines a precautionary approach to categorising roosts is therefore recommended.

Topography and wind-scape

**The topography and wind-scape within the vicinity of the proposed wind farm should be assessed and areas associated with increased flight activity and/or risky behaviour (for example ridge tops, cliffs, steep slopes and wind current routes) should be considered as high sensitivity (de Lucas et al. 2012b, Rushworth and Krüger 2014).**

Bearded Vultures *Gypaetus barbatus meridionalis* in Lesotho prefer upper slopes, mountain-tops, and high ridges

### **The use of colony and roost buffers for decision-making, and the relative importance of different colonies and roosts**

The development of wind energy facilities within the recommended 50 km colony/roost buffer (and especially within the 18 km high sensitivity buffer around breeding colonies) is discouraged due to the risk of cumulative negative impacts. While these buffers do not automatically represent a ‘no go’ for wind farm development, they should be used to guide site selection, as well as the scope of data collection for impact assessment. The buffers indicate potential sensitivity; there are some limitations to the use of standard, circular buffers (discussed below), and there are also a number of other risk factors that must be considered in the impact assessment. The risks associated with developing wind turbines both within and outside of these buffers should therefore be subject to further interrogation throughout the process.

#### *Size and shape of buffer:*

Birds from different areas may have different foraging ranges (Bamford et al. 2007, Phipps et al. 2013b, Pfeiffer et al. 2015) and size of the core home ranges vary between years (Venter et al. 2018). It is also possible that Cape Vultures from larger colonies have larger core areas to compensate for increased competition close to the breeding colony, as has been observed in some colonial breeding gull species (Corman et al. 2016). Vultures are also unlikely to use a perfectly circular area around a colony or roost (López-López et al. 2013, Phipps et al. 2013b, Pfeiffer et al. 2015). It is therefore important to also consider the additional risk factors (e.g. topography, feeding sites and risk maps) as well as monitoring data gathered for the purposes of impact assessment.

#### *Size and location of colonies and roosts:*

The size of the colony or roost is likely to influence the probability of collisions. There also is evidence that breeding success is positively influenced by nest density (Pfeiffer et al. 2017) and large colonies may act as source populations (Boshoff & Minnie 2011). Large colonies therefore warrant the highest level of protection (i.e. very high sensitivity buffers).

The proposed buffers do not take into account the density of birds using a site. In southern Spain large-scale aggregation of vultures (i.e. a measure of the distance between the turbines and colonies or roosts, combined with the number of birds at each site) was found to be a more powerful predictor of collision risk than just distance from breeding colony or roost (Carrete et al. 2012). Spatial aggregation should therefore also be considered when assigning sensitivity.

Although large colonies may be the most critical to protect, it is important to preserve the maximum number of breeding colonies, regardless of the number of breeding pairs they contain. If vulture populations continue to decline, smaller breeding colonies may experience declines in breeding success then abandonment. Small colony desertions would cause range contractions and concentrate breeding attempts at only the biggest colonies, increasing their vulnerability.

A single mass-poisoning incident near one large remnant, breeding colony could further increase the likelihood of extinction (Ogada et al. 2015a). Reducing the number of breeding colonies may also constrict gene flow and produce a genetic bottleneck, which could further accelerate the decline of the species (Bonnell and Selander 1974).

Cape Vultures are also not restricted to roosting at the colony they breed at, and during both the breeding and non-breeding season adult vultures will roost at breeding colonies that are not their 'own' (Pfeiffer unpublished data). All colonies should therefore be regarded as important and warrant protection from the impacts of wind energy.

#### ***Breeding colonies vs. roost sites:***

Colonies hold breeding populations and are therefore important for the persistence of the species and therefore warrant protection (Boshoff & Minnie 2011). Phipps et al. (2013a) argue that colonies are more important to protect than roosts, as roosts can be ephemeral and used by fewer vultures. However, small colonies, where no breeding activity occurs might be considered as roosts, and some historical roosting sites have a few breeding pairs (K. Wolter pers. comm.). Roosts may also enable birds to increase their foraging range, as they are not limited to foraging within flying distance of a colony (K. Shaw. pers. comm.) Some roosts are likely to be more important than others based on their size, how regularly they are used, and how they are used. Roosts further away from colonies may be used differently to roosts close to a colony. Boshoff et al. (2009) reported evidence for the partial migration of Cape Vultures – roosts in the Eastern Cape Midlands were not used during the autumn–winter period (breeding season), but vultures were present during the spring–summer period (non-breeding season). It is unclear how this might affect collision risk or the significance of impacts.

#### ***Abandoned colonies and temporary roosts:***

If colonies or roosts have not been used within the past five years, the appropriateness of implementing buffers should be considered based on the history, importance and potential of the site to be recolonized.

Roosts can be ephemeral and used sporadically (Phipps et al. 2013a). For the purposes of these guidelines it is proposed that the recommended high sensitivity buffers be applied to regular and seasonal roosts. However, temporary roosts may be important and the need for additional survey effort should be carefully considered and revisited throughout the assessment process.

#### ***Beyond buffers:***

The buffers proposed above are unlikely to completely mitigate collision-risk. We know that both adult and juvenile Cape Vulture move much further than the proposed buffers around breeding colonies and roosts (Jarvis et al. 1974, Phipps et al. 2013a, Rushworth and Kruger 2014, Pfeiffer et al. 2015, Martens et al 2018). It is therefore important to also consider the additional risk factors (e.g. topography, feeding sites and risk maps).

(Rushworth and Krüger 2014, Reid et al. 2015). Eurasian Griffon Vultures follow wind currents, which are dictated by local changes in topography and allow the vultures to travel great distances with little energy (de Lucas et al. 2012b). These wind currents are often situated on ridges and cliffs, which provide orographic lift (de Lucas et al. 2012b, Katzner et al. 2012). It is along these wind currents that wind farms often find suitable conditions for generating power (de Lucas et al. 2012b), placing birds at risk of collisions. Collision risk for Eurasian Griffon Vulture also appears to increase with increasing elevation above sea level (de Lucas et al. 2008). The relationship between wind, topography and collision-risk is likely to be similar for Cape Vulture.

#### ***Food availability***

The availability of food can affect the flight height and area used by vultures (Spiegel et al. 2013). The potential availability of carrion in and around the location of a proposed wind farm should be considered during site screening. This assessment should include the location of existing supplementary feeding sites, the type of livestock present in the landscape, management practices, land ownership and the availability of alternative food sources.

A mosaic of land uses is found within the vultures' foraging ranges including commercial and communal farmland, plantations, and protected areas (Pfeiffer et al. 2015). Adult Cape Vultures captured at the Msikaba Cape Vulture Colony, Eastern Cape, preferred communal farmland over commercial farmland and it is assumed that this is because communal farmland offers better foraging opportunities because of numerous livestock deaths (Vernon 1998, Pfeiffer et al. 2015). In contrast, the land use around the Potberg breeding colony in the Western Cape is dominated by commercial sheep farming operations and the breeding colony has persisted (Boshoff and Currie 1981, Boshoff et al. 1984). This suggests that while there may be a preference for communal land, commercial farmland does not preclude the Cape Vulture. The type of livestock present (e.g. cattle vs. sheep) and the potential availability of food as associated with different livestock



MORGAN PFEIFFER

*The type of livestock present in an area, land management practices and land ownership (i.e. communal vs. commercial) all affect the availability of food for vultures, which in turn influences how they use the landscape.*



management practices may also affect how vultures use the landscape (Kevin Shaw, pers. comm).

Supplementary feeding sites are used to provide a supplementary source of carrion to vultures and thus these sites may affect the likelihood of birds being present in an area, their behaviour, and the potential risk of collisions. López-López et al. (2013) found that supplementary feeding sites influenced the movement of Egyptian Vultures in Spain. Surprisingly, areas far away from nesting sites (20–30 km) were used more than some closer sites (< 5 km). The vultures in the study travelled long distances (250 km round trip) to some supplementary feeding sites. Wind farms should therefore not be established close to supplementary feeding sites (and conversely supplementary feeding sites should not be established close to wind farms) (López-López et al. 2013). The appropriate size and shape of the buffer around existing supplementary feeding sites should be influenced by how vultures travel to and from the site, how regularly the site is used, and the location of colonies and roosts in the surrounding area. **Areas between a breeding colony or roost and an established feeding site should therefore be considered as high sensitivity.**



*A Cape Vulture feeds on carrion at a vulture restaurant in the Thomas River Conservancy, Eastern Cape. Supplementary feeding sites provide an additional source of food for vultures and influence the presence and behaviour of vultures in the area. The proximity of a proposed wind farm to supplementary feeding sites should therefore be considered during site screening and impact assessment.*

### Risk maps

Where available, risk maps can provide an additional layer for site screening but do need to be verified using data gathered on the ground. Pfeiffer (2016) used high-resolution tracking data from Cape Vultures in the Eastern Cape Province to predict the probability of vultures flying in the study area and flying at risk height. Average wind speed, distance from conservation priority sites (roost sites, breeding colonies, and supplementary feeding sites) were used to investigate their influence on Cape Vulture flight behaviour) and by using spatial variables to predict vulture presence, a probability map was generated to estimate relative collision risk across the landscape. Reid et al (2015) also developed a spatially explicit model to predict collision risk for Bearded Vulture. It is anticipated that initiatives to map risk collision will continue to improve.

### Cumulative impacts

While it may be theoretically possible to develop wind farms within the foraging range of Cape Vultures, a precautionary approach is strongly advised. **The risk of cumulative negative effects must be considered during site screening (this should be repeated in more detail in the impact assessment**

**process).** As a guideline the number (and where possible impacts) of operational and potential wind turbines (i.e. that have environmental authorisation) within a radius of at least 100 km should be considered during site screening.

## 3.2. IMPACT ASSESSMENT

The duration and scope of fieldwork required to assess the impact should be guided by the potential risk to Cape Vulture as assessed during site screening (i.e. based on the proximity to colonies and roosts, topography, food availability, and risk of cumulative impacts).

If broad scale analysis suggests that there is potential for building a wind farm with minimal negative effects on Cape Vultures, but the site falls within the species' range, the applicant should proceed to detailed data collection for baseline monitoring and impact assessment. This should proceed in accordance with BirdLife South Africa/EWT Best Practice Guidelines (Jenkins et al. 2015) as well as the recommendations of the avifaunal specialist. In addition to this, surveys should be conducted to verify the absence of active (seasonal, occasional or regular) roost sites, colonies and/or supplementary feeding areas within 50km of the site.

Developers may decide to proceed with data collection in areas identified as high or even very high sensitivity during site screening, but these projects should be considered as high-risk investments and are unlikely to have a positive outcome for conservation. Subject to verification through data collection, high sensitivity areas should be considered “critical habitat” and thus most financial institutions should impose stringent requirements before they will support development in these areas (for more see IFC 2012). Data collection in high and very high sensitivity areas should follow the recommendations outlined below.

The assessment of the site sensitivity and the recommended data collection protocols should be regularly reviewed throughout the process, taking into consideration the frequency that Cape Vulture are recorded on site, the availability of food, and other features associated with risk.

All impact assessments should include consideration of the potential impact of associated infrastructure such as power lines and roads on vultures (Botha et al. 2017).

### Data collection within areas of high and very high sensitivity

If a wind energy facility is proposed within a **high sensitivity area** (as assessed in site screening), data collection must extend beyond the minimum protocols recommend in the BirdLife South Africa/EWT Best Practice Guidelines (Jenkins et al. 2015), as outlined below. While these recommendations technically also apply to areas identified as **very high sensitivity** during screening, BirdLife South Africa strongly advises against investing in further studies as it is unlikely that the wind energy can be developed sustainably in these areas.

### Duration and timing of data collection

Vulture activity levels and use of the landscape may differ year on year (e.g. Venter et al 2018) and avifaunal surveys should preferably span several years to account for seasonal variation in flight activity, and inter-annual variation in the relative abundance of birds (de Lucas et al. 2008, de Lucas et al. 2012a, Jenkins



CHRIS VAN ROOYEN

et al. 2015). **BirdLife South Africa therefore recommends that the duration of monitoring should be extended to at least two years within areas of high and very high sensitivity.**

If the results of the first year of monitoring indicate that the assessment of sensitivity during screening was inaccurate (i.e. should have been lower), it may not be necessary to continue with data collection for two years. This should only be considered if: i) all previously recorded roosts and colonies within 50km of the site are confirmed to be inactive and unlikely to be recolonized, ii) no previously unrecorded roosts or colonies are found within 50km of the proposed wind farm, and iii) no or a very low number of vultures are recorded during the surveys.

It is also important to sample as much seasonal variability as possible. Vultures could be more susceptible to wind turbine collisions in particular seasons as movement patterns and behaviour may be affected by the time of year (Spiegel et al. 2013). In southern Spain the greatest number of vulture fatalities occurred between September and February – corresponding to the Northern Hemisphere winter when thermal generation was weakest (Barrios and Rodríguez 2004, de Lucas et al. 2008, de Lucas et al. 2012a). This pattern differs between regions – a study of 89 wind farms across eight provinces in northern Spain found that the number of fatalities peaked in March and then declined until September (Camiña 2011).

Cape Vultures also may demonstrate seasonal differences in behaviour and habitat use. For example in parts of the Eastern Cape increased numbers of vultures have been recorded in spring–summer (the non-breeding season) (Boshoff et al. 2009, Smallie, unpublished). Cape Vultures from the Msikaba Colony also showed seasonal variability in habitat use and birds in the non-breeding season had slightly larger home ranges than in the breeding season (Pfeiffer et al. 2015).

Vantage point survey fieldwork should therefore include the pre-breeding season (late March to early May), as well as

*Roosts may be used sporadically and can be difficult to identify and monitor. An area of approximately 50 km around a proposed wind farm should therefore be surveyed for previously unrecorded roosts and colonies.*

the breeding season (May to December). **Site visits should be timed to account for as much seasonal variation as possible (i.e. a minimum of 6 site visits each year).**

#### ***Focal point surveys***

Accurate information on the status and location of each roost and colony is useful for the purposes of impact assessment and mitigation, and it will also help measure trends before and after the construction of the wind farm.

**All (occupied and potential) breeding colonies and roosts within 50km of a proposed wind farm should be treated as focal points during monitoring and impact assessment.** Breeding colonies should be monitored according to the standard survey protocols (e.g. Benson et al. 2007, Wolter et al. 2011), as far as is practically possible. Where access is possible, and taking care not to disturb breeding birds, the number of pairs and breeding success (productivity and fledgling rates) should be recorded. Colonies should be visited at least three times during the breeding season to count the number of pairs (May), the number of chicks (July/August) and the number of fledglings (September/October) (Wolter et al. 2011). Roosts should be visited more often (i.e. at least four times a year) and classified (as per Boshoff et al. 2009) and described (e.g. man-made vs. natural). As a minimum (i.e. where access is limited and at roost sites), notes should be taken on the number of vultures and direction of travel to and from these sites. Surveys should be done at dusk as vultures may leave a colony or roost when it is too dark to do counts at dawn (Kevin Shaw, pers. comm.).

Monitoring data for roosts and colonies could make a significant contribution to the study of the species and it is therefore recommended that these data are shared with relevant stakeholders (e.g. BirdLife South Africa, EWT, VulPro and DEA). Where possible, monitoring should be coordinated between neighbouring wind farms and local conservation organisations – there is no need to duplicate surveys. An efficient approach could be to appoint a local conservation organisation to continue, and if necessary expand existing monitoring programmes.

#### *Vantage point surveys*

It is important to ensure that a representative sample of vulture movements is sampled, particularly if a wind farm is proposed within a high-sensitivity area. This implies that time spent conducting vantage point surveys should be increased from the minimum recommend in BirdLife South Africa /EWT's Best Practice Guidelines (Jenkins et al. 2015). Enough time must be spent to be able to accurately quantify flight activity and predict risk. However, flight activity can be variable, and the ideal number of hours spent conducting vantage point surveys will be influenced by the site, species, flight activity levels, and the acceptable degree of uncertainty. Increasing the number of hours of vantage point surveys will decrease the variability in the collision risk assessment, and more hours of monitoring may be required to reduce variability (i.e. potential error) at sites with low levels of flight activity (Douglas et al. 2012). In the absence of statistical analysis of the uncertainty associated with a data set for Cape Vulture, **it is recommended that an absolute minimum of 72 hours per vantage point per year should be surveyed** (e.g. Scottish Natural Heritage, 2013). Vantage points watches should be conducted by a minimum of two persons (at the same time on the same vantage point). This will help minimise observer fatigue and distraction and promote accurate data collection.

Vantage points should be located to ensure maximum coverage of the proposed development site. The direction of flight and height of vultures should be recorded at the first sighting, and then every 15 seconds thereafter. Flight height should be recorded in bands of 10 meters, preferably by using clinometers and range finders. These data can later be categorised into three broad bands (i.e. below, within, and above the rotor-swept area), depending on the turbine specifications proposed. Flight paths of Cape Vultures should be sketched out on topographic maps. Wind velocity and wind direction should also be recorded.

#### *Tracking devices*

Tracking devices (e.g. GPS/GSM devices) can be a valuable tool for understanding the flight behaviour and habitat usage of individual birds, and tracking data can be scanned to help identify roosts (which can be costly to find and may escape detection otherwise) (Pfeiffer et. al 2017). However, the costs and benefits of using tracking devices to help inform the placement of wind turbines should be carefully thought through. Devices should be selected and programmed to meet the purpose of the study, with consideration given to accuracy, the need for data on flight height and the frequency of recording locations.

Cape Vulture are likely to move well beyond the boundaries of any single wind farm, and there is a risk that vultures fitted with tracking devices might not move through the area



KATE WEBSTER

*A Cape Vulture flies dangerously close to a wind turbine in the Eastern Cape.*

of interest. Furthermore, only individual birds can be monitored, which means that there is a risk the data collected will not be representative of all birds in an area. Age and overall health of the birds must also be considered when analysing data, this should include if the bird has been rehabilitated. Rehabilitated Cape Vultures have a lower survival rate than wild-caught birds (Monadjem et al. 2013), which may influence their movements.

Cape Vulture can also be extremely difficult to capture and handle, and this should only be done under the supervision of suitably qualified and experienced individuals. Relevant protocols (e.g. Wolter et al. 2015) for capturing, handling and fitting tracking devices must be consulted. While no accounts of Cape Vulture fatalities from harnesses or tracking devices have been published, handling birds and attaching devices may carry a risk to study animals (Marzluff et al. 1997). Skin irritations have been observed (M. Pfeiffer, pers. obs.), but the long-term effect of this condition remains unknown.

Before embarking on a project that involves capturing and tracking vultures, a permit must be obtained from DEA and/or the provincial conservation authority (as per the National Environmental Management: Biodiversity Act (10/2004): Threatened or protected species regulations). BirdLife South Africa also strongly recommends that ethical clearance be obtained. For more information please see BirdLife South Africa's position statement on the tracking of birds, and the BirdLife South Africa Ethics Committee, at [www.birdlife.org.za](http://www.birdlife.org.za)

**Data gathered through tracking vultures can provide valuable information to guide the location of wind farms and powerlines.** This approach is best suited to projects beyond the scale of most wind farms (e.g. strategic/regional planning and sensitivity maps). Collaboration and information sharing

among stakeholders is therefore strongly encouraged. In order to maximise the benefits of tracking and to avoid duplication Tracking data should be housed in a central repository (e.g. Movebank), and the results of the project should be published in a peer review journal.

### Radar

Tracking devices are useful if the intention is to monitor the movements of individual birds over a wide area. In contrast, radar can be used to accurately record the movements of many birds in a limited area. Radar can record flight height and can eliminate some of the errors associated with human observation (Becker 2016). Some radar systems cannot differentiate between species, but it may be possible to correctly identify Cape Vulture using certain types of radar equipment (Becker 2016). Although night-time movements of vultures are relatively uncommon, radar can also record flights when visibility is limited by light (Becker 2016). Radar does not replace the need for vantage point monitoring, but it can help improve precision of measurements and possibly reduce the amount of human observation time at a site. **The use of radar in high sensitivity areas is encouraged**, but precision should not be confused with accuracy – radar studies must still be well-timed (as a minimum radar surveys should be timed to coincide with the period of highest risk).

Radar may also be a useful tool to use when mitigating impacts during the operational-phase (i.e. though shut-down-on demand).

### Wind current modelling

Wind current modelling can be used to predict the likely flight behaviour of vultures at the scale of a wind farm (de Lucas et al. 2012b). This method involves constructing a topographic model of the study site and recording the movements of objects through the model at different wind directions. Although costly and time-consuming, this method could be useful for proposed development sites that experience a multitude of wind directions.

### Assessment of collision risk

Impact assessments generally assume that collision risk is correlated to bird abundance and passage rates. However, there is conflicting evidence on the relationship between the abundance and/or passage rates of Eurasian Griffon Vulture and wind-farm fatalities in Spain (de Lucas et al. 2008, Ferrer et al. 2012). Barrios and Rodríguez (2004) reported that the highest number of vulture passes within 5 m of turbine blades were also near the turbines with the highest mortality rates. Another study found that although there may have been a trend between the predictive power of the EIAs (based on passage rates) and actual vulture fatalities, this relationship was not significant (Figure 3) (Ferrer et al. 2012). De Lucas et al. (2008) also did not find a simplistic linear relationship between abundance and collision mortality.

Table 1 summarises average Cape Vulture passage rates and fatality rates at operational wind farms in South Africa to date. This data is provided for comparative purposes only. The survey effort was lower than is recommended in these guidelines and post-construction monitoring has only been conducted for a short time in South Africa.

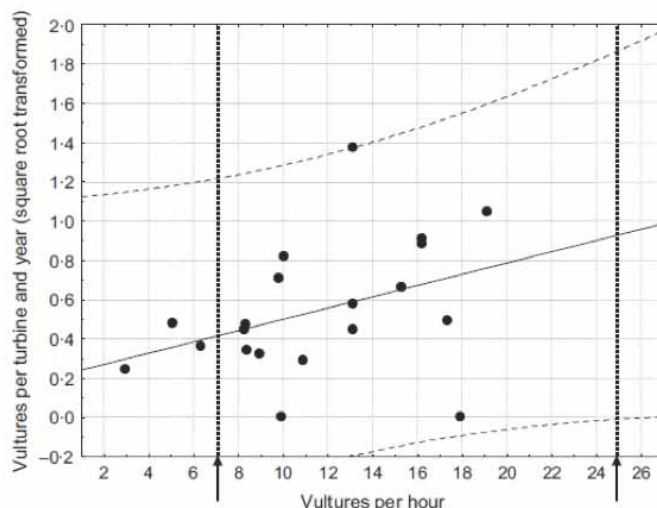

Figure 3. Non-significant correlation between Griffon Vulture mortality recorded in operating wind farms in Tarifa, Spain (square root transformed) and passage rates of vultures ( $r=0.379$ ,  $n=20$ ,  $p=0.099$ ). The dotted curves represent 95% of prediction. Some wind farms in the study were not approved, the range of passage rates recorded in these projects is represented by the arrows and dotted lines. From Ferrer et al. (2012).

The number of vulture fatalities that might take place once the wind farm is operational should be estimated using a collision risk model (Band et al. 2007, Scottish Natural Heritage 2009, Strickland et al. 2011, United States Fish and Wildlife Service (USFWS) 2012, Masden 2015) at all sites where there is sufficient data to estimate the risk. Collision risk models provide a useful and objective indication of the relative risk of collisions (USFWS 2013) and take many factors in addition to passage rates into account, including the characteristics of the wind energy facility and its turbines, flight height and speed, and a correction factor is used to account for uncertainties and behaviour (e.g. avoidance) (Strickland et al., 2011). The results of collision risk modelling can be used to compare different wind farm locations or layouts and can help contextualise the predicted impacts on the local bird population. However, if collision risk models are to produce meaningful results it is important that the input data represents average conditions – this should be possible with

	Passage Rate (vultures/hour)		Distance to nearest known roost or colony (km)	Collision rate (vultures/turbine/year)
	Pre-construction	Post-construction Year 1 (Year 2)		
Wind Farm 1	0.02	0.26	24	0
Wind Farm 2	0.31	0	17	0
Wind Farm 3	0.13		22	0.45
Wind Farm 4	0.13	0.11	28	0.07
Wind Farm 5	0.34	0.64 (0.84)	12	0.03

Table 1. Average passage rates (measured using protocols outlined in Jenkins et al. 2015), distance to nearest nest and collision rate at operational wind farms in the Eastern Cape which have recorded the presence of Cape Vulture. Operational phase monitoring was conducted for as little as three months (Wind Farm 3) and much as 36 months (Wind Farm 5)

the extended monitoring protocols recommended in these guidelines for sites of high sensitivity. Collision risk models make a number of assumptions (Whitfield 2009) and there is no literature verifying fatality rate predictions for Cape Vulture. The results should therefore be interpreted with these limitations in mind.

Predicting collision risk is not straightforward. Wind farms placed in dangerous areas with low densities of vulnerable species may be more hazardous than wind farms located in relatively safe areas with high densities of vulnerable species (Ferrer et al. 2012). In addition to passage rates and flight height, **factors such as topography, bird behaviour, season, aggregation, wind direction and wind speed may all be important (Carrete et al. 2012, de Lucas et al. 2012a, Ferrer et al. 2012) and should be taken into account during all stages of the assessment.**

#### Assessment of cumulative impacts

The risk of cumulative negative effects must be considered during site screening and then again in more detail during the impact assessment processes. The World Bank Group (2015) recommends that cumulative impact assessments should be conducted when multiple wind farms are located in areas of high biodiversity value (e.g. core habitat for Cape Vulture). The appropriate spatial extent of the cumulative assessment should be determined by the avifaunal specialist, taking the receiving environment into consideration. As a guide we recommend that the cumulative effects of all established and potential wind farms (i.e. wind farms that have environmental authorisation) within a radius of at least 100 km be considered during screening, but if multiple fatalities have been predicted during the impact assessment, it would be more appropriate to assess cumulative impacts on the regional population (e.g. through population viability assessment). This assessment should take into consideration impacts over the lifetime of the proposed facilities.

For further guidance on cumulative impact assessments see DEAT 2004, SNH 2012 and IFC 2013. The cumulative effects study for wind energy in the Tafila Region in Jordan (IFC 2017) also provides a useful example.

#### Mitigation

There are limited options available for mitigation once a wind farm is operational and the mitigation hierarchy (i.e. first seek to avoid and minimise) should always be adhered to. Mitigation measures should be designed to achieve no net loss of biodiversity (IFC 2012).

#### *Planning phase (location, layout and design)*

The considered location and layout of a wind farm and its turbines is the most widely accepted and cost-effective approach to minimise impacts. Turbines should not be placed in areas with a high abundance of Cape Vulture, high passage rates, or where there are topographic features and other areas likely to be associated with a high risk of vulture collisions (as identified in site screening and verified by the impact assessment). This may require the avoidance of large areas of the landscape.

The location and alignment of new powerlines associated with the wind farm should also take the above factors into account. No new powerlines should be permitted within a 5

km radius of a colony or roost (C. Hoogstad pers comm.). In areas where there is a high risk of collisions, above ground power lines should be avoided wherever possible and all new power lines must be marked with bird flight diverters and these devices must be monitored and maintained throughout the lifetime of the line. All new powerlines installed must be of the 'bird-friendly' type in order to minimise the risk of collision and electrocution (Jenkins et al. 2010, Boshoff et al. 2011) (for more information contact the Eskom-EWT Strategic Partnership).

Although rarely proposed in South Africa, BirdLife South Africa recommends that old lattice type wind turbine towers should not be constructed, as these provide numerous perching areas for raptors and may increase the probability of collisions (Barrios and Rodríguez 2004).

The implications of varying the name-plate capacity, hub height and rotor swept area should be assessed on a case-by-case basis, informed by the predominant flight patterns on site. Some studies have found that fatalities increased with turbine height, but relationship between turbine height and collision risk is likely to be site- and species-dependent (Marques et al. 2014).

Free spinning of turbines under low wind conditions, when turbines are not producing power should be avoided (World Bank Group 2015).

#### **Construction**

Construction activities at or near breeding colonies and roosts should be avoided to minimise disturbing vultures at these sites (Tarboton and Allan 1984, Borello and Borello 2002, Verdoorn 2004). The extent of disturbance buffers has been debated internationally and little data exists to support recommended buffer sizes. To some extent this is a moot point for the Cape Vulture and wind farms, as the buffers proposed in these guidelines to minimise collision risk (for powerlines and turbines) are likely to exceed disturbance distances. However, it may be possible that construction or upgrades to other infrastructure associated with a wind farm (e.g. roads) is proposed closer to colonies or roosts. Construction directly below or on top of a breeding colony or roost should not be permitted, and construction activities should not take place within 500 m of a breeding colony or roost (Kaisanlahti-Jokimäki et al. 2008) (this value is based on eagle research and should be adjusted based on the vultures' use of the immediate area). Construction near colonies during the breeding season (i.e. from egg laying, until the chicks have fledged) should be avoided (Borello and Borello 2002).

#### **Operational phase**

Operational phase mitigation and adaptive management carries risks and uncertainties and should not be relied on at high-risk sites where avoidance would be more appropriate. However, short of excluding wind energy from vast areas of South Africa it will be impossible to reduce the risk of vulture collisions to zero. Where the level of risk is deemed acceptable, but there is still a small residual risk of collisions, provision for operational phase mitigation and adaptive management must be included in the Environmental Management Programme (EMPr) to further reduce the risk. **The EMPr should clearly describe impact management objectives, outcomes**

and actions required to address potential impacts on vultures. Before a project proceeds it is important that decision-makers understand, and the wind farm developer agrees to the potential operational and cost implications of an adaptive management strategy.

The following operational phase mitigation options could be considered:

### 1. Curtailment and shut-down on demand

Turbine operation may be restricted to certain times of the day, season, or in specific weather conditions that are associated with a high risk of collisions. This approach requires a clear understanding of the risk factors (Barrios and Rodríguez 2004, de Lucas et al. 2012a). The collision risk for Eurasian Griffon Vulture was found to be higher at lower wind speeds (see Figure 7 from Barrios and Rodríguez 2004). In this example, turbines could theoretically be curtailed during low wind conditions, when the impact on power generation would be low. However, curtailment may result in turbines being shut down for long periods. Turbines operating at night, for example, would have a very limited impact on Cape Vultures, but could have major implications for the amount of power generated by a facility.

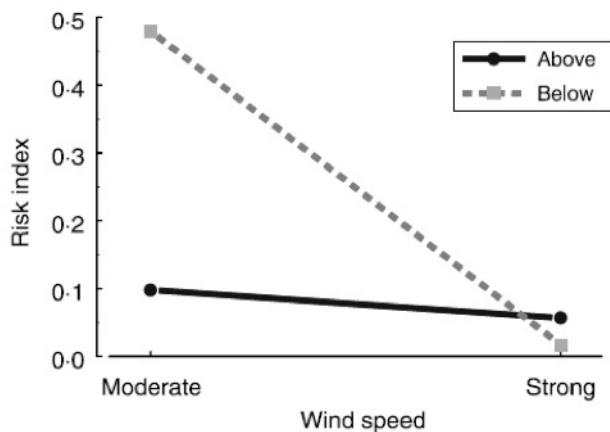

Figure 4. The interaction between height of flight at first contact with the observation area (i.e. above the turbines represented by the solid line vs. from below the turbines, dotted line) and wind speed on the putative risk index for Griffon Vulture (*Gyps fulvus*) at PESUR wind farm, Spain. Range of speeds of light/moderate winds: 4-6–12.5 m s<sup>-1</sup>; strong winds: > 12.5 m s<sup>-1</sup>. The risk index was defined as the frequency of risk situations (i.e. ratio between the number of birds observed within 5 m of the blades and the total number of passes or observations within 250 m of the turbine lines). From Barrios and Rodríguez 2004.

Shut-down-on-demand (i.e. stopping the movement of the turbines when there is a high risk of collisions) has been demonstrated to be an effective mitigation measure for reducing (but not eliminating) Eurasian Griffon Vulture mortalities in Spain (de Lucas et al. 2012a). Shut-downs can be triggered by human observers, or by using devices (i.e. radar or cameras) managed under human surveillance (Marques et al. 2014, BirdLife International 2015, World Bank Group 2015).

The effectiveness and feasibility of this approach for the Cape Vulture remains uncertain as the number of vultures

and daily passage rates will affect how often turbines need to be shut down. Shut-down-on-demand is likely to be most effective when there are clear peaks in collision-risk. In the above example of Griffon Vultures in Spain fatalities peaked during the migratory period (de Lucas et al. 2012a), while Cape Vulture are not migratory. Since most Old-World vulture species are resident, they may be exposed to risks associated with a wind farm throughout the year, not just during a specific period (e.g. migration) (Barrios and Rodríguez 2004).

Shut-down-on-demand or curtailment should not be relied on as the primary mitigation measure (BirdLife International 2015). However, it must be considered as part of the mitigation strategy if multiple Cape Vulture mortalities are expected to occur (or have been recorded) at a wind farm. The implementation of shut-down-on-demand should be adaptive, guided by a well-developed, post-construction monitoring program and the cost implications of this approach must be taken into account at an early stage of the project planning (World Bank Group 2015).

### 2. Food availability

If a wind farm is established within an area where Cape Vulture may occur it is important that the number of animal carcasses is minimised, both at the wind farm and within nearby areas, as carcasses could attract vultures and increase the risk of collisions. A dedicated full-time team should be tasked with detecting and removing any dead livestock or other animals within or near to wind turbines (e.g. within 2 km). All operational staff should also be required to report carcasses as soon as they are observed. Carcasses should be disposed of in a way that would not attract birds, or they should be transported to safe locations that are well away from the wind farm.

Calving and lambing near turbines (e.g. within 2km) is also strongly discouraged. This may require the wind farm to have agreements in place with the land owner and must be carefully considered during project planning. An alternative approach could be to curtail turbines during calving and lambing season.

If limiting the availability of food on site is proposed as mitigation and is required to reduce collision-risk to acceptable levels a) the mitigation hierarchy must have been exhausted and b) the effectiveness of this approach must be verified during the preliminary avifaunal assessment and impact assessment process.

#### Supplementary feeding sites (vulture restaurants)

It has been suggested that strategic placement of new supplementary feedings could influence the movements of vultures and reduce collision risk. While the use of supplementary feeding sites does have conservation merit and may be appropriate in the context of addressing existing threats (including from operational wind farms), a precautionary approach should be adopted if this is considered as mitigation for new wind energy facilities.

In a study of Cape Vultures (largely from the northern-node population), Kane et al. (2015) found that the location of colonies and supplementary feeding sites are both significant predictors of vulture presence. However, they found a stronger



SAMANTHA RALSTON-PATON

*The use of 'shut down-on-demand' may reduce the risk of turbine strikes in some circumstances, but the effectiveness and feasibility of this approach for Cape Vulture remains to be tested. Where it is proposed as mitigation, the cost implications must be taken into account by the applicant during the impact assessment process.*

association with roosts and colonies than with supplementary feeding sites, and supplementary feeding sites not reduce foraging ranges. Vultures were found to range over large areas, including where there are no restaurants (Kane et al. 2016). A small percentage of the Cape Vulture population may be reliant on supplementary feeding sites for food, but there appears to be enough wild ungulate carcasses and livestock deaths in communal farmland to sustain vulture populations (Kane et al. 2015, Pfeiffer et al. 2015), particularly in areas with good wind resource (i.e. Eastern Cape). While supplementary feeding sites are used by adult Cape Vultures, they are not as dependent on supplementary feeding sites as younger birds (Pfeiffer et al. 2015, Reid et al. 2015).

A study in Asia showed that five tagged Oriental White-backed Vultures *Gyps bengalensis* reduced their home ranges (by up to 59%), time in flight, and daily travel distances after supplementary feeding sites were established (Gilbert et al. 2007). However, the sample size was not representative of the population, all vultures travelled beyond the feeding site (which was 1.4 km from the breeding colony), and there was no evidence that the direction of travel was changed (Gilbert et al. 2007). There are also a number of differences between Oriental White-backed Vultures and Cape Vulture, including the size of their home ranges.

Supplementary feeding sites must be located and managed so as not to unintentionally increase risks to the birds (EWT 2011, Cortes-Avizanda et al 2016). If a new supplementary feeding site is proposed, consideration must be given to the location of other wind farms (planned, as well as operational), and associated infrastructure. These facilities would also require management throughout the lifetime of the wind farm. The pros and cons of altering the foraging range of Cape Vultures should also be carefully considered as this may affect vulture ecology and the provision of ecosystem services.

Where existing supplementary feeding sites are located in such a way that they may increase the probability of vultures traveling across a proposed wind farm, collision risk could be reduced if the supply of food is stopped at the restaurant, or the feeding site is relocated. However, if a feeding site has been operational for some time (e.g. a year or more) it is likely to take some time for birds to unlearn the behaviour and vultures may continue to visit the site even once a restaurant has been discontinued (K. Wolter pers comm.). This approach would also require the agreement and cooperation of the supplementary feeding site manager and the knock-on effects should be carefully considered. Supplementary feeding sites have many benefits including providing a safe feeding option, supplemental food in times of scarcity, and opportunities for tourism and research (Kane et al. 2015) which could benefit the overall conservation of the species. Supplementary feeding sites have increased the survival rate of first-year Cape Vultures in the Western Cape, and the number of breeding pairs at a colony in KwaZulu-Natal (although not breeding success) (Piper et al. 1999, Schabo et al. 2016).

**If the strategic location or removal of supplementary feeding sites is proposed as a mitigation measure in order to reduce the risk of collisions to acceptable levels a) the mitigation hierarchy must have been exhausted and b) the effectiveness of this approach must be verified during the preliminary avifaunal assessment and impact assessment process.**

### 3.3 MONITORING AND ADAPTIVE MANAGEMENT

If a wind farm is established in a high sensitivity area the duration and extent of construction and operational phase monitoring should be significantly increased from the minimum requirements outline in BirdLife South Africa and EWT's Best Practice Guidelines (Jenkins et al. 2015).

Given the uncertainty with regard to the potential effects of wind energy on Cape Vulture and how negative impacts could be minimised, before-and-after studies, combined with carcass surveys, will make a significant contribution to our knowledge.

Adaptive management is often proposed as a mitigation strategy in South Africa. It is an iterative decision-making process used in the face of uncertainty where the effectiveness of management policies and practices are continually reviewed and improved. As such, adaptive management relies heavily on monitoring data (USFWS 2012).

Wind farms are encouraged to go beyond demonstrating no net loss and should aim to achieve a net positive gain for the species. Once the mitigation hierarchy has been exhausted, residual impacts could be compensated through off-site conservation action.

#### Monitoring within high sensitivity areas

Data from vantage point monitoring can be useful when assessing options for operational-phase mitigation and vantage point monitoring should therefore continue through construction and into the operational phase, according to the frequency and duration recommended by the avifaunal specialist. It may be necessary to relocate vantage points to avoid construction activities.

Breeding colonies and roost sites identified and surveyed during site screening and impact assessment should be monitored throughout the lifetime of the facility (as per the recommendations for focal surveys above), and where possible in collaboration with NGOs and state conservation agencies and other wind farm operators in the area.

Surveys for bird fatalities beneath the turbines must be initiated prior to the commercial date of operation and should continue throughout the lifespan of the project. These surveys should begin before 10% of the turbines have been erected and are rotating.

If new powerlines are built, operational phase monitoring should extend to include the powerline – bird flight diverters should be checked (and if necessary, replaced) and the area beneath the line should be surveyed for fatalities (with a frequency of approximately once a month, where feasible).

#### Injuries and fatalities

Fatalities of Cape Vulture (ad hoc or recorded during systematic surveys) should be carefully recorded and reported. The location of the carcass and estimated wind speed, the weight of the bird and approximate age (adult, immature or juvenile) should be recorded, and the carcass should ultimately be donated to a museum. Monitoring reports should normally be submitted to relevant stakeholders every quarter (Jenkins et al. 2015). In the event of a Cape Vulture fatality, this should be immediately reported to the bird specialist appointed by the

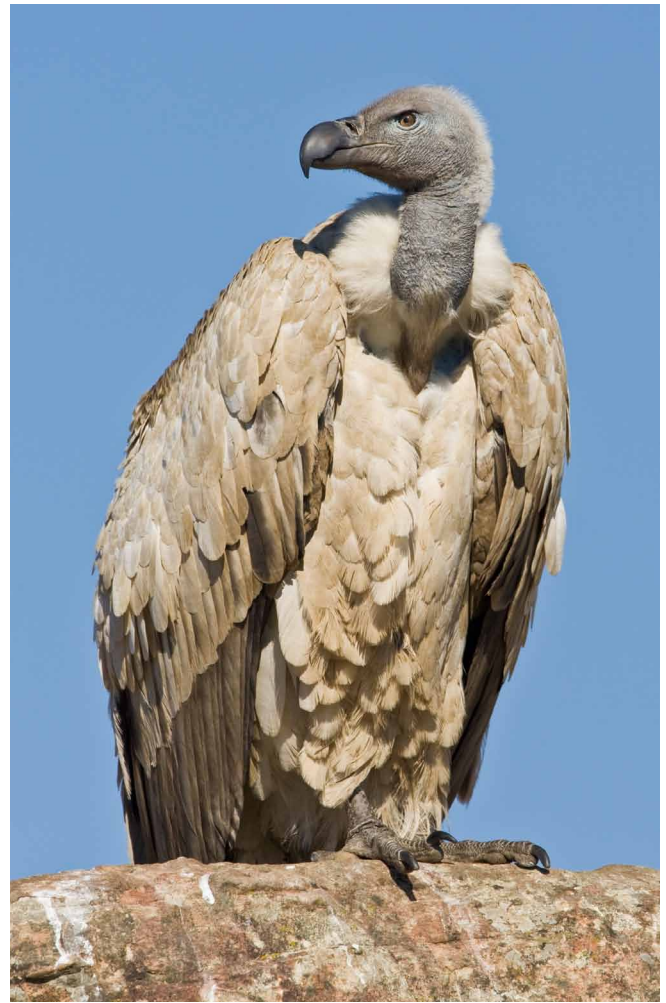

ALBERT FRONEMAN

*Monitoring birds before and after the construction of a wind farm provides an opportunity to verify predictions made during EIA processes, and test the effectiveness of mitigation measures.*

wind farm, BirdLife South Africa, VulPro, EWT and relevant conservation authorities (i.e. the DEA and provincial conservation authority). Following consultation with experts, and consideration of the as the EMPr (which should include impact management objectives, outcomes and actions relating to minimising risk to Cape Vulture), the avifaunal specialist should draft a report outlining the circumstances of the incident, the likely significance of the impact (including cumulative effects from that particular wind farm over the period of operation, and negative effects from other wind farms in the area), and if necessary a mitigation strategy should be proposed. Where necessary the specialist should propose amendments to the EMPr.

The nearest certified wildlife rehabilitation centre should be identified in the EMPr (VulPro will be able to assist in identifying suitable facilities) and if a bird is injured from a suspected collision with wind turbine blades, or related infrastructure, it should be transported to the facility where it can receive proper care. The injured birds should be examined, and the extent of the injuries documented.



## 4. CONSERVATION AND RESEARCH PRIORITIES

There are many gaps in our knowledge regarding the Cape Vulture, how they might be affected by wind energy facilities, and how these impacts could be managed. These include:

- A regular review of the location, size and status of Cape Vulture colonies and roosts (particularly in areas preferred by wind farm development, such as the Eastern Cape);
- A review of the size and effectiveness of the recommended buffer sizes proposed in these Guidelines (including a study of the relationship between proximity to roost and colony and collision risk);
- Ranking the importance of roost sites by vulture use, seasonality, type (man-made or natural) and risk of collisions (this analysis would need to include historical data; data on which individuals use roosts would also be of value);
- Assessing carrion availability in relation to foraging ranges and breeding colony size;
- Assessing the viability of locating supplementary feeding sites to reduce wind farm fatalities;
- Creating a habitat suitability model to predict potential roost sites or breeding colonies;
- Determine how hub height and rotor swept area of wind turbines influences collision risk for Cape Vulture;
- Ecological and economic significance of the species (e.g. implications of loss of species from an area);
- Is collision risk associated with vulture age or with the proportion of risky flights in the rotor swept area?
- Model Cape Vulture flight paths through wind development areas;
- A statistical analysis of the optimal duration and timing of vantage point surveys required to quantify flight activity (and risk of collisions);
- The effectiveness and feasibility of mitigation measures (e.g. curtailment and shut-down on demand using different techniques).
- Population Viability Analysis under different development scenarios.

## 5. CONCLUSION

South Africa is at an advantage with regard to wind energy development and Gyps vultures, because of the wealth of information produced in Spain on the topic. Furthermore, South Africa is fortunate to have about 2.5-fold more land than Spain, which provides numerous opportunities for wind energy development away from areas where the potential for vulture collisions is high. Over 80% of South Africa's land mass has enough wind resource for economic wind farms and can generate enough power to meet South Africa's electricity demand, with just 0.6% of the country's land area (CSIR 2016). While there are numerous other factors that constrain the area available wind energy development, we are optimistic that with careful site selection, rigorous monitoring, impact assessment and mitigation, it should be possible to develop wind energy in South Africa without negatively affecting the conservation status of Cape Vulture.

## REFERENCES

- Allan D. 2015. Cape Vulture *Gyps coprotheres* In: Taylor M, Peacock F, and R Wanless. *The 2015 Eskom Red Data Book of Birds of South Africa, Lesotho, and Swaziland*. Johannesburg: BirdLife South Africa.
- Avisense. 2015. Bird Scoping Assessment Specialist Report. *Strategic Environmental Assessment for wind and solar photovoltaic energy in South Africa*. CSIR Report Number: CSIR/CAS/EMS/ER/2015/0001/B. Stellenbosch
- Bamford AJ, Diekmann M, Monadjem A, and J Mendelsohn. 2007. Ranging behaviour of Cape Vultures *Gyps coprotheres* from an endangered population in Namibia. *Bird Conservation International* 17: 331–339.
- Band W, Madders M, and Whitfield DP. 2007. Developing field and analytical methods to assess avian collision risk at wind farms. In *Birds and wind farms – risk assessment and mitigation*. M. De Lucas, G.F.E. Janss, & M. Ferrer (eds). London, Quercus.
- Barrios L and A Rodríguez. 2004. Behavioural and environmental correlates of soaring-bird mortality at on-shore wind turbines. *Journal of Applied Ecology* 41: 72–81.
- Becker F. 2016. Optimising the use of visual and radar observations for the mitigation of wind energy related impacts on Cape vultures (*Gyps coprotheres*) in the Eastern Cape Province. Master of Science Thesis, Stellenbosch University, South Africa.
- Benson PC, Piper, SE, Neethling M, Vernon, C, Botha, A, Boshoff, A, Borello, WD, Borello, R, and PJ Mundy. 2007. Cape griffon vulture *Gyps coprotheres*: Breeding colony conservation and monitoring protocol. Endangered Wildlife Trust Birds of Prey Programme.
- Benson PC. 2015. A survey of Cape vulture breeding colonies in South Africa's northern provinces (Transvaal Region) – an update 2013 *Ornithological Observations*. 6: 31–36.
- BirdLife International. 2015. *Review and guidance on use of 'shutdown-on-demand' for wind turbines to conserve migrating soaring birds in the Rift Valley/Red Sea Flyway*. Regional Flyway Facility. Amman, Jordan
- Bonnell ML and RK Selander. 1974. Elephant seals: genetic variation and near extinction. *Science* 184: 908–909.
- Borello WD and RM Borello. 2002. The breeding status and colony dynamics of Cape vulture *Gyps coprotheres* in Botswana. *Bird Conservation International* 12: 79–97.
- Boshoff A and J Minnie. 2011. On the role of the shape and size of foraging area, and colony size, in selecting critical areas for Cape griffon *Gyps coprotheres* conservation action. *Vulture News* 61: 4–15.
- Boshoff AF and MH Currie. 1981. Notes on the Cape vulture colony at Potberg, Bredasdorp. *Ostrich* 52: 1–8.
- Boshoff AF, Barkhuysen A, Brown G, and MD Michael. 2009. Evidence of partial migratory behaviour by the Cape Vulture *Gyps coprotheres*. *Ostrich* 80: 129–133.
- Boshoff AF, Minnie JC, Tambling CJ, and MD Michael. 2011. The impact of power line-related mortality on the Cape vulture *Gyps coprotheres* in a part of its range, with an emphasis on electrocution. *Bird Conservation International* 21: 311–327.
- Boshoff AF, Robertson AS, and PM Norton. 1984. A radio-tracking study of an adult Cape griffon vulture *Gyps coprotheres* in the south-western Cape Province. *South African Journal of Wildlife Research* 14: 73–78.
- Botha AJ, Andevski J, Bowden CGR., Gudka M, Safford RJ, Tavares J, and Williams NP. 2017. *Multi-species Action Plan to Conserve African-Eurasian Vultures*. CMS Raptors MOU Technical Publication No. 4. CMS Technical Series No. 33. Coordinating Unit of the CMS Raptors MOU, Abu Dhabi, United Arab Emirates.
- Cabrera-Cruz SA and R, Villegas-Patracá. 2016. Response of migrating raptors to an increasing number of wind farms. *Journal of Applied Ecology* 53: 1667–1675.
- Camíña A. 2011. The effect of wind farms on vultures in northern Spain – fatalities behaviour and correction measures. In: May R, Bevanger K, editors. *Proceedings Conference on Wind Energy and Wildlife Impacts*, 25 May 2011.
- Carrete M, Sánchez-Zapata JA, Benítez JR, Lobón M, and JA Donáza. 2009. Large scale risk-assessment of wind-farms on population viability of a globally endangered long-lived raptor. *Biological Conservation* 142: 2954–2961.
- Carrete M, Sánchez-Zapata JA, Benítez JR, Lobón M, Montoya F, and JA Donázar. 2012. Mortality at wind-farms is positively related to large-scale distribution and aggregation in griffon vultures. *Biological Conservation* 145: 102–108.
- Corman AM, Mendel B, Voigt CC, and S Garthe. 2016. Varying foraging patterns in response to competition? A multicolony approach in a generalist seabird. *Ecology and Evolution* 6: 974–986.
- Cortés-Avizanda A, Blanco G, DeVault, TL, Markandya A, Virani MZ, Brandt J, and Donázar JA 2016. Supplementary feeding and endangered avian scavengers: benefits, caveats, and controversies. *Frontiers in Ecology and the Environment* 14(4): 191–199.
- CSIR (Council for Scientific and Industrial Research). 2015. *Strategic Environmental Assessment for wind and solar photovoltaic energy in South Africa*. CSIR Report Number: CSIR/CAS/EMS/ER/2015/0001/B. Stellenbosch
- CSIR. 2016. *Wind and Solar PV Resource Aggregation Study for South Africa*. Report by the CSIR Energy Centre, Pretoria. [www.csir.co.za/study-shows-abundance-wind-and-solar-resources-south-africa](http://www.csir.co.za/study-shows-abundance-wind-and-solar-resources-south-africa).
- de Lucas M, Ferrer M, and GFE Janss. 2012b. Using wind tunnels to predict bird mortality in wind farms: the case of Griffon vultures. *PLoS One* 7: e48092.
- de Lucas M, Ferrer M, Bechard MJ, and AR Muñoz. 2012a. Griffon vulture mortality at wind farms in southern Spain: Distribution of fatalities and active mitigation measures. *Biological Conservation* 147: 184–189.
- de Lucas M, Janss G, Whitfield D, and M Ferrer. 2008. Collision fatality of raptors in wind farms does not depend on raptor abundance. *Journal of Applied Ecology* 45: 1695–1703.
- DEAT 2004 Cumulative Effects Assessment, Integrated Environmental Management, Information Series 7, Department of Environmental Affairs and Tourism (DEAT), Pretoria. [www.environment.gov.za/sites/default/files/docs/series7\\_cumulative\\_effects\\_assessment.pdf](http://www.environment.gov.za/sites/default/files/docs/series7_cumulative_effects_assessment.pdf)
- Dermody BJ, Tanner CJ, and AL Jackson. 2011. The evolutionary pathway to obligate scavenging in *Gyps* vultures. *PLoS One* 6: e24635.
- Douglas DJT, Follestad A, Langston RHW, and Pearce-Higgins JW. 2012. Modelled sensitivity of avian collision rate at wind turbines varies with number of hours of flight activity input data. *Ibis* 154: 858–861.
- Drewitt AL and RH Langston. 2006. Assessing the impacts of wind farms on birds. *Ibis* 148: 29–42.
- Dupont H, Mihoub JB, Bobbé S, and F Sarrazin. 2012. Modelling carcass disposal practices: implications for the management of an ecological service provided by vultures. *Journal of Applied Ecology* 49: 404–411.
- EWT (Endangered Wildlife Trust). 2011. The Sasol Guide to the Establishment and Operation of Supplementary Feeding Sites for Vultures. Birds of Prey Programme. ([www.ewt.org.za/eBooks/booklets/Vulture%20Restuarant%20booklet.pdf](http://www.ewt.org.za/eBooks/booklets/Vulture%20Restuarant%20booklet.pdf)).
- Ferrer M, de Lucas M, Janss GFE, Casado E, Muñoz AR, Bechard MJ, and CP Calabuig. 2012. Weak relationship between risk assessment studies and recorded mortality in wind farms. *Journal of Applied Ecology* 49: 38–46.

- Ganz HH, Karaoz U, Getz WM, Versfeld W, and EL Brodie. 2012. Diversity and structure of soil bacterial communities associated with vultures in an African savanna. *Ecosphere* 3: 1–18.
- García-Ripollés C and P López-López. 2011. Integrating effects of supplementary feeding, poisoning, pollutant ingestion and wind farms of two vulture species in Spain using a population viability analysis. *Journal of Ornithology* 152: 879–888.
- Gilbert M, Watson RT, Ahmed S, Asim M, and JA Johnson. 2007. Vulture restaurants and their role in reducing diclofenac exposure in Asian vultures. *Bird Conservation International* 17: 63–77.
- Gill JA, Norris K, and WJ Sutherland. 2001. Why behavioural responses may not reflect the population consequences of human disturbance. *Biological Conservation* 97: 265–268.
- Gove B, Langston R, McCluskie A, Pullan J, and I Scrase. 2013. Wind farms and birds: an updated analysis of the effects of wind farms on birds, and best practice guidance on integrated planning and impact assessment. RSPB/BirdLife in the UK. Technical document T-PVS/Inf 15.
- Harel R, Horvitz N, and R Nathan. 2016. Adult vultures outperform juveniles in challenging thermal soaring conditions. *Scientific reports* 6: 27865.
- IFC (International Finance Corporation) 2012. Performance Standards on Environmental and Social Sustainability.
- IFC. 2013. *Good Practice Handbook: Cumulative Impact Assessment and Management: Guidance for the Private Sector in Emerging Markets*. www.ifc.org.
- IFC 2017 *Tafila Region Wind Power Projects Cumulative Effects Assessment*. International Finance Corporation Washington DC.
- Jarvis MJF, Siegfried WR, Currie MH. 1974. Conservation of the Cape Griffon in the Cape Province. *Journal of the Southern African Wildlife Management Association* 4: 29–34.
- Jenkins AR, Smallie JJ and M Diamond. 2010. Avian collisions with power lines: a global review of causes and mitigation with a South African perspective. *Bird Conservation International* 20: 263–278.
- Jenkins AR, Van Rooyen CS, Smallie J, Harris JA, Diamond M, Smit-Robinson HA, and S Ralston. 2015. *Best practice guidelines for assessing and monitoring the impact of wind energy facilities on birds in southern Africa*. BirdLife South Africa and the Endangered Wildlife Trust, Johannesburg.
- Johnston NN, Bradley JE, and KA Otter. 2014. Increased flight altitudes among migrating Golden eagles suggest turbine avoidance at a Rocky Mountain wind installation. *PLoS One* 9: e93030.
- Kaisanlahti-Jokimäki ML, Jokimäki J, Huhta E, Ukkola M, Helle P, and Ollila T. 2008. Territory occupancy and breeding success of the golden eagle (*Aquila chrysaetos*) around tourist destinations in northern Finland. *Ornis Fennica* 85: 2–12.
- Kane A, Jackson AL, Monadjem A, Colomer MA, and A Margalida. 2015. Carrion ecology modelling for vulture conservation: are vulture restaurants needed to sustain the densest breeding population of the African white-backed vulture? *Animal Conservation* 18: 279–286.
- Kane A, Wolter K, Nesar W, Kotze A, Naidoo V, and A Monadjem. 2016. Home range and habitat selection of Cape vultures *Gyps coprotheres* in relation to supplementary feeding. *Bird Study* 16: 387–394.
- Katzner TE, Brandes D, Miller T, Lanzone M, Maisonneuve C, Tremblay JA, Mulvihill R, and GT Merovich Jr. 2012. Topography drives migratory flight altitude of golden eagles: implications for on-shore wind energy development. *Journal of Animal Ecology* 49: 1178–1186.
- Leung DYC and Y Yang. 2012. Wind energy development and its environmental impact: A review. *Renewable and Sustainable Energy Reviews* 16: 1031–1039.
- López-López P, García-Ripollés C, and V Urios. 2013. Food predictability determines space use of endangered vultures: implications for management of supplementary feeding. *Ecological Applications* 24: 938–949.
- Loss S, Will T, and P Marra. 2013. Estimates of bird collision mortality at wind facilities in the contiguous United States. *Biological Conservation* 168: 201–209.
- Marques A, Batalha H, Rodrigues S, Costa H, Pereira M, Fonseca C, Mascarenhas M, and J Bernardino. 2014. Understanding bird collisions at wind farms: an updated review on the causes and possible mitigation strategies. *Biological Conservation* 179: 40–52.
- Martens FR. 2017. *The spatial ecology and roost site selection of fledging Cape Vultures (Gyps coprotheres) in the Eastern Cape, South Africa*. Master of Science Dissertation, Nelson Mandela University.
- Martens FR, Pfeiffer MB, Downs CP and JA Venter. 2018. Post-fledging movement and spatial ecology of the endangered Cape Vulture (*Gyps coprotheres*). *Journal of Journal of Ornithology* <https://doi.org/10.1007/s10336-018-1564-x>
- Martin GR, Portugal SJ, and CP Murn. 2012. Visual fields, foraging and collision vulnerability in Gyps vultures. *Ibis* 154: 1–6.
- Martin GR. 2011. Understanding bird collisions with man-made objects: a sensory ecology approach. *Ibis* 153: 239–254.
- Martínez-Abraín A, Tavecchia G, Regan HM, Jimenez J, Surroca M, and D Oro. 2012. Effects of wind farms and food scarcity on a large scavenging bird species following an epidemic of bovine spongiform encephalopathy. *Journal of Applied Ecology* 49: 109–117.
- Marzluff JM, Vekasy MS, Kochert MN, and K Steenhof. 1997. Productivity of Golden eagles Wearing Backpack Ratio-transmitters. *Journal of Raptor Research* 31: 223–227.
- Masden E. 2015. Developing an avian collision risk model to incorporate variability and uncertainty. *Scottish Marine and Freshwater Science* Vol 6 No 14. Edinburgh: Scottish Government, 43pp. DOI: 10.7489/1659-1
- Monadjem A, Wolter K, Nesar W, and A Kane. 2014. Effect of rehabilitation on survival rates of endangered Cape vultures. *Animal Conservation* 17: 52–60.
- Mundy P, Butchart D, Ledger J, and S Piper. 1992. *The vultures of Africa*. Acorn Books. Randburg.
- Ogada DL, Botha A, and P Shaw. 2015a. Ivory poachers and poison: drivers of Africa's declining vulture populations. *Oryx* 50: 593–596.
- Ogada DL, Shaw P, Beyers RL, Buij R, Murn C, Thiollay JM, Beale CM, Holdo RM, Pomeroy D, Baker N, Krüger SC, Botha A, Virani MZ, Monadjem A, and ARE Sinclair. 2015b. Another continental vulture crisis: Africa's vultures collapsing toward extinction. *Conservation Letters* 9:89–97.
- Ogada DL, Torchin ME, Kinnaird MF, and VO Ezenwa. 2012. Effects of vulture declines on facultative scavengers and potential implications for mammalian disease transmission. *Conservation Biology* 26: 1–8.
- Pagel J, Kritz K, Millsap B, Murphy R, Kershner E, and S Covington. 2013. Bald eagle and Golden eagle mortalities at wind energy facilities in the contiguous United States. *Journal of Raptor Research* 47: 311–315.
- Patricia Mateo-Tomás, Pedro P. Olea, Brian Gratwicke. (2010) Anticipating Knowledge to Inform Species Management: Predicting Spatially Explicit Habitat Suitability of a Colonial Vulture Spreading Its Range. *PLoS ONE* 5:8, pages e12374.
- Pfeiffer MB, 2016. Ecology and Conservation of the Cape vulture in the Eastern Cape Province, South Africa. PhD dissertation, University of KwaZulu-Natal.
- Pfeiffer MB, Venter JA, and CT Downs. 2015. Foraging range and habitat use by Cape vulture *Gyps coprotheres* from the Msikaba colony, Eastern Cape province, South Africa. *Koedoe* 57: 1–11.
- Pfeiffer MB, Venter JA, and CT Downs. 2017. Cliff characteristics, neighbour requirements and breeding success of the colonial Cape Vulture *Gyps coprotheres*. *Ibis* 159 (1): 26–37.

- Phipps WL, Willis SG, Wolter K, and V Naidoo. 2013b. Foraging ranges of immature African white-backed vultures (*Gyps africanus*) and their use of protected areas in Southern Africa. *PLoS One* 8: e52813.
- Phipps WL, Wolter K, Michael MD, MacTavish LM, and RW Yarnell. 2013a. Do power lines and protected areas present a catch-22 situation for Cape vultures (*Gyps coprotheres*)? *PLoS One* 8: e76794.
- Piper SE, Boshoff AF and HA Scott. 1999. Modelling survival rates in the cape griffon *Gyps coprotheres*, with emphasis on the effects of supplementary feeding. *Bird Study* 46: 230–238.
- Piper SE. 2005. Cape vulture. In: Hockey P, Dean W, and P. Ryan. Roberts Birds of Southern Africa. Cape Town: John Voelcker Bird Book Fund.
- Ralston-Paton S, Smallie J, Pearson A, and Ramalho R. 2017. Wind energy's impacts on birds in South Africa: A preliminary review of the results of operational monitoring at the first wind farms of the Renewable Energy Independent Power Producer Procurement Programme in South Africa. BirdLife South Africa Occasional Report Series No. 2. BirdLife South Africa, Johannesburg, South Africa.
- Reid T, Kruger S, Whitfield DP, and A Amar. 2015. Using spatial analyses of bearded vulture movements in southern Africa to inform wind turbine placement. *Journal of Applied Ecology* 52: 881–892.
- Retief EF, Diamond M, Anderson MD, Smit HA, Jenkins A, Brooks M, and R Simmons. 2013. Avian wind farm sensitivity map for South Africa: criteria and procedures used. Unpublished Report, Endangered Wildlife Trust-BirdLife South Africa, Johannesburg.
- Rushworth I and S Krüger. 2014. Wind farms threaten southern Africa's cliff-nesting vultures. *Ostrich* 85: 13–23.
- Rydell J, Bogdanowicz W, Boonman A, Pettersson S, Suchecka E, and JJ Pomorski. 2016. Bats may eat diurnal flies that rest on wind turbines. *Mammalian Biology – Zeitschrift für Säugetierkunde* 81: 331–339.
- Saidur R, Rahim NA, Islam MR, and KH Solangi. 2011. Environmental impact of wind energy. *Renewable and Sustainable Energy Reviews* 15: 2423–2430.
- Schabo D, Heuner S, Neethling M, Rösner S, Uys R, and N Farwig. 2016. Long-term data indicates that supplementary food enhances the number of breeding pairs in a Cape vulture *Gyps coprotheres* colony. *Bird Conservation International* 27:140–152.
- Scottish Natural Heritage. 2009. Guidance note. Guidance on methods for monitoring bird populations at onshore wind farms. Scottish Natural Heritage
- Scottish Natural Heritage. 2012. Assessing the cumulative impact of onshore wind energy development. SNH Guidance.
- Scottish Natural Heritage. 2013. Recommended Bird Survey Methods to Inform Impact Assessment of Onshore Wind Farms. SNH Guidance. Scottish Natural Heritage.
- Smallwood KS and C Thelander. 2008. Bird mortality in the Altamont Pass Wind Resource Area, California. *Journal of Wildlife Management* 72: 215–223.
- Spiegel O, Harel R, Getz W, and R Nathan. 2013. Mixed strategies of griffon vultures' (*Gyps fulvus*) response to food deprivation lead to a hump-shaped movement pattern. *Movement Ecology* 1: 1–12.
- Strickland M, Arnett EB, Erickson WP, Johnson DH, Johnson GD, Morrison ML, Shaffer JA, and Warren-Hicks W. 2011. *Comprehensive guide to studying wind energy/wildlife interactions*. Washington, D.C., USA: Prepared for the National Wind Coordinating Collaborative.
- Tarboton W and D Allan. 1984. *The status and conservation of birds of prey in the Transvaal*. Transvaal Museum, Pretoria.
- Tellería JL. 2009. Overlap between wind power plants and Griffon *Gyps fulvus* in Spain. *Bird Study* 56:2, 268–271, DOI: 10.1080/00063650902792056
- USFWS 2012. US Fish and Wildlife Service land-based wind energy guidelines. OMB. U.S. Fish and Wildlife Services. Arlington, VA.
- USFWS. 2013. *Eagle Conservation Plan Guidance. Module 1-Land-based Wind Energy Version 2*, US Fish and Wildlife Service, Division of Migratory Bird Management Branch of Policy, Permits and Regulations, Arlington, Virginia, USA.
- Vasilakis DP, Whitfield DP, Schindler S, Poirazidis KS, and Kati V. 2016. Reconciling endangered species conservation with wind farm development: Cinereous vultures (*Aegypius monachus*) in south-eastern Europe. *Biol Conserv.* 196: 10–17.
- Venter JA, Martens FR, and Wolter K. 2018. Recommended conservation buffer sizes derived from movement data of breeding adult Cape (*Gyps coprotheres*) in South Africa. Nelson Mandela University unpublished report.
- Verdoorn GH. 1997. Vulture restaurants as a conservation tool. In: Boshoff, AF, Anderson, MD, & Borello, WD. (Eds). *In the 21<sup>st</sup> century: Proceedings of a workshop on vulture research and conservation in southern Africa*. Vulture Study Group, Johannesburg. pp. 119–122
- Verdoorn GH. 2004. in the Northwest Province of South Africa. In: Monadjem, A., Anderson, MD, Piper, S.E. & Boshoff, AF. (Eds). *The vultures of Southern Africa – Quo Vadis? Proceedings of a workshop on vulture research and conservation in southern Africa*. Birds of Prey Working Group, Johannesburg: 100–105
- Vernon C. 1998. The Cape Vulture at Colleywobbles: 1977–1997. *Ostrich* 70: 200–202.
- Whitfield D. 2009. Collision avoidance of golden eagles at wind farms under the 'Band' collision risk model. Report from Natural Research to Scottish Natural Heritage, Banchory, UK.
- Wolter K and Hirschauer MT. 2016. *Southern African vulture breeding report 2016: Cape, African White-backed and Hooded Vulture breeding surveys*. VulPro.
- Wolter K, Nesar W, and Hirschauer MT. 2015. *Protocols for mass capturing, handling, and fitting tracking devices and patagial (wing) tags on vultures (version 2.0)*. From: [www.vulpro.com/wp-content/uploads/2016/08/Wolter-et-al.-Protocols-for-mass-capture-handling-and-fitting-tracking-devices-on-vultures-V2.0-Dec-2015.pdf](http://www.vulpro.com/wp-content/uploads/2016/08/Wolter-et-al.-Protocols-for-mass-capture-handling-and-fitting-tracking-devices-on-vultures-V2.0-Dec-2015.pdf).
- Wolter K, Piper SE, Neethling M, Veronon CJ, Botha A, Boshoff A, Borello WD, Mundy PJ, and Nesar W 2011. Cape Vulture (*Gyps coprotheres*): Breeding colony conservation & monitoring protocol update (2011) (Available at [www.vulpro.com/wp-content/uploads/2016/08/Cape-Griffon-Vulture-colony-monitoring-Protocol-KW.pdf](http://www.vulpro.com/wp-content/uploads/2016/08/Cape-Griffon-Vulture-colony-monitoring-Protocol-KW.pdf))
- Wolter K, Underhill LG, López Gómez M, and Brooks M. 2017. Bird distribution dynamics 6 – Cape Vulture *Gyps coprotheres* in South Africa, Lesotho and Swaziland. *Biodiversity Observations* 8.4: 1–11.
- World Bank Group. 2015. Environmental, health, and safety guidelines for wind energy. (Downloaded from: [www.ifc.org/ehsguideline](http://www.ifc.org/ehsguideline)).

## ACKNOWLEDGEMENTS

These guidelines were drafted following extensive consultation and valuable input from experts on the species including: Alvaro Camiña, Dr Craig Whittington-Jones (Gauteng Department of Agriculture and Rural Development), Christiaan Brink (University of Cape Town), Constant Hoogstad (EWT), David Allan (Durban Natural History Museum), Dr Jan Venter (Nelson Mandela University), Kerri Wolter and Kate Webster (Vulpro), Kevin Shaw (CapeNature), Prof Peter Mundy (National University of Science and Technology, Bulawayo, Zimbabwe) and Dr Rob Simmons (Birds and Bats Unlimited). We appreciate the time they all took to share their knowledge and insights. We are particularly grateful to Kerri Wolter (Vulpro), Dr Pfeiffer, Dr Venter and Francis Martens (Nelson Mandela University), and Dr Louis Phipps, for providing additional information to support the buffer recommendations.

We are always grateful for the on-going support and guidance of the Birds and Renewable Energy Specialist Group who reviewed drafts of the document (Andrew Jenkins, Andrew Pearson, Alvaro Camiña, Dr Birgit Erni, Chris van Rooyen, Dr Craig Whittington-Jones, Dr David Allan, Dr Hanneline Smit-Robinson, Jon Smallie, Kevin Shaw, Lourens Leeuwner, Michael Brooks, Prof Phoebe Barnard, Prof Peter Ryan and Dr Theoni Photopoulou). Our gratitude also goes to all the other stakeholders who provided comments on various drafts of the guidelines, particularly the South African Wind Energy Association and Dr Lizanne Roxburgh (Endangered Wildlife Trust) who provided extensive comment.

BirdLife South Africa's work towards renewable energy that is developed in harmony with nature is made possible through sponsorship from Investec Corporate and Institutional Banking. We are grateful for their ongoing support and encouragement.

## USEFUL CONTACTS

### BirdLife South Africa

Samantha Ralston-Paton: Birds and Renewable Energy Project Manager, 083 6733948, [energy@birdlife.org.za](mailto:energy@birdlife.org.za)

Dr Hanneline Smit-Robinson: Terrestrial Bird Conservation Programme Manager, 011 789 1122, [conservation@birdlife.org.za](mailto:conservation@birdlife.org.za)

### Cape Nature

Kevin Shaw: ornithologist, 021 866 8000, [shawka@capenature.co.za](mailto:shawka@capenature.co.za)

### Durban Natural Science Museum

David Allan: 031 3224214, [David.Allan@durban.gov.za](mailto:David.Allan@durban.gov.za)

### Eastern Cape Parks & Tourism Agency

Dr Thabiso Mokotjomela: 043 492 0730, [Thabiso.Mokotjomela@ecpta.co.za](mailto:Thabiso.Mokotjomela@ecpta.co.za)

### Department of Economic Development & Environmental Affairs

Alan Southwood: 041 508-5813, [Alan.Southwood@deaet.ecape.gov.za](mailto:Alan.Southwood@deaet.ecape.gov.za)

### Endangered Wildlife Trust

Lourens Leeuwner: Wildlife and Energy Programme Manager, 021 799 8460, [lourensl@ewt.org.za](mailto:lourensl@ewt.org.za)

Dr Gareth Tate: Bird of Prey Programme, 021 799 8459, [garetht@ewt.org.za](mailto:garetht@ewt.org.za)

### Ezemvelo KwaZulu-Natal Wildlife

Dr Sonja Kruger: 033 2391513, [sonja.krueger@kznwildlife.com](mailto:sonja.krueger@kznwildlife.com)  
Brent Coverdale: 033 8451449, [Brent.Coverdale@kznwildlife.com](mailto:Brent.Coverdale@kznwildlife.com)

### Free State Economic Development, Tourism & Environmental Affairs

Brian Colahan: ornithologist, 051 4004773, [colahan@detea.fs.gov.za](mailto:colahan@detea.fs.gov.za)

### Raptor Rescue

Ben Hoffman: 076 724 6846, [kznraptorrescue@gmail.com](mailto:kznraptorrescue@gmail.com)

### Dr Morgan Pfeiffer

United States Department of Agriculture, Wildlife Services, National Wildlife Research Center & Research Associate with School of Natural Resource Management, George Campus, Nelson Mandela University, [Morgan.B.Pfeiffer@aphis.usda](mailto:Morgan.B.Pfeiffer@aphis.usda)

### Dr Jan Venter

School of Natural Resource Management, George Campus, Nelson Mandela University, [Jan.Venter@mandela.ac.za](mailto:Jan.Venter@mandela.ac.za)

### VulPro (Vulture Programme)

Kerri Wolter: 082 8085113, [kerri.wolter@gmail.com](mailto:kerri.wolter@gmail.com)  
Kate Webster: 045 839 4716, [kate@lcom.co.za](mailto:kate@lcom.co.za)

## Savannah Public Process

---

**From:** Savannah Public Process  
**Sent:** Wednesday, December 2, 2020 8:39 PM  
**To:** 'HO de Waal'  
**Cc:** Francois Havenga  
**Subject:** RE: Basic Assessment Process

Dear Prof De Waal,

Please receive herewith our acknowledgement of your letter dated 02 December 2020 in which your company's services are offered for removal / clearing the development sites of the invader alien spiny cacti.

The correspondence has been forwarded to the applicant for their information.

Kind regards,

---

**From:** HO de Waal [REDACTED]  
**Sent:** Wednesday, December 2, 2020 11:28 AM  
**To:** Savannah Public Process <publicprocess@savannahsa.com>  
**Cc:** Francois Havenga [REDACTED]  
**Subject:** Basic Assessment Process

Hallo dear Me Nicolene Venter

Attached please find a letter for your attention.

Regards HO

--

Prof HO de Waal

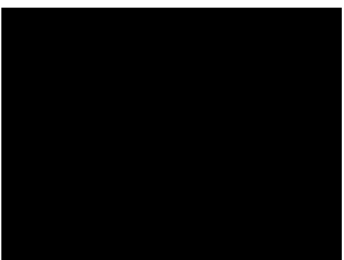



2 December 2020

Me Nicolene Venter  
Savannah International  
[publicprocess@savannahsa.com](mailto:publicprocess@savannahsa.com)

Dear Me Venter

**Basic Assessment Process  
Development of a cluster of renewable energy facilities between Somerset East and  
Makhanda  
November 2020**

We have received information (two documents) from a farmer about the envisaged projects referred to above.

Alien invader cacti, predominantly the spiny *Opuntia ficus-indica* and *O. engelmannii* have infested to various degrees the Eastern Cape Province.

Our Company, *Spiny Cactus Pear Processing (Pty) Ltd* has been involved in preparing the construction sites for the erection of a wind turbine project near Bedford. We were specifically engaged to clear the invader alien spiny cacti from the access roads and platforms stands for the contractors to erect the wind turbine towers and auxiliary facilities.

Considerable competency and expertise have been developed in harvesting and processing alien spiny invader plants as livestock feed.

Attached please find a document providing some background in this regard.

We assume our expertise will be required to implement the envisaged projects.

Please advise how and with whom we can engage to participate.

Yours sincerely



Name: HO de Waal  
Director: Spiny Cactus Pear Processing (Pty) Ltd



## Savannah Public Process

---

**From:** Savannah Public Process  
**Sent:** Sunday, December 6, 2020 8:42 AM  
**To:** 'Francois Havenga'  
**Subject:** RE: F.Havenga  
**Attachments:** SE2602 Wind Relic BID (Afr).pdf; SE2602-WindRelic RegCommForm-FINAL.pdf

Beste Francois,

Dankie vir jou e-pos van 03 Desember 2020.

Die Basiese Evalueringsprosesse vir die voorgestelde wind- en sonplaasontwikkelings in die Makhanda en Somerset-Oos omgewing het so pas 'n aanvang geneem –die Agtergrondinligtingsdokument wat tegniese en proses inligting rakende die voorgestelde ontwikkelings bevat is aangeheg vir jou inligting. Graag versoek ons jou om formeel te registreer dan sal jy op hoogte wees hoe die projek-aansoek vir omgewingsmagtiging vorder.

Savannah Environmental is aangestel om die omgewingsimpakstudie te doen en is nie deel van die konstruksie / operasionele fase van die projekte nie.

Soos genoem, die studies het pas 'n aanvang geneem en die projekte het nog nie omgewingsmagtiging ontvang nie.

Jou e-pos is aan die ontwikkelaar gestuur.

Vriendelike groete,

---

**From:** Francois Havenga [REDACTED]  
**Sent:** Thursday, December 3, 2020 7:33 PM  
**To:** Savannah Public Process <publicprocess@savannahsa.com>  
**Subject:** F.Havenga

Goeie dag Nicolene,

Jammer ek kon nie jou oproep gister ontvang nie. Die sein op terrein is baie swak.

Ek het met Andries Troskie gesels en hy het genoem dat julle besig is met werk aan die groep windplase Wes van Middleton.

Soos ek kortliks aan Mnr Chris Buchner genoem het, is ek tans werksaam op die Golden Valley Wind Energy Facility as EPC Site Civil Engineer vir Goldwind Africa. Die projek nader sy einde en ek wil hoor of ek die ontwikkelaar en/of kontrakteur(s) se kontakbesonderhede by u kan kry. Ons projekspan is almal op kontrakbasis aangestel en die kontrakte verstryk in Maart 2021. Indien dit moontlik is, sal ek graag my CV by die HR Departement wou uitkry, sodat ek aansoek kan doen vir 'n moontlike pos.

Aangesien ek woonagtig is in Somerset Oos, is ek redelik naby aan die verskillende ontwikkelings wat Dries Troskie aan my genoem het. Sy plaas is blykbaar deel vand Hamlet Wind Farm, maar die ander aangrensende ontwikkelings en selfs die in Grahamstad, is bereikbaar naby.

Indien ons kan gesels, sal ek baie waardeer.

Beste groete,

Francois Havenga  
[REDACTED]



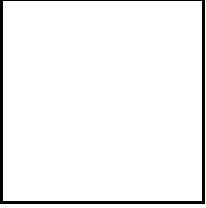

---

This email has been checked for viruses by Avast antivirus software.  
[www.avast.com](http://www.avast.com)

## Savannah Public Process

---

**From:** Savannah Public Process  
**Sent:** Friday, December 11, 2020 4:53 AM  
**To:** charles hanyani; Brenda Ton  
**Subject:** RE: Self Catering Cottages

<b>Tracking:</b>	<b>Recipient</b>	<b>Delivery</b>	<b>Read</b>
	charles hanyani		
	Brenda Ton	Delivered: 12/11/2020 4:53 AM	Read: 12/11/2020 7:30 AM

Dear Charles,

Thank you for sharing the information regarding your self catering units facilities with us.

I am forwarding it to our Office Manager who deals with staff members accommodation bookings.

Kind regards,

---

**From:** charles hanyani [REDACTED]  
**Sent:** Thursday, December 10, 2020 9:46 PM  
**To:** Savannah Public Process <publicprocess@savannahsa.com>  
**Subject:** Self Catering Cottages

Dear Nicole Venter

I hereby write to you as an owner of two neat self catering units that are available in Adelaide. The units are in a secure location in the central town of Adelaide. Each unit consists of bedroom, a small lounge, a kitchen and a bathroom with a shower and toilet.

Please assist if there are any Windfarm projects which would want to utilize our cosy accommodation.

These units are located on my property, which has a 3-bedroomed house that I am willing to rent out. The main house is fully furnished

Feel free to contact me on [REDACTED]

Regards  
Charles

## Savannah Public Process

---

**From:** Savannah Public Process  
**Sent:** Thursday, December 17, 2020 11:18 AM  
**To:** Gwen Theron  
**Cc:** Michael van Staden; Ronald Baloyi  
**Subject:** Proposed Wind Farm Developments in the Eastern Cape:  
**Attachments:** LEAP Environment-THERON Dr Gwen (2020.12.15).pdf; SE2602-WindRelic RegCommForm-FINAL.pdf; VAN STADEN Michael (2020.12.15).pdf; WRSA-YORK Richard (2020.12.15).pdf; KWANDWE-SHOLTO-DOUGLAS Angus.pdf; HEYNEKE G (2020.12.15).pdf; TALIS HOLDINGS-MOGASHOA Tebogo (2020.12.15).pdf; ENGELBRECHT Colin (2020.12.15).pdf; JURGENS Thinus (2020.12.15).pdf

<b>Tracking:</b>	<b>Recipient</b>	<b>Delivery</b>
	Gwen Theron	
	Michael van Staden	
	Ronald Baloyi	Delivered: 12/17/2020 11:18 AM

Dear Dr Theron,

Thank you for your e-mail below requesting registration of yourself and other stakeholders on the proposed project's database.

Attached for your perusal is the proof of the registrations (yourself and the other I&APs listed in your e-mail below). Please note that Mr Angus Sholto-Douglas is already a registered I&AP.

To register [REDACTED] on the project's database we need a name and surname please – would you kindly provide the information as this e-mail address has not yet been captured on the project's database.

At this stage it is envisaged that the BARs will be made available for review and comment in the new year. As registered I&APs, all will be notified of the availability of the BARs for your review and comments.

Dr Theron, it is required that yourself and those I&APs that have been registered as per your e-mail below, complete the attached registration and comment form to ensure that the relevant parties are registered to the applicable projects.

Please do not hesitate to contact us should you require any additional information at this stage.

Kind regards,

---

**From:** Gwen Theron [REDACTED]  
**Sent:** Tuesday, December 15, 2020 9:32 AM  
**To:** Savannah Public Process <publicprocess@savannahsa.com>  
**Cc:** Michael van Staden [REDACTED]  
**Subject:** FW: Proposed Wind Farm Developments in the Eastern Cape

Dear Nicolene,

Please register me and the persons listed below as interested and Affected parties for this application.

1. Michael van Staden [REDACTED]  
VAN STADEN & BOOYSEN INC.

4 IBIS PLACE, MEYERSDAL EXT 21.  
[REDACTED]

Our website: [www.vsbattorneys.co.za](http://www.vsbattorneys.co.za)

2. Richard York [REDACTED]  
The President-WRSA-Mr Gerhard Heynecke  
Deputy President-WRSA-Mr Colin Engelbrecht  
Director-High Level Affairs-Mr Tebogo Mogashoa  
CEO-WRSA-Mr Richard York  
EC Provincial Chair-Mr Thinus Jurgens

**Richard York - Chief Executive Officer**



*"Governed by nature,  
driven by passion,  
focussed on results"*

[REDACTED]

3. **ANGUS SHOLTO-DOUGLAS**  
MANAGING DIRECTOR

[REDACTED] Web: [www.kwandwe.com](http://www.kwandwe.com)



Heatherton Towers, Kwandwe Private Game Reserve, Fort Brown District, Eastern Cape, 6140, South Africa

Also

[REDACTED]  
Tebogo Mogashoa [REDACTED]

[REDACTED]  
Colin Engelbrecht [REDACTED]  
Thinus Jurgens [REDACTED]  
[REDACTED]

Please acknowledge the request

I will also appreciate it if you can give me a schedule or time frame for the submission of comments to the process.  
Much appreciated.

Dr. Gwen Theron



**LEAP**

Dr. Gwen Theron • PrLArch No 97082

Landscape Architect • Environmental Planner

Imbrilinx cc 2010/089810/23 [REDACTED]



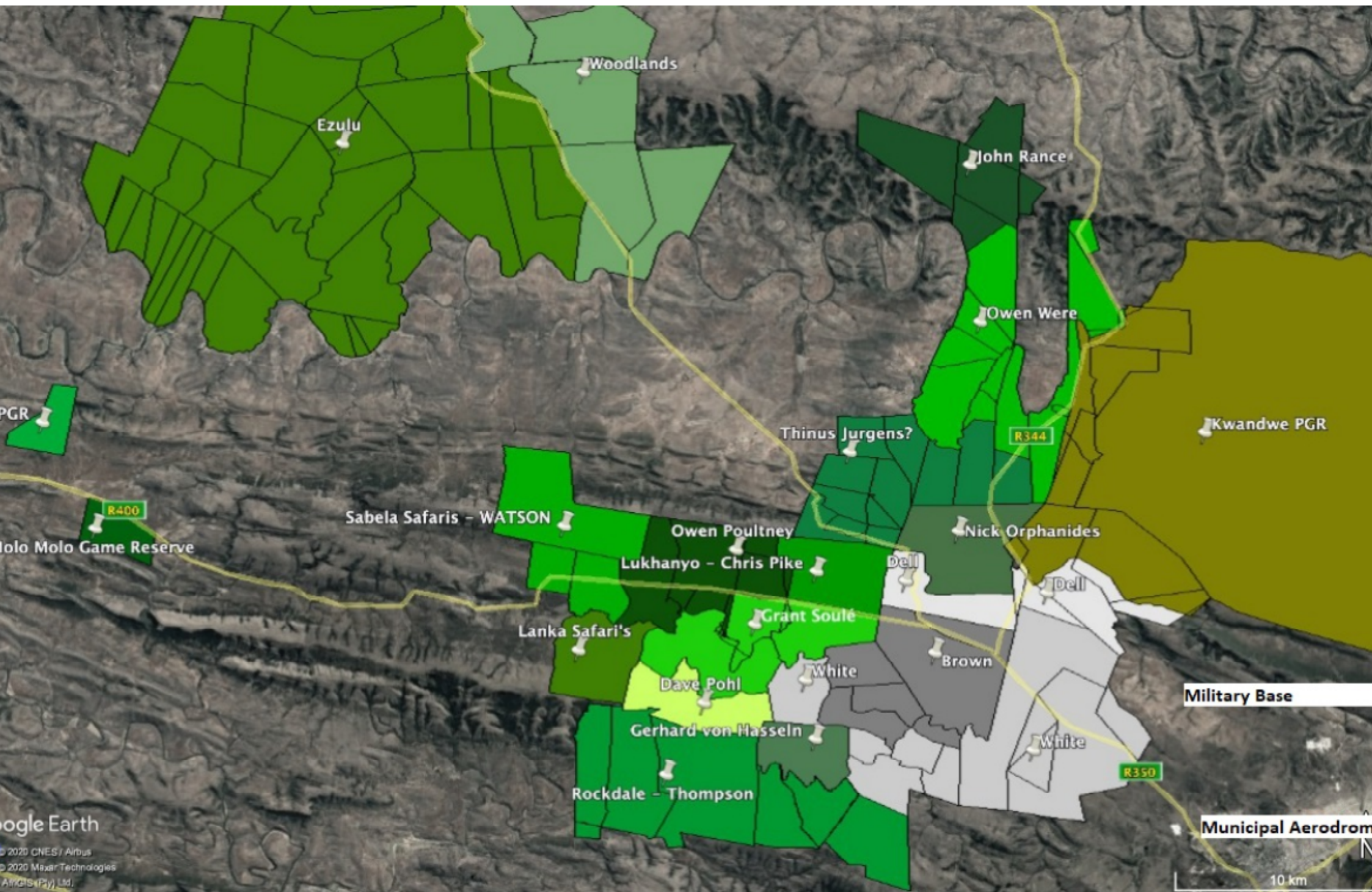

## Savannah Public Process

---

**From:** Gerhard Kapp [REDACTED]  
**Sent:** Thursday, December 17, 2020 9:44 AM  
**To:** Savannah Public Process  
**Cc:** Ronald Baloyi  
**Subject:** Re: Public invitation - Possible Renewable Energy Projects  
**Attachments:** 1.png; 0.gif

Thank you for your response.  
I appreciate it immensely.  
All the best for the festive season and New Year.

Best regards

Gerhard Kapp

On Thu, 17 Dec 2020, 08:21 Savannah Public Process, <[publicprocess@savannahsa.com](mailto:publicprocess@savannahsa.com)> wrote:

Dear Gerhard,

Thank you for your e-mail below.

Please be informed that it is forwarded to the applicant for their perusal.

Kind regards,



t: 011 656 3237  
f: 086 684 0547



**Nicolene Venter**

Public Process

e: [publicprocess@savannahsa.com](mailto:publicprocess@savannahsa.com)  
c: +27 (0) 60 978 8396

[SAWEA Award for Leading Environmental Consultant on Wind Projects in 2013 & 2015](#)

---

**From:** Gerhard Kapp <[REDACTED]>  
**Sent:** Tuesday, December 15, 2020 10:16 PM  
**To:** Savannah Public Process <[publicprocess@savannahsa.com](mailto:publicprocess@savannahsa.com)>  
**Subject:** Re: Public invitation - Possible Renewable Energy Projects

Good afternoon Nicolene

Glad to hearing from you today.

This mail is based on a notification for upcoming events at Kommadagga , as per your notification, in the region of the Easter Cape

There is an opportunity to view more farm land, in the Kommadagga region, which I think might be of interest to you.

Therefore , I want to invite you and your development Team to investigate the possibilities for a possible wind farm project.

We can arrange accommodation, if need be , however it is subjected to confirmation in advance by email and phone call.

I'm looking forward to hearing from you, and we'll be in touch.

Thank you

Kind regards

Gerhard. Kapp





**BASIC ASSESSMENT PROCESSES AND PUBLIC PARTICIPATION PROCESS**

**DEVELOPMENT OF A CLUSTER OF RENEWABLE ENERGY FACILITIES BETWEEN SOMERSET EAST AND MAKHANDA, EASTERN**

November 2020

Return completed registration and comment form to: **Nicolene Venter** or **Ronald Baloyi** of **Savannah Environmental**

Phone: 011 656 3237 / Mobile (incl. 'please call me'): 060 978 8396 / Fax: 086 684 0547

E-mail: publicprocess@savannahsa.com Postal Address: PO Box 148, Sunninghill, 2157

Your registration as an interested and/or affected party will be applicable for this project only and your contact details provided are protected by the PoPI Act of 2013

**Please provide your complete contact details:**

Name &	Louise Buswell	
Surname:	Kwandwe	
Organisation:		
Designation:		
Postal Address:		
Telephone:	fax:	
Mobile:		
E-mail:		

**Please indicate on which project/s you would like to register as an interested and affected party (I&AP)?**  
(please tick the relevant box)

**Wind Farms**

Hamlet	Rippon	Redding	Aeolus	Wind Garden	<input checked="" type="checkbox"/>	Fronteer	<input checked="" type="checkbox"/>
--------	--------	---------	--------	-------------	-------------------------------------	----------	-------------------------------------

**Solar Energy Facilities**

Solaris Fields	Sun Garden
----------------	------------

**REDZ 3 Power Grid Corridor 400MTS**

Grid Connection Corridor	<input checked="" type="checkbox"/>
--------------------------	-------------------------------------

**Note:** In terms of EIA Regulations, 2014, as amended, Regulation 43(1), you are required to register as an I&AP to receive further correspondence regarding the Basic Assessment process and comment on the Reports being made available for comments, and to disclose any direct business, financial, personal or other interest which you may have in the approval or refusal of the application (add additional pages if necessary):

Please list your comments regarding the Environmental Impact Assessment process (add additional pages if necessary):

Socio Economic impact on local communities  
Visual impact on the natural heritage area  
Long term ecological impact of proposed projects

**Please provide contact details of any other persons who you regard as a potential interested or affected party:**

Name & Surname:

Postal Address:

Telephone:

Mobile:

E-mail:

## Savannah Public Process

---

**From:** Savannah Public Process  
**Sent:** Wednesday, February 24, 2021 8:25 AM  
**To:** Chad Comley  
**Subject:** Eastern Cape Development of a Cluster of Renewable Energy Facilities

Hi Chad,

In response to your e-mails dated 16 & 17 February 2021, please be informed that queries / requests relating to company information and/or matters do not fall within the ambit of the Basic Assessment processes being undertaken for the Eastern Cape Renewable Energy Facility Clusters.

The information requested can be obtained from the Companies and Intellectual Property Commission (CIPC).

Please do not hesitate to submit any further comments that you may have relating to the environmental studies being undertaken for these proposed developments.

Kind regards,



t: +27 (0)11 656 3237  
f: +27 (0) 86 684 0547

**Nicolene Venter**

Public Participation & Social  
Consultant

e: [nicolene@savannahsa.com](mailto:nicolene@savannahsa.com)  
c: +27 (0) 83 377 9112

SAWEA Award for Leading Environmental Consultant on Wind Projects in 2013 & 2015

---

**From:** Savannah Public Process  
**Sent:** Thursday, February 18, 2021 7:23 AM  
**To:** Chad Comley [REDACTED]  
**Subject:** RE: Se2602 development of a cluster of renewable energy facilities

Hi Chad,

Please receive herewith acknowledgement of your e-mail below.

Your request for information has been forwarded to the project team for a response.

Kind regards,



t: +27 (0)11 656 3237  
f: +27 (0) 86 684 0547

**Nicolene Venter**  
**Public Process**

e: [Publicprocess@savannahsa.com](mailto:Publicprocess@savannahsa.com)  
c: +27 (0)60 978 8396

SAWEA Award for Leading Environmental Consultant on Wind Projects in 2013 & 2015

---

**From:** Chad Comley [REDACTED]  
**Sent:** Wednesday, February 17, 2021 12:21 PM  
**To:** Savannah Public Process <[publicprocess@savannahsa.com](mailto:publicprocess@savannahsa.com)>  
**Subject:** Se2602 development of a cluster of renewable energy facilities

Hi Nicolene

This is to confirm Wind Relic and Dimsum partnership  
From yesterday question

Pls could you also supply me with answer to the following questions

1) who is the project manager of the clusters of renewable energy facilities

2) who are the directors of wind relic and all the applicants company's

3) could you pls provide me with the shareholders certificates in wind relic  
And all the other applicant companies

It would be appreciated if you could get back to me with a response as soon as possible  
Maybe by the end of the week

Could you also acknowledge receipt of mail  
And yesterdays mail

Kind regards  
Chad Comley



WIND RELIC is Dimsum Energy's privately-owned partner in the current development of two significant wind projects in the Eastern Cape – the first, just South of Somerset East and the second, just West of Grahamstown. Once completed, these two utilities will combine to

## Savannah Public Process

---

**From:** Savannah Public Process  
**Sent:** Tuesday, March 2, 2021 1:18 PM  
**To:** Estelle Pillay  
**Subject:** RE: Development of a cluster of renewable energy facility between Somerset East and Grahamstown, Eastern Cape.

Dear Estelle,

Thank you for your e-mail below.

Please be informed that Savannah Environmental is the appointed Environmental Assessment Practitioner undertaking the various environmental studies for the Basic Assessment process and are not associated with or responsible for the Town Planning application referred to in your e-mail below. Also, we are not part of the procurement / construction phase of these projects.

Herewith the response to your enquiries below:

- EIA Consultant: Savannah Environmental
- Town Planners: Not part of our scope of work
- Client: Information for all the project are included in the Background Information Document (available on our website)
- Private Developer: Yes

You are most welcome to access the Background Information Document and any other project related information from our website at: <https://savannahsa.com/public-documents/energy-generation/eastern-cape-cluster-of-renewable-energy-facilities/>.

Please be informed that you are registered on the projects' databases and will receive all future environmental authorization process notifications regarding these applications.

Kind regards,



t: +27 (0)11 656 3237  
f: +27 (0) 86 684 0547

Nicolene Venter  
**Public Process**

e: [Publicprocess@savannahsa.com](mailto:Publicprocess@savannahsa.com)  
c: +27 (0)60 978 8396

SAWEA Award for Leading Environmental Consultant on Wind Projects in 2013 & 2015

---

**From:** Estelle Pillay [REDACTED]  
**Sent:** Monday, February 22, 2021 11:09 AM  
**To:** Savannah Public Process <publicprocess@savannahsa.com>  
**Subject:** Re: Development of a cluster of renewable energy facility between Somerset East and Grahamstown, Eastern Cape.

Good Day Nicolene,

I hope you are well. I wonder if you could please assist me with a development. I came across in a Town

Planning Notice for the development of a cluster of renewable energy facility between Somerset East and Grahamstown, Eastern Cape.

I do not have any objections, I am an interested party and I wanted to know if you would please provide me with the details of the client or any professionals involved.

I am interested in following the progress of the various stages of this development from the town planning stages, through design and construction. I follow all the building and construction projects in South Africa and Africa right from the conceptual stages up until construction is complete.

EIA Consultant: ?  
Town Planners: ?  
Client: ?  
Private Developer: ?

Please can you provide me with the copy of the Background Information Document for this development?

Any information would be greatly appreciated. Looking forward to your response.

--

Kind regards,



Our Business is about growing Yours. Find out Who is building What, When & Where.

## Estelle Pillay | Regional Content Researcher Projects

[www.L2B.co.za](http://www.L2B.co.za)



**L2B: Comprehensive, Online Business Leads for the Construction Industry.**

---

This e-mail is for the intended addressee only. If you have received it in error, please notify the sender by e-mail. View our Privacy Policy [here](#).