

BARLERIA PV (PTY) LTD

**TRAFFIC IMPACT STUDY FOR THE TRANSPORTATION
OF SOLAR ENERGY EQUIPMENT TO THE BARLERIA
SOLAR ENERGY FACILITY NEAR LICHTENBURG,
NORTH WEST PROVINCE**

34503.00C-REP-003-01

TRAFFIC IMPACT STUDY

DECEMBER 2021

PREPARED FOR:

BARLERIA PV (PTY) LTD
101 BLOCK A, WEST QUAY BUILDING
7 WEST QUAY ROAD
WATERFRONT
CAPE TOWN
8000

PREPARED BY:



**BVi CONSULTING ENGINEERS WESTERN
CAPE (PTY) LTD**
BLOCK B2, EDISON SQUARE
C/O EDISON WAY AND CENTURY AVENUE
CENTURY CITY
7441

EXECUTIVE SUMMARY

BVi Consulting Engineers Western Cape (Pty) Ltd was appointed by *Barleria PV (Pty) Ltd* to conduct a Traffic and Transportation Study for the proposed development of an up to 75 MW photovoltaic (PV) solar energy plant near Lichtenburg, in the North West Province. The Barleria PV facility requires Environmental Authorisation (EA) from the National Department of Forestry, Fisheries and the Environment (DFFE) subject to the completion of a full Scoping and Environmental Impact Assessment (S&EIA), as prescribed in the 2014 EIA Regulations. This specialist study forms part of the (EIA).

The following is summarized in terms of the Traffic and Transportation Study:

- The existing traffic volumes on the transportation routes were sourced from permanent count stations only, as this is the most reliable and accurate data that was available.
- The impact of the construction trip generation, on the predicted 2023 traffic volumes near the town of Lichtenburg and along the transportation routes, are expected to be low. No mitigation measures (upgrading of existing intersections) will be necessary.
- The photovoltaic (PV) components will be delivered to site from two possible ports, either from Saldanha (1420 km) or from Durban (855 km).
- All construction materials and PV components will be transported by truck. Transformer and substation components will be transported as abnormal loads.
- The access point to the site is situated off Regional Road R505. The formalisation of this access point, to the required standard, will in all probability be a requirement as part of the wayleave approval of *Ditsobotla Local Municipality* and *North West: Department of Public Works and Roads*.
 - This will mitigate the destructive impact of repetitive heavy turning vehicles on the public road pavement.
- Adequate traffic accommodation signage must be erected and maintained on either side of the access, on the R505, throughout the construction period of the project, in accordance with the *South African Road Traffic Signs Manual, Vol 2, May 2012*.
- The direct impact and significance of the Barleria solar energy facility (SEF) is considered low negative and low positive for the traffic and community parameters, respectively.
- The cumulative impact and significance of the development of other proposed PV facilities in the vicinity (incl. Barleria SEF) are considered low negative and medium positive impacts, i.e. -22 and +45.
 - Traffic will be negatively impacted, while the construction of the solar energy facilities and related infrastructure.
 - It is unlikely that the other six (6) solar energy facilities will be constructed within the exact same period as the Barleria SEF but overlapping of construction periods is a possibility.

The development of the Barleria PV solar energy facility on Portions 1, 9 and 10 of the farm Houthaalboomen No. 31 in the North West Province, can be supported from a traffic perspective.

ISSUE AND REVISION RECORD

QUALITY APPROVAL

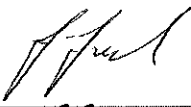
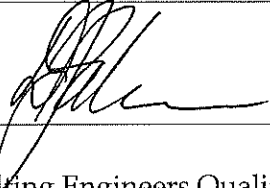
	CAPACITY	NAME	SIGNATURE	DATE
By author	Engineer	Jacques Nel Pr Tech Eng: 200770131		09/12/2021
Approved by Design Centre Leader	Director	Dirk van der Merwe Pr Eng: 20120186		09/12/2021

This report has been prepared in accordance with BVi Consulting Engineers Quality Management System. BVi Consulting Engineers is ISO 9001: 2015 registered and certified by NQA Africa.



REVISION RECORD

REVISION NUMBER	OBJECTIVE	CHANGE	DATE
0	Issue to Client for information	None	15/11/2021
1	Issue to Client	Minor	09/12/2021

TABLE OF CONTENTS

EXECUTIVE SUMMARY	ii
ISSUE AND REVISION RECORD.....	iii
CHAPTER 1 INTRODUCTION.....	1
1.1 TERMS OF REFERENCE.....	1
1.2 OBJECTIVES	1
1.3 APPROACH AND METHODOLOGY	1
1.4 ASSUMPTIONS AND LIMITATIONS.....	2
1.5 REFERENCE DOCUMENTATION	2
CHAPTER 2 PROJECT PARTICULARS	3
2.1 PROJECT DESCRIPTION AND SITE LOCATION	3
2.2 SITE ACCESS ROAD	4
2.3 SITE LAYOUT AND INTERNAL ROADS	4
CHAPTER 3 TRANSPORTATION ROUTES	7
3.1 PHOTOVOLTAIC (PV) ENERGY FACILITY COMPONENTS.....	7
3.2 TRANSFORMER AND SUBSTATION COMPONENTS.....	9
3.3 CIVIL CONSTRUCTION MATERIALS	9
3.4 TRANSPORTING OTHER PLANT, MATERIAL AND EQUIPMENT	9
3.5 CONSTRUCTION VEHICLES AND LABOUR TRANSPORT	10
3.6 ROUTE CLEARANCE.....	10
3.7 LEGISLATION AND PERMIT REQUIREMENTS	10
CHAPTER 4 BACKGROUND TRAFFIC VOLUMES	13
4.1 PHOTOVOLTAIC (PV) ENERGY FACILITY COMPONENTS.....	13
4.2 CAPACITY ANALYSIS.....	15
CHAPTER 5 TRIP GENERATION.....	16
5.1 CONSTRUCTION PHASE.....	16
5.2 OPERATIONAL PHASE	18
5.3 DECOMMISSIONING PHASE	18
CHAPTER 6 TRAFFIC IMPACT ASSESSMENT.....	19
6.1 ASSESSMENT OF IMPACTS ON TRANSPORTATION ROUTES.....	19
6.2 ASSESSMENT OF IMPACTS ON LOCAL TRAFFIC.....	20
6.3 ASSESSMENT OF IMPACT ON COMMUNITIES.....	21
CHAPTER 7 IMPACT ASSESSMENT SUMMARY	22
CHAPTER 8 CUMULATIVE IMPACT AND SIGNIFICANCE	24
8.1 CUMULATIVE TRIP GENERATION	24
8.2 CUMULATIVE IMPACT ASSESSMENT.....	25

CHAPTER 9 SUMMARY AND CONCLUSION29
APPENDIX A LOCALITY PLAN.....A
APPENDIX B BACKGROUND TRAFFIC VOLUMES B
APPENDIX C TYPICAL ACCESS GEOMETRY.....C
APPENDIX D CUMULATIVE IMPACT AND SIGNIFICANCE TABLE D
APPENDIX E ASSESSMENT METHODOLOGY G

LIST OF TABLES

Table 3.1: Permits and consent requirements.....	12
Table 4.1: Traffic recording stations (Port of Saldanha route).....	13
Table 4.2: Background traffic data (Port of Saldanha to Barleria SEF).....	14
Table 4.3: Traffic recording stations (Port of Durban route)	14
Table 4.4: Background traffic data (Port of Durban to Barleria SEF)	14
Table 4.5: Capacity analysis (background traffic).....	15
Table 5.1: Trip generation (construction phase).....	17
Table 6.1: Traffic impact on Saldanha route (delivery and construction trips)	19
Table 6.2: Traffic impact on Durban route (delivery and construction trips).....	20
Table 6.3: Traffic impact on R505 (commuter trips)	20
Table 7.1: Impact Rating – Construction Phase	22
Table 7.2: Impact Rating – Construction Phase	22
Table 7.3: Impact Rating – Operational Phase.....	22
Table 7.4: Impact Rating – Decommissioning Phase	23
Table 8.1: Additional solar power projects (within 30 km radius from study area).....	24
Table 8.2: Cumulative trip summary (Saldanha route).....	24
Table 8.3: Cumulative trip summary (Durban route)	25
Table 8.4: Cumulative significance weighting.....	26
Table 8.5: Impact assessment	27
Table 8.6: Cumulative Impact rating	28
Table 9.1: Comparison of summarised impacts on environmental parameters.....	29

LIST OF FIGURES

Figure 2.1: Locality of the Barleria SEF near the town of Lichtenburg	3
Figure 2.2: Site access road	4
Figure 2.3: Photovoltaic solar energy facilities on Portions 1, 9 and 10 of the farm Houthaalboomen No. 31	6
Figure 3.1: Transportation route (Port of Saldanha to Barleria SEF).....	7
Figure 3.2: Transportation route (Port of Durban to Barleria SEF).....	8

CHAPTER 1 INTRODUCTION

1.1 TERMS OF REFERENCE

BVi Consulting Engineers Western Cape (Pty) Ltd was appointed by *Barleria PV (Pty) Ltd* to conduct a Traffic and Transportation Study for the proposed development of an up to 75 MW photovoltaic (PV) solar energy facility near Lichtenburg, in the North West Province. The Barleria PV facility requires Environmental Authorisation (EA) from the National Department of Forestry, Fisheries and the Environment (DFFE) subject to the completion of a full Scoping and Environmental Impact Assessment (S&EIA), as prescribed in the 2014 EIA Regulations. This specialist study forms part of the (EIA).

1.2 OBJECTIVES

The objectives of this specialist traffic and transportation study are as follows:

- To determine the potential environmental and social (including labour, health and safety) indirect, direct and cumulative risks/ impacts to receptors from a traffic and transportation perspective for this project.
- To propose mitigation measures for identified significant risks/ impacts and enhance positive risk/ impacts of the project.
- To ensure that the project operations comply with relevant social and environmental standards, policies, laws and regulations.

1.3 APPROACH AND METHODOLOGY

The traffic and transportation study deals with the traffic impact on the surrounding road network during three distinct phases: *construction*, *operational* and *decommissioning*. The study considered and assessed the following:

- Traffic and transportation assessment:
 - Estimation of trip generation.
 - Discussion of potential traffic impacts.
 - Assessment of possible transportation routes and
 - Construction and operational (maintenance) vehicle trips.
- Site layout, access points and internal roads assessment:
 - Description of the surrounding road network.
 - Description of site layout.
 - Assessment of proposed access points and
 - Assessment of proposed internal roads.

1.4 ASSUMPTIONS AND LIMITATIONS

The following assumptions and limitations apply to the traffic and transportation study:

- This study is based on the project information provided by *Barleria PV (Pty) Ltd*;
- According to the Eskom specifications for power transformers, the following dimensional limitations need to be adhered to when transporting the transformers:
 - Height: 5000 mm.
 - Width: 4300 mm and
 - Length: 10 500 mm.
- Imported photovoltaics (PV) energy facility components will be transported from the most feasible port of entry, which is deemed to be the Port of Durban in the KwaZulu-Natal Province;
- If any elements are manufactured within South Africa, these will be transported from their respective manufacturing centres, which would be either in the greater Johannesburg, Pinetown/Durban or Cape Town for the transformer, inverter and the support structures;
- Civil construction materials will be sourced from nearby towns such as Lichtenburg and Mafikeng where possible;
- All other construction materials, for concrete and wearing course, will be sourced from a local licensed quarry (off-site);
- All transportation trips will occur on either surfaced national and provincial roads or existing gravel roads; and
- Maximum vertical height clearances along the transportation route is 5.2 m for abnormal loads.

1.5 REFERENCE DOCUMENTATION

The following documents/ sources were used in compiling this report and reference will be made where necessary:

- *Highway Capacity Manual (HCM) 6th Edition*, published by *Transportation Research Board*, October 2016.
- *TRH 11 – Dimensional and Mass Limitations and Other Requirements for Abnormal Load Vehicles*, published by Department of Transport (DoT), August 2009.
- *TMH 17, Volume 1 - South African Trip Data Manual*, published by the *Committee of Transport Officials (COTO)*, September 2012.
- *TRH 17 – Geometric Design of Rural Roads*, published by the *Department of Transport (DoT)*, 1988.

CHAPTER 2 PROJECT PARTICULARS

2.1 PROJECT DESCRIPTION AND SITE LOCATION

The proposed Barleria photovoltaic (PV) solar energy facility (known as the Barleria PV facility) is located on a site approximately 5km north west of the town of Lichtenburg in the North West Province. The site for this development is located off Regional Road R505, where Provincial Road D2435 will be utilised to access Portions 1, 9 and 10 of the farm Houthaalboomen No. 31. The location of the site is provided in *Figure 2.1* below.

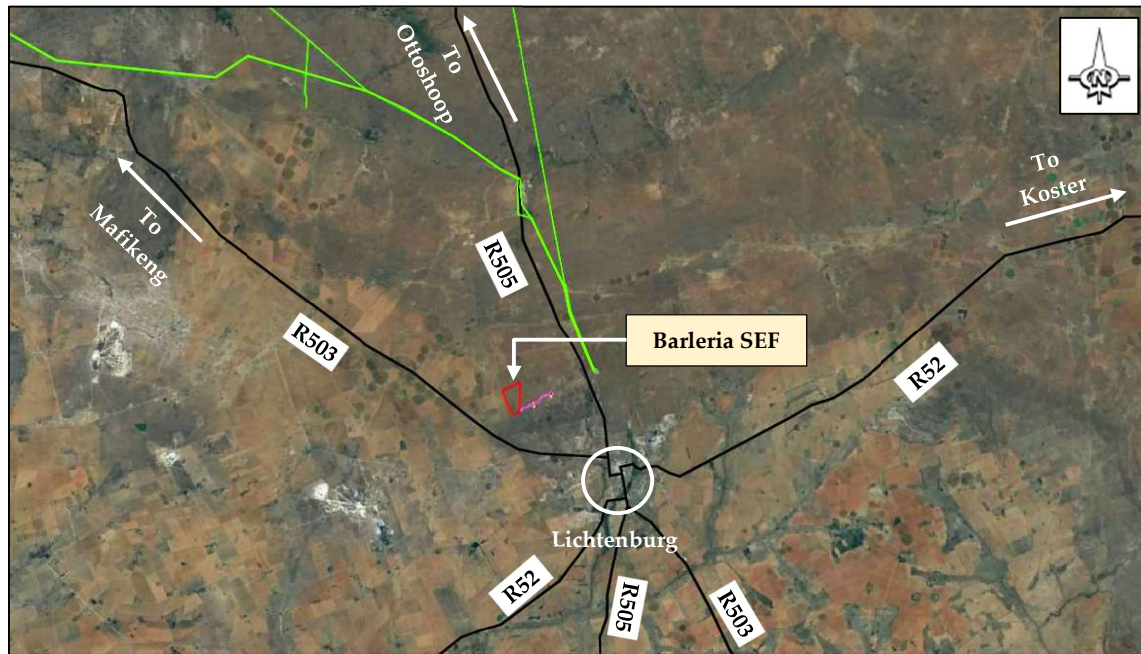

Figure 2.1: Locality of the Barleria SEF near the town of Lichtenburg

The solar PV facility will comprise several arrays of PV panels and associated infrastructure and will have a contracted capacity of up to 75MW. The purpose of the proposed solar power plant will be to supply the generated power into the *Eskom Holdings SOC Ltd* electricity grid. The total development footprint of the project will be approximately 176 hectares, as well as two alternative grid connection solutions (within a 100m wide corridor).

The photovoltaic components will be delivered to site from two (2) possible locations, either from the Port of Saldanha (1420 km) or from the Port of Durban (855 km). The construction phase of the solar energy facility is expected to take place over a period of between twelve (12) and eighteen (18) months, during which local traffic will be affected minimally. The expected traffic and trip generation figures are addressed in *Chapter 5: Trip Generation*.

2.2 SITE ACCESS ROAD

Access to the site will be via an existing gravel District Road (D2435) of approximately 2.5 km in length, which will need to be upgraded to cater for the construction vehicles navigating the road to the laydown areas on site. This gravel road will need to be suitably maintained. Re-gravelling may be necessary as a maintenance measure, from time to time, throughout the operational life of the solar power plant. The site access road is provided in *Figure 2.2* below.

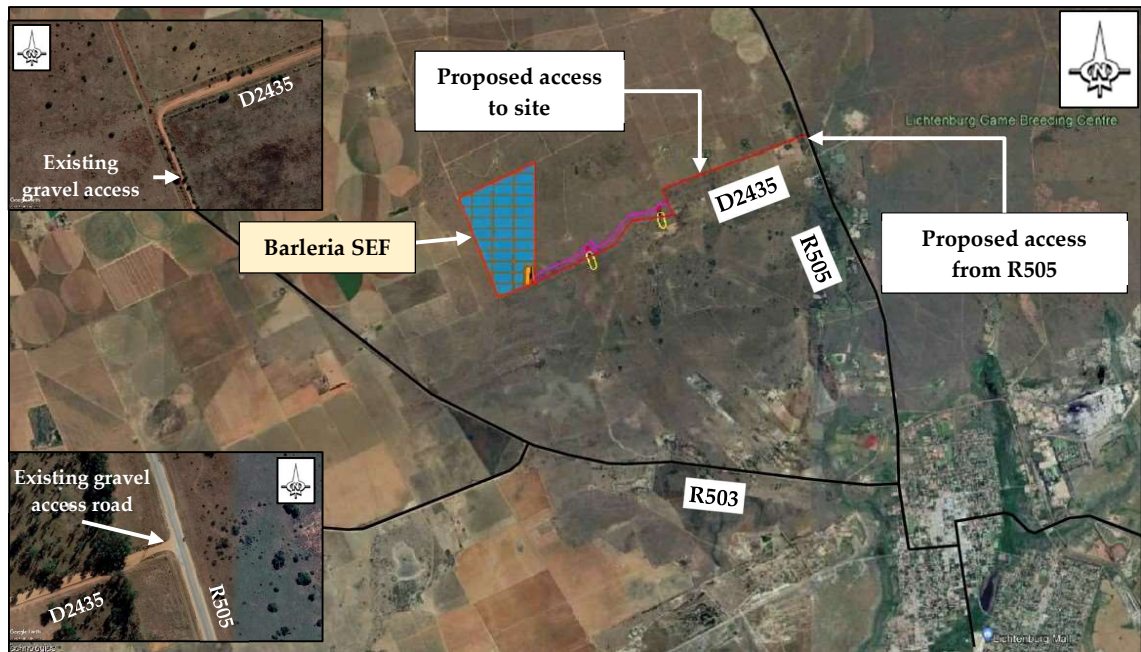

Figure 2.2: Site access road

A formal application for the access point on Regional Road R505 will need to be lodged with the *Ditsobotla Local Municipality* and *North West: Department of Public Works and Roads*. The formalisation and upgrading of the access point to the required standard, as provided in *Appendix C*, will in all probability be a requirement as part of the wayleave approval. In addition, it must be noted that adequate traffic accommodation signage must be erected and maintained on either side of the access on the R505, throughout the construction phase of the plant, in accordance with the *South African Road Traffic Signs Manual, Vol 2, May 2012*.

2.3 SITE LAYOUT AND INTERNAL ROADS

The Barleria Solar Energy Facility (SEF) will consist of the following main components:

- Photovoltaic (PV) arrays (consisting of a maximum of approximately 300 000 mono/polycrystalline modules).
- Steel mounting structures.
- Cabling.
- Medium voltage stations (inclusive of inverters), medium voltage receiving station and control building.

- High voltage substation (2x 40 MVA or 1x 80 MVA power transformers).
- Battery Energy Storage System (BESS) – BESS typically includes batteries that have been assembled in containerised/modular enclosures. While each manufacturer has slightly different individual battery container/module dimensions, they all typically fall within the following ranges:
 - Length: 6m – 12m
 - Width: 1.5m – 2.5m
 - Height: maximum of 3m
- Site offices and maintenance buildings, including workshop areas for maintenance and storage.
- Temporary and permanent laydown areas, and
- Internal roads
 - The main internal road is proposed to be 8 m wide.
 - The secondary internal roads are proposed to be 4 m wide (maximum 5 m wide).
- Grid connection solution (two alternative locations assessed) within a 100m wide corridor, including:
 - 33kV cabling between the project components and the facility substation.
 - A 132kV facility substation.
 - A 132kV Eskom switching station.
 - A Loop-in-Loop out (LILO) overhead 132kV power line between the Eskom switching station and the existing Delareyville Munic–Watershed 1 88kV power line.

Furthermore, it must be noted that the Setaria and Dicoma PV SEFs are concurrently being considered adjacent to the project site within Portions 1, 9 and 10 of the farm Houthaalboomen No. 31, as indicated in *Figure 2.3* below.

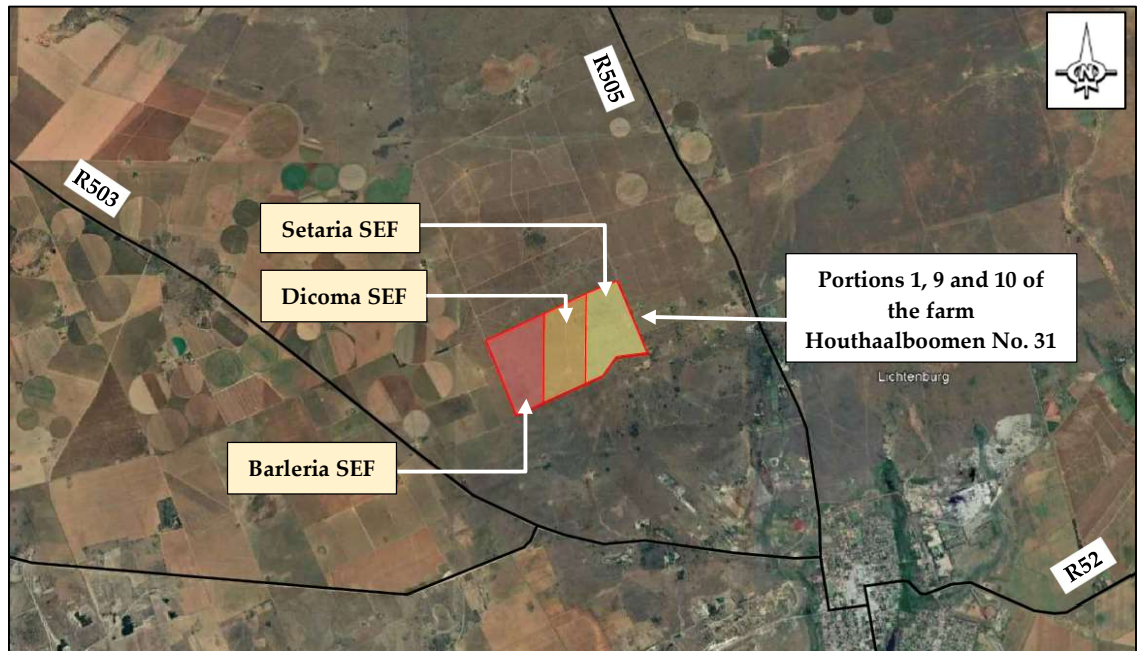

Figure 2.3: Photovoltaic solar energy facilities on Portions 1, 9 and 10 of the farm Houthaalboomen No. 31

CHAPTER 3 TRANSPORTATION ROUTES

As mentioned before, the photovoltaic (PV) equipment and relevant components will be transported to Portions 1, 9 and 10 of the farm Houthaalboomen No. 31 over a distance of 1420 km or 855 km from either the Port of Saldanha or the Port of Durban, respectively. The above-mentioned routes will be discussed in the sub-chapters below.

3.1 PHOTOVOLTAIC (PV) ENERGY FACILITY COMPONENTS

3.1.1 Alternative 1: Port of Saldanha (1420 km)

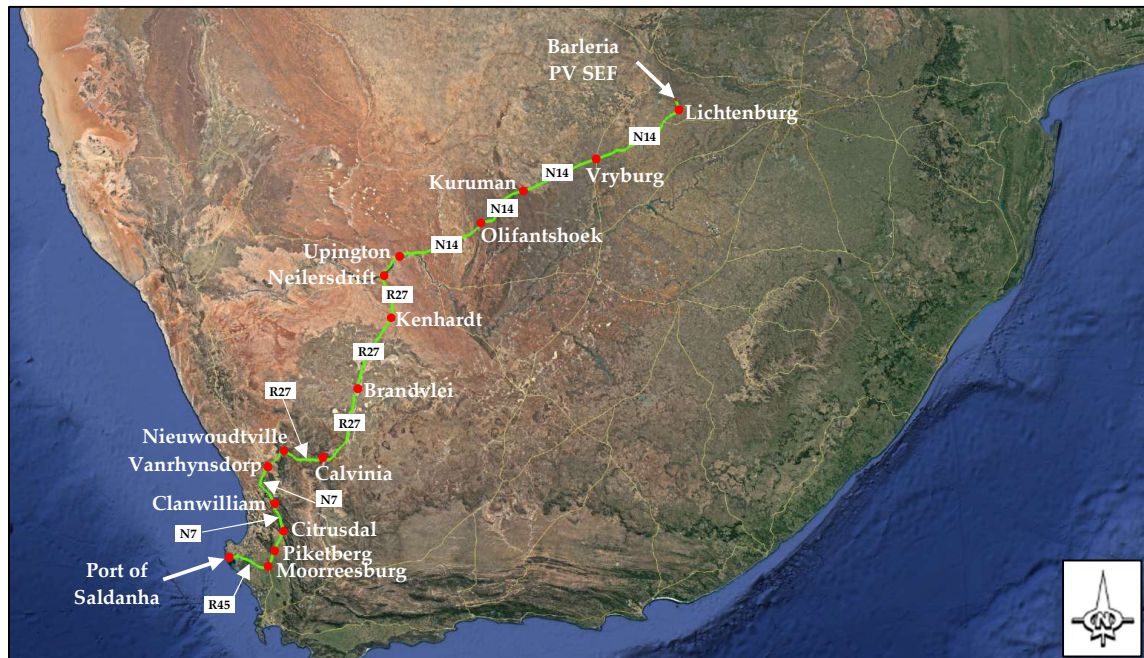

Figure 3.1: Transportation route (Port of Saldanha to Barleria SEF)

The route overview shown in *Figure 3.1* is briefly described below:

- Travel from the Port of Saldanha to Moorreesburg via the R45 and the R311 towards and through the town of Hopefield.
- Turn left onto the N7 and travel towards and through the towns of:
 - Moorreesburg,
 - Piketberg,
 - Citrusdal,
 - Clanwilliam and
 - Vanrhynsdorp.
- At Vanrhynsdorp turn right onto the R27 and travel north towards and through the towns of:
 - Nieuwoudtville,
 - Calvinia,

- Brandvlei,
- Kenhardt and
- Neilersdrift.
- Once through the town of Neilersdrift, turn right onto the N14.
- Continue on the N14 and travel north-east towards and through the towns of:
 - Upington,
 - Olifantshoek,
 - Kuruman,
 - Vryburg,
 - Delareyville and
 - Sannieshof
- Continue on the N14 and the R52 and travel north-east towards the town of Lichtenburg.
- In Lichtenburg, continue onto the R505 and travel north for approximately 8 km. The gravel access road to the Barleria SEF is located on the left-hand side of the R505.

3.1.2 Alternative 2: Port of Durban (855 km)

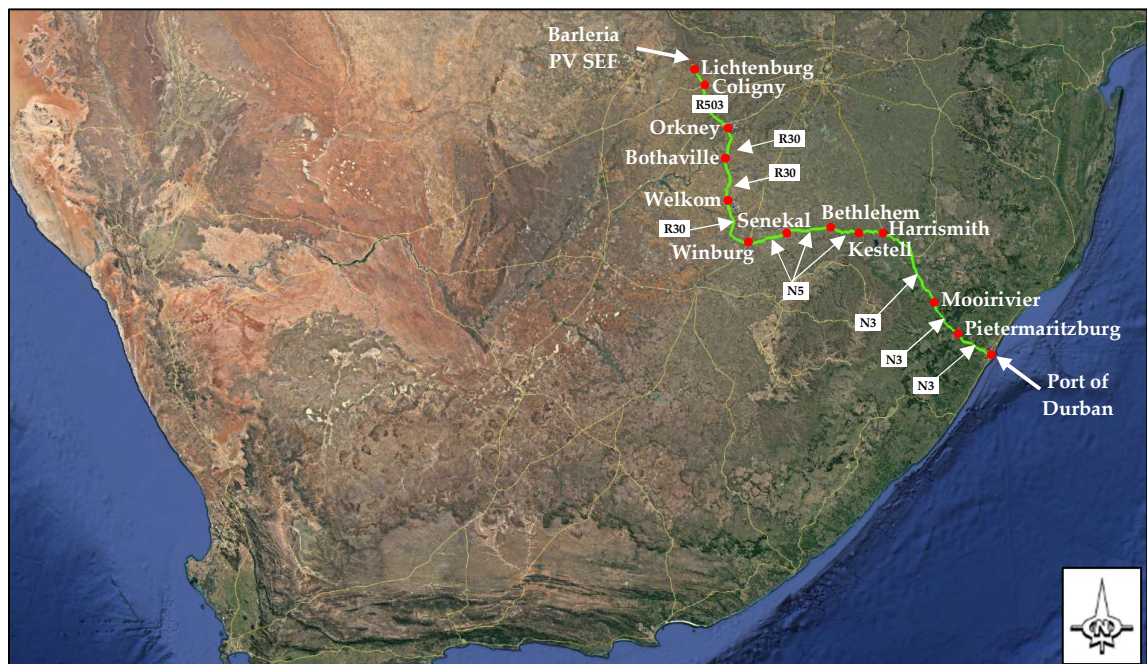

Figure 3.2: Transportation route (Port of Durban to Barleria SEF)

The route overview shown in *Figure 3.2* is briefly described below:

- Travel north-west from the Port of Durban, via the N3, towards the Harrismith interchange.
- Take the N5 from Harrismith Interchange and travel towards and through the towns of:
 - Kestell
 - Bethlehem;
 - Senekal; and

- Winburg.
- Continue north-west onto the R708 and then turn right onto the R30, at Theunissen.
- Continue north on the R30 and travel towards and through the towns of:
 - Welkom;
 - Bothaville; and
 - Orkney.
- In Orkney, turn left onto the N12 and then turn right onto the R503. Continue north on the R503 and travel towards and through the towns of:
 - Coligny; and
 - Lichtenburg.
- In Lichtenburg, continue onto the R505 and travel north for approximately 8 km. The gravel access road to the Barleria SEF is located on the left-hand side of the R505.

3.2 TRANSFORMER AND SUBSTATION COMPONENTS

Transformer and substation components are envisaged to form part of the local trips. It is anticipated that these components would be imported and transported from the preferred harbour (Saldanha or Durban) as abnormal loads. It would then be assembled in Johannesburg and transported to the Barleria SEF site, also requiring abnormal load transport. The distance from Johannesburg to Barleria SEF is approximately 223 km, along the N14. An abnormal load will necessitate an application to the Department of Transport and Public Works for a permit that will give authorisation for the conveyance of said load. A permit is required for each Province that the transportation route traverses.

It should be noted that only one abnormal load trip per transformer is expected for Barleria SEF. Abnormal load transportation is therefore considered to be isolated and would have a negligible impact on traffic over the construction phase of the project.

3.3 CIVIL CONSTRUCTION MATERIALS

Cement will be sourced from local manufacturers within the town of Lichtenburg. All other civil construction materials, needed for concrete and wearing course, will be obtained from a local licensed quarry off-site. These trips can be classified as local trips as vehicles will not be travelling over a very long distance.

3.4 TRANSPORTING OTHER PLANT, MATERIAL AND EQUIPMENT

In addition to transporting the specialised equipment, the normal Civil Engineering construction materials, plant and equipment will need to be transported to the site (e.g. sand, stone, cement, gravel, water, compaction equipment, concrete mixers, etc.). Other components, such as electrical cables, pylons and substation transformers, will also be transported to site during construction. The transport of these items will generally be conducted with normal heavy loads vehicles, except for the transformers which require an abnormal load vehicle.

3.5 CONSTRUCTION VEHICLES AND LABOUR TRANSPORT

It is anticipated that construction personnel and labour would originate from neighbouring towns such as Lichtenburg and Mafikeng. These trips can be classified as local trips as vehicles will not be travelling over a very long distance.

3.6 ROUTE CLEARANCE

The vehicles used to transport the photovoltaic (PV) equipment are standard container trucks. The transformer will be transported as abnormal loads. No obstacles (e.g. low overhead services, cattle grids, narrow bridges, etc.) are expected, as these routes are travelled by the same type of vehicle throughout.

3.7 LEGISLATION AND PERMIT REQUIREMENTS

The overarching environmental legislation for management of the environment in South Africa, is the National Environmental Management Act, 1998 (Act 107 of 1998 “NEMA”). Its foreword states that sustainable development requires the integration of social, economic, and environmental factors in the planning, implementation, and evaluation of environmental decisions to ensure that the development serves present and future generations. Traffic impacts are therefore an important aspect to consider in the decision-making process of developments.

3.7.1 Roads

The relevant legislation associated to the road (infrastructure), transportation and traffic include, inter alia:

- National Water Act (Act 36 of 1998), with regards to all crossings of water courses.
- National Road Traffic Act (Act 93 of 1996).
- National Road Traffic Regulations, 2000.
- Advertising on Road and Ribbon Development Act (Act 21 of 1940).
 - Section 9: Prohibition of erection of structures or construction of other things near intersections of certain roads, and
 - Section 10: Restriction of access to land through fence along certain roads.
- Roads Ordinance Act (Act 19 of 1976).
 - Section 13: Erection of gates across public roads and public paths.
 - Section 17: Erection of structures on or near public roads, and
 - Section 18: Access to and exit from certain public roads and public paths.

3.7.2 Vehicle dimensions

Regulations 221 to 230 of the National Road Traffic Act relates to vehicle dimensions. The most important points are summarised below.

- Regulation 221: Defines the legislation requirements regarding the overall length of vehicles. The following lengths shall not be exceeded:
 - Rigid vehicle: 12.5 m.
 - Articulated vehicle and semi-trailer: 18.5 m; and
 - Combination vehicle (interlinks, multiple trailers etc.): 22.0 m
- Regulation 223: Defines the legislation requirements regarding the overall width of vehicles. Vehicles with a gross mass of 12 000 kg or more, shall not exceed 2.6 m.
- Regulation 224: Define the legislation requirements regarding the overall height of a vehicle and transported load, which shall not exceed 4.3 m.
- Regulation 225: Defines the legislation requirements regarding the maximum turning radius and wheelbase, which shall not exceed 13.1 m or 10.0 m (semi-trailer) respectively.

3.7.3 Vehicle loads

Regulations 231 to 249 of the National Road Traffic Act relates to vehicle loads. The most important points are summarised below.

- Regulation 240: Defines the legislation requirements regarding the mass load carrying on roads.
- Regulation 241: Defines the legislation requirements regarding the mass load carrying capacity of bridges.

3.7.4 Abnormal load considerations

It is expected that the transformers will be transported with an abnormal load vehicle. Abnormal permits are required for vehicles exceeding the permissible maximum dimensions on road freight transport.

The *National Road Traffic Act (Act 93 of 1996)* and the *National Road Traffic Regulations (2000)* prescribed certain limitations on vehicle dimensions and axle and vehicle masses that a vehicle using a public road must comply with. Where the prescribed limitations are exceeded, these loads are then classified as an abnormal load. Provision for such abnormal vehicles and loads are made in *Section 81 of the National Road Traffic Act*, as substituted by *Section 23 of the National Road Traffic Amendment Act (Act 64 of 2008)*.

The requirements and procedures for transporting of abnormal loads are contained in the following two documents:

- *TRH 11: Dimensional and Mass Limitations and Other Requirements for Abnormal Load Vehicles;* and
- *COTO: Administrative Guidelines for Granting of Exemption Permits for the Conveyance of Abnormal Loads, Revision 2, March 2015.*

The specific permits and consents that may be required from the relevant authorities, for the transportation of abnormal loads, are summarised in *Table 3.1* below.

Table 3.1: Permits and consent requirements

PERMIT/ CONSENT TYPE	RELEVANT AUTHORITY	STRATEGY
Abnormal Load/Vehicle Permit in terms of <i>National Road Traffic Act 93 of 1996, Section 81</i>	<i>Provincial Government Gauteng: Department of Roads and Transport & Provincial Government North West: Department of Transport, Roads and Community Safety</i>	The contractor will obtain the necessary road transportation permits.
<i>The South African National Roads Agency Limited and National Roads Act, Act 7 of 1998</i>	<i>South African National Roads Agency SOC Limited (SANRAL)</i>	The contractor will obtain clearance from SANRAL.

CHAPTER 4 BACKGROUND TRAFFIC VOLUMES

Background traffic volumes were determined for the study network near the site, as well as along the transportation routes. These traffic volumes were acquired from *Mikros Traffic Monitoring (Pty) Ltd*, in order to determine what the existing traffic conditions are like in the absence of the proposed solar power plant.

Various traffic recording stations on major roadways, along transportation routes, were identified and are provided in the sub-chapters below. The traffic count data was sourced from permanent counting stations only, as it is the most reliable and accurate data that was available. It must be noted that the traffic data was only recorded up until December 2019. Therefore, the existing traffic volumes for the years 2020 to 2023 were predicted as described below.

4.1 PHOTOVOLTAIC (PV) ENERGY FACILITY COMPONENTS

4.1.1 Alternative 1: Port of Saldanha to Barleria SEF

The following traffic recording stations were identified along the Saldanha route:

Table 4.1: Traffic recording stations (Port of Saldanha route)

SITE IDENTIFIER	SITE NAME	SITE DESCRIPTION	ROUTE
5014	Piketberg	Between Moorreesburg and Piketberg	N7
5015	Citrusdal	Between Citrusdal and Clanwilliam	
1304	Calvinia West	Between Niewoudtville and Calvinia	R27
1302	Keimoes	Between Upington and Keimoes	N14
1303	Upington East	Between Upington and Olifantshoek	

Graphs in *Appendix B* indicate the background traffic volumes for the years 2015 to 2023. The historic traffic data (2015 to 2019) was extrapolated by means of a trendline analysis, in order to predict the traffic volumes for the years 2020 to 2023. The predicted traffic volumes for the year 2023 is provided in *Table 4.2* overleaf.

Table 4.2: Background traffic data (Port of Saldanha to Barleria SEF)

SITE IDENTIFIER	ANNUAL DAILY TRAFFIC (ADT) (vpd)	ANNUAL DAILY TRUCK TRAFFIC (ADTT) (vpd)	% OF TRUCKS
5014	5363	1162	21.67%
5015	3765	921	24.45%
1304	881	280	31.74%
1302	3704	507	13.70%
1303	1768	462	26.11%

From the table above it can be seen that heavy vehicles contribute between 14% and 32% to the total traffic volumes along the Saldanha transportation route.

4.1.2 Alternative 2: Port of Durban to Barleria SEF

The following traffic recording stations were identified along the Durban route:

Table 4.3: Traffic recording stations (Port of Durban route)

SITE IDENTIFIER	SITE NAME	SITE DESCRIPTION	ROUTE
1990	Estcourt I/C	Southern side of Giants Castle I/C	N3
533	Bethlehem East	Between Kestell and Bethlehem	N5
875	Bethlehem	5 km west of Bethlehem	
1549	Winburg	Between Winburg and Senekal	
1453	Theunissen North	Between Theunissen & P3/1 T/O	R30

Graphs in *Appendix B* indicate the background traffic volumes for the years 2015 to 2023. The historic traffic data (2015 to 2019) was extrapolated by means of a trendline analysis, in order to predict the traffic volumes for the years 2020 to 2023. The predicted traffic volumes for the year 2023 is provided in *Table 4.4* below.

Table 4.4: Background traffic data (Port of Durban to Barleria SEF)

SITE IDENTIFIER	ANNUAL DAILY TRAFFIC (ADT) (vpd)	ANNUAL DAILY TRUCK TRAFFIC (ADTT) (vpd)	% OF TRUCKS
1990	*17 777	8608	48.42%
533	5153	1507	29.25%
875	4759	1315	27.63%
1549	2428	821	33.82%
1453	7831	1046	13.35%

*The section on the N3 (SITE ID 1990) consists of three lanes in each direction, at the counting station, total volume, 17 777 ADT, 8608 ADTT.

From the table above it can be seen that heavy vehicles contribute between 13% and 48% to the total traffic volumes along the Durban transportation route.

4.2 CAPACITY ANALYSIS

The *TRH 17* document was consulted in order to determine if the capacities of the above-mentioned roadways will be exceeded within the near future. The capacity analysis results are indicated in *Table 4.5* below.

Table 4.5: Capacity analysis (background traffic)

SITE IDENTIFIER	ROUTE	2023 AVERAGE DAILY TRAFFIC (ADT) (vpd)	PREDICTED LEVEL OF SERVICE (LOS)
SALDANHA ROUTE			
5014	N7	5363	C
5015		3765	B
1304	R27	881	A
1302	N14	3704	B
1303		1768	A
DURBAN ROUTE			
1990	N3	*5926	B
533	N5	5153	C
875		4759	B
1549		2428	B
1453	R30	7831	C

Note: LOS A: 2200 vpd; LOS B: 4900 vpd; LOS C: 8800 vpd; LOS D: 14500 vpd and LOS E: 24 600 vpd (Two-lane, two-way roads)

*The section on the N3 (SITE ID 1990) consists of three lanes in each direction, at the counting station, total volume, 17 777 ADT, 8608 ADTT.

From the table above it can be concluded that, for all transportation routes, the capacities of roadways will not be exceeded.

CHAPTER 5 TRIP GENERATION

The proposed Barleria PV solar energy facility will generate additional traffic on the surrounding road network in three (3) distinct phases, namely: *construction*, *operational* and *decommissioning*. It must be noted that these three phases will generate traffic consecutively and not simultaneously, and therefore will be considered separately from each other.

5.1 CONSTRUCTION PHASE

Trips generated during the construction phase will primarily comprise of transporting equipment, energy facility components, personnel, construction and other facility materials. These trips will comprise of normal, medium and heavy vehicles.

The following assumptions were made in order to calculate trips generated during the construction phase of the project:

- It is estimated that the construction period will last between twelve (12) and eighteen (18) months, with twenty-two (22) working days per month. This results in between 308 and 396 working days over the construction period.
- The Barleria SEF will most likely be constructed from components that will be shipped to South Africa via the Port of Durban. These components will be transported to site via road transport using medium and heavy vehicles. It is also assumed that the component delivery period will be over a course of five (5) consecutive months, i.e. 110 working days.
 - The solar energy facility will generate approximately up to 75 MW electrical power.
 - The final delivery of photovoltaic (PV) components will take place one (1) month prior to completion of the SPP.
 - Approximately 160 000 - 300 000 PV modules of approximately 300 - 550 W each will be delivered to site. 220 of these 300 – 550 W units can fit into one (1) container. Therefore, 1705 trips will be generated.
- Other plant, materials and equipment will be sourced from the nearest towns.

Another contributor to trips generated during the construction phase will be daily commuters/workers. The following assumptions were made in this regard:

- Due to the site being close to the towns of Lichtenburg and Mafikeng, the construction labour force will be mostly local.
- It is assumed that approximately 350 staff members/workers will be on site.
 - Based on the composition it is assumed that 10% of the staff members will make use of private or company vehicles (cars and LDVs). These staff members will travel from their permanent or temporary residences to site on a daily basis.
 - Furthermore it is assumed that the remainder of the staff members (90%) will be transported to site with 15-seater minibus-taxis. The quantities of these vehicles will

fluctuate and will depend on the number of labourers, costs, routes and operating hours.

The table below summarises the estimated total trips that will be generated during the construction phase of the project:

Table 5.1: Trip generation (construction phase)

TRANSPORTATION OF:	TRIPS PER MONTH						
	1	2	3	4	5	6	7
Fencing and tools	8	8	-	-	-	-	-
Clearance of site (veg. transport)	56	32	-	-	-	-	-
Piles/ frames for mounting systems	-	-	20	20	20	20	20
Cement	-	96	154	154	154	167	167
PV modules	-	-	-	-	-	-	-
MV stations	-	-	-	-	-	12	12
HV substation components	-	-	8	8	8	-	-
Cables	-	-	-	-	-	-	-
Staff and labour	-	-	1410	1410	1410	1410	1410
AVERAGE NO. OF TRIPS PER MONTH	64	136	1592	1592	1592	1609	1609

TRANSPORTATION OF:	TRIPS PER MONTH							
	8	9	10	11	12	13	14	TOT
Fencing and tools	16	-	-	-	-	-	-	32
Clearance of site (veg. transport)	-	-	-	-	-	-	-	88
Piles/ frames for mounting systems	-	-	-	-	-	-	-	100
Cement	173	167	154	102	-	-	-	1488
PV modules	-	120	256	545	528	256	-	1705
MV stations	12	12	12	-	-	-	-	60
HV substation components	-	-	-	-	-	-	-	24
Cables	16	16	-	-	-	-	-	32
Staff and labour	1410	1410	1410	1410	1410	1410	-	15 510
AVERAGE NO. OF TRIPS PER MONTH	1627	1725	1832	2057	1938	1666	-	19 039

It can be seen from the table above that the construction phase of Barleria Solar Energy Facility will generate approximately **19 039 trips** over the twelve (12) month period.

5.2 OPERATIONAL PHASE

The following assumptions were made with regards to the trip generation during the operational phase of the solar power plant:

- The Barleria SEF will be in operation between twenty (20) and thirty (30) years.
- The solar energy facility will be in operation seven (7) days a week. Therefore, personnel will operate according to shifts.
- The operational team will consist of approximately fifty (50) people:

The traffic impact during the operational phase will therefore be insignificant, as approximately only fifty (50) people will work at the solar power plant.

5.3 DECOMMISSIONING PHASE

The decommissioning phase will start at the end of the Barleria SEF lifetime (20 – 30 years) and will last approximately six (6) months, involving a team of fifty (50) workers. Same as with the operational phase, the traffic impact will be insignificant.

CHAPTER 6 TRAFFIC IMPACT ASSESSMENT

The expected effects of traffic that would be generated by the proposed Barleria solar energy facility were analysed as follows:

- The background traffic volumes were determined for the study network near the site, as well as along the transportation routes (Refer to *Chapter 4: Background Traffic Volumes*).
- The existing traffic volumes for the years 2020 to 2023 were predicted and are based on trendline analyses.
- Construction phase traffic (site-generated trips) were estimated for the proposed solar power plant.
- The construction phase traffic was added to the 2023 background traffic volumes to determine the total traffic conditions with the solar power plant completed.

The sub-chapters below provide the impact the development of the solar power plant will have on the transportation routes and local traffic respectively.

6.1 ASSESSMENT OF IMPACTS ON TRANSPORTATION ROUTES

The *HCM 6th Edition Chapter 15: Two Lane Highways* was consulted as the greatest portion of the routes to be travelled by the delivery trucks are rural two-lane highways of either Class I, II or III. The trips generated by this development were evaluated in relation to the quantum of trips needed to change the Level of Service (LOS) on a portion of the rural highway and the ultimate capacity of two-lane highways.

Table 6.1 and *Table 6.2* provide the traffic impact of the delivery and construction trips on the Saldanha and Durban routes.

Table 6.1: Traffic impact on Saldanha route (delivery and construction trips)

SITE ID	ROUTE	EST. ADT ON ROUTE (vpd)	CONSTRUCTION TRIPS (vpd)	TOTAL TRIPS (vpd)
5014	All traffic	5363	40	5403
	Truck traffic	1162		1202
5015	All traffic	3765	40	3805
	Truck traffic	921		961
1304	All traffic	881	40	921
	Truck traffic	280		320
1302	All traffic	3704	40	3744
	Truck traffic	507		547
1303	All traffic	1768	40	1808
	Truck traffic	462		502

Table 6.2: Traffic impact on Durban route (delivery and construction trips)

SITE ID	ROUTE		EST. ADT ON ROUTE (vpd)	CONSTRUCTION TRIPS (vpd)	TOTAL TRIPS (vpd)
1990	N3	All traffic	17 777	40	17 817
		Truck traffic	8608		8648
533	N5	All traffic	5153	40	5193
		Truck traffic	1507		1547
875	N5	All traffic	4759	40	4799
		Truck traffic	1315		1355
1549	N5	All traffic	2428	40	2468
		Truck traffic	821		861
1453	R30	All traffic	7831	40	7871
		Truck traffic	1046		1086

It can be seen from the tables above and overleaf that the delivery and construction trips will be insignificant when compared to the Average Daily Traffic (ADT) and will not affect the existing Level of Service (LOS). It can therefore be concluded that, on both routes, no mitigation measures will be necessary.

The above-mentioned tables only accounted for the traffic impact of the Barleria SEF. It must be noted that there are other solar farm projects that may be constructed over the same period as Barleria. The ultimate scenario for the cumulative impact of these solar facilities is addressed in *Chapter 7: Cumulative Impact and Significance*.

6.2 ASSESSMENT OF IMPACTS ON LOCAL TRAFFIC

The capacity of a two-lane highway is 3200 vehicles per hour (vph), under ideal conditions, *HCM 6th Edition Chapter 15: Two Lane Highways*. The ideal conditions referred to is the absence of any restrictive geometry, traffic, or environmental factors.

From historic traffic count data, it was observed that the R505 around Lichtenburg have abundance spare capacity. The current ADT along this roadway is less than 2000 vpd. *Table 6.3* below indicate the effect of the commuter trips on the R505.

Table 6.3: Traffic impact on R505 (commuter trips)

SITE ID	ROUTE		EST. ADT ON ROUTE (vpd)	CONSTRUCTION TRIPS (vpd)	TOTAL TRIPS (vpd)
19236	R505	All traffic	707	176	883

It can be concluded from the table above that the estimated additional traffic generated by the construction staff, when travelling to/ from Barleria SEF, can be accommodated on the existing road network. Therefore, no mitigation measures will be necessary.

6.3 ASSESSMENT OF IMPACT ON COMMUNITIES

It is expected that the communities of Lichtenburg and Mafikeng will participate in the construction phase of the Barleria Solar Energy Facility. The development of this solar farm and other similar facilities creates an opportunity for temporary employment and economic upliftment of the surrounding communities.

From a traffic point of view, it was found that the total daily construction traffic will be low and will not significantly influence the surrounding communities.

CHAPTER 7 IMPACT ASSESSMENT SUMMARY

The assessment of impacts as discussed above are collated in the tables below.

Table 7.1: Impact Rating – Construction Phase

IMPACT TABLE - CONSTRUCTION PHASE		
Nature	Delivery and construction trips on Transportation routes	
	Without mitigation	With mitigation
Extent	Regional (1)	Regional (1)
Duration	Short term (1)	Short term (1)
Magnitude	Small (0)	Small (0)
Probability	Highly probable (4)	Highly probable (4)
Significance	Low (8)	Low (8)
Status (Positive or Negative)	Neutral	Neutral
Reversibility	Completely	Completely
Irreplaceable loss of resources?	No loss	No loss
Can impacts be mitigated?	Yes	Yes
Mitigation:	None	None

Table 7.2: Impact Rating – Construction Phase

IMPACT TABLE - CONSTRUCTION PHASE		
Nature	Commuter trips on Local traffic	
	Without mitigation	With mitigation
Extent	Local (1)	Local (1)
Duration	Short term (2)	Short term (2)
Magnitude	Low (4)	Minor (2)
Probability	Highly probable (4)	Improbable (2)
Significance	Low (28)	Low (10)
Status (Positive or Negative)	Neutral	Neutral
Reversibility	Completely	Completely
Irreplaceable loss of resources?	No loss	No loss
Can impacts be mitigated?	Yes	Yes
Mitigation:	None	None

Table 7.3: Impact Rating – Operational Phase

IMPACT TABLE – OPERATIONAL PHASE
The traffic generated during this phase will be minimal and will have not have any impact on the surrounding road network.

Table 7.4: Impact Rating – Decommissioning Phase

IMPACT TABLE – OPERATIONAL PHASE
The traffic generated during this phase will be minimal and will not have any impact on the surrounding road network.

CHAPTER 8 CUMULATIVE IMPACT AND SIGNIFICANCE

8.1 CUMULATIVE TRIP GENERATION

Table 7.1 below provide a summary of other renewable energy projects that may be constructed during the same period as the Barleria SEF but is unlikely. All these projects will be included in the cumulative trip generation and subsequently the cumulative impact assessment.

Table 8.1: Additional solar power projects (within 30 km radius from study area)

NO.	PROJECT NAME	DISTANCE FROM STUDY AREA (km)	CAPACITY (MW)
1	Setaria PV	-	75 MW
2	Dicoma PV	-	75 MW
3	Hibernia Solar Energy Facility	11.5 km	-
4	Lichtenburg 1 Solar PV Energy	6.1 km	100 MW
5	Lichtenburg 2 Solar PV Energy	5.0 km	100 MW
6	Lichtenburg 3 Solar PV Energy	4.0 km	100 MW
8	Tlisitseng PV 1 SEF	1.8 km	75 MW
9	Tlisitseng PV 2 SEF	1.8 km	75 MW

Table 7.2 and Table 7.3 are summaries of the expected trips generated by the development of the above-mentioned solar facilities, along with the background traffic on each of the major roadways. Take note that the below summary assumes that all of the abovementioned facilities will be constructed simultaneously.

Table 8.2: Cumulative trip summary (Saldanha route)

TYPE OF TRIPS (vpd)	N7 (Between Moorreesburg & Piketberg)	N7 (Between Citrusdal & Clanwilliam)	R27 (Between Nieuwoudtville & Calvinia)	N14 (Between Upington & Keimoes)	N14 (Between Upington & Olifantshoek)	R505 (Between Lichtenburg & Wolmaransstad)
Estimated ADT on road (vpd)	5363	3765	881	3704	1768	707
Delivery and construction trips	432	432	432	432	432	108
Commuter trips (vpd)	-	-	-	-	-	1410
TOTAL EXPECTED TRIPS (vpd)	5795	4197	1313	4136	2200	2225

Table 8.3: Cumulative trip summary (Durban route)

TYPE OF TRIPS (vpd)	N3 (Southern side of Giants Castle)	N5 (Between Kestell & Bethlehem)	N5 (5 km west of Bethlehem)	N5 (Between Winburg & Senekal)	R30 (Between Theunissen & P3/T/O)	R505 (Between Lichtenburg & Wolmaranstad)
Estimated ADT on road (vpd)	17 777	5153	4759	2428	7831	707
Delivery and construction trips	432	432	432	432	432	108
Commuter trips (vpd)	-	-	-	-	-	1410
TOTAL EXPECTED TRIPS (vpd)	18 209	5585	5191	2860	8263	2225

It can be seen from the tables above and overleaf that the cumulative additional trips will not greatly influence the immediate or wider road network. On both transportation routes, the maximum ADT of the major roadways are not exceeded, and the cumulative additional trips will not initiate a change in the LOS. It must be noted, however, that on the Durban route the LOS of the N5 (near Bethlehem) is likely to change from LOS B to LOS C. However, the roadway will still continue to operate at an acceptable level of service and therefore no mitigation measures are required due to the short period of impact.

8.2 CUMULATIVE IMPACT ASSESSMENT

A cumulative impact assessment was conducted through the assessment of the significance of impacts. The impact assessment must take into account the nature, scale and duration of impacts on the environment and whether such impacts are positive or negative. The rating system, which was applied to calculate the significance of an impact, makes use of the following formula:

$$\text{Rating} = (\text{Extent} + \text{Probability} + \text{Reversibility} + \text{Irreplaceability} + \text{Duration} + \text{Cumulative Effect}) \times (\text{Magnitude/Intensity})$$

The significance weighting for each potential impact are as follows:

Table 8.4: Cumulative significance weighting

Points	Impact Significance Rating	Description
6 to 28	Negative Low impact	The anticipated impact will have negligible negative effects and will require little to no mitigation.
6 to 28	Positive Low impact	The anticipated impact will have minor positive effects.
29 to 50	Negative Medium impact	The anticipated impact will have moderate negative effects and will require moderate mitigation measures.
29 to 50	Positive Medium impact	The anticipated impact will have moderate positive effects.
51 to 73	Negative High impact	The anticipated impact will have significant effects and will require significant mitigation measures to achieve an acceptable level of impact.
51 to 73	Positive High impact	The anticipated impact will have significant positive effects.
74 to 96	Negative Very high impact	The anticipated impact will have highly significant effects and are unlikely to be able to be mitigated adequately. These impacts could be considered "fatal flaws".
74 to 96	Positive Very high impact	The anticipated impact will have highly significant positive effects.

Table 7.4 and Table 7.5 is the result of such an assessment for the cumulative impact of the seven (7) solar farms, which are to be developed in the North West Province, overleaf.

Table 8.5: Impact assessment

IMPACT ASSESSMENT	
Nature	<p>Transportation (long distance) routes: The trips generated by the delivery of equipment and components to site are insignificant when compared to the Average Daily Traffic (ADT) of the immediate road network. The additional trips do not affect the Levels of Service (LOS) in any substantial way.</p> <p>Local traffic: The R505 near the solar energy facilities have an abundance of spare capacity and will be able to accommodate the estimated traffic generated by delivery vehicles, construction vehicles and on-site staff.</p> <p>Community: The construction of these solar energy facilities will have a positive impact on the surrounding communities, as it creates more job opportunities.</p>
Geographical Extent	The solar energy facilities will be constructed near the town of Lichtenburg. The construction of these solar power plants will affect the transportation routes as described in <i>Chapter 3</i> of this report.
Probability	<p>Local traffic: The chances of local traffic being adversely affected by the construction traffic is considered extremely low.</p> <p>Community: The construction of the solar energy facilities will have a definite positive impact on communities of the surrounding towns.</p>
Duration	The estimated construction to completion periods is between twelve (12) and eighteen (18) months.
Intensity/ Magnitude	As the construction of the solar energy facilities is of short-term duration, the impacts on the surrounding area will only be temporary.
Reversibility	All of the impacts are completely reversible, as the project is of short duration.
Irreplaceable Loss of Resources	None of the impacts will result in the loss of any resources.
Cumulative Effect	There is a small possibility that the seven (7) solar facilities be constructed over the same period. This will have moderate to minor cumulative effects on the existing traffic volumes.
Significance	The significance of the above-mentioned impacts are low, as they are only temporary and extend over a short time period.

Table 8.6: Cumulative Impact rating

IMPACT RATING	
Geographical Extent	3
Probability	2
Duration	1
Intensity/ Magnitude	2
Reversibility	1
Irreplaceable Loss of Resources	1
Cumulative Effect	3
Significance	-22 (negative low impact)

It can be seen from *Table 7.5* that the anticipated impact will have negligible negative effects and will require no mitigation.

CHAPTER 9 SUMMARY AND CONCLUSION

The following conclusions can be drawn from the Traffic and Transportation Study:

- The existing traffic volumes on the transportation routes were sourced from permanent count stations only, as this is the most reliable and accurate data that was available.
- The impact of the construction trip generation, on the predicted 2023 traffic volumes near the town of Lichtenburg and along the transportation routes, are expected to be low. No mitigation measures (upgrading of existing intersections) will be necessary.
- The photovoltaic (PV) components will be delivered to site from two possible ports, either from Saldanha (1420 km) or from Durban (855 km).
- All construction materials and PV components will be transported by truck. Transformer and substation components will be transported via abnormal loads.
- The access point to the site is situated off Regional Road R505. The formalisation of this access point, to the required standard, will in all probability be a requirement as part of the wayleave approval of *Ditsobotla Local Municipality* and *North West: Department of Public Works and Roads*.
 - This will mitigate the destructive impact of repetitive heavy turning vehicles on the public road pavement.
- Adequate traffic accommodation signage must be erected and maintained on either side of the access, on the R505, throughout the construction period of the project.
- The direct impact and significance of the Barleria solar energy facility (SEF) is considered low negative and low positive for the traffic and community parameters, respectively.
- The cumulative impact and significance of seven (7) solar farms are considered low negative and medium positive impacts. A summary of the cumulative impacts are provided in the table below:

Table 9.1: Comparison of summarised impacts on environmental parameters

ENVIRONMENTAL PARAMETER	SIGNIFICANCE RATING
Traffic	-22 (Low negative impact)

- Traffic will be negatively impacted with the construction of the solar power plants and related infrastructure.
- It is unlikely that all six (6) solar energy facilities will be constructed within the exact same period as the Barleria SEF but overlapping of construction periods is a possibility.

The development of the Barleria Solar Energy Facility on Portions 1, 9 and 10 of the farm Houthaalboomen No. 31 in the North West Province, can be supported from a traffic perspective.

APPENDIX A

LOCALITY PLAN

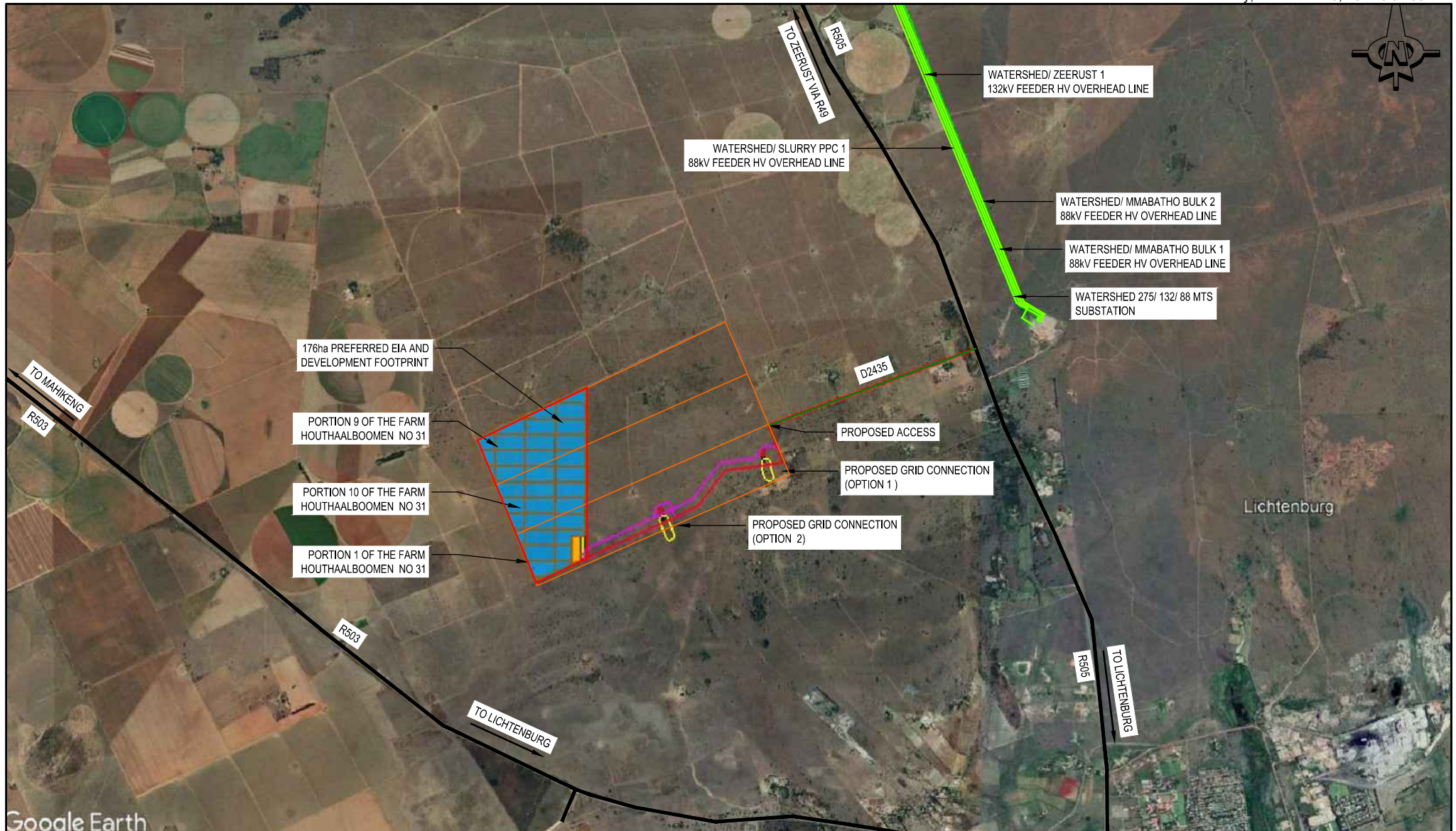

Google Earth

Western Cape Registration no. 198000015107 Cape Town (021) 527-7000 csa@bvi.co.za

• ENGINEERING • PROCUREMENT • MANAGEMENT

PROJECT		APPROVED BY BVI	
HOUTHAALBOOMEN PHOTOVOLTAIC (PV) SOLAR ENERGY FACILITIES IN THE NORTH WEST PROVINCE			
DRAWING TITLE			
BARLERIA PV SOLAR ENERGY FACILITY			
PLAN NUMBER		REVISION NO.	DATE SAVED
HOUTHAALBOOMEN PV CLUSTER		A	13-Nov-21

ENGINEER/TECHNOLOGIST		REG. NO.		DATE	
SCALE	N.T.S	DRAWN	JN		
DESIGNED	JN	CHECKED	DvdM		

APPENDIX B

BACKGROUND TRAFFIC VOLUMES

1990 - ESTCOURT IC (N3)						
YEAR	AVERAGE DAILY TRAFFIC (ADT)			AVERAGE DAILY TRUCK TRAFFIC (ADTT)		
	TO SPRINGBOK	TO CAPE TOWN	TOTAL	TO SPRINGBOK	TO CAPE TOWN	TOTAL
2015						
2016	8933	9156	18089	3351	3307	6658
2017	9017	8911	17928	3372	3394	6766
2018	8922	8633	17555	3504	3516	7020
2019	8951	9173	18124	3625	3924	7549
2020	8924	8933	17857	3863	3867	7730
2021	8910	8920	17830	4009	4014	8023
2022	8897	8907	17803	4155	4160	8315
2023	8883	8893	17777	4302	4306	8608

Southern side of Giants Castle I/C

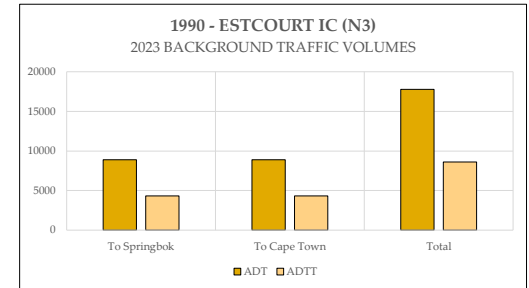
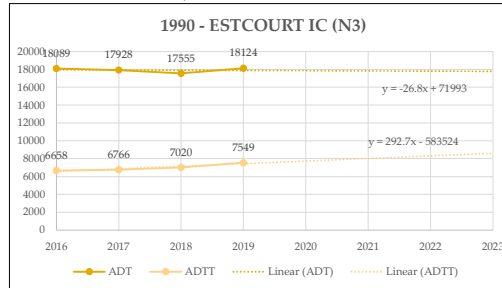

533 - BETHLEHEM EAST (N5)						
YEAR	AVERAGE DAILY TRAFFIC (ADT)			AVERAGE DAILY TRUCK TRAFFIC (ADTT)		
	TO KESTELL	TO BETHLEHEM	TOTAL	TO KESTELL	TO BETHLEHEM	TOTAL
2015	2467	2484	4951	642	625	1267
2016	2502	2542	5044	612	627	1239
2017	2550	2572	5122	652	649	1301
2018	2542	2545	5087	666	658	1324
2019	2505	2515	5020	701	692	1393
2020	2540	2559	5099	705	701	1406
2021	2549	2568	5117	722	718	1440
2022	2558	2577	5135	739	734	1473
2023	2567	2586	5153	756	751	1507

Between Kestell and Bethlehem

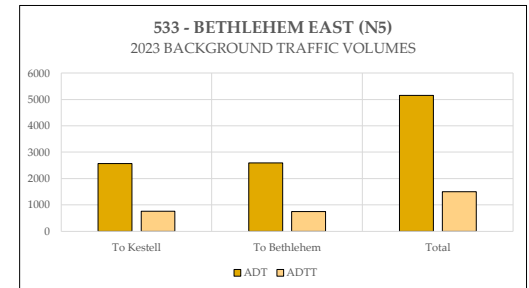
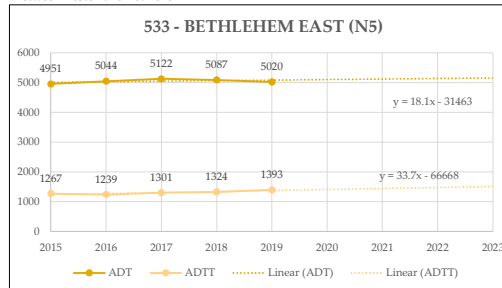

875 - BETHLEHEM (N5)						
YEAR	AVERAGE DAILY TRAFFIC (ADT)			AVERAGE DAILY TRUCK TRAFFIC (ADTT)		
	TO HARRISMITH	TO WINBURG	TOTAL	TO HARRISMITH	TO WINBURG	TOTAL
2015	1907	2015	3922	402	440	842
2016	2033	2108	4141	453	476	929
2017	2103	2151	4254	458	487	945
2018	2121	2159	4280	500	520	1020
2019	2144	2186	4330	532	556	1088
2020	2202	2270	4472	559	581	1140
2021	2249	2318	4568	587	611	1198
2022	2296	2367	4663	616	641	1257
2023	2343	2415	4759	644	671	1315

5 km west of Bethlehem

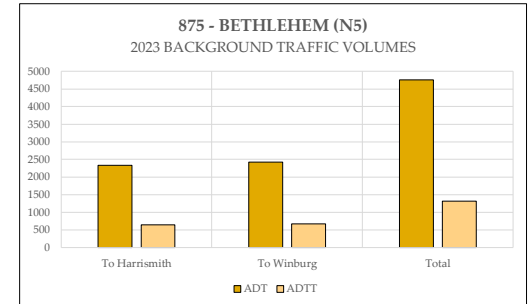
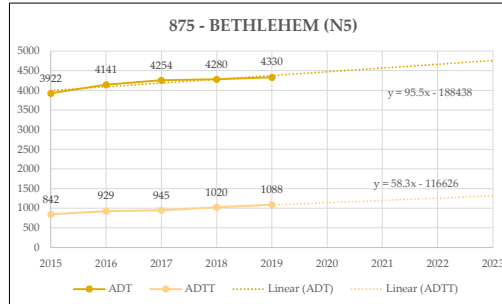

1549 - WINBURG (N5)						
YEAR	AVERAGE DAILY TRAFFIC (ADT)			AVERAGE DAILY TRUCK TRAFFIC (ADTT)		
	TO SENEKAL	TO WINBURG	TOTAL	TO SENEKAL	TO WINBURG	TOTAL
2015	1044	1096	2140	302	345	647
2016	1061	1112	2173	318	351	669
2017	1073	1138	2211	316	358	674
2018	1095	1151	2246	344	377	721
2019	1127	1191	2318	350	390	740
2020	1129	1190	2319	356	399	755
2021	1147	1208	2355	367	410	777
2022	1165	1227	2392	377	422	799
2023	1182	1245	2428	387	434	821

Between Winburg and Senekal

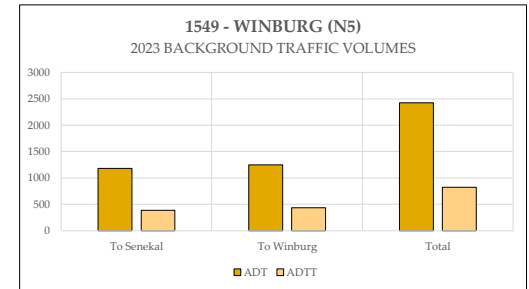
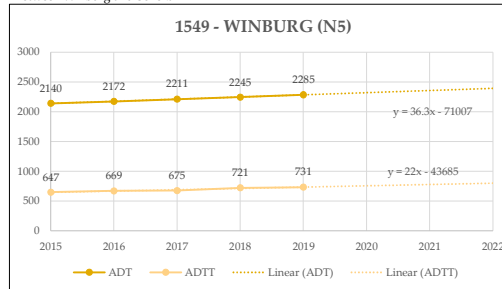

1453 - THEUNISSEN NORTH (R30)						
YEAR	AVERAGE DAILY TRAFFIC (ADT)			AVERAGE DAILY TRUCK TRAFFIC (ADTT)		
	TO VIRGINIA	TO THEUNISSEN	TOTAL	TO VIRGINIA	TO THEUNISSEN	TOTAL
2015	3534	3549	7083	723	705	1428
2016	3840	3971	7811	589	590	1179
2017	3967	4045	8012	609	602	1211
2018	3814	3893	7707	588	582	1170
2019	3640	3696	7336	631	631	1262
2020	3820	3890	7710	577	571	1148
2021	3839	3911	7750	560	554	1114
2022	3859	3931	7790	542	537	1080
2023	3879	3951	7831	525	520	1046

Between Theunissen & P3/1 T/O

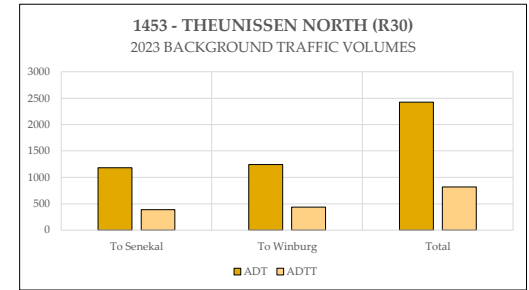
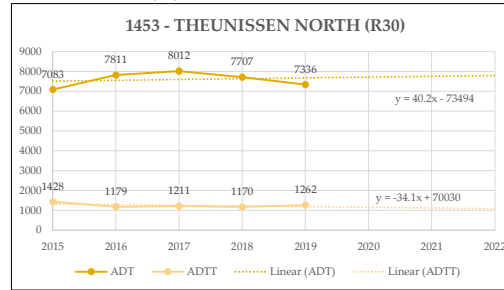

5014 - PIKETBERG (N7)						
YEAR	AVERAGE DAILY TRAFFIC (ADT)			AVERAGE DAILY TRUCK TRAFFIC (ADTT)		
	TO SPRINGBOK	TO CAPE TOWN	TOTAL	TO SPRINGBOK	TO CAPE TOWN	TOTAL
2015	1912	1883	3795	388	387	775
2016	2040	2014	4054	398	409	807
2017	2311	2311	4622	476	492	968
2018	2197	2222	4419	474	473	947
2019	2237	2277	4514	462	473	935
2020	2410	2412	4822	508	516	1024
2021	2500	2502	5002	531	539	1070
2022	2590	2592	5183	554	562	1116
2023	2680	2683	5363	577	585	1162

Between Moorreesburg & Piketberg

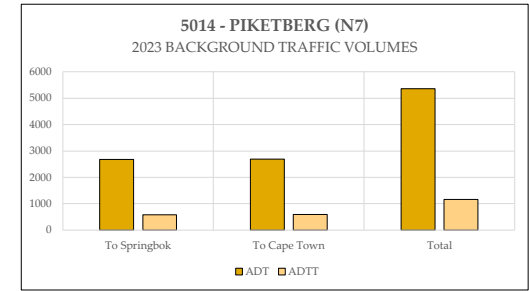
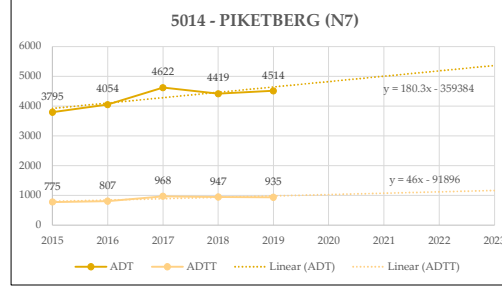

5015 - CITRUSDAL (N7)						
YEAR	AVERAGE DAILY TRAFFIC (ADT)			AVERAGE DAILY TRUCK TRAFFIC (ADTT)		
	TO CLANWILLIAM	TO CITRUSDAL	TOTAL	TO CLANWILLIAM	TO CITRUSDAL	TOTAL
2015	1633	1614	3247	350	340	690
2016	1641	1644	3285	342	344	686
2017	1691	1687	3378	383	383	766
2018	1718	1714	3432	400	393	793
2019	1748	1755	3503	391	393	784
2020	1784	1783	3567	417	415	832
2021	1817	1816	3633	432	430	862
2022	1850	1849	3699	447	444	891
2023	1883	1882	3765	462	459	921

Between Citrusdal & Clanwilliam

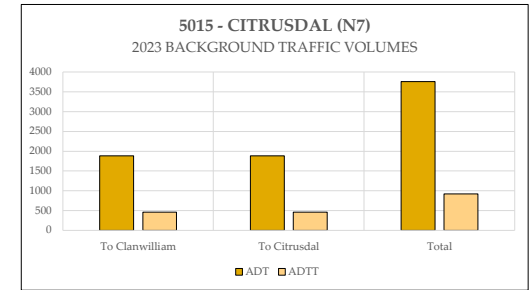
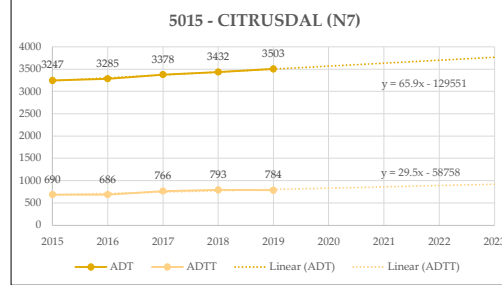

1304 - CALVINIA WEST (R27)							
YEAR	AVERAGE DAILY TRAFFIC (ADT)			AVERAGE DAILY TRUCK TRAFFIC (ADTT)			
	TO CALVINIA	TO NIEUWOUDT VILLE	TOTAL	TO CALVINIA	TO NIEUWOUDT VILLE	TOTAL	TOTAL
2015	373	360	733	93	84	177	177
2016	397	388	785	96	87	183	183
2017	425	413	838	120	110	230	230
2018	428	411	839	131	117	248	248
2019	395	383	778	108	96	204	204
2020	426	412	838	128	116	244	244
2021	433	419	852	135	121	256	256
2022	441	426	867	141	127	268	268
2023	448	433	881	147	133	280	280

Between Nieuwoudville & Calvinia

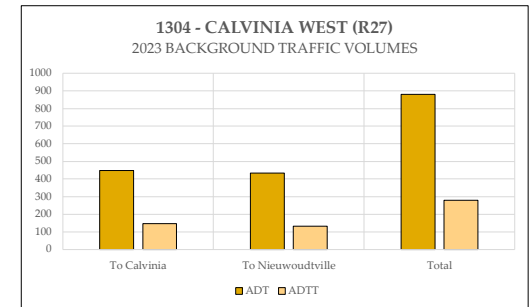
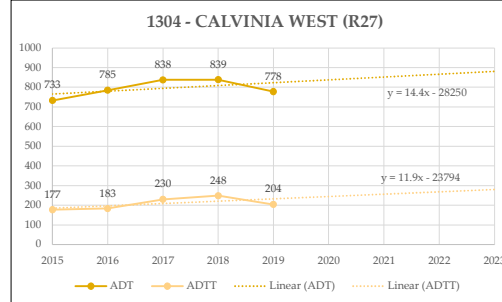

1302 - KEIMOES (N14)						
YEAR	AVERAGE DAILY TRAFFIC (ADT)			AVERAGE DAILY TRUCK TRAFFIC (ADTT)		
	TO UPINGTON	TO KEIMOES	TOTAL	TO UPINGTON	TO KEIMOES	TOTAL
2015	1662	1678	3340	202	201	403
2016	1692	1712	3404	198	198	396
2017	1761	1765	3526	228	228	456
2018	1763	1764	3527	233	229	462
2019	1740	1745	3485	217	217	434
2020	1786	1794	3580	235	234	469
2021	1806	1815	3621	241	241	482
2022	1827	1836	3663	248	247	495
2023	1848	1856	3704	254	253	507

Between Upington & Keimoos

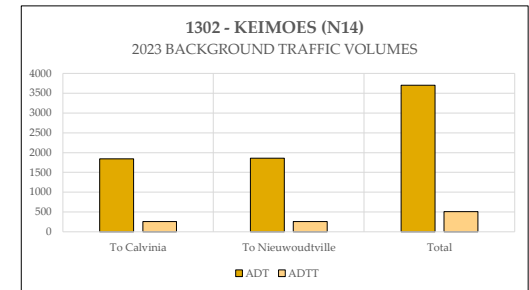
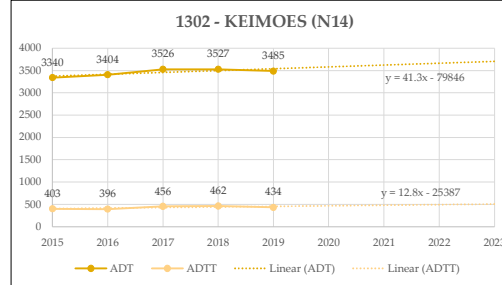

1303 - UPINGTON EAST (N14)						
YEAR	AVERAGE DAILY TRAFFIC (ADT)			AVERAGE DAILY TRUCK TRAFFIC (ADTT)		
	TO OLIFANTSHOEK	TO UPINGTON	TOTAL	TO OLIFANTSHOEK	TO UPINGTON	TOTAL
2015	775	765	1540	178	175	353
2016	770	761	1531	175	169	344
2017	827	822	1649	206	202	408
2018	842	832	1674	209	202	411
2019	806	802	1608	194	193	387
2020	847	837	1684	213	208	421
2021	861	851	1712	220	215	435
2022	875	865	1740	227	221	448
2023	889	879	1768	233	228	462

Between Upington & Olifantshoek

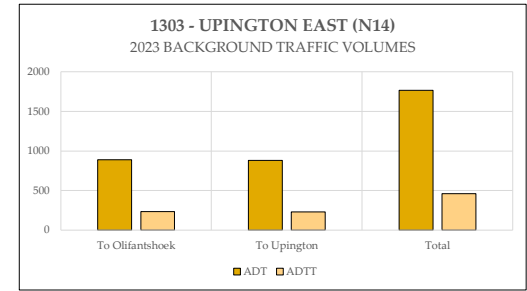
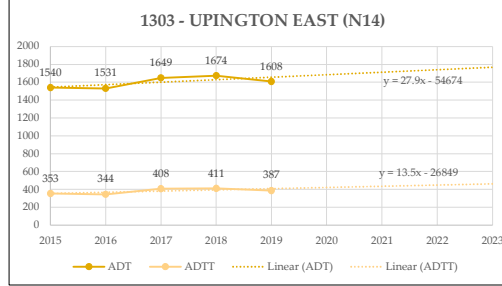

1378 - VRYBURG (N14)						
YEAR	AVERAGE DAILY TRAFFIC (ADT)			AVERAGE DAILY TRUCK TRAFFIC (ADTT)		
	TO DELAREYVILLE	TO VRYBURG	TOTAL	TO DELAREYVILLE	TO VRYBURG	TOTAL
2015	1076	1099	2175	325	333	658
2016	1031	1045	2076	220	229	449
2017	1104	1125	2229	239	258	497
2018	1109	1121	2230	242	255	497
2019	919	945	1864	169	184	353
2020	1134	1155	2289	181	192	373
2021	1150	1171	2321	160	169	330
2022	1165	1187	2353	139	147	286
2023	1181	1203	2384	118	125	243

Between Vryburg & Delareyville

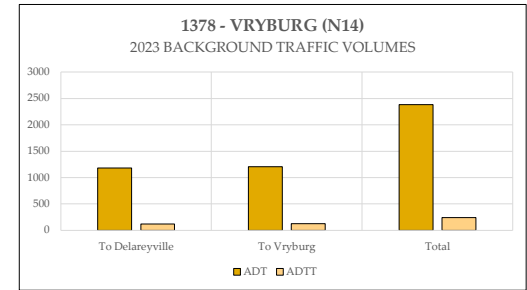
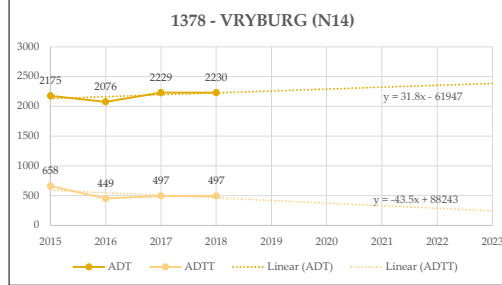

1035 - SANNIESHOF (N14)						
YEAR	AVERAGE DAILY TRAFFIC (ADT)			AVERAGE DAILY TRUCK TRAFFIC (ADTT)		
	TO JOHANNESBURG	TO VRUBURG	TOTAL	TO JOHANNESBURG	TO VRUBURG	TOTAL
2015	1134	1155	2289	168	178	346
2016	1153	1167	2320	163	169	332
2017	1167	1190	2357	160	174	334
2018	1204	1215	2419	169	177	346
2019	1231	1249	2480	181	191	372
2020	1249	1268	2517	178	188	366
2021	1273	1292	2565	181	191	373
2022	1297	1317	2613	184	195	379
2023	1321	1341	2661	188	198	386

Between Baberspan & Sannieshof

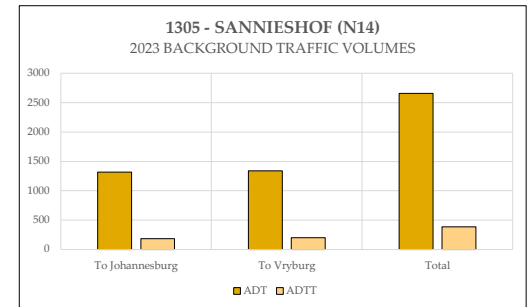
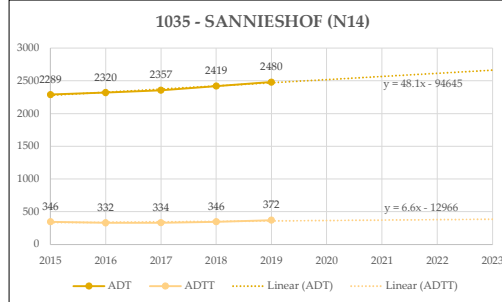

APPENDIX C

TYPICAL ACCESS GEOMETRY

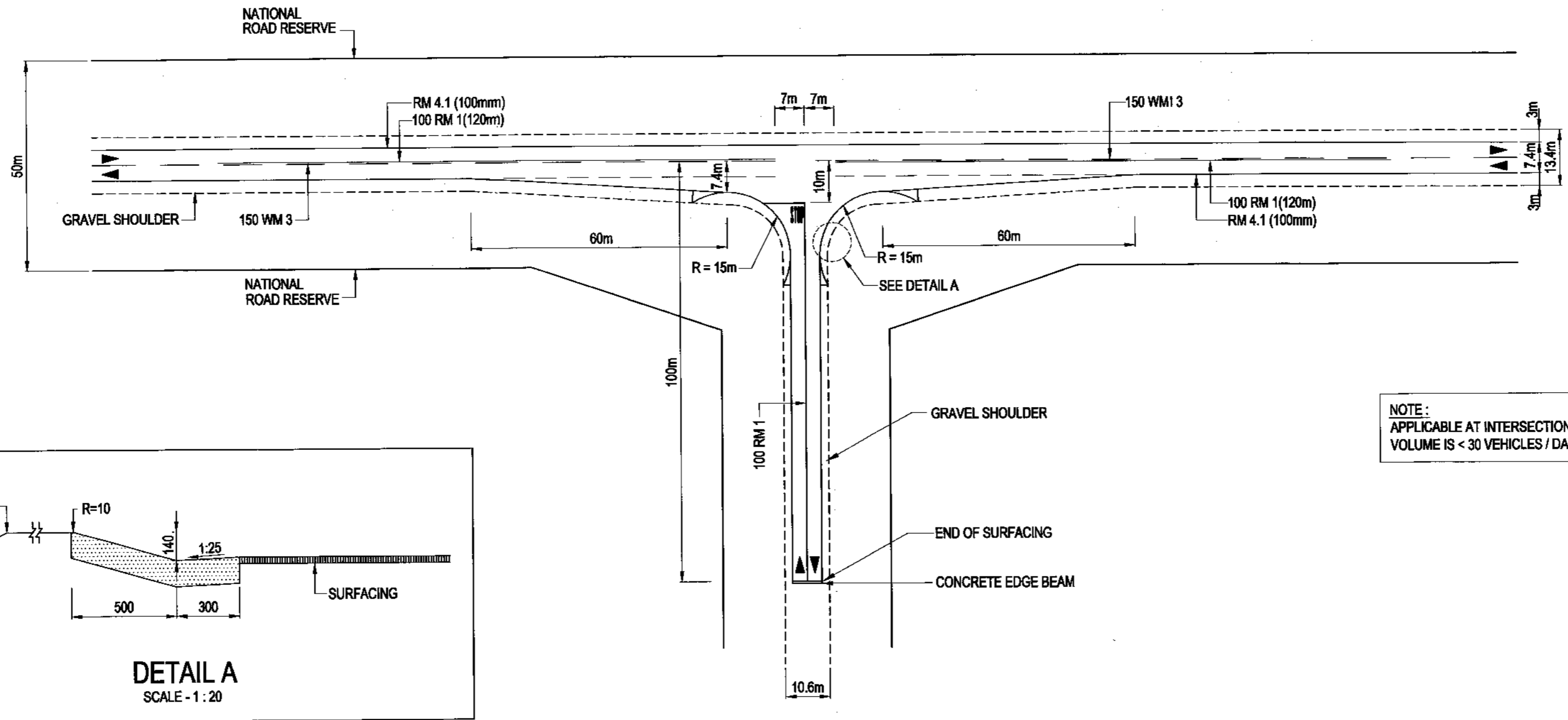

ROAD MARKING LEGEND	
RM 1	= NO OVERTAKING LINE
RM 4.1	= LEFT EDGE LINE
WM 3	= DIVIDING LINE

NOTE:
APPLICABLE AT INTERSECTIONS WHERE THE RIGHT TURNING VOLUME IS < 30 VEHICLES / DAY.

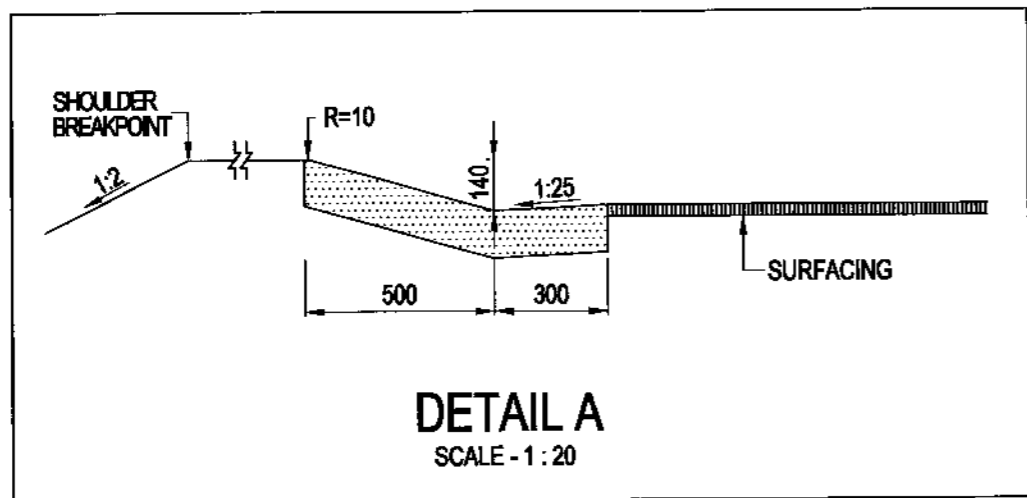
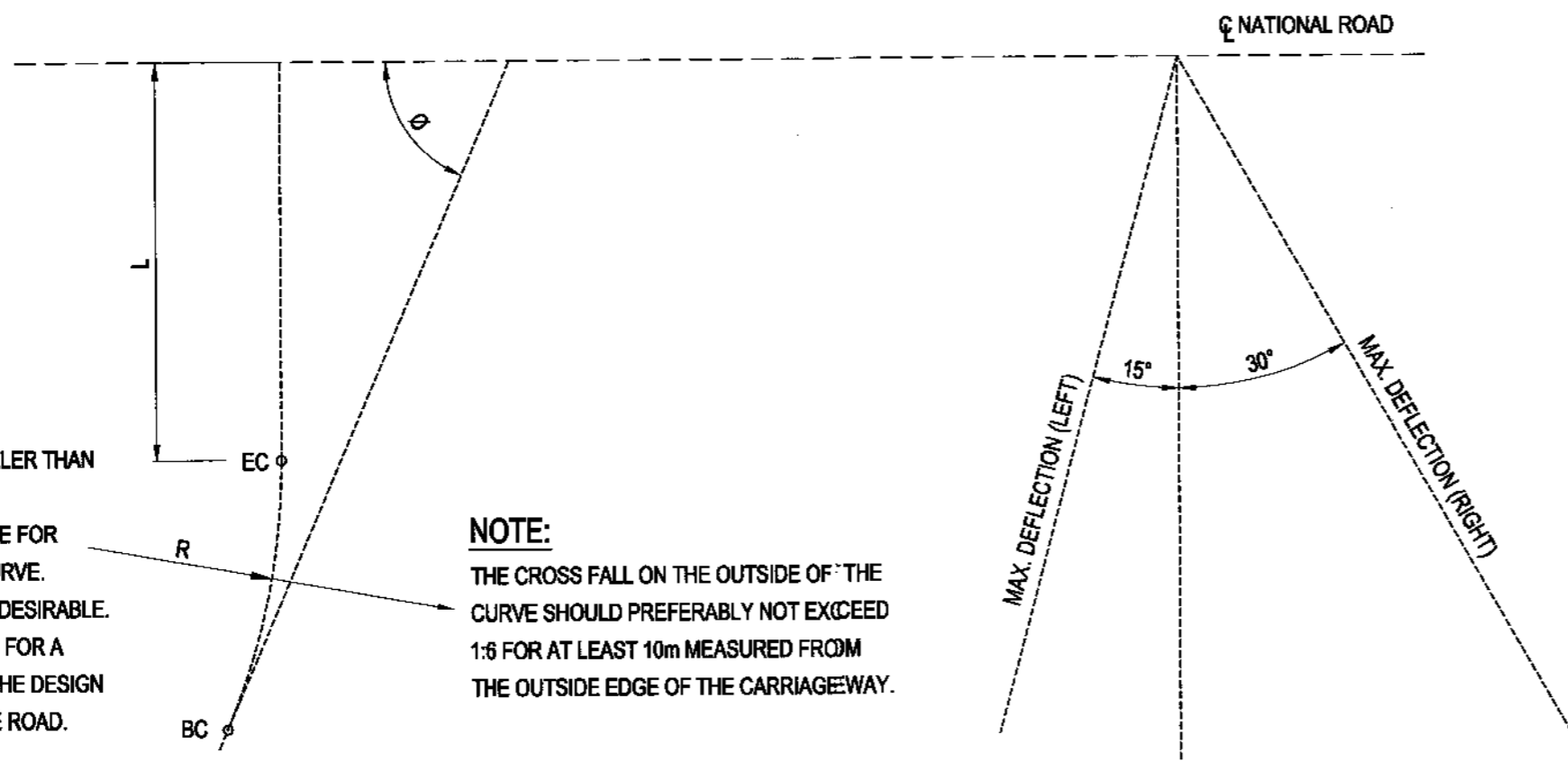

TABLE 1 SHOULDER SIGHT DISTANCE FOR STOP CONDITIONS	
DESIGN SPEED (THROUGH ROAD) (km/h)	SIGHT DISTANCE (D) (m)
50	150
60	180
70	210
80	240
90	270
100	300
110	330
120	360



- NOTE**
- θ = DEFLECTION ANGLE SMALLER THAN SAFE ANGLE.
 - L = STOPPING SIGHT DISTANCE FOR DESIGN SPEED FOR LAST CURVE. MINIMUM LENGTH OF 155m IS DESIRABLE.
 - R = CORRESPONDING RADIUS FOR A SPEED 15km/h LOWER THAN THE DESIGN SPEED FOR THE REST OF THE ROAD.

NOTE:
THE CROSS FALL ON THE OUTSIDE OF THE CURVE SHOULD PREFERABLY NOT EXCEED 1:6 FOR AT LEAST 10m MEASURED FROM THE OUTSIDE EDGE OF THE CARRIAGEWAY.

SAFE ANGLES AND STOPPING SIGHT DISTANCE AT T-JUNCTIONS
SCALE - N.T.S

- NOTE:**
- GRADIENT ON BOTH ROADS SHOULD NOT EXCEED 3%, ESPECIALLY ON THE JUNCTION LEG.
 - TABLE 1 CAN BE USED AS A BASIC GUIDELINE ON CONDITION THAT THE GRADIENTS ON BOTH THE JUNCTION AND PRIMARY ROADS DO NOT EXCEED 2%. THE SIGHT DISTANCE MUST BE MEASURED FROM AN EYE LEVEL OF 1,05m FROM A POINT 2m BEFORE THE STOP LINE ON THE JUNCTION ROAD TO AN OBJECT HEIGHT ON THE CENTRE LINE OF THE NATIONAL ROAD OF 1,30m.
 - THE DESIRABLE MINIMUM SIGHT DISTANCE IS 300m.
 - FOR DETAIL OF ROAD MARKINGS REFER TO THE SADC ROAD TRAFFIC SIGNS MANUAL.
 - THIS PLAN SERVES AS A GUIDE LINE AND WELL MOTIVATED DEVIATIONS MAY BE CONSIDERED.
 - WHERE APPLICABLE CROSS-SECTION DIMENSIONS MUST BE ADJUSTED ACCORDING TO THE APPROVED TYPICAL CROSS-SECTION BEING USED.

FOR LATEST VERSION CHECK www.nra.co.za

No.	DATE	VERSION / REVISION	APPROVED
V1	SEPT 2014	ORIGINAL VERSION	

SANRAL TYPICAL DRAWINGS

COPYRIGHT: THIS DRAWING IS PROTECTED IN TERMS OF THE COPYRIGHT ACT No. 98 OF 1978 AND MAY NOT BE REPRODUCED WITHOUT PERMISSION IN WRITING FROM SANRAL.

CONDITIONS FOR USE: CONSULTANTS APPOINTED BY SANRAL SHALL INCORPORATE THE TYPICAL DETAILS HEREON INTO THEIR SPECIFIC DESIGN FOR WHICH THEY WILL ASSUME FULL PROFESSIONAL RESPONSIBILITY. THIS TYPICAL DRAWING MAY NOT BE USED FOR TENDER PURPOSES.



HEAD OFFICE
48 Tambolle Avenue
Val de Grace
Pretoria
0184
PO Box 415
Pretoria 0001
South Africa
Tel: (012) 844 8000

M. v. d. Merwe
APPROVED
DATE: 2015/06/26

TYPICAL DRAWINGS - ROADWORKS
T - JUNCTIONS & INTERSECTIONS
T - JUNCTION WITH GRAVEL
CLASS 2 ROADS

SANRAL DOC. No. (PDF)
1693224
SANRAL DOC. No. (DWG)
1797268
SANRAL DRAWING No.
TD-R-JI-1100-V1

APPENDIX D

CUMULATIVE IMPACT AND SIGNIFICANCE TABLE

Cumulative Assessment: Traffic Impact Study

For ease of reference the significance of the impacts are colour coded as follows:

Low significance		Medium significance		High significance		Positive impact	
------------------	--	---------------------	--	-------------------	--	-----------------	--

PROPOSED DEVELOPMENT	PROJECT STATUS	APPLICANT	PROPOSED CAPACITY	DISTANCE FROM STUDY AREA (km)	FARM DETAILS	IMPACTS								POSSIBLE MITIGATION MEASURES
						CONSTRUCTION PERIOD						OPER.	DECOM	
						ADDITIONAL TRIPS GENERATED	IMPACT ON LONG DISTANCE ROUTES	IMPACT ON LOCAL TRAFFIC	AFFECTED COMMUNITIES - TRAFFIC	AFFECTED COMMUNITIES - WORK POSSIBILITY	INTENSITY	DURATION	DAILY COMMUTES	
Setaria SEF	In Process	Setaria PV (Pty) Ltd	Up to 75 MW	-	Portions 1, 9 and 10 of the farm Houthaalboomen No. 31	Low	Low	Low	Low	Pos. impact	Low	Low	Low	<p>Access to the sites will be via existing or proposed gravel roads. These gravel roads will most likely need to be extended and will need to be suitably maintained. Re-gravelling may be necessary as a maintenance measure, from time to time, throughout the operational life of the solar power plants.</p> <p>Adequate traffic accommodation signage must be erected and maintained on either side of the access, on the trafficked routes, throughout the construction period.</p> <p>Individual impacts are low and the cumulative effect of these are expected to approach medium significance in some instances but will remain of low significance.</p>
Dicoma SEF	In Process	Dicoma PV (Pty) Ltd	Up to 75 MW	-	Portions 1, 9 and 10 of the farm Houthaalboomen No. 31	Low	Low	Low	Low	Pos. impact	Low	Low	Low	
Hibernia Solar Energy Facility	Authorized	South Africa Mainstream Renewable Power Developments (Pty) Ltd	-	11.5 km	Portions 9 & 31 of the farm Hibernia No. 52	Low	Low	Low	Low	Pos. impact	Low	Low	Low	
Lichtenburg 1 Solar PV Energy	Authorized	ABO Wind Lichtenburg 1 PV (Pty) Ltd	100 MW	6.1 km	Portion 6 of the farm Zamenkomst No. 4	Low	Low	Low	Low	Pos. impact	Low	Low	Low	
Lichtenburg 2 Solar PV Energy	Authorized	ABO Wind Lichtenburg 2 PV (Pty) Ltd	100 MW	5.0 km	Portion 23 of the farm Houthaalbomen No. 31	Low	Low	Low	Low	Pos. impact	Low	Low	Low	
Lichtenburg 3 Solar PV Energy	Authorized	ABO Wind Lichtenburg 3 PV (Pty) Ltd	100 MW	4.0 km	Remaining Extent of Portion 2 of the farm Zamenkomst No. 4	Low	Low	Low	Low	Pos. impact	Low	Low	Low	

PROPOSED DEVELOPMENT	PROJECT STATUS	APPLICANT	PROPOSED CAPACITY	DISTANCE FROM STUDY AREA (km)	FARM DETAILS	IMPACTS								POSSIBLE MITIGATION MEASURES
						CONSTRUCTION PERIOD						OPER.	DECOM	
						ADDITIONAL TRIPS GENERATED	IMPACT ON LONG DISTANCE ROUTES	IMPACT ON LOCAL TRAFFIC	AFFECTED COMMUNITIES - TRAFFIC	AFFECTED COMMUNITIES - WORK POSSIBILITY	INTENSITY	DURATION	DAILY COMMUTES	
Trisitseng PV 1 SEF	Authorized	BioTherm Energy (Pty) Ltd	75 MW	1.8 km	Portion 25 of the farm Houthaalbomen No. 31	Low	Low	Low	Low	Pos. impact	Low	Low	Low	
Trisitseng PV 2 SEF	Authorized	BioTherm Energy (Pty) Ltd	75 MW	1.8 km	Portion 25 of the farm Houthaalbomen No. 31 Portions 1, 9, 10 & 18 of the farm Houthaalbomen No. 31	Low	Low	Low	Low	Pos. impact	Low	Low	Low	

APPENDIX E

ASSESSMENT METHODOLOGY

Assessment Methodology

Direct, indirect and cumulative impacts associated with the projects must be assessed in terms of the following criteria:

- The nature, which shall include a description of what causes the effect, what will be affected and how it will be affected.
- The extent, wherein it will be indicated whether the impact will be local (limited to the immediate area or site of development) or regional, and a value between 1 and 5 will be assigned as appropriate (with 1 being low and 5 being high):
- The duration, wherein it will be indicated whether:
 - the lifetime of the impact will be of a very short duration (0–1 years) – assigned a score of 1;
 - the lifetime of the impact will be of a short duration (2-5 years) - assigned a score of 2;
 - medium-term (5–15 years) – assigned a score of 3;
 - long term (> 15 years) - assigned a score of 4; or
 - permanent - assigned a score of 5;
- The magnitude, quantified on a scale from 0-10, where 0 is small and will have no effect on the environment, 2 is minor and will not result in an impact on processes, 4 is low and will cause a slight impact on processes, 6 is moderate and will result in processes continuing but in a modified way, 8 is high (processes are altered to the extent that they temporarily cease), and 10 is very high and results in complete destruction of patterns and permanent cessation of processes.
- The probability of occurrence, which shall describe the likelihood of the impact actually occurring. Probability will be estimated on a scale of 1–5, where 1 is very improbable (probably will not happen), 2 is improbable (some possibility, but low likelihood), 3 is probable (distinct possibility), 4 is highly probable (most likely) and 5 is definite (impact will occur regardless of any prevention measures).
- The significance, which shall be determined through a synthesis of the characteristics described above and can be assessed as low, medium or high; and
 - the status, which will be described as either positive, negative or neutral.
 - the degree to which the impact can be reversed.
 - the degree to which the impact may cause irreplaceable loss of resources.
 - the degree to which the impact can be mitigated.

The significance is calculated by combining the criteria in the following formula:

$$S=(E+D+M)P$$

S = Significance weighting

E = Extent

D = Duration

M = Magnitude

P = Probability

The significance weightings for each potential impact are as follows:

- < 30 points: Low (i.e. where this impact would not have a direct influence on the decision to develop in the area),
- 30-60 points: Medium (i.e. where the impact could influence the decision to develop in the area unless it is effectively mitigated),
- > 60 points: High (i.e. where the impact must have an influence on the decision process to develop in the area).