

Appendix C5:  
Organs of State Correspondence

## Nicolene Venter

---

**From:** Savannah Environmental Public Process <publicprocess@savannahsa.com>  
**Sent:** Thursday, 03 February 2022 10:40  
**To:** Francois Strydom  
**Cc:** Nicolene Venter  
**Subject:** SE3107: Houthaalboomen PV Cluster – Notification of availability of the EIA Reports  
**Attachments:** SE3107-Houthaalbomen\_PV\_Cluster\_EIARs\_OoS\_Notification\_Letter-FINAL.pdf

**HOUTHAALBOOMEN PV CLUSTER CONSISTING OF BARLERIA PV, DICOMA PV, AND SETARIA PV FACILITIES, NORTH WEST PROVINCE**

**(DFFE Reference Nos.: 14/12/16/3/3/2/2107; 14/12/16/3/3/2/2108 & 14/12/16/3/3/2/2106 respectively)**

Dear Key Stakeholders,

Savannah Environmental (Pty) Ltd, the appointed Environmental Assessment Practitioner (EAP), notified you, as a Stakeholder and a registered interested and affected party (I&AP), in October 2021 of the availability of the Scoping Reports for the above-mentioned projects for your review and comments. The final Scoping Reports were submitted to the Department of Forestry, Fisheries and the Environment (DFFE) on Friday, 26 November 2021.

In terms of Regulation 43.(2), EIA Regulations 2017, as amended, the attached letter serves to inform you that the Environmental Impact Assessment Report (EIAR) for each application are available for your Department's / Organisation's review and written comments for a 30-day period from from **Monday, 07 February 2022** until **Wednesday, 09 March 2022**.

The attached notification letter serves to inform you that:

- the DFFE accepted the Scoping Reports and approved the Plan of Study for the Environmental Impact Assessment (EIA) phase;
- that the EIA processes commencing with the impact phase of the studies;
- the availability of the EIA Reports for your review and comment; and
- invitation to attend any one of the two (2), or both, of the on-line public participation process meetings.

Kind regards,

[Unsubscribe this type of email](#)



t: 011 656 3237  
f: 086 684 0547

**Nicolene Venter**  
Public Process

e: publicprocess@savannahsa.com  
c: +27 (0) 60 978 8396

SAWEA Award for Leading Environmental Consultant on Wind Projects in 2013 & 2015

03 February 2022

Dear Stakeholder,

**HOUTHAALBOOMEN PV CLUSTER CONSISTING OF BARLERIA PV, DICOMA PV, AND SETARIA PV FACILITIES,  
NORTH WEST PROVINCE  
(DFFE Reference Nos.: 14/12/16/3/3/2/2107; 14/12/16/3/3/2/2108 & 14/12/16/3/3/2/2106 respectively)**

**NOTICE OF AVAILABILITY OF ENVIRONMENTAL IMPACT ASSESSMENT REPORTS FOR REVIEW AND COMMENT**

Savannah Environmental (Pty) Ltd, the appointed Environmental Assessment Practitioner (EAP), notified you, as a Stakeholder and a registered interested and affected party (I&AP), in October 2021 of the availability of the Scoping Reports for the above-mentioned projects for your review and comments. The final Scoping Reports were submitted to the Department of Forestry, Fisheries and the Environment (DFFE) on Friday, 26 November 2021.

We would like to take this opportunity to inform you, as a Stakeholders and a registered I&AP, that:

- The DFFE has accepted the final Scoping Reports, inclusive of the Plan of Study for the Environmental Impact Assessments (EIAs) in terms of Regulation 22 (a) of the EIA Regulations, 2014, as amended. A letter in this regard was received, on Thursday, 27 January 2022.
- Savannah Environmental has commenced with the EIA process in accordance with the tasks contemplated in the Plan of Study for EIA as required in terms of the EIA Regulations, 2014, as amended.
- The final EIA reports, inclusive of the specialist studies, record of the public participation undertaken, and the Environmental Management Programme (EMPr) is due for submission to DFFE, as per the EIA Regulation 23(1) of the EIA Regulations, 2014, as amended, within 107days of the Scoping Reports acceptance.

Although there are various timeframes associated with the environmental authorisation process, it is important to note that the public participation is an on-going process, allowing I&APs to interact with the project team and to submit queries or comments throughout the environmental authorisation process. We encourage you to contact our team with any queries or comments regarding the project at any time during the process.

## ENVIRONMENTAL IMPACT ASSESSMENT REPORTS AVAILABLE FOR REVIEW AND COMMENT

In terms of Regulation 43.(2), EIA Regulations 2017, as amended, this letter serves to inform you that the Environmental Impact Assessment Report (EIAR) for each are available for your Department's / Organisation's review and written comments for a 30-day period from from **Monday, 07 February 2022** until **Wednesday, 09 March 2022**.

The reports are available for download from Savannah Environmental website: <https://savannahsa.com/public-documents/energy-generation/houthaalbomen-pv-cluster/>. All comments received during the 30-day review and comment period will be recorded and included in the Final Environmental Impact Assessment Reports for submission to the Department of Forestry, Fisheries and the Environment (DFFE) in line with Regulation 44 of the EIA Regulations, 2014, as amended (GN R326).

Please note Regulation 3(1) of the Environmental Impact Assessment Regulations, 2014, as amended, i.e.:

*Subject to subregulations (2) and (3), when a period of days must in terms of these Regulations be reckoned from or after a particular day, that period must be reckoned as from the start of the day following that particular day to the end of the last day of the period, but if the last day of the period falls on a Saturday, Sunday or public holiday, that period must be extended to the end of the next day which is not a Saturday, Sunday or public holiday.*

## INVITATION TO AND NOTIFICATION OF ONLINE PUBLIC PARTICIPATION PROCESS MEETINGS

You are invited to attend any one of the two (or both) online public participation process meetings which will take place on:

Date	Time
Tuesday, 22 February 2022	14h00
	18h00

The meetings are being hosted via MS Teams, in compliance with COVID-19 protocols, as well as to ensure that attendance is unrestricted. You are kindly requested to register your attendance for the online public participation process meeting that you want to attend with Nicolene Venter at [publicprocess@savannahsa.com](mailto:publicprocess@savannahsa.com) to receive the virtual link for attendance.

As the country had moved to COVID-19 Alert Level 1 on 01 October 2021, physical in-person meetings may take place on the condition that COVID-19 sanitation requirements at the venue are provided. Savannah Environmental would like to offer all I&APs and representatives from stakeholder groupings an opportunity to submit their request, should they have a need for an in-person meeting to discuss the proposed project and the findings of the EIA studies to Nicolene Venter at [publicprocess@savannahsa.com](mailto:publicprocess@savannahsa.com) or SMS / WhatsApp on 060 978 8396.

Please do not hesitate to contact us should you require additional information and/or clarification regarding the project. Our team welcomes your participation and look forward to your involvement throughout this process.

Kind regards



**Nicolene Venter**

Public Participation and Social Consultant

Email: [publicprocess@savannahsa.com](mailto:publicprocess@savannahsa.com)

abc  Format: HTML

Normal Calibri Size (CTRL+S) **B** / U A 

**HOUTHAAALBOOMEN PV CLUSTER CONSISTING OF BARLERIA PV, DICOMA PV, AND SETARIA PV FACILITIES, NORTH WEST PROVINCE**  
**(DFFE Reference Nos.: 14/12/16/3/3/2/2107; 14/12/16/3/3/2/2108 & 14/12/16/3/3/2/2106 respectively)**

Dear Key Stakeholders,

Savannah Environmental (Pty) Ltd, the appointed Environmental Assessment Practitioner (EAP), notified you, as a Stakeholder and a registered interested and affected party (I&AP), in October 2021 of the availability of the Scoping Reports for the above-mentioned projects for your review and comments. The final Scoping Reports were submitted to the Department of Forestry, Fisheries and the Environment (DFFE) on Friday, 26 November 2021.

In terms of Regulation 43.(2), EIA Regulations 2017, as amended, the attached letter serves to inform you that the Environmental Impact Assessment Report (EIAR) for each application are available for your Department's / Organisation's review and written comments for a 30-day period from from **Monday, 07 February 2022** until **Wednesday, 09 March 2022**.

The attached notification letter serves to inform you that:

- the DFFE accepted the Scoping Reports and approved the Plan of Study for the Environmental Impact Assessment (EIA) phase;
- that the EIA processes commencing with the impact phase of the studies;
- the availability of the EIA Reports for your review and comment; and
- invitation to attend any one of the two (2), or both, of the on-line public participation process meetings.

Kind regards,

[Unsubscribe this type of email](#)

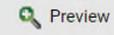
 Design  HTML  Preview

SAVE

CLOSE

[Print](#)

# SE3107: Houthaalbomen PV Cluster - EIARs Notification of availability for review and comment (OoS & KSHs) (POE)

Date:  
Thursday, 03  
February  
2022  
Time: 10:41

Company	Last Name	First Name	
African Farmers Association of South Africa	Masithela	Neo	
African Farmers Association of South Africa	Mathidi	Tshiane	
African Farmers Association of South Africa	Mthembu	AJ	
Afriforum	Grobler	Gabrie	
Agri North West	de Chavonnes Vrugt	Willem	
Agri North West	Du Toit	Boeta	
Agri North West	Du Toit	P	
Agri North West	Pienaar	Naude	
Agri North West	Van der Merwe	Daan	
Agri North West	Van Zyl	Cobus	
Agri North West	Venter	Jaco	
Agri North West Farmers Union	van wyk	Eric	
AgriSA	Rabie	Janse	
Air Traffic and Navigation Services (ATNS)	Masilela	Simphiwe	
Air Traffic Navigation Services	Masilela	Simphiwe	
BirdLife South Africa	Ralston-Paton	Samantha	
Black Farmers Association of South Africa	Mtshagi	Lennox	
Co-Operative Governance & Traditional Leaders	Diphofa	Mashwahle	
Co-Operative Governance & Traditional Leaders	Williamson	Avril	
Department of Agriculture, Forestry & Fisheries	Gombela	Cherity	
Department of Agriculture, Forestry & Fisheries	Krisjan	Portia	
Department of Agriculture, Forestry & Fisheries	Mnguni	Sambulo	
Department of Agriculture, Forestry & Fisheries	Niewoudt (Wessels)	Carene	
Department of Agriculture, Forestry & Fisheries	Phahladira	Selekane	
Department of Forestry, Fisheries and the Environment	Buthelezi	Thoko	
Department of Forestry, Fisheries and the Environment	Kutu	Lydia	
Department of Forestry, Fisheries and the Environment	Lekota	Seoka	
Department of Forestry, Fisheries and the Environment	Makitla	Portia	
Department of Forestry, Fisheries and the Environment	Mambane	Salome	
Department of Forestry, Fisheries and the Environment	Marubini	Mashudu	
Department of Forestry, Fisheries and the Environment	Mathebula	Kevin	
Department of Forestry, Fisheries and the Environment	Setshoane	Itumeleng	
Department of Forestry, Fisheries and the Environment	Sundani	Mulalo	
Department of Mineral Resources	Swart	Pieter	
Department of Water and Sanitation	Peggy	Mabuza	
Department of Water and Sanitation	Ratau	Sputnik	
Endangered Wildlife Trust	Hoogstad	Constant	
Eskom Holdings SOC Ltd	Galela	Noxolo	
Eskom Holdings SOC Ltd	Geeringh	John	
Eskom Holdings SOC Ltd	Mare	Charmaine	

Eskom Holdings SOC Ltd	Sebole	Mpho	
Federation for Sustainable Environment	Liefferink	Mariette	
NW Department of Community Safety & Transport Management	Mahlakoleng	Bailey	
NW Department of Economic Development	Tlaletsi	Abbey	
NW Department of Energy	Mahlaku	Matshediso	
NW Department of Energy	Mosadi	Lesego	
NW Department of Energy	Sethosa	Tebogo	
NW Department of Energy	Sethosa	Tebogo	
NW Department of Local Government & Traditional Affairs	Molosi	Mpho	
NW Department of Local Government & Traditional Affairs	Ramagaga	Seth	
NW Department of Public Works & Roads	Mafune	Alfred	
NW Department of Roads and Transport	Thamae	M	
NW Department of Rural, Environment & Agricultural Development	Boshoff	Tharina	
NW Department of Rural, Environment & Agricultural Development	Dintwe	Tsholofelo	
NW Department of Rural, Environment & Agricultural Development	Mahlangu	Eva	
NW Department of Rural, Environment & Agricultural Development	Mahlangu	Eva	
NW Department of Rural, Environment & Agricultural Development	Mahlangu	Eva	
NW Department of Rural, Environment & Agricultural Development	Mohlalisi	Motshabi	
NW Department of Rural, Environment & Agricultural Development	Moholo	Obitseng	
NW Department of Rural, Environment & Agricultural Development	Mojahi	Kgosi	
NW Department of Rural, Environment & Agricultural Development	Serage	Dipepeneng	
NW Department of Rural, Environment & Agricultural Development	Skosana	Ouma	
NW PHRA	Mosiane	Motlhabane	
NW PHRA	Motlhabane	Mosiane	
NW PHRA	Omar	Shahnaz	
SAHRA	Higgitt	Natasha	
SAHRA	Khumalo	Nokukhanya	
SANRAL	Barkhuizen	Ria	
SANRAL	Bota	Victoria	
SANRAL	Olivier	Jan	
SANRAL	Yorke-Hart	Michael	
Sentech Ltd	Motlhake	Serame	
Sentech Ltd	Sentech		
South Africa Defense Force	Strydom	Francois	
South African Bat Assessment Advisory Panel (SABAAP)	MacEwan	Kate	
South African Bat Assessment Association	Lotter	Caroline	
South African Civil Aviation Authority	Stroh	Lizelle	
South African Civil Aviation Authority	Vilakazi	Zwelithini	
South African Department of Defence	Zondi	Lt. Col. Kebasenos	
South African Radio Astronomy Observatory (SARAO)	Nape	Thato	
South African Radio Astronomy Observatory (SARAO)	Sithole	Busang	
South African Radio Astronomy Observatory (SARAO)	Tiplady	Adrian	
South African Weather Services	Jardine	Rydall	
South African Weather Services	Petlane	Bernard	
Transvaal Landbou-Unie SA	Celliers	Johan	
Transvaal Landbou-Unie SA	du Plessis	DJ	
Transvaalse Landbou Unie	Du Plessis	Danie	
Wildlife and Environment Society of South Africa (WESSA)	Griffiths	Morgan	
Wildlife and Environment Society of South Africa (WESSA)	Wesson	John	
Wildlife and Environment Society of South Africa (WESSA)	Wesson	John	

Totals:

## Nicolene Venter

---

**From:** Savannah Environmental Public Process <publicprocess@savannahsa.com>  
**Sent:** Thursday, 03 February 2022 12:30  
**To:** Sakkie Groenewald  
**Cc:** Nicolene Venter  
**Subject:** SE3107: Houthaalboomen PV Cluster – Notification of availability of the EIA Reports  
**Attachments:** SE3107-Houthaalbomen\_PV\_Cluster\_EIARs\_OoS\_Notification\_Letter-FINAL.pdf

**HOUTHAALBOOMEN PV CLUSTER CONSISTING OF BARLERIA PV, DICOMA PV, AND SETARIA PV FACILITIES, NORTH WEST PROVINCE**

**(DFFE Reference Nos.: 14/12/16/3/3/2/2107; 14/12/16/3/3/2/2108 & 14/12/16/3/3/2/2106 respectively)**

Dear Ngaka Modiri Molema District and Ditsobotla Local Municipal Officials,

Savannah Environmental (Pty) Ltd, the appointed Environmental Assessment Practitioner (EAP), notified you, as a Stakeholder and a registered interested and affected party (I&AP), in October 2021 of the availability of the Scoping Reports for the above-mentioned projects for your review and comments. The final Scoping Reports were submitted to the Department of Forestry, Fisheries and the Environment (DFFE) on Friday, 26 November 2021.

In terms of Regulation 43.(2), EIA Regulations 2017, as amended, the attached letter serves to inform you that the Environmental Impact Assessment Report (EIAR) for each application are available for your Department's / Organisation's review and written comments for a 30-day period from from Monday, 07 February 2022 until Wednesday, 09 March 2022.

The attached notification letter serves to inform you that:

- the DFFE accepted the Scoping Reports and approved the Plan of Study for the Environmental Impact Assessment (EIA) phase;
- that the EIA processes commencing with the impact phase of the studies;
- the availability of the EIA Reports for your review and comment; and
- invitation to attend any one of the two (2), or both, of the on-line public participation process meetings.

Kind regards,

[Unsubscribe this type of email](#)



t: 011 656 3237  
f: 086 684 0547

**Nicolene Venter**  
Public Process

e: publicprocess@savannahsa.com  
c: +27 (0) 60 978 8396

SAWEA Award for Leading Environmental Consultant on Wind Projects in 2013 & 2015



03 February 2022

Dear Stakeholder,

**HOUTHAALBOOMEN PV CLUSTER CONSISTING OF BARLERIA PV, DICOMA PV, AND SETARIA PV FACILITIES,  
NORTH WEST PROVINCE  
(DFFE Reference Nos.: 14/12/16/3/3/2/2107; 14/12/16/3/3/2/2108 & 14/12/16/3/3/2/2106 respectively)**

**NOTICE OF AVAILABILITY OF ENVIRONMENTAL IMPACT ASSESSMENT REPORTS FOR REVIEW AND COMMENT**

Savannah Environmental (Pty) Ltd, the appointed Environmental Assessment Practitioner (EAP), notified you, as a Stakeholder and a registered interested and affected party (I&AP), in October 2021 of the availability of the Scoping Reports for the above-mentioned projects for your review and comments. The final Scoping Reports were submitted to the Department of Forestry, Fisheries and the Environment (DFFE) on Friday, 26 November 2021.

We would like to take this opportunity to inform you, as a Stakeholders and a registered I&AP, that:

- The DFFE has accepted the final Scoping Reports, inclusive of the Plan of Study for the Environmental Impact Assessments (EIAs) in terms of Regulation 22 (a) of the EIA Regulations, 2014, as amended. A letter in this regard was received, on Thursday, 27 January 2022.
- Savannah Environmental has commenced with the EIA process in accordance with the tasks contemplated in the Plan of Study for EIA as required in terms of the EIA Regulations, 2014, as amended.
- The final EIA reports, inclusive of the specialist studies, record of the public participation undertaken, and the Environmental Management Programme (EMPr) is due for submission to DFFE, as per the EIA Regulation 23(1) of the EIA Regulations, 2014, as amended, within 107days of the Scoping Reports acceptance.

Although there are various timeframes associated with the environmental authorisation process, it is important to note that the public participation is an on-going process, allowing I&APs to interact with the project team and to submit queries or comments throughout the environmental authorisation process. We encourage you to contact our team with any queries or comments regarding the project at any time during the process.

## ENVIRONMENTAL IMPACT ASSESSMENT REPORTS AVAILABLE FOR REVIEW AND COMMENT

In terms of Regulation 43.(2), EIA Regulations 2017, as amended, this letter serves to inform you that the Environmental Impact Assessment Report (EIAR) for each are available for your Department's / Organisation's review and written comments for a 30-day period from from **Monday, 07 February 2022** until **Wednesday, 09 March 2022**.

The reports are available for download from Savannah Environmental website: <https://savannahsa.com/public-documents/energy-generation/houthaalbomen-pv-cluster/>. All comments received during the 30-day review and comment period will be recorded and included in the Final Environmental Impact Assessment Reports for submission to the Department of Forestry, Fisheries and the Environment (DFFE) in line with Regulation 44 of the EIA Regulations, 2014, as amended (GN R326).

Please note Regulation 3(1) of the Environmental Impact Assessment Regulations, 2014, as amended, i.e.:

*Subject to subregulations (2) and (3), when a period of days must in terms of these Regulations be reckoned from or after a particular day, that period must be reckoned as from the start of the day following that particular day to the end of the last day of the period, but if the last day of the period falls on a Saturday, Sunday or public holiday, that period must be extended to the end of the next day which is not a Saturday, Sunday or public holiday.*

## INVITATION TO AND NOTIFICATION OF ONLINE PUBLIC PARTICIPATION PROCESS MEETINGS

You are invited to attend any one of the two (or both) online public participation process meetings which will take place on:

Date	Time
Tuesday, 22 February 2022	14h00
	18h00

The meetings are being hosted via MS Teams, in compliance with COVID-19 protocols, as well as to ensure that attendance is unrestricted. You are kindly requested to register your attendance for the online public participation process meeting that you want to attend with Nicolene Venter at [publicprocess@savannahsa.com](mailto:publicprocess@savannahsa.com) to receive the virtual link for attendance.

As the country had moved to COVID-19 Alert Level 1 on 01 October 2021, physical in-person meetings may take place on the condition that COVID-19 sanitation requirements at the venue are provided. Savannah Environmental would like to offer all I&APs and representatives from stakeholder groupings an opportunity to submit their request, should they have a need for an in-person meeting to discuss the proposed project and the findings of the EIA studies to Nicolene Venter at [publicprocess@savannahsa.com](mailto:publicprocess@savannahsa.com) or SMS / WhatsApp on 060 978 8396.

Please do not hesitate to contact us should you require additional information and/or clarification regarding the project. Our team welcomes your participation and look forward to your involvement throughout this process.

Kind regards



**Nicolene Venter**

Public Participation and Social Consultant

Email: [publicprocess@savannahsa.com](mailto:publicprocess@savannahsa.com)

abc  Format: HTML

Normal Calibri Size (CTRL+S) **B** / *I* U A 

**HOUTHAAALBOOMEN PV CLUSTER CONSISTING OF BARLERIA PV, DICOMA PV, AND SETARIA PV FACILITIES, NORTH WEST PROVINCE**  
(DFFE Reference Nos.: 14/12/16/3/3/2/2107; 14/12/16/3/3/2/2108 & 14/12/16/3/3/2/2106 respectively)

Dear Ngaka Modiri Molema District and Ditsobotla Local Municipal Officials,

Savannah Environmental (Pty) Ltd, the appointed Environmental Assessment Practitioner (EAP), notified you, as a Stakeholder and a registered interested and affected party (I&AP), in October 2021 of the availability of the Scoping Reports for the above-mentioned projects for your review and comments. The final Scoping Reports were submitted to the Department of Forestry, Fisheries and the Environment (DFFE) on Friday, 26 November 2021.

In terms of Regulation 43.(2), EIA Regulations 2017, as amended, the attached letter serves to inform you that the Environmental Impact Assessment Report (EIAR) for each application are available for your Department's / Organisation's review and written comments for a 30-day period from from Monday, 07 February 2022 until Wednesday, 09 March 2022.

The attached notification letter serves to inform you that:

- the DFFE accepted the Scoping Reports and approved the Plan of Study for the Environmental Impact Assessment (EIA) phase;
- that the EIA processes commencing with the impact phase of the studies;
- the availability of the EIA Reports for your review and comment; and
- invitation to attend any one of the two (2), or both, of the on-line public participation process meetings.

Kind regards,  
[Unsubscribe this type of email](#)

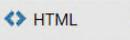
 Design  HTML  Preview

SAVE

CLOSE

[Print](#)

# SE3107: Houthaalbomen PV Cluster - EIARs Notification of availability for review and comment (DM&LM) (POE)

Date:  
Thursday, 03  
February  
2022  
Time: 12:31

Company	Last Name	First Name	
Ditsobotla Local Municipality	Batsile	Pius	
Ditsobotla Local Municipality	Buthelezi	Daniel Tebogo	
Ditsobotla Local Municipality	Dikoko	M. D.	
Ditsobotla Local Municipality	Du Plessis	Andre	
Ditsobotla Local Municipality	Groenewald	Sakkie	
Ditsobotla Local Municipality	Jack	Pule	
Ditsobotla Local Municipality	Lethaku	Jonas	
Ditsobotla Local Municipality	Matlalue	Eric	
Ditsobotla Local Municipality	Metswamere	Abel	
Ditsobotla Local Municipality	Mogogane	Otumiseng	
Ditsobotla Local Municipality	Moheta	Buti	
Ditsobotla Local Municipality	Moiloa	Gorataone	
Ditsobotla Local Municipality	Monaisa	Paseka	
Ditsobotla Local Municipality	Mosane	Tshepo	
Ditsobotla Local Municipality	Mothibedi	Kgalalelo	
Ditsobotla Local Municipality	Mothabane	Israel	
Ditsobotla Local Municipality	Ntsapodi	Matshidiso	
Ditsobotla Local Municipality	Pule	Jack	
Ditsobotla Local Municipality	Ralekgetho	Lebu	
Ditsobotla Local Municipality	Tshabadira	Aumaki	
Ditsobotla Local Municipality	Van Niekerk	G	
Ditsobotla Local Municipality	Zandamela	Nono	
Ngaka Modiri Molema District Municipality	Justice	Tshepo	
Ngaka Modiri Molema District Municipality	Makgale	Flora	
Ngaka Modiri Molema District Municipality	Makgoba	Stanley	
Ngaka Modiri Molema District Municipality	Mbengo	Collen	
Ngaka Modiri Molema District Municipality	Mohlakoana	MMJ	
Ngaka Modiri Molema District Municipality	Moleofane	Jake	
Ngaka Modiri Molema District Municipality	Motsamai	Boikanyo	
Ngaka Modiri Molema District Municipality	Nthutang	Pholo	
Ngaka Modiri Molema District Municipality	Pulenyane	Kabelo	
Ngaka Modiri Molema District Municipality	Sechoaro	Yoliswa	
Ngaka Modiri Molema District Municipality	Senwedim	Abram	

Totals:

---

04 February 2022

Mr KA Sitase  
Department of Public Works & Roads  
Private Bag X2080  
MMABATHO  
2735

Dear Mr Sitase,

**HOUTHAAALBOOMEN PV CLUSTER CONSISTING OF BARLERIA PV, DICOMA PV, AND SETARIA PV FACILITIES,  
NORTH WEST PROVINCE  
(DFFE Reference Nos.: 14/12/16/3/3/2/2107; 14/12/16/3/3/2/2108 & 14/12/16/3/3/2/2106 respectively)**

---

**NOTICE OF AVAILABILITY OF ENVIRONMENTAL IMPACT ASSESSMENT REPORTS FOR REVIEW AND COMMENT**

---

Savannah Environmental (Pty) Ltd, the appointed Environmental Assessment Practitioner (EAP), notified you, as a Stakeholder and a registered interested and affected party (I&AP), in October 2021 of the availability of the Scoping Reports for the above-mentioned projects for your review and comments. The final Scoping Reports were submitted to the Department of Forestry, Fisheries and the Environment (DFFE) on Friday, 26 November 2021.

We would like to take this opportunity to inform you, as a registered Key Stakeholder, that:

- The DFFE has accepted the final Scoping Reports, inclusive of the Plan of Study for the Environmental Impact Assessments (EIAs) in terms of Regulation 22 (a) of the EIA Regulations, 2014, as amended. A letter in this regard was received, on Thursday, 27 January 2022.
- Savannah Environmental has commenced with the EIA process in accordance with the tasks contemplated in the Plan of Study for EIA as required in terms of the EIA Regulations, 2014, as amended.
- The final EIA reports, inclusive of the specialist studies, record of the public participation undertaken, and the Environmental Management Programme (EMPr) is due for submission to DFFE, as per the EIA Regulation 23(1) of the EIA Regulations, 2014, as amended, within 107 days of the Scoping Reports acceptance.

Although there are various timeframes associated with the environmental authorisation process, it is important to note that the public participation is an on-going process, allowing I&APs to interact with the project team and to submit queries or comments throughout the environmental authorisation process. We encourage you to contact our team with any queries or comments regarding the project at any time during the process.

## ENVIRONMENTAL IMPACT ASSESSMENT REPORTS AVAILABLE FOR REVIEW AND COMMENT

In terms of Regulation 43.(2), EIA Regulations 2017, as amended, this letter serves to inform you that the Environmental Impact Assessment Report (EIAR) for each are available for your Department's review and written comments for a 30-day period from from **Monday, 07 February 2022** until **Wednesday, 09 March 2022**.

The reports are available for download from Savannah Environmental website: <https://savannahsa.com/public-documents/energy-generation/houthaalbomen-pv-cluster/>. All comments received during the 30-day review and comment period will be recorded and included in the Final Environmental Impact Assessment Reports for submission to the Department of Forestry, Fisheries and the Environment (DFFE) in line with Regulation 44 of the EIA Regulations, 2014, as amended (GN R326).

Please note Regulation 3(1) of the Environmental Impact Assessment Regulations, 2014, as amended, i.e.:

*Subject to subregulations (2) and (3), when a period of days must in terms of these Regulations be reckoned from or after a particular day, that period must be reckoned as from the start of the day following that particular day to the end of the last day of the period, but if the last day of the period falls on a Saturday, Sunday or public holiday, that period must be extended to the end of the next day which is not a Saturday, Sunday or public holiday.*

## INVITATION TO AND NOTIFICATION OF ONLINE PUBLIC PARTICIPATION PROCESS MEETINGS

You are invited to attend any one of the two (or both) online public participation process meetings which will take place on:

Date	Time
Tuesday, 22 February 2022	14h00
	18h00

The meetings are being hosted via MS Teams, in compliance with COVID-19 protocols, as well as to ensure that attendance is unrestricted. You are kindly requested to register your attendance for the online public participation process meeting that you want to attend with Nicolene Venter at [publicprocess@savannahsa.com](mailto:publicprocess@savannahsa.com) to receive the virtual link for attendance.

As the country had moved to COVID-19 Alert Level 1 on 01 October 2021, physical in-person meetings may take place on the condition that COVID-19 sanitation requirements at the venue are provided. Savannah Environmental would like to offer all I&APs and representatives from stakeholder groupings an opportunity to submit their request, should they have a need for an in-person meeting to discuss the proposed project and the findings of the EIA studies to Nicolene Venter at [publicprocess@savannahsa.com](mailto:publicprocess@savannahsa.com) or SMS / WhatsApp on 060 978 8396.

Please do not hesitate to contact us should you require additional information and/or clarification regarding the project. Our team welcomes your participation and look forward to your involvement throughout this process.

Kind regards



**Nicolene Venter**

Public Participation and Social Consultant

Email: [publicprocess@savannahsa.com](mailto:publicprocess@savannahsa.com)

EIA Report available on Savannah  
Environmental's website

(proof to be included in Final EIA Report)

EIA Report uploaded onto SAHRIS  
(proof to be included in Final EIA Report)



## SCOPING PHASE

14 October 2021

Dear Stakeholder and Interested and Affected Party,

**HOUTHAALBOOMEN PV CLUSTER CONSISTING OF BARLERIA PV, DICOMA PV, AND SETARIA PV  
 FACILITIES, NORTH WEST PROVINCE  
 (DEFF Reference Nos.: To be Issued)**

**NOTIFICATION OF AVAILABILITY OF SCOPING REPORTS FOR REVIEW AND COMMENT**

The development of three (3) separate solar photovoltaic (PV) facilities and associated infrastructure on sites located approximately 5km north -west of the town of Lichtenburg within the Ditsobotla Local Municipality, Ngaka Modiri Molema District Municipality, North West Province.

The proposed PV Facilities and associated infrastructure for the project are located on the following properties:

Applicant	Project Name	Affected Property
Barleria PV (Pty) Ltd	Barleria PV	Solar PV: Portion 1 of the Farm Houthaalboomen 31 Portion 9 of the Farm Houthaalboomen 31 Portion 10 of the Farm Houthaalboomen 31  LILO Grid Connection: Portion 1 of the Farm Houthaalboomen 31 Portion 0 of Farm Talene 25 Portion 7 of Farm Elandsfontein 34
Dicoma PV (Pty) Ltd	Dicoma PV	Solar PV: Portion 1 of the Farm Houthaalboomen 31 Portion 9 of the Farm Houthaalboomen 31 Portion 10 of the Farm Houthaalboomen 31  LILO Grid Connection: Portion 1 of the Farm Houthaalboomen 31 Portion 0 of Farm Talene 25 Portion 7 of Farm Elandsfontein 34
Setaria PV (Pty) Ltd	Setaria PV	Solar PV: Portion 1 of the Farm Houthaalboomen 31 Portion 9 of the Farm Houthaalboomen 31 Portion 10 of the Farm Houthaalboomen 31  LILO Grid Connection: Portion 1 of the Farm Houthaalboomen 31 Portion 0 of Farm Talene 25 Portion 7 of Farm Elandsfontein 34

Separate applications for Environmental Authorisation in terms of the National Environmental Management Act (No. 107 of 1998) and the Environmental Assessment Regulations, 2014, as amended, (GNR 326) are being undertaken for the projects. Each application is being supported by a separate Scoping and Environmental Impact Assessment process.

### **SCOPING REPORTS AVAILABLE FOR PUBLIC REVIEW AND COMMENT**

The Scoping Reports for each of the projects are available for review and comment from **Friday, 15 October 2021** until **Monday, 15 November 2021**. The reports are available for download from Savannah Environmental website: <https://savannahsa.com/public-documents/energy-generation/houthaalbomen-pv-cluster/>. To obtain further information on the projects and to register on the projects' databases, please submit your name, contact information and interest in the projects, in writing, to Nicolene Venter or Tumelo Mathulwe at Savannah Environmental by any of the following means:

Post: P.O. Box 148, Sunninghill, 2157

Telephone: 011 656 3237

Mobile: 060 978 8396 (*also include please call me*)

Fax: 086 684 0547

Email: [publicprocess@savannahsa.com](mailto:publicprocess@savannahsa.com)

An application for Environmental Authorisation (EA) in terms of Sections 24 and 24D of the National Environmental Management Act (No 107 of 1998), as read with the environmental Impact Assessment (EIA) Regulations, GNR 982-985 of 4 December 2014, as amended, a Scoping and EIA is required to be undertaken for the proposed PV clusters.

Details of the nature and extent of the PV clusters and the associated infrastructure is included in the Background Information Document (BID) attached to this notification letter.

### **COMMENTS AND QUERIES**

All comments received during the 30-day review and comment period will be recorded and included in the Final Scoping Reports for submission to the DFFE in line with Regulation 44 of the EIA Regulations, 2014, as amended (GN R326).

Please do not hesitate to contact us should you require additional information and/or clarification regarding the project. Our team welcomes your participation and look forward to your involvement throughout this process.

Kind regards



#### **Nicolene Venter**

Public Participation and Social Consultant

Email: [publicprocess@savannahsa.com](mailto:publicprocess@savannahsa.com)

**Attached:** Background Information Document  
Registration and Comment Form

## Nicolene Venter

---

**From:** Savannah Public Process  
**Sent:** Thursday, 14 October 2021 16:00  
**Cc:** Nicolene Venter; Nondumiso Bulunga  
**Subject:** SE3107: HOUTHAALBOOMEN PV CLUSTER – Notification of EIA Process and availability of Scoping Reports for review and comment  
**Attachments:** SE3107-Houthaalbomen PV Cluster SRs Notification Letter-FINAL.pdf; SE3107-Houthaalbomen PV Cluster RegComm Form-FINAL.pdf; SE3107-Houthaalboomen PV Cluster BID.pdf

**HOUTHAALBOOMEN PV CLUSTER CONSISTING OF BARLERIA PV, DICOMA PV, AND SETARIA PV FACILITIES, NORTH WEST PROVINCE**  
**(DEFF Reference Nos.: To be Issued)**

The development of three (3) separate solar photovoltaic (PV) facilities and associated infrastructure on sites located approximately 5km north -west of the town of Lichtenburg within the Ditsobotla Local Municipality, Ngaka Modiri Molema District Municipality, North West Province has reference.

The three (3) proposed PV Facilities and associated infrastructure are the following:

- Barleira Photovoltaic
- Dicoma Photovoltaic
- Setaria Photovoltaic

The following documents are attached for your perusal:

- Background Information Document: This document provides details of the nature and extent of the PV clusters and the associated infrastructure;
- Registration and Comment Form: To register as an Interested and Affected Party on the projects' databases and to receive further information regarding the applications; and
- Notification letter: Announcing the availability of the three Scoping Reports for your review and comment.

Please do not hesitate to contact us should you require additional information and/or clarification regarding the project. Our team welcomes your participation and look forward to your involvement throughout this process.

Kind regards,

**savannah**  
environmental

t: +27 (0)11 656 3237  
f: +27 (0) 86 684 0547

**Tumelo Mathulwe**  
Public Participation Consultant

e: [Publicprocess@savannahsa.com](mailto:Publicprocess@savannahsa.com)  
c: +27 (0)60 978 8396

SAWEA Award for Leading Environmental Consultant on Wind Projects in 2013 & 2015

We respect your privacy and acknowledge that this e-mail will contain Personal Information, which may belong to you, others and/or to your organization and which we will process. The processing of your personal information by Savannah Environmental may be included in reports submitted to governmental departments or on our public platforms, which processing will be done in accordance with our processing notice housed on our website - <https://savannahsa.com/privacy-policy-privacy-policy-page/>. By sending and/or receiving this message, you hereby expressly give us consent to process the Personal Information contained herein which processing will be done in accordance with POPIA Act 4 of 2013.

This email has been scanned for viruses and malware, and automatically archived by **Mimecast SA (Pty) Ltd**, and is believed to be clean.



t: 011 656 3237  
f: 086 684 0547

**Nicolene Venter**  
Public Process

e: [publicprocess@savannahsa.com](mailto:publicprocess@savannahsa.com)  
c: +27 (0) 60 978 8396

SAWEA Award for Leading Environmental Consultant on Wind Projects in 2013 & 2015

[Print](#)

# SE3107: Houthaalbomen PV Cluster - EIA and Scoping Report Notification (POE)

Company	Last Name	First Name	Email Address	Email Address 2
	..	Beatrice	digiteltech@webmail.co.za	
	Boikanyo	Obakeng	boikanyo0515@gmail.com	
	Botha	Lourens	tiaan6402@gmail.com	
	du preez	Pieter Hendrik	leeubos@gmail.com	
	Ferreira	Rina	odendaalbraaikuiakens@gmail.com	
	Meyer	Jannie	ivy@nwisp.co.za	
	Mongale	Lebogang	kinglebogangmongale04@gmail.com	
	Nel	Andre	nel.1305@yahoo.com	
	Nunez	David	david.nunez@siriuspower.co.za	
	Odendaal	Susan	odendaalbraaikuiakens@gmail.com	
	Pretorius	Louis	wessels@nviso.co.za	
	van Dyk	Anton	louisavd@nwisp.co.za	
	Venter	Nicolene	nicolene@savannahsa.com	
	Wessels	Estelle	wessels@nviso.co.za	
	Wessels	Wynand	wessels@nviso.co.za	
ABO Wind renewable energies (Pty) Ltd	Invernizzi	Rob	rob.invernizzi@abo-wind.com	
Agri North West	de Chavonnes Vrugt	Willem	wanda@agrinw.co.za	
Agri North West	Du Toit	Boeta	wanda@agrinw.co.za	
Agri North West	Du Toit	P	marlize@agrinw.co.za	
Agri North West	Pienaar	Naude	wanda@agrinw.co.za	
Agri North West	Van der Merwe	Daan	wanda@agrinw.co.za	
Agri North West	Van Zyl	Cobus	wanda@agrinw.co.za	
Agri North West	Venter	Jaco	jacovennas@gmail.com	
Agri North West Farmers Union	van wyk	Eric	ebvanwyk@gmail.com	
Agri SA	Rabie	Janse	janse@agrisa.co.za	
Bakerville Communal Property Association	Groenewald	Sakkie	bakervillecpa@gmail.com	
BirdLife South Africa	Ralston-Paton	Samantha	energy@birdlife.org.za	
Chris du Plessis Trust	du Plessis	Chris	chrisduplessis@nwisp.co.za	
Department of Agriculture, Forestry & Fisheries	Gombela	Cherity	CherityG@daff.gov.za	
Department of Agriculture, Forestry & Fisheries	Krisjan	Portia	Pkrisjan@nwpg.gov.za	

Department of Agriculture, Forestry & Fisheries	Mnguni	Sambulo	sambulom@nda.agric.za	
Department of Agriculture, Forestry & Fisheries	Niewoudt (Wessels)	Carene	CWessels@nwpg.gov.za	
Department of Agriculture, Forestry & Fisheries	Phahladira	Selekane	SelekaneP@daff.gov.za	
Department of Agriculture, Forestry and Fisheries	Marubini	Mashudu	mashuduma@daff.gov.za	
Department of Mineral Resources	Swart	Pieter	Pieter.Swart@dmr.gov.za	lpeleng.Wesi@dmr.gov.za
Department of Water and Sanitation	Peggy	Mabuza	mabuzap@dws.gov.za	
Department of Water and Sanitation	Ratau	Sputnik	rataus@dws.gov.za	
Ditsobotla Local Municipality	Batsile	Pius	pius864@gmail.com	
Ditsobotla Local Municipality	Buthelezi	Daniel Tebogo	Tsholofelo.dinaane99@yahoo.com	
Ditsobotla Local Municipality	Dikoko	M. D.	mddikoko@gmail.com	
Ditsobotla Local Municipality	Du Plessis	Andre	andre.duplessis@misa.gov.za	
Ditsobotla Local Municipality	Jack	Pule	pulejack79@gmail.com	
Ditsobotla Local Municipality	Letlhaku	Jonas	letlhakujay@gmail.com	letlhakujonas@gmail.com
Ditsobotla Local Municipality	Matlalue	Eric	M2Kscons@gmail.com	
Ditsobotla Local Municipality	Metswamere	Abel	metswamere@ymail.com	
Ditsobotla Local Municipality	Mogogane	Otumiseng	mogoganeo@gmail.com	
Ditsobotla Local Municipality	Moheta	Buti	mohetabuti@gmail.com	Buti.moheta@gmail.com
Ditsobotla Local Municipality	Moiloa	Gorataone	moiloag24@gmail.com	
Ditsobotla Local Municipality	Mosane	Tshepo	mosanetd@yahoo.com	
Ditsobotla Local Municipality	Motlhabane	Israel	motlhabane@gmail.com	
Ditsobotla Local Municipality	Ntsapodi	Matshidiso	mntsapodi@gmail.com	
Ditsobotla Local Municipality	Pule	Jack	pulejack@gmail.com	
Ditsobotla Local Municipality	Ralekgetho	Lebu	rlebu4139@gmail.com	
Ditsobotla Local Municipality	Tshabadira	Aumaki	artshabadira@gmail.com	
Ditsobotla Local Municipality	Van Niekerk	G	vanniekerkgiet@ditsobotla.gov.za	
Ditsobotla Local Municipality	Van Niekerk	Le-Roi	leroivanniekerk@gmail.com	
Ditsobotla Local Municipality	Zandamela	Nono	nkekesi@gmail.com	

Environmental Impact Management Services	Madau	Tshivhangwaho	mudau@eims.co.za	
Eskom Holdings SOC Ltd	Galela	Noxolo	GalelaN@eskom.co.za	
Eskom Holdings SOC Ltd	Geeringh	John	john.geeringh@eskom.co.za	GeerinJH@eskom.co.za
Eskom Holdings SOC Ltd	Mare	Charmaine	marecc@eskom.co.za	
Eskom Holdings SOC Ltd	Sebole	Mpho	SeboleMD@eskom.co.za	
Fastpulse Trading 410	Kruger	Heinrich	heinkruger@nwk.co.za	
Federation for Sustainable Environment	Liefferink	Mariette	marietteL@iburst.co.za	
G7 Renewable Energies (Pty) Ltd	Fyfe	Veronique	eia@g7energies.com	veronique@g7energies.com
Hentiq 2850 PTY LTD	Wessels	Wessel	wessels@nwisp.co.za	
JH Nel Boerdery (Eiendoms) Beperk	Nel	Henry Johannes	henrynel@telkomsa.net	
Kleinuitschot Boerdery	Hartzenberg	Ferdinand	drferdi@denand.co.za	
Ngaka Modiri Molema District Municipality	Justice	Tshepo	executivemayor@nmmdm.gov.za	
Ngaka Modiri Molema District Municipality	Makgoba	Stanley	makgobas@nmmdm.gov.za	
Ngaka Modiri Molema District Municipality	Mbengo	Collen	czmbengo@gmail.com	mbengoc@nmmdm.gov.za
Ngaka Modiri Molema District Municipality	Mohlakoana	MMJ	vanrooyenm@nmmdm.gov.za	
Ngaka Modiri Molema District Municipality	Moleofane	Jake	moleofanek@nmmdm.gov.za	
Ngaka Modiri Molema District Municipality	Motsamai	Boikanyo	boikanyom@nmmdm.gov.za	motsamaib@nmmdm.gov.za
Ngaka Modiri Molema District Municipality	Nthutang	Pholo	nthutangp@nmmdm.gov.za	
Ngaka Modiri Molema District Municipality	Pulenyane	Kabelo	kpulenyane@gmail.com	pulenyane@nmmdm.gov.za
Ngaka Modiri Molema District Municipality	Sechoaro	Yoliswa	sekweleo@nmmdm.gov.za	
Ngaka Modiri Molema District Municipality	Senwedim	Abram	senwedim@nmmdm.gov.za	
North West Department of Public Works and Roads	Mafune	Alfred	ddmogonediswa@nwpg.gov.za	
North West Department of Rural, Environmental and	Mahlangu	Eva	emahlangu@nwpg.gov.za	



Agricultural Development				
North West Department of Rural, Environmental and Agricultural Development	Moholo	Obitseng	omoholo@nwpg.gov.za	
North West Department of Rural, Environmental and Agricultural Development	Skosana	Ouma	oskosana@nwpg.gov.za	
North West Provincial Heritage Resources Agency	Omar	Shahnaz	somar@nwpg.gov.za	
Savannah Environmental (Pty) Ltd	Bulunga	Nondumiso	nondumiso@savannahsa.com	
Sentech Ltd	Motlhake	Serame	MotlhakeS@sentech.co.za	
Sentech Ltd	Sentech		support@sentech.co.za	
South African Bat Assessment Advisory Panel (SABAAP)	MacEwan	Kate	kate@iws-sa.co.za	
South African Bat Assessment Association	Lotter	Caroline	caroline@iws-sa.co.za	
South African Heritage Resources Agency (SAHRA)	Khumalo	Nokukhanya	nkhumalo@sahra.org.za	
South African National Roads Agency Limited	Bota	Victoria	botav@nra.co.za	
South African National Roads Agency Limited	Yorke-Hart	Michael	YorkeHM@nra.co.za	
Swarico Afslaers	Steinman	Jan	swarico@live.co.za	
Wildlife and Environment Society of South Africa (WESSA)	Wesson	John	jnbadmin@wessa.co.za	

Totals:

---

**SAVANNAH ENVIRONMENTAL WEBSITE**



## Houthaalbomen PV Cluster and Associated Infrastructure

### Notice Of Environmental Impact Assessments, Houthaalbomen Photovoltaic Cluster Consisting of the Barleria PV, Dicoma PV and Setaria PV Facilities & Associated Infrastructure, North West

**Proposed Activity and Location:** The development of three (3) separate solar photovoltaic (PV) facilities and associated infrastructure on sites located approximately 5km north-west of the town of Lichtenburg, in the North West Province. The projects are located in the Ditsobotla Local Municipality within the Ngaka Modiri Molema District Municipality.

Applicant	Project Name	Affected Properties - Solar PV	Affected Properties - LJO Grid Connection
Barleria PV (Pty) Ltd	Barleria PV	Portion 1 of the Farm Houthaalboomen 31 Portion 5 of the Farm Houthaalboomen 31 Portion 10 of the Farm Houthaalboomen 31	Portion 1 of the Farm Houthaalboomen 31 Portion 0 of Farm Talena 25 Portion 7 of Farm Elandsfontein 34
Dicoma PV (Pty) Ltd	Dicoma PV	Portion 1 of the Farm Houthaalboomen 31 Portion 5 of the Farm Houthaalboomen 31 Portion 10 of the Farm Houthaalboomen 31	Portion 1 of the Farm Houthaalboomen 31 Portion 0 of Farm Talena 25 Portion 7 of Farm Elandsfontein 34
Setaria PV (Pty) Ltd	Setaria PV	Portion 1 of the Farm Houthaalboomen 31 Portion 5 of the Farm Houthaalboomen 31 Portion 10 of the Farm Houthaalboomen 31	Portion 1 of the Farm Houthaalboomen 31 Portion 0 of Farm Talena 25 Portion 7 of Farm Elandsfontein 34

**Environmental Assessment Process:** Separate applications for Environmental Authorisation in terms of the National Environmental Management Act (No. 107 of 1998) and the Environmental Assessment Regulations, 2014, as amended, (GNR 326) have been submitted for the projects. Each application is being supported by a separate Scoping and Environmental Impact Assessment process.

To obtain further information and register on the project database, please submit your name, contact information and interest in the project to:

Nicolene Venter / Tumelo Mathulwe at Savannah Environmental

P.O. Box 148, Sunninghill, 2157

Tel: 011 656 3237

Fax: 086 684 0547

Email: publicprocess@savannahsa.com

Website: www.savannahsa.com

Documents for public review are available for download.

If you have already registered your interest click on "View Downloads".

Barleria PV - In Progress

[VIEW DOWNLOAD PAGE](#)

Dicoma PV - In Progress

[VIEW DOWNLOAD PAGE](#)

Setaria PV - In Progress

[VIEW DOWNLOAD PAGE](#)

If you have not registered your interest click on "Register Interest", fill in and submit the form.

Barleria PV

[REGISTER INTEREST](#)

Dicoma PV

[REGISTER INTEREST](#)

Setaria PV

[REGISTER INTEREST](#)

## Barleria PV

WELCOME TO OUR VIRTUAL CONSULTATION

[Maps &  
Plans](#)

[Project  
Information](#)

[Presentations](#)

[Scoping Report](#)[Appendix A: EIA Project Consulting Team CVs](#)[Appendix B: Authority Correspondence](#)[Appendix C: Public Participation Process Report](#)[Appendix D: Terrestrial Ecology Scoping Study](#)[Appendix E: Avifauna Scoping Study](#)[Appendix F: Soils and Agricultural Potential Scoping Study](#)

**Appendix G: Heritage Scoping Study (incl. archaeology and palaeontology)**

**Appendix H: Visual Scoping Study**

**Appendix I: Social Scoping Study**

**Appendix J: Screening Tool Reports**

**Appendix K: Maps (A3)**

**Appendix L: EAP Affirmation and Declaration**

**Appendix M: Specialist Declarations**

SAHRIS UPLOAD



## PROPOSED DEVELOPMENT OF THE BARLERIA PV FACILITY AND ASSOCIATED INFRASTRUCTURE NEAR LICHTENBURG, NORTH WEST PROVINCE

[Log in](#) or [register](#) to post comments 14 reads

**CaseHeader** [LocationInfo](#) [Admin](#)

**Status:** SUBMITTED

**HeritageAuthority(s):** SAHRA  
NWPHRA

**Case Type:** Section 38 (8) - Statutory Comment Required

**Development Type:** Solar

**ProposalDescription:**

The Applicant, Barleria PV (Pty) Ltd, is proposing the construction of a photovoltaic (PV) solar energy facility (known as the Barleria PV facility) located on a site approximately 5km north west of the town of Lichtenburg in the North West Province. The solar PV facility will comprise several arrays of PV panels and associated infrastructure and will have a contracted capacity of up to 75MW. The development area is situated within the Ditsobotla Local Municipality within the Ngaka Modiri Molema District Municipality. The site is accessible via an existing gravel road which provides access to the development area off the R505, located east of the development area. The development area for the PV facility and associated infrastructure will be located on the following properties: Portion 1 of the Farm Houthaalboomen 31 Portion 9 of the Farm Houthaalboomen 31 Portion 10 of the Farm Houthaalboomen 31 Portion 0 of Farm Talene 25 Portion 7 of Farm Elandsfontein 34 Two additional 75MW PV facilities (Dicoma PV and Setaria PV) are concurrently being considered on the project site (within Portion 1, Portion 9, and Portion 10 of the Farm Houthaalboomen 31) and are assessed through separate Environmental Impact Assessment (EIA) processes.

**ApplicationDate:** Tuesday, October 19, 2021 - 13:36

**CaseID:** 17354



**OtherReferences:**

**Heritage Reports:** [Heritage Screener: Haalhoutbomen PV Projects](#)

**ReferenceList:**

**AdditionalDocuments**

1.  SE3107 - Appendix A - EIA Project Team CV.pdf
2.  SE3107 - Appendix B - Authority Correspondence.pdf
3.  SE3107 - Appendix C-Public Participation Report.pdf
4.  SE3107 - Appendix D - Ecology & Freshwater Scoping Report.pdf
5.  SE3107 - Appendix E - Avifauna Scoping Report.pdf
6.  SE3107 - Appendix F - Soils and Agricultural Scoping Report.pdf
7.  SE3107 - Appendix H - Visual Scoping Report.pdf
8.  SE3107 - Appendix I - Social Scoping Report.pdf
9.  SE3107 - Appendix J - Screening Tool Report.pdf
10.  SE3107 - Appendix K - Maps.pdf
11.  SE3107 - Appendix L - EAP Affirmation & Declaration.pdf
12.  SE3107 - Barleria Scoping Report.pdf
13.  Houthaalboomen PV Cluster\_1.kml

# Correspondence

# Ditsobotla Local Municipality



thank you for making the time available to meet with me and Non-dusimo from Savannah Environmental regarding the Houthaalbomen PV Cluster EIAs.

07:26

Just a friendly reminder to pls send us the photos of the project notices erected at the clinic in Bakerville and at the Grasfontein Community Hall., if you had an opportunity. Kind regards Nicolene Venter Savannah Environmental



07:28



Enter message



## Savannah Public Process

---

**From:** Savannah Public Process  
**Sent:** Thursday, 14 October 2021 18:55  
**To:** Le-Roi van Niekerk  
**Subject:** RE: SE3107: HOUTHAAALBOOMEN PV CLUSTER – Notification of EIA Process and availability of Scoping Reports for review and comment

Thank you Le-Roi! Enjoy your time in the UK!

---

**From:** Le-Roi van Niekerk <leroivanniekerk@gmail.com>  
**Sent:** Thursday, 14 October 2021 17:15  
**To:** Savannah Public Process <publicprocess@savannahsa.com>  
**Subject:** Re: SE3107: HOUTHAAALBOOMEN PV CLUSTER – Notification of EIA Process and availability of Scoping Reports for review and comment

It's a please.

You can kindly remove me as I am currently in the United Kingdom and will most propbaly not be back within the next few years.

Thank you in advance.

Kind regards

Le-Roi

On Thu, 14 Oct 2021, 15:08 Savannah Public Process, <[publicprocess@savannahsa.com](mailto:publicprocess@savannahsa.com)> wrote:

Dear Le-Roi,

Thank you for the notification below.

We will send the notification to Ms Mothibedi.

Can you please confirm whether we can keep you as a Ditsobotla Local Municipality Official on the projects' databases.

Kind regards,



t: +27 (0)11 656 3237  
f: +27 (0) 86 684 0547

**Nicolene Venter**  
Public Participation and Social  
Consultant

e: [publicprocess@savannahsa.com](mailto:publicprocess@savannahsa.com)  
c: +27 (0)60 978 8396

SAWEA Award for Leading Environmental Consultant on Wind Projects in 2013 & 2015

#### Processing of personal information / POPIA compliance

We respect your privacy and acknowledge that this e-mail will contain Personal Information, which may belong to you, others and/or to your organization and which we will process. The processing of your personal information by Savannah Environmental may be included in reports submitted to governmental departments or on our public platforms, which processing will be done in accordance with our processing notice housed on our website - <https://savannahsa.com/privacy-policy-privacy-policy-page/>. By sending and/or receiving this message, you hereby expressly give us consent to process the Personal Information contained herein which processing will be done in accordance with POPIA Act 4 of 2013.

This email has been scanned for viruses and malware, and automatically archived by **Mimecast SA (Pty) Ltd**, and is believed to be clean.

---

**From:** Le-Roi van Niekerk <[leroivanniekerk@gmail.com](mailto:leroivanniekerk@gmail.com)>  
**Sent:** Thursday, 14 October 2021 16:06  
**To:** Savannah Public Process <[publicprocess@savannahsa.com](mailto:publicprocess@savannahsa.com)>  
**Cc:** Nondumiso Bulunga <[Nondumiso@savannahsa.com](mailto:Nondumiso@savannahsa.com)>; Nicolene Venter <[nicolene@savannahsa.com](mailto:nicolene@savannahsa.com)>  
**Subject:** Re: SE3107: HOUTHAAALBOOMEN PV CLUSTER – Notification of EIA Process and availability of Scoping Reports for review and comment

Good afternoon,

Would you kindly forward to Ms Kgalalelo Mothibedi at [kgalamothibedi@gmail.com](mailto:kgalamothibedi@gmail.com). She is the Unit Manager for Planning and Development. I am no longer working at Ditsobotla Local Municipality.

Thank you.

Kind regards

Le-Roi

On Thu, 14 Oct 2021, 14:59 Savannah Public Process, <[publicprocess@savannahsa.com](mailto:publicprocess@savannahsa.com)> wrote:

**HOUTHAAALBOOMEN PV CLUSTER CONSISTING OF BARLERIA PV, DICOMA PV, AND SETARIA PV FACILITIES, NORTH WEST PROVINCE**

**(DEFF Reference Nos.: To be Issued)**

The development of three (3) separate solar photovoltaic (PV) facilities and associated infrastructure on sites located approximately 5km north -west of the town of Lichtenburg within the Ditsobotla Local Municipality, Ngaka Modiri Molema District Municipality, North West Province has reference.

The three (3) proposed PV Facilities and associated infrastructure are the following:

- Barleira Photovoltaic
- Dicoma Photovoltaic
- Setaria Photovoltaic

The following documents are attached for your perusal:

- Background Information Document: This document provides details of the nature and extent of the PV clusters and the associated infrastructure;
- Registration and Comment Form: To register as an Interested and Affected Party on the projects' databases and to receive further information regarding the applications; and
- Notification letter: Announcing the availability of the three Scoping Reports for your review and comment.

Please do not hesitate to contact us should you require additional information and/or clarification regarding the project. Our team welcomes your participation and look forward to your involvement throughout this process.

Kind regards,

**Tumelo Mathulwe**

Public Participation Consultant

t: +27 (0)11 656 3237

f: +27 (0) 86 684 0547

e: [Publicprocess@savannahsa.com](mailto:Publicprocess@savannahsa.com)

c: +27 (0)60 978 8396

SAWEA Award for Leading Environmental Consultant on Wind Projects in 2013 & 2015

**Processing of personal Information / POPIA compliance**

We respect your privacy and acknowledge that this e-mail will contain Personal Information, which may belong to you, others and/or to your organization and which we will process. The processing of your personal information by Savannah Environmental may be included in reports submitted to governmental departments or on our public platforms, which processing will be done in accordance with our processing notice housed on our website - <https://savannahsa.com/privacy-policy-privacy-policy-page/>. By sending and/or receiving this message, you hereby expressly give us consent to process the Personal Information contained herein which processing will be done in accordance with POPIA Act 4 of 2013.

This email has been scanned for viruses and malware, and automatically archived by **Mimecast SA (Pty) Ltd.**, and is believed to be clean.



**Ngaka Modiri Molema District Municipality**

## Savannah Public Process

---

**From:** Savannah Public Process  
**Sent:** Friday, 15 October 2021 02:32  
**To:** collen mbengo  
**Cc:** Nicolene Venter; Nondumiso Bulunga  
**Subject:** RE: SE3107: HOUTHAAALBOOMEN PV CLUSTER – Notification of EIA Process and availability of Scoping Reports for review and comment

<b>Tracking:</b>	<b>Recipient</b>	<b>Delivery</b>
	collen mbengo	
	Nicolene Venter	Delivered: 2021/10/15 02:33
	Nondumiso Bulunga	Delivered: 2021/10/15 02:33

Dear Mr Mbengo,

Please receive herewith acknowledgement of your registration and comments form and that the team is looking forward to your Department's written comments on the Scoping Report.

It is also confirmed that Mr Jona Letlhuka, Director: Ditsobotla Local Municipality, is a registered Official on the projects' databases.

Kind regards,



t: +27 (0)11 656 3237  
f: +27 (0) 86 684 0547

**Nicolene Venter**  
Public Participation and Social  
Consultant

e: [publicprocess@savannahsa.com](mailto:publicprocess@savannahsa.com)  
c: +27 (0)60 978 8396

SAWEA Award for Leading Environmental Consultant on Wind Projects in 2013 & 2015

### Processing of personal information / POPIA compliance

We respect your privacy and acknowledge that this e-mail will contain Personal Information, which may belong to you, others and/or to your organization and which we will process. The processing of your personal information by Savannah Environmental may be included in reports submitted to governmental departments or on our public platforms, which processing will be done in accordance with our processing notice housed on our website - <https://savannahsa.com/privacy-policy-privacy-policy-page/>. By sending and/or receiving this message, you hereby expressly give us consent to process the Personal Information contained herein which processing will be done in accordance with POPIA Act 4 of 2013.

This email has been scanned for viruses and malware, and automatically archived by **Mimecast SA (Pty) Ltd**, and is believed to be clean.

---

**From:** collen mbengo <czmbengo@gmail.com>  
**Sent:** Thursday, 14 October 2021 16:38  
**To:** Savannah Public Process <publicprocess@savannahsa.com>  
**Cc:** Nicolene Venter <nicolene@savannahsa.com>; Nondumiso Bulunga <Nondumiso@savannahsa.com>  
**Subject:** Re: SE3107: HOUTHAAALBOOMEN PV CLUSTER – Notification of EIA Process and availability of Scoping Reports for review and comment

Good Day

Attached herewith is the I&AP form filled out.

Regards  
Collen Mbengo  
0763087272

On Thu, Oct 14, 2021 at 4:02 PM Savannah Public Process <[publicprocess@savannahsa.com](mailto:publicprocess@savannahsa.com)> wrote:

**HOUTHAAALBOOMEN PV CLUSTER CONSISTING OF BARLERIA PV, DICOMA PV, AND SETARIA PV FACILITIES, NORTH WEST PROVINCE**

**(DEFF Reference Nos.: To be Issued)**

The development of three (3) separate solar photovoltaic (PV) facilities and associated infrastructure on sites located approximately 5km north -west of the town of Lichtenburg within the Ditsobotla Local Municipality, Ngaka Modiri Molema District Municipality, North West Province has reference.

The three (3) proposed PV Facilities and associated infrastructure are the following:

- Barleira Photovoltaic
- Dicoma Photovoltaic
- Setaria Photovoltaic

The following documents are attached for your perusal:

- Background Information Document: This document provides details of the nature and extent of the PV clusters and the associated infrastructure;
- Registration and Comment Form: To register as an Interested and Affected Party on the projects' databases and to receive further information regarding the applications; and
- Notification letter: Announcing the availability of the three Scoping Reports for your review and comment.

Please do not hesitate to contact us should you require additional information and/or clarification regarding the project. Our team welcomes your participation and look forward to your involvement throughout this process.

Kind regards,



t: +27 (0)11 656 3237  
f: +27 (0) 86 684 0547

**Tumelo Mathulwe**  
Public Participation Consultant

e: [Publicprocess@savannahsa.com](mailto:Publicprocess@savannahsa.com)  
c: +27 (0)60 978 8396

SAWEA Award for Leading Environmental Consultant on Wind Projects in 2013 & 2015

#### Processing of personal information / POPIA compliance

We respect your privacy and acknowledge that this e-mail will contain Personal Information, which may belong to you, others and/or to your organization and which we will process. The processing of your personal information by Savannah Environmental may be included in reports submitted to governmental departments or on our public platforms, which processing will be done in accordance with our processing notice housed on our website - <https://savannahsa.com/privacy-policy-privacy-policy-page/>. By sending and/or receiving this message, you hereby expressly give us consent to process the Personal Information contained herein which processing will be done in accordance with POPIA Act 4 of 2013.

This email has been scanned for viruses and malware, and automatically archived by **Mimecast SA (Pty) Ltd**, and is believed to be clean.

## Tumelo Mathulwe

---

**From:** collen mbengo <czmbengo@gmail.com>  
**Sent:** Wednesday, 3 November, 2021 14:48  
**To:** Savannah Public Process  
**Cc:** Nondumiso Bulunga; Nicolene Venter  
**Subject:** Re: SE3107: Houthaalboomen PV Cluster: Invitation to Public Participation Process Meeting

I accept the invitation and will attend the meeting

On Wed, Nov 3, 2021 at 2:44 PM Savannah Public Process <[publicprocess@savannahsa.com](mailto:publicprocess@savannahsa.com)> wrote:

Dear Stakeholder and Interested & Affected Party,

Thank you to those who accepted the calendar invitation to the above-mentioned Public Participation Process Meeting (PPPM) scheduled for this evening:

**DATE:** Wednesday, 03November 2021

**TIME:** 18h00

**ONLINE PLATFORM:** MS Teams (link in the calendar invitation or [Click here to join the meeting](#) )

Those who had not yet *accepted* the calendar invitation, we urge those of you to please do so.

Should you not be able to attend the PPPM, you are most welcome to forward this invitation to someone that can represent you/attend on your behalf.

Just a friendly reminder that the Basic Assessment Report in support of the Application for the EA has been compiled and is available for your review and comment. Visit our website on <https://savannahsa.com/public-documents/energy-generation/houthaalbomen-pv-cluster/> - the review and comment period is ending on Day, **15 November 2021**.

Kind regards,



**Tumelo Mathulwe**  
Public Participation Consultant

t: +27 (0) 11 656 3237  
f: +27 (0) 86 684 0547

e: [Publicprocess@savannahsa.com](mailto:Publicprocess@savannahsa.com)  
c: +27 (0) 60 978 8396

SAWEA Award for Leading Environmental Consultant on Wind Projects in 2013 & 2015

#### **Processing of personal Information / POPIA compliance**

We respect your privacy and acknowledge that this e-mail will contain Personal Information, which may belong to you, others and/or to your organization and which we will process. The processing of your personal information by Savannah Environmental may be included in reports submitted to governmental departments or on our public platforms, which processing will be done in accordance with our processing notice housed on our website - <https://savannahsa.com/privacy-policy-privacy-policy-page/>. By sending and/or receiving this message, you hereby expressly give us consent to process the Personal Information contained herein which processing will be done in accordance with POPIA Act 4 of 2013.

This email has been scanned for viruses and malware, and automatically archived by **Mimecast SA (Pty) Ltd**, and is believed to be clean.

## Savannah Public Process

---

**From:** collen mbengo <czmbengo@gmail.com>  
**Sent:** Thursday, 14 October 2021 16:15  
**To:** Savannah Public Process  
**Cc:** Nicolene Venter; Nondumiso Bulunga  
**Subject:** Re: SE3107: HOUTHAAALBOOMEN PV CLUSTER – Notification of EIA Process and availability of Scoping Reports for review and comment

Good Day

Email acknowledged. Will be attended to.

Regards  
Collen Mbengo  
Manager: Town & Regional Planning  
0763087272

On Thu, Oct 14, 2021 at 4:02 PM Savannah Public Process <[publicprocess@savannahsa.com](mailto:publicprocess@savannahsa.com)> wrote:

**HOUTHAAALBOOMEN PV CLUSTER CONSISTING OF BARLERIA PV, DICOMA PV, AND SETARIA PV FACILITIES, NORTH WEST PROVINCE**

**(DEFF Reference Nos.: To be Issued)**

The development of three (3) separate solar photovoltaic (PV) facilities and associated infrastructure on sites located approximately 5km north -west of the town of Lichtenburg within the Ditsobotla Local Municipality, Ngaka Modiri Molema District Municipality, North West Province has reference.

The three (3) proposed PV Facilities and associated infrastructure are the following:

- Barleira Photovoltaic
- Dicoma Photovoltaic
- Setaria Photovoltaic

The following documents are attached for your perusal:

- Background Information Document: This document provides details of the nature and extent of the PV clusters and the associated infrastructure;
- Registration and Comment Form: To register as an Interested and Affected Party on the projects' databases and to receive further information regarding the applications; and
- Notification letter: Announcing the availability of the three Scoping Reports for your review and comment.

Please do not hesitate to contact us should you require additional information and/or clarification regarding the project. Our team welcomes your participation and look forward to your involvement throughout this process.

Kind regards,



t: +27 (0)11 656 3237  
f: +27 (0) 86 684 0547

**Tumelo Mathulwe**  
Public Participation Consultant

e: [Publicprocess@savannahsa.com](mailto:Publicprocess@savannahsa.com)  
c: +27 (0)60 978 8396

SAWEA Award for Leading Environmental Consultant on Wind Projects in 2013 & 2015

#### Processing of personal Information / POPIA compliance

We respect your privacy and acknowledge that this e-mail will contain Personal Information, which may belong to you, others and/or to your organization and which we will process. The processing of your personal information by Savannah Environmental may be included in reports submitted to governmental departments or on our public platforms, which processing will be done in accordance with our processing notice housed on our website - <https://savannahsa.com/privacy-policy-privacy-policy-page/>. By sending and/or receiving this message, you hereby expressly give us consent to process the Personal Information contained herein which processing will be done in accordance with POPIA Act 4 of 2013.

This email has been scanned for viruses and malware, and automatically archived by **Mimecast SA (Pty) Ltd**, and is believed to be clean.



## Tumelo Mathulwe

---

**From:** collen mbengo <czmbengo@gmail.com>  
**Sent:** Thursday, 4 November, 2021 8:51  
**To:** Tumelo Mathulwe  
**Subject:** Re: SE3107: Houthaalboomen PV Cluster: Invitation to Public Participation Process Meeting

Good Day

Pleasure mfanakithi, like I said in the meeting, this is worth a try IF it is feasible and viable for the applicant.

Regards  
Collen Mbengo

On Thu, Nov 4, 2021 at 8:22 AM Tumelo Mathulwe <[tumelo@savannahsa.com](mailto:tumelo@savannahsa.com)> wrote:

Thank you Collen

I will distribute this with the notes of the meeting to everyone who was in attendance

Kind Regards

savannah  
environmental

t: +27 (0)11 656 3237  
f: +27 (0) 86 684 0547

**Tumelo Mathulwe**  
Public Participation Consultant

e: [Tumelo@savannahsa.com](mailto:Tumelo@savannahsa.com)  
c: +27 (0)60 978 8396

SAWEA Award for Leading Environmental Consultant on Wind Projects in 2013 & 2015

### Processing of personal information / POPIA compliance

We respect your privacy and acknowledge that this e-mail will contain Personal Information, which may belong to you, others and/or to your organization and which we will process. The processing of your personal information by Savannah Environmental may be included in reports submitted to governmental departments or on our public platforms, which processing will be done in accordance with our processing notice housed on our website - <https://savannahsa.com/privacy-policy-privacy-policy-page/>. By sending and/or receiving this message, you hereby expressly give us consent to process the Personal Information contained herein which processing will be done in accordance with POPIA Act 4 of 2013.

This email has been scanned for viruses and malware, and automatically archived by **Mimecast SA (Pty) Ltd**, and is believed to be clean.

---

**From:** collen mbengo <[czmbengo@gmail.com](mailto:czmbengo@gmail.com)>  
**Sent:** Wednesday, 3 November, 2021 18:55  
**To:** Savannah Public Process <[publicprocess@savannahsa.com](mailto:publicprocess@savannahsa.com)>  
**Cc:** Tumelo Mathulwe <[tumelo@savannahsa.com](mailto:tumelo@savannahsa.com)>; Nondumiso Bulunga <[Nondumiso@savannahsa.com](mailto:Nondumiso@savannahsa.com)>  
**Subject:** Re: SE3107: Houthaalboomen PV Cluster: Invitation to Public Participation Process Meeting

As requested, please receive the attached document

Regards

Collen

On Wed, Nov 3, 2021 at 3:27 PM Savannah Public Process <[publicprocess@savannahsa.com](mailto:publicprocess@savannahsa.com)> wrote:

Dear Collen,

Thank you for your confirmation of attendance.

Kind regards,

savannah  
environmental

t: +27 (0)11 656 3237  
f: +27 (0) 86 684 0547

**Nicolene Venter**  
Public Participation and Social  
Consultant

e: [publicprocess@savannahsa.com](mailto:publicprocess@savannahsa.com)  
c: +27 (0)60 978 8396

SAWEA Award for Leading Environmental Consultant on Wind Projects in 2013 & 2015

Processing of personal information / POPIA compliance

We respect your privacy and acknowledge that this e-mail will contain Personal Information, which may belong to you, others and/or to your organization and which we will process. The processing of your personal information by Savannah Environmental may be included in reports submitted to governmental departments or on our public platforms, which processing will be done in accordance with our processing notice housed on our website - <https://savannahsa.com/privacy-policy-privacy-policy-page/>. By sending and/or receiving this message, you hereby expressly give us consent to process the Personal Information contained herein which processing will be done in accordance with POPIA Act 4 of 2013.

This email has been scanned for viruses and malware, and automatically archived by **Mimecast SA (Pty) Ltd**, and is believed to be clean.

---

**From:** collen mbengo <[czmbengo@gmail.com](mailto:czmbengo@gmail.com)>  
**Sent:** Wednesday, 03 November 2021 14:48  
**To:** Savannah Public Process <[publicprocess@savannahsa.com](mailto:publicprocess@savannahsa.com)>  
**Cc:** Nondumiso Bulunga <[Nondumiso@savannahsa.com](mailto:Nondumiso@savannahsa.com)>; Nicolene Venter <[nicolene@savannahsa.com](mailto:nicolene@savannahsa.com)>  
**Subject:** Re: SE3107: Houthaalboomen PV Cluster: Invitation to Public Participation Process Meeting

I accept the invitation and will attend the meeting

On Wed, Nov 3, 2021 at 2:44 PM Savannah Public Process <[publicprocess@savannahsa.com](mailto:publicprocess@savannahsa.com)> wrote:

Dear Stakeholder and Interested & Affected Party,

Thank you to those who accepted the calendar invitation to the above-mentioned Public Participation Process Meeting (PPPM) scheduled for this evening:

**DATE:** Wednesday, 03 November 2021

**TIME:** 18h00

**ONLINE PLATFORM:** MS Teams (link in the calendar invitation or [Click here to join the meeting](#) )

Those who had not yet *accepted* the calendar invitation, we urge those of you to please do so.

Should you not be able to attend the PPPM, you are most welcome to forward this invitation to someone that can represent you/attend on your behalf.

Just a friendly reminder that the Basic Assessment Report in support of the Application for the EA has been compiled and is available for your review and comment. Visit our website on <https://savannahsa.com/public-documents/energy-generation/houthaalbomen-pv-cluster/> - the review and comment period is ending on Day, **15 November 2021**.

Kind regards,



t: +27 (0)11 656 3237  
f: +27 (0) 86 684 0547

**Tumelo Mathulwe**  
Public Participation Consultant

e: [Publicprocess@savannahsa.com](mailto:Publicprocess@savannahsa.com)  
c: +27 (0)60 978 8396

SAWEA Award for Leading Environmental Consultant on Wind Projects in 2013 & 2015

#### Processing of personal Information / POPIA compliance

We respect your privacy and acknowledge that this e-mail will contain Personal Information, which may belong to you, others and/or to your organization and which we will process. The processing of your personal information by Savannah Environmental may be included in reports submitted to governmental departments or on our public platforms, which processing will be done in accordance with our processing notice housed on our website - <https://savannahsa.com/privacy-policy-privacy-policy-page/>. By sending and/or receiving this message, you hereby expressly give us consent to process the Personal Information contained herein which processing will be done in accordance with POPIA Act 4 of 2013.

This email has been scanned for viruses and malware, and automatically archived by **Mimecast SA (Pty) Ltd**, and is believed to be clean.



## MASTER THESIS REPORT

---

# **Agrivoltaic system: a possible synergy between agriculture and solar energy**

---

SEPTEMBER 2019 - MARCH 2020

DOS SANTOS Charline  
MJ232X - Examensarbete inom kraft - och värmeteknologi, avancerad nivå  
Department of Energy Technology  
TRITA-ITM-EX 2020:57

## **Acknowledgements**

I would like to express my special thanks of gratitude to my supervisor, Youcef Ait El Kabous, for all his time dedicated to develop my skills and knowledge, for his support and for including me fully in his projects.

I express my profound thanks to my manager, Jennifer Ménagé, for making my internship very interesting, trusting me and giving me sound advice.

I would like to thank Marion Ng Wing Tin for helping me with the technical and innovative aspects of agrivoltaic projects.

I would also like to thank the entire team of the North development department at EDF Renewables France for their welcome, their advice and the good times shared.



**KTH Industrial Engineering  
and Management**

**Master of Science Thesis TRITA-ITM-EX 2020:57**

## **Synergies between agriculture and solar energy**

Charline Dos Santos

Approved	Examiner <b>Justin CHIU</b>	Supervisor <b>Justin CHIU</b>
	Commissioner	Contact person <b>Youcef AIT EL KABOUS</b>

### **Abstract**

The development of photovoltaic energy requires a lot of land. To maximize the land use, agrivoltaic systems that combine an agricultural and an electrical production on the same land unit are developed. A demonstrator was built in Montpellier (France) with different experimental arrangements to study the impact of a fixed and a dynamic solutions on the crops below the panels. The effect of shade on lettuces appears to be positive with a Land Equivalent Ratio greater than 1. To extend the experiment to other crops, the crop species best adapted to the agrivoltaic system are identified. The shade tolerance and vulnerability to climate change are key parameters to select crops that will benefit the most from the installation of PV panels. The SWOT analysis brings out that agrivoltaic systems can be a solution to maximize the land use and to adapt crops to climate change. The technical constraints imposed by the PV structure must be overcome to deploy this technology on a large scale. The greatest threat lies in the non-acceptability of the projects by farmers and the chambers of agriculture. An agrivoltaic project was developed in the South of France as a first testing area but was finally abandoned because of too important reciprocal constraints for the farmer and the operator.

Utvecklingen av fotovoltaisk energi kräver mycket mark. För att maximera markanvändningen utvecklas agrivoltaiska system som kombinerar en jordbruksproduktion och en elektrisk produktion på samma markenhet. En demonstrant byggdes i Montpellier (Frankrike) med olika experimentella arrangemang för att studera effekterna av en fast och en dynamisk lösning på grödorna under panelerna. Effekten av skugga på sallader verkar vara positiv med en LER som är större än 1. För att utvidga experimentet till andra grödor identifieras de grödor som bäst anpassas till det agrivoltaiska systemet. Skuggtoleransen och sårbarheten för klimatförändringar är viktiga parametrar för att välja grödor som kommer att dra mest nytta av installationen av PV-paneler. SWOT-analysen visar att agrivoltaiska system kan vara en lösning för att maximera markanvändningen och anpassa grödorna till klimatförändringar.

De tekniska begränsningarna som PV-strukturen sätter måste övervinnas för att kunna använda denna teknik i stor skala. Det största hotet ligger i att projekten inte godtas av jordbrukare och jordbrukskamrar. Ett agrivoltaiskt projekt utvecklades i södra Frankrike som ett första testområde men övergavs slutligen på grund av för viktiga ömsesidiga begränsningar för bonden och operatören.



# Contents

<b>1</b>	<b>Introduction</b>	<b>9</b>
<b>2</b>	<b>Innovative solution to combine agriculture and energy</b>	<b>10</b>
<b>3</b>	<b>Methodology</b>	<b>11</b>
<b>4</b>	<b>Results: Optimization of parameters</b>	<b>13</b>
4.1	Design of the PV plant . . . . .	13
4.2	Crop management . . . . .	14
4.2.1	Key parameters for crop selection . . . . .	14
4.2.2	Study of some crops . . . . .	16
<b>5</b>	<b>Results: Development of project</b>	<b>20</b>
5.1	Background and funding of PV projects in France . . . . .	20
5.1.1	General context . . . . .	20
5.1.2	PV projects in agricultural zone . . . . .	21
5.1.3	Incentives for innovation . . . . .	22
5.2	The steps of development . . . . .	23
5.3	EDF agrivoltaic demonstrator . . . . .	25
5.4	Project in development at Sainte-Tulle . . . . .	26
5.4.1	Site identification . . . . .	27
5.4.2	Pre-feasibility study . . . . .	27
5.4.3	Promises of lease and conditions . . . . .	30
5.4.4	Obstacles . . . . .	31
<b>6</b>	<b>Results: Analysis of the technology</b>	<b>32</b>
<b>7</b>	<b>Comparison with wind projects</b>	<b>35</b>
7.1	Regulatory context in France . . . . .	35
7.2	The funding of wind farm projects in France . . . . .	37
7.3	Wind turbine and agriculture . . . . .	37
<b>8</b>	<b>Discussion</b>	<b>38</b>
<b>9</b>	<b>Conclusion</b>	<b>38</b>

## List of Figures

1	Activities of EDF Renewables . . . . .	8
2	Soil occupation in 2018 in Metropolitan France (French Ministry of Agriculture Food and Forestry, 2018) . . . . .	9
3	Solar plant in Toul-Rosières (France). Source: EDF Renewables France . . . . .	10
4	Scheme of an agrivoltaic system . . . . .	11
5	Schema of Sun'Agri 1: the first prototype of agrivoltaic system (Sun'R, 2017) . . . . .	12
6	Schema of Sun'Agri 2. PV strings in blue are controlled by an algorithm whereas black ones are stationnary. Full sun areas are control areas (Valle et al., 2017) . . . . .	12
7	Agrivoltaic farm schematic spaced to allow farming under the panels (Dinesh and Pearce, 2016) . . . . .	13
8	Scheme difference between monofacial and bifacial modules. . . . .	14
9	Surface and production for different vegetables in France. Surfaces are expressed in hectares and production in kilotons. (French Ministry of Agriculture Food and Forestry, 2018) . . . . .	17
10	Steps of the development of a photovoltaic project . . . . .	25
11	Photo of the EDF agrivoltaic demonstrator located in Ecuelles (France) . . . . .	26
12	Simplified scheme from the modeling of agrivoltaic system used by EDF (Edouard et al., 2019) . . . . .	26
13	Identification of the site for the agrivoltaic system in Sainte-Tulle. Source: Cartographic data from Geoportail . . . . .	27
14	Daily sum of global irradiance per month in Saint-Tulle. Source: PV planner application, Solargis . . . . .	28
15	Environmental stakes of the project zone in Sainte-Tulle. The project zone is delineated in red. . . . .	29
16	Electrical interconnection path between the project zone and the closest station. The project zone is delineated in red. . . . .	29
17	Passage of a gas pipe (in yellow) in the South of the project zone. . . . .	30

## List of Tables

1	Results of lettuce (four different species) yield and solar irradiation in two configurations : half density (HD) and full density (FD), Montpellier fixed agrivoltaic project (Marrou et al., 2013b) . . . . .	18
2	Results of lettuce yield (Kiribati species) and solar irradiation from the prototype Sun'agri 2 in three configurations : HD (half density), ST (solar tracking) and CT (controlled tracking) . . . . .	18

3 Average lifetime of orchards for different species. (Regional direction of Food, Agriculture and Forestry in New-Aquitaine, 2019) . . . . . 18

## List of acronyms

AV: Agrivoltaic

agriPV: Installation that combine a PV production and an agricultural activity

CAP: Common Agricultural Policy

CDPENAF: Departmental directorate for the protection of natural, agri-cultural and forest areas

COP: Cereal, oilseeds and protein crops

CRE: the French Energy Regulatory Commission

CT: Controlled tracking - Algorithms developed to track the path of the sun only from 11 am to 3 pm

dB: decibel

DDT: Territory Departmental Directorate

EDF: Electricity of France

EDF OA: Electricity of France Obligation to purchase

FD: Full Density

HD: Half Density

ha: hectare, 1 ha = 10,000 m<sup>2</sup>

INRA: the National Institute for Agricultural Research

W: Watt, unit of power

W<sub>p</sub>: Watt peak, unit of power of a photovoltaic cell under standard condition (irradiation of 1,000W/m<sup>2</sup> and cell temperature of 25°C)

Wh: Watt-hour

We: electrical watt, unit of power produced by a generator in normal condition (1 We  $\approx$  0.8 W<sub>p</sub> for a solar cell)

LER: Land Equivalent Ratio

PLU: Local Urbanism Plan

PPA: Power Purchase Agreement

PV: Photovoltaic

R&D: Research and Development

ST: Solar tracking - Algorithm developed to track the path of the sun during all day

STICS: multidisciplinary simulator for standard crops

SWOT analysis: Strengths, Weaknesses, Opportunities and Threats analysis

ZPS: Special Protection Zone

## Context of the master thesis

This master thesis is realized in the context of a six-month internship in the company EDF (Electricity of France) Renewables France at the department in charge of the development of solar and onshore wind projects. EDF Renewables France is the subsidiary of EDF responsible for the development of renewable energy projects (both wind and photovoltaic) in France. EDF Renewables (that includes EDF Renewables France and international) is one of the leading companies in the renewable energy sector. Its activity is distributed between wind energy (81% of the total activity and 10,309 MW installed), solar energy (17% of the total activity and 2,402 MWp) and innovative development such as storage.

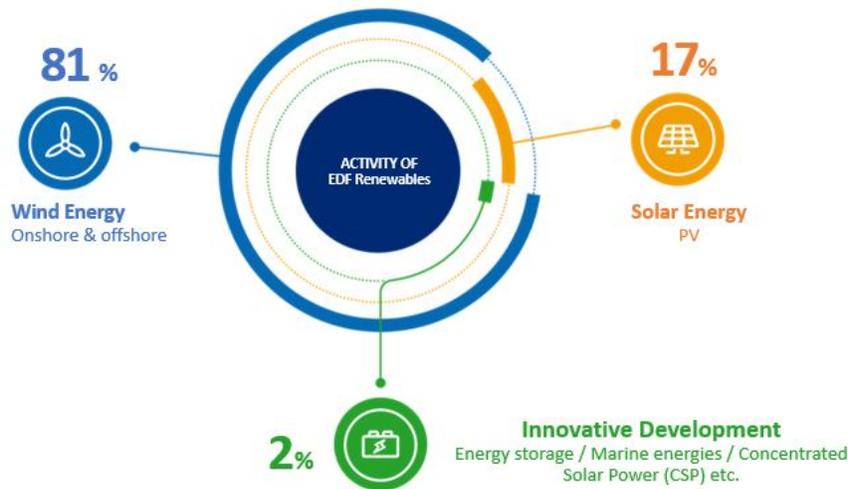

Figure 1: Activities of EDF Renewables

EDF Renewables France is an integrated operator. Its areas of expertise include project development, construction of photovoltaic or wind farms, clean energy production, operation and maintenance of the farms and dismantling and recycling of installations.

Project development includes all stages from the identification of the area of interest to the completion of the building permit for solar projects or the environmental permit for wind power projects.

In 2018, EDF announced a solar plan to build 30 GW of solar capacity between 2020 and 2035 in France. In comparison, currently, EDF exploits 920 MWp in 8 countries.

Within the development department, I work on the regions Centre-Val de Loire and Bourgogne-Franche-Comté, located in the centre of France. My main mission focuses on the innovative agrivoltaic solutions. I am also in charge of a wind power project in the centre of France.

# 1 Introduction

The competition for land use between energy and food dates back to the 1970s. The first oil shock encouraged countries to develop alternative energy sources to petroleum. Brazil launched The National Alcohol Program to promote bioethanol as a fuel. Ethanol was mainly produced from sugar plants. Growing sugar plants to produce bioethanol is more profitable than growing sugar plant for food purpose. As a consequence, many farmers started to grow plants for fuel rather than food. It entailed a food crisis and the rise of food prices. There is not enough land to fulfill the needs for food and energy when biomass is used as an energy source (Popp et al., 2014).

The world demand of energy is rising mainly due to an increase of the world population, a more energy-intensive industrial sector and an increase in the average standard of living. At the same time, the threat of climate change is changing the energy strategy. A shift from fossil fuels towards renewable energies is unavoidable and necessary to curb the climate crisis. Solar energy has the potential to offset a significant fraction of non-renewable electricity demands globally. It is currently the fastest growing power generating technology. However, ground-based solar PV panels will increase the pressure on agricultural land and compete with agriculture.

In 2018, cultivated areas represented 35% of the metropolitan territory and 52% of this territory is dedicated to an agricultural use if grass surfaces are taken into account in France.

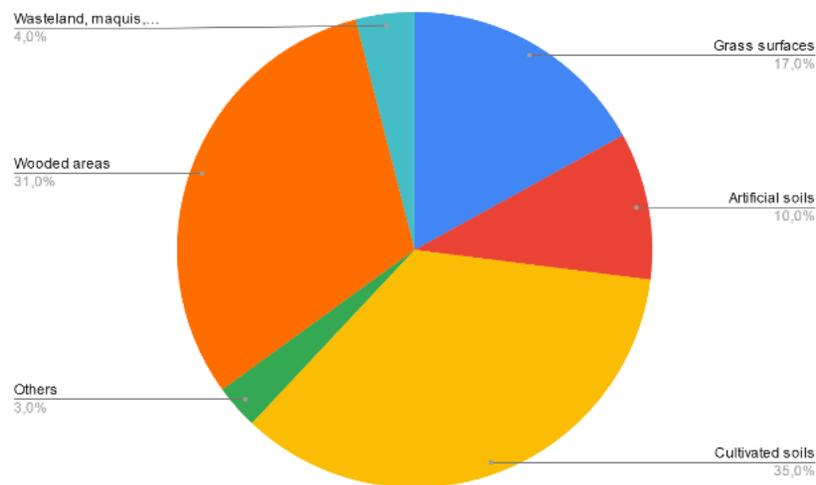

Figure 2: Soil occupation in 2018 in Metropolitan France (French Ministry of Agriculture Food and Forestry, 2018)

The installation of photovoltaic power plants on agricultural land is therefore an important opportunity to increase the share of renewable energy in the French energy mix. However, this should not be done at the expense of agricultural production. That is why it is important to develop synergies between food and energy as we need both of them.

## 2 Innovative solution to combine agriculture and energy

The current dominant scheme of production is to separate the land area and to devote one part to food production and the other to fuel production (crops for biodiesel or land for solar plant). Ground-based solar farms raise the question of land management. Currently, 1 hectare of land allows the implantation of a solar plant of 1 MW in the center of France. The power per hectare is higher in the South and lower in the North due to the difference of solar resource. To have a profitable project, the minimum surface needed is 10 hectares (1 ha = 10,000 m<sup>2</sup>). Thus, the development of solar farm triggers a new competition for land : food vs energy. To reach its target of 30 GW in 2035, EDF needs to install PV farms over a surface of 30,000 ha in France.

Therefore, solar plants using ground-based PV panels will compete with agriculture for land. Solar panels and crops will compete for solar radiation. This master thesis focuses on the possible synergies between agriculture and solar energy and more precisely to find solutions to combine fuel and food production on the same land unit.

One synergy already developed in France is the combination of pastoralism and photovoltaic production. Solar panels are elevated at 1 meter above the ground to let the sheep herd walk under the panel. The sheep herd ensures the maintenance of the grass. The first solar plant was inaugurated in 2012 in Toul-Rosières (France) and it is the first project of its kind. Feedbacks are very positive and the cohabitation works. The sheep herd got accustomed to the panels and the grass production under panels is suitable for the pastoralism activity. The main drawback is the difficulty for the farmer to notice sick animals.



Figure 3: Solar plant in Toul-Rosières (France). Source: EDF Renewables France

The combination of pastoralism and photovoltaic production is an example of synergy between an agricultural activity and electricity production. However, it can not be implemented on every type of agricultural land. Lands used to grow crops are not going to be converted into grass production just in order to develop a photovoltaic production on the land. Innovative solutions need to be found to combine crop production and electricity production.

Goetzberger and Zastrow are the first to explore the idea of mixing solar panels and food crops. Their idea is to elevate by about 2 meters above the ground the panels and to increase the distance between collectors to achieve a nearly uniform radiation (Goetzberger and Zastrow, 1982). Mixed systems that associate, on the same land and at the same period, food crops and photovoltaic panels are called agrivoltaic systems or agri-PV. Two kinds of agrivoltaic systems are developed: fixed panels elevated above crops or a dynamic system with panels coupled with trackers.



Figure 4: Scheme of an agrivoltaic system

The agrivoltaic systems developed by EDF Renewables France is a dynamic agrivoltaic system. Solar panels are put on elevated structures. The elevation will depend on the plants below and will ensure the structure to be suitable with the exploitation of the land under the panels. Panels have a rotating and a tracking system ruled by an algorithm. They let the sun rays reach the crop while it needs it by adopting a certain position. Pv panels only capture the solar energy in excess.

### 3 Methodology

The first aim of this master thesis is to study the optimization of all the parameters for the agrivoltaic system. The optimal parameters to design both the PV plant and the agricultural production are defined thanks to literature. In 2009, a partnership was signed between Sun'R, a private photovoltaic operator and INRA (the National Institute for Agricultural Research) to develop a research and development program on the concept of agrivoltaic system.

A first prototype of agrivoltaic system was built in Montpellier, France in 2009. It is the practical support for the large majority of papers dealing with agrivoltaic system. This prototype was set up to validate agrivoltaic models and to study the adaptation of crops to shade.

It was built on a surface of 820 m<sup>2</sup>. Panels are monocrystalline modules elevated at 4 metres above ground. The panels are fixed with a tilt angle of 25°. The tilt angle is not theoretical optimal tilt angle which equals the latitude. It may be the results of an optimization between reducing the shade to increase the number of rows of panels and increasing the electrical production. It is oriented towards East with a 14° aspect angle orientation. The prototype was divided in two different subsystems differing in the density of solar panels: a full density (FD) part which



optimizes the electrical production and a half density (HD) part which allows more radiation to reach the crops. The space between two different rows was 1.6m in FD and 3.2m in HD.

A 200 m<sup>2</sup> control zone was also set next to the prototype to be on a similar soil but far enough to not be shaded.

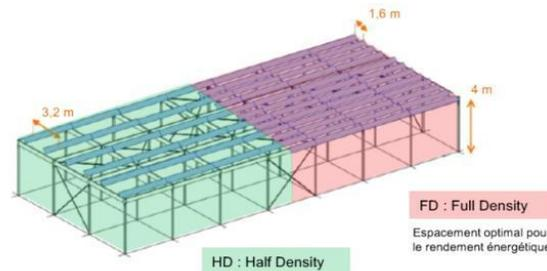

Figure 5: Schema of Sun'Agri 1: the first prototype of agrivoltaic system (Sun'R, 2017)

Studies demonstrated the necessity to install movable panels to have a real benefit on the agricultural production (Valle et al., 2017). As a consequence, in 2014, Sun'R built a dynamic agrivoltaic system next to the fixed one. Panels have trackers to follow the sun path in order to maximize the electricity production and to create the best conditions for crops. Two algorithms were tested: solar tracking (ST) that follows the path of the sun during all the day and controlled tracking (CT) that follows the path of the sun only from 11 am to 3 pm. This new prototype led to new experiments on vegetables and vine trees mainly. Researches in progress may define the optimal steering of the panels and the irrigation in order to maximize the yield and the quality of crops.

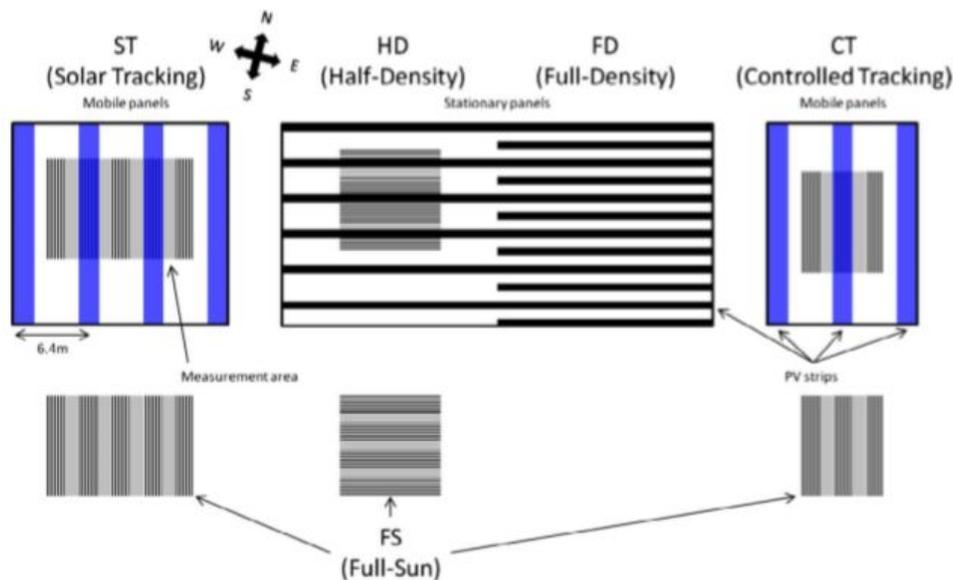

Figure 6: Schema of Sun'Agri 2. PV strings in blue are controlled by an algorithm whereas black ones are stationary. Full sun areas are control areas (Valle et al., 2017)

The last prototype developed by Sun'R, called Sun'Agri 3, is also a dynamic agrivoltaic system with trackers. Three types of crops are targeted: viticulture, arboriculture and market gardening. This master thesis includes also a part of development of project. Once all the parameters of the agrivoltaic systems are defined, a real and large scale project needs to be developed and built. The idea there is to highlight all the obstacles that are mainly humans. Last part of this report is the analysis of the technology thanks to a SWOT analysis.

## 4 Results: Optimization of parameters

### 4.1 Design of the PV plant

In order to combine the agricultural and the electricity production, the design of the PV plant needs to be adapted. Solar panel and crops compete for solar radiation.

Firstly, the panels need to be elevated. The elevation depends on the height of the crops and also on the height of the agricultural machine used to harvest. The higher the panels are, the more robust they need to be. Indeed, the structure has to resist the wind. As a consequence, the mounting system is more expensive for agrivoltaic systems compared to common ground-based PV plants.

Then, the panels need to be spaced. The spacing between the PV modules has to be large enough to allow standard sized farming equipments to go through the rows of panels. Besides, the space between PV modules allows the light to reach the crop. A reduced density of panels may be profitable for the crops. It is important to notice that the height of the PV panels does not have any effect on the total quantity available at the soil level but it does affect the heterogeneity of the light. The closer the panels are to the ground, the more heterogeneous the radiation is.

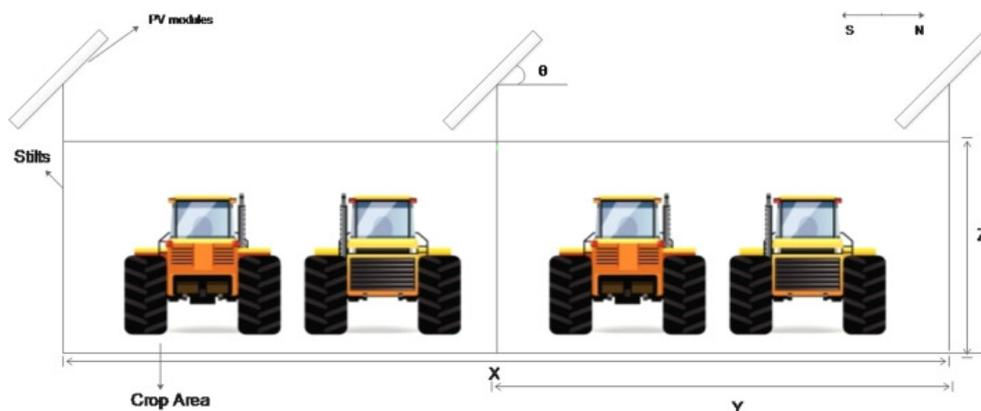

Figure 7: Agrivoltaic farm schematic spaced to allow farming under the panels (Dinesh and Pearce, 2016)

To increase the radiation available for crops, transparent or semi transparent modules can be used. One optimal solution could be the installation of bifacial solar modules. They are semi-transparent cells which can capture the radiation on their two faces. The back of the panels is

also a silicium layer and is not an opaque black sheet as traditional panels. As a consequence, a part of the radiation can go through the modules. They capture both the direct and the diffuse solar radiation. That increases the overall efficiency.

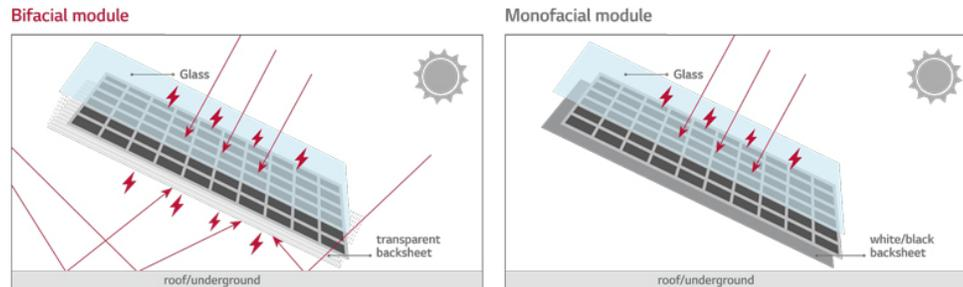

Figure 8: Scheme difference between monofacial and bifacial modules.

The consequence of agrivoltaic systems installation is quite clear on the solar production. Indeed, compared to ground-based solar farm, the light sharing triggers a reduction of the electricity production. The cost of the installation is higher. The maintenance of the panel will also be more difficult. However, the implementation of this technology will increase the available surface for solar projects. For ground-based solar farms, 1 hectare of land allows to build a solar plant of 1 MW. With an agrivoltaic system, 1 hectare of land allows to implement a solar plant of 0.5 MW.

## 4.2 Crop management

The selection of crops suitable with the installation of photovoltaic panels above is a key aspect for the success of the project. Indeed, it will modify its sun exposure, the shade, the water availability etc. A study based on literature review was performed to highlight the parameters of the crop affected by the photovoltaic plant and to determine which crops are the best suitable for agrivoltaic system.

### 4.2.1 Key parameters for crop selection

- Shade Tolerance

The main consequence of the installation of a PV plant above crops is the creation of shade. It is important to know precisely the shade tolerance of crops under the panels that is to say their ability to tolerate low light levels.

For some species, it seems that the growth rate does not decrease below the PV panels except during the juvenile phase (Marrou et al., 2013a).

The implementation of agrivoltaic systems involve changes in cropping practices. Plants able to maximize their radiation use efficiency should be prioritized. Light reduction has not necessarily a harmful effect on crops that can adapt and improve radiation interception efficiency (Marrou et al., 2013b). The lack of studies on the large majority of plant precludes any conclusion on the

impact of shade on plant growth. However, it is quite admitted that for the majority of plant, it will trigger a reduction of plant characteristics.

The optimum shade level for photosynthetic photon flux density is high enough to saturate carbon dioxide assimilation but low enough to induce shade acclimation and reduce photoinhibition (Dupraz et al., 2011).

- Water stress and irrigation

Shade provided by PV panels could prevent the damaging effect of excessive light and it could limit evapotranspiration during peaks of evaporable demand. The plants that will benefit most from the system will be plants with high water requirements and plants that are not resistant to water stress.

- Height

Crops under the panel should not exceed a certain height during their lifetime. Panels are elevated at 4 or 5 metres.

- Crop rotation

It refers to recurrent succession of crops on the same piece of land either in a year or over a longer period of time. The objective is to get maximum profit and ensure the preservation of the fertility of the soil and to keep a uniform distribution of soil nutrients. Crops are divided into exhaustive crops and less exhaustive crops. The crops which uptake higher amount of nutrients from the soil are called exhaustive crops. It is important to take into consideration crop rotation before the installation of the agrivoltaic system to ensure the sustainability of the agriculture under the panels. Every crop decided before the construction of the PV plant should respect criteria mentioned here. They also should be modeled by the STICS model. The STICS model is a generic model for the simulation of crops and their water and nitrogen balances developed by the French institute INRA.

- Lifetime

The exploitation of the PV plant lasts 30 years. The installation of the PV panels will not move during 30 years. As a consequence, it is not possible to grow crops which need huge soil labour during these 30 years. For example, it is not practicable to uproot a tree while the PV installation is there.

- Climate change resilience

Climate change causes higher temperature, higher risks of drought and more radiation stress for crops. The agrivoltaic system increases the shade for crops and it is a protection against climate change consequences. It is interesting to target crops which are badly affected by climate change and for which agrivoltaic systems will contribute to improve their yield.

#### 4.2.2 Study of some crops

A first qualitative study on different open-field farming was conducted in order to identify species that are the most suitable with the criteria of adaptation for agrivoltaic installation.

- Cereal, oilseeds and protein crops (COP)

The main interest of these crops relies on the huge available surface they represent. Indeed, 45% of the total agricultural surface in France is used to grow cereals, oilseeds and protein crops (Agreste, 2018). The main drawbacks linked to the installation of agrivoltaic infrastructure are the loss of harvest at the bottom of the mounting system and the loss of time due to the manoeuvre needed to avoid the mounting system. The photovoltaic installation will also have to deal with the height of the agricultural machines and the system of irrigation. The partnership between INRA (French National Institute for Agricultural Research) and EDF Renewables France helps to study the adaptation of species to agrivoltaic system. The main benefit is the protection for plants of water stress. Indeed, panels trigger shade protection and shade reduce transpiration needs. This benefit will be important for species harvested at the end of the spring or during the autumn such as corn, sunflower or soybean. In addition to that, the agrivoltaic system could protect the crops against hail, frost, erosion or heavy rain.

An experiment to test the shade tolerance of some maize species was performed (Fu et al., 2009). It was conducted under 50% shading. The plant height, the stem diameter, the leaf net photosynthetic rate, the specific leaf weight and the dry matter accumulation were compared. On the 24 maize species tested, 14 were shade-tolerant and 10 were shade-sensitive. These results are encouraging concerning the compatibility of maize with the agrivoltaic system.

Shade also has effect on sunflower. Experiments show that a reduction of incident radiation between floral initiation and 20 days after the first anthesis reduces the grain number in sunflowers (Cantagallo et al., 2004).

- Industrial cultures

Industrial cultures include industrial beets, fibre plants such as line or hemp, aromatic plants, medicinal plants and other industrial cultures such as tobacco, hop or chicory. The large majority of industrial cultures grows in the North of France where sun resources are quite limited. At first sight it is not interesting to develop agrivoltaic system above industrial cultures. There are some exceptions with aromatic plants such as lavender which grow exclusively in the South of France.

- Vegetables and potatoes

Cultivated species are varied in France. Figure 8 shows there is no obvious link between cultivated surface and production. Peas and lentils use large surfaces for a low volume of production. Agrivoltaic systems need large surfaces. However it is also important to take into account the principle of crop rotation for vegetables.

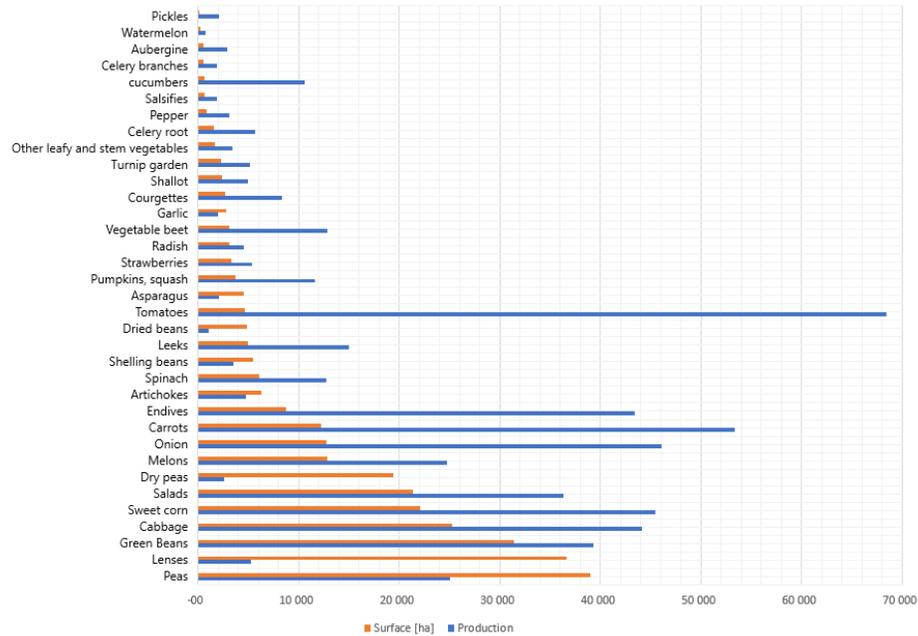

Figure 9: Surface and production for different vegetables in France. Surfaces are expressed in hectares and production in kilotons. (French Ministry of Agriculture Food and Forestry, 2018)

Exhaustive crops which seem interesting according to Figure 9 are tomato, cabbage and potato. Less exhaustive crops that can be chosen to study their potential for synergies with PV production are pea, bean, onion, lettuce and carrot. All these crops are well distributed on the territory and especially in the South of France. There is still a need to study the irrigation of these crops and to perform agronomic simulation to highlight the best combination of vegetables suitable with a photovoltaic production.

Some synergies between the agrivoltaic system and anti-insect net used for some crops such as lettuce or cabbage are practicable. The agrivoltaic installation could also protect the crops from climatic variations (hail, frost, heavy rain). It could regulate the water intake to control the quality of vegetables.

- Lettuces

Lettuces were grown under the prototype of agrivoltaic system of Sun'R in Montpellier. As a consequence, some results concerning their adaptation to the agrivoltaic systems are available (Marrou et al., 2013b). Four varieties of lettuces were studied under two shade levels : 50% (HD) and 70% (FD) of the incoming radiation during Sun'agri1. The effect on crop yield and the morphological and physiological response of the plant were analysed.

Figure 1 shows that every ratio is superior to one. The ratio is defined as the ratio of crop yield on solar irradiation. Biomass reduction is less than the available light reduction. The lettuce has the capacity to produce biomass more efficiently when the light resource is reduced. Under half density panel, lettuces maintain relatively high yields under PV. Lettuces improve their ability to

	Summer 2010			Spring 2011		
	Solar irradiation	Yield	Ratio	Solar irradiation	Yield	Ratio
<b>FD</b>	53%	58%	1.09	53%	79%	1.49
<b>HD</b>	68%	81%	1.19	73%	99%	1.36

Table 1: Results of lettuce (four different species) yield and solar irradiation in two configurations : half density (HD) and full density (FD), Montpellier fixed agrivoltaic project (Marrou et al., 2013b)

intercept light thanks to morphological changes. Experiments show lettuces increase the total plant leaf area and optimize leaf area arrangement to harvest light more efficiently. Lettuces grow at the same rate during the period of maximal vegetative growth but the growth rate is reduced at the beginning of the plant life cycle (Marrou et al., 2013b).

The dynamic prototype developed by Sun'R, called Sun'agri 2, also tested the impact of the PV panels on lettuces. High productivity per land area unit was reached when trackers are implemented compared to stationary PV panels tested in Sun'Agri 1. It justifies the interest to develop algorithms that take into consideration the plant needs and to install trackers (Valle et al., 2017).

	Spring 2015			Summer 2015		
	Solar irradiance	Crop yield	Ratio	Solar irradiance	Crop yield	Ratio
<b>HD</b>	59%	71%	1.21	56%	68%	1.21
<b>ST</b>	63%	74%	1.18	62%	76%	1.23
<b>CT</b>	82%	83%	1.01	83%	76%	0.92

Table 2: Results of lettuce yield (Kiribati species) and solar irradiation from the prototype Sun'agri 2 in three configurations : HD (half density), ST (solar tracking) and CT (controlled tracking)

- Fruit farming

Fruit farming gather arboriculture (stone fruit and nuts) and bays (blackcurrant, blueberry, raspberry etc.). The large majority of the fruit culture is in the South of France.

Apple	Pear	Peach	Plum	Apricot	Cherry	Nut	Kiwi	Grape
15	29	10	21	12	18	28	18	23

Table 3: Average lifetime of orchards for different species. (Regional direction of Food, Agriculture and Forestry in New-Aquitaine, 2019)

The lifetime of fruit trees is a limitation for the development of agrivoltaic system above them. Indeed, photovoltaic plants are exploited during 25/35 years. Only a few of species have a lifetime longer and it would be difficult to clear and replant trees while the PV structure is in place. One

other obstacle of the combination of fruit farming with PV plant is the height of trees. The maximum height for agrivoltaic systems can not exceed 5 m. For example, nut trees reach a too high height. The only fruit tree compatible with the agrivoltaic infrastructure based on these two criteria (lifetime and height) is the pear tree. INRA studies show a reduction of the number of pear trees in France and the low replacement of pear trees (due to their high lifetimes) will reduce the opportunity of implementation of agrivoltaic systems.

In the case of a possible combination between fruit trees and agrivoltaic infrastructure, trees could benefit from a protection from climatic events (hail, heavy rain, frost) and could help control the need of cold for stone fruit.

Bays are free from all constraints studied above: their lifetime is long and the height of the trees is quite low. As a consequence, it is a really interesting plant and studies should deepen their potential.

- Viticulture

Constraints linked to arboriculture are not applicable to vine trees. Their lifetime is around 30 years and there are often cut and they do not exceed 1.5 m height. As in the case of fruit farming or vegetables, agrivoltaic system could be a solution to protect the vine from hail, frost and heavy rain. It will also provide shade and limit the drought. Heatwaves have terrible consequences on vine. Indeed, it slows the grapes maturation, can burn the grapes and entails production loss. It would also help fighting against the spring frost to which the vine is particularly sensitive.

Thus, the comparison of different crops shows that some crops are more suitable for the installation of a photovoltaic production. This study helps to focus on the species with the largest chance to survive and develop under PV panels. The interesting species for now are vine trees, pear trees, lavender trees, COP and combination of exhausting plants (tomato, cabbage and potato) and less exhaustive plants (pea, bean, onion, lettuce and carrot).

It shows that some plants like lettuce have the ability to adapt to these conditions and compensate partially or totally the reduction of light availability by a higher light harvesting capability. Our results suggest that these agrivoltaic systems can be optimized both by plant breeding and by specific arrangements of PV panels in order to find the best compromise between food production and electricity production on the same piece of land.

The impact of the agrivoltaic system on the agricultural yield is not obvious. Plants would have a reduced access to light which can limit their growth. However, it could improve the protection against climatic variations such as frosts, droughts, heavy rains or hails. It could provide shade to plants and it could reduce water stress by reducing the plant evapotranspiration. Climate change is a real threat for the agricultural sector and agrivoltaic system could be a solution to reduce the drastic impact of climate change on crops.



## 5 Results: Development of project

### 5.1 Background and funding of PV projects in France

#### 5.1.1 General context

France is willing to harness its solar potential. Indeed, France set the target of 32% of renewable electricity in the energy mix by 2030 compared to the 22% achieved in 2018 (French Ministry of Ecological and Inclusive Transition, 2019). To reach this target, the French government focuses especially on the development of solar energy. They plan to increase the total solar capacity in France from 8,300 MW to 18,200-20,200 MW in 2023.

Currently, two different kinds of solar plants are widespread in France. The first one is ground-based solar farms which maximize the solar energy production because the orientation, the tilt angle and the localisation can be chosen precisely. The second option is solar plants installed on the roofs of industrial, commercial and municipal buildings and connected to the electricity grid. Other technologies such as floating PV are emerging in France too. This paper focuses only on the first case, ground-based solar farm.

To promote the development of solar projects in France, the CRE (the French Energy Regulatory Commission) launched call for tender for ground-based solar plants. Every 6 months, a new call for tender with a certain volume of projects is published by the CRE. This tender is divided into three families:

- Family 1: ground-based photovoltaic installation with a power superior to 5 MWp
- Family 2: ground-based photovoltaic installation with a power between 500 kWp and 5 MWp
- Family 3: photovoltaic installation on parking shelters with a power between 500 kWp and 10 MWp

For example, the last tender ended in June 2019 and represented a cumulative power of 550 MWp for installations of family 1. That is to say the sum of the power of all the winning projects can not exceed 550 MWp in that case. Each application form has to detail the offer and has to include the localisation and the nature of the site chosen for the project, the expected feed-in tariff, the environmental impact of the project, the business plan and the technology used.

In order to preserve woody and agricultural areas and to minimize the environmental impact of projects, implementation sites selected for solar projects have to belong to one of these three categories:

- Case 1: The site location is an urbanised area or a zone to be urbanised according to the Local Urbanism Plan (PLU).
- Case 2: The site location is a natural zone with a special mention “Renewable energy” according to the urban planning document in effect. The site has to be not situated on a wetland and the project is not subjected to land clearing authorisation.

- Case 3: The site is a degraded site such as an airfield, an old mine, an old quarry etc.

For cases 1 and 2, the power of solar project is limited to 30 MWp. It is important to notice that no project can be developed on agricultural lands.

It is important to understand the status of the PLU. It is the leading document in town planning. It is a map of the city divided into different zones affected by different urbanization rules. It indicates for each zone the nature of the area, the kind of project authorized on the zone, the obligations to respect. It is the blueprint for the orientation and evolution of the city. The main zones are: A (agricultural area), N (natural area), U (urbanised area) and AU (to be urbanized).

Then, each offer is assessed according to 3 criteria: price, carbon impact and environmental relevance. The rating scale is allocated as follow: the price represents 70 % of the total rate, the carbon impact 21% and the environmental relevance 9%. The carbon impact criterion mainly focuses on the carbon impact of the solar panel and the point for environmental relevance is attributed if the project belongs to case 3 (it is located on a degraded site). Once every offer is rated, the CRE ranks them and selects the top projects while their cumulative power is inferior to the total power proposed in the tender. Every winner of the tender benefits from a feed-in tariff guaranteed for 20 years. Feed-in tariffs are huge incentives for renewables because investors receive a guaranteed price for renewable power generation (per kWh) for a specific time period. The average feed-in tariff for the last tender was 67.2€/MWh. In comparison the fixed price of nuclear electricity in France is 42€/MWh. Every solar project will sell its electricity to the spot market. When the tariff on the market spot is inferior to the feed-in tariff retained by the CRE, the CRE fund the difference. On the contrary, if the tariff on the market spot is superior to the feed-in tariff retained by the CRE, the solar energy producer gives the surplus to the CRE.

### **5.1.2 PV projects in agricultural zone**

The development of PV projects is really framed by the rules of the CRE. Photovoltaic projects implemented in agricultural parcels also have to respect the rules of urban planning of the city (as for every project) to obtain the building permit.

In August 2016, a legislative decree set new modalities of application for agricultural compensation. Every operator needs to study the potential impact of the project on the agricultural activity. This decree applies to every parcel in zones A or N with an agricultural activity during the last five years or parcel in zone AU with an agricultural activity since three years (CDPENAF, 2017). Once the impacts are identified, operators have to propose measures to avoid, reduce and compensate their impact to the Departmental directorate for the protection of natural, agricultural and forest areas (CDPENAF). Allowances can be individual in order to compensate the loss of income (decrease of CAP aid from Europe, crop destruction etc.) or collective (funding of collective projects, participation in a collective compensation fund etc.).

As a consequence, regulations imposed by the CRE, expansive agricultural compensation and town planning laws curb the development of PV plants on agricultural land. However, solar plants can be funded outside the call for tenders process. The electricity can be sold directly on the spot market or a corporate PPA (Power Purchase Agreement) can be concluded with a private entity that buys all the electricity from the solar plant.

EDF Renewables France only focuses on projects eligible for CRE's call for tender. Projects funded outside the call for tender process are considered too risky. Indeed, the price of electricity on the spot market is very fluctuating and can not ensure the profitability of the project. Moreover, PV panels produce electricity mainly at midday when the electricity is the cheapest. EDF Renewables France calculated that for a project not funded by the CRE, the minimum surface needed to be profitable is around 30-50 ha in the South of France whereas the average profitable solar project in France is 10 ha when it is funded by the CRE. Only projects with a very close electrical connection to the grid are competitive because surcharges of connection are very expansive. But, agricultural lands are often far away from electrical stations and quite isolated.

However, the politic and regulatory context is changing in France. The government tries to simplify the development of renewable energy project. In 2017, the first innovative CRE's call for tender was published and it granted 15 MWp for agrivoltaic systems.

### **5.1.3 Incentives for innovation**

To support innovation in the photovoltaic sector, the CRE launched innovative calls for tender. The procedure is comparable to the call for tender for ground-based solar farms described above. This call for tender is divided into two families:

- Family 1: Innovative photovoltaic ground-based solar installation with a power between 500 kWp and 5 MWp.
- Family 2: Innovative photovoltaic installation on buildings, agricultural hangar and parking shelters or agrivoltaic innovation with a power between 100 kWp and 3 MWp.

Agrivoltaic installations are defined in this call for tender as installations which couple a secondary photovoltaic production with an agricultural production and which allow a demonstrable functioning synergy.

To be selected, the implementation site has to belong to the three cases described above and a fourth case is possible in this call for tender:

- Case 4: For agricultural hangars and agrivoltaic installations of family 2 only, the site can be located on an agricultural land.

The rating scale is quite different. The price represents 55% of the total rate and the innovation 45%. Each offer needs to detail the innovation as precisely as possible.

Thus, in France, there are financial incentives through feed-in tariffs to develop agrivoltaic installations in order to combine photovoltaic and agricultural production.

## 5.2 The steps of development

To develop a project and to prepare an application for a call for tender CRE, many missions need to be fulfilled.

The first part is to identify the project. The site location, the owner and the farmer of the land and the availability of the site need to be defined.

Then, a study of pre-feasibility is performed. The aim is to define all the constraints and challenges of the site. Based on online inventories, environmental and patrimonial stakes are analyzed. The urban compliance is checked to confirm the possibility to build a photovoltaic plant in this area. The solar resource is estimated thanks to an online application called PV planner from Solargis. A study on the electrical connection to the grid is led to define where it is possible to connect, if there is enough capacity and what is the distance between the site and the station. The electricity network operator is consulted to estimate the price of the electrical connection. Finally, administrations are also consulted to know if there are servitudes to take into consideration. The administrations contacted are the Army, the Regional Health Agency, Territory Departmental Directorate, Department of Security of Civil Aviation and the Regional Directorate for Environment, Development and Housing. They make recommendations that must be taken into account for the design of the PV plant.

Once all the constraints are addressed, the site is considered as "qualified". Promise of emphyteutic lease are ratified between the owner of the land, the farmer and EDF Renewables France. This document clarifies all the commitments taken once the promise of lease is signed. It is valid for a period of seven years. During this period, the owner and the farmer allow EDF Renewables France to perform studies on their lands and they can not implement activities that can jeopardize the project.

In parallel of the signature of the promise of lease, the elected representatives of the city are consulted. The project is presented to the mayor and his municipal council. Their agreement is essential for the success of the project. The opinion of the mayor will be asked during the instruction of the project.

When the promise lease is contracted, studies can begin. Independent experts are consulted to lead different studies.

- An ecological study is launched to inventory animals and plants living on or next to the site. It highlights the ecological and functional stakes of the area. Heritage and endangered species are listed. Then, all the impacts and measures to implement in order to avoid, reduce and compensate the impact of the project are defined.
- An environmental impact study is performed and is defined precisely by the Environment Code (Article R. 122-5). It must include a non-technical summary, a description of the project (its characteristics and its environment), factors possibly affected by the project (population, human health, biodiversity, soil, water, air, landscape etc.), significant impacts, risks of accidents and disasters and the measures taken by the operator to avoid, reduce and compensate all the negative impacts of the project.

- A surveyor is commissioned to provide a topographical study. It identifies lines of communication, water point, diverse networks and also the height of vegetation and the typology of the soil.
- An architect is mandated to draw up the file for the building permit. He creates the ground plane, the situation plane and he realises the photo-montages.
- An intern study is led to choose the final design that takes into account all the conclusions of studies.

All these studies are compiled and some administrative documents are added to complete the building permit which is, then, registered. Public authorities analyze the permit and they can ask for some complementary pieces to complete the permit. Then, the Territory Departmental Directorate (DDT) requests the opinion of the Regional Environmental Authority and the simple notification of some administrations. The Regional Environmental Authority has two months to give its favourable or unfavourable decision. Once its decision is taken, the public inquiry of one month begins and is ruled by an investigating commissioner. During the public inquiry, questions from the population are asked to the operator who needs to answer precisely. One month after the closure of the public inquiry, the investigating commissioner publishes his report and gives an opinion, positive or negative, about the project. After the reception of the report of the public inquiry, public authorities have two months to investigate the case and to decide whether or not to authorize the construction of the photovoltaic plant. They do not have to follow the decision of the Regional Environmental Authority or the investigating commissioner.

To build the photovoltaic plant, the project also has to obtain a feed-in tariff by applying to the call for tender of the CRE. A business plan is edited and defines the expected feed-in tariff calculated to maximize the profitability of the project while guaranteeing a feed-in tariff at the call for tender. For common calls for tender for ground-based PV plant (paragraph 2.1), the building permit is necessary to apply contrary to innovative calls for tender (paragraph 2.2).

To apply to the innovative call for tender, some pieces are requested:

- The completed application form
- A certificate of eligibility for the site location of the project. The project has to be implemented on one of the four possible cases described by the call for tender (cf. paragraph 2.2)
- A report dealing with the contribution to innovation. It has to detail the proposed innovation, the installation considered, the regulatory context of the innovation, the positioning on the market, the technical relevance etc.
- A technical report about the synergies with the agricultural use. This report highlights the synergies developed between the PV plant and agricultural production: which crops are selected, what are the motivations, what is the light sharing adopted, the final design of the agrivoltaic system etc.

After obtaining a feed-in tariff, the operator has two years to build the photovoltaic plant. The different steps of the development of a photovoltaic project is summed up in Figure 10.

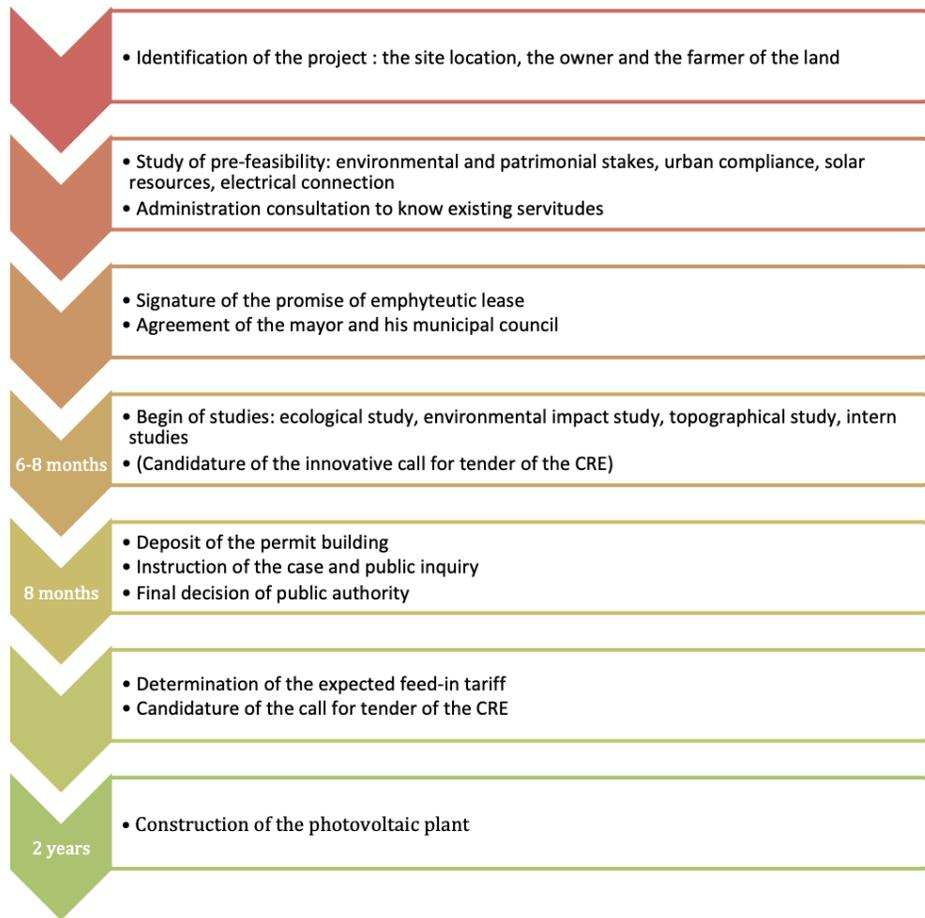

Figure 10: Steps of the development of a photovoltaic project

### 5.3 EDF agrivoltaic demonstrator

An agrivoltaic system was built in 2019 in the EDF Research & Development lab located two hours away from Paris. It is a dynamic system with a power of 155 kWp. The total surface of the demonstrator is 1,900 m<sup>2</sup>. Alfalfa was planted under the panels in order to test the adaptation of Alfalfa to shade and to test the development of algorithm. The functioning of the demonstrator is detailed by Figure 11.

A ray-tracing 3D tool was elaborated by EDF R&D in order to provide accurate predictions of PV plants yield. The radiation model is used to calculate the electrical production and to estimate the incident radiation (by ray tracing) to the crop. It is coupled to a crop model to simulate the growth of the plant. L-egume simulates the growth at the individual scale and allows to analyze the interaction between plants. STICS is a crop model, developed by INRA, that simulates plant growth at the field scale. It calculates both agricultural variables (yield, input consumption) and environmental variables (water and nitrogen losses). The input data of algorithms are instantaneous climate data (wind, solar radiation, temperature and hygrometry).



Figure 11: Photo of the EDF agrivoltaic demonstrator located in Ecuellas (France)

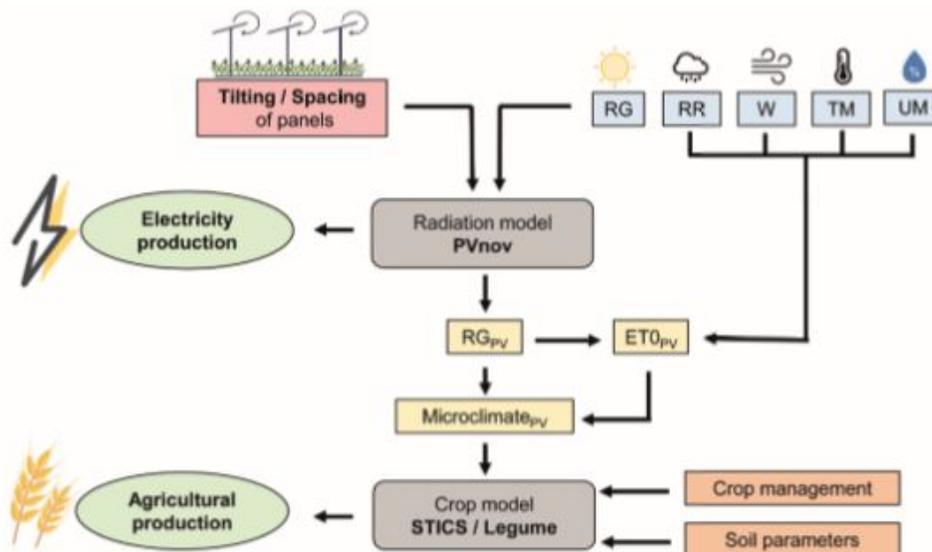

Figure 12: Simplified scheme from the modeling of agrivoltaic system used by EDF (Edouard et al., 2019)

## 5.4 Project in development at Sainte-Tulle

This master thesis includes a part of development of project. Once all the parameters of the agrivoltaic system are defined, a real and large-scale project needs to be developed and built. The target of this project is to be candidate for the call for tender "CRE innovation" which closes on the 3rd of April 2020.

### 5.4.1 Site identification

This project is a first test for EDF Renewables and its economical viability is not ensured. The site chosen for the project is located in the South of France where the solar irradiation is the highest and solar projects the most profitable. It is located in the city of Sainte-Tulle in the Region Provence-Alpes-Côte d'Azur. The owner of the land is EDF, the parent company of EDF Renewables. The farmer grows organic farming in this land since 2010. It is mainly cereals (soya, corn, wheat) but he practices crop rotation so it changes over the years. His total farm represents 110 ha and the surface targeted for the project is approximately 10 ha.



Figure 13: Identification of the site for the agrivoltaic system in Sainte-Tulle. Source: Cartographic data from Geoportail

### 5.4.2 Pre-feasibility study

The application PVPlanner from Solargis allows to estimate the PV output for one year. It is based on meteorological data of previous years to estimate the average sunlight. The PV output is then used in the business plan to determine the profitability of the project. The PV output for a two-axis tracking PV module is 2060 kWh/kWp. The implementation of an agrivoltaic system



will deteriorate the PV production. The use of models will calculate the energy losses due to the lighting share with the agricultural production.

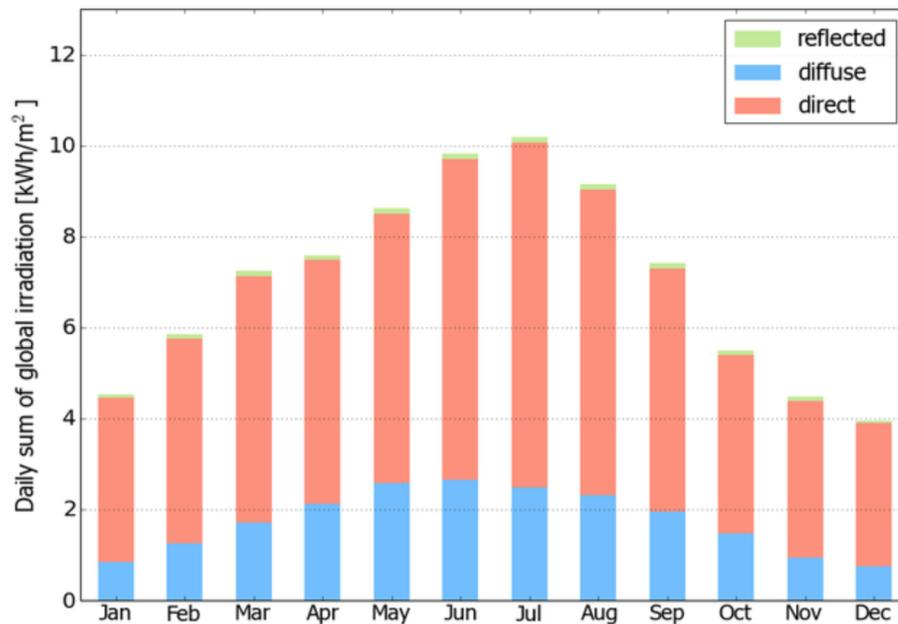

Figure 14: Daily sum of global irradiance per month in Saint-Tulle. Source: PV planner application, Solargis

The local urban plan is being reviewed by the elected representatives. To be eligible for the innovative call for tender, the land needs to be qualified as an agricultural land. Discussions are initiated and, a priori, there is no opposition to qualify this land as an agricultural land compatible with the installation of a photovoltaic plant. Their final decision has to be taken before the end of February. This project is applying for family 2 "Innovative photovoltaic installation on buildings, agricultural hangar and parking shelters or innovative agrivoltaic innovation with a power between 100 kWp and 3 MWp" and the implementation site belongs to case 4 "For agricultural hangars and agrivoltaic installation of family 2 only, the site location can be situated on an agricultural land" for the innovative call for tender (cf. paragraph 2.2).

Online inventories show there is no patrimonial stake. The map below summarizes all the environmental issues. The site belongs to a regional natural park. It is a biosphere reserve. The south of the area is classified as an important area for Bird conservation. The site is closed to a Natura 2000-ZPS zone. Natura 2000-ZPS (Special Protection Zone for wild birds) was created in order to conserve the biodiversity in the European Union. The installations in these zones are regulated. All these environmental constraints are not prohibitive for the construction of a photovoltaic plant but the ecological and the environmental impact studies have to take them into consideration. It will probably imply some extra costs to avoid, reduce and compensate the impact on the environment.

The closest station for electrical interconnection is 2.5 km away from the project zone. The total power of the project is 3 MWp or 2.4 MWe. There is no more capacity for renewables available



Figure 15: Environmental stakes of the project zone in Sainte-Tulle. The project zone is delineated in red.

in this station but there is a total free capacity of 24.2 MWe. As a conclusion, it is possible to connect to the network via this station but the project will not benefit from a preferential access as the capacity for renewable energy is full.



Figure 16: Electrical interconnection path between the project zone and the closest station. The project zone is delineated in red.

The project is close to the highway and it has to respect the Barnier law. This law forbids any construction in a 100 metre wide strip. A derogation must be granted based on the justification that the project does not induce supplementary impact on the highway and inversely.

The consultation of administration revealed some existing servitudes. The site is situated less than 3 km from an airport. As a consequence, it is submitted to a reverberation study. It is compulsory to ensure there is not any risk of glare for pilots. There is a gas pipe in the South of the project zone which will impact the design of the PV plant. Indeed, any construction is allowed in a three metre wide strip on the left and seven metre wide strip on the right centering on the pipe.



Figure 17: Passage of a gas pipe (in yellow) in the South of the project zone.

#### 5.4.3 Promises of lease and conditions

The pre-feasibility study shows some constraints but they are not prohibitive for the development of a photovoltaic plant. On the 27th of November, a meeting was organised between the farmer, the owner and EDF Renewables France. The aim was to discuss the conditions of the promise of lease. The owner (EDF) rents the land to EDF Renewables France and the farmer cultivates under the panel.

Usually for ground-based PV plants, the operator, EDF Renewables France in this case, pays a rent to the owner and the farmer in order to exploit the land instead. It is around 3,000€/ha. The emphyteusis triggers the break of the rural lease between the farmer and the owner. Indeed, it is not possible to have two leases on the same land. The farmer can not continue to cultivate because of the panels and has to find another land to pursue its activity. In the case of agrivoltaic systems, the farmer continues to exploit the land under the panel. EDF Renewables France will pay the owner, EDF, a rent but EDF Renewables France will not pay the farmer. This decision

relies on the fact that the farmer should benefit from the agrivoltaic system. Indeed, it is supposed to protect the crop from climate change, natural disaster and reduce the need of irrigation. The difficulty was to find a farmer who agrees to cultivate under the panel for free despite the constraints of the PV installation. The farmer does not pay a rent to the owner to cultivate the land in this case.

This meeting aims to learn about the cultivation practices of the farmer and how to adapt them in order to make them compatible with the PV plant. The farmer practices the ploughing. To plough and to sow, his agricultural machines are three metres large maximum. For the harvest, the harvester is nine metres large. For the spreading and pulverization of treatments, the machine is 15 metres large. Each machine is a huge investment for the farmer and the agrivoltaic system needs to be compatible with the use of them. To irrigate, he pumps the water from the canal nearby. He uses a diesel pump which consumes and pollutes a lot. The pressure of the water in the spray is six bar and it can reach 10 meters high. As a consequence, its irrigation system is not compatible with the PV plant and a new irrigation system needs to be studied. He grows only organic crops and he can only use copper or sulphur treatments. To limit the spread of fungal diseases, he has to implement crop rotation.

To ensure the success of the project, EDF Renewables submits some conditions to the farmer. First of all, he has to use only agricultural practices that can not jeopardize the project. A new irrigation process has to be decided. Then, the farmer must make a commitment to follow a certain crop rotation defined jointly with EDF Renewables France. Every crop should be modeled by the STICS model in order to have an algorithm for the panel control which respects the growth model of the plant. The possible crops mentioned are chickpea, corn, wheat, soya, bean, dry bean and barley. The farmer must commit himself to harvest under the panels in the best conditions and during all the period of the exploitation of the PV plant. A control zone needs to be created and cultivated in the same conditions as the crop under the panels. It will allow to have feedback on the impact of the agrivoltaic system on the agriculture.

#### **5.4.4 Obstacles**

The project was abandoned in January. Several problems arose during the development of the project. First of all, the crops desired by the farmer were not adapted to the agriPV (cereals, lentils, peas). Indeed, they cannot be modelled by the STICS model. There is no guarantee that the agrivoltaic system creates favourable conditions for growing these crops. Moreover, the risk of fungal diseases on these shaded crops is high, especially in organic agriculture. The farmer does not wish to adapt his farm to the agrivoltaic system. It is therefore difficult to envisage working with him. It is essential in this type of project to create a clear relationship with the farmer and to make sure you can count on him throughout the project. The farmer did not see the benefit of the system. The time limit to candidate to the CRE call for tenders is short. As a consequence, it was decided to give up this project and to focus on another project on viticulture in the South of France.

## 6 Results: Analysis of the technology

A SWOT analysis is performed to assess the strengths (S), weaknesses (W), opportunities (O) and threats (T) of the development of agrivoltaic systems for EDF Renewables France.

STRENGTHS	WEAKNESSES
S1. Maximize the land use S2. Adaptation of crops against climate change and natural disaster S3. Diversification of farmer's income	W1. Non mature technology W2. Less efficiency for crop yield and energy production W3. Technical constraints for farmers and for the exploitation of the PV farm
OPPORTUNITIES	THREATS
O1. A new market O2. Compatible with various crops O3. Increase the communication about renewables in rural world	T1. Lack of acceptability from farmers T2. Opposition from agriculture chambers T3. Technological breakthrough

### S1. Maximize the land use

Mixing solar panels and food crops on the same land maximizes the land use. To quantify the productivity of the land and to compare the agrivoltaic system with separating solar farm and agriculture, the Land Equivalent Ratio (LER) is adapted to this new concept. Usually, the LER is a criteria used in agriculture to evaluate different intercropping situations. For two mixed species, the LER equation is defined as follows :

$$LER = mixed\ yield1/pure\ yield1 + mixed\ yield2/pure\ yield2$$

The result measures the amount of land needed to grow both specie together compared with the amount of land needed for monoculture (Malérieux et al., 2008). A LER greater than 1.0 signals mixed systems are advantageous and a LER less than 1.0 indicates that intercropping triggers a reduction of yield and is a disadvantage.

The definition of LER can be adapted for agrivoltaic systems (Dupraz et al., 2011). It is defined as :

$$LER = crop\ yield\ in\ AV/monocrop\ yield + electricity\ yield\ in\ AV/PV\ yield$$

where AV stands for agrivoltaic and PV for standard PV farm. Dupraz et al. calculated the predicted LER for the experimentation in Montpellier thanks to models. For the FD agrivoltaic system, the LER is estimated at 1.7 and for the HD agrivoltaic system, the predicted LER is 1.3. A LER equals to 1.7 means that 100 ha of agrivoltaic farms would produce as much electricity and food as a 170 ha farm (Dupraz et al., 2011). The high level of LER obtained confirms the relevance of agrivoltaic systems to maximize the land use.

### S2. Adaptation of crops against climate change and natural disaster

As described before, panels above the agricultural land provide shade and a protection for the crops. Climate change triggers more frequent hail events, heatwaves and other natural hazards that can be a disaster for crops. The shade provided by the panel prevents the culture above to burn and it also reduces the water stress. The shade reduces the transpiration of plants and thus their water needs. Moreover, agrivoltaic systems do not trigger soil artificialisation which is currently a huge threat for agriculture.

### **S3. Diversification of the farmer's income**

The agricultural sector is going through an economic crisis. Farmers' incomes are low and state aid is becoming scarce. The loss of crop due to a bad weather is dramatic for farmers that can not make profit from their agricultural exploitation. A little financial compensation can be considered to compensate for constraints of the system or to report infrastructure malfunctions for example. The business plan of agrivoltaic system is not clearly defined yet. It may evolve according to the discussion with agricultural chambers. The business plan proposed by EDF Renewables is to rent the land at very low prices for installing panels above crops and protect them. It is supposed to be a win-win process with advantages in the crop management for farmers. This business plan will not participate to the increase of the market value of agricultural land.

#### **W1. Non mature technology**

Agrivoltaic systems are a non mature technology. The first prototype dates back from 2009 and there is no major project development in this sector. The cost of this kind of project is higher compared to basic solar project. It is also risky because there is a lack of knowledge on the real impact of the installation on the agriculture. Indeed, results concerning the dynamic agrivoltaic system implemented in 2014 are not published. It is still in the experimental stage. Moreover, experiments performed can not allow to conclude on the efficiency of the system for every type of crops. There is still a great deal of uncertainty about the impact of the agrivoltaic system on crops above.

#### **W2. Less efficiency for crop yield and energy production**

The agricultural and electrical production per hectare is reduced. That can be an obstacle for farmers and solar developers. The energy production does not overcome 80% and it represents a huge loss for the operator. Even if the LER is expected to be greater than 1, it is difficult to convince actors from the two sectors (agriculture and energy) to combine their activities.

#### **W3. Technical constraints for farmers and for the exploitation of the PV farm**

The structure supporting the panels is a constraint for the farmer. Once it is implemented, he can not change the dimension of his agricultural machines because the design of the PV plant is based on the dimensions of the machines used. Farming around metal poles is more difficult. The system of irrigation also needs to be adapted. The use of some chemical products has to be controlled to ensure they can not damage the metal structure or the panels. The elevation of panels is also a constraint for the operation and maintenance of the solar farm. Maintenance personnel must be authorised to work at heights. The exploitation of the agricultural and solar farm is much more complicated when an agrivoltaic system is implemented and it requires adaptation of cropping practices.

#### **O1. A new market**

The market is expanding and opportunities are various. Competition is weak. The first company to develop large-scale agrivoltaic project will become a reference in the field.

#### **O2. Compatible with various crops**

The impossibility of building a solar power plant on agricultural land is currently the main obstacle to the development of large-scale solar power plants. In France, 28 million ha of land are

dedicated to agriculture (French Ministry of Agriculture Food and Forestry, 2018). The possibility to implement PV plants on agricultural land is huge. Agrivoltaic experiments are currently conducted on different types of crops such as arboriculture or market gardening.

### **O3. Increase the communication about renewable energy in rural world**

Through his behavior, his consumer choices, his political vote, every citizen impacts the strategy of his country. To fight against climate change and to build a more sustainable society, the support of the population is needed. Raising public awareness of the need for the energy transition requires communication. They are a good example of dialogue on the integration of renewable energies into the modern lifestyles.

#### **T1. Lack of acceptability from farmers**

Agrivoltaic projects will only be a success if they get the support of farmers. To demonstrate the possible synergy between agriculture and photovoltaic energy, crops against the panels must be maintained. The know-how of the farmers is essential to the success of the project. But farmers can be reluctant to these kind of project. First of all, that implies some constraints for them. A social study was performed in 2018 questioning the acceptability of renewable energy projects in the rural world (Saubamea, 2018). Interviews of farmers highlight the main points of opposition. Farmers do not trust the technical aspects of the projects. The technology is not mature and there are no exploitable results to convince them of the feasibility of the projects. Another opposition comes from the gap between rural and urban worlds. Farmers do not feel concerned about renewable energy projects that are driven by the urban world and they feel that the projects are being imposed on them. Better communication and greater integration of farmers in the projects could reduce this threat.

#### **T2. Opposition from agriculture chambers**

The biggest threat is an opposition from chambers of agriculture. Discussions are under way between farmers' representatives and solar operators. The Board of Directors of the Young Farmers expressed an unfavourable opinion regarding the development of photovoltaic projects. According to them, the photovoltaic activity presents several risks of land drifts such as a price increase and a change in the destination of the land. The agricultural sector is currently facing a critical demographic situation: in less than ten years, half of all farmers will retire. The transfer of viable and liveable farms to young farmers is at the heart of their plans. According to them, the agrivoltaic systems pose a threat to the transfer of farms and are a brake on the establishment of young people. Moreover, they fear that if farmers are financially compensated for the installation of the PV power plant, they will abandon farming under the panels. It will therefore harm food production. The problem has already arisen with PV greenhouses. In March 2017, the CRE launched its first call for tender for PV greenhouses. PV greenhouses are transparent PV glass integrated within greenhouse roofs. Some projects were built and obtained a feed-in tariff but they did not couple the production of electricity with an agricultural activity. PV greenhouses were built only to get a tariff for the electricity and did not care about the crops inside the greenhouse.

#### **T3. Technological breakthrough**

Agrivoltaic projects are consistent with the current strategy of EDF Renewables France. In 2018, EDF announced a solar plan to build 30 GW of solar capacity between 2020 and 2035 in France.

The development of the technology could be a way to reach the target defined in the solar plan. However, it is not impossible to envisage a change of the strategy of the company due to a change of political orientation or a technological breakthrough. Floating panels can also be a solution to reach the objectives of the solar plan. Wind turbines are more and more powerful and they consume a very limited space. The development of offshore wind turbines is booming. Other sources of energy can be a threat for the development of agrivoltaic systems such as the progress on the discoveries of nuclear fusion.

## 7 Comparison with wind projects

During my internship at EDF Renewables France, I was also in charge of a wind project in France. It is located near Chartres. The context of development of wind energy is different from the solar energy in France. This part only deals with onshore wind farms.

### 7.1 Regulatory context in France

In 2010, Grenelle Laws 2 and its application decree of 2011 stated that wind turbines are considered as facilities classified for environmental protection. It implies obtaining a prefectural authorization before building the wind farm. This regulatory framework also provides for a minimum distance of 500 meters from the first home, in addition to limit values for noise exposure. The construction of a wind farm has to be compatible with the town planning laws. Regional wind energy planning schemes were also elaborated to identify favorable zones for the implementation of wind farms.

The process to obtain a prefectural authorization is divided into different steps:

- Preparation of a form including a study of the environmental impact of the project, a hazard assessment study (fire, overspeed, blade projection), a notice concerning hygiene and security and informations about technical and financial capacities of the operators
- Review of the form and consultation of the administrative authorities. Each authority has to emit an opinion, whether positive or negative.
- A one-month public inquiry. The commissioner in charge of the public inquiry gives an opinion on the project.
- The final decision of the prefect and the publication of the prefectural decree.

Globally, the steps are quite similar to solar projects but the studies to perform in order to obtain the prefectural authorization are much more burdensome. The ecological study lasts one year and exposes the initial situation of the project zone during an entire life cycle of the fauna and flora. The main stakes are linked to the impact of the wind turbines on birds and chiropterans.

During the development of the project and for a duration of at least one year, a mast measurement is implemented on the project zone. It is equipped with many captors that measure the



direction and the speed of the wind. That aims to calculate precisely the expected energy capacity production and to build a business plan. It is also used to install chiropterans captors to study the activity of bats.

The environmental impact study for a wind farm includes an acoustic analysis. Wind turbines generate sounds due to different phenomena such as the interaction of wind turbines blades with atmospheric turbulence, the rotor rotation, the interaction between the rotor wake and the support tower etc. The noise emergence of the wind farm must comply to the decree of the 26th of August 2011. The noise emergence is defined as the difference between the background sound and the background sound that includes the introduction of some specific sound. In the case of a wind farm, it is the difference between the background sound without the wind turbines and the background sound with the wind turbines. In France, the noise emergence of a wind farm should not overcome 5 dB during the day (7 a.m. to 10 p.m.) and 3 dB during the night (10 p.m. to 7 a.m.).

A landscape study also has to be performed in order to evaluate the landscape integration of the project. Photomontages are created from each monument and identified site in the study zone that can reach a diameter of 20 km around the project zone. Photomontages are also made from main roads in order to ensure a certain consistency of the territory.

The studies to develop wind farms in France are more robust than studies for solar projects. The duration of development of a wind energy project, that is to say the time between the beginning of the project and the construction of the wind farm, is around 6 years contrary to 3 years for a solar plant.

Another specificity of a wind farm project is the conditions of decommissioning. The lifetime of a wind turbine is estimated at 30-35 years. In France, there is no wind farm that reaches this seniority. But it is possible to consider a decommissioning before the end of the life of wind turbines. For example, some operations of re-powering are led to replace old turbines with more powerful ones. Companies are always responsible for turbine removal and it is clearly indicated in the legally-binding contract to lease land between local farmers, the owner and the operator. The goal is to restore the land as close as possible to the initial situation. The concrete used for the foundation of wind turbines needs to be remove partially. Then, 90% of the total mass of the wind turbine is recycled. In France, during the development of a wind farm project, the operator must invest 50,000 euros per wind turbine on a fund that will only be used for the dismantling of the wind turbine.

Public concern about the possible impacts of wind farms on the environment and human health often slows down the project. Many residents living near current wind farm sites complain about the potential role of infrasound and low frequencies emitted by wind turbines. The other main opposition deals with the impact of wind turbines on landscape. After the publication of the prefectural decree which authorizes the build of the wind farm, associations and people have four months to attack the state decision. Legal remedies take place in front of the administrative court and can take years. Increasing the acceptability of wind farm project is still a huge challenge.

## 7.2 The funding of wind farm projects in France

The context of electricity sale in France changed in 2017. The former system granted a fixed price for each MW of wind energy connected to the grid and funded by EDF OA (Obligation to purchase). EDF OA is a subsidiary company of EDF in charge of the purchase of renewable energy. It gave a fixed feed-in tariff to renewable installations. Now, the process to obtain a tariff depends on the project.

- Wind farms with less than six wind turbines and any with a power superior to 3 MW

They make an agreement of additional compensation with EDF. The feed-in tariff is fixed each year and only depends on the size of the rotor. It is around 72 and 74 €/MWh. It is guaranteed for 20 years. An additional compensation process is based on the fact that the CRE compensates the difference between the price on the spot market and the feed-in tariff obtained.

- Wind farms with more than seven wind turbines or with a wind turbine with a power superior to 3 MW

A call for tender is launched by the CRE every six months. The cumulative power for each phase is 500 MW for now. Each application form has to detail the offer and to provide the environmental authorization and some administrative piece. Then, each admissible candidate is assessed only on the basis of the tariff expected and detailed in the offer. Every winner of the tender benefits from a feed-in tariff guaranteed for 20 years. It is an additional compensation process. In 2018, the average feed-in tariff for onshore wind farms calls for tender was 65€/MWh. The CRE seems to strive towards a call for tender for this kind of wind farms too.

## 7.3 Wind turbine and agriculture

Contrary to solar farms, wind farms and agricultural land have always coexisted. To reduce the visual and the acoustical impacts of wind turbines, they are located the furthest away from the dwellings. Currently in France, the law requires that the minimum distance between a wind turbine and a house is 500 meters. The CRE is considering on a possible increase in the distance. As a consequence, wind turbines are always located in fields. The floor space needed for a wind turbine is around 3,000 m<sup>2</sup> regardless of the power of the wind turbine. The ground footprint of a wind turbine is very small compared to that of a solar farm. There is no competition of land use between agriculture and wind farm. The Departmental Commission for the Preservation of Natural, Agricultural and Forest Areas (CDPENAF) is responsible for preventing the excessive artificialisation of agricultural land. It seeks to preserve agricultural land. During project appraisal, it emits an opinion on the project. For large wind farms that consume more than 5 ha on the ground, collective compensation is expected. It is often of a financial nature and may also take the form of ecological compensation measures (planting hedges, restoring natural habitats in neighbouring areas, etc.).

The main link between wind turbines and agriculture is financial. Wind turbines represent a significant diversification of rents for farmers. In order of magnitude, for 2,000 m<sup>2</sup> an owner of agricultural land earns 30€, a farmer hopes to earn 400€ of sales. On the other hand, for 2,000m<sup>2</sup> EDF Renewables France offers rent of 10,000€ to split between the farmer and the owner.

In conclusion, the synergies between wind turbines and the agricultural world are weak. The two activities have always coexisted without causing many inconveniences to each other.

## 8 Discussion

It is not possible to conclude clearly on the effectiveness of agrivoltaic systems in developing strong synergies between agriculture and solar energy. Indeed, the models used show that for certain crops, the presence of solar panels allows to reduce irrigation and provides protection to crops against climate change. However, many crops have not been evaluated for agrivoltaic application. Literature focuses only on lettuces. Future work must extend the implementation of agrivoltaic systems to other plants.

From a technical point of view, this technology seems viable. Fixed system with vegetables under the panels has already been developed in USA or in Asia. Fixed agrivoltaic systems consist only of elevating the panels and spacing them. The difficulty for dynamic agrivoltaic system is the development of an algorithm that takes into consideration the needs of the plant.

Moreover, the results from the models will have to be compared with the results obtained on the Sun'agri prototypes and other demonstrators. To develop agrivoltaic projects, farmers must have confidence in the technical aspect of the project. Today it is difficult to assure farmers that the system will not lead to a drastic decrease in agricultural yields due to lack of experience.

It is difficult to quantify the costs and investments involved in agrivoltaic projects. The economic viability of projects is not assured. The common investment for a ground-based solar farm is one million euros per mega-watt (EDF figure). The estimation of the investment of an agrivoltaic system for EDF can not be released. However, literature is quite optimistic concerning the economic viability of agrivoltaic system. The economic value of an agrivoltaic systems deploying above grape farms in India is estimated more than 15 times higher than a conventional farming while maintaining the same grape production (Malu et al., 2017). Economic value measures the benefit provided by a good or a service to an economical agent. According to EDF, the economical viability can be reached only in regions with a high solar resource that is to say only in the South of France.

## 9 Conclusion

Agrivoltaic projects combine on the same land an agricultural and an electrical production. They have the potential to maximize the land use and reduce the competition between food and energy. The analysis of optimal parameters for PV plant design and crop management is essential to ensure the success of the first agrivoltaic projects. It is important to co-construct agrivoltaic

projects with farmers and chambers of agriculture so that a real synergy exists and so that solar panels do not harm agricultural production.

The regulatory framework with the establishment of a new family for agrivoltaic project for the CRE innovative call for tender is a huge incentive. Agrivoltaic projects represent a great potential to reach the 30 GW of solar capacity in 2035 fixed by EDF' solar plan.

Finally, there is a lack of large-scale project to confirm models and to know precisely the economic viability of the project.

## References

- Cantagallo, J.-E., Medan, D., and Hall, A.-J. (2004). Grain number in sunflower as affected by shading during floret growth, anthesis and grain setting. *Field Crops Research*, pages 191–202.
- Dinesh, H. and Pearce, J. M. (2016). The potential of agrivoltaic systems. *Sustainable Energy Review* 54, pages 299–308.
- Dupraz, C., Marrou, H., Talbot, G., Dufour, L., Nogier, A., and Ferard, Y. (2011). Combining solar photovoltaic panels and food crops for optimising land use: Towards new agrivoltaic schemes. *Renewable Energy*, vol. 36, pages 2725–2732.
- Edouard, S., Combes, D., Van Iseghem, M., Louarn, G., and Escobar-Gutiérrez, A. (2019). Analysis and modeling (stics/l-egume) of crop growth under shading conditions in agrivoltaic context. *Applied Energy* 206.
- French Ministry of Agriculture Food and Forestry (2018). *Annual Agricultural Statistic*.
- French Ministry of Ecological and Inclusive Transition (2019). Energy and climate project law: towards an increase of the development of renewable energy. Available at <https://www.ecologique-solidaire.gouv.fr/projet-loi-energie-climat-vers-acceleration-du-deploiement-des-energies-renouvelables>.
- Fu, J., Li, C.-H., Zhao, J.-R., Ma, L., and Liu, T. (2009). Shade-tolerance indices of maize: Selection and evaluation. *Chinese Journal of Applied Ecology*, vol.20, pages 2705–2709.
- Goetzberger, A. and Zastrow, A. (1982). On the coexistence of solar-energy conversion and plant cultivation. *International Journal of Solar Energy*, 1, pages 55–69.
- Malu, P., Sharma, U., and Pearce, M. (2017). Agrivoltaic potential on grape farms in india. *Sustainable Energy Technologies and Assessments*, v23, pages 104–110.
- Malérieux, E., Crozat, Y., Dupraz, C., Laurans, M., Makowski, D., Ozier-Lafontaine, H., Rapidel, B., de Tournonnet, S., and Valantin-Morison, M. (2008). Mixing plant species in cropping systems: concepts, tools and models. *Agronomy for Sustainable Development*, pages 43–62.
- Marrou, H., Guillioni, L., Dufour, L., Dupraz, C., and Wery, J. (2013a). Microclimate under agrivoltaic systems: is crop growth rate affected in the partial shade of solar panels? *Agricultural and Forest Meteorology*, vol. 177, pages 117–132.
- Marrou, H., Wery, J., Dufour, L., and Dupraz, C. (2013b). Productivity and radiation use efficiency of lettuces grown in the partial shade of photovoltaic panels. *European Journal of Agronomy* 44, pages 54–66.
- Popp, J., Lakner, Z., Harangi-Rákos, M., and Fáric, M. (2014). The effect of bioenergy expansion: Food, energy, and environment. *Renewable and Sustainable Energy Reviews*, v32, pages 559–578.
- Regional direction of Food, Agriculture and Forestry in New-Aquitaine (2019). *Tree and fruit industry*.
- Saubamea, G. (2018). Renewable energies and the agricultural world. *Master thesis in partnership with EDF Renewables France*.

Sun'R (2017). Sun'agri, press release.

Valle, B., Simonneau, T., Sourd, F., Pechier, P., Hamard, P., Frisson, T., Ryckewaert, M., and Christophe, A. (2017). Increasing the total productivity of a land by combining mobile photovoltaic panels and food crops. *Applied Energy* 206, pages 1495–1507.

Department of Forestry, Fisheries and the Environment

Department of Forestry, Fisheries and the Environment

Directorate: Biodiversity Conservation



## Tumelo Mathulwe

---

**From:** Mulalo Sundani <msundani@dffe.gov.za>  
**Sent:** Wednesday, 3 November, 2021 19:19  
**To:** Savannah Public Process  
**Subject:** RE: 3107 - Barleria PV - Savannah Environmental - Public Participation Registration

Thank you very much

Mulalo

-----Original Message-----

From: publicprocess@savannahsa.com [mailto:publicprocess@savannahsa.com]  
Sent: Wednesday, 03 November 2021 18:38  
To: Mulalo Sundani <msundani@dffe.gov.za>  
Subject: 3107 - Barleria PV - Savannah Environmental - Public Participation Registration

Hi Mulalo Sundani

Thank you for your registration.

Use the following code to access the documentation for Barleria PV:

f9e977HQ

Regards  
Savannah Environmental

## Tumelo Mathulwe

---

**From:** Savannah Public Process  
**Sent:** Thursday, 4 November, 2021 9:17  
**To:** Mulalo Sundani  
**Cc:** Nicolene Venter  
**Subject:** SE3107 - HOUTHAALBOOMEN SOLAR PVs

Good Day Mulalo

As requested in yesterdays meeting please see the link and release code for the abovementioned project below:

**Link:** <https://savannahsa.com/public-documents/energy-generation/houthaalbomen-pv-cluster/>

**Release Code:** f9e977HQ

Kind Regards



t: +27 (0)11 656 3237  
f: +27 (0) 86 684 0547

**Tumelo Mathulwe**  
Public Participation Consultant

e: [Publicprocess@savannahsa.com](mailto:Publicprocess@savannahsa.com)  
c: +27 (0)60 978 8396

SAWEA Award for Leading Environmental Consultant on Wind Projects in 2013 & 2015

### Processing of personal information / POPIA compliance

We respect your privacy and acknowledge that this e-mail will contain Personal Information, which may belong to you, others and/or to your organization and which we will process. The processing of your personal information by Savannah Environmental may be included in reports submitted to governmental departments or on our public platforms, which processing will be done in accordance with our processing notice housed on our website - <https://savannahsa.com/privacy-policy-privacy-policy-page/>. By sending and/or receiving this message, you hereby expressly give us consent to process the Personal Information contained herein which processing will be done in accordance with POPIA Act 4 of 2013.

This email has been scanned for viruses and malware, and automatically archived by **Mimecast SA (Pty) Ltd**, and is believed to be clean.

## Nicolene Venter

---

**From:** MMatlala Rabothata <MRABOTHATA@dffe.gov.za>  
**Sent:** Thursday, 18 November 2021 01:46  
**To:** Nicolene Venter  
**Cc:** Savannah Public Process  
**Subject:** RE: 14/12/16/3/3/2/2106 & 14/12/16/3/3/2/2107 & 14/12/16/3/3/2/2108: Request for written comments

Thank you so much. I managed to access the reports.

---

**From:** Nicolene Venter [mailto:[nicolene@savannahsa.com](mailto:nicolene@savannahsa.com)]  
**Sent:** Thursday, 18 November 2021 01:43  
**To:** MMatlala Rabothata <MRABOTHATA@dffe.gov.za>  
**Cc:** Savannah Public Process <[publicprocess@savannahsa.com](mailto:publicprocess@savannahsa.com)>  
**Subject:** RE: 14/12/16/3/3/2/2106 & 14/12/16/3/3/2/2107 & 14/12/16/3/3/2/2108: Request for written comments

Dear Mmatlala,

No problem, herewith the release code to the Reports f9e977HQ

Please do not hesitate to contact me should you require any additional assistance.

Kind regards,



t: +27 (0)11 656 3237  
f: +27 (0) 86 684 0547

**Nicolene Venter**  
Public Participation and Social  
Consultant

e: [nicolene@savannahsa.com](mailto:nicolene@savannahsa.com)  
c: +27 (0)60 978 8396

SAWEA Award for Leading Environmental Consultant on Wind Projects in 2013 & 2015

### Processing of personal information / POPIA compliance

We respect your privacy and acknowledge that this e-mail will contain Personal Information, which may belong to you, others and/or to your organization and which we will process. The processing of your personal information by Savannah Environmental may be included in reports submitted to governmental departments or on our public platforms, which processing will be done in accordance with our processing notice housed on our website - <https://savannahsa.com/privacy-policy-privacy-policy-page/>. By sending and/or receiving this message, you hereby expressly give us consent to process the Personal Information contained herein which processing will be done in accordance with POPIA Act 4 of 2013.

This email has been scanned for viruses and malware, and automatically archived by **Mimecast SA (Pty) Ltd**, and is believed to be clean.

---

**From:** MMatlala Rabothata <[MRABOTHATA@dffe.gov.za](mailto:MRABOTHATA@dffe.gov.za)>  
**Sent:** Thursday, 18 November 2021 01:28  
**To:** Savannah Public Process <[publicprocess@savannahsa.com](mailto:publicprocess@savannahsa.com)>  
**Cc:** Nicolene Venter <[nicolene@savannahsa.com](mailto:nicolene@savannahsa.com)>  
**Subject:** RE: 14/12/16/3/3/2/2106 & 14/12/16/3/3/2/2107 & 14/12/16/3/3/2/2108: Request for written comments

Dear Nicolene,

I am not able to access your reports. Kindly send me the release code.

Regards

---

**From:** Savannah Public Process [<mailto:publicprocess@savannahsa.com>]

**Sent:** Wednesday, 17 November 2021 14:13

**To:** MMatlala Rabothata <[MRABOTHATA@dffe.gov.za](mailto:MRABOTHATA@dffe.gov.za)>

**Subject:** 14/12/16/3/3/2/2106 & 14/12/16/3/3/2/2107 & 14/12/16/3/3/2/2108: Request for written comments

**Importance:** High

Dear Ms Rabothata,

I am following-up on your directorate's written comments on the above-mentioned three applications which are:

- Setaria PV: 14/12/16/3/3/2/2106
- Barleira PV: 14/12/16/3/3/2/2107
- Dicoma PV: 14/12/16/3/3/2/2108

Would you please be so kind and re-send your written comments as the review period ended on Monday, 15 November 2021 and the EAP had scheduled the submission of the final Scoping Reports to the DFFE for Tuesday, 23 November 2021.

Kind regards,



t: +27 (0)11 656 3237  
f: +27 (0) 86 684 0547

**Nicolene Venter**

Public Participation and Social  
Consultant

e: [publicprocess@savannahsa.com](mailto:publicprocess@savannahsa.com)  
c: +27 (0)60 978 8396

SAWEA Award for Leading Environmental Consultant on Wind Projects in 2013 & 2015

**Processing of personal information / POPIA compliance**

We respect your privacy and acknowledge that this e-mail will contain Personal Information, which may belong to you, others and/or to your organization and which we will process. The processing of your personal information by Savannah Environmental may be included in reports submitted to governmental departments or on our public platforms, which processing will be done in accordance with our processing notice housed on our website - <https://savannahsa.com/privacy-policy-privacy-policy-page/>. By sending and/or receiving this message, you hereby expressly give us consent to process the Personal Information contained herein which processing will be done in accordance with POPIA Act 4 of 2013.

This email has been scanned for viruses and malware, and automatically archived by **Mimecast SA (Pty) Ltd**, and is believed to be clean.

---

**From:** Tsholofelo Shalot Sekonko <[tsekonko@environment.gov.za](mailto:tsekonko@environment.gov.za)>

**Sent:** Friday, 22 October 2021 13:21

**To:** Savannah Public Process <[publicprocess@savannahsa.com](mailto:publicprocess@savannahsa.com)>

**Cc:** MMatlala Rabothata <[MRabothata@environment.gov.za](mailto:MRabothata@environment.gov.za)>

**Subject:** HOUTHAAALBOOMEN PV CLUSTER – Notification of EIA Process and availability of Scoping Reports for review and comment

Dear Ms. Venter

DFFE Directorate: Biodiversity Conservation hereby acknowledge receipt of the invitation to review and comment on the development of three (3) separate solar photovoltaic (PV) facilities and associated infrastructure on sites located

approximately 5km north -west of the town of Lichtenburg within the Ditsobotla Local Municipality, Ngaka Modiri Molema District Municipality, North West Province. Kindly note that the project has been allocated to Ms Rabothata (both copied on this email) and myself.

Please note: All Public Participation Process documents related to Biodiversity EIA review and any other Biodiversity EIA queries will be submitted to the Directorate: Biodiversity Conservation at Email: [BCAdmin@environment.gov.za](mailto:BCAdmin@environment.gov.za) for attention of Mr Seoka Lekota.

*Regards ,  
Ms Tsholofelo Sekonko  
Intern: Biodiversity Mainstreaming EIA  
Department of Forestry, Fisheries and the Environment  
473 Steve Biko Rd  
Arcadia  
Pretoria  
0083  
Email: [tsekonko@environment.gov.za](mailto:tsekonko@environment.gov.za)*

'Please consider the environment before you print this email' The processing of personal information by the Department of Forestry, Fisheries and the Environment is done lawfully and not excessive to the purpose of processing in compliance with the POPI Act, any codes of conduct issued by the Information Regulator in terms of the POPI Act and / or relevant legislation providing appropriate security safeguards for the processing of personal information of others.

## **Disclaimer**

This message and any attachments transmitted with it are intended solely for the addressee(s) and may be legally privileged and/or confidential. If you have received this message in error please destroy it and notify the sender. Any unauthorized usage, disclosure, alteration or dissemination is prohibited. The Department of Forestry, Fisheries and the Environment no responsibility for any loss whether it be direct, indirect or consequential, arising from information made available and actions resulting there from. The views and opinions expressed in this e-mail message may not necessarily be those of Management. The processing of personal information by the Department of Forestry, Fisheries and the Environment is done lawfully and not excessive to the purpose of processing in compliance with the POPI Act, any codes of conduct issued by the Information Regulator in terms of the POPI Act and / or relevant legislation providing appropriate security safeguards for the processing of personal information of others.

## Tumelo Mathulwe

---

**From:** Mulalo Sundani <msundani@dffe.gov.za>  
**Sent:** Wednesday, 10 November, 2021 13:07  
**To:** Tumelo Mathulwe  
**Cc:** Nicolene Venter  
**Subject:** RE: SE3107 - HOUTHAAALBOOMEN SOLAR PVs

Good afternoon

I tried but the problem is my internet connection , I will try tomorrow at work or I will go to Environmental House and download the document.

But we will forward the comments shortly.

Mulalo

---

**From:** Tumelo Mathulwe [mailto:tumelo@savannahsa.com]  
**Sent:** Wednesday, 10 November 2021 09:46  
**To:** Mulalo Sundani <msundani@dffe.gov.za>  
**Cc:** Nicolene Venter <nicolene@savannahsa.com>  
**Subject:** RE: SE3107 - HOUTHAAALBOOMEN SOLAR PVs

Good Day Mulalo

I am following up on the below, if you were able to access the report documentation.

Kind Regards

savannah  
environmental

t: +27 (0)11 656 3237  
f: +27 (0) 86 684 0547

**Tumelo Mathulwe**  
Public Participation Consultant

e: [Tumelo@savannahsa.com](mailto:Tumelo@savannahsa.com)  
c: +27 (0)60 978 8396

SAWEA Award for Leading Environmental Consultant on Wind Projects in 2013 & 2015

### Processing of personal Information / POPIA compliance

We respect your privacy and acknowledge that this e-mail will contain Personal Information, which may belong to you, others and/or to your organization and which we will process. The processing of your personal information by Savannah Environmental may be included in reports submitted to governmental departments or on our public platforms, which processing will be done in accordance with our processing notice housed on our website - <https://savannahsa.com/privacy-policy-privacy-policy-page/>. By sending and/or receiving this message, you hereby expressly give us consent to process the Personal Information contained herein which processing will be done in accordance with POPIA Act 4 of 2013.

This email has been scanned for viruses and malware, and automatically archived by **Mimecast SA (Pty) Ltd**, and is believed to be clean.

---

**From:** Savannah Public Process  
**Sent:** Thursday, 4 November, 2021 9:17  
**To:** Mulalo Sundani <[msundani@environment.gov.za](mailto:msundani@environment.gov.za)>

**Cc:** Nicolene Venter <[nicolene@savannahsa.com](mailto:nicolene@savannahsa.com)>

**Subject:** SE3107 - HOUTHAAALBOOMEN SOLAR PVs

Good Day Mulalo

As requested in yesterdays meeting please see the link and release code for the abovementioned project below:

**Link:** <https://savannahsa.com/public-documents/energy-generation/houthaalbomen-pv-cluster/>

**Release Code:** f9e977HQ

Kind Regards

savannah  
environmental

t: +27 (0)11 656 3237  
f: +27 (0) 86 684 0547

**Tumelo Mathulwe**  
Public Participation Consultant

e: [Publicprocess@savannahsa.com](mailto:Publicprocess@savannahsa.com)  
c: +27 (0)60 978 8396

SAWEA Award for Leading Environmental Consultant on Wind Projects in 2013 & 2015

**Processing of personal Information / POPIA compliance**

We respect your privacy and acknowledge that this e-mail will contain Personal Information, which may belong to you, others and/or to your organization and which we will process. The processing of your personal information by Savannah Environmental may be included in reports submitted to governmental departments or on our public platforms, which processing will be done in accordance with our processing notice housed on our website - <https://savannahsa.com/privacy-policy-privacy-policy-page/>. By sending and/or receiving this message, you hereby expressly give us consent to process the Personal Information contained herein which processing will be done in accordance with POPIA Act 4 of 2013.

This email has been scanned for viruses and malware, and automatically archived by **Mimecast SA (Pty) Ltd**, and is believed to be clean.