

NOTIFICATION OF BASIC ASSESSMENT PROCESS
AND PUBLIC PARTICIPATION PROCESS

17 August 2018

Dear Stakeholder

**BASIC ASSESSMENT AND
PUBLIC PARTICIPATION PROCESS**

ZONNEQUA WIND FARM, NORTHERN CAPE

NOTICE OF ENVIRONMENTAL IMPACT ASSESSMENT PROCESS

A wind farm is proposed to be developed within the Springbok Renewable Energy Development Zone (REDZ), approximately 19 km south-east of the town of Kleinsee in the Northern Cape. The wind farm is known as the **Zonnequa Wind Farm** and is located within the Nama Khoi Local Municipality and the Namakwa District Municipality. A suitable project site for the development of the wind farm has been identified by the project development company. The details of the project are as follows:

Project Name	Zonnequa Wind Farm
Applicant	Genesis Zonnequa Wind (Pty) Ltd
Area of project site	~4434ha
Affected properties	» Portion 1 of the Farm Zonnekwa 328 » Remaining Extent of the Farm Zonnekwa 326
Contracted Capacity of wind farm	up to 140MW
No of turbines	up to 56
Turbine hub height	up to 130m
Turbine tip height	up to 205m
Grid connection	At the existing Gromis Substation, approx. 19km north of the site
On-site substation size	150m x 150m

Power line	Overhead 132kV power line (assessed as a 300m power line corridor), with a servitude of 32m
Affected properties - 132kV grid connection	<ul style="list-style-type: none"> » Remaining extent of the Farm Zonnekwa 326 » Remaining extent of the Farm Honde Vlei 325 » Remaining extent of the Farm Kannabieduin 324 » Remaining extent of the Farm Sand Kop 322 » Remaining extent of the Farm Mannels Vley 321 » Remaining extent of the Farm Dikgat 195 » Portion 15 of the Farm Dikgat 195
Access roads (internal and main)	~8m in width

Other associated infrastructure will be required for the wind farm, including:

- » Concrete turbine foundations and hardstand areas;
- » Temporary laydown areas which will accommodate storage and assembly areas;
- » Cabling between the turbines, to be laid underground where practical;
- » A temporary concrete batching plant; and
- » Operation and Maintenance buildings including a gate house, security building, control centre, offices, warehouses, a workshop and visitors centre.

It is the developer's intention to bid the Zonnequa Wind Farm project under the Department of Energy's (DoE) Renewable Energy Independent Power Producer Procurement (REIPPP) Programme. The power generated from the project will be sold to Eskom and will feed into the national electricity grid. The development of the project will also assist with achieving the electricity generation goals as set out in the Integrated Resources Plan.

Another wind farm is proposed to be developed directly south of the Zonnequa Wind Farm, known as the Namas Wind Farm. This wind farm will be assessed as part of a separate Environmental Impact Assessment (EIA) process.

BASIC ASSESSMENT PROCESS

As per the EIA Regulations published in terms of Section 24(5) of the National Environmental Management Act (NEMA, Act No 107 of 1998), the applicant will require authorisation from the National Department of Environmental Affairs (DEA) (in consultation with Northern Cape Department of Environment and Nature Conservation (DENC)) for the undertaking of the project. Due to the location of the project site within the REDZ, a Basic Assessment (BA) process is required to be undertaken for the Zonnequa Wind Farm in accordance with GN114, as formally gazetted on 16 February 2018. The application is required to be supported by comprehensive, independent environmental studies undertaken in accordance with the EIA Regulations, 2014, as amended.

Genesis Zonnequa Wind (Pty) Ltd has appointed Savannah Environmental, as the independent environmental consultant, to undertake separate a Basic Assessment for the project to identify and assess all potential environmental impacts associated with the wind farm, and recommend appropriate mitigation measures in an Environmental Management Programme (EMPr). As part of

the environmental studies, I&APs will be actively involved through the public involvement process being undertaken by Savannah Environmental.

The department and/or the organisation which you represent has been identified as a commenting authority for the proposed wind farm. In this regard, please can you provide us with the name and contact details of the relevant contact person at your department who we would liaise with regarding this project. By registering on the project database, you will receive all information relating to the project and will be provided with an opportunity to provide comment and input into the BA process.

A background information document, which provides further information on the BA process as well as the nature and extent of the proposed wind farm, is attached to this letter and is also available for download on the Savannah Environmental Website (www.savannahsa.com).

Please do not hesitate to contact us should you require additional information and/or clarification regarding the project. Our team welcomes your participation and look forward to your involvement throughout this process.

Kind regards

Rozanne Els
Public Participation Co-ordinator
Email: publicprocess@savannahsa.com
Savannah Environmental

Namas & Zonnequa Wind Farms- Notification of Basic Assessment Process

Search

Forward

Assigned to:	Savannah Public Process	Date Sent:	17/08/2018 15:40
Teams:	Global	Project:	Namas & Zonnequa Wind Farm
From:	Savannah Public Process <publicprocess@savannahsa.com>		
To:			
Cc:	gabriele@savannahsa.com, nicolene@savannahsa.com		
Bcc:	Bryan Fisher <bfisher@ncpg.gov.za>, Peter Cloete <peter.denc87@gmail.com>, Wilma Lutsch <wlutsch@environment.gov.za>, Pheladi Masipa <pheladi.masipa@energy.gov.za>, Mashudu Marubini <mashuduma@daff.gov.za>, Thoko Buthelezi <thokob@daff.gov.za>, Jacoline Mans <jacolinema@daff.gov.za>, Jasper Nieuwoudt <jasper.nieuwoudt@dmr.gov.za>, Jaco Roelofse <roelofse.j@vodamail.co.za>, Tabbie Roberts <tabbie@vodamail.com>, Nicole Abrahams <abrahamsn@nra.co.za>, Andrea van Gensen <vgenseal@eskom.co.za>, John Geeringh <john.geeringh@eskom.co.za>, Tamai Hore <tamai.hore@nersa.org.za>, Lizell Stroh <strohl@caa.co.za>, Natasha Higgitt <nhiggitt@sahra.org.za>, Ratha Andrew Timothy <ratha.timothy@gmail.com>, Chris Fortuin <chrisf@namakwa-dm.gov.za>, Bulelani Right <bulelanir@namakwa-dm.gov.za>, Samantha Titus <municipal.manager@namakhoi.gov.za>, Steven Shibambu <shibambus@dwa.gov.za>, Adrian Tiplady <atiplady@ska.ac.za>, Leonard Shaw <shawls@telkom.co.za>, Lt. Cnl. Kebasenoszi Zondi <kebasenoszi@yahoo.com>, Michael Knight <mike.knight@sanparks.org>, Werner Kleynhans <kleynhansw@caa.co.za>, Thebe Thebe <tthebe@ncpg.gov.za>, Elizabeth Botes <twessels@ncpg.gov.za>, Abe Abrahams <franksl@dwa.gov.za>, Nomfundo Ntloko-Gobodo <nomfundo.ntloko-gobodo@drdlr.gov.za>, Mangalane Du Toit <mangalane.dutoit@drdlr.gov.za>, Russel Hartley <russel.hartley@namakhoi.gov.za>, Jacques Cloete <jacques.cloete@namakhoi.gov.za>		
Subject:	Namas & Zonnequa Wind Farms- Notification of Basic Assessment Process		
Body:	<p>Dear Stakeholder,</p> <p>Two 140MW wind farms are proposed to be developed on adjacent sites within the Springbok REDZ, approximately 20km south of the town of Kleinsee in the Northern Cape. The wind farm are known as the Namas wind Farm and the Zonnequa Wind Farm and are within the Nama Khoi Local Municipality and the Namakwa District Municipality. A suitable project site for the development of each of the wind farms has been identified by the project development companies.</p> <p>Savannah Environmental has been appointed to undertake the Basic Assessment Process for the Namas and Zonnequa Wind Farms.</p> <p>Please refer to the attached Notification letter and Background Information document for further information regarding the project.</p> <p>Please do not hesitate to contact us if you have any quires in this regards.</p> <p>Kind regards</p>		

Tel: +27 (0)11 656 3237 | Fax: +27 (0)86 684 0547

Search

SAWEA Award for Leading Environmental Consultant for Wind Projects in 2013 & 2015

Show Plain Text

Attachments: [11833 Savannah_web_afr.pdf](#)
[11833 Savannah_web_eng.pdf](#)
[Namas WF Notification Letter - OoS.pdf](#)
[Reply Form.pdf](#)
[Zonnequa WF Notification Letter - OoS.pdf](#)

▼ Activities

▲ Attachments

		(1 - 5 of 5)		
Subject	Contact	Last Modified		
11833 Savannah_web_afr.pdf		17/08/2018 15:40	edit	<input type="checkbox"/>
11833 Savannah_web_eng.pdf		17/08/2018 15:40	edit	<input type="checkbox"/>
Namas WF Notification Letter - OoS.pdf		17/08/2018 15:40	edit	<input type="checkbox"/>
Reply Form.pdf		17/08/2018 15:40	edit	<input type="checkbox"/>
Zonnequa WF Notification Letter - OoS.pdf		17/08/2018 15:40	edit	<input type="checkbox"/>

▼ Accounts

▼ Contacts

▼ Email Stakeholders

▼ Users

▲ Projects

Name	Assigned To	Start Date:	End Date:		
Namas & Zonnequa Wind Farm	Gabriele Stein	01/05/2018	01/11/2018	edit	<input type="checkbox"/>

Print ↑ Back to top

Namas & Zonnequa Wind Farms- Notification of Basic Assessment Process

Search





Forward

Assigned to: Savannah Public Process	Date Sent: 02/10/2018 10:37
Teams: Global	Project: Namas & Zonnequa Wind Farm
From: Savannah Public Process <publicprocess@savannahsa.com>	
To: Lani Adonus <lanieadonus9@gmail.com>	
Cc:	
Bcc:	
Subject: Namas & Zonnequa Wind Farms- Notification of Basic Assessment Process	
<p>Body: Dear Stakeholder,</p> <p>Two 140MW wind farms are proposed to be developed on adjacent sites within the Springbok REDZ, approximately 20km south of the town of Kleinsee in the Northern Cape. The wind farm are known as the Namas wind Farm and the Zonnequa Wind Farm and are within the Nama Khoi Local Municipality and the Namakwa District Municipality. A suitable project site for the development of each of the wind farms has been identified by the project development companies.</p> <p>Savannah Environmental has been appointed to undertake the Basic Assessment Process for the Namas and Zonnequa Wind Farms.</p> <p>Please refer to the attached Notification letter and Background Information document for further information regarding the project.</p> <p>Please do not hesitate to contact us if you have any quires in this regards.</p> <p>Kind regards,</p> <p>Rozanne Els</p> <p>Public Participation Co-ordinator Savannah Environmental (Pty) Ltd Tel: +27 (0)11 656 3237 Fax: +27 (0)86 684 0547</p> <p><i>SAWEA Award for Leading Environmental Consultant for Wind Projects in 2013 & 2015</i></p> <p><input type="checkbox"/> Show Plain Text</p>	
Attachments: 11833 Savannah web afr.pdf 11833 Savannah web eng.pdf	

▼ Activities

Search

▲ Attachments

		(1 - 5 of 5)	
Subject	Contact	Last Modified	
 11833 Savannah_web_afr.pdf		02/10/2018 10:37	edit
 11833 Savannah_web_eng.pdf		02/10/2018 10:37	edit
 Namas WF Notification Letter - OoS.pdf		02/10/2018 10:37	edit
 Reply Form.pdf		02/10/2018 10:37	edit
 Zonnequa WF Notification Letter - OoS.pdf		02/10/2018 10:37	edit

▼ Accounts

▼ Contacts

▼ Email Stakeholders

▼ Users

▲ Projects

		(1 - 1 of 1)	
Name	Assigned To	Start Date:	End Date:
Namas & Zonnequa Wind Farm	Gabriele Stein	01/05/2018	01/11/2018

Print ↑ Back to top

Namas & Zonnequa Wind Farms- Notification of Basic Assessment Process

Search

Forward

Assigned to:	Savannah Public Process	Date Sent:	02/10/2018 10:00
Teams:	Global	Project:	Namas & Zonnequa Wind Farm
From:	Savannah Public Process <publicprocess@savannahsa.com>		
To:			
Cc:			
Bcc:	Palo van Reenen <paulus.vanreenen@namakhoi.gov.za>		
Subject:	Namas & Zonnequa Wind Farms- Notification of Basic Assessment Process		
Body:	<p>Dear Stakeholder,</p> <p>Two 140MW wind farms are proposed to be developed on adjacent sites within the Springbok REDZ, approximately 20km south of the town of Kleinsee in the Northern Cape. The wind farm are known as the Namas wind Farm and the Zonnequa Wind Farm and are within the Nama Khoi Local Municipality and the Namakwa District Municipality. A suitable project site for the development of each of the wind farms has been identified by the project development companies.</p> <p>Savannah Environmental has been appointed to undertake the Basic Assessment Process for the Namas and Zonnequa Wind Farms.</p> <p>Please refer to the attached Notification letter and Background Information document for further information regarding the project.</p> <p>Please do not hesitate to contact us if you have any quires in this regards.</p> <p>Kind regards,</p> <p>Rozanne Els</p> <p>Public Participation Co-ordinator Savannah Environmental (Pty) Ltd Tel: +27 (0)11 656 3237 Fax: +27 (0)86 684 0547</p> <p><i>SAWEA Award for Leading Environmental Consultant for Wind Projects in 2013 & 2015</i></p> <p><input type="checkbox"/> Show Plain Text</p>		
Attachments:	11833 Savannah web afr.pdf 11833 Savannah web eng.pdf		

▼ Activities

Search

▲ Attachments

(1 - 5 of 5)			
Subject	Contact	Last Modified	
11833 Savannah_web_afr.pdf		02/10/2018 10:00	edit
11833 Savannah_web_eng.pdf		02/10/2018 10:00	edit
Namas WF Notification Letter - OoS.pdf		02/10/2018 10:00	edit
Reply Form.pdf		02/10/2018 10:00	edit
Zonnequa WF Notification Letter - OoS.pdf		02/10/2018 10:00	edit

▼ Accounts

▼ Contacts

▼ Email Stakeholders

▼ Users

▲ Projects

(1 - 1 of 1)				
Name	Assigned To	Start Date:	End Date:	
Namas & Zonnequa Wind Farm	Gabriele Stein	01/05/2018	01/11/2018	edit

Print Back to top

Rozanne Els

From: Nicolene Venter <nicolene@savannahsa.com>
Sent: 02 October 2018 2:06 PM
To: townplanner@kharahais.gov.za
Cc: rozanne@savannahsa.com
Subject: Allepad PV Projects - Notice of Environmental Impact Assessment Process & Request for Confirmation of Properties owned by Dawid Kruper Local Municipality
Attachments: Allepad PV EIAs_Notification Letter_Organs of State.pdf; Allepad PV Projects_BID_Afrikaans.pdf; Allepad PV Projects_BID_English.pdf; Reply Form.pdf; Allepad PV_Landowners Map_28.jpg
Importance: High

Mr J du Plessis
Manager: Land-Use Management
Dawid Kruiper Local Municipality
UPINGTON

Dear Mr Du Plessis,

The development of four 100MW Photovoltaic (PV) facilities and associated infrastructure is proposed on the Remaining Extent of Erf 5315 Upingont, located approximately 11km north-west of Upington, in the Dawid Kruiper Local Municipality, of the ZF Mgcawu District, in the Northern Cape Province. The projects are to be known as Allepad PV One, Allepad PV Two, Allepad PV Three, and Allepad PV Four. Each of the four Allepad PV projects entails the development of a PV facility and supporting infrastructure.

Please refer to the attached Notification Letter and background Information Document for further information.

Additional to the projects' information, we request your Department's written confirmation of any of the adjacent properties which are owned by Dawid Kruiper Local Municipality.

We are looking forward to hear from you.

Kind regards,



Virus-free. www.avast.com

savannah
environmental

t: +27 (0)11 656 3237
f: +27 (0) 86 684 0547

Nicolene Venter

Public Participation and Social
Consultant

e: nicolene@savannahsa.com
c: +27 (0) 83 377 9112

Namas & Zonnequa Wind Farms- Notification of Basic Assessment Process

Search

Forward

Assigned to: Savannah Public Process	Date Sent: 04/10/2018 11:30
Teams: Global	Project: Namas & Zonnequa Wind Farm
From: Savannah Public Process <publicprocess@savannahsa.com>	
To: Paulus van Reenen <paulus.vanreenen@namakhoi.gov.za>	
Cc: nicolene@savannahsa.com	
Bcc:	
Subject: Namas & Zonnequa Wind Farms- Notification of Basic Assessment Process	
<p>Body: Dear Cllr van Reenen,</p> <p>As discussed with Nicolene, please find herewith the Background Information Document and Notification Letter for the above-mentioned proposed projects.</p> <p>Kind regards,</p> <p>Rozanne Els</p> <p>Public Participation Co-ordinator Savannah Environmental (Pty) Ltd Tel: +27 (0)11 656 3237 Fax: +27 (0)86 684 0547</p> <p><i>SAWEA Award for Leading Environmental Consultant for Wind Projects in 2013 & 2015</i></p> <hr/> <p>> From: Savannah Public Process > Date Sent: 02/10/2018 10:37 > To: Lani Adonus > Cc: > Subject: FW: Namas & Zonnequa Wind Farms- Notification of Basic Assessment Process ></p> <p>Dear Stakeholder,</p> <p>Two 140MW wind farms are proposed to be developed on adjacent sites within the Springbok REDZ, approximately 20km south of the town of Kleinsee in the Northern Cape. The wind farm</p>	

Savannah Environmental has been appointed to undertake the Basic Assessment Process for the Namas and Zonnequa Wind Farms.

Please refer to the attached Notification letter and Background Information document for further information regarding the project.

Please do not hesitate to contact us if you have any quires in this regards.

Kind regards,

Rozanne Els

Public Participation Co-ordinator | Savannah Environmental (Pty) Ltd

Tel: +27 (0)11 656 3237 | Fax: +27 (0)86 684 0547





SAWEA Award for Leading Environmental Consultant for Wind Projects in 2013 & 2015

Show Plain Text

- Attachments: [11833 Savannah_web_afr.pdf](#)
[11833 Savannah_web_eng.pdf](#)
[Namas WF Notification Letter - OoS.pdf](#)
[Reply Form.pdf](#)
[Zonnequa WF Notification Letter - OoS.pdf](#)

▼ Activities

▲ Attachments

		(1 - 5 of 5)	
Subject	Contact	Last Modified	
 11833 Savannah_web_afr.pdf		04/10/2018 11:30	edit
 11833 Savannah_web_eng.pdf		04/10/2018 11:30	edit
 Namas WF Notification Letter - OoS.pdf		04/10/2018 11:30	edit
 Reply Form.pdf		04/10/2018 11:30	edit
 Zonnequa WF Notification Letter - OoS.pdf		04/10/2018 11:30	edit

▼ Accounts

Projects

Search

<input type="button" value="Create"/>		(1 - 1 of 1)	
Name	Assigned To	Start Date:	End Date:
Namas & Zonnequa Wind Farm	Gabriele Stein	01/05/2018	01/11/2018
			<input type="button" value="edit"/>

Print Back to top

Background Information Document Uploaded onto the Website

+27 (0) 11 656 3237 info@savannahsa.com in

savannah
environmental

Home About Us Services Experience Public Documents Careers Contact Us

Namas & Zonnequa Wind Farms

Namas & Zonnequa Wind Farms, Northern Cape Province.

Project Name: Namas Wind Farm, Northern Cape Province

Applicant: Genesis Namas Wind (Pty) Ltd

Proposed Activity: The development of a wind farm with a contracted capacity of up to 140MW which will include up to 43 wind turbines and associated infrastructure including a substation, a power line to connect at Gromis Substation, access roads and laydown areas.

Location: The project site is located approximately 20km south-east of Kleinse, within the Nama Khoi Local Municipality and the Namakwa District Municipality in the Northern Cape Province. The site falls within Focus Area 8 of the Renewable Energy Development Zones (REDZ), which is known as the Springbok REDZ.

Four properties comprise the wind farm site: Portion 3 of the Farm Zonnekwa 328, Portion 4 of the Farm Zonnekwa 328, Remaining Extent of the Farm Rooivlei 327 and Portion 3 of the Farm Rooivlei 327

+27 (0) 11 656 3237 info@savannahsa.com in

savannah
environmental

Home About Us Services Experience Public Documents Careers Contact Us

Downloads

NAMAS & ZONNEQUA WIND FARMS

BID - ENGLISH

BID_AFRIKAANS

In order to view or download the following documents Adobe Acrobat Reader is required. [Download Adobe Acrobat Reader...](#)

CONSULTATION WITH ORGANS OF STATE

From: Peter Cloete <peter.denc87@gmail.com>

Sent: Monday, 01 October 2018 4:58 PM

To: nicolene@savannahsa.com; Conrad Geldenhuys; Elsabe Swart; Samantha De la Fontaine; Nanine van Olmen Phillips; Louise Geldenhuys; Adeleen Cloete; Bronwen Cornelissen

Cc: Rozanne Els; lisa.o@savannahsa.com

Subject: Re: Basic Assessments: Namas & Sonnequa Wind Farms

Dear Nicolene

Thank you for the information. I would like to propose a meeting for Thursday, 25 October 2018 , 11:00 am at DENC Boardroom in Springbok. I have also cc my colleagues in this communication in case they wish to participate in the meeting. They will have to indicate their attendance.

Kind regards

Mr. Peter Cloete

Candidate Scientist: District Ecologists

Research and Development Support Section

Northern Cape Department of Environment and Nature Conservation

C/O Voortrekker and Magasyn Street

Springbok

8240

Tel: (027) 718 8800

Fax: (027) 718 8814

E-mail: peter.denc87@gmail.com

On Mon, Oct 1, 2018 at 4:43 PM Nicolene Venter <nicolene@savannahsa.com> wrote:

Dear Peter,

Thank you so much for taking my call earlier today!

Peter, as discussed it is envisaged that the Basic Assessment Reports for both the projects will be made available for comments on Friday, 12 October 2018 or shortly thereafter. Please be informed that your Department will be notified of the availability of the Reports.

Should the Reports be released on Friday, 12 October 2018, we tentatively book the following meeting dates and time with you:

- Wednesday, 24 October 2018: morning;
- Thursday, 25 October 2018: morning; or
- Friday, 26 October 2018: morning

Attached as requested is the Background Information Document (BID) for the proposed Namas and Sonnequa Wind Farm Projects situated near Kleinzee, Northern Cape Province.

You are most welcome to distribute the BID to your colleagues who you believe should also be informed.

Kind regards,



Virus-free. www.avast.com

Error! Filename not specified.

t: +27 (0)11 656 3237

f: +27 (0) 86 684 0547

**Error!
Filename
not
specified.**

Nicolene Venter

Public Participation and Social
Consultant

e: nicolene@savannahsa.com

c: +27 (0) 83 377 9112

SAWEA Award for Leading Environmental Consultant on Wind Projects in 2013 & 2015

Nicolene Venter

From: Savannah Public Process <publicprocess@savannahsa.com>
Sent: Monday, October 22, 2018 12:56 PM
To: Mr. Abe Abrahams
Cc: nicolene@savannahsa.com
Subject: Basic Assessments: Namas & Zonnequa Wind Farm Projects - Confirmation of BARs

Dear Mr Abrahams,

Thank you for taking my call a few minutes ago.

The Basic Assessment Reports (BARs) for the above-mentioned projects will be available for your Department's review and comments shortly.

This e-mail confirm our discussion that hard copies of the BARs can be courier to your Offices and if needed, your Office will forward the Reports to the National Department.

I would like to thank you for this confirmation and it is envisaged that the Reports will be at your offices tomorrow or Wednesday.

Kind regards

(Nicolene Venter)

Rozanne Els

Public Participation Co-ordinator | Savannah Environmental (Pty) Ltd
Tel: +27 (0)11 656 3237 | Fax: +27 (0)86 684 0547

SAWEA Award for Leading Environmental Consultant for Wind Projects in 2013 & 2015

Rozanne Els

From: Nicolene Venter <nicolene@savannahsa.com>
Sent: 19 October 2018 5:09 PM
To: 'Peter Cloete'
Cc: 'Conrad Geldenhuys'; 'Elsabe Swart'; 'Samantha De la Fontaine'; 'NVanOlmen'; 'Louise Geldenhuys'; adeleen.denc@gmail.com; bronwen.dtec@gmail.com; 'Rozanne Els'
Subject: Basic Assessments: Namas & Sonnequa Wind Farms - Focus Group Meeting
Importance: High

Dear Peter,

As per our e-mail communication below, the following:

- the protocol for securing a meeting with the Northern Cape DEND, as communicated below, will be followed;
- please cancel the tentative meeting date (Thursday, 25 October 2018 @ 11h00) as previously discussed;
- the Basic Assessment Report will be released for comment next week – the Northern Cape DENC will receive their notification and an electronic copy of the BAR (CD) will be courier to Mr Bryan Fisher, Director: Environmental Quality Management; and
- we will be in contact for a new meeting date (by following protocol).

Kind regards

Nicolene Venter

Public Participation & Social Consultant | Savannah Environmental (Pty) Ltd
Tel: +27 (0)11 656 3237 | Fax: +27 (0)86 684 0547

[SAWEA Award for Leading Environmental Consultant for Wind Projects in 2013 & 2015](#)

From: Nicolene Venter <nicolene@savannahsa.com>
Sent: Tuesday, October 2, 2018 10:23 AM
To: 'Peter Cloete' <peter.denc87@gmail.com>; 'BFisher' <bfisher@ncpg.gov.za>; 'dmoleka@ncpg.gov.za' <dmoleka@ncpg.gov.za>
Cc: 'Conrad Geldenhuys' <c.geldenhuys@hotmail.com>; 'Elsabe Swart' <elsabe.dtec@gmail.com>; 'Samantha De la Fontaine' <sdelafontaine@gmail.com>; 'Nanine van Olmen Phillips' <nvanolmen@ncpg.gov.za>; 'Louise Geldenhuys' <geldenhuys.louise1@gmail.com>; 'Adeleen Cloete' <adeleen.denc@gmail.com>; 'Bronwen Cornelissen' <bronwen.dtec@gmail.com>; 'Rozanne Els' <rozanne@savannahsa.com>; 'lisa.o@savannahsa.com' <lisa.o@savannahsa.com>
Subject: RE: Basic Assessments: Namas & Sonnequa Wind Farms

Dear Peter,

Thank you for the information provided and please receive herewith confirmation that the officials have been captured on the project database.

Kind regards

Nicolene Venter

Public Participation & Social Consultant | Savannah Environmental (Pty) Ltd
Tel: +27 (0)11 656 3237 | Fax: +27 (0)86 684 0547

[SAWEA Award for Leading Environmental Consultant for Wind Projects in 2013 & 2015](#)

From: Peter Cloete <peter.denc87@gmail.com>

Sent: Tuesday, October 2, 2018 10:07 AM

To: nicolene@savannahsa.com; BFisher <bfisher@ncpg.gov.za>; dmoleka@ncpg.gov.za

Cc: Conrad Geldenhuys <c.geldenhuys@hotmail.com>; Elsabe Swart <elsabe.dtec@gmail.com>; Samantha De la Fontaine <sdelafontaine@gmail.com>; Nanine van Olmen Phillips <nvanolmen@ncpg.gov.za>; Louise Geldenhuys <geldenhuys.louise1@gmail.com>; Adeleen Cloete <adeleen.denc@gmail.com>; Bronwen Cornelissen <bronwen.dtec@gmail.com>; Rozanne Els <rozanne@savannahsa.com>; lisa.o@savannahsa.com

Subject: Re: Basic Assessments: Namas & Sonnequa Wind Farms

Dear Nicolene

Please add the following officials to the database:

Ms. Dineo Moleka

Email: dmoleka@ncpg.gov.za

Tel: 083 807 7300

Mr. Bryan Fisher

Email: bfisher@ncpg.gov.za

Tel: 053 807 7300

I will also cc them in this communicate.

Kind regards

Mr. Peter Cloete

Candidate Scientist: District Ecologists

Research and Development Support Section

Northern Cape Department of Environment and Nature Conservation

C/O Voortrekker and Magasyn Street

Springbok

8240

Tel: (027) 718 8800

Fax: (027) 718 8814

E-mail: peter.denc87@gmail.com

On Tue, Oct 2, 2018 at 8:15 AM Nicolene Venter <nicolene@savannahsa.com> wrote:

Dear Conrad,

Thank you for your prompt response.

The project database will be updated with the information as per your e-mail signature and as communicate, we will confirm the meeting date and time as soon as the BAR is available for review and comment.

Kind regards

Nicolene Venter

Public Participation & Social Consultant | Savannah Environmental (Pty) Ltd

Tel: +27 (0)11 656 3237 | Fax: +27 (0)86 684 0547

[SAWEA Award for Leading Environmental Consultant for Wind Projects in 2013 & 2015](#)

From: Conrad Geldenhuys <c.geldenhuys@hotmail.com>

Sent: Tuesday, October 2, 2018 7:46 AM

To: Peter Cloete <peter.denc87@gmail.com>; nicolene@savannahsa.com; Elsabe Swart <elsabe.dtec@gmail.com>;

Samantha De la Fontaine <sdelafontaine@gmail.com>; Nanine van Olmen Phillips <nvanolmen@ncpg.gov.za>; Louise

Geldenhuis <geldenhuis.louise1@gmail.com>; Adeleen Cloete <adeleen.denc@gmail.com>; Bronwen Cornelissen <bronwen.dtec@gmail.com>

Cc: Rozanne Els <rozanne@savannahsa.com>; lisa.o@savannahsa.com

Subject: Re: Basic Assessments: Namas & Sonnequa Wind Farms

The date is noted.

Regards

Conrad

Conrad Geldenhuis Pr.Sci.Nat.
Production Scientist Grade B: Botanist
Research and Development Support Section
Northern Cape Department of Environment and Nature Conservation
Corner of Voortrekker and Magasyn streets
Private Bag X16
Springbok
South Africa
8240
EMAIL: c.geldenhuis@hotmail.com
Tel: (+27) 027 718 8800
Fax: (+27) 027 718 8807

From: Peter Cloete <peter.denc87@gmail.com>

Sent: Monday, 01 October 2018 4:58 PM

To: nicolene@savannahsa.com; Conrad Geldenhuis; Elsabe Swart; Samantha De la Fontaine; Nanine van Olmen Phillips; Louise Geldenhuis; Adeleen Cloete; Bronwen Cornelissen

Cc: Rozanne Els; lisa.o@savannahsa.com

Subject: Re: Basic Assessments: Namas & Sonnequa Wind Farms

Dear Nicolene

Thank you for the information. I would like to propose a meeting for Thursday, 25 October 2018 , 11:00 am at DENC Boardroom in Springbok. I have also cc my colleagues in this communication in case they wish to participate in the meeting. They will have to indicate their attendance.

Kind regards

Mr. Peter Cloete
Candidate Scientist: District Ecologists
Research and Development Support Section
Northern Cape Department of Environment and Nature Conservation
C/O Voortrekker and Magasyn Street
Springbok
8240
Tel: (027) 718 8800
Fax: (027) 718 8814
E-mail: peter.denc87@gmail.com

On Mon, Oct 1, 2018 at 4:43 PM Nicolene Venter <nicolene@savannahsa.com> wrote:

Dear Peter,

Thank you so much for taking my call earlier today!

Peter, as discussed it is envisaged that the Basic Assessment Reports for both the projects will be made available for comments on Friday, 12 October 2018 or shortly thereafter. Please be informed that your Department will be notified of the availability of the Reports.

Should the Reports be released on Friday, 12 October 2018, we tentatively book the following meeting dates and time with you:

- Wednesday, 24 October 2018: morning;
- Thursday, 25 October 2018: morning; or
- Friday, 26 October 2018: morning

Attached as requested is the Background Information Document (BID) for the proposed Namas and Sonnequa Wind Farm Projects situated near Kleinzee, Northern Cape Province.

You are most welcome to distribute the BID to your colleagues who you believe should also be informed.

Kind regards,

Virus-free. www.avast.com

Error! Filename not specified. Error! Filename not specified.

t: +27 (0)11 656 3237
f: +27 (0) 86 684 0547

Nicolene Venter
Public Participation and Social
Consultant
e: nicolene@savannahsa.com
c: +27 (0) 83 377 9112

SAWEA Award for Leading Environmental Consultant on Wind Projects in 2013 & 2015

Rozanne Els

From: Nicolene Venter <nicolene@savannahsa.com>
Sent: 02 October 2018 1:38 PM
To: 'Samantha De la Fontaine'
Cc: 'Peter Cloete'; 'BFisher'; dmoleka@ncpg.gov.za; 'Conrad Geldenhuys'; 'Elsabe Swart'; 'NvanOlmen'; 'Louise Geldenhuys'; adeleen.denc@gmail.com; bronwen.dtec@gmail.com; rozanne@savannahsa.com; lisa.o@savannahsa.com
Subject: BAs: Namas & Sonnequa Wind Farms - Acknowledgement (Samantha De la Fontaine: DENC)

Dear Samantha,

Thank you for the confirmation that we can register you on the project database.

Kind regards,

Nicolene Venter

Public Participation & Social Consultant | Savannah Environmental (Pty) Ltd
Tel: +27 (0)11 656 3237 | Fax: +27 (0)86 684 0547

[SAWEA Award for Leading Environmental Consultant for Wind Projects in 2013 & 2015](#)

From: Samantha De la Fontaine <sdelafontaine@gmail.com>
Sent: Tuesday, October 2, 2018 12:40 PM
To: nicolene@savannahsa.com
Cc: Peter Cloete <peter.denc87@gmail.com>; BFisher <bfisher@ncpg.gov.za>; dmoleka@ncpg.gov.za; Conrad Geldenhuys <c.geldenhuys@hotmail.com>; Elsabe Swart <elsabe.dtec@gmail.com>; NvanOlmen <nvanolmen@ncpg.gov.za>; Louise Geldenhuys <geldenhuys.louise1@gmail.com>; adeleen.denc@gmail.com; bronwen.dtec@gmail.com; rozanne@savannahsa.com; lisa.o@savannahsa.com
Subject: Re: Basic Assessments: Namas & Sonnequa Wind Farms

Dear Nicolene

I will not be able to attend the meeting but you can keep me on the database.

Regards

Samantha

Samantha De la Fontaine (Pr.Sci.Nat.)
Production Scientist Grade A: District Ecologist

Northern Cape Department of Environment and Nature Conservation
Evelina De Bruin (former Provincial) Building
Corner of Rivier & Nelson Mandela Road
Upington
8800
Tel.: +27 054 338 4800

E-mail: sdelafontaine@gmail.com
Website: <http://denc.ncpg.gov.za/>

On Tue, Oct 2, 2018 at 10:22 AM Nicolene Venter <nicolene@savannahsa.com> wrote:

Dear Peter,

Thank you for the information provided and please receive herewith confirmation that the officials have been captured on the project database.

Kind regards

Nicolene Venter

Public Participation & Social Consultant | Savannah Environmental (Pty) Ltd

Tel: +27 (0)11 656 3237 | Fax: +27 (0)86 684 0547

[SAWEA Award for Leading Environmental Consultant for Wind Projects in 2013 & 2015](#)

From: Peter Cloete <peter.denc87@gmail.com>

Sent: Tuesday, October 2, 2018 10:07 AM

To: nicolene@savannahsa.com; BFisher <bfisher@ncpg.gov.za>; dmoleka@ncpg.gov.za

Cc: Conrad Geldenhuys <c.geldenhuys@hotmail.com>; Elsabe Swart <elsabe.dtec@gmail.com>; Samantha De la Fontaine <sdelafontaine@gmail.com>; Nanine van Olmen Phillips <nvanolmen@ncpg.gov.za>; Louise Geldenhuys <geldenhuys.louise1@gmail.com>; Adeleen Cloete <adeleen.denc@gmail.com>; Bronwen Cornelissen <bronwen.dtec@gmail.com>; Rozanne Els <rozanne@savannahsa.com>; lisa.o@savannahsa.com

Subject: Re: Basic Assessments: Namas & Sonnequa Wind Farms

Dear Nicolene

Please add the following officials to the database:

Ms. Dineo Moleka

Email: dmoleka@ncpg.gov.za

Tel: 083 807 7300

Mr. Bryan Fisher

Email: bfisher@ncpg.gov.za

Tel: 053 807 7300

I will also cc them in this communicate.

Kind regards

Mr. Peter Cloete

Candidate Scientist: District Ecologists

Research and Development Support Section

Northern Cape Department of Environment and Nature Conservation

C/O Voortrekker and Magasyn Street

Springbok

8240

Tel: (027) 718 8800

Fax: (027) 718 8814

E-mail: peter.denc87@gmail.com

On Tue, Oct 2, 2018 at 8:15 AM Nicolene Venter <nicolene@savannahsa.com> wrote:

Dear Conrad,

Thank you for your prompt response.

The project database will be updated with the information as per your e-mail signature and as communicate, we will confirm the meeting date and time as soon as the BAR is available for review and comment.

Kind regards

Nicolene Venter

Public Participation & Social Consultant | Savannah Environmental (Pty) Ltd

Tel: +27 (0)11 656 3237 | Fax: +27 (0)86 684 0547

[SAWEA Award for Leading Environmental Consultant for Wind Projects in 2013 & 2015](#)

From: Conrad Geldenhuys <c.geldenhuys@hotmail.com>
Sent: Tuesday, October 2, 2018 7:46 AM
To: Peter Cloete <peter.denc87@gmail.com>; nicolene@savannahsa.com; Elsabe Swart <elsabe.dtec@gmail.com>; Samantha De la Fontaine <sdelafontaine@gmail.com>; Nanine van Olmen Phillips <nvanolmen@ncpg.gov.za>; Louise Geldenhuys <geldenhuys.louise1@gmail.com>; Adeleen Cloete <adeleen.denc@gmail.com>; Bronwen Cornelissen <bronwen.dtec@gmail.com>
Cc: Rozanne Els <rozanne@savannahsa.com>; lisa.o@savannahsa.com
Subject: Re: Basic Assessments: Namas & Sonnequa Wind Farms

The date is noted.

Regards

Conrad

Conrad Geldenhuys Pr.Sci.Nat.
Production Scientist Grade B: Botanist
Research and Development Support Section
Northern Cape Department of Environment and Nature Conservation
Corner of Voortrekker and Magasyn streets
Private Bag X16
Springbok
South Africa
8240
EMAIL: c.geldenhuys@hotmail.com
Tel: (+27) 027 718 8800
Fax: (+27) 027 718 8807

From: Peter Cloete <peter.denc87@gmail.com>

Sent: Monday, 01 October 2018 4:58 PM

To: nicolene@savannahsa.com; Conrad Geldenhuys; Elsabe Swart; Samantha De la Fontaine; Nanine van Olmen Phillips; Louise Geldenhuys; Adeleen Cloete; Bronwen Cornelissen

Cc: Rozanne Els; lisa.o@savannahsa.com

Subject: Re: Basic Assessments: Namas & Sonnequa Wind Farms

Dear Nicolene

Thank you for the information. I would like to propose a meeting for Thursday, 25 October 2018 , 11:00 am at DENC Boardroom in Springbok. I have also cc my colleagues in this communication in case they wish to participate in the meeting. They will have to indicate their attendance.

Kind regards

Mr. Peter Cloete

Candidate Scientist: District Ecologists

Research and Development Support Section

Northern Cape Department of Environment and Nature Conservation

C/O Voortrekker and Magasyn Street

Springbok

8240

Tel: (027) 718 8800

Fax: (027) 718 8814

E-mail: peter.denc87@gmail.com

On Mon, Oct 1, 2018 at 4:43 PM Nicolene Venter <nicolene@savannahsa.com> wrote:

Dear Peter,

Thank you so much for taking my call earlier today!

Peter, as discussed it is envisaged that the Basic Assessment Reports for both the projects will be made available for comments on Friday, 12 October 2018 or shortly thereafter. Please be informed that your Department will be notified of the availability of the Reports.

Should the Reports be released on Friday, 12 October 2018, we tentatively book the following meeting dates and time with you:

- Wednesday, 24 October 2018: morning;
- Thursday, 25 October 2018: morning; or
- Friday, 26 October 2018: morning

Attached as requested is the Background Information Document (BID) for the proposed Namas and Sonnequa Wind Farm Projects situated near Kleinzee, Northern Cape Province.

You are most welcome to distribute the BID to your colleagues who you believe should also be informed.

Kind regards,

Virus-free. www.avast.com

Error! Filename not specified.

t: +27 (0)11 656 3237
f: +27 (0) 86 684 0547

**Error!
Filename
not
specified.**

Nicolene Venter
Public Participation and Social
Consultant
e: nicolene@savannahsa.com
c: +27 (0) 83 377 9112

SAWEA Award for Leading Environmental Consultant on Wind Projects in 2013 & 2015

Nicolene Venter

From: Nicolene Venter <nicolene@savannahsa.com>
Sent: Wednesday, November 21, 2018 11:12 AM
To: 'Deidre Koopman'
Cc: 'Cynthia Nkoane'
Subject: RE: Namas & Zonnequa: Property information

Dear Deidre,

Thank you for the confirmation below.

Kind regards,

Nicolene Venter

Public Participation & Social Consultant | Savannah Environmental (Pty) Ltd
Tel: +27 (0)11 656 3237 | Fax: +27 (0)86 684 0547

[SAWEA Award for Leading Environmental Consultant for Wind Projects in 2013 & 2015](#)

From: Deidre Koopman <Deidre.Koopman@drdlr.gov.za>
Sent: Wednesday, November 21, 2018 11:10 AM
To: Nicolene Venter <nicolene@savannahsa.com>
Cc: Cynthia Nkoane <Cynthia.Nkoane@drdlr.gov.za>
Subject: RE: Namas & Zonnequa: Property information

Dear Nicolene

Kindly note that the DRDLR has no relation in terms of the properties listed on the spreadsheet, as it is privately owned.

Regards
Deidré

From: Nicolene Venter [mailto:nicolene@savannahsa.com]
Sent: Tuesday, November 20, 2018 4:15 PM
To: Deidre Koopman
Subject: Namas & Zonnequa: Property information

Dear Deidre,

Attached please find the spreadsheet with the property information for both the Namas & Zonnequa Wind Energy Projects as requested.

Please do not hesitate to contact us should you require any additional information.

Kind regards,

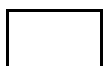

Virus-free. www.avast.com



t: +27 (0)11 656 3237
f: +27 (0) 86 684 0547

Nicolene Venter
Public Participation and Social
Consultant

e: nicolene@savannahsa.com
c: +27 (0) 83 377 9112

SAWEA Award for Leading Environmental Consultant on Wind Projects in 2013 & 2015

Rozanne Els

From: Nicolene Venter <nicolene@savannahsa.com>
Sent: 02 October 2018 2:10 PM
To: 'NVanOlmen'
Cc: rozanne@savannahsa.com
Subject: BAs: Namas & Sonnequa Wind Farms - Acknowledgement of Registration and Contact details

Dear Ms Van Olmen,

Thank you for your prompt response and the contact details provided.

Please receive herewith confirmation that you are registered on the projects' database.

Kind regards,

Nicolene Venter

Public Participation & Social Consultant | Savannah Environmental (Pty) Ltd
Tel: +27 (0)11 656 3237 | Fax: +27 (0)86 684 0547

[SAWEA Award for Leading Environmental Consultant for Wind Projects in 2013 & 2015](#)

From: NVanOlmen <nvanolmen@ncpg.gov.za>
Sent: Tuesday, October 2, 2018 11:20 AM
To: nicolene@savannahsa.com
Subject: RE: Basic Assessments: Namas & Sonnequa Wind Farms

Dear Ms Venter,

You may register me on your database. My details are as follows:

Nanine van Olmen
Director: Environmental Policy, Planning and Coordination
office phone: 053 807 7379
cell: 082 458 3129

kind regards

Nanine

>>> "Nicolene Venter" <nicolene@savannahsa.com> 10/02/18 6:56 AM >>>

Dear Peter,

Thank you for the tentative date and time for our requested meeting.

We will liaise timeously with you and your colleagues (formal invitation

& calendar invitation) once the BAR is released for review and comment.

Dear:

- * Mr Conrad Geldenhuys
- * Ms Elsabe Swart
- * Ms Samantha de la Fontaine
- * Ms Nanine van Olmen Phillips
- * Ms Louise Geldenhuys
- * Ms Adeleen Cloete
- * Ms Bronwen Cornelissen

Would you please be so kind and confirm that we can register you on the above-mentioned projects' database? If so, please provide us with the following details:

- * Position at DENC
- * Telephone no (office)
- * Fax no
- * Mobile no

Kind regards,

Nicolene Venter

Public Participation & Social Consultant | Savannah Environmental
(Pty) Ltd

Tel: +27 (0)11 656 3237 | Fax: +27 (0)86 684 0547

SAWEA Award for Leading Environmental Consultant for Wind Projects in
2013 & 2015

From: Peter Cloete <peter.denc87@gmail.com>
Sent: Monday, October 1, 2018 4:59 PM
To: nicolene@savannahsa.com; Conrad Geldenhuys
<c.geldenhuys@hotmail.com>; Elsabe Swart <elsabe.dtec@gmail.com>;
Samantha De la Fontaine <sdelafontaine@gmail.com>; Nanine van Olmen
Phillips <nvanolmen@ncpg.gov.za>; Louise Geldenhuys
<geldenhuys.louise1@gmail.com>; Adeleen Cloete <adeleen.denc@gmail.com>;

Bronwen Cornelissen <bronwen.dtec@gmail.com>

Cc: Rozanne Els <rozanne@savannahsa.com>; lisa.o@savannahsa.com

Subject: Re: Basic Assessments: Namas & Sonnequa Wind Farms

Dear Nicolene

Thank you for the information. I would like to propose a meeting for Thursday, 25 October 2018 , 11:00 am at DENC Boardroom in Springbok. I have also cc my colleagues in this communication in case they wish to participate in the meeting. They will have to indicate their attendance.

Kind regards

Mr. Peter Cloete

Candidate Scientist: District Ecologists

Research and Development Support Section

Northern Cape Department of Environment and Nature Conservation

C/O Voortrekker and Magasyn Street

Springbok

8240

Tel: (027) 718 8800

Fax: (027) 718 8814

E-mail: <<mailto:peter.denc87@gmail.com>> peter.denc87@gmail.com

On Mon, Oct 1, 2018 at 4:43 PM Nicolene Venter <nicolene@savannahsa.com>
<<mailto:nicolene@savannahsa.com>> > wrote:

Dear Peter,

Thank you so much for taking my call earlier today!

Peter, as discussed it is envisaged that the Basic Assessment Reports for both the projects will be made available for comments on Friday, 12 October 2018 or shortly thereafter. Please be informed that your Department will be notified of the availability of the Reports.

Should the Reports be released on Friday, 12 October 2018, we tentatively book the following meeting dates and time with you:

- * Wednesday, 24 October 2018: morning;
- * Thursday, 25 October 2018: morning; or
- * Friday, 26 October 2018: morning

Attached as requested is the Background Information Document (BID) for the proposed Namas and Sonnequa Wind Farm Projects situated near Kleinzee, Northern Cape Province.

You are most welcome to distribute the BID to your colleagues who you believe should also be informed.

Kind regards,

https://www.avast.com/sig-email?utm_medium=email&utm_source=link&utm_campaign=sig-email&utm_content=emailclient

Virus-free.

https://www.avast.com/sig-email?utm_medium=email&utm_source=link&utm_campaign=sig-email&utm_content=emailclient
www.avast.com

Error! Filename not specified.

Error! Filename not specified.

Nicolene Venter
Public Participation and Social Consultant

t: +27 (0)11 656 3237

f: +27 (0) 86 684 0547

e: nicolene@savannahsa.com: +27 (0) 83 377 9112

SAWEA Award for Leading Environmental Consultant on Wind Projects in
2013 & 2015

This email has been checked for viruses by Avast antivirus software.

<https://www.avast.com/antivirus>

This email and any files transmitted with it are confidential and intended solely for the use of the individual or entity to whom they are addressed. If you have received this email in error please notify the system manager. Please note that any views or opinions presented in this email are solely those of the author and do not necessarily represent those of the company. Finally, the recipient should check this email and any attachments for the presence of viruses. The company accepts no liability for any damage caused by any virus transmitted by this email.



Virus-free. www.avast.com

NOTIFICATION OF BASIC ASSESSMENT REPORT
FOR PUBLIC REVIEW AND COMMENT

23 October 2018

Dear Stakeholder

BASIC ASSESSMENT AND PUBLIC PARTICIPATION PROCESS ZONNEQUA WIND FARM, NORTHERN CAPE

NOTICE OF AVAILABILITY OF BASIC ASSESSMENT REPORT FOR REVIEW AND COMMENT

A wind farm is proposed to be developed within the Springbok Renewable Energy Development Zone (REDZ), approximately 20 km south-east of the town of Kleinsee in the Northern Cape. The wind farm is known as the **Zonnequa Wind Farm** and is located within the Nama Khoi Local Municipality and the Namakwa District Municipality.

It is Genesis Zonnequa Wind (Pty) Ltd's, the developer, intention to bid the Zonnequa Wind Farm project under the Department of Energy's (DoE) Renewable Energy Independent Power Producer Procurement (REIPPP) Programme. The power generated from the project will be sold to Eskom and will feed into the national electricity grid. The development of the project will also assist with achieving the electricity generation goals as set out in the Integrated Resources Plan.

Another wind farm is proposed to be developed directly south of the Zonnequa Wind Farm, known as the Nama Wind Farm. This wind farm will be assessed as part of a separate Basic Assessment (BA) process.

AVAILABILITY OF BASIC ASSESSMENT REPORT FOR REVIEW

As a registered Interested and Affected Party (I&AP), you are hereby notified that the Basic Assessment Report is available for review and comment. The report can be viewed at the Kleinsee Public Library (3rd Avenue, Kleinsee, open on Tuesdays & Thursdays between 11h00 and 17h00) from **Wednesday, 24 October 2018 to Friday, 23 November 2018**. The report can also be downloaded from the Savannah Environmental's website: www.savannahsa.com. A password will be required to access the download, and the password can be requested from our Public Participation Office (contact details below).

We kindly request that you submit your written comment(s) on the BA Report before or by **Friday, 23 November 2018** via fax, post or email (contact details below). All comments received during this 30-day review period will be recorded and included in the Final Basic Assessment Report for submission to the Department of Environmental Affairs in line with Regulation 44 of the 2014 NEMA EIA Regulations, as amended (GN R326).

Please do not hesitate to contact us should you require additional information and / or clarification regarding the projects. Our team welcomes your participation and looks forward to your involvement throughout this process.

Kind regards

A handwritten signature in black ink, appearing to read 'Nicolene Venter', written in a cursive style.

Nicolene Venter

Public Participation and Social Consultation

(publicprocess@savannahsa.com)

ZONNEQUA WIND FARM: NOTIFICATION OF AVAILABILITY OF BASIC ASSESSMENT REPORT FOR REVIEW AND COMMENT

Search

Forward

Assigned to:	Savannah Public Process	Date Sent:	23/10/2018 09:28
Teams:	Global	Project:	Namas & Zonnequa Wind Farm
From:	Savannah Public Process <publicprocess@savannahsa.com>		
To:			
Cc:	nicolene@savannahsa.com		
Bcc:	<p>John Wesson <jnbadm@wessa.co.za>, Mandy Poole <mandyp@ewt.org.za>, Morne du Plessis <mduplessis@wwf.org.za>, Yolandé Oberholzer <agrivbgl@truvb.co.za>, Werner Kleynhans <kleynhansw@caa.co.za>, Chris Fortuin <chrisf@namakwa-dm.gov.za>, Andrea van Gensen <vgenseal@eskom.co.za>, Abegail Makgato <abegailm@transhex.co.za>, Elizabeth Botes <twessels@ncpg.gov.za>, Gert Greeff <greeffg@eskom.co.za>, Steven Shibambu <shibambus@dwa.gov.za>, Livhuwani Mashamba <mashamlp@eskom.co.za>, Natalie Weyers <nats.weyers@gmail.com>, Samantha Ralston-Paton <energy@birdlife.org.za>, Bryan Fisher <bfisher@ncpg.gov.za>, Tiaan Priem <tiaanp@transhex.co.za>, Adam Claasen <claassenaubrey@gmail.com>, Adrian Tiplady <atiplady@ska.ac.za>, Constant Hoogstad <constanth@ewt.org.za>, Peter Cloete <peter.denc87@gmail.com>, Dineo Moleko <dmoleko@ncpg.gov.za>, Thebe Thebe <tthebe@ncpg.gov.za>, Nomfundo Ntloko-Gobodo <nomfundo.ntloko-gobodo@drdlr.gov.za>, Tabbie Roberts <tabbie@vodamail.com>, Riaan van Wyk <socialdev1@hantam.gov.za>, Anton Meyer <anton.meyer@debeersgroup.com>, Nicole Abrahams <abrahamsn@nra.co.za>, Johan Jacobus Mostert <rooivley@gmail.com>, Leonard Shaw <shawls@telkom.co.za>, Jeanene Jessnitz <jeanene.jessnitz@gmail.com>, Ravisha Ajodhapersadh <ravisha.ajodhapersadh@enel.com>, John Geeringh <john.geeringh@eskom.co.za>, Jacques Cloete <jacques.cloete@namakhoi.gov.za>, Lani Adonus <lanieadonus9@gmail.com>, Ratha Andrew Timothy <ratha.timothy@gmail.com>, Bentram Leukes <buildings@hantam.gov.za>, Albertus Johannes Roux <irene53@yahoo.com>, Veronique Fyfe <eia@g7energies.com>, Jaco Roelofse <roelofse.j@vodamail.co.za>, Lt. Cnl. Kebasenosi Zondi <kebasenosi@yahoo.com>, Lizell Stroh <strohl@caa.co.za>, Megan Murison <meganm@ewt.org.za>, Yolán Friedmann <yolanf@ewt.org.za>, Nanine van Olmen Phillips <nvanolmen@ncpg.gov.za>, ST Felix <idp@hantam.gov.za>, Natasha Higgitt <nhiggitt@sahra.org.za>, Belinda Farmer <loeriesfonteinlib@ncpg.gov.za>, Jasper Nieuwoudt <jasper.nieuwoudt@dmr.gov.za>, Wilma Lutsch <wlutsch@environment.gov.za></p>		
Subject:	ZONNEQUA WIND FARM: NOTIFICATION OF AVAILABILITY OF BASIC ASSESSMENT REPORT FOR REVIEW AND COMMENT		
Body:	<p>Dear Stakeholder,</p> <p>A wind farm is proposed to be developed within the Springbok Renewable Energy Development Zone (REDZ), approximately 20 km south-east of the town of Kleinsee in the Northern Cape. The wind farm is known as the Zonnequa Wind Farm and is located within the Nama Khoi Local</p>		

and will feed into the national electricity grid. The development of the project will also assist with achieving the electricity generation goals as set out in the Integrated Resources Plan. Search

This e-mail serves to inform you, as a registered Interested and Affected Party (I&AP), that in terms of the National Environmental Management Act (No. 107 of 1998) (NEMA) and the 2014 Environmental Impact Assessment (EIA) Regulations, as amended in April 2017, that the Basic Assessment Report (BAR) is available for your review and comment.

The hard copy of the BAR can be viewed at the Kleinsee Library (3rd Avenue, Kleinsee, open on Tuesdays & Thursdays between 11h00 and 17h00) from **Wednesday, 24 October 2018 to Friday, 23 November 2018**. An electronic copy can be downloaded from our website (<http://www.savannahsa.com/public-documents/energy-generation/zonnequa-wind-farm/>).

Please refer to the attached letter for further details in this regard.

Kind regards,

Nicolene Venter

Public Participation and Social Consultant | Savannah Environmental (Pty) Ltd
 Tel: +27 (0)11 656 3237 | Mobile: +27 83 377 9112 | Fax: +27 (0)86 684 0547

SAWEA Award for Leading Environmental Consultant for Wind Projects in 2013 & 2015

Show Plain Text

Attachments: [Zonnequa WF BAR NotificaitonLetter.pdf](#)

Activities

(0 - 0 of 0)				
Subject	Status	Contact	Due Date	Assigned User
No Data				

Attachments

(1 - 1 of 1)		
Subject	Contact	Last Modified
 Zonnequa WF BAR NotificaitonLetter.pdf		23/10/2018 09:28 edit

Accounts

(0 - 0 of 0)		
Account Name	Town/City	Phone
M. D. ...		

ZONNEQUA WIND FARM: NOTIFICATION OF AVAILABILITY OF BASIC ASSESSMENT REPORT FOR REVIEW AND COMMENT

Search

Forward

Assigned to:	Savannah Public Process	Date Sent:	23/10/2018 09:30
Teams:	Global	Project:	Namas & Zonnequa Wind Farm
From:	Savannah Public Process <publicprocess@savannahsa.com>		
To:			
Cc:	nicolene@savannahsa.com		
Bcc:	<p>Karen de Bruyn <karen@g7energies.com>, Nicol Jansen <henning@agrink.co.za>, Deon Fontini <dfontini@martin-east.co.za>, Minnelise Levendal <mlevendal@csir.co.za>, Koos Bisschoff <koosbisschoff@gmail.com>, Jacqueline Mans <jacolinema@daff.gov.za>, D Jennings <daacatmat@yahoo.com>, Kleinzee Conservation Club <info@kleinzeeinfo.co.za>, Annabe van Dyk <annabevandyk@gmail.com>, Conrad Geldenhuys <c.geldenhuys@hotmail.com>, Meisie Engelbrecht <mesie@3i.co.za>, Kate MacEwan <kate@iws-sa.co.za>, Hentie Van Jaarsveld <saffier@hantam.co.za>, Samantha De la Fontaine <sdelafontaine@gmail.com>, Magdalena Michalowska <m.michalowska@buildingenergy.it>, Samantha Titus <municipal.manager@namakhoi.gov.za>, Paulus van Reenen <paulus.vanreenen@namakhoi.gov.za>, Bulelani Right <bulelanir@namakwa-dm.gov.za>, Johanna Morobane <johannam@atns.co.za>, Paul Vermeulen <paul@eranamaquacoast.co.za>, Kleinzee Tourism <nmtourism@debeersgroup.com>, Thoko Buthelezi <thokob@daff.gov.za>, Quiryn Snethlage <qsnetlage@mweb.co.za>, J Schabort <jschabort@gmail.com>, Tamai Hore <tamai.hore@nersa.org.za>, Simphiwe Masilela <simphiwem@atns.co.za>, Abe Abrahams <franksl@dwa.gov.za>, Michael Knight <mike.knight@sanparks.org>, Russel Hartley <russel.hartley@namakhoi.gov.za>, Mangalane Du Toit <mangalane.dutoit@drdlr.gov.za>, Vincent Madlela <vincent@mamokgoka.co.za>, Roger Swartz <mayor@hantam.gov.za>, Louise Geldenhuys <geldenhuys.louise1@gmail.com>, Elsabe Swart <elsabe.dtec@gmail.com>, Mashudu Marubini <mashuduma@daff.gov.za>, Pheladi Masipa <pheladi.masipa@energy.gov.za></p>		
Subject:	ZONNEQUA WIND FARM: NOTIFICATION OF AVAILABILITY OF BASIC ASSESSMENT REPORT FOR REVIEW AND COMMENT		
Body:	<p>Dear Stakeholder,</p> <p>A wind farm is proposed to be developed within the Springbok Renewable Energy Development Zone (REDZ), approximately 20 km south-east of the town of Kleinsee in the Northern Cape. The wind farm is known as the Zonnequa Wind Farm and is located within the Nama Khoi Local Municipality and the Namakwa District Municipality.</p> <p>It is Genesis Zonnequa Wind (Pty) Ltd's, the developer, intention to bid the Zonnequa Wind Farm project under the Department of Energy's (DoE) Renewable Energy Independent Power Producer Procurement (REIPPP) Programme. The power generated from the project will be sold to Eskom and will feed into the national electricity grid. The development of the project will also assist with</p>		

Assessment Report (BAR) is available for your review and comment.

Search

The hard copy of the BAR can be viewed at the Kleinsee Library (3rd Avenue, Kleinsee, open on Tuesdays & Thursdays between 11h00 and 17h00) from **Wednesday, 24 October 2018 to Friday, 23 November 2018**. An electronic copy can be downloaded from our website (<http://www.savannahsa.com/public-documents/energy-generation/zonnequa-wind-farm/>).

Please refer to the attached letter for further details in this regard.

Kind regards,

Nicolene Venter

Public Participation and Social Consultant | Savannah Environmental (Pty) Ltd
 Tel: +27 (0)11 656 3237 | Mobile: +27 83 377 9112 | Fax: +27 (0)86 684 0547

SAWEA Award for Leading Environmental Consultant for Wind Projects in 2013 & 2015

Show Plain Text

Attachments: [Zonnequa WF BAR NotificaitonLetter.pdf](#)

Activities

Subject	Status	Contact	Due Date	Assigned User
No Data				

Attachments

Subject	Contact	Last Modified
 Zonnequa WF BAR NotificaitonLetter.pdf		23/10/2018 09:30
		<input type="button" value="edit"/>

Accounts

Account Name	Town/City	Phone
No Data		

Contacts

Name	Organisation	Email
No Data		

Savannah Environmental Public Process

From: Savannah Environmental Public Process <publicprocess@savannahsa.com>
Sent: 01 November 2018 12:26 PM
To: 'jacquidmerwe395@gmail.com'
Subject: Namas and Zonnequa
Attachments: Namas & Zonnequa_BID_AFR.PDF; Namas & Zonnequa_BID_ENG.PDF; Namas WF BAR NotificationLetter.pdf; Zonnequa WF BAR NotificaitonLetter.pdf; Reply Form.pdf

Importance: High

Dear Jacqueline,

Please see attached the Background Information document and reply Form. Also see attached the Notification of the availability of the Basic Assessment report for review and comment.

The Review period is from Wednesday, 24 October 2018 to Friday, 23 November 2018. All comments are kindly requested to be submitted before or by Friday 23 November 2018.

Kind regards,

DISTRIBUTION OF BASIC ASSESSMENT REPORT FOR
PUBLIC REVIEW AND COMMENT

WEBSITE:

<http://www.savannahsa.com/public-documents/energy-generation/zonnequa-wind-farm/>



Zonnequa Wind Farm, Northern Cape Province

Project Name: Zonnequa Wind Farm, Northern Cape Province

Applicant: Genesis Zonnequa Wind (Pty) Ltd

Proposed Activity: The development of a wind farm with a contracted capacity of up to 140MW which will include up to 56 wind turbines and associated infrastructure including a substation, a power line to connect at Gromis Substation, access roads and laydown areas.

Location: The project site is located approximately 19km south-east of Kleinsee, within the Nama Khoi Local Municipality and the Namakwa District Municipality in the Northern Cape Province. The site falls within Focus Area 8 of the Renewable Energy Development Zones (REDZ), which is known as the Springbok REDZ.

Two properties comprise the wind farm site: Portion 1 of the Farm Zonnekwa 328 and the Remaining Extent of the Farm Zonnekwa 326.

The power line corridor traverses seven affected properties: Remaining extent of the Farm Zonnekwa 326, Remaining extent of the Farm Honde Vlei 325, Remaining extent of the Farm Kannabieduin 324, Remaining extent of the Farm Leliefontein 322, Remaining extent of the Farm Mannels Vley 321, Remaining extent of the Farm Dikgat 195 and Portion 15 of the Farm Dikgat 195.

Basic Assessment Process: In terms of Sections 24 and 24D of the National Environmental Management Act (No 107 of 1998), as read with Government Notice R324 – R327, as amended, Environmental Authorisation is required for the project. As the project site is located within the REDZ, a Basic Assessment (BA) process is required to be undertaken in accordance with GN114 (February 2018). Savannah Environmental is undertaking the required environmental assessment and public participation process.

To obtain further information and register on the project database, please submit your name, contact information and interest in the project to:

Rozanne Els of Savannah Environmental

Post: P.O. Box 148, Sunninghill, 2157, Johannesburg

Tel: 011 656 3237 | Fax: 086 684 0547

Email: publicprocess@savannahsa.com

Downloads

Zonnequa Wind Farm

[BASIC ASSESSMENT REPORT](#)

[APPENDIX A - EIA CONSULTING TEAM & SPECIALIST CVS](#)

[APPENDIX B - AUTHORITY CONSULTATION](#)

[APPENDIX C1 - I&AP DATABASE](#)

[APPENDIX C2 - SITE NOTICES & NEWSPAPER ADVERTISEMENTS](#)

[APPENDIX C3 - BACKGROUND INFORMATION DOCUMENT](#)

[APPENDIX C4 - ORGANS OF STATE CORRESPONDENCE](#)

[APPENDIX C5 - STAKEHOLDER CORRESPONDENCE](#)

[APPENDIX C6 - COMMENTS RECEIVED](#)

[APPENDIX C7 - MINUTES OF MEETINGS](#)

[APPENDIX C8 - COMMENTS & RESPONSES REPORT](#)

[APPENDIX D - ECOLOGICAL IMPACT ASSESSMENT](#)

APPENDIX E - AVIFAUNA IMPACT ASSESSMENT

APPENDIX F - BAT IMPACT ASSESSEMENT

APPENDIX G - SOILS & AGRICULTURAL IMPACT ASSESSMENT

APPENDIX H - HERITAGE IMPACT ASSESSEMENT

APPENDIX I - NOISE IMPACT ASSESSMENT

APPENDIX J - VISUAL IMPACT ASSESSMENT

APPENDIX K - SOCIO-ECONOMIC IMPACT ASSESSMENT

APPENDIX L - TRAFFIC IMPACT ASSESSMENT

APPENDIX M - EMPR

APPENDIX N - MAPS

APPENDIX O - SPECIALIST DECLARATIONS

APPENDIX P - EAP DECLARATION & AFFIRMATION

SAHRA:

<https://www.sahra.org.za/sahris/cases/zonnequa-wind-farm>

Zonnequa Wind Farm

Add new comment Subscribe to: This post 11 reads

CaseHeader LocationInfo Admin

Status: SUBMITTED

HeritageAuthority(s): SAHRA
NBKB

Case Type: Section 38 (8) - Statutory Comment Required

Development Type: Wind

ProposalDescription:

The development of a wind farm with a contracted capacity of up to 140MW which will include up to 56 wind turbines and associated infrastructure including a substation, a power line to connect at Gromis Substation, access roads and laydown areas.

ApplicationDate: Thursday, October 18, 2018 - 09:58

CaseID: 13065

Applicants: Genesis Zonnequa Wind (Pty) Ltd

Consultants/Experts: Lisa Opperman

OtherReferences:

Dept	CaseReference	DueDate	FinalDecision
DEA			

Heritage Reports: HIA - Zonnequa Wind Farm (26.09.18)

ReferenceList:

AdditionalDocuments

1.  ZonnequaWF_Appendix A - EIA Consulting Team & Specialist CVs.pdf
2.  ZonnequaWF_Basic Assessment Report (Oct'18).pdf
3.  ZonnequaWF_Appendix B - Authority Consultation.pdf
4.  ZonnequaWF_Appendix C1 - I&AP Database.pdf
5.  ZonnequaWF_Appendix C2 - Site Notices & Newspaper Advertisements.pdf
6.  ZonnequaWF_Appendix C3 - Background Information Document.pdf
7.  ZonnequaWF_Appendix C4 - Organs of State Correspondence.pdf
8.  ZonnequaWF_Appendix C5 - Stakeholder Correspondence.pdf
9.  ZonnequaWF_Appendix C6 - Comments Received.pdf
10.  ZonnequaWF_Appendix C7 - Minutes of Meetings.pdf
11.  ZonnequaWF_Appendix C8 - Comments & Responses Report.pdf
12.  ZonnequaWF_Appendix D - Ecological Impact Assessment.pdf
13.  ZonnequaWF_Appendix E - Avifauna Impact Assessment.pdf
14.  ZonnequaWF_Appendix F - Bat Impact Assessment.pdf
15.  ZonnequaWF_Appendix G - Soils & Agricultural Impact Assessment.pdf
16.  ZonnequaWF_Appendix I - Noise Impact Assessment.pdf
17.  ZonnequaWF_Appendix J - Visual Impact Assessment.pdf
18.  ZonnequaWF_Appendix K - Socio-Economic Impact Assessment.pdf
19.  ZonnequaWF_Appendix L - Traffic Impact Assessment.pdf
20.  ZonnequaWF_Appendix M - EMP.pdf
21.  ZonnequaWF_Appendix N - Maps.pdf
22.  ZonnequaWF_Appendix O - Specialist Declarations.pdf
23.  ZonnequaWF_Appendix P - EAP Declaration & Affirmation.pdf



BASIC ASSESSMENT AND PUBLIC PARTICIPATION PROCESS FOR THE
ZONNEQUA WIND FARM NEAR KLEINSEE, NORTHERN CAPE PROVINCE

DISTRIBUTION OF THE BASIC ASSESSMENT REPORT TO ORGANS OF STATE: Review Period Wednesday, 24 October 2018 to Friday, 23 November 2018

TITLE	NAME	SURNAME	POSITION	DELIVERY ADDRESS	CONTACT DETAILS	REPORT FORMAT & METHOD OF DISTRIBUTION	COMMENTS (Follow-ups & confirmation of receipt)			
							1ST REMINDER 16 Nov 2018	ADDITIONAL	2ND REMINDER 23 Nov 2018	COMMENTS RECEIVED
DEPARTMENT OF AGRICULTURE, FORESTRY AND FISHERIES										
<i>National</i>										
Mr	Mashudu	Marubini	Delegate to the Minister	Office 270 Delpen Building C/o Annie Botha & Union Streets PRETORIA 0002	Tel.: 012 319 7619 Cell: 072 195 7000 E-mail: mashuduma@daff.gov.za	1 x CD Courier Waybill No.:1298110925	E-mail	E-mail: 20-11-2018	E-mail	No Comments
<i>Northern Cape Province</i>										
Ms	Jacoline	Mans	Chief Forester: NFA Regulations	Louisvale Road UPINGTON 8801	Tel.: 054 338 5909 E-mail: jacolinema@daff.gov.za	1 x CD Courier Waybill No.:1298110892	E-mail	E-mail: 20-11-2018	E-mail	No Comments
DEPARTMENT OF ENVIRONMENTAL AFFAIRS (Decision-Making Authority)										
			Registry - EIA Administration	Environmental House 473 Steve Biko Road PRETORIA 0002		2 x Hard Copy 2 x USBs By Hand: DELIVERY MEMO				Received
<i>Biodiversity Department</i>										
Ms	Wilma	Lutsch	Director: Biodiversity Conservation	Environmental House 473 Steve Biko Road PRETORIA 0002	Tel.: 012 399 9000 E-mail: wlutsch@environment.gov.za	1 x CD BY HAND (Upon delivery, Savannah was informed that Ms Lutsch retired and Reports to be delivered to Mr Tshitwamulomoni)	E-mail	E-mail: 20-11-2018	E-mail	No Comments
Mr	Stanley	Tshitwamulomoni			E-mail: stanleyt@environment.gov.za					
DEPARTMENT OF MINERAL RESOURCES (DMR)										
<i>Northern Cape Province</i>										
Mr	Jasper	Nieuwoudt	Regional Manager	Hopley Centre C/o Van der Stel & Van Riebeeck Streets SPRINGBOK 8240	Tel.: 027 712 8160 E-mail: jasper.nieuwoudt@dmr.gov.za	1 x CD Courier Waybill No.:1298110903	E-mail	E-mail: 20-11-2018	E-mail	No Comments
Mr	Kevin	Mutheiwana			E-mail: Mmboneni.Mutheiwana@dmr.gov.za	It was identified that Mr Nieuwoudt resigned and Mr Mutheiwana will comment on BAR)				
DEPARTMENT OF ROADS AND PUBLIC WORKS										
<i>Northern Cape Province</i>										
Ms	Jaco	Roelofse	Director: Roads	45 Schmidtsdrift Road KIMBERLEY 8301	Tel.: 05 839 2100 Cell: 076 811 6206 E-mail: roelofse.j@vodamail.co.za	1 x CD Courier Waybill No.:1298110870	E-mail	E-mail: 20-11-2018	E-mail	No Comments
DEPARTMENT OF WATER AND SANITATION										
<i>Northern Cape Province</i>										
Mr	Abe	Abrahams	Chief Director	28 Central Road Beraconsfield KIMBERLEY 8301	Ms Lindiwe Franks Tel.: 053 830 8800 Cell: 082 883 6741 E-mail: franksl@dwa.gov.za	1 x Printed Copy 1 x CD Courier Waybill No.:1298110914	E-mail	E-mail: 20-11-2018	E-mail	Received
NORTHERN CAPE DEPARTMENT OF ENVIRONMENT AND NATURE CONSERVATION										
Mr	Bryan	Fisher	Director: Environmental Quality Management	Sasko Building 90 Long Street KIMBELEY 8301	Tel.: 083 807 7431 Cell: 083 270 8323 E-mail: bfisher@ncpg.gov.za	1 x CD Courier Waybill No.:1298110881	E-mail	E-mail: 20-11-2018	E-mail	No Comments
NORTHERN CAPE PSSC OFFICE (DEPARTMENT OF RURAL DEVELOPMENT AND LAND REFORM)										

Mr	Kgotso	Moeketsi	Chief Director: PSSC	New Public Building Cnr Stead & Knight Streets KIMBERLEY 8301	Tel.: 053 830 4000/1 E-mail: kgotso.moeketsi@drdlr.gov.za	1 x CD Courier Waybill No.:1298110833	E-mail	E-mail: 20-11-2018	E-mail	Received
NAMAKWA DISTRICT MUNICIPALITY										
Mr	Chris	Fortuin	Municipal Manager	Hendrik J Visser Building, Van Riebeeck Street SPRINGBOK	Ms Christene Nel Personal Assistant to the Municipal Manager Tel.: 027 712 8000 E-mail: chrif@namakwa-dm.gov.za	1 x CD Courier Waybill No.:1298110866	E-mail	E-mail: 20-11-2018	E-mail	No Comments
Nama Khoi Local Municipality										
Ms	Samantha	Titus	Municipal Manager	No 4 Namakwa Street SPRINGBOK 8240	Tel.: 027 718 8100 E-mail: municipal.manager@namakhoi.gov.za	1 x CD Courier Waybill No.:1298110855	E-mail	E-mail: 20-11-2018	E-mail	No Comments
NATIONAL ENERGY REGULATOR OF SOUTH AFRICA (NERSA)										
Mr	Tamai	Hore	Senior Engineer: Generation Licensing	Kulawula House 526 Madiba Street ARCADIA 0083	Tel.: 012 401 4053 E-mail: tamai.hore@nersa.org.za	1 x CD Courier Waybill No.:1298110844	E-mail	E-mail: 20-11-2018		No Comments
SOUTH AFRICA HERITAGE RESOURCES AGENCY (SAHRA)										
UPLOAD ONTO SAHRIS Case ID: 13065										Received

TOTAL HARD COPIES 3
TOTAL USBs 2
TOTAL CDs 12

TITLE	NAME	SURNAME	POSITION	DELIVERY ADDRESS	CONTACT DETAILS	REPORT FORMAT & METHOD OF DISTRIBUTION	COMMENTS (Follow-ups & confirmation of receipt)			
							1ST REMINDER 16 Nov 2018	ADDITIONAL	2ND REMINDER 23 Nov 2018	COMMENTS RECEIVED
AGRI SA										
<i>Province</i>										
Mr	Nicol	Jansen	President: Agri Northern Cape	No 2 Bebington Street Monument Heights KIMBERLEY 8301	Tel.: 053 82 9595 E-mail: henning@agrink.co.za	CD Courier Waybill no.:1298110811	E-mail	E-mail: 20-11-2018	E-mail	No Comments
<i>Sandveld Farmers' Union</i>										
Mrs	Meisie	Engelbrecht	Chairperson	CD TO BE DELIVERED AT FGM	Cell: 083 458 2190 E-mail: meisie@3i.co.za	CD TO BE DELIVERED AT FGM	E-mail	E-mail: 20-11-2018	E-mail	Received
AIR TRAFFIC AND NAVIGATION SERVICES (ATNS)										
Mr	Simphiwe	Masilela	Obstacle Evaluator	Eastgate Office Park Block C South Boulevard Road BRUMA 2198	Tel.: 011 607 1228 E-mail: simphiwem@atns.co.za	1 x CD Courier Waybill No.:12988110822	E-mail	E-mail: 20-11-2018	E-mail	Received
BIRDLIFE SOUTH AFRICA										
Ms	Samantha	Ralston-Paton	Birds & Renewable Energy Manager	Room A3 CBC Building Kirstenbosch Botanical Gardens Rhodes Drive CAPE TOWN 7735	Tel.: 011 789 3948 Cell: 083 673 3948 E-mail: energy@birdlife.org.za	1 x CD Courier Waybill No.:1298110796	E-mail	E-mail: 20-11-2018	E-mail	Received
ENDANGERED WILDLIFE TRUST										
Mr	Constant	Hoogstad	Programme Manager	Pinelands Office Park Ardeer MODDERFONTEIN 1609		1 x CD Courier Waybill No.:1298110800				No Comments
ESKOM HOLDINGS SOC LTD										
<i>Head Office</i>										
Mr	John	Geeringh	Senior Environmental Advisor	COLLECT AT SAVANNAH ENVIRONMENTAL OFFICES	Tel.: 011 516 7233 Cell: 083 632 7663 E-mail: john.geeringh@eskom.co.za	1 x CD (hand delivered)	E-mail	E-mail: 20-11-2018	E-mail	Received
<i>Northern Cape Province</i>										
Ms	Andrea	Van Gensen	Regional Environmental Manager	120 Henry Street BLOEMFONTEIN 9301	Tel.: 083 830 5775 Cell: 082 482 7579 E-mail: vangensen@eskom.co.za	1 x CD Courier Waybill No.:1298110774	E-mail	E-mail: 20-11-2018	E-mail	No Comments
SENTECH										
Mr	Marlon	Fennis	Executive: Operations	Sender Technology Park Octave Street HONEYDEW 2040	Tel.: 0860 736 832 E-mail: info@sentech.co.za	1 x CD Courier Waybill No.:1298110785	E-mail	E-mail: 20-11-2018	E-mail	No Comments
SOUTH AFRICA CIVIL AVIATION AUTHORITY (SA CAA)										
Ms	Lizell	Stoh	Obstacle Specialist: Aviation Obstacle and GIS	Ikhaya Lokundiza Building 16 Treur Close Waterfall Park MIDRAND 1682	Tel.: 011 545 1323 Cell: 083 461 6660 E-mail: stroh@caa.co.za	1 x CD Courier Waybill No.:1298111054	E-mail	E-mail: 20-11-2018	E-mail	Received
SOUTH AFRICA NATIONAL PARKS (SANPARKS)										

Mr	Michael	Knight	Team Leader: Park Planning & Consolidation Task Team	643 Leyds Street PRETORIA 0002	Tel.: 012 426 5066 E-mail: mike.knight@sanparks.org	1 x CD Courier Waybill No.:129811043	E-mail	E-mail: 20-11-2018	E-mail	No Comments
Mr	Howard	Hendricks			Tel.: 012 426 5066 E-mail: mike.tebogo.mohudi@sanparks.org (Secretary to Mr Hendricks)	1 x CD Courier Waybill No.:129811043 (Savannah was infomed that Thobogo Mohudi will review report)	E-mail	E-mail: 20-11-2018 & Telephone follow-up on 21-11-2018	E-mail	No Comments
SOUTH AFRICAN NATIONAL ROADS AGENCY LTD (SANRAL)										
Ms	Nicole	Abrahams	Environmental Coordinator: Western Region	1 Havenga Street Oakdale BELLEVILLE 7530	Tel.: 021 857 4602 E-mail: abrahams@nra.co.za	1 x CD Courier Waybill No.:129811076	E-mail	E-mail: 20-11-2018	E-mail	No Comments
SOUTH AFRICAN RADIO ASTRONOMY OBSERVATORY (SKA emalgated)										
Dr	Adriaan	Tiplady	Manager: Site Categorisation	1st Floor 17 Baker Street ROSEBANK 2196	Tel.: 011 442 2434 Cell: 072 372 0134 E-mail: atiplady@ska.ac.za	1 x CD Courier Waybill No.:129811065	E-mail	E-mail: 20-11-2018	E-mail	Received
Mr	Busang	Sethole	Analyst: Spectrum and Telecoms		Tel.: 011 268 3449 E-mail: bsethole@ska.ac.za	(SKA SA merged with Marteebeeshoek Radio Astronomy Observatory (HartRAO) to form SARAO)				
SOUTH AFRICA BAT ASSESSMENT ASSOCIATION (SABAA)										
Ms	Katie	MacEwan	Manager: Nature & Conservation	126 Ballyclare Dirve MORNING SIDE EXT 40 2196	Tel.: 011 787 7400 Cell: 079 175 1758 E-mail: kate@iws-sa.co.za	1 x CD Courier Waybill No.:129811021	E-mail	E-mail: 20-11-2018	E-mail	Received

TOTAL HARD COPIES

0

TOTAL CDs

15

24 October 2018

Attention: EIA Admin
Department of Environmental Affairs
Cnr Steve Biko and Soutpansberg Road
Pretoria
0001

**ENVIRONMENTAL BASIC ASSESSMENT AND
PUBLIC PARTICIPATION PROCESS**

NAMAS WIND FARM, NORTHERN CAPE PROVINCE

BASIC ASSESSMENT REPORT FOR REVIEW

Dear Registry/EIA Admin,

Savannah Environmental has been appointed to undertake the Basic Assessment Process for the Namas Wind Farm located within the Springbok Renewable energy Development Zone (REDZ), Northern Cape Province.

A pre-application meeting was held with the DEA on 14 May 2018. The following DEA officials attended the pre-application meeting for the wind farm:

NAME	ORGANISATION
Coenrad Agenbach	Department of Environmental Affairs
Adika Rambally	Department of Environmental Affairs
Mahlatse Shubane	Department of Environmental Affairs
Herman Alberts	Department of Environmental Affairs
Karen Jodas	Savannah Environmental
Lisa Opperman	Savannah Environmental
Davin Chown	Genesis Eco-Energy Developments

Please find herewith attached the Basic Assessment (2 hard copies and 1 USB) report for review. The electronic copy of the application for Environmental Authorisation is included on the USB. The 30-day review period for the report is from **24 October 2018 – 23 November 2018**. Please submit your written comments by **23 November 2018**.

Please contact me with any queries in this regard, and advise should the Department require any additional information pertaining to this project.

Kind regards

LISA OPPERMAN
SAVANNAH ENVIRONMENTAL
(lisa.o@savannahsa.com)

MEMO

DATE:	24 October 2018
TO:	National Department of Environmental Affairs
ATT:	Registry – EIA Admin
REFERENCE:	N/A – New Application
OUR REFERENCE:	SE1836

Please acknowledge receipt of the following for the proposed Zonnequa Wind Farm, Northern Cape Province:

- 2 Hard Copies of the new application for Environmental Authorisation
- 2 Hard Copies of the Basic Assessment Report for Review
- X1 USB with the electronic copy of the Application and the Basic Assessment Report

NAME OF RECIPIENT:

SESS LETSABE

SIGNATURE:

ENVIRONMENTAL AFFAIRS INT ENV AUTH
2018 -10- 24
SIGN: <i>[Signature]</i>

DATE RECEIVED:

STAMP:

22 October 2018

Ms Jacoline Mans
Chief Forester: NFA Regulations
Department of Agriculture, Forestry and Fisheries
Louisvale Road
UPINGTON 8801

Per Courier

Dear Ms Mans,

**BASIC ASSESSMENT AND PUBLIC PARTICIPATION PROCESSES FOR THE DEVELOPMENT OF THE
PROPOSED NAMAS AND ZONNEQUA WIND FARM PROJECTS NEAR KLEINSEE IN THE NORTHERN CAPE
PROVINCE**

NOTICE OF AVAILABILITY OF BASIC ASSESSMENT REPORTS FOR REVIEW AND WRITTEN COMMENTS

Genesis Namas Wind (Pty) Ltd is proposing two (2) 140MW wind farms and associated infrastructures on sites located approximately 20km south-east of Kleinsee. The wind farms are known as the **Namas Wind Farm** and **Zonnequa Wind Farm** and are located within the Nama Khoi Local Municipality and the Namakwa District Municipality in the Northern Cape Province.

This letter serves to inform you that the Basic Assessment Reports (BARs) are available for your Department's review and written comments, and a CD containing the BARs is included in this envelope.

Please note that the BARs' review period is from **Wednesday, 24 October** to **Friday, 23 November 2018** and we are looking forward receiving your Department's written comment on the BARs before or on the closing date of the review period.

Kind regards

Nicolene Venter
Public Participation and Social Consultant
Savannah Environmental



DAWN WING
global express

a division of **dpd LASER**

0861 223 224
www.dawnwing.co.za

WAYBILL

S202639



1298110892

FROM: SAVANNAH ENVIRO S A		HAZARDOUS YES <input type="checkbox"/> NO <input type="checkbox"/>		Filing Ref: 1836	
Address		PARCEL DETAILS		SERVICE (mark only one)	
1ST FLOOR, BLOCK 2		No. of Parcels: 1		Overnight Express <input checked="" type="checkbox"/>	
5 WOODLANDS DRIVE		Dimensions (cm): 30 20 1		Economy Cargo <input type="checkbox"/>	
WOODMEAD		Postal Code must be filled in: 2128		International Documents <input type="checkbox"/>	
WOODMEAD		City/Country: LISA		Special Instructions	
Senders Name: LISA		Phone No: 011 6563237		Dawn Delivery (P.O. / Time Required) <input type="checkbox"/>	
TO: Dep. Agriculture, forestry and fisheries		Street Address (P.O. Box Addresses not accepted): Louisvale Road		Sunday / Public Holiday <input type="checkbox"/>	
City/Country: Uppington		Postal Code must be filled in: 8801		After Hours <input type="checkbox"/>	
Receiver's Name: Jacobus Mans		Phone No: 0543385909		Condition of Delivery <input type="checkbox"/>	
By signing this waybill the sender is concluding a contract with Dawn Wing and warrants his authority to enter into this contract and to bind the entity, which herein represents. The terms and conditions of this contract are contained on the reverse of the sender's copy.		Date: 22/10/18		Risk for special liability option (for non-included articles) <input type="checkbox"/>	
Senders Name: LISA		Date: 22/10/18		Customs Value: ZAR	
Signature: [Signature]		Time: 10:18		Account to be Debited: JB6925	
Date: 22/10/18		Time: 10:18		Sender's Ref. / Bag No.	
Signature: [Signature]		Time: 10:18		RECEIVED IN GOOD ORDER AND CONDITION	
Date: 22/10/18		Time: 10:18		Receiver's Signature: [Signature]	
Signature: [Signature]		Time: 10:18		Print Name: L. Schepers	
Date: 22/10/18		Time: 10:18		Date: 22/10/18	
Signature: [Signature]		Time: 10:18		Time: 10:18	

PROOF OF DELIVERY

*All weight and dimensions subject to verification through electronic weight and dimension machine (SABS calibrated)

DAWN WING
A Division of DPD Laser Express Logistics (Pty) Ltd
Reg. No. 2008/0333307 VAT No. 4690235280
FSP NO 32009

11/05/2016 FMI/UC2009 FMI AFRICA (PTY) LTD Tel: (011) 228-1300

Sender to complete yellow areas only

22 October 2018

Mr Nicol Jansen
President: Agri Northern Cape
No 2 Bebington Street
Monument Heights
KIMBERLEY 8301

Per Courier

Dear Mr Jansen,

**BASIC ASSESSMENT AND PUBLIC PARTICIPATION PROCESSES FOR THE DEVELOPMENT OF THE
PROPOSED NAMAS AND ZONNEQUA WIND FARM PROJECTS NEAR KLEINSEE IN THE NORTHERN CAPE
PROVINCE**

NOTICE OF AVAILABILITY OF BASIC ASSESSMENT REPORTS FOR REVIEW AND WRITTEN COMMENTS

Genesis Namas Wind (Pty) Ltd is proposing two (2) 140MW wind farms and associated infrastructures on sites located approximately 20km south-east of Kleinsee. The wind farms are known as the **Namas Wind Farm** and **Zonnequa Wind Farm** and are located within the Nama Khoi Local Municipality and the Namakwa District Municipality in the Northern Cape Province.

This letter serves to inform you that the Basic Assessment Reports (BARs) are available for your Organisation's review and written comments, and a CD containing the BARs is included in this envelope.

Please note that the BARs' review period is from **Wednesday, 24 October** to **Friday, 23 November 2018** and we are looking forward receiving your Organisation's written comment on the BARs before or on the closing date of the review period.

Kind regards

Nicolene Venter
Public Participation and Social Consultant
Savannah Environmental



0861 223 224
www.dawnwing.co.za

a division of DPD LASER

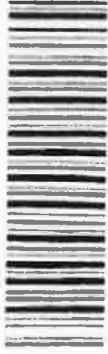

1298110811

WAYBILL

FROM: SAVANNAH ENVIRO S A		HAZARDOUS		Filing Ref: 1836	
Address		YES NO		SERVICE (mark only one)	
1ST FLOOR, BLOCK 2		No. of Parcels		Overnight Express <input checked="" type="checkbox"/>	
5 WOODLANDS DRIVE		Weight (kg) & Cts Apply		Express Cash <input type="checkbox"/>	
WOODMEAD		Dimensions (cm)		Domestic Non-Dutiable <input type="checkbox"/>	
WOODMEAD		30 20 1		International Road Freight <input type="checkbox"/>	
City/Country		Postal Code must be filled in		SPECIAL INSTRUCTIONS	
LISA		2128		Dawn Delivery Instructions <input type="checkbox"/>	
TO: Agri SA - Northern Cape		Sender's Name		After Hours <input type="checkbox"/>	
Street Address (P.O. Box addresses not accepted)		011 6563237		Sunday Public Holiday <input type="checkbox"/>	
No 2 Bebington's Moor		City/Country		Collection or Delivery <input type="checkbox"/>	
Monument Heights		Kimberley		Tick to select limited liability option (to a maximum amount of R50 000) for non-excluded articles	
City/Country		Postal Code must be filled in		Customs Value ZAR	
NICOL Jansen		8301		Account to be Credited	
Receiver's Name		053 829595		JB6925	
By signing this waybill the sender is acknowledging & certifies with Dawn Wing and warrants his authority to enter into this contract and to bind his estate, which he/she represents. The terms and conditions of this contract are contained on the reverse of this waybill.		Date		Sender's Ref / Bag No.	
SIGNED BY		22/10/18		RECEIVED IN GOOD ORDER AND CONDITION	
LISA AN		Time		Receiver's Signature	
SIGNED BY		22/10/18		A.A.	
LISA AN		Time		Print Name	
SIGNED BY		PAETA		Henning	
LISA AN		Time		M. ylboumgh	
SIGNED BY		PAETA		Date	
LISA AN		Time		23/10/18 11:50	
SIGNED BY		PAETA		Date	
LISA AN		Time		23/10/18 11:50	

Sender to complete yellow areas only

DAWN WING
A Division of DPD Laser Express Logistics (Pty) Ltd
Reg. No. 2006003353-07 VAT No. 4690235280
FSP NO. 10099

*All weight and dimensions subject to verification through electronic weight and dimension machine (SABS calibrated)

PROOF OF DELIVERY

11.05.2015 FMA/2009 (M) AFRIKA (PTY) LTD TR- (011) 2291300

22 October 2018

Mr Simphiwe Masilela
Obstacle Evaluator
Eastgate Office Park
Block C
South Boulevard Road
BRUMA 2198

Per Courier

Dear Mr Masilela,

**BASIC ASSESSMENT AND PUBLIC PARTICIPATION PROCESSES FOR THE DEVELOPMENT OF THE
PROPOSED NAMAS AND ZONNEQUA WIND FARM PROJECTS NEAR KLEINSEE IN THE NORTHERN CAPE
PROVINCE**

NOTICE OF AVAILABILITY OF BASIC ASSESSMENT REPORTS FOR REVIEW AND WRITTEN COMMENTS

Genesis Namas Wind (Pty) Ltd is proposing two (2) 140MW wind farms and associated infrastructures on sites located approximately 20km south-east of Kleinsee. The wind farms are known as the **Namas Wind Farm** and **Zonnequa Wind Farm** and are located within the Nama Khoi Local Municipality and the Namakwa District Municipality in the Northern Cape Province.

This letter serves to inform you that the Basic Assessment Reports (BARs) are available for your Company's review and written comments, and a CD containing the BARs is included in this envelope.

Please note that the BARs' review period is from **Wednesday, 24 October** to **Friday, 23 November 2018** and we are looking forward receiving your Company's written comment on the BARs before or on the closing date of the review period.

Kind regards

Nicolene Venter
Public Participation and Social Consultant
Savannah Environmental



0861 223 224
www.dawnwing.co.za

WAYBILL

1298110822



FROM: SAVANNAH ENVIRO S A Address: 1ST FLOOR, BLOCK 2 5 WOODLANDS DRIVE WOODMEAD City/Country: WOODMEAD Postal Code: 2128 Senders Name: LISA Tel: 011 6563237		TO: Air Traffic and Navigation CATINS Street Address: (P.O. Box Addresses not accepted) Eastgate Office Park, block C South Boulevard Road. City/Country: Bruma Postal Code: 2198 Receiver's Name: Simphine Masilek Tel: 011 6071228		Contents: CD HAZARDOUS: YES <input type="checkbox"/> NO <input checked="" type="checkbox"/> # YES, SEE INSTRUCTIONS PARCEL DETAILS No. of Parcels: 1 Vol(kg): T's & C's Apply* Dimensions (cm): 30 x 20 x 1 Mass(kg): T's & C's Apply* 0.05		Filing Ref: 1836 SERVICE (mark only one) Overnight Express Economy Cargo Domestic Road Freight International Air Freight International Documents International Road Freight SPECIAL INSTRUCTIONS Saturday Delivery Collection Dawn Delivery 9-100 / Time Required After Hours Sunday / Public Holiday Confirmation Delivery Tick to select limited liability option (to a maximum amount of R50 000) for non-excluded articles Customs Value ZAR Value of Article ZAR Account to be Debited: JB6925 Sender's Ref. / Bag No.	
Dawn Wing reserves the right to mark the service "Overnight Express" should no service level be selected Terms strictly 30 days from date of statement CASH AMOUNT R PAID YES NO Special Instructions				RECEIVED IN GOOD ORDER AND CONDITION Receivers Signature: [Signature] Print Name: Nicks Date: 23/10/18 Time: 10:10 Date: 23/10/18 Time: 10:10			

Sender to complete yellow areas only

*All weight and dimensions subject to verification through electronic weight and dimension machine (SABS calibrated)

PROOF OF DELIVERY

DAWN WING
 A Division of DPD Laser Express Logistics (Pty) Ltd
 Reg. No. 2006033333/07 VAT No. 4690235280
 FSP NO 32009

22 October 2018

Ms Samantha Ralston-Paton
Birds & Renewable Energy Manager
BirdLife South Africa
Room A3, CBC Building
Kirstenbosch Botanical Gardens
Roades Drive
CAPE TOWN 7735

Per Courier

Dear Ms Ralston-Paton,

**BASIC ASSESSMENT AND PUBLIC PARTICIPATION PROCESSES FOR THE DEVELOPMENT OF THE
PROPOSED NAMAS AND ZONNEQUA WIND FARM PROJECTS NEAR KLEINSEE IN THE NORTHERN CAPE
PROVINCE**

NOTICE OF AVAILABILITY OF BASIC ASSESSMENT REPORTS FOR REVIEW AND WRITTEN COMMENTS

Genesis Namas Wind (Pty) Ltd is proposing two (2) 140MW wind farms and associated infrastructures on sites located approximately 20km south-east of Kleinsee. The wind farms are known as the **Namas Wind Farm** and **Zonnequa Wind Farm** and are located within the Nama Khoi Local Municipality and the Namakwa District Municipality in the Northern Cape Province.

This letter serves to inform you that the Basic Assessment Reports (BARs) are available for your Organisation's review and written comments, and a CD containing the BARs is included in this envelope.

Please note that the BARs' review period is from **Wednesday, 24 October** to **Friday, 23 November 2018** and we are looking forward receiving your Organisation's written comment on the BARs before or on the closing date of the review period.

Kind regards

Nicolene Venter
Public Participation and Social Consultant
Savannah Environmental



0861 223 224
www.dawnwing.co.za

WAYBILL

1298111076



FROM: SAVANNAH ENVIRO S A Address		TO: SA National Roads Agency Street Address (P.O. Box Addresses not accepted) 1 Havena Street Oakdale	
City/Country WOODMEAD		City/Country Bellville	
Senders Name LISA		Receiver's Name Nicole Anthonio	
Postal Code must be filled in 2128		Postal Code must be filled in 7530	
Phone No. 011 6563237		Phone No. 021 857 4602	
Date 22/10/18		Date 22/10/18	
Time 15:00		Time 15:00	
Signature <i>[Signature]</i>		Signature <i>[Signature]</i>	
Collecting By Counter <i>[Signature]</i>		Collecting By Counter <i>[Signature]</i>	
By signing this waybill the sender is concluding a contract with Dawn Wing and warrants his authority to enter into this contract and to bind the entity, which he/she represents. The terms and conditions of this contract are contained on the reverse of the sender's copy.		By signing this waybill the sender is concluding a contract with Dawn Wing and warrants his authority to enter into this contract and to bind the entity, which he/she represents. The terms and conditions of this contract are contained on the reverse of the sender's copy.	

HAZARDOUS YES <input type="checkbox"/> NO <input type="checkbox"/>		Contents CD	
PARCEL DETAILS		SERVICE (mark only one)	
No. of Parcels 1	Vol (kg)-T's & C's Apply 0,05	Mass (kg)-T's & C's Apply 0,05	Filing Ref: 1836
Dimensions (cm) 30 x 20 x 1			
SPECIAL INSTRUCTIONS		RECEIVED IN GOOD ORDER AND CONDITION	
Dawn Wing reserves the right to mark the service "Overnight Express" should no service level be selected		Receivers Signature: <i>[Signature]</i>	
Terms strictly 30 days from date of statement		Print Name: <i>[Signature]</i>	
CASH AMOUNT R PAID YES NO		Date: 23/10/18 Time: 8:15	
Special Instructions		PROOF OF DELIVERY	

DAWN WING
A Division of DPD Laser Express Logistics (Pty) Ltd
Reg. No. 2006/0335307 VAT No. 4690235280
FSP NO 32009

*All weight and dimensions subject to verification through electronic weight and dimension machine (SABS calibrated)

11/05/2016 FMA/2009 FMI AFRICA (PTY) LTD Tel: (011) 228-1300

Sender to complete yellow areas only

22 October 2018

Ms Lizell Ströh
Obstacle Specialist: Aviation Obstacle and Task Team
SA Civil Aviation Authority
Ikhaya Lokundiza Building
16 Treur Close
Waterfall Park
MIDRAND 1682

Per Courier

Dear Ms Ströh,

**BASIC ASSESSMENT AND PUBLIC PARTICIPATION PROCESSES FOR THE DEVELOPMENT OF THE
PROPOSED NAMAS AND ZONNEQUA WIND FARM PROJECTS NEAR KLEINSEE IN THE NORTHERN CAPE
PROVINCE**

NOTICE OF AVAILABILITY OF BASIC ASSESSMENT REPORTS FOR REVIEW AND WRITTEN COMMENTS

Genesis Namas Wind (Pty) Ltd is proposing two (2) 140MW wind farms and associated infrastructures on sites located approximately 20km south-east of Kleinsee. The wind farms are known as the **Namas Wind Farm** and **Zonnequa Wind Farm** and are located within the Nama Khoi Local Municipality and the Namakwa District Municipality in the Northern Cape Province.

This letter serves to inform you that the Basic Assessment Reports (BARs) are available for your Company's review and written comments, and a CD containing the BARs is included in this envelope.

Please note that the BARs' review period is from **Wednesday, 24 October** to **Friday, 23 November 2018** and we are looking forward receiving your Company's written comment on the BARs before or on the closing date of the review period.

Kind regards

Nicolene Venter
Public Participation and Social Consultant
Savannah Environmental

Waybill Summary Details

Waybill Number :	1298111054	Waybill Date :	2018-10-22
Waybill Status :	POD RECEIVED	Service :	%%ServiceType%%
From :	JOHANNESBURG CENTRAL AREAS	To :	JOHANNESBURG CENTRAL AREAS
Sender :	SAVANNAH ENVIRONMENT 5 WOODLANDS DRIVE OFFICE PARK CNR WOODLANDS DR & WESTERN SERVICE ROAD WOODMEAD EXT 2191	Receiver :	SA CIVIL AVIATION IKHAYA LOKUNDISA BLDG 16 TREUER CLOSE WATERFALL PARK MIDRAND 1885
Contact :	%%SenContact%%	Contact :	LIZELL
Telephone :	%%SenTelNo%%	Telephone :	0115451323
Cellphone :	%%SenCelNo%%	Cellphone :	%%RecCelNo%%
Customer Ref :	%%InvoiceRefNo%%	Collection No :	
Total Parcels :	1	Total Mass :	0.10
Total Volume :	0.24	Value :	

Proof of Delivery

Received By	Date Received	Time	Parcels
LIZELL LIZELL	2018-10-23	09:01	1

Detailed track and trace

Event	Location	Date	Time	Additional Information
SHIPMENT RECEIVED BY HUB	JNB	2018-10-23	10:58	
MASS DIMENSION VERIFICATION	JNB	2018-10-23	10:58	
POD RECEIVED / DELIVERED	JNB	2018-10-23	13:15	

[Back](#)

22 October 2018

Mr Mushudu Marubini
Department of Agriculture, Forestry and Fisheries
Office 270
Delpen Building
Cnr Annie Botha & Union Streets
PRETORIA 0002

Per Courier

Dear Mr Marubini,

**BASIC ASSESSMENT AND PUBLIC PARTICIPATION PROCESSES FOR THE DEVELOPMENT OF THE
PROPOSED NAMAS AND ZONNEQUA WIND FARM PROJECTS NEAR KLEINSEE IN THE NORTHERN CAPE
PROVINCE**

NOTICE OF AVAILABILITY OF BASIC ASSESSMENT REPORTS FOR REVIEW AND WRITTEN COMMENTS

Genesis Namas Wind (Pty) Ltd is proposing TWO (2) 140MW wind farms and associated infrastructures on sites located approximately 20km south-east of Kleinsee. The wind farms are known as the **Namas Wind Farm** and **Zonnequa Wind Farm** and are located within the Nama Khoi Local Municipality and the Namakwa District Municipality in the Northern Cape Province.

This letter serves to inform you that the Basic Assessment Reports (BARs) are available for your Department's review and written comments, and a CD containing the BARs is included in this envelope.

Please note that the BARs' review period is from **Wednesday, 24 October** to **Friday, 23 November 2018** and we are looking forward receiving your Department's written comment on the BARs before or on the closing date of the review period.

Kind regards

Nicolene Venter
Public Participation and Social Consultant
Savannah Environmental



global express

a division of dpd LASER

0861 223 224

www.dawnwing.co.za



1298110925

WAYBILL

FROM: SAVANNAH ENVIRO S A		Contents CD		HAZARDOUS YES NO		Filing Ref: 1836	
Address 1ST FLOOR. BLOCK 2 5 WOODLANDS DRIVE WOODMEAD		No. of Parcels 1		Mass(kg)-T's & C's Apply 0,05		SERVICE (mark only one)	
City/Country WOODMEAD		Dimensions (cm) 30 20 1		International Documents		Economy Cargo	
Postal Code must be filled in 2128		Dawn Delivery Required		International Documents		Domestic Road Freight	
Senders Name LISA		After Hours		International Documents		International Road Freight	
TO: Dep Agriculture, Forestry + Fisheries		Confirmation of Delivery		International Documents		SPECIAL INSTRUCTIONS	
Street Address (P.O. Box Addresses not accepted) Office 270, Delphien Building Car Amie Botha & Unioni Sheeb		Value of Article ZAR		International Documents		SPECIAL INSTRUCTIONS	
City/Country Pretoria		Account to be Debited JB6925		International Documents		SPECIAL INSTRUCTIONS	
Postal Code must be filled in 0002		Sender's Ref. / Bag No.		International Documents		SPECIAL INSTRUCTIONS	
Receiver's Name Mushudu Mambini		Dawn Wing reserves the right to mark the service "Overnight Express" should no service level be selected		International Documents		SPECIAL INSTRUCTIONS	
Date 22/10/18		Terms strictly 30 days from date of statement		International Documents		SPECIAL INSTRUCTIONS	
Time 14:18		CASH AMOUNT PAID YES NO		International Documents		SPECIAL INSTRUCTIONS	
Collected By Courier PHELA		Special Instructions		International Documents		SPECIAL INSTRUCTIONS	
Signature LISA		RECEIVED IN GOOD ORDER AND IN CONDITION		International Documents		SPECIAL INSTRUCTIONS	
Date 22/10/18		Receiver's Signature B. Botha		International Documents		SPECIAL INSTRUCTIONS	
Time 14:18		Print Name B. Botha		International Documents		SPECIAL INSTRUCTIONS	
Date 22/10/18		Date 22/10/18		International Documents		SPECIAL INSTRUCTIONS	
Time 14:18		Time 14:18		International Documents		SPECIAL INSTRUCTIONS	

Sender to complete yellow areas only

DAWN WING

A Division of DPD Laser Express Logistics (Pty) Ltd

Reg. No. 200603333/07 VAT No. 4690235280

FSP NO 32009

*All weight and dimensions subject to verification through electronic weight and dimension machine (SABS calibrated)

PROOF OF DELIVERY

11/05/2016 FMI/2008 FMI AFRICA (PTY) LTD Tel: (011) 228-1300

22 October 2018

Ms Wilma Lutsch
Director: Biodiversity Conservation
Department of Environmental Affairs
Environmental House
473 Steve Biko Road
PRETORIA 0002

By Hand

Dear Ms Lutsch,

**BASIC ASSESSMENT AND PUBLIC PARTICIPATION PROCESSES FOR THE DEVELOPMENT OF THE
PROPOSED NAMAS AND ZONNEQUA WIND FARM PROJECTS NEAR KLEINSEE IN THE NORTHERN CAPE
PROVINCE**

NOTICE OF AVAILABILITY OF BASIC ASSESSMENT REPORTS FOR REVIEW AND WRITTEN COMMENTS

Genesis Namas Wind (Pty) Ltd is proposing TWO (2) 140MW wind farms and associated infrastructures on sites located approximately 20km south-east of Kleinsee. The wind farms are known as the **Namas Wind Farm** and **Zonnequa Wind Farm** and are located within the Nama Khoi Local Municipality and the Namakwa District Municipality in the Northern Cape Province.

This letter serves to inform you that the Basic Assessment Reports (BARs) are available for your Department's review and written comments, and a CD containing the BARs is included in this envelope.

Please note that the BARs' review period is from **Wednesday, 24 October** to **Friday, 23 November 2018** and we are looking forward receiving your Department's written comment on the BARs before or on the closing date of the review period.

Kind regards

Nicolene Venter
Public Participation and Social Consultant
Savannah Environmental

MEMO

DATE:	24 October 2018
TO:	Department of Environmental Affairs
ATT:	Ms Wilma Lutsch (Director: Biodiversity Conservation)
REFERENCE:	No DEA reference number yet
OUR REFERENCE:	SE1836

Please acknowledge receipt of x1 CD with the Basic Assessment Report for review for the Namas Wind Farm and x1 CD with the Basic Assessment Report for review for the Zonnequa Wind Farm, Northern Cape Province.

NAME OF RECIPIENT:

DEBS RETHABE

SIGNATURE:

ENVIRONMENTAL AFFAIRS
INT ENV AUTH

DATE RECEIVED:

2018 -10- 24

STAMP:

SIGN: *[Signature]*

22 October 2018

Mr Chris Fortuin
Municipal Manager
Namakwa District Municipality
Hendrik J Visser Building
Van Riebeeck Street
SPRINGBOK 8240

Per Courier

Dear Mr Fortuin,

**BASIC ASSESSMENT AND PUBLIC PARTICIPATION PROCESSES FOR THE DEVELOPMENT OF THE
PROPOSED NAMAS AND ZONNEQUA WIND FARM PROJECTS NEAR KLEINSEE IN THE NORTHERN CAPE
PROVINCE**

NOTICE OF AVAILABILITY OF BASIC ASSESSMENT REPORTS FOR REVIEW AND WRITTEN COMMENTS

Genesis Namas Wind (Pty) Ltd is proposing two (2) 140MW wind farms and associated infrastructures on sites located approximately 20km south-east of Kleinsee. The wind farms are known as the **Namas Wind Farm** and **Zonnequa Wind Farm** and are located within the Nama Khoi Local Municipality and the Namakwa District Municipality in the Northern Cape Province.

This letter serves to inform you that the Basic Assessment Reports (BARs) are available for Nama Khoi Local Municipality's review and written comments, and a CD containing the BARs is included in this envelope.

Please note that the BARs' review period is from **Wednesday, 24 October** to **Friday, 23 November 2018** and we are looking forward receiving Nama Khoi Local Municipality's written comment on the BARs before or on the closing date of the review period.

Kind regards

Nicolene Venter
Public Participation and Social Consultant
Savannah Environmental



0861 223 224

www.dawnwing.co.za



WAYBILL

FROM: SAVANNAH ENVIRO S A 1ST FLOOR, BLOCK 2 5 WOODLANDS DRIVE WOODMEAD Woodmead 2128 LISA 011 6563237		OUR INFO: CD HAZARDOUS: YES NO Filing Ref: 836
TO: Namakwa District Municipality Hendrik J Visser Building Van Riebeeck Street Springbok 8240 Chris Fortuin 027 712 8000		PARCEL DETAILS (P.O. NO. / QTY. / DIMENSIONS (CM)) 1 C/O'S 30 20 1
Special Instructions: Dawn Wing reserves the right to mark the service "Overnight Express" should no service level be selected.		SPECIAL INSTRUCTIONS: RECEIVED IN GOOD ORDER AND CONDITION Receiver's Signature: [Signature] Print Name: Not clear Date: 24/10/18 Time: 8:19
Sender's Name: Chris Fortuin Sender's Address: Springbok 8240 Sender's Phone: 027 712 8000		TERMS: Terms strictly 30 days from date of statement CASH AMOUNT: R [] PAID: YES NO Special Instructions:
Shippers Memo: LISA Date: 22/10/18 Collected By Courier: [Signature] Date: 22/10/18		

Sender to complete yellow areas only

DAWN WING
 Division of DPD Laser Express Logistics (Pty) Ltd
 Reg. No. 2005/033353/07 VAT No. 4680235780
 011 223 2209

*All weight and dimensions subject to verification through electronic weight and dimension machine (SABS calibrated)

PROOF OF DELIVERY
 11/02/2018 01:42:009 FUMAFRISA (PT) LTD 011 223 1300

22 October 2018

Mr Jasper Nieuwoudt
Regional Managers
Department of Mineral Resources
Hopley Centre
Cnr Van der Stel & Van Riebeeck Streets
SPRINGBOK 8240

Per Courier

Dear Mr Nieuwoudt,

**BASIC ASSESSMENT AND PUBLIC PARTICIPATION PROCESSES FOR THE DEVELOPMENT OF THE
PROPOSED NAMAS AND ZONNEQUA WIND FARM PROJECTS NEAR KLEINSEE IN THE NORTHERN CAPE
PROVINCE**

NOTICE OF AVAILABILITY OF BASIC ASSESSMENT REPORTS FOR REVIEW AND WRITTEN COMMENTS

Genesis Namas Wind (Pty) Ltd is proposing two (2) 140MW wind farms and associated infrastructures on sites located approximately 20km south-east of Kleinsee. The wind farms are known as the **Namas Wind Farm** and **Zonnequa Wind Farm** and are located within the Nama Khoi Local Municipality and the Namakwa District Municipality in the Northern Cape Province.

This letter serves to inform you that the Basic Assessment Reports (BARs) are available for your Department's review and written comments, and a CD containing the BARs is included in this envelope.

Please note that the BARs' review period is from **Wednesday, 24 October** to **Friday, 23 November 2018** and we are looking forward receiving your Department's written comment on the BARs before or on the closing date of the review period.

Kind regards

Nicolene Venter
Public Participation and Social Consultant
Savannah Environmental



0861 223 224
www.dawnwing.co.za



1298110903

Waybill

HAZARDOUS YES NO

Filing Ref 1836

Contents CD

FROM: SAVANNAH ENVIRO S A

1ST FLOOR, BLOCK 2
5 WOODLANDS DRIVE
WOODMEAD

Postcode 2128

City/Town WOODMEAD

Sender's Name LISA

011 6563237

TO: Dep Mineral & Resources

Hoppy Centre
Cnr Van der Stel & Van
Riebeecks Streets

Postcode 8240

City/Town Springbok

Receiver's Name Jasper Nieuwoudt 027 7128160

By signing this waybill, the sender is declaring a contract with Dawn Wing and accepting full responsibility for the contents and to hold the carrier, who hereby represents the contents, harmless of any or all claims and demands on the revenue of the carrier's liability.

Senders Name LISA PN

Date 22/10/18

Collected By Courier [Signature]

Date 22/10/18

Special Instructions

PARCEL DETAILS

SERVICE (mark only one)

SPECIAL INSTRUCTIONS

Customer Value ZAR

Account to be Debited JB6925

Receiver's Signature [Signature]

Print Name A. N.

Date 22/10/18

Time 12:38

PROOF OF DELIVERY

DAWN WING
A Division of DPD Laser Express Logistics (Pty) Ltd
Reg. No. 2006/033353/07 VAT No. 4690235280
ISP NO 32009

*All weight and dimensions subject to verification through electronic weight and dimension machine (SASS calibrated)

22 October 2018

Mr Abe Abrahams
Chief Director
Department of Water and Sanitation
28 Central Road
Beaconsfield
KIMBERLEY 8301

Per Courier

Dear Mr Abrahams,

**BASIC ASSESSMENT AND PUBLIC PARTICIPATION PROCESSES FOR THE DEVELOPMENT OF THE
PROPOSED NAMAS AND ZONNEQUA WIND FARM PROJECTS NEAR KLEINSEE IN THE NORTHERN CAPE
PROVINCE**

NOTICE OF AVAILABILITY OF BASIC ASSESSMENT REPORTS FOR REVIEW AND WRITTEN COMMENTS

Genesis Namas Wind (Pty) Ltd is proposing two (2) 140MW wind farms and associated infrastructures on sites located approximately 20km south-east of Kleinsee. The wind farms are known as the **Namas Wind Farm** and **Zonnequa Wind Farm** and are located within the Nama Khoi Local Municipality and the Namakwa District Municipality in the Northern Cape Province.

This letter serves to inform you that the Basic Assessment Reports (BARs) are available for your Department's review and written comments, and hard copies and CDs containing the BARs are included in this envelope.

Please note that the BARs' review period is from **Wednesday, 24 October** to **Friday, 23 November 2018** and we are looking forward receiving your Department's written comment on the BARs before or on the closing date of the review period.

Kind regards

Nicolene Venter
Public Participation and Social Consultant
Savannah Environmental



0861 223 224
www.dawnwing.co.za



1298110914

WAYBILL

FROM: SAVANNAH ENVIRO S A		Contents CD 1st HC's		HAZARDOUS YES NO		Filing Ref: 1836	
Address 1ST FLOOR, BLOCK 2 5 WOODLANDS DRIVE WOODMEAD		No. of Pieces 2		Mandatory Tax & C's Apply 6/40kg		SERVICE (mark only one)	
City/Country WOODMEAD		Dimensions (cm) 40 30 1		International Documents		Express/ Special	
Postcode 2128		Special Instructions		International Flight Permit		Insurance/ Declared Value	
Sender's Name LISA		Postcode must be filled in 2128		Domestic/ Air Freight		Sender's Ref. / Bag No.	
TO: Dep Water & Sanitation		011 6563237		Value of Article ZAR		JB6925	
Street Address (P.O. Box Addresses not accepted) 28 Central Road Beaconsfield		Postcode must be filled in 8301		Tick to select limited liability option (to a maximum amount of R50 000) for merchandise articles.		Account to be Debited	
City/Country Kimberley		Receiver's Name Abc Abckhew		Dawn Wing reserves the right to mark the service "Overnight Express" should no service level be selected		RECEIVED IN GOOD ORDER AND CONDITION	
By signing this waybill the sender is concluding a contract with Dawn Wing and warrants his authority to enter into this contract and to bind the entity, which hereby represents. The terms and conditions of this contract are outlined on the reverse of the sender's copy.		Date 22/10/18		CASH R		Receiver's Signature ABC BUCKHEW	
Senders Name LISA PN		Collected By Courier PAEFA		PAID YES NO		Print Name	
Signature <i>[Signature]</i>		Date 22/10/18		Special Instructions		Date 22/10/18 11:20	

DAWN WING
A Division of DPD Laser Express Logistics (Pty) Ltd
Reg. No. 2006/633323/07 V.A.T. No. 4686739280
FSP NO 32605

*All weight and dimensions subject to verification through
electronic weight and dimension machine (SABS calibrated)

PROOF OF DELIVERY

11/9/2018 FMA 2009 FOR AFRICA (PTY) LTD TEL: 011 228-1200

Sender to complete yellow areas only

22 October 2018

Mr John Geeringh
Senior Environmental Manager
Eskom Holdings SOC Ltd
Maxwell Office Park
SUNNINGHILL

Collect at Savannah Environmental

Dear Mr Geeringh,

**BASIC ASSESSMENT AND PUBLIC PARTICIPATION PROCESSES FOR THE DEVELOPMENT OF THE
PROPOSED NAMAS AND ZONNEQUA WIND FARM PROJECTS NEAR KLEINSEE IN THE NORTHERN CAPE
PROVINCE**

NOTICE OF AVAILABILITY OF BASIC ASSESSMENT REPORTS FOR REVIEW AND WRITTEN COMMENTS

Genesis Namas Wind (Pty) Ltd is proposing two (2) 140MW wind farms and associated infrastructures on sites located approximately 20km south-east of Kleinsee. The wind farms are known as the **Namas Wind Farm** and **Zonnequa Wind Farm** and are located within the Nama Khoi Local Municipality and the Namakwa District Municipality in the Northern Cape Province.

This letter serves to inform you that the Basic Assessment Reports (BARs) are available for your Company's review and written comments, and a CD containing the BARs is included in this envelope.

Please note that the BARs' review period is from **Wednesday, 24 October** to **Friday, 23 November 2018** and we are looking forward receiving your Company's written comment on the BARs before or on the closing date of the review period.

Kind regards

Nicolene Venter
Public Participation and Social Consultant
Savannah Environmental

22 October 2018

Ms Andrea van Gensen
Regional Environmental Manager
Eskom Holdings SOC Ltd
120 Henry Street
BLOEMFONTEIN 9301

Per Courier

Dear Ms Van Gensen,

**BASIC ASSESSMENT AND PUBLIC PARTICIPATION PROCESSES FOR THE DEVELOPMENT OF THE
PROPOSED NAMAS AND ZONNEQUA WIND FARM PROJECTS NEAR KLEINSEE IN THE NORTHERN CAPE
PROVINCE**

NOTICE OF AVAILABILITY OF BASIC ASSESSMENT REPORTS FOR REVIEW AND WRITTEN COMMENTS

Genesis Namas Wind (Pty) Ltd is proposing two (2) 140MW wind farms and associated infrastructures on sites located approximately 20km south-east of Kleinsee. The wind farms are known as the **Namas Wind Farm** and **Zonnequa Wind Farm** and are located within the Nama Khoi Local Municipality and the Namakwa District Municipality in the Northern Cape Province.

This letter serves to inform you that the Basic Assessment Reports (BARs) are available for your Company's review and written comments, and a CD containing the BARs is included in this envelope.

Please note that the BARs' review period is from **Wednesday, 24 October** to **Friday, 23 November 2018** and we are looking forward receiving your Company's written comment on the BARs before or on the closing date of the review period.

Kind regards

Nicolene Venter
Public Participation and Social Consultant
Savannah Environmental



a division of **dpd LASER**

0861 223 224
www.dawnwing.co.za

WAYBILL



1298110774

FROM: Address SAVANNAH ENVIRO S A 1ST FLOOR, BLOCK 2 5 WOODLANDS DRIVE WOODMEAD WOODMEAD		Contents CD		HAZARDOUS YES NO P.YES SEE REVERSE		Filing Ref: 1836	
City/Country LISA		Postal Code must be filled in 2128		Parcel Details No. of Parcels 1		SERVICE (mark only one) Overnight Express <input checked="" type="checkbox"/> Domestic Road Freight International Documents <input type="checkbox"/> International Air Freight	
Senders Name LISA		Postal Code must be filled in 9301		Dimensions (cm) 30 20 1		SPECIAL INSTRUCTIONS Tick to select limited liability option (to a maximum amount of R50 000) Sundays / Public Holiday <input type="checkbox"/> After Hours <input type="checkbox"/> Dawn Delivery (P.O. / Time Required) <input type="checkbox"/> Confirmation of Delivery <input type="checkbox"/>	
To: Street Address (P.O. Box Addresses not accepted) 120 Henry Street Eskon Holdings		City/Country Bloufontein		CASH AMOUNT R		Value of Article ZAR	
Receiver's Name Andrea van Gersa		Postal Code must be filled in 9301		PAID YES NO		Account to be Debited JB6925	
By signing this waybill the sender is concluding a contract with Dawn Wing and warrants his authority to enter into this contract and to bind the entity, which he/she represents. The terms and conditions of this contract are contained on the reverse of the sender's copy.		Date 22/10/18		Special Instructions		Sender's Ref. / Bag No.	
Senders Name LISA		Date 22/10/18		Dawn Wing reserves the right to mark the service "Overnight Express" should no service level be selected		RECEIVED IN GOOD ORDER AND CONDITION	
Signature <i>[Signature]</i>		Time 22:10:18		Terms strictly 30 days from date of statement		Receivers Signature: <i>[Signature]</i>	
Date 22/10/18		Time 22:10:18		CASH AMOUNT R		Print Name: CYDIA	
Time 22:10:18		Date 22/10/18		PAID YES NO		Date: 24/10/18 Time: 10:23	

Sender to complete yellow areas only

DAWN WING
A Division of DPD Laser Express Logistics (Pty) Ltd
Reg. No. 2006/033353/07 VAT No. 4680235280
FSP NO 32009

*All weight and dimensions subject to verification through electronic weight and dimension machine (SABS calibrated)

PROOF OF DELIVERY

11/05/2016 FMA22009 FMI AFRICA (PTY) LTD Tel: (011) 228-1300

22 October 2018

Ms Samantha Titus
Municipal Manager
Nama Khoi Local Municipality
No 4 Namakwa Street
SPRINGBOK 8240

Per Courier

Dear Ms Titus,

**BASIC ASSESSMENT AND PUBLIC PARTICIPATION PROCESSES FOR THE DEVELOPMENT OF THE
PROPOSED NAMAS AND ZONNEQUA WIND FARM PROJECTS NEAR KLEINSEE IN THE NORTHERN CAPE
PROVINCE**

NOTICE OF AVAILABILITY OF BASIC ASSESSMENT REPORTS FOR REVIEW AND WRITTEN COMMENTS

Genesis Namas Wind (Pty) Ltd is proposing two (2) 140MW wind farms and associated infrastructures on sites located approximately 20km south-east of Kleinsee. The wind farms are known as the **Namas Wind Farm** and **Zonnequa Wind Farm** and are located within the Nama Khoi Local Municipality and the Namakwa District Municipality in the Northern Cape Province.

This letter serves to inform you that the Basic Assessment Reports (BARs) are available for Nama Khoi Local Municipality's review and written comments, and a CD containing the BARs is included in this envelope.

Please note that the BARs' review period is from **Wednesday, 24 October** to **Friday, 23 November 2018** and we are looking forward receiving Nama Khoi Local Municipality's written comment on the BARs before or on the closing date of the review period.

Kind regards

Nicolene Venter
Public Participation and Social Consultant
Savannah Environmental



global express

DPD LA 111

0861 223 224

www.dawnwing.co.za

WAYBILL



1298110855

FROM: SAVANNAH ENVIRO S A		Contents: CD		HAZARDOUS: YES NO		Filing Ref. 1826	
1ST FLOOR, BLOCK 2 5 WOODLANDS DRIVE WOODMEAD		Parcel Code must be filled in: 2129		PARCEL DETAILS:		SERVICE (mark only one):	
Country: WOODMEAD		Dimensions (cm): 30 20 1 1		C/O's		Special Instructions	
Sender's Name: LISA		Phone: 011 6563237		Dawn Wing reserves the right to mark the service "Overnight Express" should no service level be selected		Receiver's Signature: [Signature]	
TO: Nanga Khoi Local Municipality		Country: Springbok		Parcel Code must be filled in: 8240		Account to be Debited: JB6925	
Street Address (P.O. Box Addresses not accepted): No 4 Nankai Street		Sender's Name: Samantha Titus		Phone: 0277188100		CASH AMOUNT: R [] PAID YES NO	
Country: Springbok		Parcel Code must be filled in: 8240		Terms strictly 30 days from date of statement		Special Instructions	
Sender's Name: LISA PN		Date: 22/10/18		Collected By Courier: [Signature]		Date: 24/10/18 Time: 12:00	

Sender to complete yellow areas only

DAWN WING
A Division of DPD Laser Express Logistics (Pty) Ltd
Reg. No. 2006/033532/7 VAT No. 4690235780
PST NO 32009

*All weight and dimensions subject to verification through electronic weight and dimension machine (SABS calibrated)

PROOF OF DELIVERY

11/05/2018 F1252909 FAX 0861 223 224 TEL (011) 223 1200

22 October 2018

Mr Bryan Fisher
Director: Environmental Quality Management
Northern Cape Department of Environment and Nature Conservation
Sasko Building
90 Long Street
KIMBERLEY 8301

Per Courier

Dear Mr Fisher,

**BASIC ASSESSMENT AND PUBLIC PARTICIPATION PROCESSES FOR THE DEVELOPMENT OF THE
PROPOSED NAMAS AND ZONNEQUA WIND FARM PROJECTS NEAR KLEINSEE IN THE NORTHERN CAPE
PROVINCE**

NOTICE OF AVAILABILITY OF BASIC ASSESSMENT REPORTS FOR REVIEW AND WRITTEN COMMENTS

Genesis Namas Wind (Pty) Ltd is proposing two (2) 140MW wind farms and associated infrastructures on sites located approximately 20km south-east of Kleinsee. The wind farms are known as the **Namas Wind Farm** and **Zonnequa Wind Farm** and are located within the Nama Khoi Local Municipality and the Namakwa District Municipality in the Northern Cape Province.

This letter serves to inform you that the Basic Assessment Reports (BARs) are available for your Department's review and written comments, and a CD containing the BARs is included in this envelope.

Please note that the BARs' review period is from **Wednesday, 24 October** to **Friday, 23 November 2018** and we are looking forward receiving your Department's written comment on the BARs before or on the closing date of the review period.

Kind regards

Nicolene Venter
Public Participation and Social Consultant
Savannah Environmental

26 October 2018

Mr Bryan Fisher
Director: Environmental Quality Management
Northern Cape Department of Environment and Nature Conservation
Sasko Building
90 Long Street
KIMBERLEY 8301

Per Courier

Dear Mr Fisher,

**BASIC ASSESSMENT AND PUBLIC PARTICIPATION PROCESSES FOR THE DEVELOPMENT OF THE
PROPOSED NAMAS AND ZONNEQUA WIND FARM PROJECTS NEAR KLEINSEE IN THE NORTHERN CAPE
PROVINCE**

NOTICE OF AVAILABILITY OF BASIC ASSESSMENT REPORTS FOR REVIEW AND WRITTEN COMMENTS

Genesis Namas Wind (Pty) Ltd is proposing two (2) 140MW wind farms and associated infrastructures on sites located approximately 20km south-east of Kleinsee. The wind farms are known as the **Namas Wind Farm** and **Zonnequa Wind Farm** and are located within the Nama Khoi Local Municipality and the Namakwa District Municipality in the Northern Cape Province.

This letter serves to inform you that the Basic Assessment Reports (BARs) are available for your Department's review and written comments, and a CD containing the BARs as well as a copy of the Environmental Authorisation Application Form as submitted to the Department of Environmental Affairs are included in this envelope.

Please note that the BARs' review period is from **Wednesday, 24 October** to **Friday, 23 November 2018** and we are looking forward receiving your Department's written comment on the BARs before or on the closing date of the review period.

Kind regards

Nicolene Venter
Public Participation and Social Consultant
Savannah Environmental



0861 223 224
www.dawnwing.co.za



1298110881

WAYBILL

FROM: SAVANNAH ENVIRO S A		Contents CD		HAZARDOUS YES NO		Filing Ref. 1836	
Address 1ST FLOOR, BLOCK 2 5 WOODLANDS DRIVE WOODMEAD		No. of Parcels 1		Messages & Charges 0,05		SERVICE (mark only one)	
City/Country WOODMEAD		Dimensions (cm) 30 20 1		International Documents		Domestic Parcel Weight International Parcel Weight	
Postal Code 2128		Special Instructions		Security Check Required		Special Instructions	
City/Country LISA		Sender's Name LISA		Clearance Fee		Value of Article ZAR	
TO: Nkape Dep Environment and Nature Conservation		Postal Code 8301		Accused to be Detained JB6925		Sender's Ref./Bag No.	
Sasto Building, 90 Long Street		Receiver's Name Lamberky		Dawn Wing reserves the right to mark the service "Overnight Express" should no service level be selected		RECEIVED IN GOOD ORDER AND CONDITION	
City/Country Lamberky		Phone No. 083 8077431		Terms strictly 30 days from date of statement		Receiver's Signature	
City/Country BYER FISHOE		Postal Code 8323		CASH AMOUNT R		Print Name A1 Werburu	
By signing this waybill the sender is concluding a contract with Dawn Wing and warrants its validity to enter into this contract and to bind the entity, which hereby represents. The terms and conditions of this contract are contained on the reverse of the sender's copy.		Date 22/10/18		PAID YES NO		Date 23/10/2018	
Sender's Name LISA PN		Collected By Counter A1 Werburu		Special Instructions		Time 11449	
Signature LISA PN		Date 22/10/18		Special Instructions		Time 11449	

Sender to complete yellow areas only

DAWN WING
A Division of DPD Laser Express Logistics (Pty) Ltd
Reg. No. 2066/03353/07 VAT No. 489233280
PSP NO 32039

*All weight and dimensions subject to verification through electronic weight and dimension machine (SABS calibrated)

PROOF OF DELIVERY

11/06/2015 - 04/03/2008 P.M. AFRICA (PTY) LTD Tel: (011) 240-1200

22 October 2018

Mr Kgotso Moeketsi
Chief Director: PSSC
Northern Cape Department of Rural Development and Land Reform
New Public Building
Cnr Stead & Knight Streets
KIMBERLEY 8301

Per Courier

Dear Mr Moeketsi,

**BASIC ASSESSMENT AND PUBLIC PARTICIPATION PROCESSES FOR THE DEVELOPMENT OF THE
PROPOSED NAMAS AND ZONNEQUA WIND FARM PROJECTS NEAR KLEINSEE IN THE NORTHERN CAPE
PROVINCE**

NOTICE OF AVAILABILITY OF BASIC ASSESSMENT REPORTS FOR REVIEW AND WRITTEN COMMENTS

Genesis Namas Wind (Pty) Ltd is proposing two (2) 140MW wind farms and associated infrastructures on sites located approximately 20km south-east of Kleinsee. The wind farms are known as the **Namas Wind Farm** and **Zonnequa Wind Farm** and are located within the Nama Khoi Local Municipality and the Namakwa District Municipality in the Northern Cape Province.

This letter serves to inform you that the Basic Assessment Reports (BARs) are available for your Department's review and written comments, and a CD containing the BARs is included in this envelope.

Please note that the BARs' review period is from **Wednesday, 24 October** to **Friday, 23 November 2018** and we are looking forward receiving your Department's written comment on the BARs before or on the closing date of the review period.

Kind regards

Nicolene Venter
Public Participation and Social Consultant
Savannah Environmental

22 October 2018

Ms Jacoline Roelofse
Director: Roads
Department of Roads and Public Works
45 Schmidtsdrift Road
KIMBERLEY 8301

Per Courier

Dear Ms Roelofse,

**BASIC ASSESSMENT AND PUBLIC PARTICIPATION PROCESSES FOR THE DEVELOPMENT OF THE
PROPOSED NAMAS AND ZONNEQUA WIND FARM PROJECTS NEAR KLEINSEE IN THE NORTHERN CAPE
PROVINCE**

NOTICE OF AVAILABILITY OF BASIC ASSESSMENT REPORTS FOR REVIEW AND WRITTEN COMMENTS

Genesis Namas Wind (Pty) Ltd is proposing two (2) 140MW wind farms and associated infrastructures on sites located approximately 20km south-east of Kleinsee. The wind farms are known as the **Namas Wind Farm** and **Zonnequa Wind Farm** and are located within the Nama Khoi Local Municipality and the Namakwa District Municipality in the Northern Cape Province.

This letter serves to inform you that the Basic Assessment Reports (BARs) are available for your Department's review and written comments, and a CD containing the BARs is included in this envelope.

Please note that the BARs' review period is from **Wednesday, 24 October** to **Friday, 23 November 2018** and we are looking forward receiving your Department's written comment on the BARs before or on the closing date of the review period.

Kind regards

Nicolene Venter
Public Participation and Social Consultant
Savannah Environmental



0861 223 224
www.dawnwing.co.za



1298110870

WAYBILL

FROM: SAVANNAH ENVIRO S A		Contents		Filing Ref. 1836	
1ST FLOOR, BLOCK 2		CD		SERVICE (mark only one)	
5 WOODLANDS DRIVE		No. of Parcels 1		<input checked="" type="checkbox"/> Economy <input type="checkbox"/> Standard <input type="checkbox"/> International	
WOODMEAD		Dimensions (cm)		<input type="checkbox"/> International <input type="checkbox"/> Air Freight	
WOODMEAD		40 30 10		SPECIAL INSTRUCTIONS	
LISA		Postal Code 2128		<input type="checkbox"/> Open <input type="checkbox"/> Delivery <input type="checkbox"/> After <input type="checkbox"/> Hours <input type="checkbox"/> Customs <input type="checkbox"/> Prohibited <input type="checkbox"/> Goods <input type="checkbox"/> Delivery <input type="checkbox"/> Location <input type="checkbox"/> Delivery <input type="checkbox"/> Location	
TO: Rep. Roads & Public Works		Postal Code 8301		Tick to select limited liability option (to a maximum amount of R30 000) for non-included articles	
45 Schmittsdrift Road		Postal Code 8301		Customs Value Value of Article ZAR	
Kimberley		Postal Code 8301		Account to be Debited JB6925	
Jacqueline Roelfse		Postal Code 8301		Sender's Ref. / Bag No.	
By signing this waybill the sender is concluding a contract with Dawn Wing and warrants his authority to enter into this contract and to bind the entry, which he/she represents. The terms and conditions of this contract are contained on the reverse of the sender's copy.		Dawn Wing reserves the right to mark the service "Overnight Express" should no service level be selected		RECEIVED IN GOOD ORDER AND CONDITION Receiver's Signature: <i>W. Wellington</i> Date: 27/08/18 Time: 12:56	
Senders Name: USAPN Date: 27/08/18 Time: 12:56 Collected By Courier: <i>JP</i>		CASH AMOUNT R PAID YES NO		PROOF OF DELIVERY	
Signature: <i>JP</i>		Special Instructions		Date: 27/08/18 Time: 12:56	

Sender to complete yellow areas only

*All weight and dimensions subject to verification through electronic weight and dimension machine (SABS calibrated)

DAWN WING
A Division of DPD Laser Express Logistics (Pty) Ltd
Reg. No. 2006/033553/07 VAT No. 459213780
FSP-NO 32068

22 October 2018

Mr Tamai Hore
Senior Engineer: Generation Licensing
National Energy Regulator of South Africa
Kulawula House
526 Madiba Street
ARCADIA 0083

Per Courier

Dear Mr Hore,

**BASIC ASSESSMENT AND PUBLIC PARTICIPATION PROCESSES FOR THE DEVELOPMENT OF THE
PROPOSED NAMAS AND ZONNEQUA WIND FARM PROJECTS NEAR KLEINSEE IN THE NORTHERN CAPE
PROVINCE**

NOTICE OF AVAILABILITY OF BASIC ASSESSMENT REPORTS FOR REVIEW AND WRITTEN COMMENTS

Genesis Namas Wind (Pty) Ltd is proposing two (2) 140MW wind farms and associated infrastructures on sites located approximately 20km south-east of Kleinsee. The wind farms are known as the **Namas Wind Farm** and **Zonnequa Wind Farm** and are located within the Nama Khoi Local Municipality and the Namakwa District Municipality in the Northern Cape Province.

This letter serves to inform you that the Basic Assessment Reports (BARs) are available for your Organisation's review and written comments, and a CD containing the BARs is included in this envelope.

Please note that the BARs' review period is from **Wednesday, 24 October** to **Friday, 23 November 2018** and we are looking forward receiving your Organisation's written comment on the BARs before or on the closing date of the review period.

Kind regards

Nicolene Venter
Public Participation and Social Consultant
Savannah Environmental



0861 223 224
www.dawnwing.co.za

global express
a division of dpd LASER



1298110844

WAYBILL

FROM: SAVANNAH ENVIRO S A		HAZARDOUS YES <input type="checkbox"/> NO <input type="checkbox"/>		Filing Ref: 1830	
Address 1ST FLOOR, BLOCK 2 5 WOODLANDS DRIVE WOODMEAD		Parcel Details No. of Parcels: 1 Vol(kg)-T's & C's Apply: 0,03 Mass(kg)-T's & C's Apply: 0,03		SERVICE (mark only one) Overnight Express <input checked="" type="checkbox"/> Economy Cargo International Documents International Road Freight International Air Freight	
City/Country WOODMEAD		Dimensions (cm) 30 20 1		SPECIAL INSTRUCTIONS Saturday Delivery Collection Requested Dawn Delivery (300 / 1 min) After Hours Sunday / Public Holiday Confirmation of Delivery	
Postal Code must be filled in 2128		Sender's Name LISA		Tick to select limited liability option (to a maximum amount of R50 000) <input type="checkbox"/>	
City/Country Arcadia		Postal Code must be filled in 00823		Customs Value ZAR	
Street Address (No Box Addresses not accepted) NERSA - National Energy Regulator of South Africa Kulawula House 526 Macaliba Street		Dawn Wing reserves the right to mark the service "Overnight Express" should no service level be selected		Value of Article ZAR	
City/Country Arcadia		Postal Code must be filled in 00823		Account to be Debited JB6925	
Receiver's Name Amoi Hore		CASH AMOUNT R		Sender's Ref. / Bag No.	
Date 22/10/11		PAID YES <input type="checkbox"/> NO <input type="checkbox"/>		RECEIVED IN GOOD ORDER AND CONDITION	
Time 18:55		Special Instructions		Receivers Signature: <i>Linda</i>	
Collected By Courier PATEP		Terms strictly 30 days from date of statement		Print Name: Linda	
Date 22/10/11		Time 10:09		Date: 23/10 Time: 10:09	

*All weight and dimensions subject to verification through electronic weight and dimension machine (SABS calibrated)

PROOF OF DELIVERY

22 October 2018

Mr Marlon Fennis
Executive: Operations
SENTECH
Sender Technology Park
Octave Street
HONEYDEW 2040

Per Courier

Dear Mr Fennis,

**BASIC ASSESSMENT AND PUBLIC PARTICIPATION PROCESSES FOR THE DEVELOPMENT OF THE
PROPOSED NAMAS AND ZONNEQUA WIND FARM PROJECTS NEAR KLEINSEE IN THE NORTHERN CAPE
PROVINCE**

NOTICE OF AVAILABILITY OF BASIC ASSESSMENT REPORTS FOR REVIEW AND WRITTEN COMMENTS

Genesis Namas Wind (Pty) Ltd is proposing two (2) 140MW wind farms and associated infrastructures on sites located approximately 20km south-east of Kleinsee. The wind farms are known as the **Namas Wind Farm** and **Zonnequa Wind Farm** and are located within the Nama Khoi Local Municipality and the Namakwa District Municipality in the Northern Cape Province.

This letter serves to inform you that the Basic Assessment Reports (BARs) are available for your Company's review and written comments, and a CD containing the BARs is included in this envelope.

Please note that the BARs' review period is from **Wednesday, 24 October** to **Friday, 23 November 2018** and we are looking forward receiving your Company's written comment on the BARs before or on the closing date of the review period.

Kind regards

Nicolene Venter
Public Participation and Social Consultant
Savannah Environmental



global express

a division of dpd LASER

0861 223 224

www.dawnwing.co.za



1298110785

WAYBILL

FROM: Address SAVANNAH ENVIRO S A 1ST FLOOR. BLOCK 2 5 WOODLANDS DRIVE WOODMEAD		Contents CD		HAZARDOUS YES <input type="checkbox"/> NO <input checked="" type="checkbox"/>		Filing Ref: 1836	
City/Country WOODMEAD		Postal Code must be filled in 2128		No. of Parcels 1		Vol(kg)-Ts & C's Apply* 0,05	
Senders Name LISA		Phone No 011 6563237		Dimensions (cm) 30 20 1		Mass(kg)-Ts & C's Apply*	
TO: Street Address (P.O. Box Addresses not accepted) Sender Technology Park Octave sheet		City/Country Honeydew, JHB.		Postal Code must be filled in 2040		International Documents <input checked="" type="checkbox"/>	
Receiver's Name Marion Lemis		Phone No 0860 736 832		Special Instructions Dawn Wing reserves the right to mark the service "Overnight Express" should no service level be selected		Economy Cargo <input checked="" type="checkbox"/>	
Senders Name USAPIN		Date 22/10/11		Collected By Courier JME/TP		Domestic Road Freight <input type="checkbox"/>	
Signature 		Date 22/10/11		Time 08:50		International Air Freight <input type="checkbox"/>	
City/Country Honeydew, JHB.		Postal Code must be filled in 2040		Special Instructions Dawn Wing reserves the right to mark the service "Overnight Express" should no service level be selected		International Documents <input type="checkbox"/>	
Receiver's Name Marion Lemis		Phone No 0860 736 832		Special Instructions Dawn Wing reserves the right to mark the service "Overnight Express" should no service level be selected		International Documents <input type="checkbox"/>	
Senders Name USAPIN		Date 22/10/11		Collected By Courier JME/TP		Domestic Road Freight <input type="checkbox"/>	
Signature 		Date 22/10/11		Time 08:50		International Air Freight <input type="checkbox"/>	

Sender to complete yellow areas only

DAWN WING
A Division of DPD Laser Express Logistics (Pty) Ltd
Reg. No. 2006/033353/07 VAT No. 4690235280
FSP NO 32009

PROOF OF DELIVERY

*All weight and dimensions subject to verification through electronic weight and dimension machine (SABS calibrated)

11/05/2016 FMIA2009 FMI AFRICA (PTY) LTD Tel: (011) 228-1900

22 October 2018

Ms Katie MacEwan
Manager: Nature & Conservation
SA Bat Assessment Association
125 Ballyclar Drive
MORNING SIDE EXT 40 2196

Per Courier

Dear Ms MacEwan,

**BASIC ASSESSMENT AND PUBLIC PARTICIPATION PROCESSES FOR THE DEVELOPMENT OF THE
PROPOSED NAMAS AND ZONNEQUA WIND FARM PROJECTS NEAR KLEINSEE IN THE NORTHERN CAPE
PROVINCE**

NOTICE OF AVAILABILITY OF BASIC ASSESSMENT REPORTS FOR REVIEW AND WRITTEN COMMENTS

Genesis Namas Wind (Pty) Ltd is proposing two (2) 140MW wind farms and associated infrastructures on sites located approximately 20km south-east of Kleinsee. The wind farms are known as the **Namas Wind Farm** and **Zonnequa Wind Farm** and are located within the Nama Khoi Local Municipality and the Namakwa District Municipality in the Northern Cape Province.

This letter serves to inform you that the Basic Assessment Reports (BARs) are available for your Organisation's review and written comments, and a CD containing the BARs is included in this envelope.

Please note that the BARs' review period is from **Wednesday, 24 October** to **Friday, 23 November 2018** and we are looking forward receiving your Organisation's written comment on the BARs before or on the closing date of the review period.

Kind regards

Nicolene Venter
Public Participation and Social Consultant
Savannah Environmental

Waybill Summary Details

Waybill Number : 1298111021
Waybill Status : POD RECEIVED
From : JOHANNESBURG CENTRALAREAS
Sender : SAVANNAH ENVIRONMENT
1ST FLOOR, BLOCK 2
5 WOODLANDS DRIVE
WOODMEAD
2128
Contact : %%SenContact%%
Telephone : %%SenTelNo%%
Cellphone : %%SenCelNo%%
Customer Ref : %%InvoiceRefNo%%
Total Parcels : 1
Total Volume : 0.12

Waybill Date : 2018-10-22
Service : %%ServiceType%%
To : JOHANNESBURG CENTRALAREAS
Receiver : SABAT ASSESSMENT ASSOCIATION
125 BALLYCALR DRIVE
MORNINGSIDE EXT 40
MORNINGSIDE EXT 40
2196
Contact : MACTWAN
Telephone : 011 7877400
Cellphone : %%RecCelNo%%
Collection No :
Total Mass : 0.05
Value :

Proof of Delivery

Received By	Date Received	Time	Parcels
Finalized : RTSBIL	2018-11-05	16:30	1

Detailed track and trace

Event	Location	Date	Time	Additional Information
DAWN WING WILL CONTACT YOU	JNB	2018-10-23	10:15	REASON: 17 - INCOMPLETE ADDRESS
WAYBILL NOTE	JNB	2018-10-30	08:03	REASON: 03 - CONTACT NOT AVAILABLE
POD RECEIVED / DELIVERED	JNB	2018-11-05	16:32	

[Back](#)

22 October 2018

Mr Michael Knight
Team Leader: Park Planning & Consolidation Task Team
SANParks
643 Leyds Street
PRETORIA 0002

Per Courier

Dear Mr Knight,

**BASIC ASSESSMENT AND PUBLIC PARTICIPATION PROCESSES FOR THE DEVELOPMENT OF THE
PROPOSED NAMAS AND ZONNEQUA WIND FARM PROJECTS NEAR KLEINSEE IN THE NORTHERN CAPE
PROVINCE**

NOTICE OF AVAILABILITY OF BASIC ASSESSMENT REPORTS FOR REVIEW AND WRITTEN COMMENTS

Genesis Namas Wind (Pty) Ltd is proposing two (2) 140MW wind farms and associated infrastructures on sites located approximately 20km south-east of Kleinsee. The wind farms are known as the **Namas Wind Farm** and **Zonnequa Wind Farm** and are located within the Nama Khoi Local Municipality and the Namakwa District Municipality in the Northern Cape Province.

This letter serves to inform you that the Basic Assessment Reports (BARs) are available for your Organisation's review and written comments, and a CD containing the BARs is included in this envelope.

Please note that the BARs' review period is from **Wednesday, 24 October** to **Friday, 23 November 2018** and we are looking forward receiving your Organisation's written comment on the BARs before or on the closing date of the review period.

Kind regards

Nicolene Venter
Public Participation and Social Consultant
Savannah Environmental



a division of dpd LASER

0861 223 224
www.dawnwing.co.za



1298111043

WAYBILL

FROM: SAVANNAH ENVIRO S A		Contents D		Filing Ref: 1836	
Address 1ST FLOOR, BLOCK 2 5 WOODLANDS DRIVE WOODMEAD		HAZARDOUS YES <input type="checkbox"/> NO <input checked="" type="checkbox"/>		SERVICE (mark only one)	
City/Country WOODMEAD		No. of Parcels 1		Economy Cargo	
Postal Code must be filled in 2128		Dimensions (cm) 40 30 10		Sameday Express	
Senders Name LISA		Mass(kg)-T's & C's Apply* 970kgs		Domestic Road Freight	
TO: SAN PARKS		Special Instructions		International Documents	
Street Address (P.O. Box Addresses not accepted) 643 leys street		Dawn Wing reserves the right to mark the service "Overnight Express" should no service level be selected		International Air Freight	
City/Country PRETORIA		Dawn Wing strictly 30 days from date of statement		SPECIAL INSTRUCTIONS	
Postal Code must be filled in 0002		CASH AMOUNT R		Sundays / Public Holiday	
Receiver's Name Michael Lueg		PAID YES NO		After Hours	
City/Country PRETORIA		Special Instructions		Depts. Delivery PH207/Time Required	
Senders Name LISA		Terms strictly 30 days from date of statement		Confirmation of Delivery	
Signature LISA		RECEIVED IN GOOD ORDER AND CONDITION		Tick to select limited liability option (to a maximum amount of R50 000) for non-excluded articles	
Date/Time 22/10/18 15:14		RECEIVED IN GOOD ORDER AND CONDITION		Value of Article ZAR	
Collected By Courier PASTOR		RECEIVED IN GOOD ORDER AND CONDITION		Account to be Debited JB6925	
Date/Time 22/10/18 15:14		RECEIVED IN GOOD ORDER AND CONDITION		Sender's Ref. / Bag No.	
Signature LISA		RECEIVED IN GOOD ORDER AND CONDITION		Receiver's Signature: <i>[Signature]</i>	
Date/Time 22/10/18 15:14		RECEIVED IN GOOD ORDER AND CONDITION		Prig. Name: <i>[Signature]</i>	
Signature LISA		RECEIVED IN GOOD ORDER AND CONDITION		Date/Time 22/10/18 15:14	

Sender to complete yellow areas only

DAWN WING
A Division of DPD Laser Express Logistics (Pty) Ltd
Reg. No. 2006/0333507 VAT No. 4690235280
FSP NO 32009

*All weight and dimensions subject to verification through
electronic weight and dimension machine (SABS calibrated)

PROOF OF DELIVERY

11/05/2018 FMA22009 FMI AFRICA (PTY) LTD Tel: (011) 228-1300

22 October 2018

Ms Nicole Abrahams
Environmental Co-ordinator: Western Region
SA National Roads Agency Ltd
1 Havenga Street
Oakdale
BELLEVILLE 7530

Per Courier

Dear Ms Abrahams,

**BASIC ASSESSMENT AND PUBLIC PARTICIPATION PROCESSES FOR THE DEVELOPMENT OF THE
PROPOSED NAMAS AND ZONNEQUA WIND FARM PROJECTS NEAR KLEINSEE IN THE NORTHERN CAPE
PROVINCE**

NOTICE OF AVAILABILITY OF BASIC ASSESSMENT REPORTS FOR REVIEW AND WRITTEN COMMENTS

Genesis Namas Wind (Pty) Ltd is proposing two (2) 140MW wind farms and associated infrastructures on sites located approximately 20km south-east of Kleinsee. The wind farms are known as the **Namas Wind Farm** and **Zonnequa Wind Farm** and are located within the Nama Khoi Local Municipality and the Namakwa District Municipality in the Northern Cape Province.

This letter serves to inform you that the Basic Assessment Reports (BARs) are available for your Company's review and written comments, and a CD containing the BARs is included in this envelope.

Please note that the BARs' review period is from **Wednesday, 24 October** to **Friday, 23 November 2018** and we are looking forward receiving your Company's written comment on the BARs before or on the closing date of the review period.

Kind regards

Nicolene Venter
Public Participation and Social Consultant
Savannah Environmental



global express

a division of dpd LASER

0861 223 224
www.dawnwing.co.za



1298110796

WAYBILL

FROM: SAVANNAH ENVIRO S A Address 1ST FLOOR, BLOCK 2 5 WOODLANDS DRIVE WOODMEAD City/Country WOODMEAD Postal Code must be filled in 2128		Contents CD HAZARDOUS YES NO F. YES, SEE REVERSE.		Filing Ref: 1836	
Senders Name LISA 011 6563237 Postal Code must be filled in 2128		PARCEL DETAILS Vol(kg)-T's & C's Apply* 0,05 Dimensions (cm) 30 20 1		SERVICE (mark only one) <input checked="" type="checkbox"/> Overnight Express <input type="checkbox"/> Economy Cargo <input type="checkbox"/> Domestic Road Freight <input type="checkbox"/> International Air Freight <input type="checkbox"/> International Documents <input type="checkbox"/> International Road Freight	
TO: Biodlife South Africa. Street Address (P.O. Box Addresses not accepted) ROOM A3 CBC Building Kirstenbosch Botanical Gardens Roodes Drive City/Country CAPE TOWN Postal Code must be filled in 7735		SPECIAL INSTRUCTIONS Saturday Delivery Collection Dawn Drop / Public Holiday Other Hours Required Confirmation of Delivery Value of Article ZAR Account to be Debited JB6925 Sender's Ref. / Bag No.		RECEIVED IN GOOD ORDER AND CONDITION Receivers Signature: Print Name: Nicola Oakes Date: 23/11/18 Time: 5:30	
Receiver's Name Samantha Ralston- 7 PATON City/Country CAPE TOWN Postal Code must be filled in 7735		Special Instructions Dawn Wing reserves the right to mark the service "Overnight Express" should no service level be selected Terms strictly 30 days from date of statement CASH AMOUNT R PAID YES NO		PROOF OF DELIVERY	
Senders Name LISAPN Date 23/11/18 Time 18:30 Collected By Courier PMSR		Special Instructions		PROOF OF DELIVERY	

Sender to complete yellow areas only

DAWN WING
 A Division of DPD Laser Express Logistics (Pty) Ltd
 Reg. No. 2006/03353/07 VAT No. 4690235280
 FSP NO 32009
 *All weight and dimensions subject to verification through electronic weight and dimension machine (SABS calibrated)

22 October 2018

Dr Adriaan Tiplady
Manager: Site Categorisation
Square Kilometre Array
1st Floor
17 Baker Street
ROSEBANK 2196

Per Courier

Dear Dr Tiplady,

**BASIC ASSESSMENT AND PUBLIC PARTICIPATION PROCESSES FOR THE DEVELOPMENT OF THE
PROPOSED NAMAS AND ZONNEQUA WIND FARM PROJECTS NEAR KLEINSEE IN THE NORTHERN CAPE
PROVINCE**

NOTICE OF AVAILABILITY OF BASIC ASSESSMENT REPORTS FOR REVIEW AND WRITTEN COMMENTS

Genesis Namas Wind (Pty) Ltd is proposing two (2) 140MW wind farms and associated infrastructures on sites located approximately 20km south-east of Kleinsee. The wind farms are known as the **Namas Wind Farm** and **Zonnequa Wind Farm** and are located within the Nama Khoi Local Municipality and the Namakwa District Municipality in the Northern Cape Province.

This letter serves to inform you that the Basic Assessment Reports (BARs) are available for your Company's review and written comments, and a CD containing the BARs is included in this envelope.

Please note that the BARs' review period is from **Wednesday, 24 October** to **Friday, 23 November 2018** and we are looking forward receiving your Company's written comment on the BARs before or on the closing date of the review period.

Kind regards

Nicolene Venter
Public Participation and Social Consultant
Savannah Environmental



0861 223 224
www.dawnwing.co.za

a division of dpd LASER



1298111065

WAYBILL

FROM: SAVANNAH ENVIRO S A		Filing Ref: 1836	
Address		SERVICE (mark only one)	
1ST. FLOOR. BLOCK 2		Overnight Express	Domestic Road Freight
5 WOODLANDS DRIVE		International Documents	International Air Freight
WOODMEAD		International Non Documents	International Road Freight
City/Country		SPECIAL INSTRUCTIONS	
WOODMEAD	Postal Code must be filled in 2128	Sunday Delivery 9:00 / Time Collected	Sunday / Public Holiday
Senders Name	011 6563237	After Hours	Confirmation of Delivery
LISA			
TO: Square Kubo Meme Arway		Track to select limited liability option (Maximum amount of R50 000) (For unregistered articles)	
Street Address (P.O. Box Addresses not accepted)		Customs Value	Value of Article
1st floor, Baker Street		ZAR	ZAR
Rosebank		Account to be Debited	
City/Country		JB6925	
Johannesburg	Postal Code must be filled in 2196	Sender's Ref. / Beg No.	
Receiver's Name			
Adrican Tiplady	011 442 2434	RECEIVED IN GOOD ORDER AND CONDITION	
By signing this waybill the sender is concluding a contract with Dawn Wing and warrants his authority to enter into this contract and to bind the entity, which he/she represents. The terms and conditions of this contract are contained on the reverse of the sender's copy.			
Senders Name	Date	Receiver's Signature:	
USA PN	22/10/18	[Signature]	
Signature	Time	Print Name	
		LIR29	
		Date	Time
		23/10/18	9H40a

HAZARDOUS	
YES	NO
Parcel Details	
No. of Parcels	Mass(kg)-T's & C's Apply
1	0,05
Dimensions (cm)	
30 20 1	
Dawn Wing reserves the right to mark the service "Overnight Express" should no service level be selected	
Terms strictly 30 days from date of statement.	
CASH AMOUNT	PAID YES NO
R	
Special Instructions	

DAWN WING
A Division of DPD Laser Express Logistics (Pty) Ltd
Reg. No. 200603333007 VAT No. 4690235280
FSP NO 32009

PROOF OF DELIVERY

*All weight and dimensions subject to verification through electronic weight and dimension machine (SABS calibrated)

11/05/2016 FIM422009 FMI AFRICA (PTY) LTD Tel: (011) 229-1300

Sender to complete yellow areas only

CONSULTATION WITH ORGANS OF STATE

Rozanne Els

From: Rozanne Els <rozanne@savannahsa.com>
Sent: 19 November 2018 12:31 PM
To: 'Musa Baloye'
Subject: RE: REMINDER: NAMAS WIND FARM: NOTIFICATION OF AVAILABILITY OF BASIC ASSESSMENT REPORT FOR REVIEW AND COMMENT

Dear Musa,

Please see below:
LEk87*56\Kllqqh

Kind regards,

Rozanne Els

Public Participation Co-ordinator | Savannah Environmental (Pty) Ltd
Tel: +27 (0)11 656 3237 | Fax: +27 (0)86 684 0547

[SAWEA Award for Leading Environmental Consultant for Wind Projects in 2013 & 2015](#)

From: Musa Baloye [mailto:mbaloye@ska.ac.za]
Sent: 19 November 2018 11:36 AM
To: rozanne@savannahsa.com
Subject: Re: REMINDER: NAMAS WIND FARM: NOTIFICATION OF AVAILABILITY OF BASIC ASSESSMENT REPORT FOR REVIEW AND COMMENT

Hi Rozanne

Please kindly assist with the password of the above mentioned in order to download the documents on your website.

Thank you.

Kind regards,

Musa Baloye

On Mon, Nov 19, 2018 at 11:28 AM Selaelo Matlhane - SKA <smatlhane@ska.ac.za> wrote:

Please coordinate reply.

----- Forwarded message -----

From: Adrian Tiplady <atiplady@ska.ac.za>

Date: Mon, 19 Nov 2018 at 10:23

Subject: Fwd: REMINDER: NAMAS WIND FARM: NOTIFICATION OF AVAILABILITY OF BASIC ASSESSMENT REPORT FOR REVIEW AND COMMENT

To: Selaelo Matlhane <smatlhane@ska.ac.za>, Busang Sethole <bsethole@ska.ac.za>, Tshegofatso Monama <temonama@ska.ac.za>

----- Forwarded Message -----

Subject:REMINDER: NAMAS WIND FARM: NOTIFICATION OF AVAILABILITY OF BASIC ASSESSMENT REPORT FOR REVIEW AND COMMENT

Date:Fri, 16 Nov 2018 07:45:03 +0000 (UTC)

From:Savannah Public Process <publicprocess@savannahsa.com>

Reply-To:Savannah Public Process <publicprocess@savannahsa.com>

CC:nicolene@savannahsa.com

Dear Stakeholder,

With reference to the attached notification letter and email below, this email serves as a reminder that the comment period ends on **Friday, 23 November 2018**.

Kindly submit your comments on or before **Friday, 23 November 2018** by close of business.

Thank you and kind regards,

Rozanne Els

Public Participation Co-ordinator | Savannah Environmental (Pty) Ltd
Tel: +27 (0)11 656 3237 | Fax: +27 (0)86 684 0547

SAWEA Award for Leading Environmental Consultant for Wind Projects in 2013 & 2015

> From: Savannah Public Process <publicprocess@savannahsa.com>
> Date Sent: 23/10/2018 09:18
> To:
> Cc:
> Subject: FW: NAMAS WIND FARM: NOTIFICATION OF AVAILABILITY OF BASIC ASSESSMENT REPORT FOR REVIEW AND COMMENT
>

Dear Stakeholder,

A wind farm is proposed to be developed within the Springbok Renewable Energy Development Zone (REDZ), approximately 20 km south-east of the town of Kleinsee in the Northern Cape. The wind farm is

known as the **Namas Wind Farm** and is located within the Nama Khoi Local Municipality and the Namakwa District Municipality.

It is Genesis Namas Wind (Pty) Ltd's, the developer, intention to bid the Namas Wind Farm project under the Department of Energy's (DoE) Renewable Energy Independent Power Producer Procurement (REIPPP) Programme. The power generated from the project will be sold to Eskom and will feed into the national electricity grid. The development of the project will also assist with achieving the electricity generation goals as set out in the Integrated Resources Plan.

This e-mail serves to inform you, as a registered Interested and Affected Party (I&AP), that in terms of the National Environmental Management Act (No. 107 of 1998) (NEMA) and the 2014 Environmental Impact Assessment (EIA) Regulations, as amended in April 2017, that the Basic Assessment Report (BAR) is available for your review and comment.

The hard copy of the BAR can be viewed at the Kleinsee Library (3rd Avenue, Kleinsee, open on Tuesdays & Thursdays between 11h00 and 17h00) from **Wednesday, 24 October 2018 to Friday, 23 November 2018**. An electronic copy can be downloaded from our website (<http://www.savannahsa.com/public-documents/energy-generation/namas-wind-farm/>).

Please refer to the attached letter for further details in this regard.

Kind regards,

Nicolene Venter

Public Participation and Social Consultant | Savannah Environmental (Pty) Ltd
Tel: +27 (0)11 656 3237 | Mobile: +27 83 377 9112 | Fax: +27 (0)86 684 0547

SAWEA Award for Leading Environmental Consultant for Wind Projects in 2013 & 2015

--

Musa Baloye

Project Coordinator

South African Radio Astronomy Observatory (SARAO)

17 Baker Street, Rosebank, Johannesburg, 2196

Email: mbaloye@ska.ac.za

Website: www.ska.ac.za



www.winsms.co.za

WinSMS Delivery Report

To Name : 27714014473
To Cell Number : 27714014473
Date Sent : 10/25/2018 14:17
Scheduled Time :
Message Status : SENT
Status Time :

Message

Middag Peter:Namas&Zonnequa Windkragaanlegte (Kleinsee); Ek verneem graag watter datum&tyd jou en jou kollegas sal pas vir 'n Fokusgroepvergadering die week van 12Nov2018.VriendelikeGroete NicoleneVenter (SavannahEnvironmental) 0833779112 or 0116563237

Rozanne Els

From: Nicolene Venter <nicolene@savannahsa.com>
Sent: 14 November 2018 7:55 AM
To: 'Conrad Geldenhuys'; 'Peter Cloete'
Cc: 'Rozanne Els'; 'Lisa Opperman'
Subject: Namas & Zonnequa WEF Basic Assessments: Strandveld Conservation Club

Dear Conrad,

Thank you for the information.

Kind regards,

Nicolene Venter

Public Participation & Social Consultant | Savannah Environmental (Pty) Ltd
Tel: +27 (0)11 656 3237 | Fax: +27 (0)86 684 0547

[SAWEA Award for Leading Environmental Consultant for Wind Projects in 2013 & 2015](#)

From: Conrad Geldenhuys <c.geldenhuys@hotmail.com>
Sent: Tuesday, November 13, 2018 11:43 AM
To: Nicolene Venter <nicolene@savannahsa.com>; 'Peter Cloete' <peter.denc87@gmail.com>
Cc: 'Rozanne Els' <rozanne@savannahsa.com>
Subject: Re: Namas & Zonnequa WEF Basic Assessments: FGM Presentation

Nicolene and Rozanne,

for your information the Goraap property northwest of the project site that is under negotiation for protection. It is owned by the Strandveld Conservation Club.

Regards
Conrad

From: Nicolene Venter <nicolene@savannahsa.com>
Sent: Tuesday, 13 November 2018 11:09 AM
To: 'Peter Cloete'; 'Conrad Geldenhuys'
Cc: 'Rozanne Els'
Subject: Namas & Zonnequa WEF Basic Assessments: FGM Presentation

Dear Peter and Conrad,

Please find attached a PDF copy of the Focus Group Meeting (FGM) presentation as presented at this morning's FGM.

Kind regards,

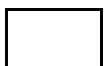

Virus-free. www.avast.com

Savannah Environmental Public Process

From: Nicolene Venter <nicolene@savannahsa.com>
Sent: 29 November 2018 10:03 AM
To: 'Conrad Geldenhuys'; 'Peter Cloete'
Cc: dmoleko@ncpg.gov.za; 'Lisa Opperman'; 'Savannah Environmental Public Process'
Subject: RE: Namas & Zonnequa Wind Farms: Confirmation of Comments from NC: DENC

Dear Conrad,

Thank you for the confirmation and information.

We will follow-up with Ms Moleko regarding the official comments.

Kind regards,

Nicolene Venter

Public Participation & Social Consultant | Savannah Environmental (Pty) Ltd
Tel: +27 (0)11 656 3237 | Fax: +27 (0)86 684 0547

[SAWEA Award for Leading Environmental Consultant for Wind Projects in 2013 & 2015](#)

From: Conrad Geldenhuys <c.geldenhuys@hotmail.com>
Sent: Thursday, November 29, 2018 8:31 AM
To: Nicolene Venter <nicolene@savannahsa.com>; 'Peter Cloete' <peter.denc87@gmail.com>
Cc: dmoleko@ncpg.gov.za; 'Lisa Opperman' <lisa.o@savannahsa.com>; 'Savannah Environmental Public Process' <publicprocess@savannahsa.com>
Subject: Re: Namas & Zonnequa Wind Farms: Confirmation of Comments from NC: DENC

Dear Nicolene,

comments by officials on assessments follow the line function within the department with supervisors/managers signing off on comments and recommendations as part of the EIA review process. The comments in our consultation meeting can therefore not be recorded as official comments on the assessments, since these were just discussion topics, questions for clarity and background information. I think you could however document the meeting we had for your records of course.

Note that Peter's laptop is in for repairs, so he may be delayed in responding to your email.

Regards
Conrad

From: Nicolene Venter <nicolene@savannahsa.com>
Sent: Wednesday, 28 November 2018 3:30 PM
To: 'Peter Cloete'; 'Conrad Geldenhuys'
Cc: dmoleko@ncpg.gov.za; 'Lisa Opperman'; 'Savannah Environmental Public Process'
Subject: Namas & Zonnequa Wind Farms: Confirmation of Comments from NC: DENC

Good Afternoon Peter and Conrad,

DEA Ref. Nos.: 14/12/16/3/3/1/1970 (Zonnequa Wind Farm) and 14/12/16/3/3/1/1971 (Namas Wind Farm)

I would like to take this opportunity to confirm whether the comments raised, and inputs received at the Focus Group Meeting (FGM) held Tuesday, 13 November 2018 at your Offices in Springbok can be recorded as comments received on the Basic Assessment Reports for the above-mentioned projects.

The meeting notes will be sent to you and Conrad by Friday, 30 November 2018.

Again, thank you for making time available in your busy schedule to meet with the project team.

Kind regards,



Virus-free. www.avast.com

savannah
environmental

t: +27 (0)11 656 3237
f: +27 (0) 86 684 0547

Nicolene Venter

Public Participation and Social
Consultant

e: nicolene@savannahsa.com
c: +27 (0) 83 377 9112

SAWEA Award for Leading Environmental Consultant on Wind Projects in 2013 & 2015

Savannah Environmental Public Process

From: Savannah Public Process <publicprocess@savannahsa.com>
Sent: 05 December 2018 10:58 AM
To: Peter Cloete; Conrad Geldenhuys
Cc: nicolene@savannahsa.com; publicprocess@savannahsa.com
Subject: Namas & Zonnequa Wind Farm Project: Meeting Notes & Appendices of Focus Group Meeting held 14 November 2018
Attachments: Namas&Zonnequa-FGM Notes-DENC (Complete Set).pdf

Dear Conrad & Peter,

Please find attached the Meeting Notes and associated Appendices of the Focus Group Meeting held on Tuesday, 13 November 2018 at your Offices in Springbok.

Please do not hesitate to contact us, should you need any further information or clarification.

kind regards,

Nicolene Venter

Public Participation and Social Consultant | Savannah Environmental (Pty) Ltd
Tel: +27 (0)11 656 3237 | Fax: +27 (0)86 684 0547

SAWEA Award for Leading Environmental Consultant for Wind Projects in 2013 & 2015

Savannah Environmental Public Process

From: John Geeringh <GeerinJH@eskom.co.za>
Sent: 06 November 2018 9:08 AM
To: Savannah Environmental Public Process
Subject: FW: Namas and Zonnequa WEF
Attachments: Eskom requirements for work in or near Eskom servitudes WIND (3).doc; Renewable Energy Generation Plant Setbacks to Eskom Infrastructure - Signed.pdf

Same applies?
John



From: John Geeringh
Sent: 01 November 2018 09:32 AM
To: Nicolene Venter (nicolene@savannahsa.com)
Subject: Namas and Zonnequa WEF

Please find attached Eskom requirements for works at or near Eskom infrastructure or servitudes. Please send me KMZ files of the affected properties and development layouts. Please send me the DEA reference numbers as soon as they become available.

Kind regards

John Geeringh (Pr Sci Nat)
Senior Consultant Environmental Management
Group Capital Division: Land Development and Management
Megawatt Park, D1Y42, Maxwell Drive, Sunninghill, Sandton.
P O Box 1091, Johannesburg, 2000.
Tel: 011 516 7233
Cell: 083 632 7663
Fax: 086 661 4064
E-mail: john.geeringh@eskom.co.za

NB: This Email and its contents are subject to the Eskom Holdings SOC Ltd EMAIL LEGAL NOTICE which can be viewed at http://www.eskom.co.za/Pages/Email_Legal_Spam_Disclaimer.aspx

	<p style="text-align: center;">SCOT</p>	<p style="text-align: center;">Technology</p>
---	--	--

Title: **Renewable Energy Generation Plant Setbacks to Eskom Infrastructure** Unique Identifier: **240-65559775**

Alternative Reference Number: **N/A**

Area of Applicability: **Power Line Engineering**

Documentation Type: **Guideline**

Revision: **0**

Total Pages: **8**

Next Review Date: **N/A**

Disclosure Classification: **CONTROLLED DISCLOSURE**

Compiled by



J W Chetty
Mechanical Engineer

Date: 20/02/2014

Approved by



V Naidoo
Chief Engineer (Lines)

Date: 24/02/2014

Authorised by

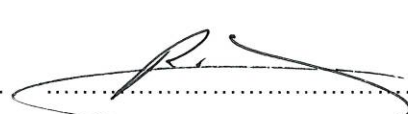

R A Vajeth
Acting Snr Manager (Lines)

Date: 27/2/2014

Supported by SCOT/SC



R Vajeth
SCOT/SC/ Chairperson

Date: 27/2/2014

PCM Reference: 240-65132732 **LINE ENGINEERING SERVICES**

SCOT Study Committee Number/Name : **OVERHEAD LINES**

CONTENTS

	Page
EXECUTIVE SUMMARY	3
1. INTRODUCTION.....	4
2. SUPPORTING CLAUSES	4
2.1 SCOPE	4
2.1.1 Purpose.....	4
2.1.2 Applicability	5
2.2 NORMATIVE/INFORMATIVE REFERENCES	5
2.2.1 Normative.....	5
2.2.2 Informative	5
2.3 DEFINITIONS	5
2.3.1 Disclosure Classification.....	6
2.4 ABBREVIATIONS	6
2.5 ROLES AND RESPONSIBILITIES	6
2.6 PROCESS FOR MONITORING	6
2.7 RELATED/SUPPORTING DOCUMENTS	6
3. DOCUMENT CONTENT	6
3.1 INTERNATIONAL SETBACK COMPARISON	6
3.2 ESKOM APPROACH FOR WIND FARMS.....	7
4. AUTHORISATION	8
5. REVISIONS.....	8
6. DEVELOPMENT TEAM	9

FIGURES

Figure 1: Horizontal Axis Wind Turbine	8
--	---

CONTROLLED DISCLOSURE

When downloaded from the EDMS, this document is uncontrolled and the responsibility rests with the user to ensure it is in line with the authorised version on the system.

EXECUTIVE SUMMARY

In recent decades, the use of wind turbines, concentrated solar plants and photovoltaic plants have been on the increase as it serves as an abundant source of energy. This document specifies setbacks for wind turbines and the reasons for these setbacks from infrastructure as well as setbacks for concentrated solar plants and photovoltaic plants. Setbacks for wind turbines employed in other countries were compared and a general setback to be used by Eskom was suggested for use with wind turbines and other renewable energy generation plants.

CONTROLLED DISCLOSURE

When downloaded from the EDMS, this document is uncontrolled and the responsibility rests with the user to ensure it is in line with the authorised version on the system.

1. INTRODUCTION

During the last few decades, a large amount of wind turbines have been installed in wind farms to accommodate for the large demand of energy and depleting fossil fuels. Wind is one of the most abundant sources of renewable energy. Wind turbines harness the energy of this renewable resource for integration in electricity networks. The extraction of wind energy is its primary function and thus the aerodynamics of the wind turbine is important. There are many different types of wind turbines which will all exhibit different wind flow characteristics. The most common wind turbine used commercially is the Horizontal Axis Wind Turbine. Wind flow characteristics of this turbine are important to analyse as it may have an effect on surrounding infrastructure.

Wind turbines also cause large turbulence downwind that may affect existing infrastructure. Debris or parts of the turbine blade, in the case of a failure, may be tossed behind the turbine and may lead to damage of infrastructure in the wake path.

This document outlines the minimum distances that need to be introduced between a wind turbine and Eskom infrastructure to ensure that debris and / or turbulence would not negatively impact on the infrastructure.

Safety distances of wind turbines from other structures as implemented by other countries were also considered and the reasons for their selection were noted.

Concentrated solar plants and photovoltaic plants setbacks away from substations were also to be considered to prevent restricting possible power line access routes to the substation.

2. SUPPORTING CLAUSES

2.1 SCOPE

This document provides guidance on the safe distance that a wind turbine should be located from any Eskom power line or substation. The document specifies setback distances for transmission lines (220 kV to 765 kV), distribution lines (6.6 kV to 132 kV) and all Eskom substations. Setbacks for concentrated solar plants and photovoltaic plants are also specified away from substations.

2.1.1 Purpose

Setbacks for wind turbines and power lines / substations are required for various reasons. These include possible catastrophic failure of the turbine blade that may release fragments and which may be thrown onto nearby power lines that may result in damage with associated unplanned outages. Turbulence behind the turbine may affect helicopter flight during routine Eskom live line maintenance and

CONTROLLED DISCLOSURE

When downloaded from the EDMS, this document is uncontrolled and the responsibility rests with the user to ensure it is in line with the authorised version on the system.

inspections that may lead to safety risk of the aircraft / personnel. Concentrated solar plants and photovoltaic plants setback away from substations were required to prevent substations from being boxed in by these renewable generation plants limiting line route access to the substations.

2.1.2 Applicability

This document is applicable to the siting of all new and existing wind turbines, concentrated solar plants and photovoltaic plants near power lines and substations.

2.2 NORMATIVE/INFORMATIVE REFERENCES

2.2.1 Normative

1. <http://www.envir.ee/orb.aw/class=file/action=preview/id=1170403/Hiiumaa+turbulence+impact+EMD.pdf>.
2. <http://www.energy.ca.gov/2005publications/CEC-500-2005-184/CEC-500-2005-184.PDF>
3. <http://www.adamscountywind.com/Revised%20Site/Windmills/Adams%20County%20Ordinance/Adams%20County%20Wind%20Ord.htm>
4. http://www.dsireusa.org/incentives/incentive.cfm?Incentive_Code=PA11R&RE=1&EE=1
5. <http://www.wind-watch.org/documents/european-setbacks-minimum-distance-between-wind-turbines-and-habitations/>
6. <http://www.publications.parliament.uk/pa/ld201011/ldbills/017/11017.1-i.html>
7. http://www.caw.ca/assets/pdf/Turbine_Safety_Report.pdf
8. Rogers J, Slegers N, Costello M. (2011) A method for defining wind turbine setback standards. Wind energy 10.1002/we.468

2.2.2 Informative

None

2.3 DEFINITIONS

Definition	Description
Setback	The minimum distance between a wind turbine and boundary line/dwelling/road/infrastructure/servitude etc.
Flicker	Effect caused when rotating wind turbine blades periodically cast shadows
Tip Height	The total height of the wind turbine ie. Hub height plus half rotor diameter (see Figure1)

CONTROLLED DISCLOSURE

When downloaded from the EDMS, this document is uncontrolled and the responsibility rests with the user to ensure it is in line with the authorised version on the system.

2.3.1 Disclosure Classification

Controlled disclosure: controlled disclosure to external parties (either enforced by law, or discretionary).

2.4 ABBREVIATIONS

Abbreviation	Description
None	

2.5 ROLES AND RESPONSIBILITIES

All personnel involved in the positioning wind turbines, concentrated solar plants and photovoltaic plants near power lines/substations must follow the setbacks outlined in this guideline.

2.6 PROCESS FOR MONITORING

Approval by Eskom in writing.

2.7 RELATED/SUPPORTING DOCUMENTS

None

3. DOCUMENT CONTENT

3.1 INTERNATIONAL SETBACK COMPARISON

Wind Turbine setbacks employed by various countries were considered. It was found that setbacks were determined for various reasons that include noise, flicker, turbine blade failure and wind effects. The distances (setbacks) varied based on these factors and were influenced by the type of infrastructure

Wind turbine setbacks varied for roads, power lines, dwellings, buildings and property and it was noted that the largest setbacks were employed for reasons of noise and flicker related issues [1-7]. Very few countries specified setbacks for power lines.

The literature survey [1-7], yielded information about studies and experiments were conducted to determine the distance that a broken fragment from a wind turbine might be thrown. Even though of low probability of hitting a power line [5.0×10^{-5}]^[8], the distances recorded were significant [750m]^[8]

Setbacks were thus introduced to prevent any damage to Eskom infrastructure.

CONTROLLED DISCLOSURE

When downloaded from the EDMS, this document is uncontrolled and the responsibility rests with the user to ensure it is in line with the authorised version on the system.

Wind turbines may also cause changes in wind patterns with turbulent effects behind the hub. These factors dictate the wind turbine setbacks specified in this document.

Concentrated solar plants and photovoltaic plants also can limit access into the substation for power lines of all voltages. A setback distance must therefore be employed to prevent the substation from being boxed in by these generation plants. These setback distances are specified in this document.

3.2 ESKOM REQUIRED SETBACKS

- Eskom requires a setback distance of 3 times the tip height of the wind turbine from the edge of the closest Eskom servitude (including vacant servitudes) for transmission lines.
- Eskom requires a setback distance of 1 times the tip height of the wind turbine from the edge of the closest Eskom servitude (including vacant servitudes) for distribution Lines.
- Eskom must be informed of any proposed wind turbine, concentrated solar plants and photovoltaic activity within a 5 km radius of a substation. No wind turbine structure shall be built within a 2 km radius of the closest point of the substation. Where concentrated solar plants and photovoltaic structures fall within a 2 km radius of the closest point of a substation, Eskom should be informed in writing during the planning phase of the construction of such plant or structure.
- Applicants must show that Eskom radio telecommunication systems (mainly microwave systems) will not be affected in any way by wind turbines.

CONTROLLED DISCLOSURE

When downloaded from the EDMS, this document is uncontrolled and the responsibility rests with the user to ensure it is in line with the authorised version on the system.

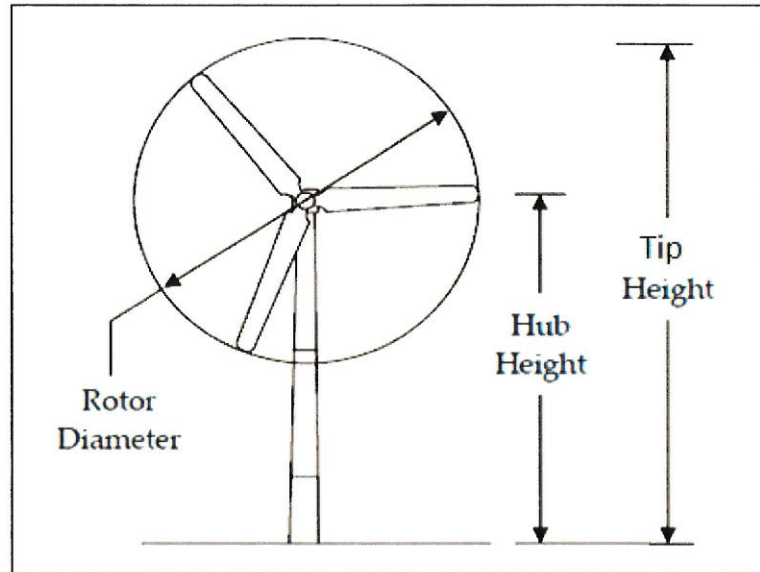

Figure 1: Horizontal Axis Wind Turbine ^[2]

4. AUTHORISATION

This document has been seen and accepted by:

Name & Surname	Designation
V Naidoo	Chief Engineer
Dr P H Pretorius	Electrical Specialist
J Geeringh	Snr Consultant Environ Mngt
B Haridass	Snr Consultant Engineer
R A Vajeth	Acting Snr Manager (Lines)

5. REVISIONS

Date	Rev.	Compiler	Remarks
November 2013	0	J W Chetty	First Publication - No renewable energy generation plant setback specification in existence

CONTROLLED DISCLOSURE

When downloaded from the EDMS, this document is uncontrolled and the responsibility rests with the user to ensure it is in line with the authorised version on the system.

6. DEVELOPMENT TEAM

The following people were involved in the development of this document:

Jonathan W Chetty (Mechanical Engineer)

Vivendhra Naidoo (Chief Engineer)

Dr Pieter H Pretorius (Electrical Specialist)

John Geeringh (Snr Consultant Environ Mngt)

Bharat Haridass (Snr Consultant Engineer)

Riaz A Vajeth (Acting Snr Manager (Lines))

CONTROLLED DISCLOSURE

When downloaded from the EDMS, this document is uncontrolled and the responsibility rests with the user to ensure it is in line with the authorised version on the system.

Eskom requirements for work at or near Eskom infrastructure.

1. Eskom's rights and services must be acknowledged and respected at all times.
2. Eskom shall at all times retain unobstructed access to and egress from its servitudes.
3. Eskom's consent does not relieve the developer from obtaining the necessary statutory, land owner or municipal approvals.
4. Any cost incurred by Eskom as a result of non-compliance to any relevant environmental legislation will be charged to the developer.
5. If Eskom has to incur any expenditure in order to comply with statutory clearances or other regulations as a result of the developer's activities or because of the presence of his equipment or installation within the servitude restriction area, the developer shall pay such costs to Eskom on demand.
6. The use of explosives of any type within 500 metres of Eskom's services shall only occur with Eskom's previous written permission. If such permission is granted the developer must give at least fourteen working days prior notice of the commencement of blasting. This allows time for arrangements to be made for supervision and/or precautionary instructions to be issued in terms of the blasting process. It is advisable to make application separately in this regard.
7. Changes in ground level may not infringe statutory ground to conductor clearances or statutory visibility clearances. After any changes in ground level, the surface shall be rehabilitated and stabilised so as to prevent erosion. The measures taken shall be to Eskom's satisfaction.
8. Eskom shall not be liable for the death of or injury to any person or for the loss of or damage to any property whether as a result of the encroachment or of the use of the servitude area by the developer, his/her agent, contractors, employees, successors in title, and assignees. The developer indemnifies Eskom against loss, claims or damages including claims pertaining to consequential damages by third parties and whether as a result of damage to or interruption of or interference with Eskom's services or apparatus or otherwise. Eskom will not be held responsible for damage to the developer's equipment.
9. No mechanical equipment, including mechanical excavators or high lifting machinery, shall be used in the vicinity of Eskom's apparatus and/or services, without prior written permission having been granted by Eskom. If such permission is granted the developer must give at least seven working days' notice prior to the commencement of work. This allows time for arrangements to be made for supervision and/or precautionary instructions to be issued by the relevant Eskom Manager

Note: Where and electrical outage is required, at least fourteen work days are required to arrange it.

10. Eskom's rights and duties in the servitude shall be accepted as having prior right at all times and shall not be obstructed or interfered with.
11. Under no circumstances shall rubble, earth or other material be dumped within the servitude restriction area. The developer shall maintain the area concerned to Eskom's satisfaction. The developer shall be liable to Eskom for the cost of any remedial action which has to be carried out by Eskom.
12. The clearances between Eskom's live electrical equipment and the proposed construction work shall be observed as stipulated by *Regulation 15 of the Electrical Machinery Regulations of the Occupational Health and Safety Act, 1993 (Act 85 of 1993)*.
13. Equipment shall be regarded electrically live and therefore dangerous at all times.
14. In spite of the restrictions stipulated by Regulation 15 of the Electrical Machinery Regulations of the Occupational Health and Safety Act, 1993 (Act 85 of 1993), as an additional safety precaution, Eskom will not approve the erection of houses, or structures occupied or frequented by human beings, under the power lines or within the servitude restriction area.
15. Eskom may stipulate any additional requirements to highlight any possible exposure to Customers or Public to coming into contact or be exposed to any dangers of Eskom plant.
16. It is required of the developer to familiarise himself with all safety hazards related to Electrical plant.
17. Any third party servitudes encroaching on Eskom servitudes shall be registered against Eskom's title deed at the developer's own cost. If such a servitude is brought into being, its existence should be endorsed on the Eskom servitude deed concerned, while the third party's servitude deed must also include the rights of the affected Eskom servitude.

John Geeringh (Pr Sci Nat)

Senior Consultant Environmental Management
Eskom GC: Land Development

Rozanne Els

From: Nicolene Venter <nicolene@savannahsa.com>
Sent: 22 November 2018 5:02 PM
To: tamai.hore@nersa.org.za
Cc: 'Rozanne Els'
Subject: NERSA Acknowledgement of Removal of Contact Details

Dear Ms Hore,

We apologise for any inconvenience cause and please be informed that no further e-mail notification will be send to you.

Kind regards,

Nicolene Venter

Public Participation & Social Consultant | Savannah Environmental (Pty) Ltd
Tel: +27 (0)11 656 3237 | Fax: +27 (0)86 684 0547

[SAWEA Award for Leading Environmental Consultant for Wind Projects in 2013 & 2015](#)

From: Tamai Hore [<mailto:Tamai.Hore@nersa.org.za>]
Sent: 22 November 2018 2:54 PM
To: Savannah Public Process <publicprocess@savannahsa.com>
Subject: RE: ZONNEQUA WIND FARM: NOTIFICATION OF AVAILABILITY OF BASIC ASSESSMENT REPORT FOR REVIEW AND COMMENT

I requested Savannah to STOP sending your emails to me and got an email confirming that my email address is removed from your emailing list so I am surprised that I received two of your emails today.

Regards
Tamai

From: Savannah Public Process [<mailto:publicprocess@savannahsa.com>]
Sent: 22 November 2018 01:15 PM
Subject: ZONNEQUA WIND FARM: NOTIFICATION OF AVAILABILITY OF BASIC ASSESSMENT REPORT FOR REVIEW AND COMMENT

Dear Stakeholder,

With reference to the attached notification letter and emails below, this email serves as a reminder that the comment period ends **Tomorrow, Friday the 23rd November 2018.**

Kindly submit your comments by **Tomorrow, Friday the 23rd November 2018**, by close of business.

Thank you and kind regards,

Rozanne Els

Public Participation Co-ordinator | Savannah Environmental (Pty) Ltd
Tel: +27 (0)11 656 3237 | Fax: +27 (0)86 684 0547

SAWEA Award for Leading Environmental Consultant for Wind Projects in 2013 & 2015

> From: Savannah Public Process <publicprocess@savannahsa.com>
> Date Sent: 16/11/2018 09:42
> To:
> Cc:
> Subject: FW: ZONNEQUA WIND FARM: NOTIFICATION OF AVAILABILITY OF BASIC ASSESSMENT REPORT FOR REVIEW AND COMMENT
>

Dear Stakeholder,

With reference to the attached notification letter and email below, this email serves as a reminder that the comment period ends on **Friday, 23 November 2018**.

Kindly submit your comments on or before **Friday, 23 November 2018** by close of business.

Thank you and kind regards,

Rozanne Els

Public Participation Co-ordinator | Savannah Environmental (Pty) Ltd
Tel: +27 (0)11 656 3237 | Fax: +27 (0)86 684 0547

SAWEA Award for Leading Environmental Consultant for Wind Projects in 2013 & 2015

> From: Savannah Public Process
> Date Sent: 23/10/2018 09:30
> To:
> Cc:
> Subject: FW: ZONNEQUA WIND FARM: NOTIFICATION OF AVAILABILITY OF BASIC ASSESSMENT REPORT FOR REVIEW AND COMMENT
>

Dear Stakeholder,

A wind farm is proposed to be developed within the Springbok Renewable Energy Development Zone (REDZ), approximately 20 km south-east of the town of Kleinsee in the Northern Cape. The wind farm is known as the **Zonnequa Wind Farm** and is located within the Nama Khoi Local Municipality and the Namakwa District Municipality.

It is Genesis Zonnequa Wind (Pty) Ltd's, the developer, intention to bid the Zonnequa Wind Farm project under the Department of Energy's (DoE) Renewable Energy Independent Power Producer Procurement (REIPPP) Programme. The power generated from the project will be sold to Eskom and will feed into the national electricity grid. The development of the project will also assist with achieving the electricity generation goals as set out in the Integrated Resources Plan.

This e-mail serves to inform you, as a registered Interested and Affected Party (I&AP), that in terms of the National Environmental Management Act (No. 107 of 1998) (NEMA) and the 2014 Environmental Impact Assessment (EIA) Regulations, as amended in April 2017, that the Basic Assessment Report (BAR) is available for your review and comment.

The hard copy of the BAR can be viewed at the Kleinsee Library (3rd Avenue, Kleinsee, open on Tuesdays & Thursdays between 11h00 and 17h00) from **Wednesday, 24 October 2018** to **Friday, 23 November 2018**. An electronic copy can be downloaded from our website (<http://www.savannahsa.com/public-documents/energy-generation/zonnequa-wind-farm/>).

Please refer to the attached letter for further details in this regard.

Kind regards,

Nicolene Venter

Public Participation and Social Consultant | Savannah Environmental (Pty) Ltd
Tel: +27 (0)11 656 3237 | Mobile: +27 83 377 9112 | Fax: +27 (0)86 684 0547

SAWEA Award for Leading Environmental Consultant for Wind Projects in 2013 & 2015

▪



Virus-free. www.avast.com

Nicolene Venter

From: Lisa Opperman <lisa.o@savannahsa.com>
Sent: Thursday, October 25, 2018 4:35 PM
To: Dmoleko@ncpg.gov.za
Cc: 'Nicolene Venter'
Subject: FW: Namas Wind Farm and Zonnequa Wind Farm - DEA Application Forms

Good Day Dineo,

I trust you are well.

I have been trying to send the email below to you, however it keeps on bouncing back. I have two files (3MB) each which is attached to the mail below.

Kindly advise whether you have a limit on the size of the files which you are able to receive?

Kind regards
Lisa

Lisa Opperman

Environmental Consultant | Savannah Environmental (Pty) Ltd
Tel: +27 (0)11 656 3237 | Fax: +27 (0)86 684 0547

[SAWEA Award for Leading Environmental Consultant for Wind Projects in 2013 & 2015](#)

From: Lisa Opperman [mailto:lisa.o@savannahsa.com]
Sent: Thursday, October 25, 2018 12:32 PM
To: 'Dmoleko@ncpg.gov.za' <Dmoleko@ncpg.gov.za>
Cc: 'Nicolene Venter' <nicolene@savannahsa.com>
Subject: Namas Wind Farm and Zonnequa Wind Farm - DEA Application Forms

Dear Dineo,

I trust you are well.

Savannah Environmental is in the process of undertaking two separate Basic Assessments for the Namas Wind Farm and the Zonnequa Wind Farm near Kleinsee. The projects are also located within the Springbok REDZ.

As per the requirements of the DEA Application Form for Environmental Authorisation, the DEA application form must also be provided to the Provincial Environmental Department. This is as per number 15 of the requirements included on page 2 of the applications as attached.

Therefore, this email serves to formally submit the application forms for the two projects to you as per the requirement.

Kindly also note that a CD containing the Basic Assessment reports for review has been couriered to the DENC for comment.

Kindly acknowledge receipt of this email.

Please let me know should you require any further information.

Kind regards
Lisa

Rozanne Els

From: Nicolene Venter <nicolene@savannahsa.com>
Sent: 05 November 2018 6:36 AM
To: dmoleko@ncpg.gov.za
Cc: 'Rozanne Els'
Subject: Basic Assessments: Namas & Zonnequa Wind Farm Projects Invitation to Focus Group Meeting - Namas & Z
Attachments: Namas&Zonnequa WEF-FGM DENC InviteLetter.pdf
Importance: High

Dear Ms Moleko,

Two 140MW wind farms are proposed to be developed on adjacent sites within the Springbok REDZ, approximately 20 km south of the town of Kleinsee in the Northern Cape. The wind farms are known as the **Namas Wind Farm** and the **Zonnequa Wind Farm** and are within the Nama Khoi Local Municipality and the Namakwa District Municipality. A suitable project site for the development of each of the wind farms has been identified by the project development companies.

We would like to take this opportunity of inviting the relevant Officials from your Department to attend the Focus Group Meeting (FGM) scheduled to take place:

- **DATE:** Tuesday, 13 November 2018
- **TIME:** 09H00
- **VENUE:** DENC Offices, Springbok

We are looking forward to hear from you.

Kind regards,



Virus-free. www.avast.com

savannah
environmental

t: +27 (0)11 656 3237
f: +27 (0) 86 684 0547

Nicolene Venter

Public Participation and Social
Consultant

e: nicolene@savannahsa.com
c: +27 (0) 83 377 9112

SAWEA Award for Leading Environmental Consultant on Wind Projects in 2013 & 2015

01 November 2018

Ms Dineo Moleka
Assistant Director: Impact Management
Department of Environment and Nature Conservation
KIMBERLEY

By e-mail: dmoleko@ncpg.gov.za

**BASIC ASSESSMENTS: NAMAS AND ZONNEQUA WIND FARM PROJECTS NEAR KLEINSEE,
NORTHERN CAPE PROVINCE**

FOCUS GROUP MEETING: Tuesday, 13 November 2018

Two 140MW wind farms are proposed to be developed on adjacent sites within the Springbok REDZ, approximately 20 km south of the town of Kleinsee in the Northern Cape. The wind farms are known as the **Namas Wind Farm** and the **Zonnequa Wind Farm** and are within the Nama Khoi Local Municipality and the Namakwa District Municipality. A suitable project site for the development of each of the wind farms has been identified by the project development companies. The affected properties will include the following:

Project Name	Namas Wind Farm	Zonnequa Wind Farm
Applicant	Genesis Namas Wind (Pty) Ltd	Genesis Zonnequa Wind (Pty) Ltd
Affected properties	<ul style="list-style-type: none"> » Portion 3 of the Farm Zonnekwa 328 » Portion 4 of the Farm Zonnekwa 328 » Remaining Extent of the Farm Rooivlei 327 » Portion 3 of the Farm Rooivlei 327 	<ul style="list-style-type: none"> » Portion 1 of the Farm Zonnekwa 328 » Remaining Extent of the Farm Zonnekwa 326

We would like to take this opportunity to invite the Northern Cape Department of Environment and Nature Conservation (DENC) to attend the Focus Group Meeting (FGM) to take place on:

DATE: Tuesday, 13 November 2018

TIME: 09h00 – 10h30

VENUE: Boardroom, Department of Environment and Nature Conservation, Springbok

The purpose of inviting the FGM is to present the following:

- background to the proposed project;
- an overview of the Basic Assessments process followed;
- an opportunity to seek clarity and raise comments; and
- an opportunity to liaise with the project team members.

Officials from the DENC are also welcome to nominate a colleague to attend the meeting should they not be available to attend.

We encourage the DENC Officials to attend the Focus Group Meeting and to participate in the Public Participation Process. We would like to thank you in anticipation for your active and meaningful contribution to the BAs' process.

Please do not hesitate to contact us should you require additional information and/or clarification regarding the proposed project. Our team welcomes your participation and looks forward to your involvement throughout this process.

Kind regards



Nicolene Venter
Public Participation and Social Consultant
Savannah Environmental

CC: Mr. Peter Cloete, Candidate Scientist: District Ecologist, Research and Development Support Section

Rozanne Els

From: Nicolene Venter <nicolene@savannahsa.com>
Sent: 09 November 2018 12:59 PM
To: dmoleko@ncpg.gov.za
Cc: 'Peter Cloete'; 'Rozanne Els'; 'Louise Geldenhuys'; 'Conrad Geldenhuys'; 'Samantha De la Fontaine'; 'Nanine van Olmen Phillips'; 'Adeleen Cloete'; 'Bronwen Cornelissen'; 'Elsabe Swart'
Subject: Basic Assessments: Namas & Zonnequa Wind Farm Projects Invitation to Focus Group Meeting (Tuesday, 13 November 2018)
Attachments: Namas&Zonnequa WEF-FGM DENC InviteLetter.pdf
Importance: High

Good Day Ms Moleko,

With reference to our Focus Group Meeting invitation to the Department of Environment and Nature Conservation (DENC), Northern Cape Province, it would be appreciated if it can be confirmed that you will be attending the meeting and that the relevant DENC Officials in Springbok has been informed of the FGM.

We are looking forward to your response.

Kind regards,

Nicolene Venter

Public Participation & Social Consultant | Savannah Environmental (Pty) Ltd
Tel: +27 (0)11 656 3237 | Fax: +27 (0)86 684 0547

[SAWEA Award for Leading Environmental Consultant for Wind Projects in 2013 & 2015](#)

From: Nicolene Venter <nicolene@savannahsa.com>
Sent: Monday, November 5, 2018 6:36 AM
To: 'dmoleko@ncpg.gov.za' <dmoleko@ncpg.gov.za>
Cc: 'Rozanne Els' <rozanne@savannahsa.com>
Subject: Basic Assessments: Namas & Zonnequa Wind Farm Projects Invitation to Focus Group Meeting - Namas & Z
Importance: High

Dear Ms Moleko,

Two 140MW wind farms are proposed to be developed on adjacent sites within the Springbok REDZ, approximately 20 km south of the town of Kleinsee in the Northern Cape. The wind farms are known as the **Namas Wind Farm** and the **Zonnequa Wind Farm** and are within the Nama Khoi Local Municipality and the Namakwa District Municipality. A suitable project site for the development of each of the wind farms has been identified by the project development companies.

We would like to take this opportunity of inviting the relevant Officials from your Department to attend the Focus Group Meeting (FGM) scheduled to take place:

- **DATE:** Tuesday, 13 November 2018
- **TIME:** 09H00
- **VENUE:** DENC Offices, Springbok

We are looking forward to hear from you.

Savannah Environmental Public Process

From: Savannah Environmental Public Process <publicprocess@savannahsa.com>
Sent: 21 November 2018 1:59 PM
To: 'Samantha Ralston-Paton'
Subject: RE: Request fro Comment: Namas & Zonnequa Wind Farms

Dear Samantha,

Please see below:

Namas LEk87*56\Kllqqh
Zonnequa 75j744}7Drf6

Let me know if there is anything else I can assist with.

Kind regards,

Rozanne Els

Public Participation Co-ordinator | Savannah Environmental (Pty) Ltd
Tel: +27 (0)11 656 3237 | Fax: +27 (0)86 684 0547

[SAWEA Award for Leading Environmental Consultant for Wind Projects in 2013 & 2015](#)

From: Samantha Ralston-Paton [mailto:energy@birdlife.org.za]
Sent: 21 November 2018 11:04 AM
To: Savannah Environmental Public Process <publicprocess@savannahsa.com>
Subject: Re: Request fro Comment: Namas & Zonnequa Wind Farms
Importance: High

Good Day

Please send me the password so I can download these docs asap. I'd appreciate it if you automatically sent the passwords will all wind energy facility notifications.

Regards

Sam

Samantha Ralston-Paton

Birds and Renewable Energy Manager

Rozanne Els

From: Nicolene Venter <nicolene@savannahsa.com>
Sent: 09 November 2018 12:14 PM
To: 'Paulus Van Reenen'
Cc: 'Rozanne Els'
Subject: Namas&Zonnequa: Fokusgroepvergadering - Nama Khoi Plaaslike Munisipaliteit

Middag Raadslid Van Reenen,

Graag bevestig ek dat die vergadering met u en u Wykskomiteelede gehou gaan word by die Blue Dimond Lodge, Uniestraat 19, Springbok op:

- Dinsdag, 13 November 2018
- Om 11h00

Vriendelike groete

Nicolene Venter

Public Participation & Social Consultant | Savannah Environmental (Pty) Ltd
Tel: +27 (0)11 656 3237 | Fax: +27 (0)86 684 0547

[SAWEA Award for Leading Environmental Consultant for Wind Projects in 2013 & 2015](#)

From: Paulus Van Reenen <Paulus.VanReenen@namakhoi.gov.za>
Sent: Friday, November 9, 2018 12:00 PM
To: nicolene@savannahsa.com
Subject: Vergadering te Houthoop

Goeiedag Nicolene

Die volgende persone sal ook die vergadering bywoon

Marion Daniels

Randica Milfordt - 0789768196

Paulus van Reenen - 0761138491

Baie dankie

P van Reenen

Sent from Samsung tablet

This email was scanned by Bitdefender

Disclaimer

The information contained in this communication from the sender is confidential. It is intended solely for use by the recipient and others authorized to receive it. If you are not the recipient, you are hereby notified that any disclosure, copying, distribution or taking action in relation of the contents of this information is strictly prohibited and may be unlawful.

This email has been scanned for viruses and malware, and may have been automatically archived by **Mimecast Ltd**, an innovator in Software as a Service (SaaS) for business. Providing a **safer** and **more useful** place for your human generated data. Specializing in; Security, archiving and compliance. To find out more [Click Here](#).

Rozanne Els

From: Nicolene Venter <nicolene@savannahsa.com>
Sent: 13 November 2018 7:01 PM
To: 'Paulus Van Reenen'; dbugan55@gmail.com
Cc: 'Rozanne Els'
Subject: Namas & Zonnequa Windplaas en Kraglyn Projekte: Aanbiedingsmateriaal - Fokusgroepvergadering, Dinsdag, 13 November 2018
Attachments: Namas & Zonnequa WEF & PL FGMs Presentation (13-14 Nov 2018).pdf

Middag Raadslid Van Reenen en Mnr Bugan,

Soos bespreek tydens vanmiddag se Fokusgroepvergadering, vind asseblief aangeheg 'n elektroniese kopie van die aanbiedingsmateriaal soos aangebied tydens vanmiddag se vergadering.

Vriendelike groete,



Virus-free. www.avast.com

savannah
environmental

t: +27 (0)11 656 3237
f: +27 (0) 86 684 0547

Nicolene Venter

Public Participation and Social
Consultant

e: nicolene@savannahsa.com
c: +27 (0) 83 377 9112

[SAWEA Award for Leading Environmental Consultant on Wind Projects in 2013 & 2015](#)

Rozanne Els

From: Nicolene Venter <nicolene@savannahsa.com>
Sent: 26 November 2018 4:37 PM
To: 'Paulus Van Reenen'
Cc: 'Lisa opperman'; 'Rozanne Els'
Subject: RE: REMINDER: ZONNEQUA WIND FARM: NOTIFICATION OF AVAILABILITY OF BASIC ASSESSMENT REPORT FOR REVIEW AND COMMENT

Middag Raadslid Van Reenen,

Namens die projekspan wil ek ook vir u dankie sê vir die insette wat u en die Wykskomiteede gelewer het.

Mag u dag en feesgety geseënd wees.

Groete

Nicolene Venter

Public Participation & Social Consultant | Savannah Environmental (Pty) Ltd
Tel: +27 (0)11 656 3237 | Fax: +27 (0)86 684 0547

[SAWEA Award for Leading Environmental Consultant for Wind Projects in 2013 & 2015](#)

From: Paulus Van Reenen <Paulus.VanReenen@namakhoi.gov.za>
Sent: Monday, November 26, 2018 3:42 PM
To: nicolene@savannahsa.com
Subject: Fwd: REMINDER: ZONNEQUA WIND FARM: NOTIFICATION OF AVAILABILITY OF BASIC ASSESSMENT REPORT FOR REVIEW AND COMMENT

Die voorlegging was goed, alle voorspoed voorentoe met die Projek.

Wens u ñ geseende fees seisoen toe

Wyk 8 Raadslid en Wykskomitee

Sent from Samsung tablet

----- Original message -----

From: Savannah Public Process <publicprocess@savannahsa.com>
Date: 23/11/2018 07:25 (GMT+02:00)
To:
Subject: REMINDER: ZONNEQUA WIND FARM: NOTIFICATION OF AVAILABILITY OF BASIC ASSESSMENT REPORT FOR REVIEW AND COMMENT

Dear Stakeholder,

With reference to the attached notification letter and emails below, this email serves as a reminder that the comment period ends **Today, Friday the 23rd of November 2018**.

Kindly submit your comments **Today, Friday the 23rd of November 2018**, by close of business.

Thank you and kind regards,

Rozanne Els

Public Participation Co-ordinator | Savannah Environmental (Pty) Ltd
Tel: +27 (0)11 656 3237 | Fax: +27 (0)86 684 0547

SAWEA Award for Leading Environmental Consultant for Wind Projects in 2013 & 2015

> From: Savannah Public Process <publicprocess@savannahsa.com>
> Date Sent: 22/11/2018 13:14
> To:
> Cc:
> Subject: FW: ZONNEQUA WIND FARM: NOTIFICATION OF AVAILABILITY OF BASIC ASSESSMENT REPORT FOR REVIEW AND COMMENT
>

Dear Stakeholder,

With reference to the attached notification letter and emails below, this email serves as a reminder that the comment period ends **Tomorrow, Friday the 23rd November 2018**.

Kindly submit your comments by **Tomorrow, Friday the 23rd November 2018**, by close of business.

Thank you and kind regards,

Rozanne Els

Public Participation Co-ordinator | Savannah Environmental (Pty) Ltd
Tel: +27 (0)11 656 3237 | Fax: +27 (0)86 684 0547

SAWEA Award for Leading Environmental Consultant for Wind Projects in 2013 & 2015

> From: Savannah Public Process
> Date Sent: 16/11/2018 09:42
> To:
> Cc:
> Subject: FW: ZONNEQUA WIND FARM: NOTIFICATION OF AVAILABILITY OF BASIC ASSESSMENT REPORT FOR REVIEW AND COMMENT
>

Dear Stakeholder,

With reference to the attached notification letter and email below, this email serves as a reminder that the comment period ends on **Friday, 23 November 2018.**

Kindly submit your comments on or before **Friday, 23 November 2018** by close of business.

Thank you and kind regards,

Rozanne Els

Public Participation Co-ordinator | Savannah Environmental (Pty) Ltd
Tel: +27 (0)11 656 3237 | Fax: +27 (0)86 684 0547

SAWEA Award for Leading Environmental Consultant for Wind Projects in 2013 & 2015

> From: Savannah Public Process
> Date Sent: 23/10/2018 09:30
> To:
> Cc:
> Subject: FW: ZONNEQUA WIND FARM: NOTIFICATION OF AVAILABILITY OF BASIC ASSESSMENT REPORT FOR REVIEW AND COMMENT
>

Dear Stakeholder,

A wind farm is proposed to be developed within the Springbok Renewable Energy Development Zone (REDZ), approximately 20 km south-east of the town of Kleinsee in the Northern Cape. The wind farm is known as the **Zonnequa Wind Farm** and is located within the Nama Khoi Local Municipality and the Namakwa District Municipality.

It is Genesis Zonnequa Wind (Pty) Ltd's, the developer, intention to bid the Zonnequa Wind Farm project under the Department of Energy's (DoE) Renewable Energy Independent Power Producer Procurement

(REIPPP) Programme. The power generated from the project will be sold to Eskom and will feed into the national electricity grid. The development of the project will also assist with achieving the electricity generation goals as set out in the Integrated Resources Plan.

This e-mail serves to inform you, as a registered Interested and Affected Party (I&AP), that in terms of the National Environmental Management Act (No. 107 of 1998) (NEMA) and the 2014 Environmental Impact Assessment (EIA) Regulations, as amended in April 2017, that the Basic Assessment Report (BAR) is available for your review and comment.

The hard copy of the BAR can be viewed at the Kleinsee Library (3rd Avenue, Kleinsee, open on Tuesdays & Thursdays between 11h00 and 17h00) from **Wednesday, 24 October 2018** to **Friday, 23 November 2018**. An electronic copy can be downloaded from our website (<http://www.savannahsa.com/public-documents/energy-generation/zonnequa-wind-farm/>).

Please refer to the attached letter for further details in this regard.

Kind regards,

Nicolene Venter

Public Participation and Social Consultant | Savannah Environmental (Pty) Ltd
Tel: +27 (0)11 656 3237 | Mobile: +27 83 377 9112 | Fax: +27 (0)86 684 0547

SAWEA Award for Leading Environmental Consultant for Wind Projects in 2013 & 2015

This email was scanned by Bitdefender

Disclaimer

The information contained in this communication from the sender is confidential. It is intended solely for use by the recipient and others authorized to receive it. If you are not the recipient, you are hereby notified that any disclosure, copying, distribution or taking action in relation of the contents of this information is strictly prohibited and may be unlawful.

This email has been scanned for viruses and malware, and may have been automatically archived by **Mimecast Ltd**, an innovator in Software as a Service (SaaS) for business. Providing a **safer** and **more useful** place for your human generated data. Specializing in; Security, archiving and compliance. To find out more [Click Here](#).



Virus-free. www.avast.com

Savannah Environmental Public Process

From: Savannah Public Process <publicprocess@savannahsa.com>
Sent: 05 December 2018 11:11 AM
To: Dominic Bagan; Paulus van Reenen
Cc: nicolene@savannahsa.com; publicprocess@savannahsa.com
Subject: Namas & Zonnequa Wind Farm Project: Meeting Notes & Appendices of Focus Group Meeting held 13 November 2018
Attachments: Namas&Zonnequa-FGM Notes-Local Authorities (CompleteSet)-compressed.pdf

Beste Raadslid Van Reenen en Wyksraadslede (Me Laura Diergaardt, Me Elmarie Julie en Mnr Dominic Bagan)

Vind asseblief hierby aangeheg die Vergaderingsnotas van die Fokusgroepvergadering gehou op Dinsdag, 13 November 2018 te Springbok.

Moet asseblief nie huiwer om ons te kontak indien u enige addisionele inligting of uitklarings verlang nie.

Vriendelike groete,

Nicolene Venter

Public Participation and Social Consultant | Savannah Environmental (Pty) Ltd
Tel: +27 (0)11 656 3237 | Fax: +27 (0)86 684 0547

SAWEA Award for Leading Environmental Consultant for Wind Projects in 2013 & 2015

ATTEMPTS TO ATTAIN COMMENTS

REMINDER: NAMAS WIND FARM: NOTIFICATION OF AVAILABILITY OF BASIC ASSESSMENT REPORT FOR REVIEW AND COMMENT

Search

Forward

Assigned to:	Savannah Public Process	Date Sent:	23/11/2018 07:22
Teams:	Global	Project:	Namas & Zonnequa Wind Farm
From:	Savannah Public Process <publicprocess@savannahsa.com>		
To:			
Cc:			
Bcc:	<p>John Wesson <jnbadm@wessa.co.za>, Mandy Poole <mandyp@ewt.org.za>, Mome du Plessis <mduplessis@wwf.org.za>, Hannes van Zyl <hannes@solek.co.za>, Yolandé Oberholzer <agrivbgl@truvb.co.za>, Werner Kleynhans <kleynhansw@caa.co.za>, Chris Fortuin <chrif@namakwa-dm.gov.za>, Andrea van Gensen <vgenseal@eskom.co.za>, Abegail Makgato <abegaim@transhex.co.za>, Elizabeth Botes <twessels@ncpg.gov.za>, Gert Greeff <greeffg@eskom.co.za>, Steven Shibambu <shibambus@dwa.gov.za>, Livhuwani Mashamba <mashamp@eskom.co.za>, Natalie Weyers <nats.weyers@gmail.com>, Samantha Ralston-Paton <energy@birdlife.org.za>, Bryan Fisher <bfisher@ncpg.gov.za>, Tiaan Priem <tiaanp@transhex.co.za>, Adam Claasen <claassenaubrey@gmail.com>, Adrian Tiplady <atiplady@ska.ac.za>, Constant Hoogstad <constanth@ewt.org.za>, Peter Cloete <peter.denc87@gmail.com>, Dineo Moleko <dmoleko@ncpg.gov.za>, Thebe Thebe <tthebe@ncpg.gov.za>, Nomfundo Ntloko-Gobodo <nomfundo.ntloko-gobodo@drdlr.gov.za>, Tabbie Roberts <tabbie@vodamail.com>, Riaan van Wyk <socialdev1@hantam.gov.za>, Anton Meyer <anton.meyer@debeersgroup.com>, Nicole Abrahams <abrahamsn@nra.co.za>, Johan Jacobus Mostert <rooivley@gmail.com>, Leonard Shaw <shawls@telkom.co.za>, Jeanene Jessnitz <jeanene.jessnitz@gmail.com>, Ravisha Ajodhapersadh <ravisha.ajodhapersadh@enel.com>, John Geeringh <john.geeringh@eskom.co.za>, Jacques Cloete <jacques.cloete@namakhoi.gov.za>, Lani Adonus <lanieadonus9@gmail.com>, Ratha Andrew Timothy <ratha.timothy@gmail.com>, Bentram Leukes <buildings@hantam.gov.za>, Albertus Johannes Roux <irene53@yahoo.com>, Veronique Fyfe <eia@g7energies.com>, Kevin Mutheiwana <mmboneni.mutheiwana@dmr.gov.za>, Jaco Roelofse <roelofse.j@vodamail.co.za>, Lt. Cnl. Kebasenosi Zondi <kebasenosi@yahoo.com>, Lizell Stroh <strohl@caa.co.za>, Willem Daniel Engelbrecht (1944) <meisie@3i.co.za>, Megan Murison <meganm@ewt.org.za>, Yolán Friedmann <yolanf@ewt.org.za>, Nanine van Olmen Phillips <nvanolmen@ncpg.gov.za>, ST Felix <idp@hantam.gov.za>, Natasha Higgitt <nhiggitt@sahra.org.za>, Belinda Farmer <loeriesfonteinlib@ncpg.gov.za>, Jasper Nieuwoudt <jasper.nieuwoudt@dmr.gov.za>, Wilma Lutsch <wlutsch@environment.gov.za>, Karen de Bruyn <karen@g7energies.com>, Nicol Jansen <henning@agrink.co.za>, Deon Fontini <dfontini@martin-east.co.za>, Minnelise Levendal <mlevendal@csir.co.za>, Koos Bisschoff <koosbisschoff@gmail.com>, Jacqueline Mans <jacolinema@daff.gov.za>, D Jennings <daacatmat@yahoo.com>, Kleinzee Conservation Club <info@kleinzeeinfo.co.za>, Annabe van Dyk <annabevandyk@gmail.com>, Conrad Geldenhuys <c.geldenhuys@hotmail.com>, Jacquiline van der Merwe <jacquidmerwe395@gmail.com>, Kate MacEwan <kate@iws-sa.co.za>, Hentie Van Jaarsveld <saffier@hantam.co.za>, Samantha De la Fontaine <sdelafontaine@gmail.com>, Magdalena Michalowska <m.michalowska@buildingenergy.it>, Samantha Titus <municipal.manager@namakhoi.gov.za>, Paulus van Reenen <paulus.vanreenen@namakhoi.gov.za>, Bulelani Right <bulelanir@namakwa-dm.gov.za>,</p>		

Abrahams <franksl@dwa.gov.za>, Michael Knight <mike.knight@sanparks.org>, Russel Hartle Search <russel.hartley@namakhoi.gov.za>, Mangalane Du Toit <mangalane.dutoit@drdlr.gov.za>, Vincent Madlela <vincent@mamokgoka.co.za>, Roger Swartz <mayor@hantam.gov.za>, Louise Geldenhuys <geldenhuys.louise1@gmail.com>, Elsabe Swart <elsabe.dtec@gmail.com>, Mashudu Marubini <mashuduma@daff.gov.za>, Pheladi Masipa <pheladi.masipa@energy.gov.za>

Subject: REMINDER: NAMAS WIND FARM: NOTIFICATION OF AVAILABILITY OF BASIC ASSESSMENT REPORT FOR REVIEW AND COMMENT

Body: Dear Stakeholder,

With reference to the attached notification letter and emails below, this email serves as a reminder that the comment period ends **Today, Friday the 23rd of November 2018**.

Kindly submit your comments **Today, Friday the 23rd of November 2018**, by close of business.

Thank you and kind regards,

Rozanne Els

Public Participation Co-ordinator | Savannah Environmental (Pty) Ltd

Tel: +27 (0)11 656 3237 | Fax: +27 (0)86 684 0547

SAWEA Award for Leading Environmental Consultant for Wind Projects in 2013 & 2015

> From: Savannah Public Process
> Date Sent: 22/11/2018 13:12
> To:
> Cc:
> Subject: FW: REMINDER: NAMAS WIND FARM: NOTIFICATION OF AVAILABILITY OF BASIC ASSESSMENT REPORT FOR REVIEW AND COMMENT
>

Dear Stakeholder,

With reference to the attached notification letter and emails below, this email serves as a reminder that the comment period ends **Tomorrow, Friday the 23rd November 2018**.

Kindly submit your comments by **Tomorrow, Friday the 23rd November 2018**, by close of business.

Public Participation Co-ordinator | Savannah Environmental (Pty) Ltd

Tel: +27 (0)11 656 3237 | Fax: +27 (0)86 684 0547

Search

SAWEA Award for Leading Environmental Consultant for Wind Projects in 2013 & 2015

> From: Savannah Public Process
> Date Sent: 16/11/2018 09:44
> To:
> Cc:
> Subject: FW: REMINDER: NAMAS WIND FARM: NOTIFICATION OF AVAILABILITY OF BASIC ASSESSMENT REPORT FOR REVIEW AND COMMENT
>

Dear Stakeholder,

With reference to the attached notification letter and email below, this email serves as a reminder that the comment period ends on **Friday, 23 November 2018**.

Kindly submit your comments on or before **Friday, 23 November 2018** by close of business.

Thank you and kind regards,

Rozanne Els

Public Participation Co-ordinator | Savannah Environmental (Pty) Ltd

Tel: +27 (0)11 656 3237 | Fax: +27 (0)86 684 0547

SAWEA Award for Leading Environmental Consultant for Wind Projects in 2013 & 2015

> From: Savannah Public Process
> Date Sent: 23/10/2018 09:18
> To:
> Cc:
> Subject: FW: NAMAS WIND FARM: NOTIFICATION OF AVAILABILITY OF BASIC ASSESSMENT REPORT FOR REVIEW AND COMMENT
>

Dear Stakeholder,

A wind farm is proposed to be developed within the Springbok Renewable Energy Development Zone (REDZ), approximately 20 km south-east of the town of Kleinsee in the Northern Cape. The wind farm is known as the **Namas Wind Farm** and is located within the Nama Khoi Local Municipality and the Namakwa District Municipality.

It is Genesis Namas Wind (Pty) Ltd's, the developer, intention to bid the Namas Wind Farm

Resources Plan.

Search

This e-mail serves to inform you, as a registered Interested and Affected Party (I&AP), that in terms of the National Environmental Management Act (No. 107 of 1998) (NEMA) and the 2014 Environmental Impact Assessment (EIA) Regulations, as amended in April 2017, that the Basic Assessment Report (BAR) is available for your review and comment.

The hard copy of the BAR can be viewed at the Kleinsee Library (3rd Avenue, Kleinsee, open on Tuesdays & Thursdays between 11h00 and 17h00) from **Wednesday, 24 October 2018 to Friday, 23 November 2018**. An electronic copy can be downloaded from our website (<http://www.savannahsa.com/public-documents/energy-generation/namas-wind-farm/>).

Please refer to the attached letter for further details in this regard.

Kind regards,

Nicolene Venter

Public Participation and Social Consultant | Savannah Environmental (Pty) Ltd
 Tel: +27 (0)11 656 3237 | Mobile: +27 83 377 9112 | Fax: +27 (0)86 684 0547

SAWEA Award for Leading Environmental Consultant for Wind Projects in 2013 & 2015

Show Plain Text

Attachments: [Namas WF BAR NotificationLetter.pdf](#)

▼ Activities

▲ Attachments

(1 - 1 of 1)		
Subject	Contact	Last Modified
 Namas WF BAR NotificationLetter.pdf		23/11/2018 07:22 edit

▼ Accounts

▼ Contacts

▼ Email Stakeholders

▼ Users

▲ Projects

(1 - 1 of 1)			
Name	Assigned To	Start Date:	End Date:
Namas & Zonnequa Wind Farm	Gabriele Stein	01/05/2018	01/11/2018 edit

AIR TRAFFIC AND NAVIGATION SERVICES
(ATNS)

Savannah Environmental Public Process

From: Nicolene Venter <nicolene@savannahsa.com>
Sent: 23 November 2018 7:51 AM
To: 'Simphiwe Masilela'
Cc: 'Rozanne Els'
Subject: Namas & Zonnequa: Extension of Comment Period on BAR
Attachments: Namas Wind Farm Project Site.kmz; Zonnequa Wind Farm Project Site.kmz; 2215_001.pdf

Dear Simphiwe,

The ATNS is welcome to submit their comments on the Basic Assessment Reports (BARs) for the Namas and Zonnequa Wind Farms by next week Tuesday, 27 November 2018 by COB.

Please find attached the KMZ files for each of the project sites.

We take note of the fact that ATNS (your department) received the CD containing both the above-mentioned projects' BARs at such a late stage. For easy reference, please see our proof of delivery.

Kind regards,

Nicolene Venter

Public Participation & Social Consultant | Savannah Environmental (Pty) Ltd

Tel: +27 (0)11 656 3237 | Fax: +27 (0)86 684 0547

[SAWEA Award for Leading Environmental Consultant for Wind Projects in 2013 & 2015](#)

From: Simphiwe Masilela [<mailto:SimphiweM@atns.co.za>]
Sent: 22 November 2018 4:59 PM
To: Savannah Public Process <publicprocess@savannahsa.com>
Cc: Graham Mondzinger <grahamm@atns.co.za>; Francois Coetzee <FrancoisC@atns.co.za>
Subject: RE: ZONNEQUA WIND FARM: NOTIFICATION OF AVAILABILITY OF BASIC ASSESSMENT REPORT FOR REVIEW AND COMMENT



Dear Rozanne,

Kindly allow for us to make comment on all your basic report reviews and comments by Tuesday COB.

We are having difficulty locating these sites because your notifications do not include coordinates and we have to request for a password in order to access the information, so if it is possible please provide us with kmz files sourced from google earth for us to easily locate the sites.

We have received the discs this week, however we have not yet had the time to go over them

The sites in Question:

- ZONNEQUA WIND FARM
- NAMAS WIND FARM

Thank you for your patience.

Kind Regards,

[Simphiwe Masilela](#)

Obstacle Evaluator | COO - Air Traffic Services
ATNS Head Office, Bruma, Johannesburg, South Africa

T: +2711 607 1228 • F: 011 607 1466 • C:
E: SimphiweM@atns.co.za • W: www.atns.com



[View Disclaimer](#)

From: Savannah Public Process [<mailto:publicprocess@savannahsa.com>]

Sent: Thursday, November 22, 2018 1:15 PM

Subject: ZONNEQUA WIND FARM: NOTIFICATION OF AVAILABILITY OF BASIC ASSESSMENT REPORT FOR REVIEW AND COMMENT

Dear Stakeholder,

With reference to the attached notification letter and emails below, this email serves as a reminder that the comment period ends **Tomorrow, Friday the 23rd November 2018.**

Kindly submit your comments by **Tomorrow, Friday the 23rd November 2018**, by close of business.

Thank you and kind regards,

Rozanne Els

Public Participation Co-ordinator | Savannah Environmental (Pty) Ltd
Tel: +27 (0)11 656 3237 | Fax: +27 (0)86 684 0547

SAWEA Award for Leading Environmental Consultant for Wind Projects in 2013 & 2015

> From: Savannah Public Process <publicprocess@savannahsa.com>
> Date Sent: 16/11/2018 09:42
> To:
> Cc:
> Subject: FW: ZONNEQUA WIND FARM: NOTIFICATION OF AVAILABILITY OF BASIC ASSESSMENT REPORT FOR REVIEW AND COMMENT
>

Dear Stakeholder,

With reference to the attached notification letter and email below, this email serves as a reminder that the comment period ends on **Friday, 23 November 2018**.

Kindly submit your comments on or before **Friday, 23 November 2018** by close of business.

Thank you and kind regards,

Rozanne Els

Public Participation Co-ordinator | Savannah Environmental (Pty) Ltd
Tel: +27 (0)11 656 3237 | Fax: +27 (0)86 684 0547

SAWEA Award for Leading Environmental Consultant for Wind Projects in 2013 & 2015

> From: Savannah Public Process
> Date Sent: 23/10/2018 09:30
> To:
> Cc:
> Subject: FW: ZONNEQUA WIND FARM: NOTIFICATION OF AVAILABILITY OF BASIC ASSESSMENT REPORT FOR REVIEW AND COMMENT
>

Dear Stakeholder,

A wind farm is proposed to be developed within the Springbok Renewable Energy Development Zone (REDZ), approximately 20 km south-east of the town of Kleinsee in the Northern Cape. The wind farm is known as the **Zonnequa Wind Farm** and is located within the Nama Khoi Local Municipality and the Namakwa District Municipality.

It is Genesis Zonnequa Wind (Pty) Ltd's, the developer, intention to bid the Zonnequa Wind Farm project under the Department of Energy's (DoE) Renewable Energy Independent Power Producer Procurement (REIPPP)

Programme. The power generated from the project will be sold to Eskom and will feed into the national electricity grid. The development of the project will also assist with achieving the electricity generation goals as set out in the Integrated Resources Plan.

This e-mail serves to inform you, as a registered Interested and Affected Party (I&AP), that in terms of the National Environmental Management Act (No. 107 of 1998) (NEMA) and the 2014 Environmental Impact Assessment (EIA) Regulations, as amended in April 2017, that the Basic Assessment Report (BAR) is available for your review and comment.

The hard copy of the BAR can be viewed at the Kleinsee Library (3rd Avenue, Kleinsee, open on Tuesdays & Thursdays between 11h00 and 17h00) from **Wednesday, 24 October 2018** to **Friday, 23 November 2018**. An electronic copy can be downloaded from our website (<http://www.savannahsa.com/public-documents/energy-generation/zonnequa-wind-farm/>).

Please refer to the attached letter for further details in this regard.

Kind regards,

Nicolene Venter

Public Participation and Social Consultant | Savannah Environmental (Pty) Ltd
Tel: +27 (0)11 656 3237 | Mobile: +27 83 377 9112 | Fax: +27 (0)86 684 0547

SAWEA Award for Leading Environmental Consultant for Wind Projects in 2013 & 2015

▪
The contents of this email are confidential and intended for the named recipient(s) only. The information may be privileged or otherwise protected from disclosure. The views expressed in this message are those of the sender, unless otherwise stated to be. This email is also subject to copyright. No part hereof may be reproduced, adapted, transmitted, or used in any way without the written consent of ATNS SOC Limited. Please do not hesitate to contact us immediately should you have any doubts regarding the authenticity of an email purportedly sent by the sender.

BIRDLIFE SOUTH AFRICA

Savannah Environmental Public Process

From: Savannah Environmental Public Process <publicprocess@savannahsa.com>
Sent: 23 November 2018 12:39 PM
To: 'Samantha Ralston-Paton'
Subject: Request fro Comment: Namas & Zonnequa Wind Farms
Attachments: Zonnequa WF BAR NotificaitonLetter.pdf; Namas WF BAR NotificationLetter.pdf

Importance: High

Dear Samantha,

This email serves as a reminder that the comment period for the above mentioned project ends **Today the 23rd of November 2018.**

Kindly indicate whether you will be submitting any comments ?

Thank you and kind regards,

Rozanne Els

Public Participation Co-ordinator | Savannah Environmental (Pty) Ltd
Tel: +27 (0)11 656 3237 | Fax: +27 (0)86 684 0547

[SAWEA Award for Leading Environmental Consultant for Wind Projects in 2013 & 2015](#)

From: Savannah Environmental Public Process [mailto:publicprocess@savannahsa.com]
Sent: 20 November 2018 10:25 AM
To: 'energy@birdlife.org.za' <energy@birdlife.org.za>
Subject: Request fro Comment: Namas & Zonnequa Wind Farms
Importance: High

Dear Samantha,

With reference to the attached notification letters in regards to the Namas and Zonnequa Wind Farms, we noted that we have not yet received written comment on the Basic Assessment Report for public review from Birdlife SA.

This e-mail serves as a reminder that the comment period for the above mentioned project ends on **Friday, 23 November 2018.**

It would be appreciated if you can submit written comment before or on **Friday, 23 November 2018** by close of business.

Should you not have any comments, please inform us accordingly.

Kind regards,

DEPARTMENT OF AGRICULTURE, FORESTRY AND
FISHERIES (DAFF): NORTHERN CAPE

Savannah Environmental Public Process

From: Savannah Environmental Public Process <publicprocess@savannahsa.com>
Sent: 23 November 2018 12:47 PM
To: 'jacolinema@daff.gov.za'
Subject: Request for Comment: Namas & Zonnequa Wind Farms
Attachments: Zonnequa WF BAR NotificaitonLetter.pdf; Namas WF BAR NotificationLetter.pdf

Importance: High

Good day,

This email serves as a reminder that the comment period for the above mentioned project ends **today the 23rd of November 2018**.

Kindly indicate whether your department will be submitting any comments ?

Thank you and kind regards,

Rozanne Els

Public Participation Co-ordinator | Savannah Environmental (Pty) Ltd
Tel: +27 (0)11 656 3237 | Fax: +27 (0)86 684 0547

[SAWEA Award for Leading Environmental Consultant for Wind Projects in 2013 & 2015](#)

From: Savannah Environmental Public Process [mailto:publicprocess@savannahsa.com]
Sent: 20 November 2018 9:58 AM
To: 'jacolinema@daff.gov.za' <jacolinema@daff.gov.za>
Subject: Request fro Comment: Namas & Zonnequa Wind Farms
Importance: High

Dear Jacoline,

With reference to the attached notification letters in regards to the Namas and Zonnequa Wind Farms, we noted that we have not yet received written comment on the Basic Assessment Report for public review from the Northern Cape Department of Agriculture, Forestry and Fisheries (DAFF).

This e-mail serves as a reminder that the comment period for the above mentioned project ends on **Friday, 23 November 2018**.

It would be appreciated if you can submit written comment before or on **Friday, 23 November 2018** by close of business.

Should you not have any comments, please inform us accordingly.

Kind regards,

DEPARTMENT OF AGRICULTURE, FORESTRY AND
FISHERIES (DAFF)

Savannah Environmental Public Process

From: Savannah Environmental Public Process <publicprocess@savannahsa.com>
Sent: 23 November 2018 12:47 PM
To: 'mashuduma@daff.gov.za'
Cc: 'thokob@daff.gov.za'
Subject: Request for Comment: Namas & Zonnequa Wind Farms
Attachments: Zonnequa WF BAR NotificaitonLetter.pdf; Namas WF BAR NotificationLetter.pdf

Importance: High

Good day,

This email serves as a reminder that the comment period for the above mentioned project ends **today the 23rd of November 2018**.

Kindly indicate whether your department will be submitting any comments ?

Thank you and kind regards,

Rozanne Els

Public Participation Co-ordinator | Savannah Environmental (Pty) Ltd
Tel: +27 (0)11 656 3237 | Fax: +27 (0)86 684 0547

[SAWEA Award for Leading Environmental Consultant for Wind Projects in 2013 & 2015](#)

From: Savannah Environmental Public Process [mailto:publicprocess@savannahsa.com]
Sent: 20 November 2018 9:59 AM
To: 'mashuduma@daff.gov.za' <mashuduma@daff.gov.za>
Cc: 'thokob@daff.gov.za' <thokob@daff.gov.za>
Subject: Request fro Comment: Namas & Zonnequa Wind Farms
Importance: High

Dear Mashudu,

With reference to the attached notification letters in regards to the Namas and Zonnequa Wind Farms, we noted that we have not yet received written comment on the Basic Assessment Report for public review from the Department of Agriculture, Forestry and Fisheries.

This e-mail serves as a reminder that the comment period for the above mentioned project ends on **Friday, 23 November 2018**.

It would be appreciated if you can submit written comment before or on **Friday, 23 November 2018** by close of business.

Should you not have any comments, please inform us accordingly.

Kind regards,

DEPARTMENT OF ENVIRONMENTAL AFFAIRS:
BIODIVERSITY

Savannah Environmental Public Process

From: Savannah Environmental Public Process <publicprocess@savannahsa.com>
Sent: 27 November 2018 10:07 AM
To: 'Seoka Lekota'
Cc: 'Stanley Tshitwamulomoni'; 'Portia Makitla'; 'MMatlala Rabothata'; 'Thobekile Zungu'
Subject: RE: Request fro Comment: Namas & Zonnequa Wind Farms
Attachments: DEA(Biodiversity) Cover Letter.pdf; 2238_001.pdf

Importance: High

Good day,

Please find attached the Cover Letter and the MEMO which shows the proof that this project was delivered to DEA and that it was signed for. This was also filled in on the book. If you look in the book the submissions are written into you will find the proof there as well.

As previously confirmed with Mr Stanley – this was addressed to Wilma Luth because this was before we were made aware of the fact that she is not there anymore.

Non the less, this was still delivered to DEA by hand, signed for and directed at the Director of Biodiversity.

Would you like me to put it on a drop box link for you ? you can also access it on our website.

Thank you and kind regards,

Rozanne Els

Public Participation Co-ordinator | Savannah Environmental (Pty) Ltd
Tel: +27 (0)11 656 3237 | Fax: +27 (0)86 684 0547

[SAWEA Award for Leading Environmental Consultant for Wind Projects in 2013 & 2015](#)

From: Seoka Lekota [mailto:SLekota@environment.gov.za]
Sent: 26 November 2018 4:17 PM
To: Savannah Environmental Public Process <publicprocess@savannahsa.com>
Cc: Stanley Tshitwamulomoni <StanleyT@environment.gov.za>; Portia Makitla <PMakitla@environment.gov.za>; MMatlala Rabothata <MRabothata@environment.gov.za>; Thobekile Zungu <tzungu@environment.gov.za>
Subject: RE: Request fro Comment: Namas & Zonnequa Wind Farms

Dear Rozanne

Please note that we have checked on our database (were in coming reports are captured and allocated for review) and the mentioned project was never received by the Directorate: Biodiversity Conservation for comments. In order for us to provide comments we need to receive the mentioned project, to allow us to give informative comments as Stakeholder in this matter.



Mr. Seoka Lekota [Pr.Sci.Nat.]
Department of Environmental Affairs

Directorate: Biodiversity Conservation
Private Bag X447
PRETORIA
0001

Tel: +27(0)12 399 9573

E-mail: slekota@environment.gov.za

From: Savannah Environmental Public Process [<mailto:publicprocess@savannahsa.com>]

Sent: 23 November 2018 07:55 AM

To: Stanley Tshitwamulomoni; Portia Makitla; Seoka Lekota

Subject: Request fro Comment: Namas & Zonnequa Wind Farms

Importance: High

Good day Stanley,

This e-mail serves as a reminder that the comment period for the above mentioned project ends Today, Friday the 23rd of November 2018.

Kindly confirm if you will be submitting comments ?

Thank you and kind regards,

Rozanne Els

Public Participation Co-ordinator | Savannah Environmental (Pty) Ltd

Tel: +27 (0)11 656 3237 | Fax: +27 (0)86 684 0547

[SAWEA Award for Leading Environmental Consultant for Wind Projects in 2013 & 2015](#)

From: Stanley Tshitwamulomoni [<mailto:StanleyT@environment.gov.za>]

Sent: 20 November 2018 8:12 PM

To: Portia Makitla <PMakitla@environment.gov.za>; Seoka Lekota <SLekota@environment.gov.za>

Cc: Savannah Environmental Public Process <publicprocess@savannahsa.com>

Subject: FW: Request fro Comment: Namas & Zonnequa Wind Farms

Importance: High

Dear Seoka and Portia

May you follow-up

Regards

Stanley

From: Savannah Environmental Public Process [<mailto:publicprocess@savannahsa.com>]

Sent: Tuesday, 20 November 2018 10:05

To: Stanley Tshitwamulomoni

Cc: Thobekile Zungu

Subject: Request fro Comment: Namas & Zonnequa Wind Farms

Importance: High

Dear Stanley,

With reference to the attached notification letters in regards to the Namas and Zonnequa Wind Farms, we noted that we have not yet received written comment on the Basic Assessment Report for public review from the Department of Environmental Affairs: Biodiversity.

This was also a Report Delivered to Wilma Lutch at the Department of Environmental Affairs before we were informed about you taking over.

This e-mail serves as a reminder that the comment period for the above mentioned project ends on **Friday, 23 November 2018.**

It would be appreciated if you can submit written comment before or on **Friday, 23 November 2018** by close of business.

Should you not have any comments, please inform us accordingly.

Kind regards,



t: 011 656 3237
f: 086 684 0547

Public Process

e: publicprocess@savannahsa.com
c:

SAWEA Award for Leading Environmental Consultant on Wind Projects in 2013 & 2015

'Please consider the environment before you print this email'

'Please consider the environment before you print this email'

This message and any attachments transmitted with it are intended solely for the addressee(s) and may be legally privileged and/or confidential. If you have received this message in error please destroy it and notify the sender. Any unauthorized usage, disclosure, alteration or dissemination is prohibited. The Department of Environmental Affairs accepts no responsibility for any loss whether it be direct, indirect or consequential, arising from information made available and actions resulting there from. The views and opinions expressed in this e-mail message may not necessarily be those of Management.

'Please consider the environment before you print this email'

'Please consider the environment before you print this email'

This message and any attachments transmitted with it are intended solely for the addressee(s) and may be legally privileged and/or confidential. If you have received this message in error please destroy it and notify the sender. Any unauthorized usage, disclosure, alteration or dissemination is prohibited. The Department of Environmental Affairs accepts no responsibility for any loss whether it be direct, indirect or consequential, arising from information made available and actions resulting there from. The views and opinions expressed in this e-mail message may not necessarily be those of Management.

Savannah Environmental Public Process

From: Savannah Environmental Public Process <publicprocess@savannahsa.com>
Sent: 28 November 2018 3:19 PM
To: 'Seoka Lekota'
Subject: RE: Request for Comment: Namas & Zonnequa Wind Farms

Dear Seoka,

Please see below the link

<https://www.dropbox.com/sh/dja1g5dbt5snr9v/AAAi5iuGG6Ma926FBgqGLUE3a?dl=0>

Kindly let me know if you need assistance with anything else.

Can you also give us an estimate of when we will receive comments ?

Thanks for your assistance.

Kind regards,

Rozanne Els

Public Participation Co-ordinator | Savannah Environmental (Pty) Ltd
Tel: +27 (0)11 656 3237 | Fax: +27 (0)86 684 0547

[SAWEA Award for Leading Environmental Consultant for Wind Projects in 2013 & 2015](#)

From: Seoka Lekota [mailto:SLekota@environment.gov.za]
Sent: 28 November 2018 11:40 AM
To: Savannah Environmental Public Process <publicprocess@savannahsa.com>
Cc: Stanley Tshitwamulomoni <StanleyT@environment.gov.za>; Portia Makitla <PMakitla@environment.gov.za>; MMatlala Rabothata <MRabothata@environment.gov.za>; Thobekile Zungu <tzungu@environment.gov.za>
Subject: RE: Request for Comment: Namas & Zonnequa Wind Farms

Dear Rozanne

May you please send it to us via drop box as suggested since, it seems like the project documents have been lost somewhere, maybe because it was addressed to Wilma but that is not a problem at the moment please send us the link so that we can provide you with our comments as early as possible.

Regards 

*Mr. Seoka Lekota [Pr.Sci.Nat.]
Department of Environmental Affairs
Directorate: Biodiversity Conservation
Private Bag X447
PRETORIA
0001*

Tel: +27(0)12 399 9573

E-mail: slekota@environment.gov.za

From: Savannah Environmental Public Process [<mailto:publicprocess@savannahsa.com>]
Sent: 27 November 2018 10:07 AM
To: Seoka Lekota
Cc: Stanley Tshitwamulomoni; Portia Makitla; MMatlala Rabothata; Thobekile Zungu
Subject: RE: Request fro Comment: Namas & Zonnequa Wind Farms
Importance: High

Good day,

Please find attached the Cover Letter and the MEMO which shows the proof that this project was delivered to DEA and that it was signed for. This was also filled in on the book. If you look in the book the submissions are written into you will find the proof there as well.

As previously confirmed with Mr Stanley – this was addressed to Wilma Luth because this was before we were made aware of the fact that she is not there anymore.

Non the less, this was still delivered to DEA by hand, signed for and directed at the Director of Biodiversity.

Would you like me to put it on a drop box link for you ? you can also access it on our website.

Thank you and kind regards,

Rozanne Els

Public Participation Co-ordinator | Savannah Environmental (Pty) Ltd
Tel: +27 (0)11 656 3237 | Fax: +27 (0)86 684 0547

[SAWEA Award for Leading Environmental Consultant for Wind Projects in 2013 & 2015](#)

From: Seoka Lekota [<mailto:SEkota@environment.gov.za>]
Sent: 26 November 2018 4:17 PM
To: Savannah Environmental Public Process <publicprocess@savannahsa.com>
Cc: Stanley Tshitwamulomoni <StanleyT@environment.gov.za>; Portia Makitla <PMakitla@environment.gov.za>; MMatlala Rabothata <MRabothata@environment.gov.za>; Thobekile Zungu <tzungu@environment.gov.za>
Subject: RE: Request fro Comment: Namas & Zonnequa Wind Farms

Dear Rozanne

Please note that we have checked on our database (were in coming reports are captured and allocated for review) and the mentioned project was never received by the Directorate: Biodiversity Conservation for comments. In order for us to provide comments we need to receive the mentioned project, to allow us to give informative comments as Stakeholder in this matter.



Mr. Seoka Lekota [Pr.Sci.Nat.]
Department of Environmental Affairs
Directorate: Biodiversity Consaervation
Private Bag X447
PRETORIA
0001

Tel: +27(0)12 399 9573

E-mail: slekota@environment.gov.za

From: Savannah Environmental Public Process [<mailto:publicprocess@savannahsa.com>]

Sent: 23 November 2018 07:55 AM

To: Stanley Tshitwamulomoni; Portia Makitla; Seoka Lekota

Subject: Request fro Comment: Namas & Zonnequa Wind Farms

Importance: High

Good day Stanley,

This e-mail serves as a reminder that the comment period for the above mentioned project ends Today, Friday the 23rd of November 2018.

Kindly confirm if you will be submitting comments ?

Thank you and kind regards,

Rozanne Els

Public Participation Co-ordinator | Savannah Environmental (Pty) Ltd

Tel: +27 (0)11 656 3237 | Fax: +27 (0)86 684 0547

[SAWEA Award for Leading Environmental Consultant for Wind Projects in 2013 & 2015](#)

From: Stanley Tshitwamulomoni [<mailto:StanleyT@environment.gov.za>]

Sent: 20 November 2018 8:12 PM

To: Portia Makitla <PMakitla@environment.gov.za>; Seoka Lekota <SLekota@environment.gov.za>

Cc: Savannah Environmental Public Process <publicprocess@savannahsa.com>

Subject: FW: Request fro Comment: Namas & Zonnequa Wind Farms

Importance: High

Dear Seoka and Portia

May you follow-up

Regards

Stanley

From: Savannah Environmental Public Process [<mailto:publicprocess@savannahsa.com>]

Sent: Tuesday, 20 November 2018 10:05

To: Stanley Tshitwamulomoni

Cc: Thobekile Zungu

Subject: Request fro Comment: Namas & Zonnequa Wind Farms

Importance: High

Dear Stanley,

With reference to the attached notification letters in regards to the Namas and Zonnequa Wind Farms, we noted that we have not yet received written comment on the Basic Assessment Report for public review from the Department of Environmental Affairs: Biodiversity.

This was also a Report Delivered to Wilma Lutch at the Department of Environmental Affairs before we were informed about you taking over.

This e-mail serves as a reminder that the comment period for the above mentioned project ends on **Friday, 23 November 2018**.

It would be appreciated if you can submit written comment before or on **Friday, 23 November 2018** by close of business.

Should you not have any comments, please inform us accordingly.

Kind regards,



t: 011 656 3237
f: 086 684 0547

Public Process

e: publicprocess@savannahsa.com
c:

SAWEA Award for Leading Environmental Consultant on Wind Projects in 2013 & 2015

'Please consider the environment before you print this email'
'Please consider the environment before you print this email'

This message and any attachments transmitted with it are intended solely for the addressee(s) and may be legally privileged and/or confidential. If you have received this message in error please destroy it and notify the sender. Any unauthorized usage, disclosure, alteration or dissemination is prohibited. The Department of Environmental Affairs accepts no responsibility for any loss whether it be direct, indirect or consequential, arising from information made available and actions resulting there from. The views and opinions expressed in this e-mail message may not necessarily be those of Management.

'Please consider the environment before you print this email'
'Please consider the environment before you print this email'

This message and any attachments transmitted with it are intended solely for the addressee(s) and may be legally privileged and/or confidential. If you have received this message in error please destroy it and notify the sender. Any unauthorized usage, disclosure, alteration or dissemination is prohibited. The Department of Environmental Affairs accepts no responsibility for any loss whether it be direct, indirect or consequential, arising from information made available and actions resulting there from. The views and opinions expressed in this e-mail message may not necessarily be those of Management.

'Please consider the environment before you print this email'
'Please consider the environment before you print this email'

This message and any attachments transmitted with it are intended solely for the addressee(s) and may be legally privileged and/or confidential. If you have received this message in error please destroy it and notify the sender. Any unauthorized usage, disclosure, alteration or dissemination is prohibited. The Department of Environmental Affairs accepts no responsibility for any loss whether it be direct, indirect or consequential, arising from information made available and actions resulting there from. The views and opinions expressed in this e-mail message may not necessarily be those of Management.

DEPARTMENT OF ENVIRONMENT AND NATURE
CONSERVATION: NORTHERN CAPE

Savannah Environmental Public Process

From: Savannah Environmental Public Process <publicprocess@savannahsa.com>
Sent: 23 November 2018 12:46 PM
To: 'BFisher@ncpg.gov.za'
Subject: Request fro Comment: Namas & Zonnequa Wind Farms
Attachments: Zonnequa WF BAR NotificaitonLetter.pdf; Namas WF BAR NotificationLetter.pdf

Importance: High

Good day,

This emails serves as a reminder that the comment period for the above mentioned project ends **today the 23rd of November 2018.**

Kindly indicate whether your department will be submitting any comments ?

Thank you and kind regards,

Rozanne Els

Public Participation Co-ordinator | Savannah Environmental (Pty) Ltd
Tel: +27 (0)11 656 3237 | Fax: +27 (0)86 684 0547

[SAWEA Award for Leading Environmental Consultant for Wind Projects in 2013 & 2015](#)

From: Savannah Environmental Public Process [mailto:publicprocess@savannahsa.com]
Sent: 20 November 2018 10:16 AM
To: 'BFisher@ncpg.gov.za' <BFisher@ncpg.gov.za>
Subject: Request fro Comment: Namas & Zonnequa Wind Farms
Importance: High

Dear Bryan,

With reference to the attached notification letters in regards to the Namas and Zonnequa Wind Farms, we noted that we have not yet received written comment on the Basic Assessment Report for public review from the Department of Environment and Nature Conservation.

This e-mail serves as a reminder that the comment period for the above mentioned project ends on **Friday, 23 November 2018.**

It would be appreciated if you can submit written comment before or on **Friday, 23 November 2018** by close of business.

Should you not have any comments, please inform us accordingly.

Kind regards,

DEPARTMENT OF WATER AND SANITATION

Savannah Environmental Public Process

From: Savannah Environmental Public Process <publicprocess@savannahsa.com>
Sent: 23 November 2018 12:31 PM
To: 'franksl@dwa.gov.za'
Subject: Request fro Comment: Namas & Zonnequa Wind Farms
Attachments: Zonnequa WF BAR NotificaitonLetter.pdf; Namas WF BAR NotificationLetter.pdf

Importance: High

Dear Abe,

This emails serves as a reminder that the comment period for the abovementioned project ends **today the 23rd of November 2018.**

Kindly confirm if your department will be submitting any comments ?

Thank you and kind regards,

Rozanne Els

Public Participation Co-ordinator | Savannah Environmental (Pty) Ltd
Tel: +27 (0)11 656 3237 | Fax: +27 (0)86 684 0547

[SAWEA Award for Leading Environmental Consultant for Wind Projects in 2013 & 2015](#)

From: Savannah Environmental Public Process [mailto:publicprocess@savannahsa.com]
Sent: 20 November 2018 10:40 AM
To: 'franksl@dwa.gov.za' <franksl@dwa.gov.za>
Subject: Request fro Comment: Namas & Zonnequa Wind Farms
Importance: High

Dear Abe,

With reference to the attached notification letters in regards to the Namas and Zonnequa Wind Farms, we noted that we have not yet received written comment on the Basic Assessment Report for public review from the Department of Water and Sanitation.

This e-mail serves as a reminder that the comment period for the above mentioned project ends on **Friday, 23 November 2018.**

It would be appreciated if you can submit written comment before or on **Friday, 23 November 2018** by close of business.

Should you not have any comments, please inform us accordingly.

Kind regards,

Savannah Environmental Public Process

From: Franks Lindiwe <FranksL@dws.gov.za>
Sent: 20 November 2018 10:45 AM
To: Savannah Environmental Public Process
Subject: Read: Request fro Comment: Namas & Zonnequa Wind Farms

Importance: High

DISCLAIMER: This message and any attachments are confidential and intended solely for the addressee. If you have received this message in error, please notify the system manager/sender. Any unauthorized use, alteration or dissemination is prohibited. The Department of Water and Sanitation further accepts no liability whatsoever for any loss, whether it be direct, indirect or consequential, arising from this e-mail, nor for any consequence of its use or storage.

Savannah Environmental Public Process

From: Franks Lindiwe <FranksL@dws.gov.za>
Sent: 23 November 2018 1:10 PM
To: Savannah Environmental Public Process
Subject: Read: Request fro Comment: Namas & Zonnequa Wind Farms

Importance: High

DISCLAIMER: This message and any attachments are confidential and intended solely for the addressee. If you have received this message in error, please notify the system manager/sender. Any unauthorized use, alteration or dissemination is prohibited. The Department of Water and Sanitation further accepts no liability whatsoever for any loss, whether it be direct, indirect or consequential, arising from this e-mail, nor for any consequence of its use or storage.

DEPARTMENT OF MINERAL RESOURCES:
NORTHERN CAPE

Savannah Environmental Public Process

From: Savannah Environmental Public Process <publicprocess@savannahsa.com>
Sent: 23 November 2018 12:28 PM
To: 'Mmboneni.Mutheiwana@dmr.gov.za'
Subject: Request fro Comment: Namas & Zonnequa Wind Farms
Attachments: Zonnequa WF BAR NotificaitonLetter.pdf; Namas WF BAR NotificationLetter.pdf

Importance: High

Dear Mr. Mutheiwana,

This email serves as a reminder that the comment period for the above mentioned project ends **today the 23rd of November 2018.**

With reference to the emails below, could you kindly indicate If your department will be submitting any comments ?

Thank you and kind regards,

Rozanne Els

Public Participation Co-ordinator | Savannah Environmental (Pty) Ltd
Tel: +27 (0)11 656 3237 | Fax: +27 (0)86 684 0547

[SAWEA Award for Leading Environmental Consultant for Wind Projects in 2013 & 2015](#)

From: Savannah Environmental Public Process [mailto:publicprocess@savannahsa.com]
Sent: 20 November 2018 10:45 AM
To: 'Mmboneni.Mutheiwana@dmr.gov.za' <Mmboneni.Mutheiwana@dmr.gov.za>
Subject: Request fro Comment: Namas & Zonnequa Wind Farms
Importance: High

Dear Mr Mutheiwana,

I believe that the below email should have been sent to you. Please could you confirm ?

We have also sent a CD Copy with the Reports on to the Department – but it was addressed to Jasper unfortunately.

Kind regards,

Rozanne Els

Public Participation Co-ordinator | Savannah Environmental (Pty) Ltd
Tel: +27 (0)11 656 3237 | Fax: +27 (0)86 684 0547

[SAWEA Award for Leading Environmental Consultant for Wind Projects in 2013 & 2015](#)

From: Savannah Environmental Public Process [<mailto:publicprocess@savannahsa.com>]
Sent: 20 November 2018 10:06 AM
To: 'Jasper.Nieuwoudt@dmr.gov.za' <Jasper.Nieuwoudt@dmr.gov.za>
Subject: Request fro Comment: Namas & Zonnequa Wind Farms
Importance: High

Dear Jasper,

With reference to the attached notification letters in regards to the Namas and Zonnequa Wind Farms, we noted that we have not yet received written comment on the Basic Assessment Report for public review from the Department of Mineral resources Northern Cape.

This e-mail serves as a reminder that the comment period for the above mentioned project ends on **Friday, 23 November 2018**.

It would be appreciated if you can submit written comment before or on **Friday, 23 November 2018** by close of business.

Should you not have any comments, please inform us accordingly.

Kind regards,

Savannah Environmental Public Process

From: Mmboneni Mutheiwana <MMboneni.Mutheiwana@dmr.gov.za>
To: Savannah Environmental Public Process
Sent: 20 November 2018 3:54 PM
Subject: Read: Request fro Comment: Namas & Zonnequa Wind Farms

Your message

To: Mmboneni Mutheiwana
Subject: Request fro Comment: Namas & Zonnequa Wind Farms
Sent: Tuesday, November 20, 2018 10:45:05 AM (UTC+02:00) Harare, Pretoria

was read on Tuesday, November 20, 2018 3:53:53 PM (UTC+02:00) Harare, Pretoria.

DEPARTMENT OF RURAL DEVELOPMENT AND
LAND REFORM

Savannah Environmental Public Process

From: Savannah Environmental Public Process <publicprocess@savannahsa.com>
Sent: 23 November 2018 12:46 PM
To: 'kgotso.moeketsi@drdlr.gov.za'
Subject: Request fro Comment: Namas & Zonnequa Wind Farms
Attachments: Zonnequa WF BAR NotificaitonLetter.pdf; Namas WF BAR NotificationLetter.pdf

Importance: High

Good day,

This emails serves as a reminder that the comment period for the above mentioned project ends **today the 23rd of November 2018.**

Kindly indicate whether your department will be submitting any comments ?

Thank you and kind regards,

Rozanne Els

Public Participation Co-ordinator | Savannah Environmental (Pty) Ltd
Tel: +27 (0)11 656 3237 | Fax: +27 (0)86 684 0547

[SAWEA Award for Leading Environmental Consultant for Wind Projects in 2013 & 2015](#)

From: Savannah Environmental Public Process [mailto:publicprocess@savannahsa.com]
Sent: 20 November 2018 10:19 AM
To: 'kgotso.moeketsi@drdlr.gov.za' <kgotso.moeketsi@drdlr.gov.za>
Subject: Request fro Comment: Namas & Zonnequa Wind Farms
Importance: High

Dear Kgotso,

With reference to the attached notification letters in regards to the Namas and Zonnequa Wind Farms, we noted that we have not yet received written comment on the Basic Assessment Report for public review from the Northern Cape Department of Rural Development and Land Reform.

This e-mail serves as a reminder that the comment period for the above mentioned project ends on **Friday, 23 November 2018.**

It would be appreciated if you can submit written comment before or on **Friday, 23 November 2018** by close of business.

Should you not have any comments, please inform us accordingly.

Kind regards,

Savannah Environmental Public Process

From: Kgotso Moeketsi <Kgotso.Moeketsi@drdlr.gov.za>
To: Savannah Environmental Public Process
Sent: 20 November 2018 12:26 PM
Subject: Read: Request fro Comment: Namas & Zonnequa Wind Farms

Your message

To: Kgotso Moeketsi
Subject: Request fro Comment: Namas & Zonnequa Wind Farms
Sent: 20 November 2018 10:18:50 AM (UTC+02:00) Harare, Pretoria

was read on 20 November 2018 12:26:06 PM (UTC+02:00) Harare, Pretoria.

Savannah Environmental Public Process

From: Kgotso Moeketsi <Kgotso.Moeketsi@drdlr.gov.za>
To: Savannah Environmental Public Process
Sent: 23 November 2018 2:19 PM
Subject: Read: Request fro Comment: Namas & Zonnequa Wind Farms

Your message

To: Kgotso Moeketsi
Subject: Request fro Comment: Namas & Zonnequa Wind Farms
Sent: Friday, November 23, 2018 12:45:41 PM (UTC+02:00) Harare, Pretoria

was read on Friday, November 23, 2018 2:21:38 PM (UTC+02:00) Harare, Pretoria.

Savannah Environmental Public Process

From: Cynthia Nkoane <Cynthia.Nkoane@drdlr.gov.za>
Sent: 23 November 2018 2:48 PM
To: publicprocess@savannahsa.com
Subject: FW: Request fro Comment: Namas & Zonnequa Wind Farms

From: Cynthia Nkoane
Sent: 23 November 2018 14:46
To: Kgotso Moeketsi
Cc: 'Savannah Environmental Public Process'; Deidre Koopman
Subject: RE: Request fro Comment: Namas & Zonnequa Wind Farms

Dear CD

Please note that we have already responded. We indicated that the properties are privately owned, and therefore we do not have any comments to make.

I just spoke to Ms Rozanne Els to confirm this.

Kind regards
Cindy

From: Kgotso Moeketsi
Sent: 23 November 2018 14:19
To: Cynthia Nkoane
Cc: Itumeleng Mashune
Subject: FW: Request fro Comment: Namas & Zonnequa Wind Farms
Importance: High

From: Savannah Environmental Public Process [mailto:publicprocess@savannahsa.com]
Sent: 23 November 2018 12:46 PM
To: Kgotso Moeketsi
Subject: Request fro Comment: Namas & Zonnequa Wind Farms
Importance: High

Good day,

This emails serves as a reminder that the comment period for the above mentioned project ends **today the 23rd of November 2018.**

Kindly indicate whether your department will be submitting any comments ?

Thank you and kind regards,

Rozanne Els

Public Participation Co-ordinator | Savannah Environmental (Pty) Ltd
Tel: +27 (0)11 656 3237 | Fax: +27 (0)86 684 0547

SAWEA Award for Leading Environmental Consultant for Wind Projects in 2013 & 2015

From: Savannah Environmental Public Process [mailto:publicprocess@savannahsa.com]

Sent: 20 November 2018 10:19 AM

To: 'kgotso.moeketsi@drdlr.gov.za' <kgotso.moeketsi@drdlr.gov.za>

Subject: Request fro Comment: Namas & Zonnequa Wind Farms

Importance: High

Dear Kgotso,

With reference to the attached notification letters in regards to the Namas and Zonnequa Wind Farms, we noted that we have not yet received written comment on the Basic Assessment Report for public review from the Northern Cape Department of Rural Development and Land Reform.

This e-mail serves as a reminder that the comment period for the above mentioned project ends on **Friday, 23 November 2018.**

It would be appreciated if you can submit written comment before or on **Friday, 23 November 2018** by close of business.

Should you not have any comments, please inform us accordingly.

Kind regards,

DEPARTMENT OF ROADS AND PUBLIC WORKS:
NORTHERN CAPE

Savannah Environmental Public Process

From: Savannah Environmental Public Process <publicprocess@savannahsa.com>
Sent: 23 November 2018 12:47 PM
To: 'roelofse.j@vodamail.co.za'
Subject: Request for Comment: Namas & Zonnequa Wind Farms
Attachments: Zonnequa WF BAR NotificaitonLetter.pdf; Namas WF BAR NotificationLetter.pdf

Importance: High

Good day,

This email serves as a reminder that the comment period for the above mentioned project ends **today the 23rd of November 2018**.

Kindly indicate whether your department will be submitting any comments ?

Thank you and kind regards,

Rozanne Els

Public Participation Co-ordinator | Savannah Environmental (Pty) Ltd
Tel: +27 (0)11 656 3237 | Fax: +27 (0)86 684 0547

[SAWEA Award for Leading Environmental Consultant for Wind Projects in 2013 & 2015](#)

From: Savannah Environmental Public Process [mailto:publicprocess@savannahsa.com]
Sent: 20 November 2018 10:08 AM
To: 'roelofse.j@vodamail.co.za' <roelofse.j@vodamail.co.za>
Subject: Request fro Comment: Namas & Zonnequa Wind Farms
Importance: High

Dear Jaco,

With reference to the attached notification letters in regards to the Namas and Zonnequa Wind Farms, we noted that we have not yet received written comment on the Basic Assessment Report for public review from the Northern Cape Department of Roads and Public Works

This e-mail serves as a reminder that the comment period for the above mentioned project ends on **Friday, 23 November 2018**.

It would be appreciated if you can submit written comment before or on **Friday, 23 November 2018** by close of business.

Should you not have any comments, please inform us accordingly.

Kind regards,

Savannah Environmental Public Process

From: Jaco Roelofse <roelofse.j@vodamail.co.za>
To: 'Savannah Environmental Public Process'
Sent: 21 November 2018 7:52 AM
Subject: Read: Request fro Comment: Namas & Zonnequa Wind Farms

Your message

To: roelofse.j@vodamail.co.za
Subject: Request fro Comment: Namas & Zonnequa Wind Farms
Sent: 2018/11/20 10:08

was read on 2018/11/21 07:51.

ESKOM

Savannah Environmental Public Process

From: Savannah Environmental Public Process <publicprocess@savannahsa.com>
Sent: 20 November 2018 10:26 AM
To: 'john.geeringh@eskom.co.za'; 'vangensen@eskom.co.za'
Subject: Request fro Comment: Namas & Zonnequa Wind Farms
Attachments: Zonnequa WF BAR NotificaitonLetter.pdf; Namas WF BAR NotificationLetter.pdf

Importance: High

Dear John and Andrea,

With reference to the attached notification letters in regards to the Namas and Zonnequa Wind Farms, we noted that we have not yet received written comment on the Basic Assessment Report for public review from ESKOM.

This e-mail serves as a reminder that the comment period for the above mentioned project ends on **Friday, 23 November 2018.**

It would be appreciated if you can submit written comment before or on **Friday, 23 November 2018** by close of business.

Should you not have any comments, please inform us accordingly.

Kind regards,

NAMA KHOI LOCAL MUNICIPALITY

Savannah Environmental Public Process

From: Savannah Environmental Public Process <publicprocess@savannahsa.com>
Sent: 23 November 2018 12:42 PM
To: 'municipal.manager@namakhoi.gov.za'
Subject: Request fro Comment: Namas & Zonnequa Wind Farms
Attachments: Zonnequa WF BAR NotificaitonLetter.pdf; Namas WF BAR NotificationLetter.pdf

Importance: High

Good day,

With reference to the emails below, this email serves as a reminder that the comment period for the above mentioned project ends **Today, the 23rd of November 2018.**

Kindly indicate whether the municipality will be submitting any comments ?

Thank you and kind regards,

Rozanne Els

Public Participation Co-ordinator | Savannah Environmental (Pty) Ltd
Tel: +27 (0)11 656 3237 | Fax: +27 (0)86 684 0547

[SAWEA Award for Leading Environmental Consultant for Wind Projects in 2013 & 2015](#)

From: Savannah Environmental Public Process [mailto:publicprocess@savannahsa.com]
Sent: 20 November 2018 10:21 AM
To: 'municipal.manager@namakhoi.gov.za' <municipal.manager@namakhoi.gov.za>
Subject: Request fro Comment: Namas & Zonnequa Wind Farms
Importance: High

Dear Samantha,

With reference to the attached notification letters in regards to the Namas and Zonnequa Wind Farms, we noted that we have not yet received written comment on the Basic Assessment Report for public review from the Nama Khoi Local Municipality.

This e-mail serves as a reminder that the comment period for the above mentioned project ends on **Friday, 23 November 2018.**

It would be appreciated if you can submit written comment before or on **Friday, 23 November 2018** by close of business.

Should you not have any comments, please inform us accordingly.

Kind regards,

NAMAKWA DISTRICT MUNICIPALITY

Savannah Environmental Public Process

From: Savannah Environmental Public Process <publicprocess@savannahsa.com>
Sent: 23 November 2018 12:44 PM
To: 'chrisf@namakwa-dm.gov.za'
Subject: Request fro Comment: Namas & Zonnequa Wind Farms
Attachments: Zonnequa WF BAR NotificaitonLetter.pdf; Namas WF BAR NotificationLetter.pdf

Importance: High

Dear Chris,

With reference to the email below, this email below this email serves as a reminder that the comment period for the above mentioned project ends **Today, the 23rd of November r2018.**

Kindly indicate whether the Municipality will be submitting any comments ?

Thank you and kind regards,

Rozanne Els

Public Participation Co-ordinator | Savannah Environmental (Pty) Ltd
Tel: +27 (0)11 656 3237 | Fax: +27 (0)86 684 0547

[SAWEA Award for Leading Environmental Consultant for Wind Projects in 2013 & 2015](#)

From: Savannah Environmental Public Process [mailto:publicprocess@savannahsa.com]
Sent: 20 November 2018 10:20 AM
To: 'chrisf@namakwa-dm.gov.za' <chrisf@namakwa-dm.gov.za>
Subject: Request fro Comment: Namas & Zonnequa Wind Farms
Importance: High

Dear Chris,

With reference to the attached notification letters in regards to the Namas and Zonnequa Wind Farms, we noted that we have not yet received written comment on the Basic Assessment Report for public review from the Namakwa District Municipality.

This e-mail serves as a reminder that the comment period for the above mentioned project ends on **Friday, 23 November 2018.**

It would be appreciated if you can submit written comment before or on **Friday, 23 November 2018** by close of business.

Should you not have any comments, please inform us accordingly.

Kind regards,

SOUTH AFRICAN CIVIL AVIATION AUTHORITY

Savannah Environmental Public Process

From: Savannah Environmental Public Process <publicprocess@savannahsa.com>
Sent: 20 November 2018 10:29 AM
To: 'Lizelle Stroh'
Subject: Request fro Comment: Namas & Zonnequa Wind Farms
Attachments: Zonnequa WF BAR NotificaitonLetter.pdf; Namas WF BAR NotificationLetter.pdf

Importance: High

Dear Lizell,

With reference to the attached notification letters in regards to the Namas and Zonnequa Wind Farms, we noted that we have not yet received written comment on the Basic Assessment Report for public review from South African Civil Aviation Authority.

This e-mail serves as a reminder that the comment period for the above mentioned project ends on **Friday, 23 November 2018.**

It would be appreciated if you can submit written comment before or on **Friday, 23 November 2018** by close of business.

Should you not have any comments, please inform us accordingly.

Kind regards,

SANPARKS

Rozanne Els

From: Tebogo Mohudi <tebogo.mohudi@sanparks.org>
Sent: 21 November 2018 3:30 PM
To: Rozanne Els
Subject: RE: Namas and Zonnequa Wind Farms

Hi Rozanne.
Thanks for your email.
I will follow-up with him.
Regards
Jakes

From: Rozanne Els [mailto:rozanne@savannahsa.com]
Sent: 21 November 2018 2:30 PM
To: Tebogo Mohudi
Subject: Namas and Zonnequa Wind Farms
Importance: High

Good day Tebogo,

I am referring to our telephonic conversation we just had.

We have sent a report to your offices, but was addressed to Mike Knight. Someone did however receive it. We only found out afterwards that he is not there anymore and that Mr Howard Hendricks is the relevant person.

Please see the Proof of Delivery attached.

Please could you maybe assist ? we want to know if SANPARKS will be giving comment as the review period is ending on Friday the 23rd of November 2018.

Kind regards,

savannah
environmental

t: 011 656 3237
f: 086 684 0547

Rozanne Els
Public Participation and Administration
Co-ordinator

e: rozanne@savannahsa.com
c: +27 (0) 83 268 8719

SAWEA Award for Leading Environmental Consultant on Wind Projects in 2013 & 2015

Disclaimer: 1) Confidentiality: This email communication and any attachments sent from tebogo.mohudi@sanparks.org to rozanne@savannahsa.com on 2018-11-21 15:30:17 are confidential and may contain privileged or copyright information. You may not present this message to another party without consent from the sender. If you are not rozanne@savannahsa.com please notify tebogo.mohudi@sanparks.org and delete this email and you are notified that disclosing, copying, distributing or taking any action in reliance on the contents of this information is strictly prohibited. 2) Liability: This email is not a binding agreement and does not conclude an agreement without the express confirmation by the sender's superior or relevant authorisation of SANParks. 3) Viruses: SANParks does not certify that this email is free of viruses or defects. 4) Requested: SANParks does not consent to its employees sending un-asked for emails which contravene the law. In the event that you feel this email is such, please notify SANParks in order for the appropriate corrective action to be taken. 5) Advice: Any views or opinions presented in this email are solely those of the author and do not necessarily represent those of SANParks. Any actions taken on the basis of this email are at the reader's own risk. 6) Other: The sender of this email is expressly required not make any defamatory statements. Any such communication is contrary to SANParks policy and outside the scope of the employment of the individual concerned. SANParks will not accept any liability in respect of such communication, and the employee responsible will be personally liable for any damages or other liability arising. Thank you. South African National Parks 643 Leyds Street, Muckleneuk, Pretoria, South Africa

SOUTH AFRICAN NATIONAL ROADS AGENCY
LIMITED (SANRAL)

Savannah Environmental Public Process

From: Savannah Environmental Public Process <publicprocess@savannahsa.com>
Sent: 23 November 2018 12:34 PM
To: 'Abrahamsn@nra.co.za'
Subject: Request fro Comment: Namas & Zonnequa Wind Farms
Attachments: Zonnequa WF BAR NotificaitonLetter.pdf; Namas WF BAR NotificationLetter.pdf

Importance: High

Hi Nicole,

This email serves as a reminder that the comment period for the above mentioned project ends **Today the 23rd of November 2018.**

Kindly indicate if you will be submitting any comments ?

Thank you and kind regards,

Rozanne Els

Public Participation Co-ordinator | Savannah Environmental (Pty) Ltd
Tel: +27 (0)11 656 3237 | Fax: +27 (0)86 684 0547

[SAWEA Award for Leading Environmental Consultant for Wind Projects in 2013 & 2015](#)

From: Savannah Environmental Public Process [mailto:publicprocess@savannahsa.com]
Sent: 20 November 2018 10:30 AM
To: 'Abrahamsn@nra.co.za' <Abrahamsn@nra.co.za>
Subject: Request fro Comment: Namas & Zonnequa Wind Farms
Importance: High

Dear Nicole,

With reference to the attached notification letters in regards to the Namas and Zonnequa Wind Farms, we noted that we have not yet received written comment on the Basic Assessment Report for public review from SANRAL.

This e-mail serves as a reminder that the comment period for the above mentioned project ends on **Friday, 23 November 2018.**

It would be appreciated if you can submit written comment before or on **Friday, 23 November 2018** by close of business.

Should you not have any comments, please inform us accordingly.

Kind regards,

Savannah Environmental Public Process

From: Nicole Abrahams (WR) <AbrahamsN@nra.co.za>
To: Savannah Environmental Public Process
Sent: 20 November 2018 3:15 PM
Subject: Read: Request fro Comment: Namas & Zonnequa Wind Farms

Your message

To: Nicole Abrahams (WR)
Subject: Request fro Comment: Namas & Zonnequa Wind Farms
Sent: Tuesday, November 20, 2018 10:30:27 AM (UTC+02:00) Harare, Pretoria

was read on Tuesday, November 20, 2018 3:14:49 PM (UTC+02:00) Harare, Pretoria.

SOUTH AFRICAN RADIO ASTRONOMY
OBSERVATORY (SARAO) / SQUARE KILOMETRE
ARRAY

Savannah Environmental Public Process

From: Savannah Environmental Public Process <publicprocess@savannahsa.com>
Sent: 23 November 2018 12:33 PM
To: 'atiplady@ska.ac.za'
Subject: Request fro Comment: Namas & Zonnequa Wind Farms
Attachments: Zonnequa WF BAR NotificaitonLetter.pdf; Namas WF BAR NotificationLetter.pdf

Importance: High

Dear Adrian,

This email serves as a reminder that the comment period for the above mentioned project ends **Today the 23rd of November 2018.**

Kindly indicate if you will be submitting comments ?

Thank you and kind regards,

Rozanne Els

Public Participation Co-ordinator | Savannah Environmental (Pty) Ltd
Tel: +27 (0)11 656 3237 | Fax: +27 (0)86 684 0547

[SAWEA Award for Leading Environmental Consultant for Wind Projects in 2013 & 2015](#)

From: Savannah Environmental Public Process [mailto:publicprocess@savannahsa.com]
Sent: 20 November 2018 10:32 AM
To: 'atiplady@ska.ac.za' <atiplady@ska.ac.za>
Subject: Request fro Comment: Namas & Zonnequa Wind Farms
Importance: High

Dear Adrian,

With reference to the attached notification letters in regards to the Namas and Zonnequa Wind Farms, we noted that we have not yet received written comment on the Basic Assessment Report for public review from SKA.

This e-mail serves as a reminder that the comment period for the above mentioned project ends on **Friday, 23 November 2018.**

It would be appreciated if you can submit written comment before or on **Friday, 23 November 2018** by close of business.

Should you not have any comments, please inform us accordingly.

Kind regards,

Savannah Environmental Public Process

From: Adrian Tiplady <atiplady@ska.ac.za>
Sent: 26 November 2018 8:26 AM
To: Savannah Environmental Public Process
Cc: Busang Sethole
Subject: Re: Request fro Comment: Namas & Zonnequa Wind Farms

Hi Rozanne,

Apologies for the delay - the facility will not pose any detrimental impact on the SKA. My colleague Busang, cc'd on this email, will send you a formal submission confirming this.

Regards,

Adrian

On 23/11/2018 12:32 PM, Savannah Environmental Public Process wrote:

Dear Adrian,

This email serves as a reminder that the comment period for the above mentioned project ends **Today the 23rd of November 2018.**

Kindly indicate if you will be submitting comments ?

Thank you and kind regards,

Rozanne Els

Public Participation Co-ordinator | Savannah Environmental (Pty) Ltd
Tel: +27 (0)11 656 3237 | Fax: +27 (0)86 684 0547

SAWEA Award for Leading Environmental Consultant for Wind Projects in 2013 & 2015

From: Savannah Environmental Public Process [<mailto:publicprocess@savannahsa.com>]

Sent: 20 November 2018 10:32 AM

To: 'atiplady@ska.ac.za' <atiplady@ska.ac.za>

Subject: Request fro Comment: Namas & Zonnequa Wind Farms

Importance: High

Dear Adrian,

With reference to the attached notification letters in regards to the Namas and Zonnequa Wind Farms, we noted that we have not yet received written comment on the Basic Assessment Report for public review from SKA.

This e-mail serves as a reminder that the comment period for the above mentioned project ends on **Friday, 23 November 2018.**

It would be appreciated if you can submit written comment before or on **Friday, 23 November 2018** by close of business.

Should you not have any comments, please inform us accordingly.

Kind regards,

--

Dr. Adrian Tiplady
SKA South Africa
Johannesburg
+27 11 442 2434
+27 72 372 0134
www.ska.ac.za

Rozanne Els

From: Nicolene Venter <nicolene@savannahsa.com>
Sent: 26 November 2018 10:10 AM
To: 'Busang Sethole'
Cc: 'Adrian Tiplady'; 'Musa Baloye'; 'Sonia Miszczak'; 'Tamsin Sheard'; 'Lisa Opperman'; 'Rozanne Els'
Subject: ZONNEQUA WIND FARM: Basic Assessment Report - Acknowledgement of Comments

Dear Mr Sethole,

Please receive herewith acknowledgement of SARAO's comment on the Basic Assessment Report for the proposed Zonnequa Wind Farm project.

As requested, we confirm that SARAO will be kept inform of the Basic Assessment process of this project and we will inform the client to keep SARAO informed should they be successful in the BIDDING process.

Kind regards,

Nicolene Venter

Public Participation & Social Consultant | Savannah Environmental (Pty) Ltd
Tel: +27 (0)11 656 3237 | Fax: +27 (0)86 684 0547

[SAWEA Award for Leading Environmental Consultant for Wind Projects in 2013 & 2015](#)

From: Busang Sethole <bsethole@ska.ac.za>
Sent: Monday, November 26, 2018 8:55 AM
To: publicprocess@savannahsa.com
Cc: Adrian Tiplady <atiplady@ska.ac.za>; nicolene@savannahsa.com; Musa Baloye <mbaloye@ska.ac.za>
Subject: Re: Request fro Comment: Namas & Zonnequa Wind Farms

Good Day

Kindly find the signed response from SARAO on the basic assessment report.

BR,

Busang Sethole

Analyst: Spectrum and Telecoms
South African Radio Astronomy Observatory
www.ska.ac.za
17 Baker Street, Rosebank, South Africa
Phone: +27 11 442 3449

On Mon, Nov 26, 2018 at 8:44 AM Savannah Environmental Public Process <publicprocess@savannahsa.com> wrote:

Dear Adrian,

Thank you. We will await the formal submission.

Kind regards,

Rozanne Els

Public Participation Co-ordinator | Savannah Environmental (Pty) Ltd

Tel: +27 (0)11 656 3237 | Fax: +27 (0)86 684 0547

[SAWEA Award for Leading Environmental Consultant for Wind Projects in 2013 & 2015](#)

From: Adrian Tiplady [mailto:atiplady@ska.ac.za]
Sent: 26 November 2018 8:26 AM
To: Savannah Environmental Public Process <publicprocess@savannahsa.com>
Cc: Busang Sethole <bsethole@ska.ac.za>
Subject: Re: Request fro Comment: Namas & Zonnequa Wind Farms

Hi Rozanne,

Apologies for the delay - the facility will not pose any detrimental impact on the SKA. My colleague Busang, cc'd on this email, will send you a formal submission confirming this.

Regards,

Adrian

On 23/11/2018 12:32 PM, Savannah Environmental Public Process wrote:

Dear Adrian,

This email serves as a reminder that the comment period for the above mentioned project ends **Today the 23rd of November 2018.**

Kindly indicate if you will be submitting comments ?

Thank you and kind regards,

Rozanne Els

Public Participation Co-ordinator | Savannah Environmental (Pty) Ltd

Tel: +27 (0)11 656 3237 | Fax: +27 (0)86 684 0547

SAWEA Award for Leading Environmental Consultant for Wind Projects in 2013 & 2015

From: Savannah Environmental Public Process [<mailto:publicprocess@savannahsa.com>]

Sent: 20 November 2018 10:32 AM

To: 'atiplady@ska.ac.za' <atiplady@ska.ac.za>

Subject: Request fro Comment: Namas & Zonnequa Wind Farms

Importance: High

Dear Adrian,

With reference to the attached notification letters in regards to the Namas and Zonnequa Wind Farms, we noted that we have not yet received written comment on the Basic Assessment Report for public review from SKA.

This e-mail serves as a reminder that the comment period for the above mentioned project ends on **Friday, 23 November 2018.**

It would be appreciated if you can submit written comment before or on **Friday, 23 November 2018** by close of business.

Should you not have any comments, please inform us accordingly.

Kind regards,

--

Dr. Adrian Tiplady
SKA South Africa
Johannesburg
+27 11 442 2434
+27 72 372 0134
www.ska.ac.za



Virus-free. www.avast.com

SENTECH

Savannah Environmental Public Process

From: Savannah Environmental Public Process <publicprocess@savannahsa.com>
Sent: 20 November 2018 10:28 AM
To: 'info@sentech.co.za'
Subject: Request fro Comment: Namas & Zonnequa Wind Farms
Attachments: Zonnequa WF BAR NotificaitonLetter.pdf; Namas WF BAR NotificationLetter.pdf

Importance: High

Dear Marlon,

With reference to the attached notification letters in regards to the Namas and Zonnequa Wind Farms, we noted that we have not yet received written comment on the Basic Assessment Report for public review from SENTECH.

This e-mail serves as a reminder that the comment period for the above mentioned project ends on **Friday, 23 November 2018.**

It would be appreciated if you can submit written comment before or on **Friday, 23 November 2018** by close of business.

Should you not have any comments, please inform us accordingly.

Kind regards,