

CO-ORDINATES (System WGS 84)		
POINT	Y	X
o	-33731.7614	3763975.4496
p	-33745.6071	3764022.3626
q	-33881.7584	3763960.2894
r	-34021.8390	3763862.4592
s	-34024.7018	3763866.5585
t	-33884.2475	3763964.6498
u	-33742.4703	3764029.2878
v	-33728.4409	3763981.7525

SERVITUDE DIAGRAM
NOT TO SCALE

DESIGNED	RDB	APPROVED	SCALE	NELSON MANDELA BAY MUNICIPALITY SEAVIEW BULK WATER		 Consulting Engineers • Project Managers
DRAWN	SM/TS	PROJECT MANAGER	1 : 10000	PORTION 1 & 10 S.G. No B1076/1927		
CHECKED	GC	DIRECTOR	DATE	12/12/16		
COPYRIGHT AND USE OF THIS DRAWING IS RESERVED BY BOSCH STEMELE			DRAWING NUMBER	8003/011/011F	A4 REVISION 2	



SIDES METERS	ANGLES OF DIRECTION	CO-ORDINATES (System WGS 84)	
		Y	X
		0	+37 00 000.0
AB	345.00 283 44 17	A	-33382.730 63168.755
BC	749.70 4 9 53	B	-33717.830 63250.655
CD	80.00 72 28 20	C	-33663.330 63998.355
DE	193.40 187 44 20	D	-33587.030 64022.455
EF	79.70 97 40 10	E	-33613.030 63830.855
FG	361.90 122 58 40	F	-33534.030 63820.155
GA	479.20 198 31 50	G	-33230.430 63623.155

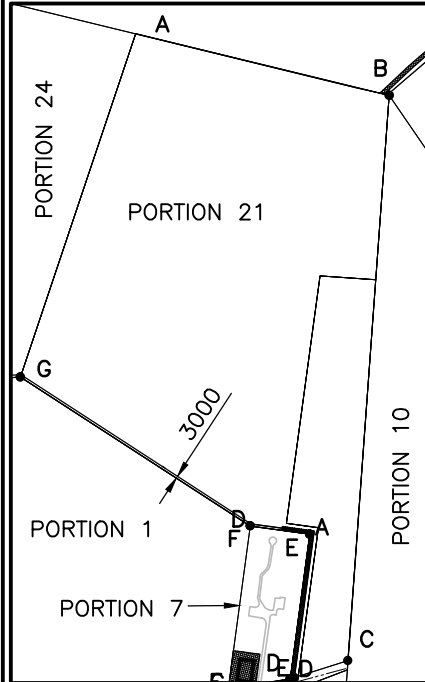

CO-ORDINATES (System WGS 84)		
POINT	Y	X
a	-33231.415	3763620.218
b	-33230.430	3763623.155
c	-33535.099	3763817.272
d	-33534.030	3763820.155
e	-33573.858	3763822.522
f	-33573.550	3763825.500
g	-33613.030	3763830.855
h	-33618.657	3763826.572
i	-33587.030	3764022.455
j	-33592.334	3764020.739
k	-33576.647	3763820.882

THE LINE A B C D E F G REPRESENTS 24.0770 HECTARES OF LAND BEING PORTION 21 (A PORTION OF SEAVIEW WEST) OF THE FARM SEA VIEW

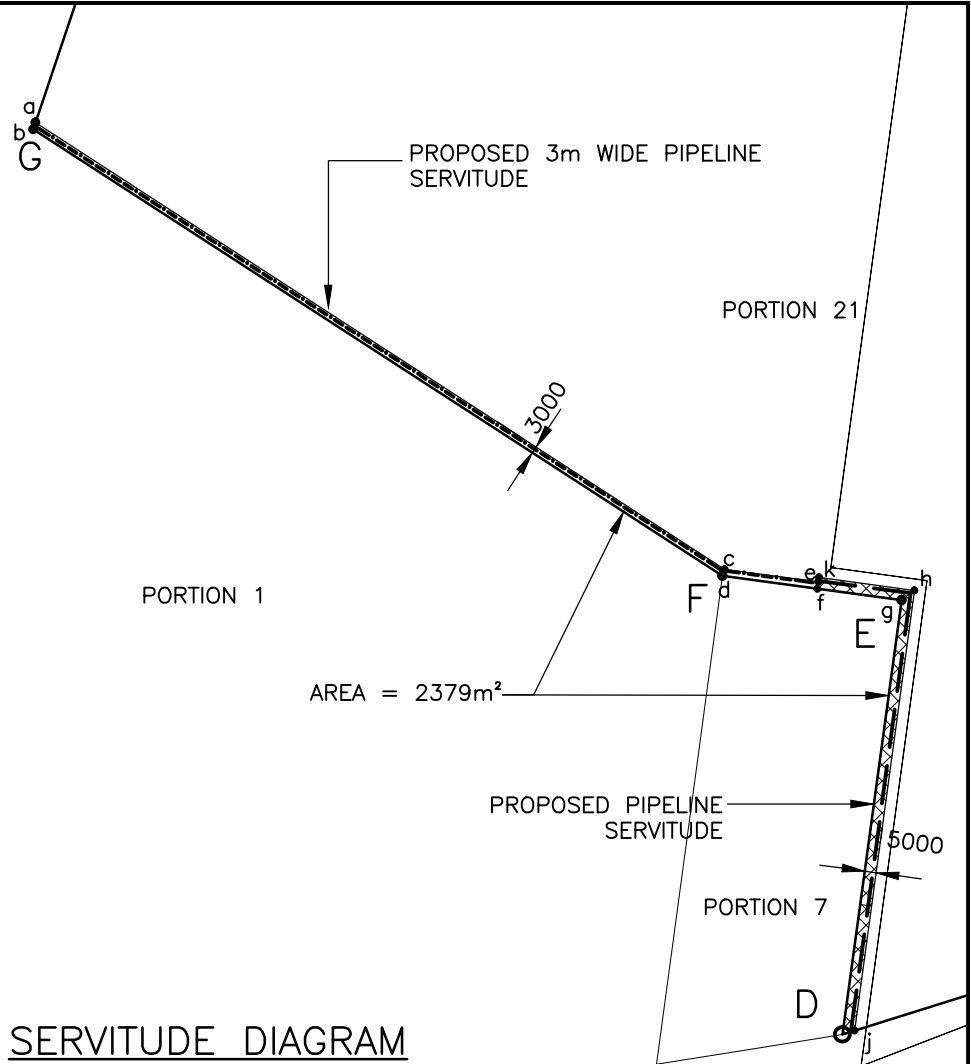

SERVITUDE DIAGRAM
NOT TO SCALE

DESIGNED	RDB	APPROVED	SCALE
DRAWN	TS	PROJECT MANAGER	1 : 10000
CHECKED	GC	DIRECTOR	DATE
			03/12/08

NELSON MANDELA BAY MUNICIPALITY
SEAVIEW BULK WATER

PORTION 21
S.G. No 2312/70



Consulting Engineers • Project Managers

BOSCH STEMELE (PTY) LTD.
P.O. BOX 27158, GREENACRES, P.E. 6057.
BLOCK 2, GROUND FLOOR, GREENACRES OFFICE PARK
2nd AVENUE, NEWTON PARK, PORT ELIZABETH, 6045, RSA
TELEPHONE: (041) 363 0598 TELEFAX: (041) 363 7646
E-mail: bsp@boschstemele.co.za
www.boschstemele.co.za



COPYRIGHT AND USE OF THIS DRAWING IS RESERVED BY BOSCH STEMELE

DRAWING NUMBER

8003/011/011E

A4

REVISION

0

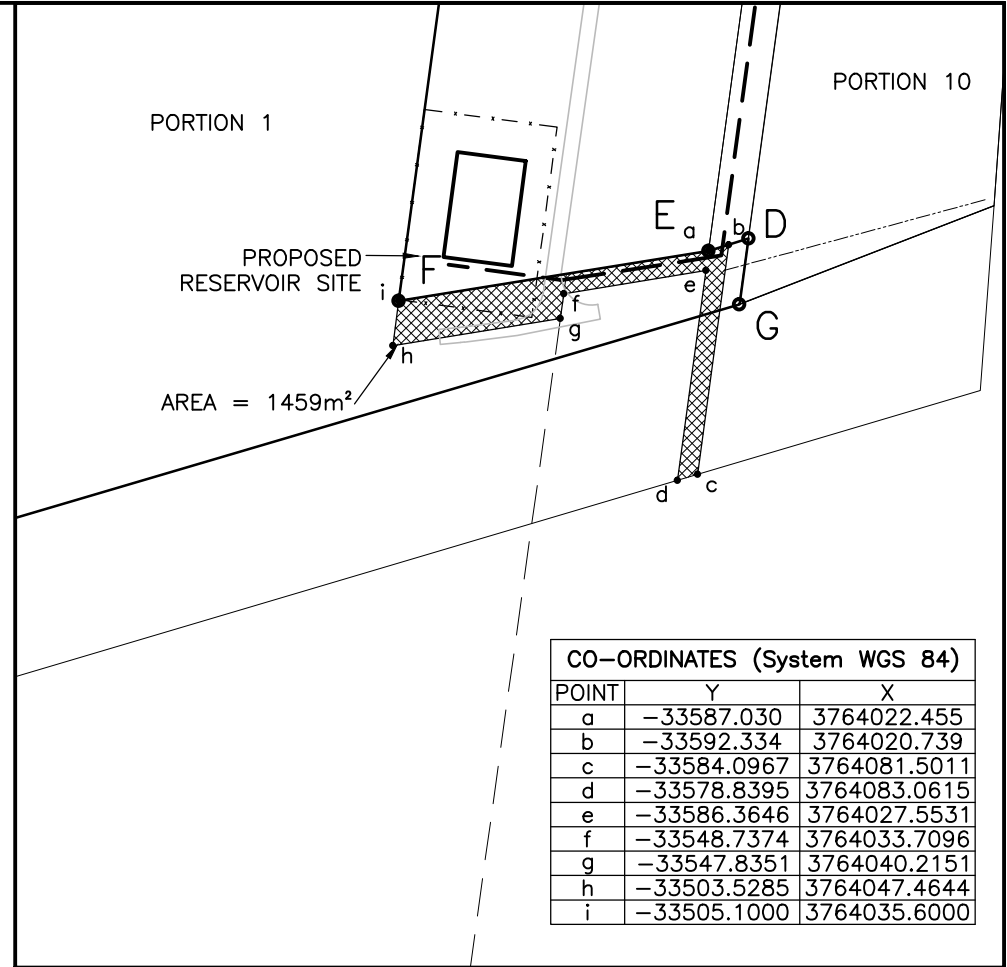

SIDES	METERS	ANGLES OF DIRECTION	CO-ORDINATES (System WGS 84)	
			Y	X
			0	+37 00 000.0
DE	11.10	253 0 0	D -33597.600	64019.100
EF	263.49	80 52 30	E -33586.987	64022.446
DG	17.55	8 0 0	F -33505.074	64035.604
			G 33595.200	64036.500

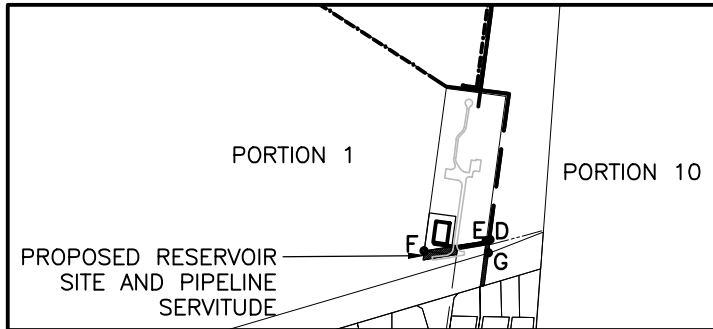

CO-ORDINATES (System WGS 84)		
POINT	Y	X
a	-33587.030	3764022.455
b	-33592.334	3764020.739
c	-33584.0967	3764081.5011
d	-33578.8395	3764083.0615
e	-33586.3646	3764027.5531
f	-33548.7374	3764033.7096
g	-33547.8351	3764040.2151
h	-33503.5285	3764047.4644
i	-33505.1000	3764035.6000



SERVITUDE DIAGRAM
NOT TO SCALE

DESIGNED RDB	APPROVED	SCALE	<p align="center">NELSON MANDELA BAY MUNICIPALITY SEAVIEW BULK WATER</p> <p align="center">PORTION 1 S.G. No B1076/1927</p>	 <p align="center">Consulting Engineers • Project Managers</p> <p><small>BOSCH STEMELE (PTY) LTD. P.O. BOX 27158, GREENACRES, P.E. 6057. BLOCK 2, GROUND FLOOR, GREENACRES OFFICE PARK 2nd AVENUE, NEWTON PARK, PORT ELIZABETH, 6045, RSA TELEPHONE: (041) 363 0598 TELEFAX: (041) 363 7646 E-mail: bspe@boschstemele.co.za www.boschstemele.co.za</small></p> 			
DRAWN TS	PROJECT MANAGER	1 : 10000					
CHECKED GC	DIRECTOR	DATE					
		03/12/08					
COPYRIGHT AND USE OF THIS DRAWING IS RESERVED BY BOSCH STEMELE			DRAWING NUMBER	8003/011/011D	A4	REVISION	0

SIDES (FEET)	ANGLES OF DIRECTION	CO-ORDINATES (System WGS 84)	
		Y	X
		0	+37 00 000.0
AB	614.18 7 44 20	A	-33613.025 63830.828
BC	263.49 80 52 30	B	-33586.987 64022.446
CD	690.32 187 39 50	C	-33505.074 64035.604
DA	253.07 277 40 10	D	-33534.056 63820.195

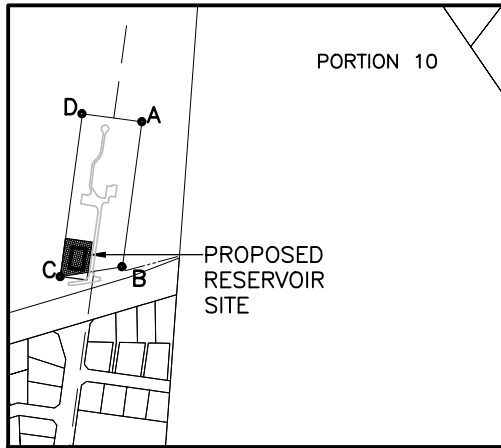

CO-ORDINATES (System WGS 84)		
POINT	Y	X
a	-33511.9194	3763984.9487
b	-33546.9694	3763989.6258
c	-33541.6210	3764029.7419
d	-33505.074	3764035.604

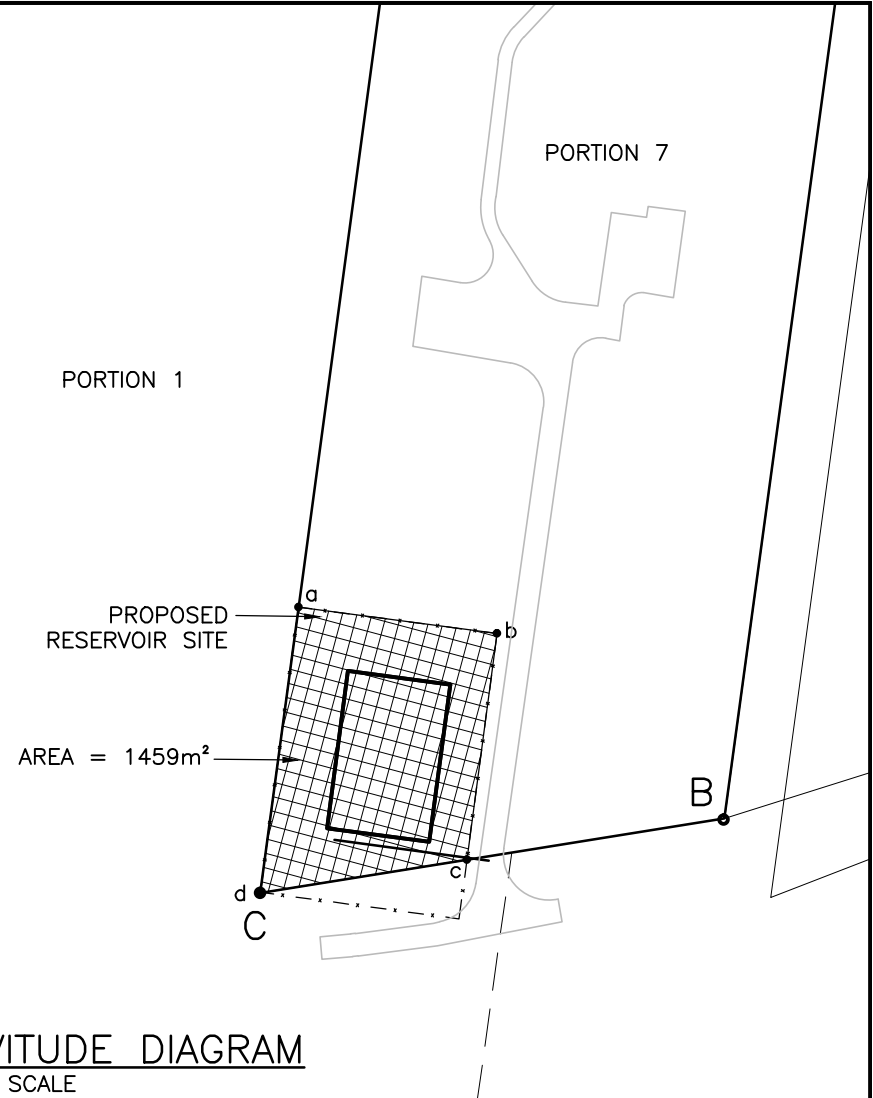

SERVITUDE DIAGRAM
NOT TO SCALE

DESIGNED	RDB	APPROVED PROJECT MANAGER DIRECTOR	SCALE
DRAWN	TS		1 : 10000
CHECKED	GC		DATE
			03/12/08

**NELSON MANDELA BAY
MUNICIPALITY
SEAVIEW BULK WATER**

PORTION 7
S.G. No 6716/55



Consulting Engineers • Project Managers

BOSCH STEMELE (PTY) LTD.
P.O. BOX 27158, GREENACRES, P.E. 6057.
BLOCK 2, GROUND FLOOR, GREENACRES OFFICE PARK
2nd AVENUE, NEWTON PARK, PORT ELIZABETH, 6045, RSA
TELEPHONE: (041) 363 0598 TELEFAX: (041) 363 7646
E-mail: bspe@boschstemele.co.za
www.boschstemele.co.za



COPYRIGHT AND USE OF THIS DRAWING IS RESERVED BY BOSCH STEMELE

DRAWING NUMBER

8003/011/011C

A4

REVISION

0

SIDES METERS	ANGLES OF DIRECTION	CO-ORDINATES (System WGS 84)	
		Y	X
		0	+37 00 000.0
AB	43.24 46 36 30	A	-33710.858 63249.139
BC	46.90 43 14 00	B	-33679.420 63278.905
CD	52.07 12 03 10	C	-33647.300 63313.075
DE	32.16 12 21 30	D	-33636.430 63363.985
EF	83.96 8 34 30	E	-33629.540 63395.375
FG	349.72 7 43 00	F	-33617.038 63478.369
		G	-33570.070 63824.975

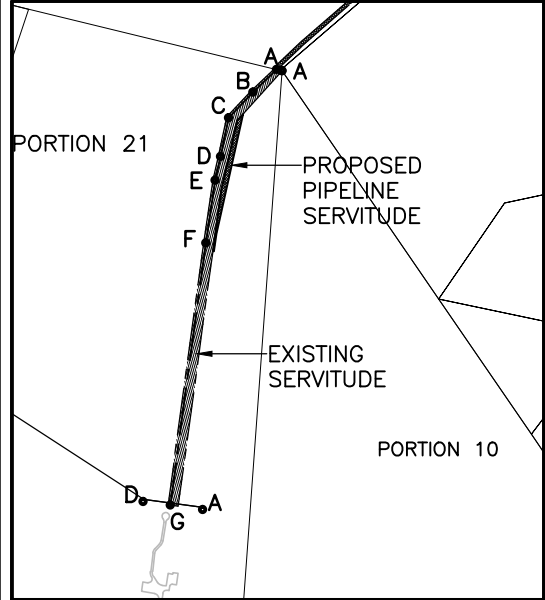

CO-ORDINATES (System WGS 84)		
POINT	Y	X
a	-33666.1671	3763308.0938
b	-33658.7570	3763316.3303
c	-33630.9177	3763466.1086
d	-33637.3490	3763408.0747
e	-33627.7669	3763489.3704
f	-33626.3200	3763489.2650

THE LINE A B C D E F G REPRESENTS THE CENTRE LINE OF A PIPE LINE SERVITUDE 6 METRES WIDE OVER REMAINDER PORTION 21 (A PORTION OF SEAVIEW WEST) OF THE FARM SEA VIEW No. 28

SERVITUDE DIAGRAM
NOT TO SCALE

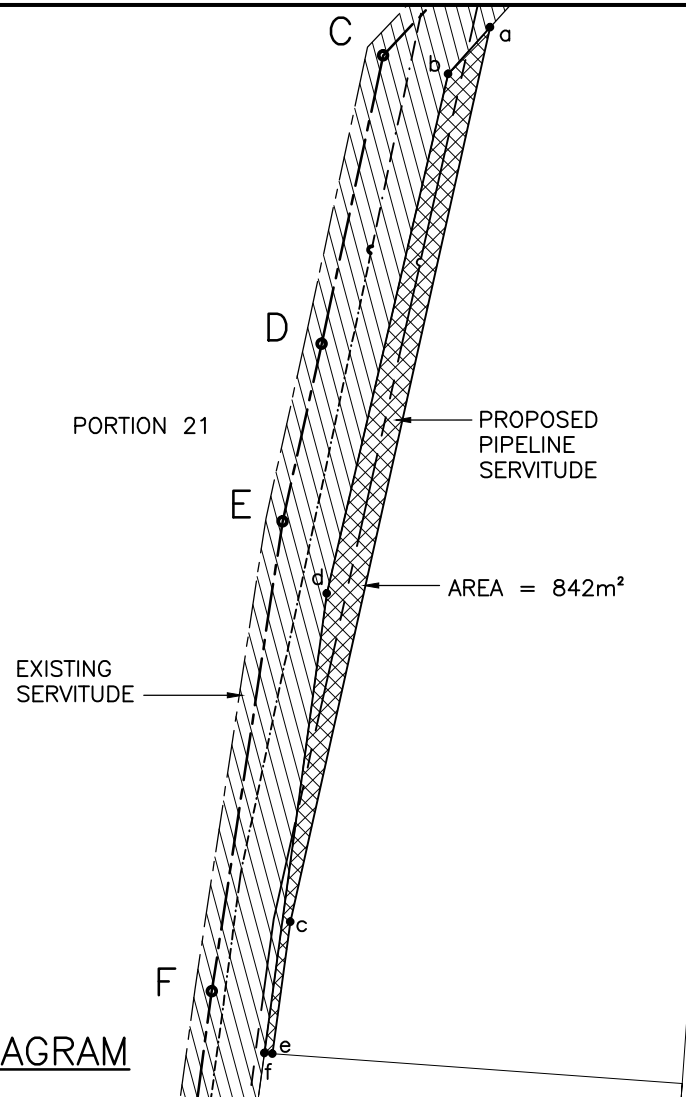

DESIGNED	RB	APPROVED PROJECT MANAGER	SCALE
DRAWN	SM		1 : 10000
CHECKED	GC		DATE
		DIRECTOR	03/12/08

NELSON MANDELA BAY MUNICIPALITY
SEAVIEW BULK WATER

PORTION 21
S.G. No 2494/1996

BOSCH STEMELE

Consulting Engineers • Project Managers

BOSCH STEMELE (PTY) LTD.
P.O. BOX 27158, GREENACRES, P.E. 6057.
BLOCK 2, GROUND FLOOR, GREENACRES OFFICE PARK
2nd AVENUE, NEWTON PARK, PORT ELIZABETH, 6045, RSA
TELEPHONE: (041) 363 0598 TELEFAX: (041) 363 7646
E-mail: bspe@boschstemele.co.za
www.boschstemele.co.za

COPYRIGHT AND USE OF THIS DRAWING IS RESERVED BY BOSCH STEMELE	DRAWING NUMBER	8003/011/011B	A4	REVISION	0
--	----------------	---------------	----	----------	---

SIDES (FEET)	ANGLES OF DIRECTION		CO-ORDINATES (System WGS 84)	
			Y	X
			0	+37 00 000.0
AB	1381.20	229 13 00	A	-33717.910 63250.791
Bd	902.60	213 28 50	B	-34047.186 62966.729
dC	1262.40	213 28 50	C	-34423.249 62398.162

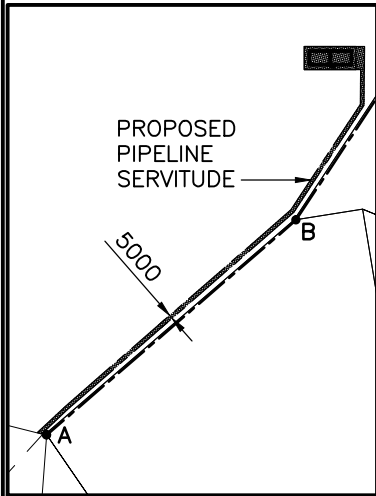

CO-ORDINATES (System WGS 84)		
POINT	Y	X
a	-33705.553	3763247.654
b	-33711.338	3763249.068
c	-33742.555	3763212.714
d	-33745.988	3763216.349
e	-34040.413	3762953.108
f	-34044.216	3762956.426
g	-34131.965	3762813.612
h	-34136.950	3762815.129
i	-34132.439	3762767.464
j	-34058.247	3762767.464
k	-34058.247	3762737.263
l	-34137.723	3762737.263
m	-34137.423	3762767.437

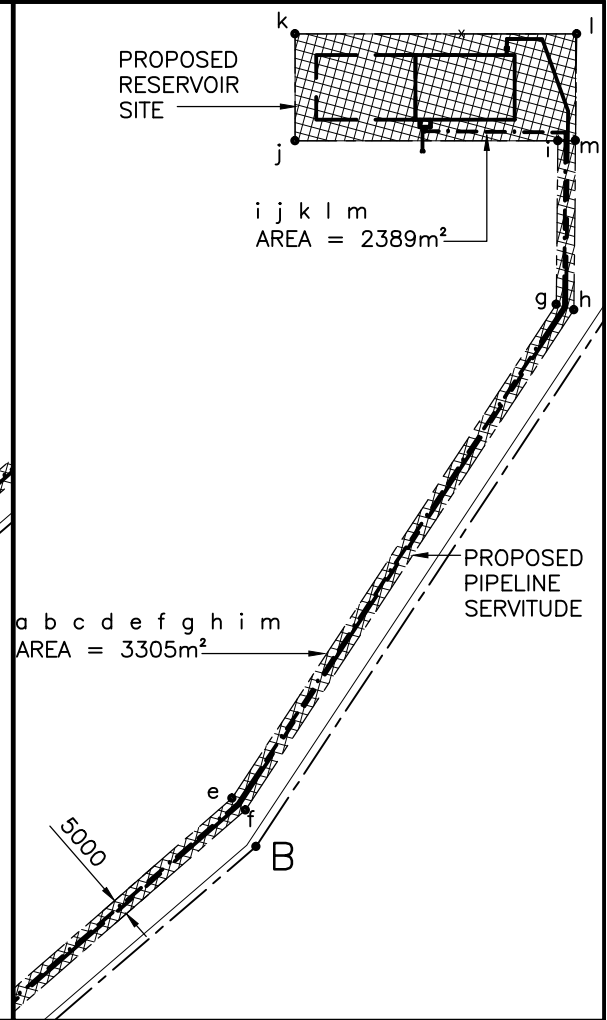
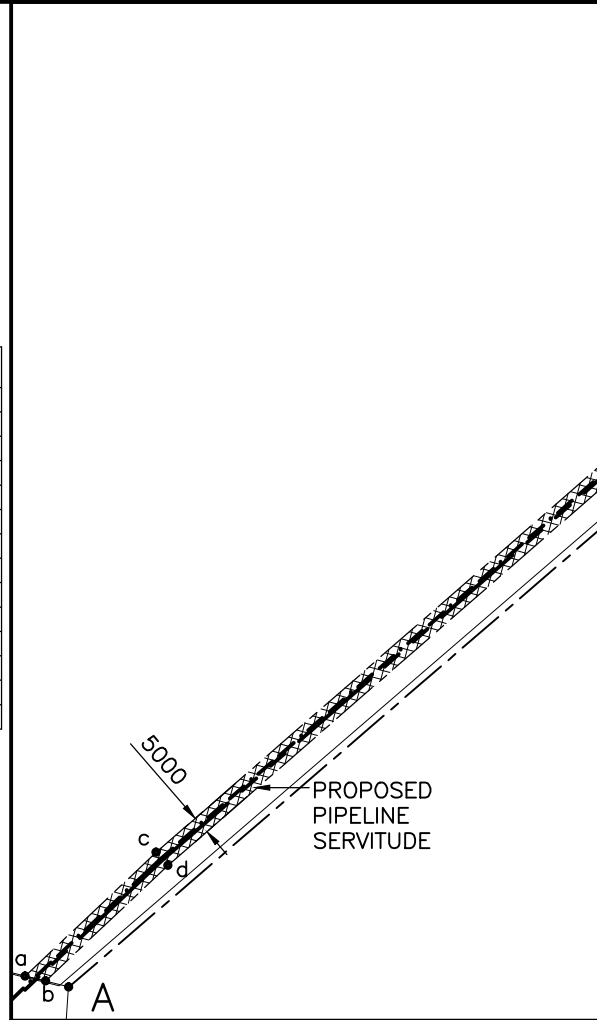

SERVITUDE DIAGRAM
NOT TO SCALE

DESIGNED	RDB	APPROVED	SCALE
DRAWN	SM	PROJECT MANAGER	1 : 10000
CHECKED	GC	DIRECTOR	DATE
			03/12/08

NELSON MANDELA BAY
MUNICIPALITY
SEAVIEW BULK WATER

THE ISLAND No. 486
S.G. No 6457/68

BOSCH STEMELE

Consulting Engineers • Project Managers

BOSCH STEMELE (PTY) LTD.
P.O. BOX 27158, GREENACRES, P.E. 6057.
BLOCK 2, GROUND FLOOR, GREENACRES OFFICE PARK
2nd AVENUE, NEWTON PARK, PORT ELIZABETH, 6045, RSA
TELEPHONE: (041) 363 0598 TELEFAX: (041) 363 7646
E-mail: bsp@boschstemele.co.za
www.boschstemele.co.za

COPYRIGHT AND USE OF THIS DRAWING IS RESERVED BY BOSCH STEMELE

DRAWING NUMBER **8003/011/011A** A4 REVISION **0**

SIDES METERS	ANGLES OF DIRECTION	CO-ORDINATES (System WGS 84)			
		Y	X		
		0	+37 00 000.0		
AB	456.600	109 0 20	A	-31253.330	63255.855
AC	574.100	204 2 40	B	-31685.030	63404.555
			C	-31019.500	63780.200

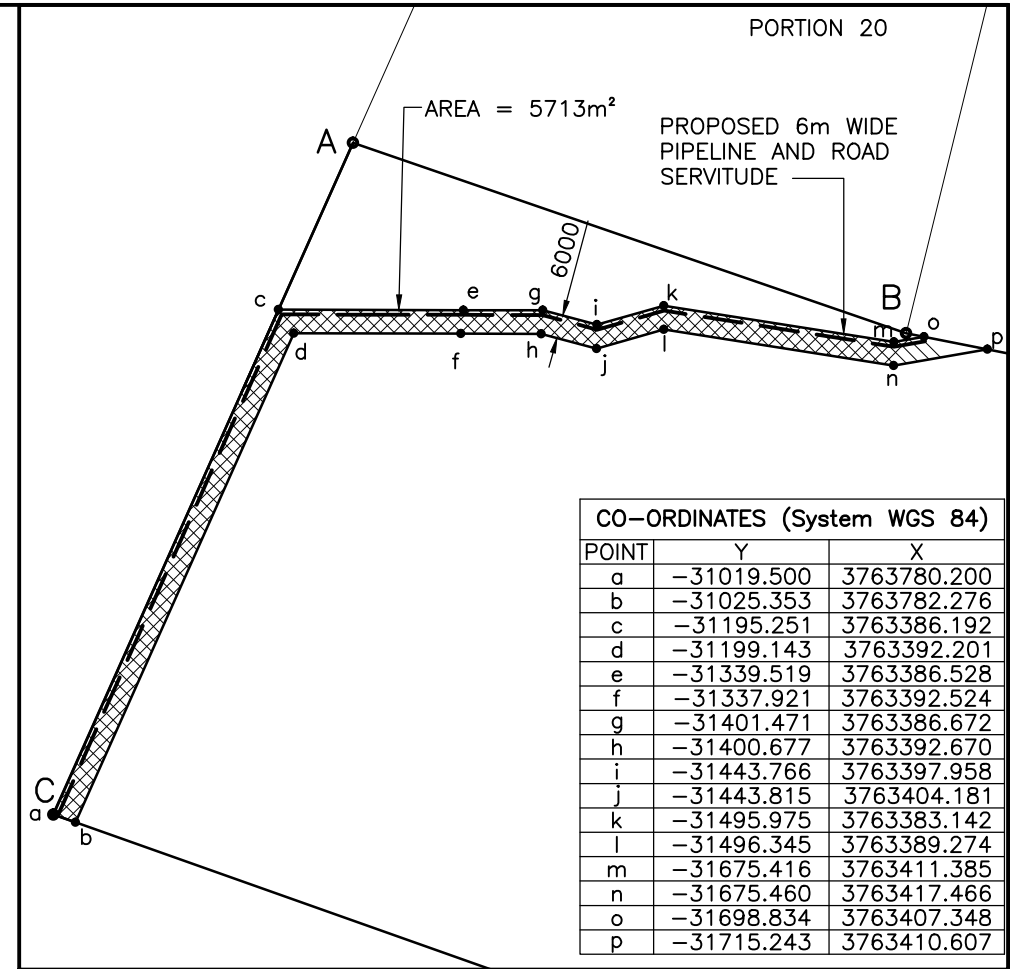
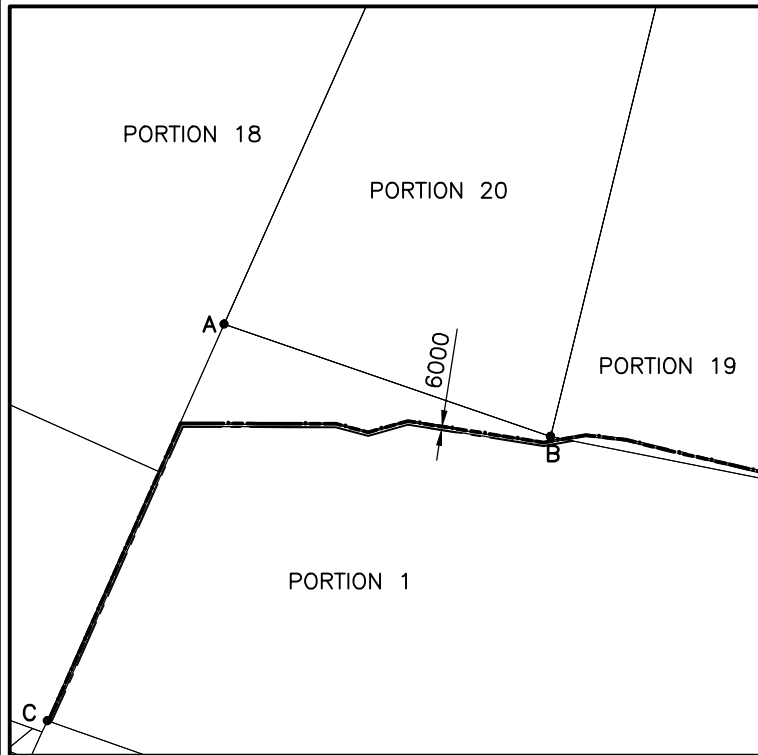

CO-ORDINATES (System WGS 84)		
POINT	Y	X
a	-31019.500	3763780.200
b	-31025.353	3763782.276
c	-31195.251	3763386.192
d	-31199.143	3763392.201
e	-31339.519	3763386.528
f	-31337.921	3763392.524
g	-31401.471	3763386.672
h	-31400.677	3763392.670
i	-31443.766	3763397.958
j	-31443.815	3763404.181
k	-31495.975	3763383.142
l	-31496.345	3763389.274
m	-31675.416	3763411.385
n	-31675.460	3763417.466
o	-31698.834	3763407.348
p	-31715.243	3763410.607

SERVITUDE DIAGRAM
NOT TO SCALE

DESIGNED	RDB	APPROVED PROJECT MANAGER DIRECTOR	SCALE
DRAWN	TS		1 : 10000
CHECKED	GC		DATE
			03/12/08

**NELSON MANDELA BAY
MUNICIPALITY
SEAVIEW BULK WATER**

PORTION 1
S.G. No B1076/1927



Consulting Engineers • Project Managers

BOSCH STEMELE (PTY) LTD.
P.O. BOX 27158, GREENACRES, P.E. 6057.
BLOCK 2, GROUND FLOOR, GREENACRES OFFICE PARK
2nd AVENUE, NEWTON PARK, PORT ELIZABETH, 6045, RSA
TELEPHONE: (041) 363 0598 TELEFAX: (041) 363 7646
E-mail: bspe@boschstemele.co.za
www.boschstemele.co.za



COPYRIGHT AND USE OF THIS DRAWING IS RESERVED BY BOSCH STEMELE

DRAWING NUMBER

8003/011/011K

A4

REVISION **0**

SIDES METERS	ANGLES OF DIRECTION	CO-ORDINATES (System WGS 84)			
		Y	X		
		0	+37 00 000.0		
AB	397.0	283 44 17	A	-31835.330	62790.455
BC	614.8	13 42 30	B	-32220.900	62884.800
CD	397.8	101 14 0	C	-32075.230	63482.055
DA	632.2	193 45 10	D	-31685.030	63404.555

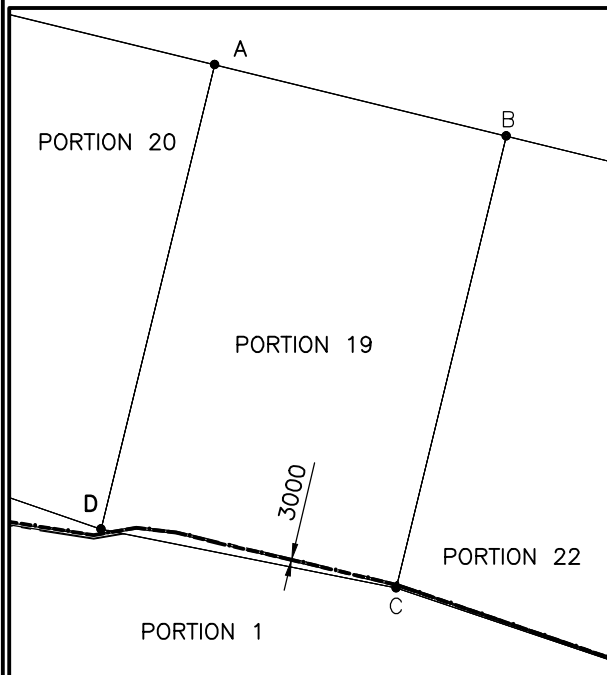

CO-ORDINATES (System WGS 84)		
POINT	Y	X
a	-31697.604	3763407.052
b	-31705.808	3763408.682
c	-31731.499	3763401.208
d	-31731.582	3763404.238
e	-31784.968	3763407.449
f	-31784.620	3763410.429
g	-32076.519	3763476.770
h	-32075.823	3763479.688

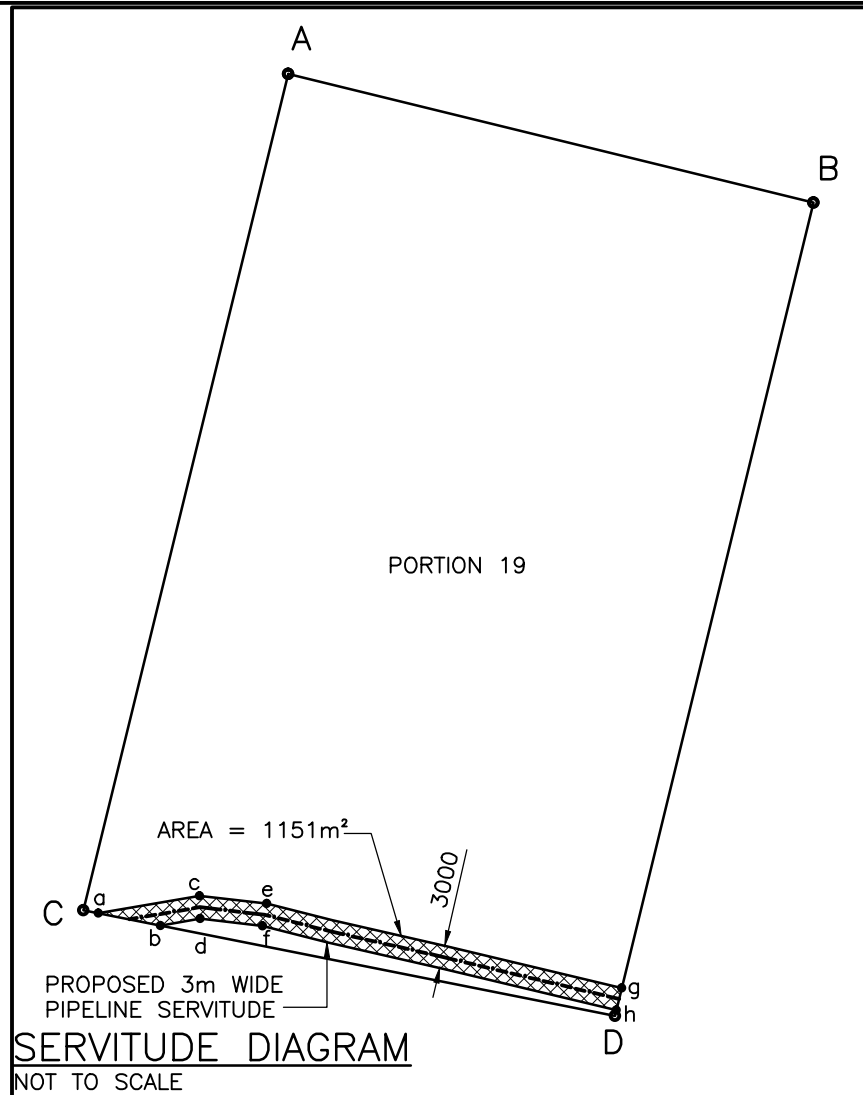

THE FIGURE A B C D REPRESENTS 24.7664 HECTARES OF LAND BEING PORTION 19 (A PORTION OF SEA VIEW WEST) OF THE FARM SEA VIEW

DESIGNED	RDB	APPROVED	SCALE
DRAWN	SM		1 : 10000
CHECKED	GC	PROJECT MANAGER	DATE
		DIRECTOR	03/12/08

NELSON MANDELA BAY MUNICIPALITY
SEAVIEW BULK WATER

PORTION 19
S.G. No 2310/70



Consulting Engineers • Project Managers

BOSCH STEMELE (PTY) LTD.
P.O. BOX 27158, GREENACRES, P.E. 6057.
BLOCK 2, GROUND FLOOR, GREENACRES OFFICE PARK
2nd AVENUE, NEWTON PARK, PORT ELIZABETH, 6045, RSA
TELEPHONE: (041) 363 0598 TELEFAX: (041) 363 7646
E-mail: bspe@boschstemele.co.za
www.boschstemele.co.za



COPYRIGHT AND USE OF THIS DRAWING IS RESERVED BY BOSCH STEMELE	DRAWING NUMBER	8003/011/011J	A4	REVISION	0
--	----------------	---------------	----	----------	---

SIDES METERS	ANGLES OF DIRECTION	CO-ORDINATES (System WGS 84)	
		Y	X
		0	+37 00 000.0
AB	371.0	283 44 17	A -32220.839 62885.049
BC	654.3	8 30 30	B -32581.300 62973.200
CD	431.9	108 37 10	C -32484.500 63620.000
DA	614.8	193 42 30	D -32075.200 63482.100

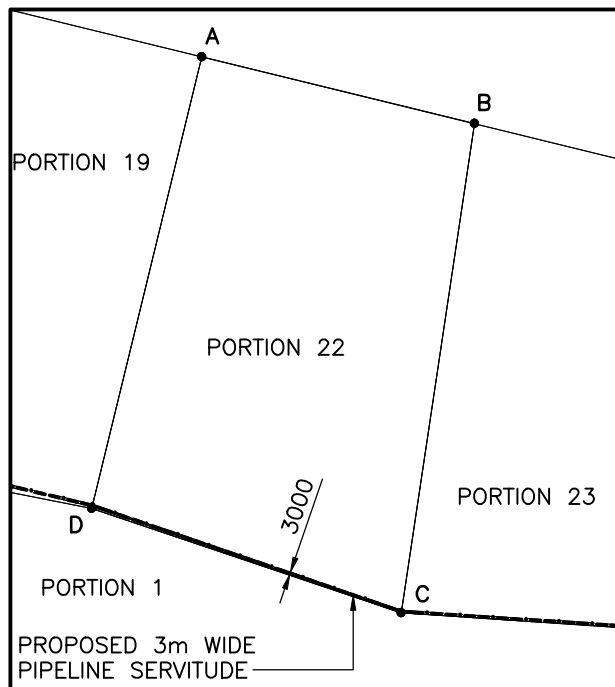

CO-ORDINATES (System WGS 84)		
POINT	Y	X
a	-32076.505	3763476.753
b	-32075.798	3763479.682
c	-32484.977	3763616.823
d	-32484.514	3763619.850

THE FIGURE A B C D REPRESENTS 25.3155 HECTARES OF LAND BEING PORTION 22 (A PORTION OF SEA VIEW WEST) OF THE FARM SEA VIEW

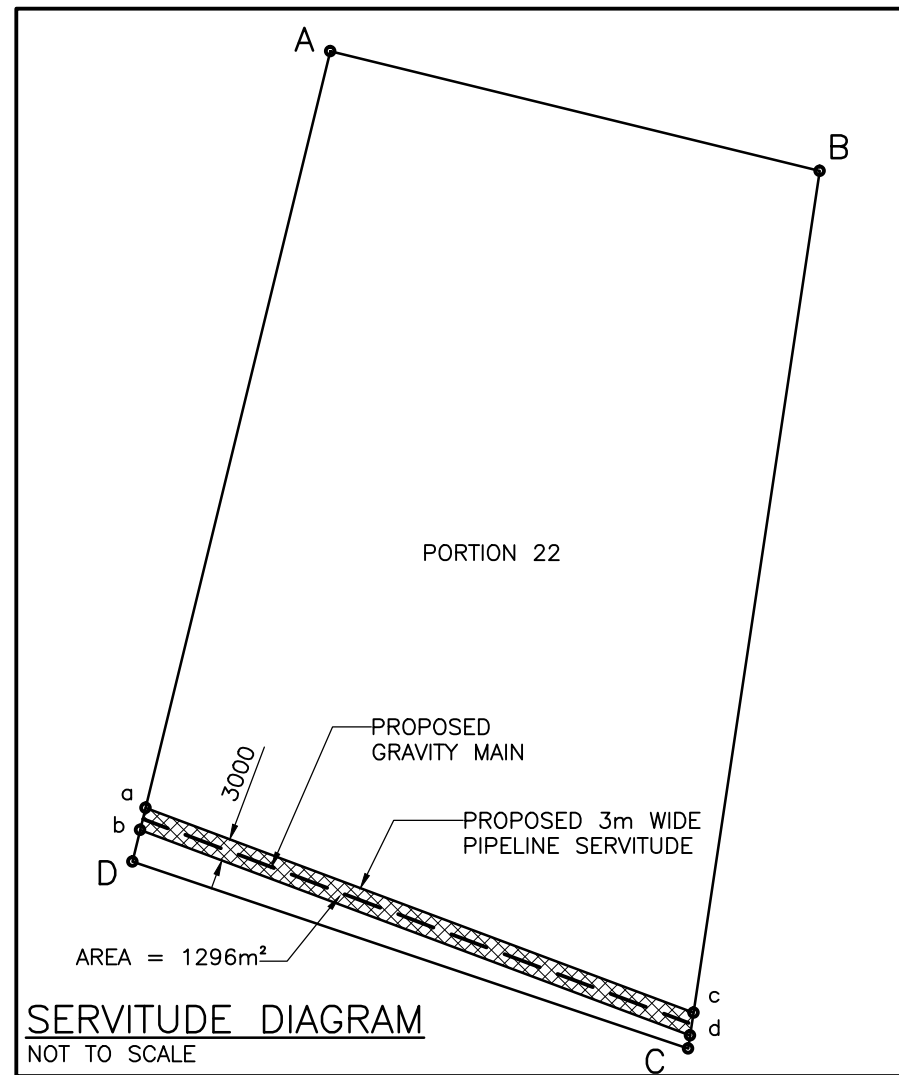

DESIGNED	RDB	APPROVED	SCALE
DRAWN	SM	PROJECT MANAGER	1 : 10000
CHECKED	GC	DIRECTOR	DATE
			03/12/08

NELSON MANDELA BAY MUNICIPALITY
SEAVIEW BULK WATER

PORTION 22
S.G. No 2313/70

BOSCH STEMELE
Consulting Engineers • Project Managers

BOSCH STEMELE (PTY) LTD.
P.O. BOX 27158, GREENACRES, P.E. 6057.
BLOCK 2, GROUND FLOOR, GREENACRES OFFICE PARK
2nd AVENUE, NEWTON PARK, PORT ELIZABETH, 6045, RSA
TELEPHONE: (041) 363 0598 TELEFAX: (041) 363 7646
E-mail: bsp@boschstemele.co.za
www.boschstemele.co.za

COPYRIGHT AND USE OF THIS DRAWING IS RESERVED BY BOSCH STEMELE

DRAWING NUMBER **8003/011/011H** A4 REVISION **0**

SIDES METERS	ANGLES OF DIRECTION	CO-ORDINATES (System WGS 84)	
		Y	X
		0	+37 00 000.0
AB	435.0	283 44 17	A -32581.300 62973.200
BC	479.2	18 31 50	B -32960.130 63065.455
CD	398.4	87 3 50	C -32820.930 63593.155
DA	50.4	178 10 0	D -32832.530 63643.555
EA	543.3	193 45 30	E -32075.200 63482.100

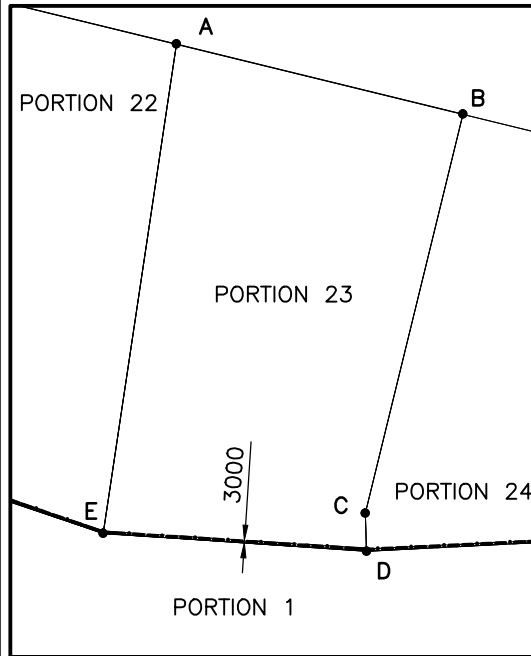

CO-ORDINATES (System WGS 84)		
POINT	Y	X
a	-32484.990	3763616.881
b	-32484.545	3763619.858
c	-32832.405	3763639.625
d	-32832.501	3763642.638

THE FIGURE A B C D E REPRESENTS 22.5460 HECTARES OF LAND BEING PORTION 23 (A PORTION OF SEA VIEW WEST) OF THE FARM SEA VIEW

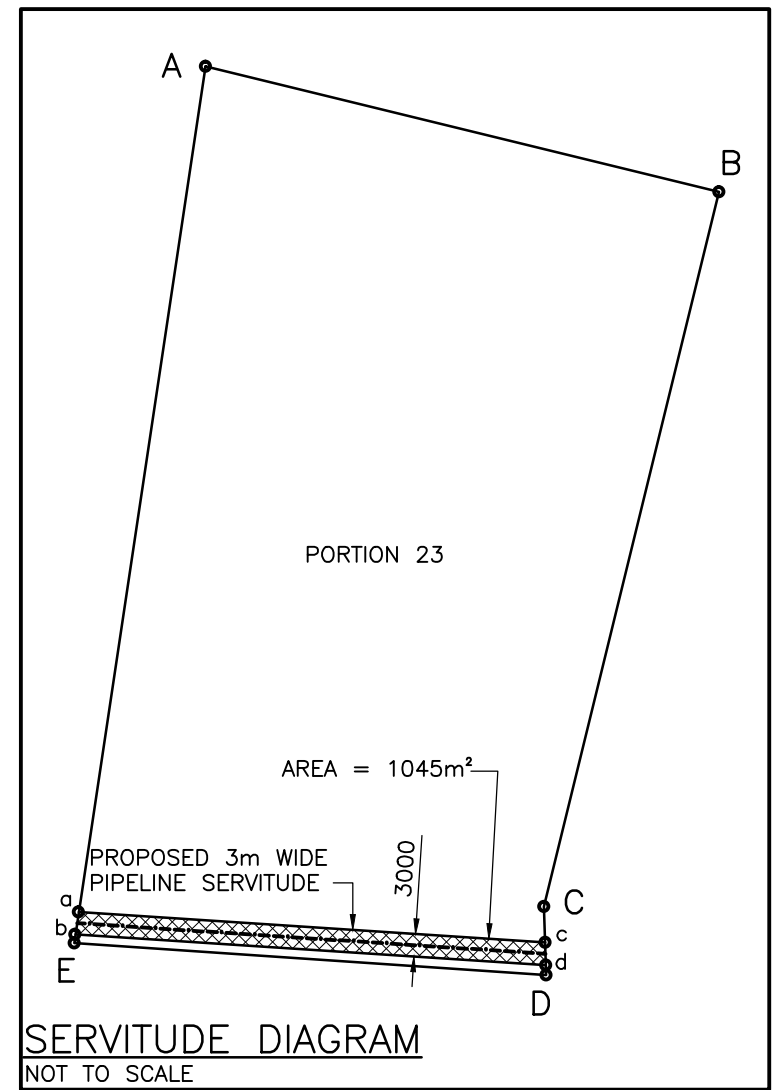

DESIGNED	RDB	APPROVED PROJECT MANAGER DIRECTOR	SCALE
DRAWN	SM		1 : 10000
CHECKED	GC		DATE
			03/12/08

NELSON MANDELA BAY MUNICIPALITY
SEAVIEW BULK WATER

PORTION 23
S.G. No 2314/70



BOSCH STEMELE

Consulting Engineers • Project Managers

BOSCH STEMELE (PTY) LTD.
P.O. BOX 27158, GREENACRES, P.E. 6057.
BLOCK 2, GROUND FLOOR, GREENACRES OFFICE PARK
2nd AVENUE, NEWTON PARK, PORT ELIZABETH, 6045, RSA
TELEPHONE: (041) 363 0598 TELEFAX: (041) 363 7646
E-mail: bspe@boschstemele.co.za
www.boschstemele.co.za



COPYRIGHT AND USE OF THIS DRAWING IS RESERVED BY BOSCH STEMELE	DRAWING NUMBER	8003/011/011G	A4	REVISION	0
--	----------------	---------------	----	----------	---

SIDES METERS		ANGLES OF DIRECTION		CO-ORDINATES (System WGS 84)	
				Y	X
				0	+37 00 000.0
AB	435.0	283 44 17	A	-32960.130	63065.455
BC	479.2	18 31 50	B	-33382.730	63168.755
CD	398.4	87 3 50	C	-33230.430	63623.155
DA	50.4	178 10 0	D	-32832.530	63643.555
EA	543.3	193 45 30	E	-32830.930	63593.155

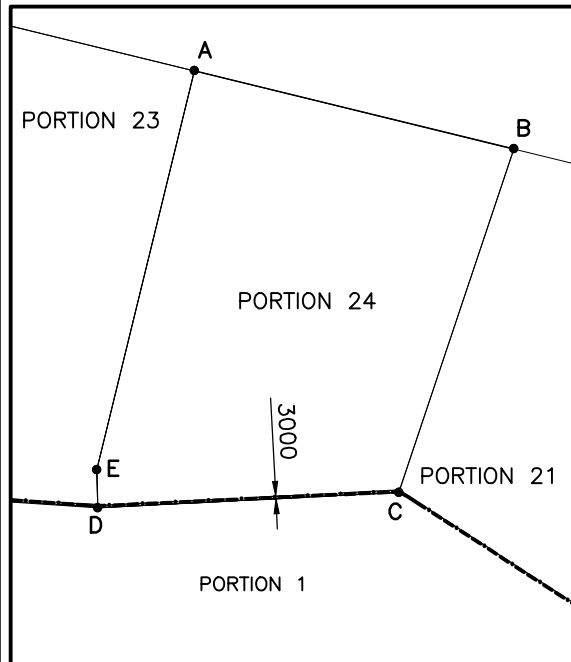

CO-ORDINATES (System WGS 84)		
POINT	Y	X
a	-32832.435	3763640.556
b	-32832.530	3763643.555
c	-33231.454	3763620.099
d	-33230.430	3763623.155

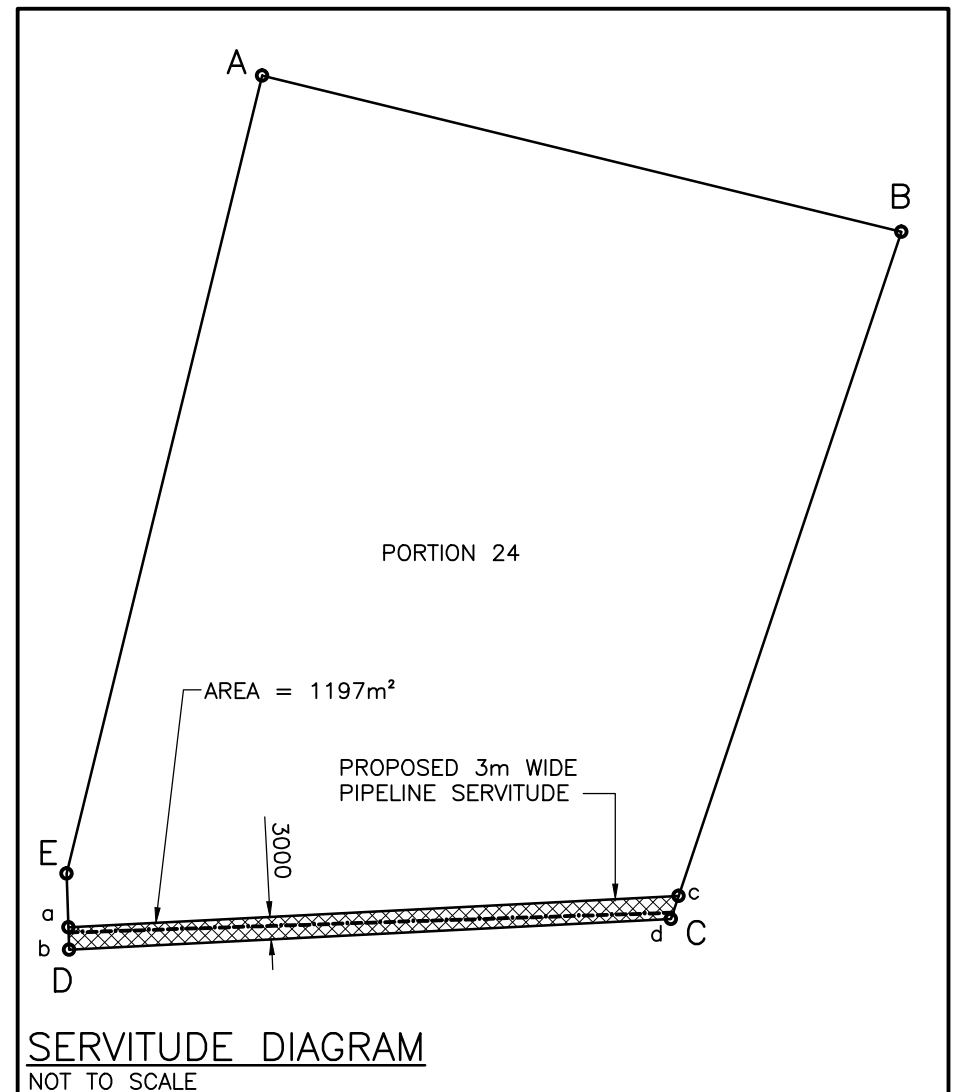

THE FIGURE A B C D E REPRESENTS 22.1270 HECTARES OF LAND BEING PORTION 24 (A PORTION OF SEA VIEW WEST) OF THE FARM SEA VIEW

DESIGNED	RDB	APPROVED	SCALE
DRAWN	SM	PROJECT MANAGER	1 : 10000
CHECKED	GC	DIRECTOR	DATE
			03/12/08

NELSON MANDELA BAY MUNICIPALITY
SEAVIEW BULK WATER

PORTION 24
S.G. No 2315/70



BOSCH STEMELE
Consulting Engineers • Project Managers

BOSCH STEMELE (PTY) LTD.
P.O. BOX 27158, GREENACRES, P.E. 6057.
BLOCK 2, GROUND FLOOR, GREENACRES OFFICE PARK
2nd AVENUE, NEWTON PARK, PORT ELIZABETH, 6045, RSA
TELEPHONE: (041) 363 0598 TELEFAX: (041) 363 7646
E-mail: bsp@boschstemele.co.za
www.boschstemele.co.za

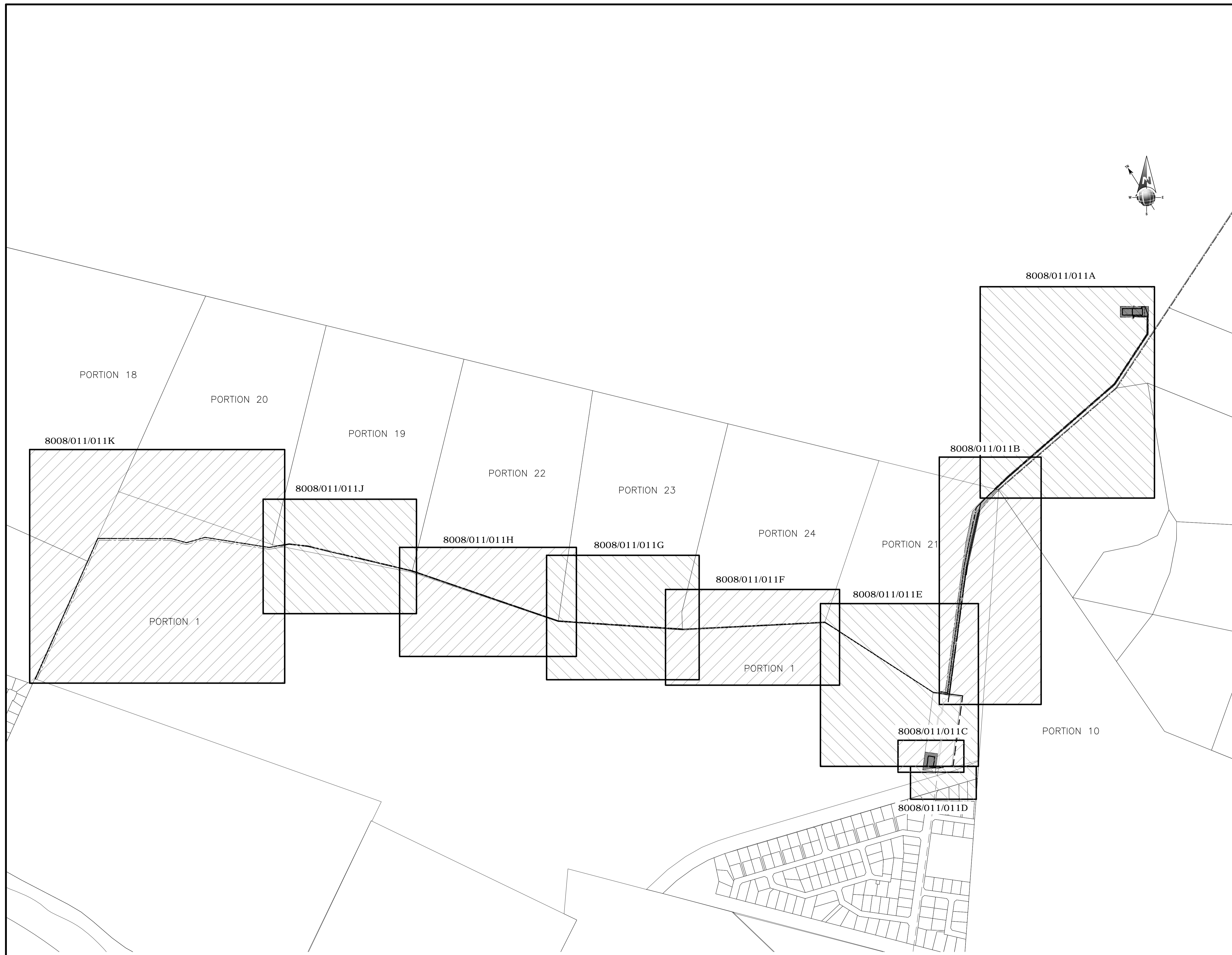
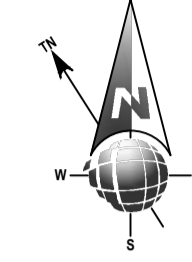
COPYRIGHT AND USE OF THIS DRAWING IS RESERVED BY BOSCH STEMELE	DRAWING NUMBER	8003/011/011F	A4	REVISION	0
--	----------------	---------------	----	----------	---



KEY PLAN – SERVITUDE DIAGRAMS
SCALE 1:5000

1	FOR INTERNAL REVIEW	00/00/00	
REV.	DESCRIPTION	DATE	APPR'D
DRG. No.	REFERENCE DRAWING		
 Consulting Engineers • Project Managers			
BOSCH STEMELE (PTY) LTD. P.O. BOX 27158, GREENACRES, P.E, 6057. BLOCK 2, GROUND FLOOR, GREENACRES OFFICE PARK 2nd AVENUE, NEWTON PARK PORT ELIZABETH, 6045, RSA TELEPHONE: (041) 363 0598 TELEFAX: (041) 363 7646 E-mail: bspe@boschstemele.co.za www.boschstemele.co.za REGIONAL OFFICES IN: CAPE TOWN • DURBAN • EAST LONDON • JOHANNESBURG			
			
COPYRIGHT AND USE OF THIS DRAWING IS RESERVED BY BOSCH STEMELE			
DESIGNED	RDB	DRAWN	TS
CHECKED	GC	CIVIL ENGINEER	RDB
STRUCTURAL ENGINEER		MECHANICAL ENGINEER	
ELECTRICAL ENGINEER		CO-ORDINATION ENGINEER	
APPROVED	PROJECT MANAGER		DIRECTOR
NELSON MANDELA BAY MUNICIPALITY SEAVIEW BULK WATER			
KEY PLAN			
SCALE	AS SHOWN	DATE	00/00/00
DRAWING NUMBER	8003/011/011	REVISION	1

PROPOSED FUTURE
2.5MI RESERVOIR

OUTLET/ SCOUR
VALVE CHAMBER

200Ø SCOUR PIPE LENGTH TO
HEADWALL TO BE CONFIRMED
ON SITE BY ENGINEER

HEADWALL

PROPOSED 1MI RESERVOIR

SECURITY FENCE

PI 13
Chain 1423.56
Y9 = -34118.0157
X9 = 3762738.7014

PI 12
Chain 1413.57
Y9 = -34128.0048
X9 = 3762738.7014

PI 11
Chain 1391.91
Y9 = -34135.3059
X9 = 3762759.092

PI 11

PROPOSED 315mmØ
RISING MAIN





LEGEND

- PROPOSED WATER RETICULATION
- DIRECT OF FLOW
- EXISTING WATER RETICULATION
- EXISTING SEWER
- EXISTING STORMWATER
- UNDERGROUND ELECTRICAL CABLES
- OVERHEAD TELKOM CABLE
- STORMWATER FLOW
- EXISTING FENCE
- OVERHEAD ELECTRICITY CABLE
- AV AIR VALVE
- BV BUTTERFLY VALVE
- FH FIRE HYDRANT
- GV GATE VALVE
- IT INSPECTION TEE
- PG PRESSURE GAUGE
- SV SCOUR VALVE
- VM VENTURI METER
- o WATER METER
- o MAHOLE
- o RODDING EYE
- o GULLY
- o SEWER VENT PIPE

1	FOR INTERNAL REVIEW	00/00/00
REV.	DESCRIPTION	DATE APPR'D

DRG. No. REFERENCE DRAWING



Consulting Engineers • Project Managers

BOSCH STEMELE (PTY) LTD.
 P.O. BOX 27158, GREENACRES, P.E. 6057.
 BLOCK 2, GROUND FLOOR,
 GREENACRES OFFICE PARK
 2nd AVENUE, NEWTON PARK
 PORT ELIZABETH, 6045, RSA
 TELEPHONE: (041) 363 0598
 TELEFAX: (041) 363 7646
 E-mail: bspe@boschstemele.co.za
 www.boschstemele.co.za
 REGIONAL OFFICES IN:
 CAPE TOWN • DURBAN • EAST LONDON • JOHANNESBURG



COPYRIGHT AND USE OF THIS DRAWING IS RESERVED BY BOSCH STEMELE

DESIGNED	R.B	DRAWN	T.S
CHECKED	G.C	CIVIL ENGINEER	R.B
STRUCTURAL ENGINEER	N/A	MECHANICAL ENGINEER	N/A
ELECTRICAL ENGINEER	N/A	CO-ORDINATION ENGINEER	N/A

APPROVED PROJECT MANAGER DIRECTOR

NELSON MANDELA BAY MUNICIPALITY
SEAVIEW BULK WATER
 SEAVIEW PUMPSTATION SITE LAYOUT
 PROPOSED RESERVOIR LOCATION OPTIONS

SCALE	1:500	DATE	21/05/14
DRAWING NUMBER	8003/011/073 A1	REVISION	1

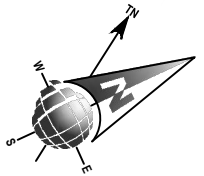

**350mmØ uPVC CLASS
12 GRAVITY MAIN**

**315mmØ uPVC
CLASS 16
PUMPING MAIN**

END
Y -34 082.346
X 37 627 71.206

CH 50
Y -34 088.891
X 37 628 21.797

START
Y -34 120.065
X 37 628 56.481

PROPOSED 2,5M
RESERVOIR

PROPOSED
ACCESS
ROAD

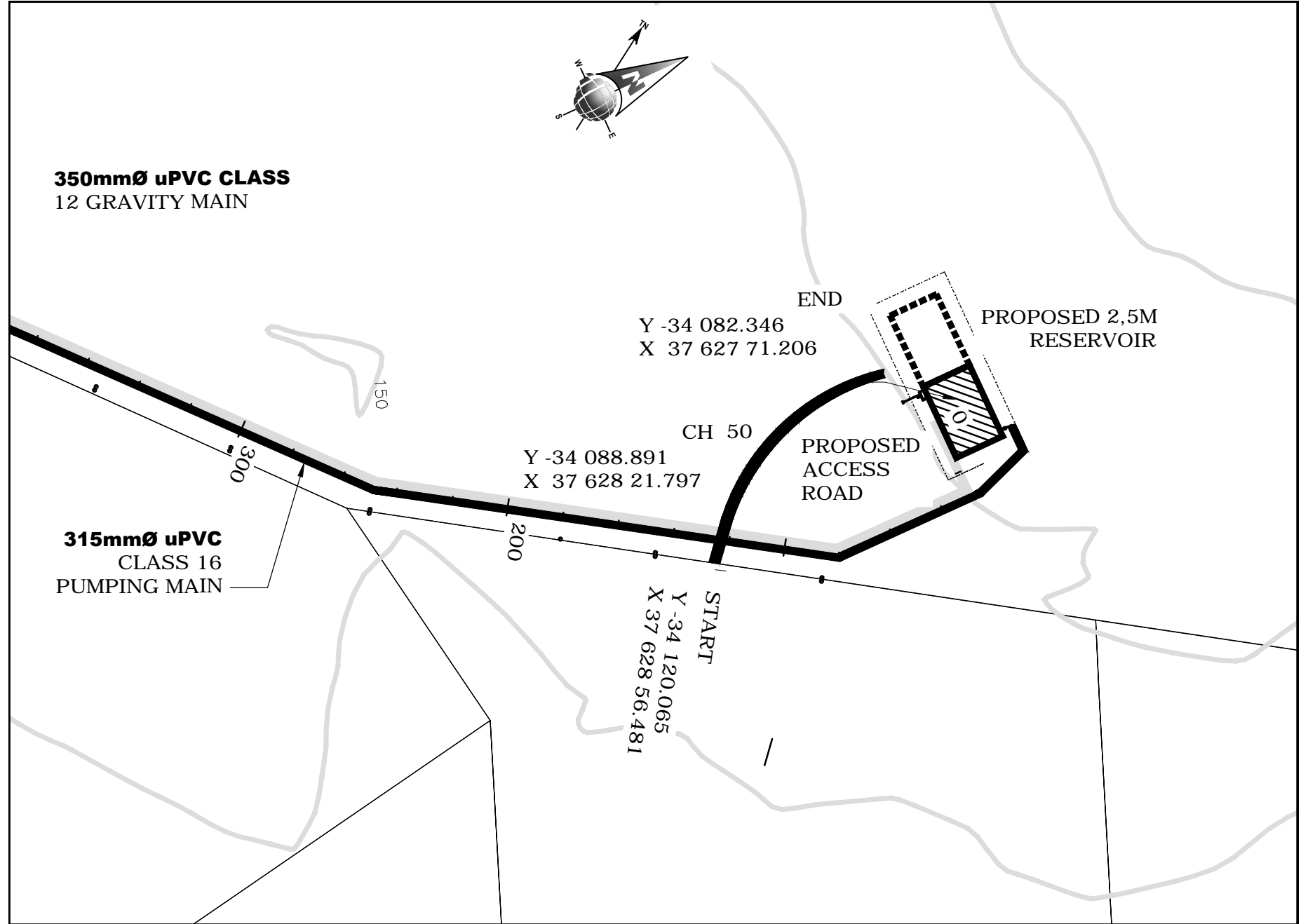

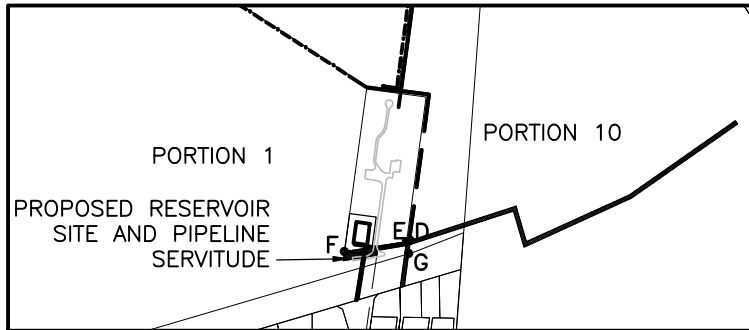

SIDES METERS	ANGLES OF DIRECTION	CO-ORDINATES (System WGS 84)	
		Y	X
		0	+37 00 000.0
DE	11.10 253 0 0	D	-33597.600 64019.100
EF	263.49 80 52 30	E	-33586.987 64022.446
DG	17.55 8 0 0	F	-33505.074 64035.604
		G	33595.200 64036.500

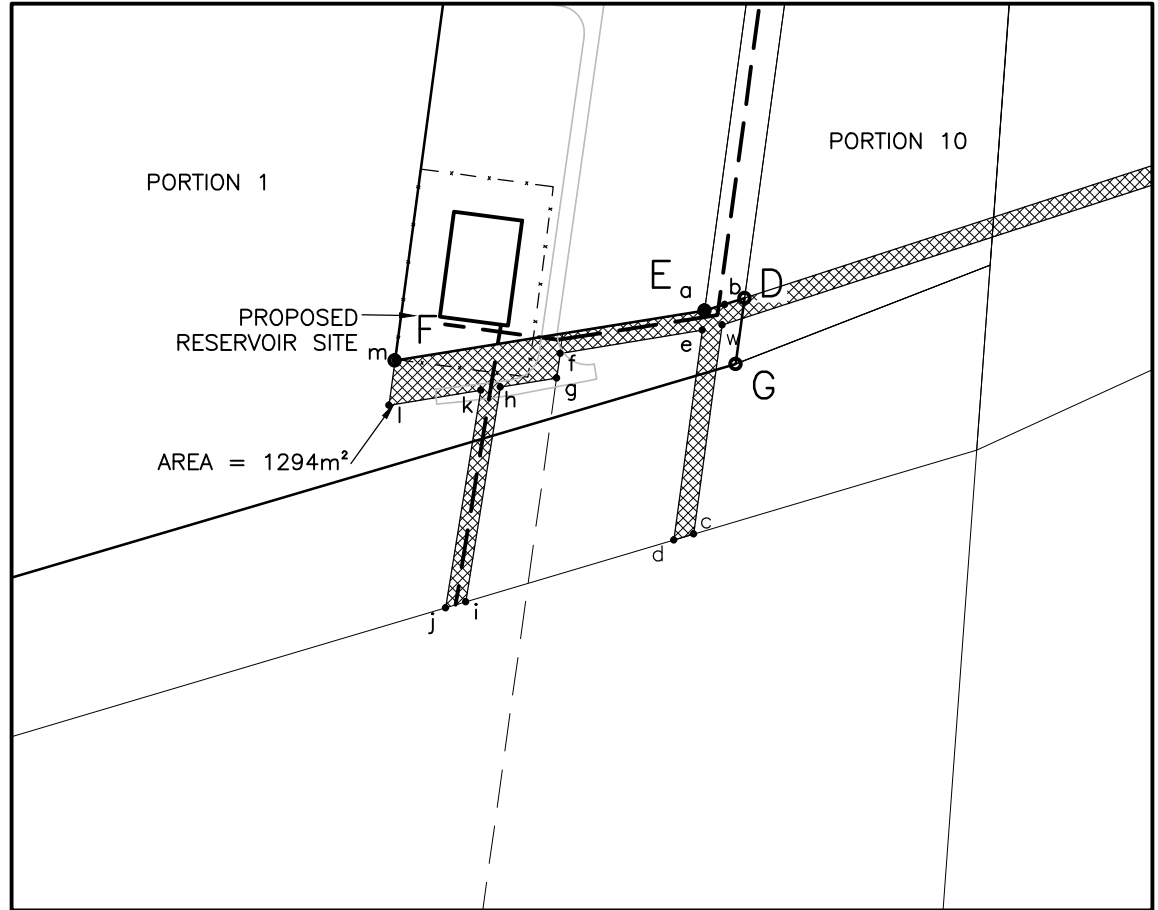

CO-ORDINATES (System WGS 84)		
POINT	Y	X
a	-33587.030	3764022.455
b	-33592.334	3764020.739
c	-33584.0967	3764081.5011
d	-33578.8395	3764083.0615
e	-33586.3646	3764027.5531
f	-33548.7374	3764033.7096
g	-33547.8351	3764040.2151
h	-33533.1098	3764042.6244
i	-33524.0079	3764098.8621
j	-33518.6895	3764100.4274
k	-33527.9070	3764043.4756
l	-33503.5285	3764047.4644
m	-33505.1000	3764035.6000
w	-33591.5932	3764026.2044



SERVITUDE DIAGRAM
NOT TO SCALE

DESIGNED	RDB	APPROVED	SCALE	<p align="center">NELSON MANDELA BAY MUNICIPALITY SEAVIEW BULK WATER</p> <p align="center">PORTION 1 S.G. No B1076/1927</p>	 <p align="center">BOSCH STEMELE</p> <p align="center">Consulting Engineers • Project Managers</p> <p><small>BOSCH STEMELE (PTY) LTD. P.O. BOX 27158, GREENACRES, P.E. 6057. BLOCK 2, GROUND FLOOR, GREENACRES OFFICE PARK 2nd AVENUE, NEWTON PARK, PORT ELIZABETH, 6045, RSA TELEPHONE: (041) 363 0598 TELEFAX: (041) 363 7646 E-mail: bsp@boschstemele.co.za www.boschstemele.co.za</small></p> 
DRAWN	SM/TS	PROJECT MANAGER	1 : 10000		
CHECKED	GC	DIRECTOR	DATE		
			12/12/16		
COPYRIGHT AND USE OF THIS DRAWING IS RESERVED BY BOSCH STEMELE				DRAWING NUMBER	8003/011/011D
				A4	REVISION 2