

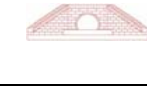

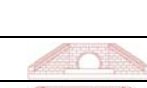









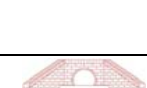
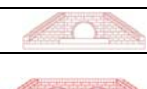
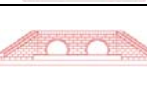
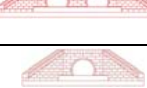
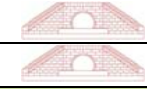

AREA OF DRAINAGE STRUCTURES: PROPOSED MBLANE ROAD

Name	Y_coord	X_Coord	Type	Precast Structure					IN- & OUT-let Structures				Total Area (m ²)	
				Size	Diam (mm)	Length(m)	Barrels	Area (m ²)	Type	Inlet (m ²)	Outlet (m ²)			
1	P1	-28.245537	30.741649	Precast Concrete Pipes	Ø600 pipe	700	9.46	1	6.62	Brick-600		2.90	2.90	12.43
2	P2	-28.246051	30.742540	Precast Concrete Pipes	Ø600 pipe	700	9.46	1	6.62	Brick-600		2.90	2.90	12.43
3	P3	-28.246367	30.744013	Precast Concrete Pipes	Ø600 pipe	700	9.46	1	6.62	Brick-600		2.90	2.90	12.43
4	P4	-28.246818	30.744887	Precast Concrete Pipes	Ø900 pipe	1035	9.46	1	9.79	Brick-900		4.43	4.43	18.64
5	P5	-28.247671	30.746106	Precast Concrete Pipes	Ø900 pipe	1035	9.46	2	23.93	Brick-900		6.77	6.77	37.48
6	P6	-28.248076	30.747382	Precast Concrete Pipes	Ø900 pipe	1035	9.46	1	9.79	Brick-900		4.43	4.43	18.64
7	P7	-28.248490	30.748463	Precast Concrete Pipes	Ø600 pipe	700	9.46	1	6.62	Brick-600		2.90	2.90	12.43
8	P8	-28.248434	30.749521	Precast Concrete Pipes	Ø600 pipe	700	9.46	1	6.62	Brick-600		2.90	2.90	12.43
9	P9	-28.248304	30.750741	Precast Concrete Pipes	Ø600 pipe	700	9.46	1	6.62	Brick-600		2.90	2.90	12.43
10	P10	-28.248329	30.751888	Precast Concrete Pipes	Ø600 pipe	700	9.46	1	6.62	Brick-600		2.90	2.90	12.43
11	P11	-28.248331	30.752566	Precast Concrete Pipes	Ø600 pipe	700	9.46	1	6.62	Brick-600		2.90	2.90	12.43
12	P12	-28.248228	30.754039	Precast Concrete Pipes	Ø600 pipe	700	9.46	1	6.62	Brick-600		2.90	2.90	12.43
13	P13	-28.248063	30.754969	Precast Concrete Pipes	Ø900 pipe	1035	9.46	1	9.79	Brick-900		4.43	4.43	18.64
14	P14	-28.247946	30.755968	Precast Concrete Pipes	Ø1200 Pipe	1375	9.46	2	30.37	Brick-1200		10.23	10.23	50.83
15	P15	-28.248229	30.757716	Precast Concrete Pipes	Ø1200 Pipe	1375	9.46	2	30.37	Brick-1200		10.23	10.23	50.83
16	P16	-28.248933	30.758953	Precast Concrete Pipes	Ø600 pipe	700	9.46	1	6.62	Brick-600		2.90	2.90	12.43
17	P17	-28.249881	30.759717	Precast Concrete Pipes	Ø1200 Pipe	1375	9.46	1	13.01	Brick-1200		6.61	6.61	26.23
18	CS 1	-28.250484	30.760031	Concrete Slab	18 x 6	N/A			N/A				108.00	
19	P18	-28.251934	30.761210	Precast Concrete Pipes	Ø600 pipe	700	9.46	1	6.62	Brick-600		2.90	2.90	12.43
20	P19	-28.252321	30.761806	Precast Concrete Pipes	Ø900 pipe	1035	9.46	1	9.79	Brick-900		4.43	4.43	18.64
21	P20	-28.252572	30.762151	Precast Concrete Pipes	Ø1200 Pipe	1375	9.46	1	13.01	Brick-1200		6.61	6.61	26.23
22	CS 2	-28.253226	30.763722	Concrete Slab	20 x 6	N/A			N/A				120.00	
23	CS 3	-28.253318	30.764894	Concrete Slab	30 x 6	N/A			N/A				180.00	
24	P21	-28.253307	30.766220	Precast Concrete Pipes	Ø600 pipe	700	9.46	1	6.62	Brick-600		2.90	2.90	12.43
25	P22	-28.253520	30.767153	Precast Concrete Pipes	Ø600 pipe	700	9.46	1	6.62	Brick-600		2.90	2.90	12.43

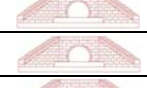
26	CS 4	-28.252550	30.768101	Concrete Slab	30 x 6	N/A				N/A		180.00		
27	CS 5	-28.252350	30.770239	Concrete Slab	20 x 6	N/A				N/A		120.00		
28	P23	-28.250772	30.772059	Precast Concrete Pipes	Ø600 pipe	700	9.46	1	6.62	Brick-600		2.90	2.90	12.43

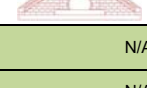
Ø600 STORMWATER PIPE DIMENSIONS

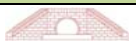
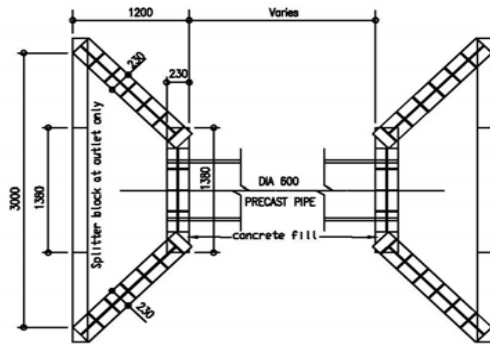
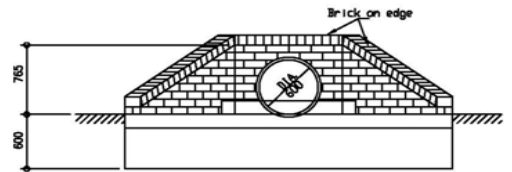
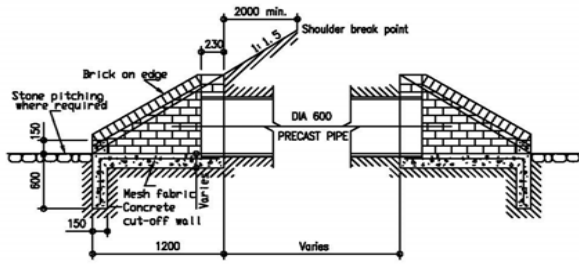

Not to scale

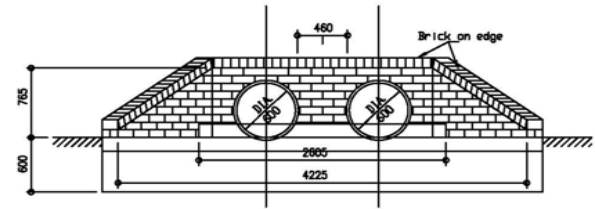

Not to scale

Ø900 STORMWATER PIPE DIMENSIONS (NTS)

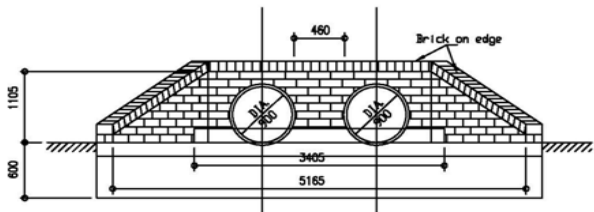
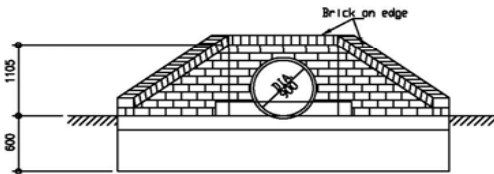
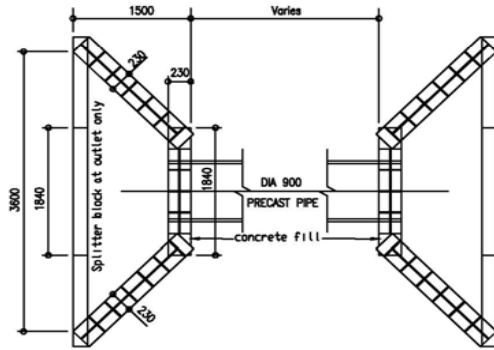
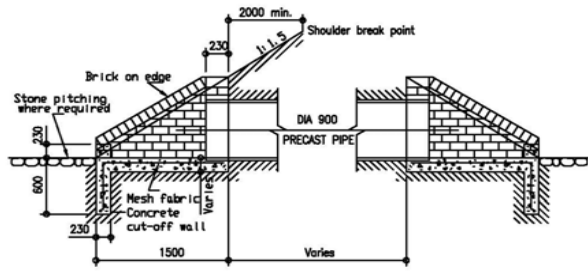

Ø1200 STORMWATER PIPE DIMENSIONS (NTS)

